



PROGRAMMABLE DISPLAY
FOR INCREMENTAL SENSORS

PAS 11062AE

12 / 2001

MODEL PAS49 MI

USER'S MANUAL

TWK-ELEKTRONIK GmbH · D-40041 Düsseldorf · PF. 10 50 63 · Heinrichstr. 85 · T. 02 11/63 20 67 · F. 02 11/63 77 05 · e-mail: info@twk.de · <http://www.twk.de>

This manual does not constitute a formal agreement. All information given in this manual is subject to change without notice.

The PAS 49 series brings a new philosophy in digital panel instrumentation which is expressed by multipurpose, modular-concept devices providing a rich array of basic functions and advanced capabilities.

With a fully MODULAR DESIGN, it is possible to implement a wide variety of applications by only adding the adequate options.

Intelligence within allows the meter to recognize the options installed and ask for the necessary parameters to properly function within desired margins. The parameters related to non-installed options are removed from the program routines.

The instruments CALIBRATION is made at the factory eliminating the need for adjustment potentiometers. Any circuit or option liable to be adjusted incorporates a memory where calibration parameters are stored, making it possible the optional cards be totally interchangeable without need of any subsequent adjust.

Custom CONFIGURATION for specific applications can be made quickly and easily through five front panel keys, following structured choice menus aided by display prompts at each programming step.

Other features of the PAS 49 family include :

- CONNECTIONS via plug-in terminal blocks without screws and CLEMP-WAGO clips cable retention system.
- DIMENSIONS
Models PAS 49 A/ L 96x48x120 mm DIN 43700
Models PAS 49 J / M 96x48x60 mm DIN 43700
- CASE MATERIAL UL-94 V0-rated polycarbonate.
- PANEL INSTALLATION without screws by means of single part fastening clips.

To guarantee the meter's technical specifications, it is recommended to recalibrate the meter at periodical intervals according to the ISO9001 standards for the particular application operating criteria. Calibration should be performed at the factory or in a qualified laboratory.

DIGITAL PANEL INSTRUMENT

PAS 49 SERIES

MODEL PAS49 MI

1. GENERAL OVERVIEW ON MODEL PAS 49 MI

1.1. INTRODUCTION	5
1.2. COUNTER OPERATION.....	7
1.3. CHRONOMETER OPERATION	9
1.4. FRONT-PANEL FUNCTIONS.....	10

2. FIRST OPERATIONS

2.1. GETTING STARTED	12
2.2. POWER SUPPLY	13
2.3. INPUT CONFIGURATION	14
2.4. SIGNAL CONNECTION	15

3. PROGRAMMING INSTRUCTIONS

3.1. INTRODUCTION	16
3.2. PROGRAMMING THE COUNTER	
3.2.1. INPUT.....	18
3.2.2. DISPLAY	23
3.3. PROGRAMMING THE CHRONOMETER	
3.3.1. INPUT.....	26
3.3.2. DISPLAY	29

4. CHARACTERISTICS

4.1. OUTPUT OPTIONS	31
4.2. TECHNICAL SPECIFICATIONS	32
4.3. DIMENSIONS AND MOUNTING.....	33

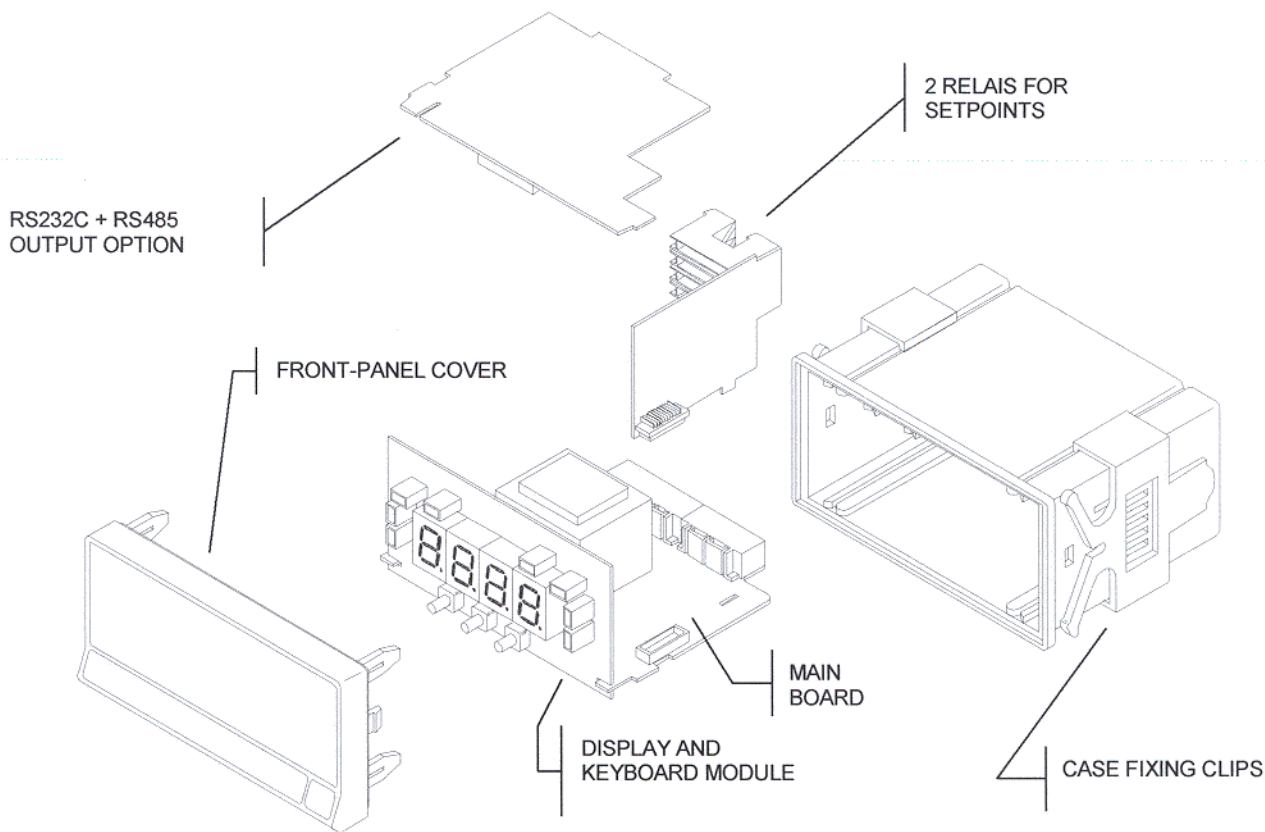

1. MODEL PAS 49MI

1.1. INTRODUCTION

The PAS49MI model is a four-digit, small format instrument with two inputs that admit several types of sensors and pulse generators, as selected by DIP-SWITCH, to make the functions of :

UP, DOWN and UP/DOWN COUNTER;
with front-panel and remote RESET, selectable decimal point, display offset (value to which the counter goes after each reset), 20Hz debounce filter and possibility of locking out the RESET button, the setpoints programming and the offset programming.

CHRONOMETER;
with five time ranges from hundredths of second to hours, front-panel and remote RESET, decimal point according to scale and possibility of locking out the RESET button and the setpoints programming.
The last count registered before a power failure or cut-off is saved in an internal memory and restored on the display on power up.

The basic instrument is a soldered assembly composed by the main board and the display + keyboard module. Extended capabilities are furnished by the following optional cards:

- Serial communication output card with RS232C and RS485 protocols.
- Control outputs card with 2 SPDT 8A relays.

The output options give the meter a wide number of new additional functions and operating modes and also permit automatic process control and communication with external devices.

Each option provides independent connectors, protruding out of the rear of the instrument, status LED's on the front-panel and a specific programming module which is automatically activated once the card is installed.

The outputs are opto-isolated with respect to the input signal.

VERY IMPORTANT :

THE "2RE" AND "RS6" OPTIONS, CONNECTABLE TO THE PAS 49 FAMILY, CAN ALSO BE INSTALLED IN THE PAS49MI MODELS TAKING NOTICE OF THE FOLLOWING INSTRUCTIONS :

FOR THE "2RE" OPTION :

You must refer to pages 8, 9 and 10 to install the card, make wiring connections and consult the technical specifications. Leave out the rest of the pages since they do not include the programming instructions nor the functional description of the setpoints with relation to the MICRA-I model. These instructions can be found in the annexe at the end of the present manual.

FOR THE "RS6" OPTION :

COMMAND		FUNCTION	TYPE OF FUNCTION
TWK	ISO		
O	00	Transmission of the offset value	data request
D	0D	Transmission of the display value	
F	0F	Transmission of the input factor	
L1	L1	Transmission of the setpoint 1	
L2	L2	Transmission of the setpoint 2	
M1	M1	Modification of the setpoint 1	changing parameters
M2	M2	Modification of the setpoint 2	

6

1.2. COUNTER OPERATION

In pulse counter configuration, the instrument provides up counting operation (UP mode), down counting operation (DOWN mode) or bidirectional counting operation (UP/DOWN mode) as selected via software.

UP Counter

The counting is made in the up direction from zero or from the programmed offset. When count rises above 9999, the display indicates overrange (OvE).

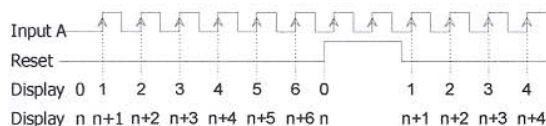

DOWN Counter

The instrument starts counting down from the programmed offset. Counts below zero cause negative overrange (UndE).

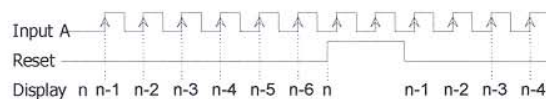

A push of **3 seconds** on the RESET key returns the counter to zero or to the offset value. The meter starts counting on the first pulse applied after releasing the RESET key.

In the UP or DOWN configuration, the second meter input (Input B) can be used to start and stop the counter (see section 20.2, page 20).

UP Counter with A-B inputs

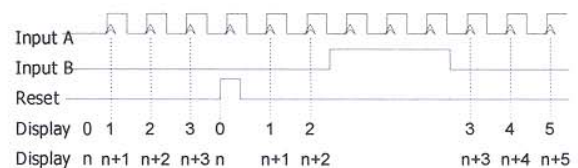

DOWN Counter with A-B inputs

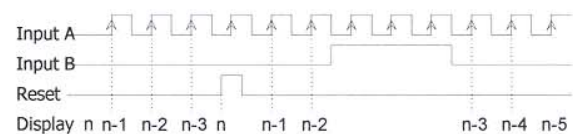

The meter increments or decrements the display value on each pulse applied at the input A as long as the input B is held at low level. The counter is stopped by putting the input B to high level.

7

BIDIRECTIONAL COUNTER

The bidirectional counter can count in the up or in the down direction depending on a combination of its A and B inputs. It starts counting from zero or from a programmable offset.

The display limits are -9999 and 9999, out of which the instrument goes to negative overrange (-OvE) or positive overrange (+OvE) respectively. The positive values are indicated by the "UP" LED and the minus sign by the "DOWN" LED.

There are three selectable modes for the UP/DOWN counter :

Independent UP/DOWN Counter

The A and B inputs are independent. Pulses applied at the A input increment the counter and pulses on the B input decrement the counter.

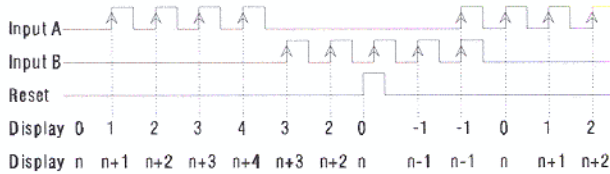

In the diagrams given on this page and on page 7, the display values are represented in the cases where the counter starts from zero (Display 0) and from the programmed offset n (Display n). The offset programming can be locked-out via software (see page 22).

For every counter type and counting direction, it is possible to multiply the number of input pulses by a programmable factor between 0.001 and 9.999 (see page 24).

Directional UP/DOWN Counter

Pulses applied at the A input increment the counter while B is at high level and decrement the counter if B is at low level.

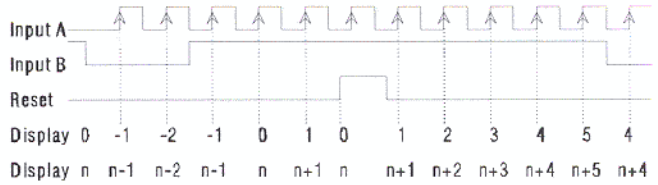

UP/DOWN Phase Counter

The counter changes its direction each time the input signal changes its phase.

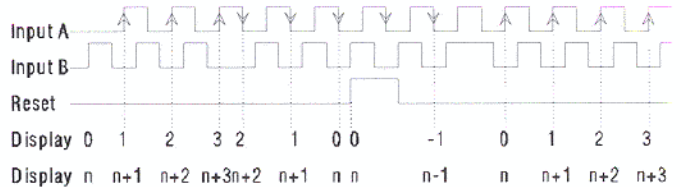

1.3. CHRONOMETER OPERATION

The chronometer accumulates time intervals elapsed between two START and STOP signals until a manual, automatic or remote RESET returns it to zero.

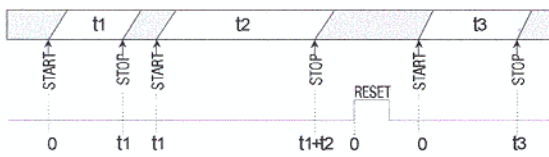

The time measurement can be realized in any of the five available scales ; 99.99s, 999.9s, 9999s, 99min59s or 9999h.

The scale is selected in the display programming module (see pages 29 and 30).

If the time counting exceeds from the limits of the selected scale, the instrument starts the cycle again from zero.

The RESET by keyboard must be held for at least **3 seconds** to be effective. The remote RESET is instantaneous. The reset function can be locked out via software (see page 28).

The start and stop inputs can operate in two modes as selected by software (see section 20.2 page 20) :

Independent Mode

The chronometer starts on a rising edge of the A input and stops on the next falling edge.

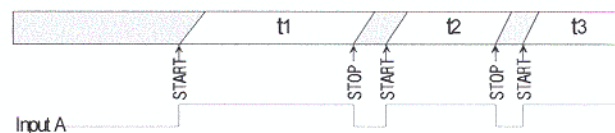

Direct Mode

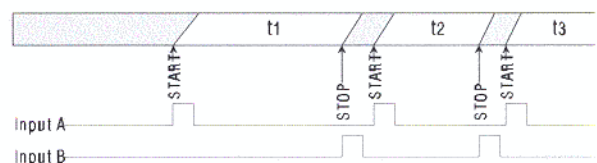

The chronometer starts on a rising edge of the A input and stops on the next rising edge of the B input. The A and B inputs must be configured for TTL / 24V operation (page 14).





10

1.4. FRONT-PANEL FUNCTIONS

N	Description	RUN mode function	PROG mode function
1	LED RS232C	RS232C output selected	Programming of the RS232C output
2	LED RS485	RS485 output selected	Programming of the RS485 output
3	LED SET2	Indicates activation of the SET2 relay	Indicates programming of the setpoint 2
4	LED OFFS / F2	Indicates that an offset has been programmed	Indicates programming of the serial outputs
5	LED PROG / F4	-	Indicates programming mode
6	LABEL	Measurement unit	
7	KEY 	Enters in PROG mode. Displays data	Accepts data. Advances the programming
8	KEY 	-	Displacement to the right
9	RESET KEY	A press of 3 seconds restarts the meter to the initial conditions	Increments value. In conjunction with ENTER, allows programming the setpoints
10	DISPLAY	Displays data	Displays programming parameters
11	LED DOWN / F3	Indicates negative values	Indicates scale programming
12	LED UP / F1	Indicates positive values	Indicates input programming
13	LED SET1	Indicates activation of the SET1 relay	Indicates programming of the setpoint 1

If it is necessary to change any of the meter's hardware configurations, insert a screwdriver into the slots on each side of the case and push until the clips disengage. Lift out the electronics assembly from the case by pulling outwards as indicated (see figure 9.1.)

115/230V AC : The instruments that are to be powered with 115/230V AC are set up at fabrication for **230V** operation, see figure 9.2. To change to 115V, plug in power jumpers indicated in table 1 as shown in figure 9.3.

24/48V AC : The instruments that are to be powered with 24/48V AC are set up at fabrication for **24V** operation, see figure 9.3. To change to 48V, plug in power jumpers indicated in table 1 as shown in figure 9.3.

12V DC or 24V DC :

The instruments for operation with DC power are supplied for the voltage specified in the wiring label (12V or 24V DC).

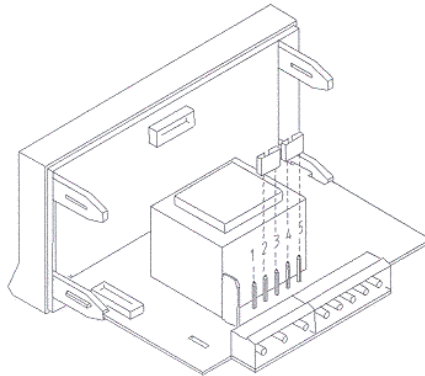

Fig. 9.2. Power jumper position for 230V or 48V AC

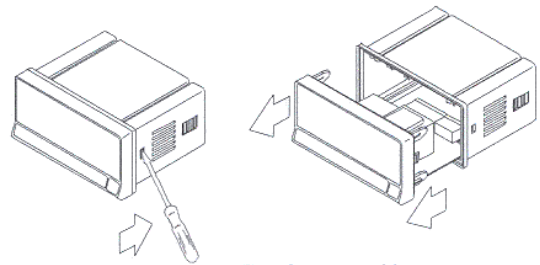

Fig. 9.1. Disambling.

Table 1. Jumper positions.

Pin	1	2	3	4	5
230V AC	-	█	█	█	-
115V AC	█	█	█	█	-
48V AC	-	█	█	█	█
24V AC	█	█	█	█	-

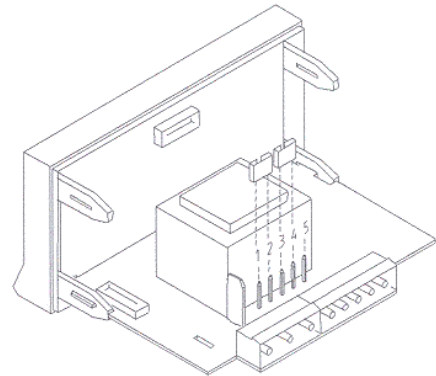
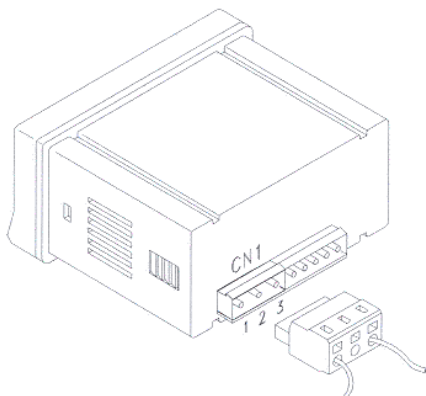

Fig. 9.3. Power jumper position for 115V or 24V AC

2.3. POWER CONNECTION



AC VERSIONS

- PIN 1 = AC HI (PHASE)
- PIN 2 = PROT. EARTH
- PIN 3 = AC LO (NEUTRAL)

DC VERSIONS

- PIN 1 = DC POSITIVE
- PIN 2 = NOT CONNECTED
- PIN 3 = GND (GROUND)

CONNECTORS

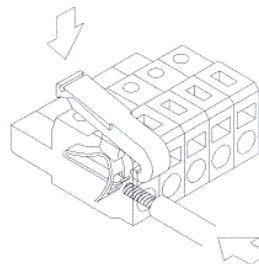

To perform wiring connections, remove the terminal block from the meter's connector, strip the wire leaving from 7 to 10mm exposed and insert it into the proper terminal while pushing the fingertip down to open the clip inside the connector as indicated in the figure. Proceed in the same manner with all pins and plug the terminal block into the corresponding meter's connector.

Each terminal can admit cables of section comprised between 0.08mm and 2.5mm (AWG 26 ÷ 14).

The blocks are shipped with removable adaptors inserted in each terminal to provide proper fastening for cables of sections less than 0.5mm².

2.3. INPUT CONFIGURATION

Main circuit REF. 430 (component side)

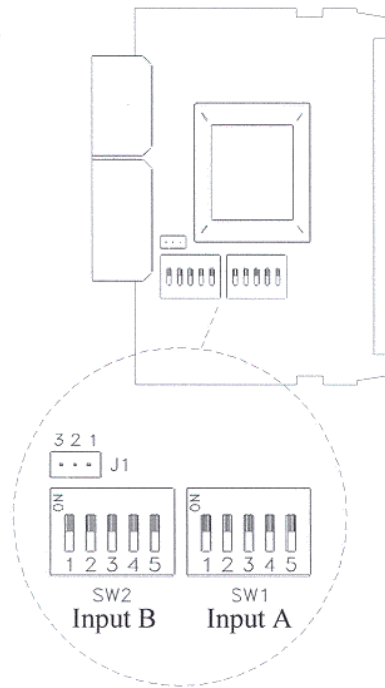

Before applying the input signal, set the SW1 switches according to the type of sensor that is to be connected to the A input, and the SW2 switches for the input B.

SW1 (A) and SW2 (B)	1	2	3	4	5
Magnetic pickup	off	off	on	off	off
NAMUR sensor	on	off	on	on	off
TTL/24V (Encoder)	on	off	off	off	on
NPN sensor	on	on	off	off	off
PNP sensor	on	off	off	on	off
Contact closure	on	on	on	off	on

Select the excitation supply by means of the J1 jumper.

EXCITATION	JUMPER J1
8V DC	1-2
24V DC	2-3

14

2.4. INPUT SIGNAL CONNECTION

COUNTER

When using the two inputs for counting UP and DOWN, the main sensor must be connected to the A input and the secondary sensor (signal that determines the UP or DOWN direction) to the B input. If only one input is to be used, this must be the A input.

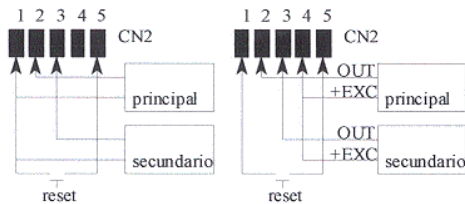

MAGNETIC PICKUP & CONTACT CLOSURE

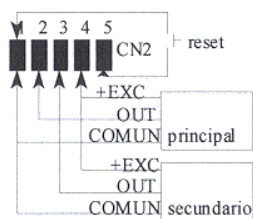

NAMUR SENSOR

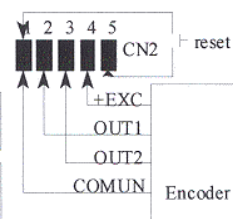

NPN and PNP SENSORS TTL/24V DC (ENCODER)

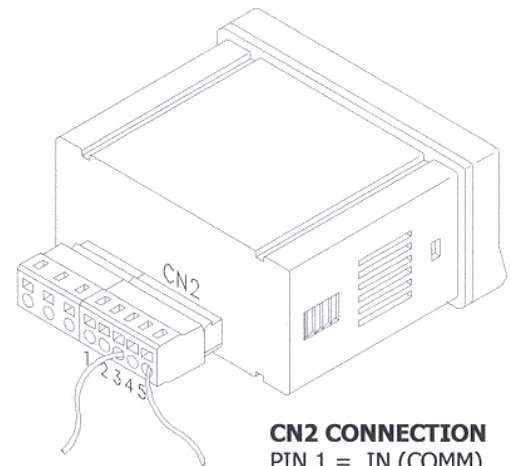

CN2 CONNECTION

- PIN 1 = IN (COMM)
- PIN 2 = +IN A
- PIN 3 = +IN B
- PIN 4 = +EXC (8V/24V)
- PIN 5 = RESET

CHRONOCHRONOMETER (Inputs configured for TTL/24V)

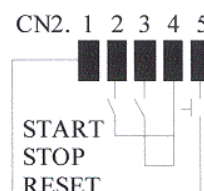

[A = START, B = STOP] [A on = START / A off = STOP]

15

3. PROGRAMMING INSTRUCTIONS

3.1. INTRODUCTION

Connect the instrument to the supply. For a few seconds the display illuminates all segments, decimal points and LEDs as a test of their correct function. After, in absence of input signal, the display shows the last registered value. If the instrument is to be used for the first time, this value is zero.

To enter in the programming mode, press **ENTER**; the **PROG** LED activates and the display indicates **Pro**. This is the programming entry stage from which it is possible to access to the input configuration module (**F1** LED activates), display configuration module (**F3** LED activates) and, if present, to the serial outputs module (**F2** LED activates) or the setpoints module (**SET1** and **SET2** LEDs activate).

The access from one to other of the programming modules is made by pressing the "**▶**" key until the LED corresponding to the desired function activates. A press of **ENTER** gives access to the configuration of the parameters in this menu.

The normal sequence at each step is to push the "**▶**" key a number of times to make changes and the **ENTER** key to store them in the memory and advance to the next step.

The figures are arranged so that they follow this normal sequence, where the indication with filled-out segments means that the display may show this option or another depending on the previous choice.

PROGRAMMING LOCK-OUT.

Once the instrument's programming has been completed, it is recommended to lockout the access to prevent from accidental or unauthorized modifications. The locking is made by taking off a plug-in jumper located at the rear side of the display (see figure).

NOTE : Remove power before opening the box and before changing the jumper position.

While the instrument is locked out, it is however possible to access to the programming routines to check the current configuration, but it won't be possible to enter or modify data. In this case, the **Pro** indication is substituted by **dALA**.

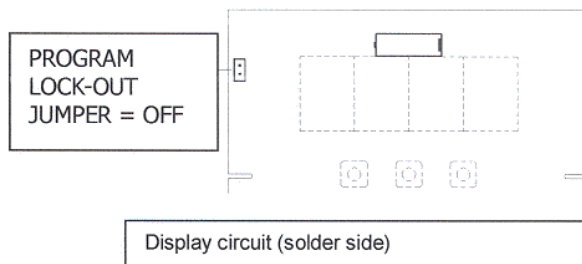

16

PROGRAMMABLE PARAMETERS OF MODEL PAS 49MI

COUNTER PROGRAMMING

In the input configuration module (page 18) select the **COU** option (counter) to get access to the following parameters :

- Decimal point location.
 - Counter direction (up, down or bidirectional counting).
 - Operating mode (see pages 7 and 8).
- and, with indirect access (press of **ENTER** of 3s) :
- Lock-out functions for the RESET key, the offset programming and the setpoints programming (see page 22).

Once the instrument has been programmed as a counter, the display configuration module (page 23) allows to change its basic functioning by means of the following options :

- Input multiplier factor from 0.001 to 9.999.
- For example, if it is desired that the display varies 1 count as the input receives 10 pulses, the multiplier factor must be 0.100
- Debounce filter with 20Hz cut-off frequency.

CHRONOMETER PROGRAMMING

In the input configuration module (page 26) select the **CHrO** option (chronometer) to have access to the following parameters:

- START and STOP signals operating mode (see page 9).
- and, with indirect access (press of **ENTER** of 3s) :
- Lock-out functions for the RESET key and the setpoints programming (see page 28).

In the display configuration module (page 29), it will be necessary to select one of the following time ranges :

- Hundredths of second (99.99s).
- Tenths of second (999.9s).
- Seconds (9999s)
- Minutes and seconds (99min59s)
- Hours (9999h).

17

3.2. PROGRAMMING THE COUNTER

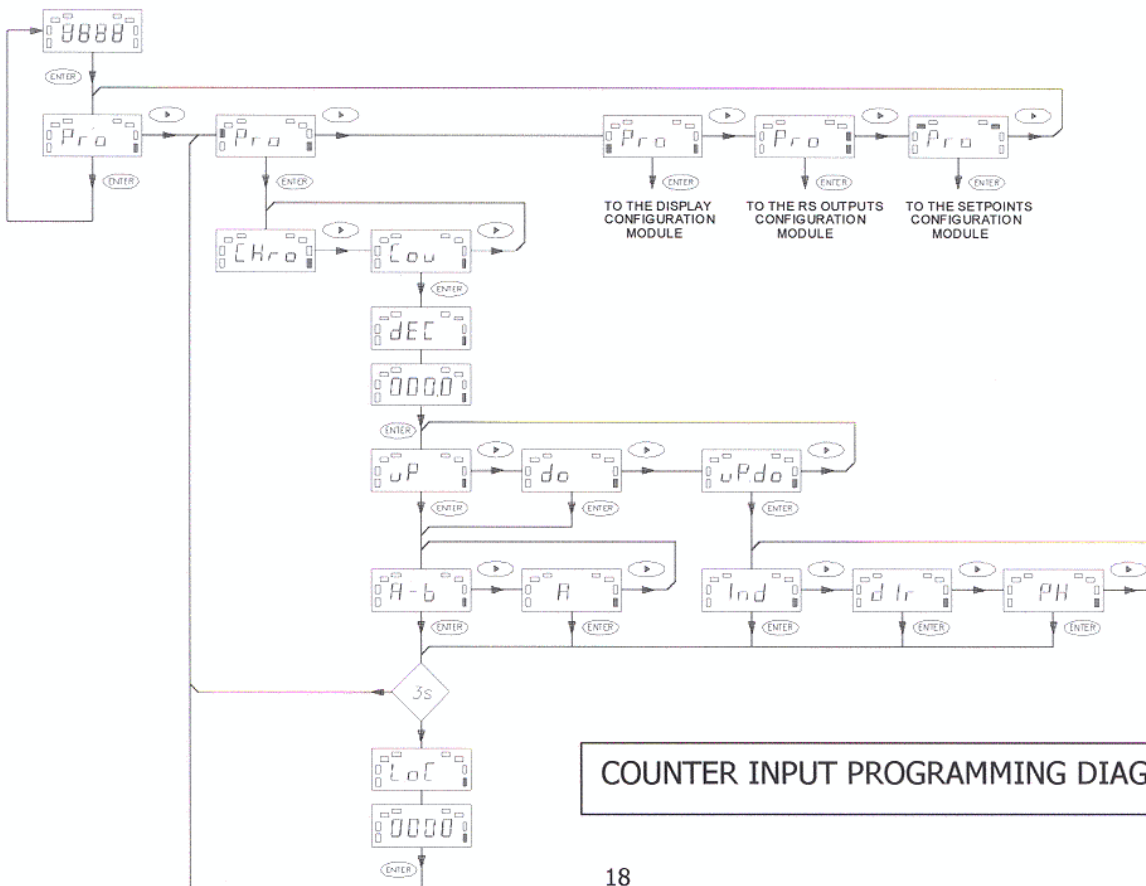

18

3.2.1. PROGRAMMING THE COUNTER INPUT

[19.1]

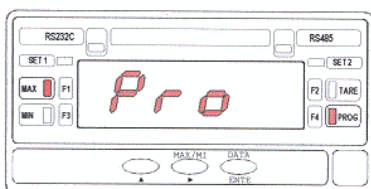

The figure 19.1 shows the indication corresponding to the entry stage of the input programming module.

From the run mode, press **ENTER** and **▶** to access this level.

Once programmed the last module parameter, the instrument will go back to this stage. To return to the RUN mode, press repeatedly the **▶** key until all LED's deactivate except the PROG LED and press **ENTER**. The meter exits from the programming mode and goes to the normal operation.

[19.2]

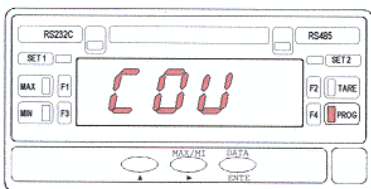

A press of **ENTER** made at previous step allows access to the selection of the meter type : counter (**COU** indication) or chronometer (**CHro** indication).

Press the **▶** key, if necessary, to make the display indicate **COU** and press **ENTER** to enter in the programming routine corresponding to the counter configuration.

[19.3]

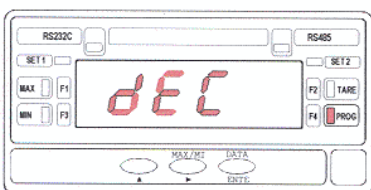

The first menu step is the decimal point location. The indication shown in figure 19.3 appears for 2 seconds before this item is allowed to be changed.

After 2s or by pressing the **ENTER** key, the display shows "0000" with the decimal point in its previously selected position.

Press repeatedly the **▶** key to shift the decimal point to the right until it gets the desired position and press **ENTER** to validate the entry and pass to the phase represented in figure 20.1.

[20.1]

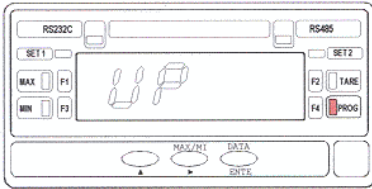

This program phase allows to select the counter direction. The figure shows one of the possible options : **UP** = UP counter, **DO** = DOWN counter and **UP.DO** = UP/DOWN (bidirectional) counter. The three options alternate on the display by successively pressing the **▶** key. When the indication corresponding to the desired option appears on the display, press **ENTER** to validate the choice and advance to the next program step.

IF "UP" or "DO" HAVE BEEN SELECTED ...

In case you have selected one of the uni-directional counting options ("UP" or "DOWN"), the next program step offers two options; "A" for using one meter input and "A-b" for using the two inputs, in order to operate the counter in one of the following modes (see page 6):

[20.2]

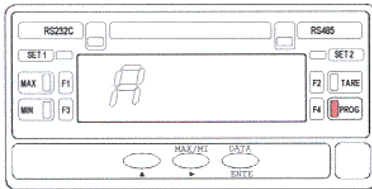

The input A receives the pulses that increment or decrement the counter.

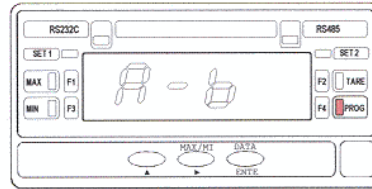

The input A receives the pulses and the input B starts or stops the counter.

By pressing the **▶** key, the display alternates between the "A" and "A-B" indications. Use this key if desired to change the option present on display and, from this level :

- A push of 3 seconds on the **ENTER** key gives access to the lock-out functions routine (go to page 22).
- A push of **ENTER** of less than 3 seconds returns the meter to the **Pro** stage (fig. 19.1).

IF "UP.DO" HAS BEEN SELECTED ...

The bidirectional counter ("UP.DO" option) provides three selectable modes of operation (see page 8). From the phase represented by figure 20.1, select the "UP.DO" option and press **ENTER**. The display shows one of the indications represented in the following three figures, each corresponding to a specific UP/DOWN counting mode :

[21.1]

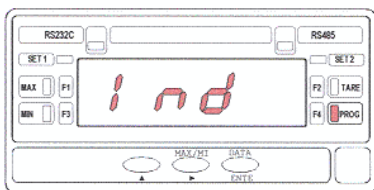

Independent mode

A counts up,
B counts down

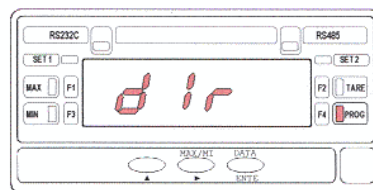

Directional mode

while B = 0, A counts down
while B = 1, A counts up

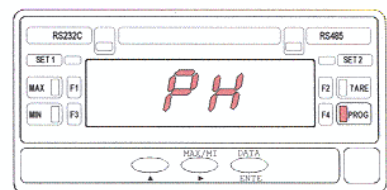

Phase mode

each time the signal changes its phase, the counter changes its direction

Press repeatedly the **▶** key to make the display rotate around the different options and, when the indication corresponding to the desired mode appears on display, hold down the **ENTER** key for 3 seconds to get access to the lock-out functions routine (go to page 22), or Press **ENTER** for a shorter time to return the meter to the **Pro** level (fig. 19.1).

COUNTER LOCK-OUT FUNCTIONS ROUTINE

[22.1]

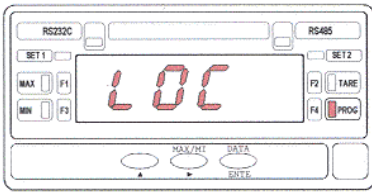

The lock-out functions routine is accessible, from the phase represented in fig. 20.2 or in fig. 21.1, by holding down the "ENTER" key for 3 seconds, at the end of which the display shows the indication given by figure 22.1. The indication **LOC** is viewed for 2 seconds before passing to the level represented on the next figure, where the display may shown any combination of "0" and "1" (depending on previous settings) with the first digit in flash.

[22.2]

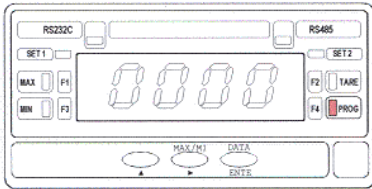

From left to right ;
 El 1st digit has no function. Press to shift to the next digit.
 El 2nd digit permits to lock out the setpoints programming routine. (0=access allowed, 1=access denied). Press the key if desired to change the flashing digit value and the key to advance to the next digit.
 El 3rd digit enables/disables the display offset programming. (0=enabled, 1=disabled). Press the key to change the digit from "0" to "1" or viceversa and the key to accede to the last digit.
 El 4th digit allows to inhibit the action of the reset key. One "0" enables the reset function by front-panel key and one "1" disables this function. Use the key if desired to change the active digit value, or the key if desired to start again the programming from the first digit and press to save changes in the memory and return to the **Pro** level (page 19).

3.2.2. DISPLAY PROGRAMMING IN COUNTER MODE

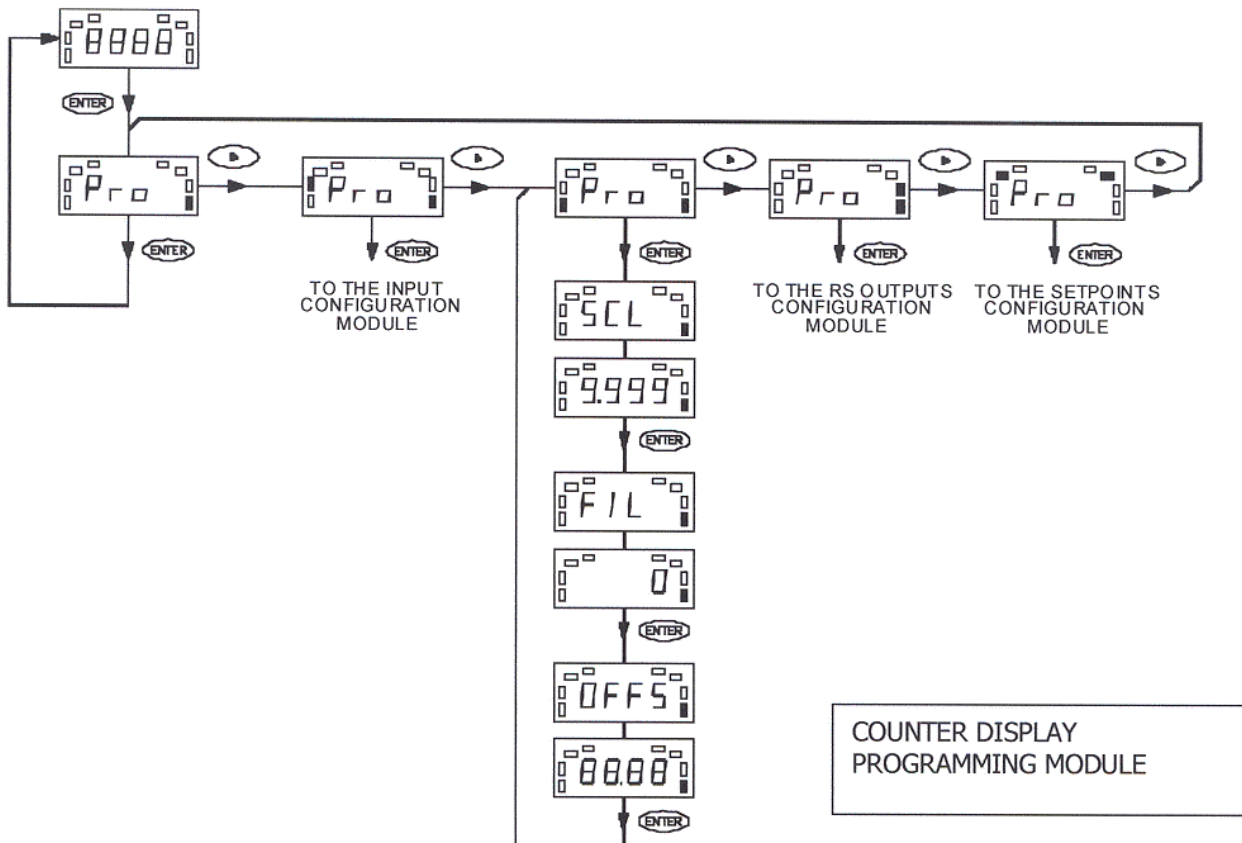

PROGRAMMING THE COUNTER DISPLAY

[24.1]

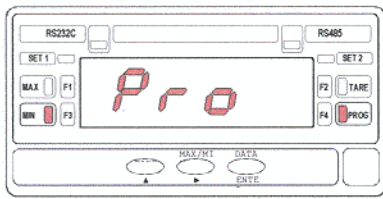

The figure 30.1 shows the indication corresponding to the entry stage of the display programming module. From the run mode, press "ENTER" and two times to access this level.

Once programmed the last module parameter, the instrument will go back to this stage. To return to the RUN mode, press repeatedly the key until all LED's deactivate except the PROG LED and press . The meter exits from the programming mode and goes to the normal operation.

[24.2]

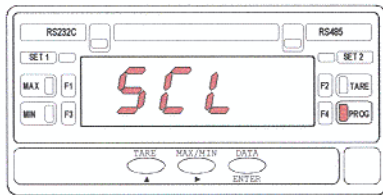

A press of "ENTER" made at previous step gives access to the programming of the input multiplier factor. This parameter permits the display to read the number of input pulses multiplied by a programmable factor between 0.001 and 9.999.

The indication shown in figure 24.2 is viewed for 2 seconds before the input factor is allowed to be programmed. At the end of these 2 seconds or by a press of "ENTER" the previously programmed factor appears on the display with its first digit in flash. Press repeatedly the key to increment the flashing digit value between 0 and 9 and when it takes the desired value, press to move to the next digit to the right. Repeat these operations until the desired multiplier factor is registered on the display and press to save the entry in the memory and advance to the next programming phase.

If it is wanted to read the actual number of input pulses without any factor, this parameter must be set to 1.000

24

[25.1]

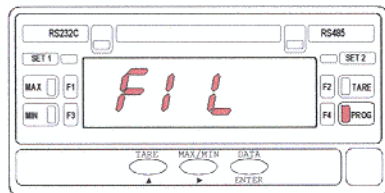

In this program step it is possible to activate a debounce filter with a cut-off frequency of 20Hz.

The figure 25.1 shows the indication that appears on the display by a press of "ENTER" on the previous phase. After 2 seconds or by pressing the "ENTER" key, the display shows "0" or "1" depending on the initial configuration.

The "0" means filter OFF (the meter admits any frequency in the range specified for the counter) and the "1" means filter ON (it only admits signals of frequency lower than 20Hz).

Press if it is desired to change the option present on the display and press to validate the choice and go to the next programming phase.

The next phase (fig. 25.2) is accessible if the display offset programming routine is not locked out (see section "LOCK-OUT FUNCTIONS ROUTINE"). If this parameter is locked out, the instrument returns to the **Pro** stage given on figure 24.1 with data memory storage.

[25.2]

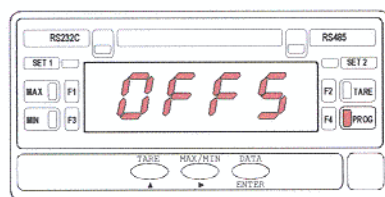

If the display offset programming is enabled, a press of made at previous step gives access to the programming of the value from which the meter starts counting after each reset.

The initially programmed value appears on the display with the first digit in flash, preceded, for 2 seconds, by the indication shown on figure 25.2.

Use the procedure described in fig. 24.2 (changes the flashing digit value, advances to the next digit to the right) until the desired value is composed on the display and press to save data in the memory and return to the **Pro** stage.

25

3.3. PROGRAMMING THE CHRONOMETER

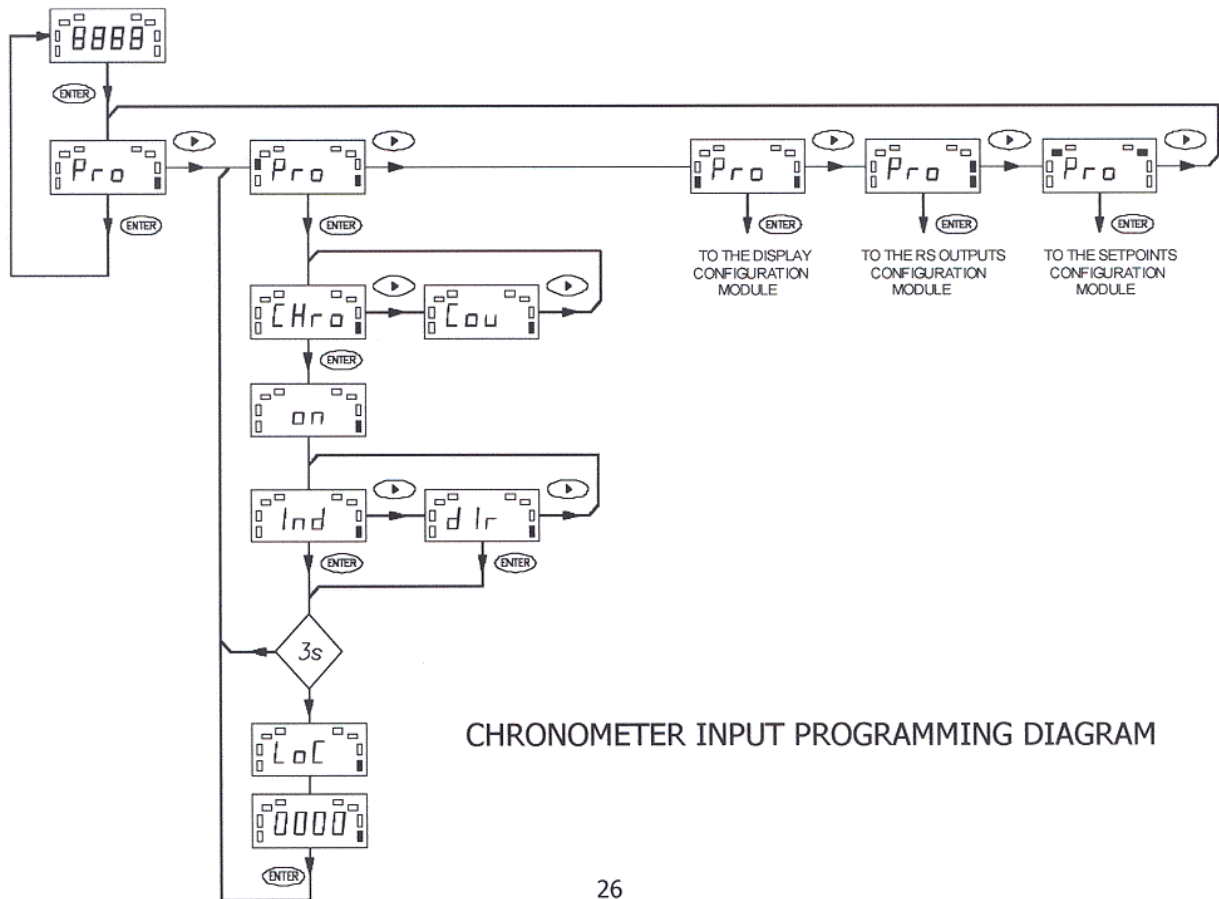

26

[27.1]

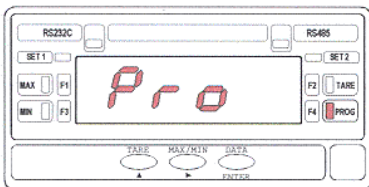

The figure 27.1 shows the indication corresponding to the entry stage of the input programming module.

From the run mode, press **ENTER** and **▶** to access this level.

Once programmed the last module parameter, the instrument will go back to this stage. To return to the RUN mode, press repeatedly the **▶** key until all LED's deactivate except the PROG LED and press **ENTER**. The meter exits from the programming mode and goes to the normal operation.

[27.2]

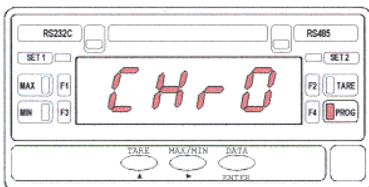

A press of **ENTER** made at previous step gives access to the selection of the meter type : Counter (**COU** indication) or Chronometer (**CHrO** indication).

Press the **▶** key, if necessary, to make the display show the option **CHrO** and press **ENTER** to access to the programming of the chronometer inputs mode (see page 9).

[27.3]

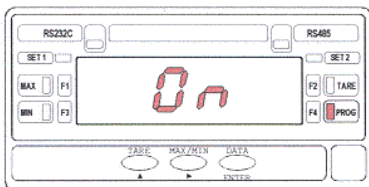

The indication represented in figure 27.3 is displayed for 2 seconds before entering in the chronometer mode programming phase. After 2 seconds or by pressing **ENTER**, the display shows the indication corresponding to the initially programmed mode:

Ind = INDEPENDENT, **dIr** = DIRECTIONAL.

Use the **▶** key to select the desired option (page 9) and :

press **ENTER** for 3s to get access to the lock-out functions routine (page 22), or press briefly the **ENTER** key to validate the choice and automatically go to the **Pro** level (fig. 27.1).

CHRONOMETER LOCK-OUT FUNCTIONS

[28.1]

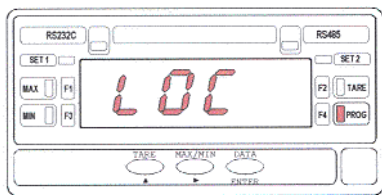

The chronometer lock-out functions are accessible, from the stage represented in figure 27.3, by holding down the **ENTER** key for 3 seconds, at the end of which the display shows the indication **LOC** given on the left figure. This indication is viewed for 2 seconds before passing to the phase represented in the next figure, where the display may show any combination of "0" and "1" (depending on previous configuration) with the first digit in flash.

[28.2]

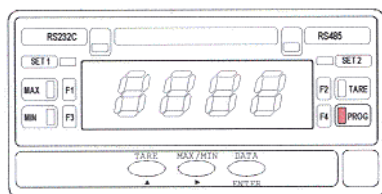

Starting from the left ;
 The 1st digit has no function, press **▶** to go to the next digit to the right.
 The 2nd digit allows to lock out the setpoints programming : (0=enabled, 1=locked out). Press the **▲** key if wanted to change the value of the flashing digit and the **▶** key to advance to the next digit to the right.
 The 3rd digit has no function in the chronometer configuration; Press **▶** to pass to the next one.
 The 4th digit controls the action of the "RESET" key. One "0" allows to make reset on the front panel and one "1" disables this function. Use the **▲** key if desired to change the digit value, or **▶** if wanted to start the programming by the first digit and press **ENTER** to validate the introduced data and return to the **Pro** level (page 27).

3.3.2. PROGRAMMING THE CHRONOMETER SCALE

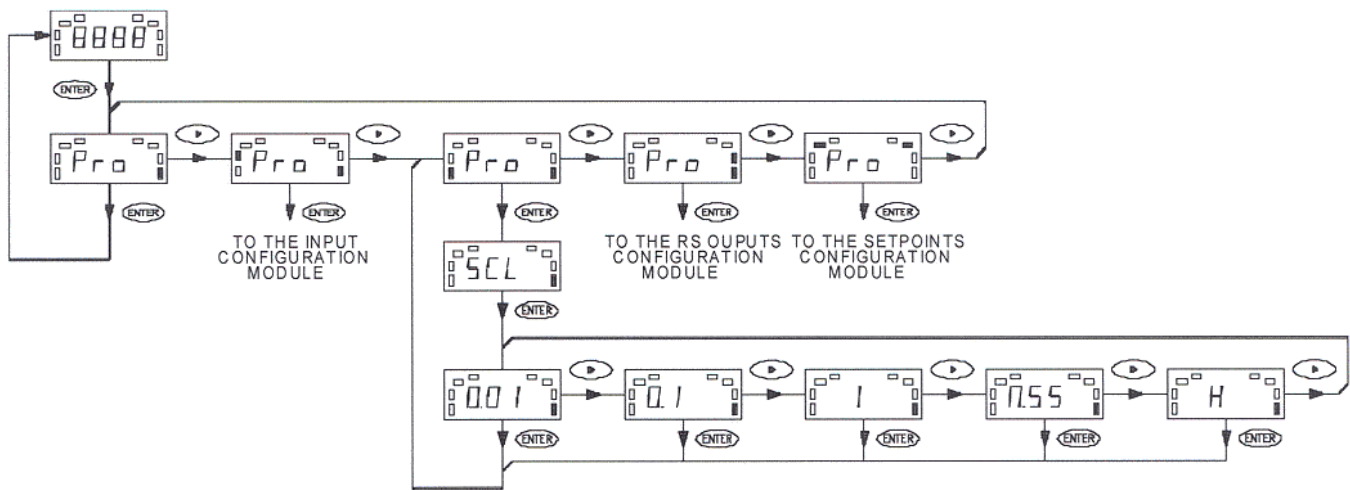

CRONOMETER PROGRAMMING DIAGRAM

CHRONOMETER DISPLAY PROGRAMMING

[30.1]

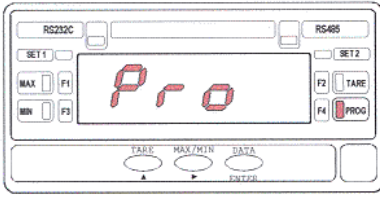

The figure 30.1 shows the indication corresponding to the entry stage of the display programming module. From the run mode, press **ENTER** and two times **▶** to access this level.

Once programmed the last module parameter, the instrument will go back to this stage. To return to the RUN mode, press repeatedly the **▶** key until all LED's deactivate except the PROG LED and press "ENTER". The meter exits from the programming mode and goes to the normal operation.

Press **ENTER** to access to the phase represented in the next figure.

[30.2]

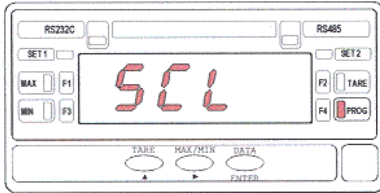

The indication given by figure 30.2 is viewed for 2 seconds before entering in the chronometer scaling. After 2 seconds or by a press of **ENTER** the display will show the indication corresponding to the initially programmed scale :

[**0.01** = hundredths of second, **0.1** = tenths of second, **1** = seconds, **M.SS** = minutes and seconds, **H** = hours].

Press repeatedly the **▶** key to shift around the different options and, when the desired scale appears on the display, press **ENTER** to save the choice in the memory and automatically go to the **Pro** stage of figure 30.1.

30

4. CHARACTERISTICS

4.1. OUTPUT OPTIONS

As an option, the PAS 49MI models can incorporate the following output cards : A serial outputs card with RS232C and RS485 communications protocol, 1200 to 9600 baud half-duplex. Both types are included in the option but only one of them can be operative as selected via software. Ref. **RS6**

A control card with 2 SPST relay outputs rating 8A @ 250V AC / 150V DC. The option provides four selectable control modes and selection of impulsional (with programmable pulse width) or latched output for each relay. Ref. **2RE**

The output options consist of additional cards that are supplied with their specific instructions manual describing characteristics, installation, programming and operation. Once installed in the meter's assembly by means of plug-in connectors, a program module is automatically included in the software routines.

For more detailed information on characteristics, applications, mounting and programming, please refer to the specific manual furnished with the option

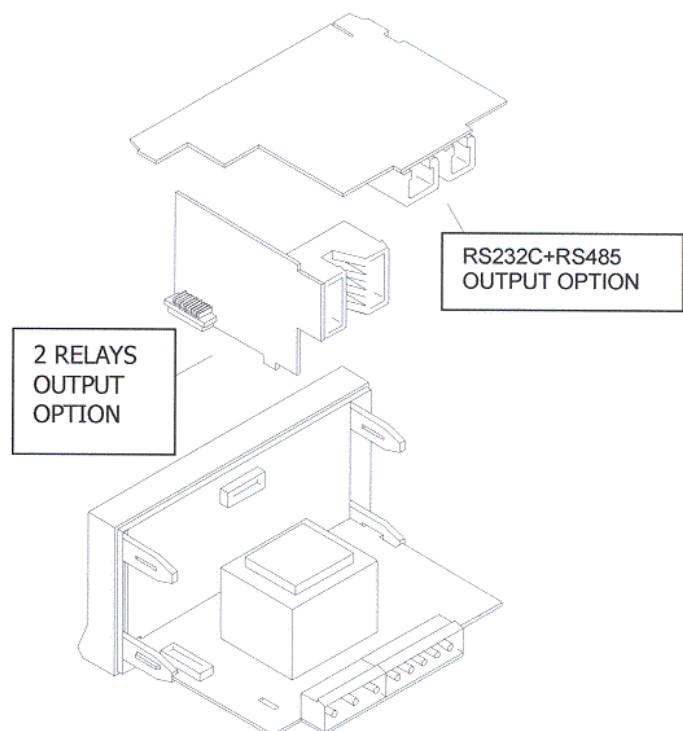

31

4.2. TECHNICAL SPECIFICATIONS

INPUT SIGNAL

Maximum frequency
 Without 2 relay option 2KHz
 With 2 relay option..... 1KHz
 UP/DOWN counter (independent mode) 500Hz

Excitation..... 8V @ 30mA or 24V @ 30mA
 Common mode max. voltage (signal / power supply) :
 AC power..... 1000V DC / 1500V ACpp
 DC power ±400V DC

Magnetic pickup

Sensitivity Vin (AC) > 120mV eff.

NAMUR

Rc..... 1K
 Ion < 1mA DC
 Ioff > 3mA DC

TTL/ 24V DC (encoder)

Logic levels "0" < 2.4V DC, "1" > 2.6V DC

NPN and PNP sensors

Rc..... 1K (incorporated)
 Logic levels "0" < 2.4V DC, "1" > 2.6V DC

Contact closure

Vc..... 5V
 Rc..... 3.9K
 Fc..... 20Hz

POWER SUPPLY

AC voltages 115/230V, 24/48V (±10%) 50/60Hz
 DC voltages . 12 V DC (10.5 a 16V), 24V DC (21 a 32V)
 Power consumption 3W

DISPLAY

Type..... 9999,4 digits red LED14mm
 LED's..... 4 for control and 4 for output status
 Chronometer scales ... 5 escalas, from 99.99s to 9999h
 Counter scale..... programmable multiplier factor
 Overage (+) indication OvE (Up), +OvE (Up/Down)
 Overage () indicationUndE (Down), -OvE (Up/Down)

ACCURACY

Temperature coefficient..... 100 ppm/ C
 Warm-up time..... 5 min.

ENVIRONMENTAL

Operating temperature..... -10 C to +60 C
 Storage temperature..... -25 C to +85 C
 Relative humidity (non condensing)..... <95% to 40 C

MECHANICAL

Dimensions..... 96x48x60mm
 Weight..... 250g
 Case material..... polycarbonate s/UL 94 V-0
 Degree of protection IP65

32

4.3. DIMENSIONS (mm) AND MOUNTING

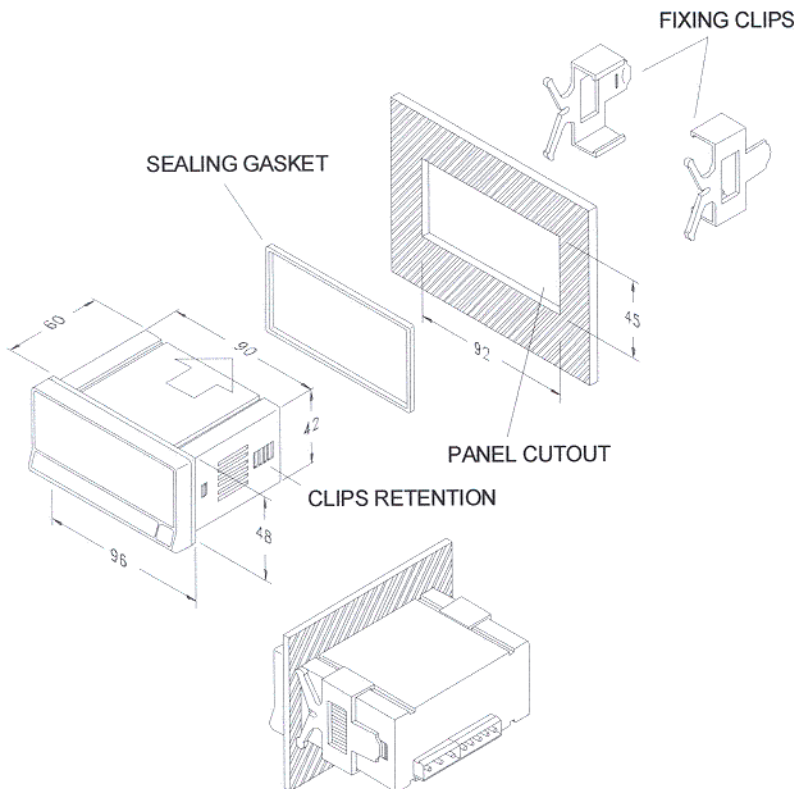

To install the instrument into the panel, make a 92x45mm cutout and insert the instrument into the panel from the front, placing the sealing gasket between this and the front bezel.

Place the fixing clips on both sides of the case and slide them over the guide tracks until they touch the panel at the rear side. Press slightly to fasten the bezel to the panel and secure the clips at the retention protrudings.

To take the instrument out of the panel, pull outwards the rear tabs of the fixing clips to disengage and slide them back over the case.

33

7. APPLICABLE STANDARDS

Applicable Standards : **EN50081-1** Generic emission
EN55022/CISPR22 Class B

Applicable Standards : **EN50082-1** Generic immunity
IEC1000-4-2 Level 3 Criteria B
Air Discharge 8kV
Contact Discharge 6kV

IEC1000-4-3 Level 2 Criteria A
3V/m 80..1000MHz

IEC1000-4-4 Level 2 Criteria B
1kV Power Lines
0.5kV Signal Lines

Applicable Standards : **EN61010-1** Generic Safety
IEC1010-1 Installation Category II
Transient Voltages <2.5kV
Pollution Degree 2
Conductive pollution excluded
Insulation Type
Enclosure : Double
Inputs/Outputs : Basic

PAS49MI

ANNEXE : PROGRAMMING AND OPERATION OF THE **2RE** OPTION

TABLE OF CONTENTS

Functional description	34
UP COUNTER diagrams	35
DOWN COUNTER diagrams	36
UP/DOWN COUNTER diagrams	37
CHRONOMETER diagrams	38
PROGRAMMING THE 2RE OPTION	
Programming diagram. Description	40
Programming the setpoint values	42
Programming the operating modes	43

OPERATING MODES : DESCRIPTION

The 2 relay option (supplied independently) provides the instrument with a totally programmable control module that gives aports additional working modes and relay outputs. The reference of this option is 2RE.

IMPORTANT

ANY "2RE" OPTION CAN BE INSTALLED IN THE PAS49MI MODELS TAKING NOTICE OF THE FOLLOWING INSTRUCTIONS :

You must refer to pages 8, 9 and 10 to install the card, make wiring connections and consult the technical specifications. Leave out the rest of the pages since they do not include the programming instructions nor the functional description of the setpoints with relation to the PAS49MI model. These instructions can be found in the present annexe.

The 2RE programming routines allow to configure the setpoint values, the type of each relay output (impulsional with programmable pulse width, or latched) and one of the following four control modes :

Mode 1

Both relays energize when the display reaches the setpoint value. The counter goes on until a RESET is produced. The RESET deactivates the relays (if they are still ON) and returns the meter to the OFFSET value.

Mode 2

Both relays energize when the display reaches the setpoint value. The counter stops on the setpoint 2. One RESET deactivates the relays (if they are still ON) and brings the meter to the indication of the OFFSET value.

Mode 3

Both relays energize when the display reaches the setpoint value. The RESET is automatically made when the display reaches the setpoint 2 which also deactivates the relays (if they are still ON) and brings the meter to the indication of the OFFSET value.

Mode 4

The relay 1 is activated on the setpoint 1 and deactivated on the setpoint 2. The counting goes on until a RESET makes the instrument return to the OFFSET value.

When overrange occurs, the relays are held at their previous state until a reset action.

UP COUNTER FUNCTIONAL DIAGRAMS

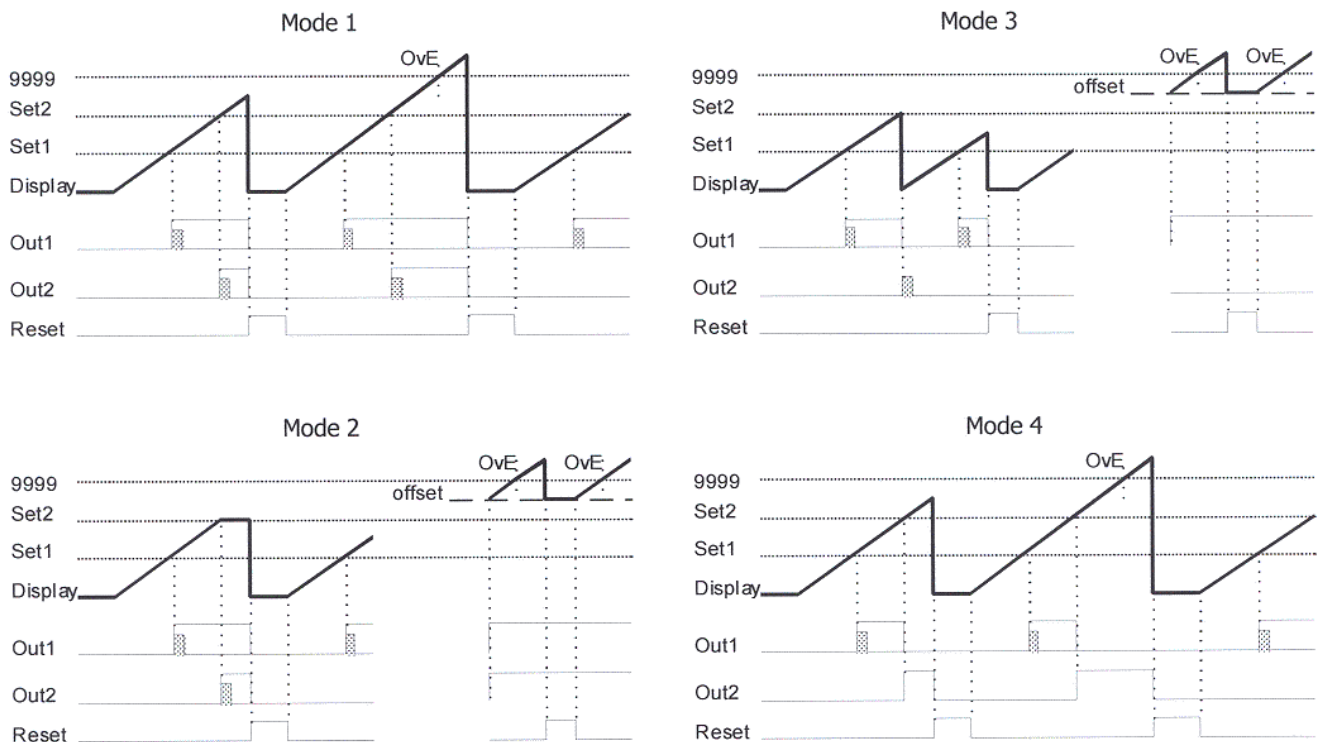

Both impulsional mode () and latched mode () are represented for each relay output (Out1 and Out2).

DOWN COUNTER FUNCTIONAL DIAGRAMS

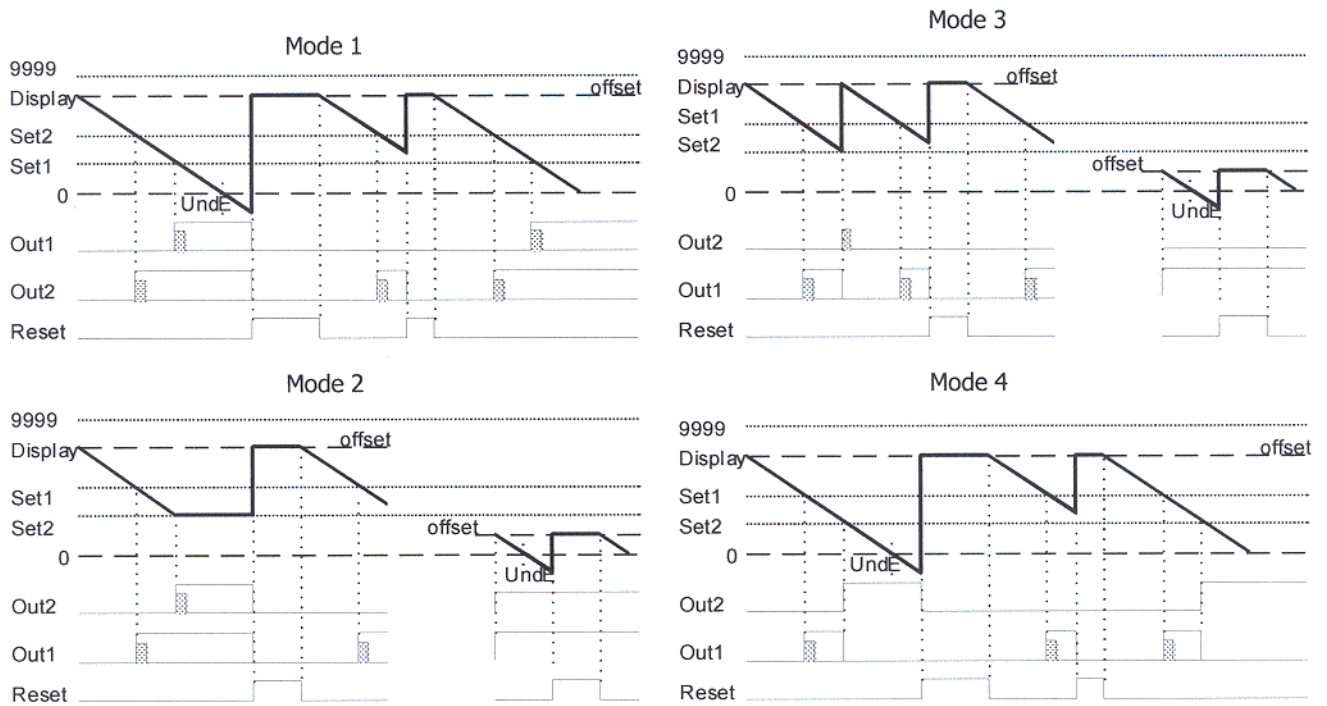

Both impulsional mode () and latched mode () are represented for each relay output (Out1 and Out2).

UP/DOWN COUNTER FUNCTIONAL DIAGRAMS

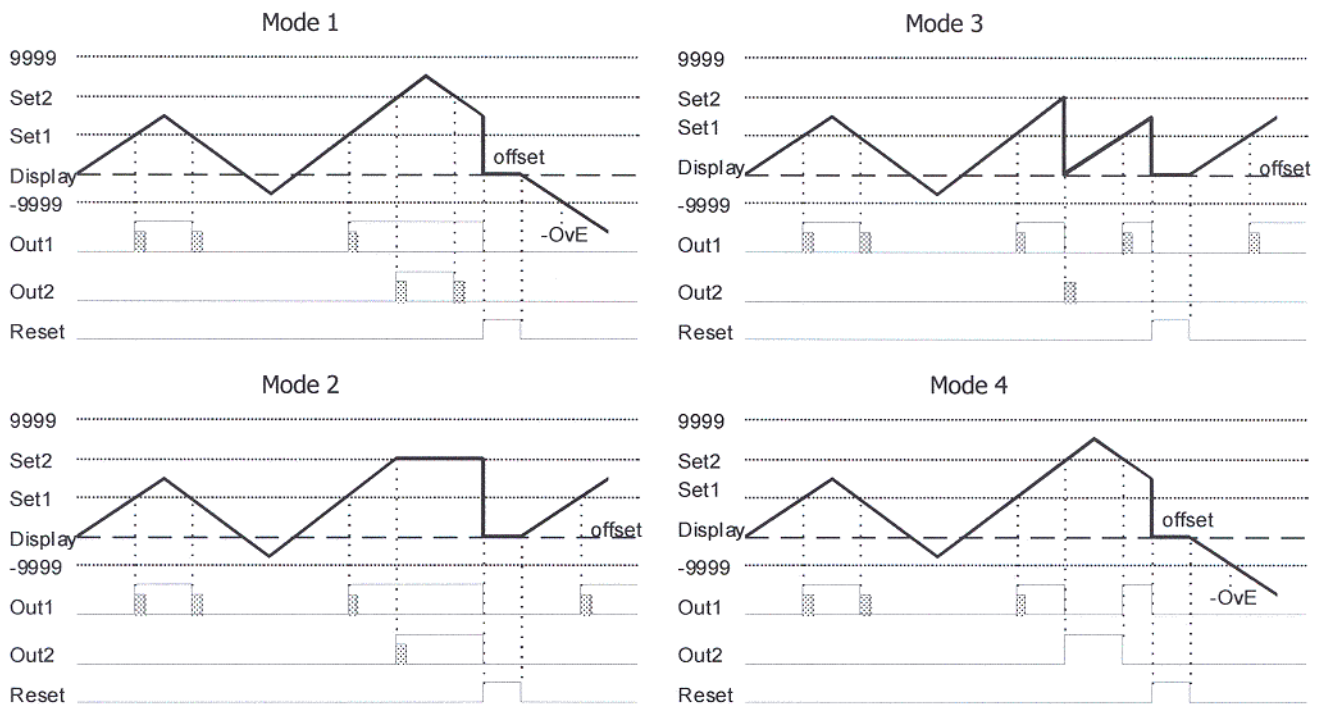

Both impulsional mode () and latched mode () are represented for each relay output (Out1 and Out2).

CHRONOMETER FUNCTIONAL DIAGRAMS

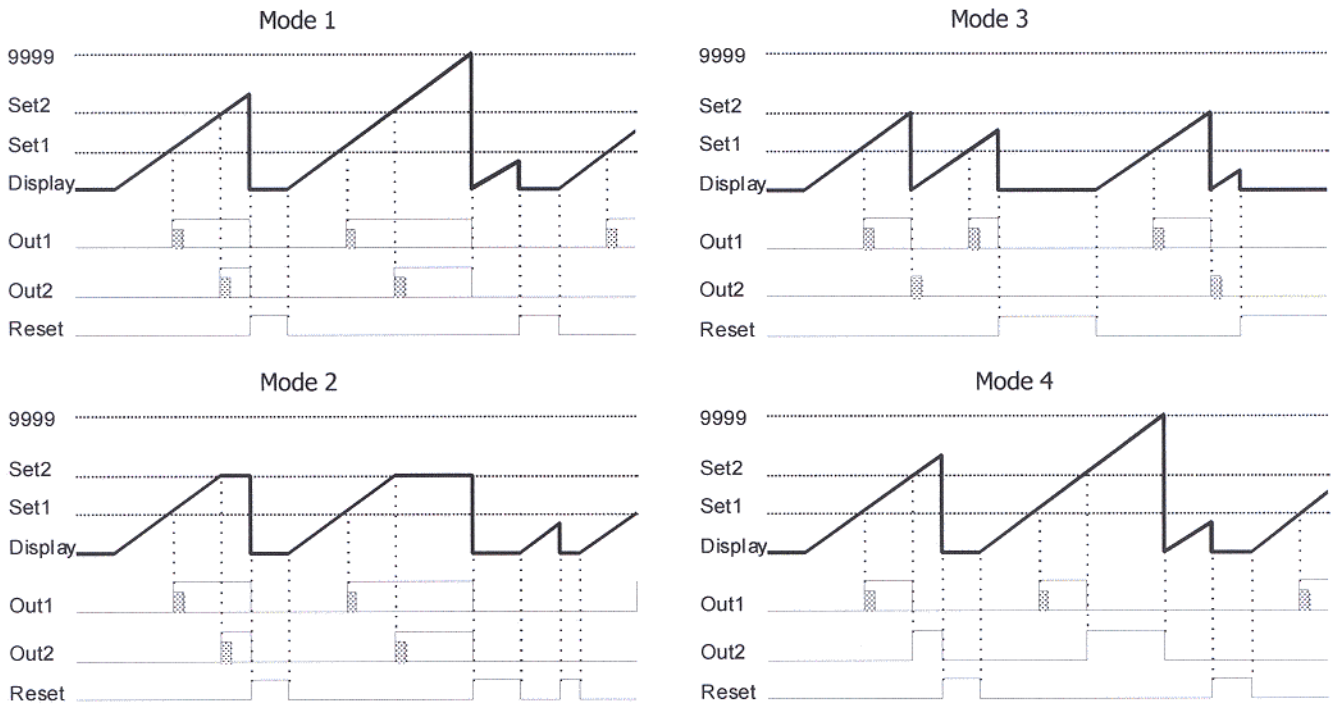

Both impulsional mode () and latched mode () are represented for each relay output (Out1 and Out2).

7. SETPOINT PROGRAMMING MODEL PAS49MI



MODEL PAS49MI SETPOINTS PROGRAMMING DIAGRAM

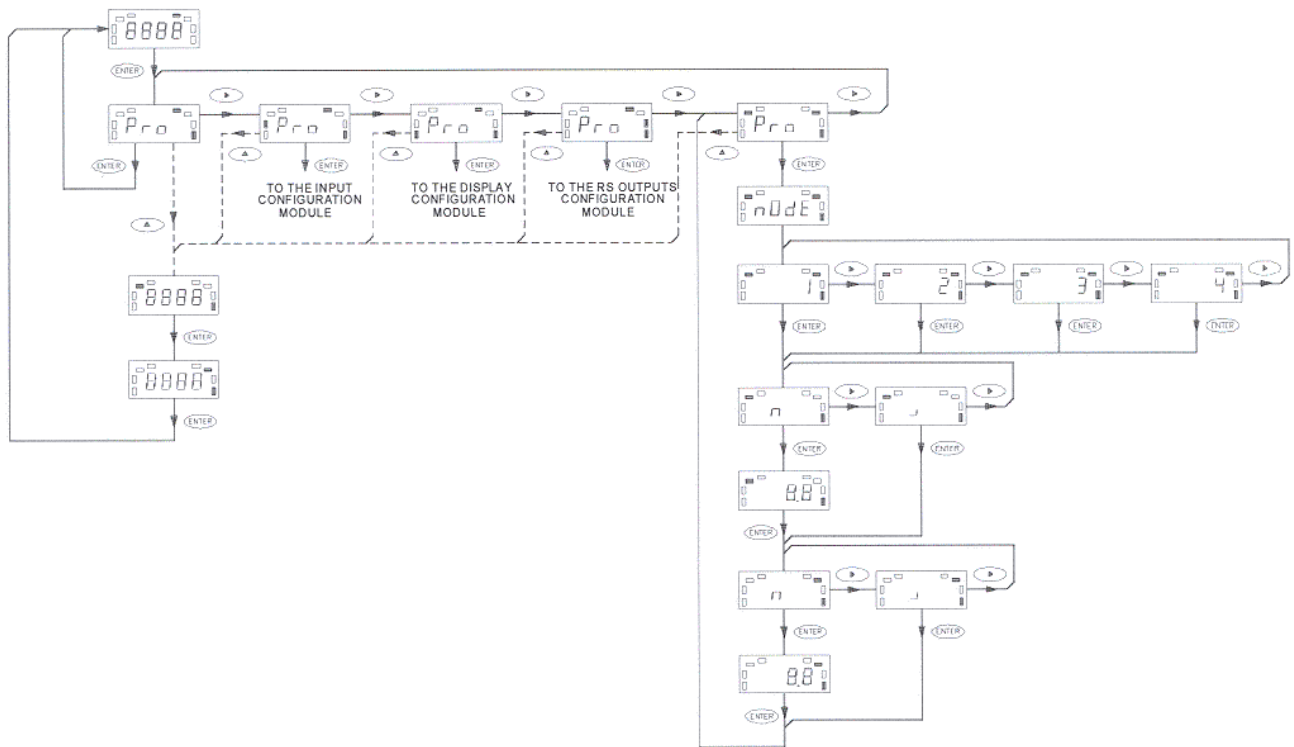

40

PROGRAMMING THE 2RE OPTION

DEFINITION.

The diagram represented on page 40 shows the setpoints programming module, which is valid for the PAS 49MI models with 2RE option installed.

The programmable parameters of this option are the following :

- The setpoint values, programmable from -9999 to 9999 for the UP/DOWN counter and from 0 to 9999 for the other configurations.
- The control mode (see pages 34 to 38).
- The type of each relay output ; IMPULSIONAL OUTPUT with programmable pulse width (0.1s to 9.9s) or LATCHED OUTPUT with deactivation on a reset.

ACCESS TO THE PROGRAMMING OF THE SETPOINT VALUES.

The setpoint values are directly accessed from the **Pro** level in any of the programming modules (hidden lines in the diagram, page 40).

From the run mode, press **ENTER** to get access to the programming mode and press "▲" to enter in the first setpoint programming phase. Follow the programming instructions given on page 42.

This routine can not be locked out by hardware with the rest of the programming routines as indicated on page 16 of the PAS49MI manual.

ACCESS TO THE PROGRAMMING OF THE CONTROL MODE.

From the run mode, press **ENTER** to acced to the programming mode ; the display indicates **Pro** and the **PROG** LED illuminates.

Press repeatedly the ▶ key until the **SET1** and **SET2** LED's activate.

A press of **ENTER** at this step provides access to the programming of the relays functional parameters according to pages 43 and 44.

This routine can be locked out by jumper with the rest of the programming

PROGRAMMING THE VALUES FOR SETPOINTS

[42.1]

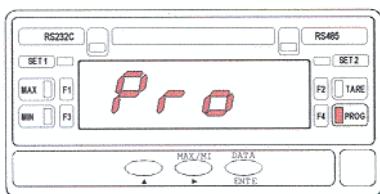

The figure 42.1 shows the **Pro** stage, where the "▶" key leads to the different programming modules or the **ENTER** key returns the meter to the normal operation.

To get access to the programming of the setpoints values, it will only be necessary to bring the meter to this level (or any other **Pro** level) and press the ▲ key.

[42.2]

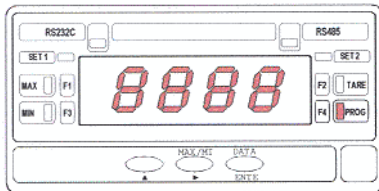

A press of ▲ made at previous step presents on display the current value for the setpoint 1 with the SET1 LED activated and the first digit blinking.

If it is desired to change the setpoint 1 initial value, press repeatedly the ▲ key to modify the value of the active digit between 0 and 9. When the digit takes the desired value, press ▶ to shift to the next digit on the right. Repeat these operations with all the digits until the display shows the new value.

In case of UP/DOWN counter configuration, after programming the last digit, a press of ▶ makes the UP LED or the DOWN LED blink to indicate positive or negative sign respectively. By means of the ▲ key, select the sign for the setpoint1 and once the display registers the complete value with sign, press **ENTER** to save in the memory and advance to the next programming step.

[42.3]

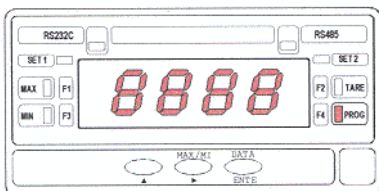

After, the initially programmed value for the setpoint 2 appears on the display (the SET2 activates) with the first digit blinking. Proceed as in the previous section: ▲ changes the blinking digit value and ▶ advances to the next digit, to program the desired new value with sign.

A press of **ENTER** brings the instrument to the run mode with data memory storage.

— 42 —

CONTROL MODE PROGRAMMING MENU

[43.1]

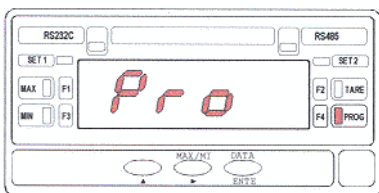

From the run mode, press **ENTER** to enter in the programming mode and press repeatedly the ▶ key until the display shows the indication given by figure 43.1 (display **Pro**, leds **PROG**, **SET1** and **SET2** activated).

This module permits selection among the four available control modes, the output type of each relay and, in case of impulsional type, the pulse width. Press **ENTER** to access to the configuration of these parameters.

Once programmed the last module parameter, the instrument will go back to this stage. To return to the RUN mode, press repeatedly the ▶ key until all LED's deactivate except the PROG LED and press **ENTER**. The meter exits from the programming mode and goes to the normal operation.

[43.2]

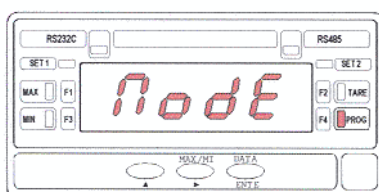

The indication given on the figure 43.2 is viewed for 2 seconds before the control mode is allowed to be selected. At the end of 2 seconds or by a press of **ENTER**, the display shows the number corresponding to the initially selected mode (1 to 4).

Press repeatedly the ▶ key to rotate around the available options and, when the display shows the number corresponding to the desired mode (see pages 34 to 38), press **ENTER** to validate the choice and advance to the next programming step (fig. 44.1).

[44.1]

IMPULSIONAL OUTPUT

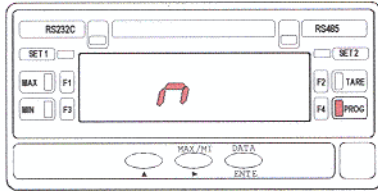

LATCHED OUTPUT

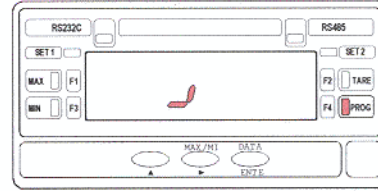

A press of **ENTER** makes the display show one of the indications given in fig. 44.1 (according to previous configuration).

The SET1 LED is activated to mean that the output type selection will be applied to the setpoint 1.

The LATCHED OUTPUT option means that the relay 1 will be held to the ON status until a RESET is produced or until the out of limit condition terminates.

The IMPULSIONAL OUTPUT option means that the relay 1 will activate on the setpoint 1 and will deactivate at the end of the programmed pulse width.

Press **▶** if necessary, to display the indication corresponding to the desired output type. Press **ENTER** to validate the choice and,

If you have selected LATCHED OUTPUT, the SET2 LED activates and the initial output type of the setpoint 2 appears on the display.

If you have selected IMPULSIONAL OUTPUT, it will be necessary to program the pulse time. Go to figure 44.2

[44.2]

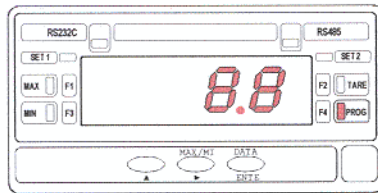

The pulse width of an impulsional output can be programmed from 0.1 to 9.9 seconds. In this program step, the display shows the previously programmed value with the first digit blinking. Use the **▲** key to modify the active digit value and the **▶** key to advance to the next digit until the desired pulse width is composed on the display and press **ENTER** to save the entry and go to the programming of the output type for the setpoint 2 (the SET2 LED illuminates).

Proceed as described in the present section to configure the output type of the setpoint 2, once programmed the last menu parameter, the instrument will return to the Pro level of fig. 43.1