



*Maintenance & Safety Manual for  
Saw Chain, Guide Bars, and Drive Sprockets*

**Saw Chain, Guide Bar and Drive Sprocket**

# Maintenance and Safety Manual

Oregon® Maintenance & Safety Manual



**Blount, Inc.**  
**Oregon Cutting Systems Group**  
 4909 S.E. International Way (97222-4607)  
 P.O. Box 22127 • Portland, Oregon • 97269-2127  
 (503) 653-4706  
[www.oregonchain.com](http://www.oregonchain.com)



**Oregon Distribution Ltd.**  
 Guelph, Ontario, Canada N1H 6L4  
 (519) 822-6870  
[www.oregonchain.ca](http://www.oregonchain.ca)

*This Maintenance & Safety Manual supercedes and replaces  
all previous Oregon® Maintenance & Safety Manuals*

**Read and follow all Chainsaw  
Safety Warnings and  
Important Safety Information.**

Printed in USA  
F/N A106971 AG 0904

# Chainsaw Safety

## IMPORTANT SAFETY MESSAGE

### SAFETY SYMBOL:

This safety symbol is used to highlight safety messages. When you see this symbol, read and follow the safety message to avoid severe personal injury.

### **WARNING** There is a risk of serious injury to the saw operator or bystanders.

All cutting chain can kick back, which can lead to dangerous loss of control of the chainsaw and result in serious injury to the saw operator or bystanders. Follow all instructions in your chainsaw operator's manual and in this booklet for safe use and proper maintenance of your saw's cutting chain, guide bar, and sprocket. Get information from your local chainsaw dealer as well if you are unsure about the use or maintenance of your saw and its cutting attachments.

## GUARD AGAINST CHAINSAW KICKBACK

△ **Know your personal level of chainsaw experience.**

△ **Know your cutting chain.**

If you do not have experience and specialized training for dealing with chainsaw kickback, then Oregon® urges you to use only low-kickback saw chains which have this blue label.

### ATTENTION: READ THIS

 **WARNING** This saw chain is low kickback chain. It met the kickback performance requirements of ANSI B175.1 when tested on a representative sample of chainsaws. Its safety features significantly reduce the hazard of kickback while maintaining high cutting performance.

ALL CUTTING CHAINS CAN KICK BACK, which may result in severe personal injury to the saw operator or bystanders. Operate your saw safely. Read all warnings in your chainsaw operator's manual.

Saw chains marked with a yellow label, such as the one below, are not low-kickback and are intended for use only by professional chainsaw operators.

### ATTENTION: READ THIS

 **WARNING** The chain in this box may be capable of kickback that could result in serious injury to the saw operator or bystanders. Do not use this chain unless you have experience and specialized training for dealing with kickback. Saw chain with reduced kickback potential is available.

# ANSI Chain Chart

## IMPORTANT SAFETY INFORMATION

## OREGON® SAW CHAIN CLASSIFICATION CHART



### ANSI-STANDARD LOW-KICKBACK SAW CHAIN

Part numbers of Oregon® chain that comply with the ANSI low-kickback standard are highlighted in blue. Packages of Oregon® low-kickback saw chain carry this authorized UL® Classification Marking:



### UNDERWRITERS LABORATORIES, INC. CLASSIFIED LOW KICKBACK SAW CHAIN®

In accordance with American National Standard Low-Kickback Safety Requirements for Gasoline Powered Chainsaws (ANSI B175.1-2000), Paragraph 5.11.2.4, the saw chain in this package is low-kickback saw chain. It met the reduced kickback requirement of ANSI B175.1 when tested on a representative sample of chainsaws. 17R2

Chain Pitch	.043"-gauge Part Number	.050"-gauge Part Number	.058"-gauge Part Number	.063"-gauge Part Number
.325"		33SL Narrow-kerf 95VP	34SL	35SL
3/8"		72V	73V	75V
3/8" 90 Series	Narrow-kerf 90SG	91P, 91VG Power Sharp® 91LX		



### SAW CHAIN FOR PROFESSIONAL USERS

Part numbers of Oregon® chains that do not meet ANSI low-kickback performance requirements are highlighted in yellow. The chains below should be used only by those with experience and specialized training for dealing with kickback.

1/4"	25AP		
.325"	20BP, 20LP, 33LG MultiCut™ Chain: M20LP Ripping Chain: 95R	21BP, 21LP, 34LG MultiCut™ Chain: M21LP	22BP, 22LP, 35LG MultiCut™ Chain: M22LP
3/8"	Round-ground Chain: 72AP, 72DP, 72JG, 72LG, 72JP, 72LP MultiCut™ Chain: M72LP Ripping Chain: 72RD Square-ground Chain: 72CJ, 72CJX, 72 CK, 72CKX 72CL, 72CLX	Round-ground Chain: 73DP, 73JG, 73LG, 73JP, 73LP MultiCut™ Chain: M73LP Ripping Chain: 73RD	Round-ground Chain: 75DP, 75JG, 75LG 75JP, 75LP MultiCut™ Chain: M75LP Ripping Chain: 75RD Square-ground Chain: 75CJ, 75CJX, 75CK, 75CKX, 75CL, 75CLX
3/8" 90 Series	Round-ground Chain: 91VS MultiCut™ Chain: M91VS		
.404"		Round-ground Chain: 26, 26P, 58J, 58L  Square-ground Chain: 58CJ, 58CL	Round-ground Chain: 27, 27A, 27P, 59J, 59L  Ripping Chain: 27R, 27RA Square-ground Chain: 59CJ, 59CK, 59CL

This Saw Chain Classification Chart supersedes and replaces all previous Oregon® Saw Chain classification charts and posters. Effective September 1, 2004.

# Chainsaw Safety

## WHAT IS KICKBACK?

Kickback is the violent backward and/or upward motion of the chainsaw guide bar occurring when the chain near the nose or tip of the guide bar contacts any object, such as another log or branch, or when the wood closes in and pinches the saw chain in the cut.

### **BE AWARE OF KICKBACK**

1. Be alert at all times to guard against a possible kickback reaction. Always be aware of the position of your bar's nose.

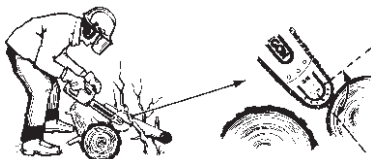

### **POTENTIAL KICKBACK SITUATION**

2. Different models of cutting chain are available for most cutting tasks. Use the chain suitable for your type of cutting, with the lowest kickback potential.
3. Narrow-nose bars, such as Oregon® Double Guard® bars, are recommended for maximum kickback safety.

## WEAR PROPER CLOTHING AND PROTECTIVE EQUIPMENT

Wear safety goggles or face shield to protect eyes.

Wear hard hat to protect head.

Wear gloves to prevent slippage and to protect hands.

Wear ear muffs or plugs to protect ears.

Wear heavy boots to protect legs and feet.

Wear protective chaps to protect legs.



### **NOTE**

Dress properly – do not wear clothing that is too tight or too loose.

# Chainsaw Safety, (Continued)

## MAKE PROPER WORK PRACTICES A HABIT

---

△ Use only a right-handed grip to hold your saw (right hand on the trigger, left hand on the front handle).

△ Keep your left arm straight for better control.

△ Hold saw firmly with both hands. Keep thumb firmly locked under front handle.

△ Stand to the side of the chainsaw, never behind it.

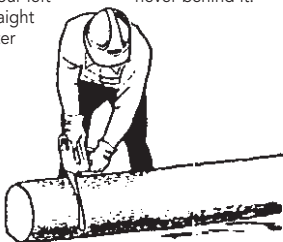

△ Run engine at full throttle.

△ Use low-kickback saw chain and a reduced-kickback guide bar.

△ Keep the chainsaw, cutting chain, guide bar, and sprocket properly maintained.

△ Stand with feet well braced and your body balanced.

△ Cut only wood with your chainsaw. Do not cut any other material.

## CAUTION

---

- △ Keep yourself clear of the work. Before cutting:
  - Calculate how the object being cut will fall.
  - Determine if the saw may be pinched during the cut.
  - Calculate whether the saw may be thrown unexpectedly by the movement of the cut material.
  - Position yourself to avoid injury.
- △ Never cut above shoulder level.
- △ Never cut while in a tree, or while on a ladder.
- △ Keep others away from the cutting area. Do not allow others to hold wood during cutting.

## FOR ADDITIONAL COPIES OF THIS MANUAL

Contact:

Oregon Cutting Systems Division, Blount, Inc.

Attention: Dept. 18A

4909 S.E. International Way

P.O. Box 22127

Portland, OR 97269-2127 U.S.A. (503) 653-4706

[www.oregonchain.com](http://www.oregonchain.com)

# Introduction/Contents

Your chainsaw is only as good as your chain, guide bar, and sprocket. They function as a team while cutting wood and must be maintained as a team.

A properly maintained chain, bar, and sprocket will provide excellent cutting performance. An improperly maintained chain will cause damage to the bar and sprocket, will cut poorly, and will create potential safety hazards.

This manual addresses the maintenance of only Oregon® manufactured chains, bars, and sprockets. For information on maintenance and operation of your saw, refer to your saw's operator's manual or contact your local chainsaw dealer.

## **SYMBOLS**

End Use Symbols . . . . .	2
Five Oregon® Symbols for Periodic Maintenance . . .	3

## **CHAIN**

Chain Terms . . . . .	4, 5
Chain Pitch . . . . .	4
Chain Gauge . . . . .	4
Parts of a Cutter . . . . .	4
Cutter Sequence . . . . .	4
Parts of a Saw Chain . . . .	5
Maintenance Terms . . . . .	5
Chain Maintenance Tools .6-8	
Filing & Repair Tools . . . .	6
Grinders & Grease Guns .7	
Grinding Wheels . . . . .	8
Chain Identification (ID) .9-11	
Drive-link Number ID . . . .	12
Chain Letter ID . . . . .	13-14
Four Basic Rules . . . . .	15-16
Chain Maintenance . . . . .	17
Chain Tension . . . . .	18-21
Chain Lubrication . . . . .	21
Sharpening Chain . . . . .	22-26
Setting Depth Gauges .26-30	
Installing Chain Parts . .30-31	
Breaking out Rivets . . . . .	32-33
Breaking in a Chain . . . . .	34
Filing Specifications . . .35-63	
Square Ground Filing . .64-66	
Chain Troubleshooting .67-73	

## **GUIDE BARS**

How Bar P/N's Work . . .74-75	
Guide-bar Terms . . . . .	76
Bar Maintenance Tools . . .76	
Intenz® Bars . . . . .	77
Bar Maintenance . . . . .	78-79
Power Match® Noses . . .80-81	
Nose Sprockets: Pro-Lite® & Micro-Lite® Pro Bars .82-83	
Bar Troubleshooting . . .84-87	

## **DRIVE SPROCKETS**

Terms and Tools . . . . .	88
Rim sprockets with Wear-depth Indicators . . . .	89
Installing Sprockets . . . . .	89
Sprocket Maintenance . . . . .	90-91
Sprocket Troubleshooting . . . . .	92-93

## **HOW A CUTTER WORKS .94**

## **HOW TO ORDER REPLACEMENT CHAIN . . .95**

## **CUTTING IN COLD WEATHER . . . . .96**

## **WARRANTY . . . . .97**

## **ANSI CHAIN CHART . . .Inside Back Cover**

## The Four Oregon® End-Use Symbols

Each of these four symbols represents a generalized category of chain saw use. Oregon® chains are listed in this manual under one or more of these symbols, generally indicating the type of use for which the product is intended.

### PROFESSIONAL CHAINSAW USE



- Big-timber loggers
- Pulpwood loggers
- Forest firefighters

### COMMERCIAL CHAINSAW USE



- Arborists
- Orchardists
- Utility and construction workers
- Tree Surgeons
- Farmers
- Commercial thinners
- Commercial firewood cutters
- Landscapers

### CONSUMER CHAINSAW USE



- Homeowners
- Occasional firewood cutters
- Campers
- Hunters

### MECHANICAL HARVESTER USE



- For use on mechanical timber-harvesting and processing equipment.

Do not use harvester attachments on hand-held saws.

#### NOTE

Harvester chains are listed in this manual for reference. For more information on other harvester products, see the Oregon® Harvester Application Guide or the Oregon® Harvester Handbook.

# The Five Oregon® Symbols for Periodic Maintenance

3

To keep your cutting system of chain, bar, and sprocket working at peak efficiency - and to minimize wear - there are a number of things every user should do periodically. There are specific maintenance tasks that should be performed and there are more general "common-sense" things to do, some of which need to occur with greater frequency, some with lesser frequency. And there are some things you should never do.

To help you know what to do and how often, Oregon® uses five symbols that tell the frequency at which each of the different activities should occur. Here are the five symbols, what they mean, and an example of a task or activity that corresponds to each.

## EXAMPLES OF SYMBOL USE

Symbol	Its Meaning	Example task or activity
▲	Before each use	Be sure your saw's oil reservoir is filled with clean bar-and-chain oil.
■	Often (hourly, or at each refueling)	Check your chain's tension and adjust it if necessary.
●	Daily	Check you drive sprocket for wear and replace it if necessary.
◆	Weekly (periodically)	Check your bar's rails to be sure they are square and free from excessive wear, repair or replace if needed.
⊘	Never	Never allow your chain to contact dirt or rocks during operation.

These five symbols appear throughout this manual, and on other Oregon® product packaging. Oregon® urges you to become familiar with these symbols, and to perform the tasks they refer to, so that you can enjoy maximum performance and maximum life from your Oregon® chain, bar, and sprocket.

# 4 Saw Chain

## OREGON® CHAIN TERMS

### CHAIN PITCH

Chain pitch is the distance between any three consecutive rivets, divided by two.

Oregon® chain pitches are:

1/4," .325," 3/8," .404," and 3/4."

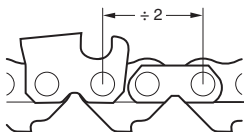

### CHAIN GAUGE

Chain gauge is the drive link's thickness where it fits into the guide-bar groove. The industry standard for gauges is: .043," .050," .058" and .063." Oregon® chain gauges of .063," .080" and .122" are used for Harvester applications.

### THE PARTS OF A CUTTER

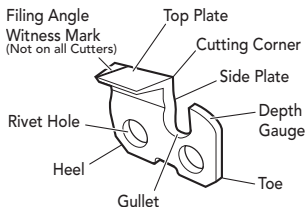

Wide-track depth gauge with Filing Witness Mark

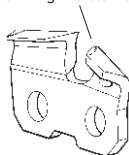

Vanguard Cutter

### CHAIN CUTTER-SEQUENCE TERMS

Standard



Semi-Skip



Skip  
(Full Skip)



CONTINUED...



## OREGON® CHAIN TERMS (CONTINUED)

## THE PARTS OF A SAW CHAIN

**NOTE** Parts below named in **Bold Face** indicate kick-back-reducing links and features: bumper tie straps, bumper drive links, and ramped depth gauges.

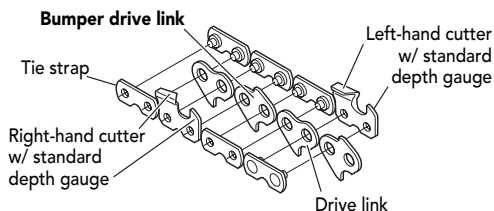
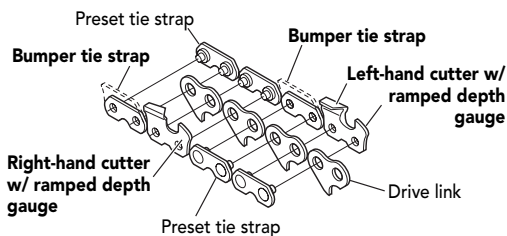

## CUTTER MAINTENANCE TERMS

DEPTH-GAUGE SETTING



TOP-PLATE FILING ANGLE

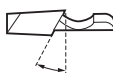

TOP-PLATE CUTTING ANGLE



SIDE-PLATE ANGLE



FILE-GUIDE ANGLES

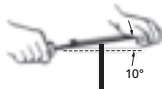

# 6 Saw Chain

## OREGON® CHAIN-MAINTENANCE TOOLS

### FILING TOOLS

- ① ASSEMBLED FILE GUIDE  
\*Asst'd. P/N's



- ② SHARPENING KITS  
\*Asst'd. P/N's

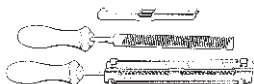

- ③ ROUND FILE  
\*Asst'd. P/N's



- ④ FLAT FILE  
P/N 12211



- ⑤ DEPTH-GAUGE TOOLS  
\*Asst'd. P/N's

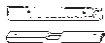

- ⑥ BAR-MOUNT FILING GUIDE  
P/N 23736A

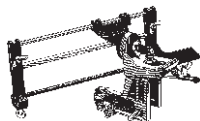

- ⑦ FILE HANDLE  
P/N 30870B (100 CT.)



\*See pages 35-63 for part numbers, file sizes, and other help selecting the right tools for your Oregon® chain.

### CHAIN-REPAIR TOOLS

- ① CHAIN BREAKER  
P/N 24548A



- ② RIVET SPINNER  
P/N 24549-s (SAE)  
P/N 24549-si (Metric)

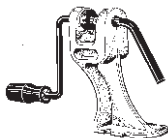

- ③ CHAIN BREAKER ANVIL  
P/N 111939



## OREGON® CHAIN-MAINTENANCE TOOLS

### GRINDERS

- ① SURE SHARP®  
12-VOLT  
GRINDER  
P/N 28588



- ② BENCH-MODEL  
CHAIN GRINDER  
P/N 511A



- ③ GRINDING WHEELS  
FOR 511A GRINDER  
\*Asst'd. P/N's  
See page 8



- ④ MINI GRINDER  
P/N 108181



- ⑤ BAR-MOUNTED  
CHAIN GRINDER  
P/N 109178 (12 V)  
P/N 109176 (115 V)

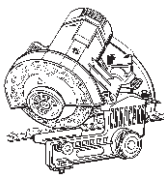

- ⑥ GRINDING WHEELS  
FOR MINI GRINDER  
& BAR-MOUNTED  
GRINDERS  
\*Asst'd. P/N's  
See page 8



### GREASE GUNS

- ① GREASE GUN  
P/N's 110534

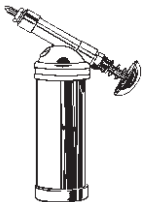

- ② GREASE GUN  
40469-A)





- ③ GREASE GUN  
21939





# 8 Saw Chain

## 511-A GRINDER WHEELS

GRINDING WHEEL PART NUMBER	GRINDING WHEEL WIDTH	CORRESPONDS TO FILE SIZE DIAMETER(S)
		
OR534-18 OR534-316 OR534-516	1/8" 3/16" 5/16"	5/32" or 4.5mm 3/16" or 7/32" 5/16"

## MINI GRINDER AND BAR-MOUNTED CHAIN GRINDER WHEELS

GRINDING WHEEL PART NUMBER	GRINDING WHEEL WIDTH	CORRESPONDS TO FILE SIZE DIAMETER(S)
		
OR4125-18 OR4125-316	1/8" 3/16"	5/32" or 4.5mm 3/16" or 7/32"



















## CHAIN IDENTIFICATION

OREGON® CHAIN PART NUMBER	FILING SPEC'S	OREGON® CHAIN TYPE	CHAIN GAUGE	CUTTER TYPE		CUTTER SEQUENCE	KICKBACK- REDUCING FEATURES (IF ANY)*
				END VIEW	SIDE VIEW		







## 1/4" – PITCH CHAIN

25AP	PAGE	MICRO CHISEL®	.050"	MICRO CHISEL®		STANDARD	
	35						

## .325" – PITCH CHAIN

20BP 21BP 22BP	PAGE	MICRO CHISEL®	.050" .058" .063"	MICRO CHISEL®		STANDARD	
	36						
20LP, M20LP 21LP, M21LP 22LP, M22LP	PAGE	SUPER 20	.050" .058" .063"	CHISEL		STANDARD	
	37						
33LG 34LG 35LG	PAGE	SUPER GUARD®	.050" .058" .063"	CHISEL		STANDARD	
	38						
33SL 34SL 35SL	PAGE	PRO GUARD™	.050" .058" .063"	CHISEL		STANDARD	
	39						
95VP	PAGE	MICRO LITE™	.050"	MICRO CHISEL®		STANDARD	
	40						
95R	PAGE	RIPPING CHAIN	.050"	MICRO CHISEL®		STANDARD	
	41						

## 3/8" – PITCH CHAIN (CONTINUED ON NEXT PAGE)















72CJ, CJX, CK, CKX, CL, CLX 75CJ, CJX, CK, CKX, CL, CLX	PAGE	SUPER GUARD® SQUARE GROUND	.050" .063"	CHISEL		(CJ, CJX) SKIP (CK, CKX) SEMI-SKIP (CL, CLX) STANDARD	
	48						
72AP, DP 73DP 75DP	PAGE	S-70	.050" .058" .063"	SEMI CHISEL		(AP) SKIP (DP) ST'D.	
	43						

## \*KICKBACK REDUCING FEATURES

① BUMPER  
DRIVE LINK④ LOW-PROFILE  
RAMPED DEPTH  
GAUGE② BUMPER  
TIE STRAP⑤ WIDE-TRACK  
RAMPED  
DEPTH GAUGE③ RAMPED  
DEPTH  
GAUGE⑥ HIGH TOP-  
PLATE TAIL  
LOCATION

# 10 Saw Chain

## CHAIN IDENTIFICATION (CONTINUED)

OREGON® CHAIN PART NUMBER	FILING SPEC'S	OREGON® CHAIN TYPE	CHAIN GAUGE	CUTTER TYPE		CUTTER SEQUENCE	KICKBACK- REDUCING FEATURES (IF ANY)
				END VIEW	SIDE VIEW		
72DG,DJ 73DG 75DG	PAGE <b>44</b>	SPEED GUARD™	.050" .058" .063"	SEMI-CHISEL		(DG) ST'D. (DJ) SKIP	
72JG,LG 73JG,LG 75JG,LG	PAGE <b>45</b>	SUPER GUARD®	.050" .058" .063"	CHISEL		(JG) SKIP (LG) ST'D.	
72JP,LP,M72LP 73JP,LP,M73LP 75LP,M75LP	PAGE <b>46</b>	SUPER 70	.050" .058" .063"	CHISEL		(JP) SKIP (LP) ST'D.	
72RD 73RD 75RD	PAGE <b>49</b>	RIPPING CHAIN	.050" .058" .063"	SEMI-CHISEL		STANDARD	
72SG 73SG 75SG	PAGE <b>47</b>	XTRA GUARD®	.050" .058" .063"	SEMI-CHISEL		STANDARD	
72V 73V 75V	PAGE <b>42</b>	VAN- GUARD	.050" .058" .063"	CHISEL		STANDARD	 
90SG	PAGE <b>50</b>	MICRO- LITE™	.043"	CHAMFER CHISEL		(SG) ST'D.	 
91P	PAGE <b>51</b>	XTRA GUARD®	.050"	CHAMFER CHISEL		STANDARD	 
91VS, M91VS	PAGE <b>52</b>	LOW VIBRATION LOW PROFILE	.050"	CHAMFER CHISEL		STANDARD	
91VG	PAGE <b>53</b>	LOW VIBRATION XTRA GUARD®	.050"	CHAMFER CHISEL		STANDARD	 
91LX	**	POWER SHARP®	.050"	SPECIALIZED		STANDARD	 

\*\*Use 91LX ONLY on saws with automatic chain-sharpening systems. No hand maintenance required.

## CHAIN IDENTIFICATION (CONTINUED)

OREGON® CHAIN PART NUMBER	FILING SPEC'S	OREGON® CHAIN TYPE	CHAIN GAUGE	CUTTER TYPE		CUTTER SEQUENCE	KICKBACK- REDUCING FEATURES (IF ANY)
				END VIEW	SIDE VIEW		

### .404" – PITCH CHAIN

16H 18H	PAGE <b>61</b>	HAR- VESTER	.063" .080"	MICRO CHISEL®		STANDARD	
26, 26P 27, 27A 27P	PAGE <b>54</b>	MICRO CHISEL®	.058" .063"	MICRO CHISEL®		STANDARD (A) SKIP	26P, 27P  26, 27, 27A 
27R 27RA	PAGE <b>55</b>	RIPPING CHAIN	.063"	MICRO CHISEL®		(R) ST'D. (RA) SKIP	
50AJ,AL 51AJ,AL 52AJ, AK,AL	PAGE <b>59</b>	SUPER CHISEL™ SQUARE GROUND	.050" .058" .063"	CHISEL		(AJ) SKIP (AK) SEMI (AL) ST'D.	
50L 51L 52L	PAGE <b>56</b>	SUPER CHISEL™	.050" .058" .063"	CHISEL		STANDARD	
58CJ, CL 59CJ, CK, CL	PAGE <b>59</b>	SUPER GUARD® GROUND	.058" .063" SQUARE	CHISEL		(JG) SKIP (LG) ST'D.	
58CP 59CP	PAGE <b>57</b>	MICRO BIT®	.058" .063"	CHIPPER		STANDARD	
58J, 58L 58LG 59J, 59L 59JG, LG	PAGE <b>58</b>	SUPER GUARD®	.058" .063"	CHISEL		(JG) SKIP (LG) ST'D.	
59AA	PAGE <b>60</b>	CHIPPER CUTTER	.063"	CHIPPER		SKIP	

### 3/4" – PITCH CHAINS

11BC	PAGE <b>62</b>	CHIPPER	.122"	CHIPPER		STANDARD	
11H	PAGE <b>63</b>	SEMI CHISEL	.122"	SEMI-CHISEL		STANDARD	

# 12 Saw Chain



## CHAIN DRIVE-LINK NUMBER IDENTIFICATION

Nearly all Oregon® chains are named by a part number made up of a number (see below), and letters (see pages 13-14).

Oregon® Part-number Examples: 27A, 72LP, 91VG, M72LP

First, note the numbers: 27A, 72LP, 91VG, M72LP

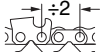
These numbers are stamped on the chain's drive links and indicate the physical size of the chain (pitch and gauge).

		
CHAIN NUMBER	PITCH	GAUGE
11	3/4"	.122"
16	.404"	.063"
18	.404"	.080"
20	.325"	.050"
21	.325"	.058"
22	.325"	.063"
25	1/4"	.050"
27	.404"	.063"
33	.325"	.050"
34	.325"	.058"
35	.325"	.063"
50	.404"	.050"
51	.404"	.058"
52	.404"	.063"
58	.404"	.058"
59	.404"	.063"
72	3/8"	.050"
73	3/8"	.058"
75	3/8"	.063"
90	3/8" Low Profile	.043"
91	3/8" Low Profile	.050"
95	.325"	.050"



## CHAIN LETTER IDENTIFICATION

The Letters: 27 **A**, 72 **LP**, 91 **VG**, **M** 72 **LP**

The letters represent cutter type and sequence, kick-back-reducing features, or other physical traits of the chain.

- |   |  |
|---|--|
| <b>A</b> Micro Chisel® cutters with skip sequence (27A only)  | <b>CK</b> Square-ground chisel cutters with ramped depth gauges and semi-skip                    |
| <b>AA</b> Chipper cutters with skip sequence (59AA only)  | <b>CKX</b> Square-ground DuraPro™ chisel cutters with ramped depth gauges and semi-skip sequence |
| <b>AJ</b> Square-ground chisel cutters with skip sequence   | <b>CL</b> Square-ground chisel cutters with ramped depth gauges and standard sequence            |
| <b>AK</b> Square-ground chisel cutters with semi-skip sequence  | <b>CLX</b> Square-ground DuraPro™ chisel cutters with ramped depth gauges and standard sequence  |
| <b>AL</b> Square-ground chisel cutters with standard sequence   | <b>CP</b> Chipper cutters with bumper drive links and standard sequence                          |
| <b>AP</b> 25AP: Micro Chisel® cutters with bumper drive links and standard sequence. 72AP: Semi-chisel cutters with skip sequence | <b>DG</b> Semi-chisel cutters with ramped depth gauges and standard sequence                     |
| <b>BC</b> Chipper cutters with standard sequence (11BC only)  | <b>DJ</b> Semi-chisel cutters with ramped depth gauges and skip sequence (72DJ only)             |
| <b>BP</b> Low-vibration Micro Chisel® cutters with bumper drive links and standard sequence                                       | <b>DP</b> Semi-chisel cutters with bumper drive links and standard sequence                      |
| <b>CJ</b> Square-ground chisel cutters with ramped depth gauges and skip sequence   | <b>H</b> Modified for harvester applications, Micro Chisel® cutters with standard sequence       |
| <b>CJX</b> Square-ground DuraPro™ chisel cutters with ramped depth gauges and skip sequence                                       |  |

CONTINUED...

# 14 Saw Chain

## CHAIN LETTER IDENTIFICATION (CONTINUED)

- JG** Round-ground chisel cutters with ramped depth gauges, bumper tie straps and skip sequence
- JP** Round-ground chisel cutters with bumper drive links and skip sequence
- L** Chisel cutters with standard sequence
- LG** Round-ground chisel cutters with ramped depth gauges and standard sequence (33LG is a low vibration chain)
- LP** Low-vibration, round-ground chisel cutters with bumper drive links and standard sequence
- LX** Power Sharp® chain with ramped depth gauges, bumper drive links and standard sequence (no hand maintenance required)
- M** Specially built chain with round-ground chisel cutters and bumper drive links for effective cutting in extremely dirty or abrasive conditions
- P** Micro Chisel® cutters (26P, 27P), or Chamfer Chisel cutters (91P), with bumper drive links and standard sequence
- R** Ripping chain with Micro Chisel® cutters and standard sequence
- RA** Ripping chain with Micro Chisel® cutters and skip sequence (27RA only)
- RD** Ripping chain with semi-chisel cutters and standard sequence (3/8"-pitch only)
- SG** Ramped depth gauges, bumper tie straps and standard sequence (72, 73, 75SG have semi-chisel cutters. 90SG has low-vibration chamfer-chisel cutters)
- SL** Round-ground chisel cutters with ramped depth gauges, bumper tie straps and standard sequence (33SL is a low vibration chain)
- V** Low-vibration, round-ground Vanguard chisel cutters with standard sequence and wide-track depth gauges
- VG** Low-vibration semi-chisel cutters with ramped depth gauges, bumper tie straps and standard sequence
- VP** Low-vibration Micro Chisel® cutters with ramped depth gauges, bumper drive links and narrow-kerf design (95VP only)
- VS** Low-vibration semi-chisel cutters with ramped depth gauges and standard sequence (91VS only)

## THE FOUR BASIC SAW-CHAIN RULES

### ATTENTION CHAINSAW USERS:

Oregon® urges you to become familiar with the four basic saw-chain rules. Users who know and follow these rules can count on superior performance from their chain, bar, and sprocket – and – reduce safety hazards at the same time.

### RULE NUMBER 1

#### YOUR CHAIN MUST BE CORRECTLY TENSIONED



More chain and bar problems are caused by incorrect chain tension than by any other single factor. See pages 18-21 on how to tension your chain.

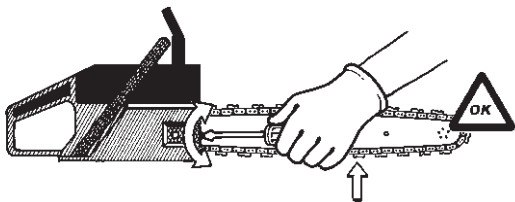

### RULE NUMBER 2

#### YOUR CHAIN MUST BE WELL LUBRICATED

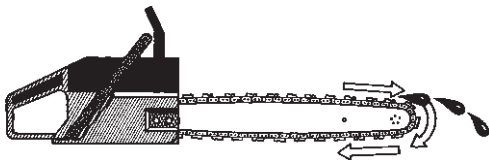

A constant supply of oil to your saw's bar, chain, and sprocket is vital. Without it, excessive friction, wear, and damage will occur. See page 21 for instructions on how to lubricate your chain.

CONTINUED...

# 16 Saw Chain

## RULE NUMBER 3

**YOUR CHAIN MUST BE SHARP**

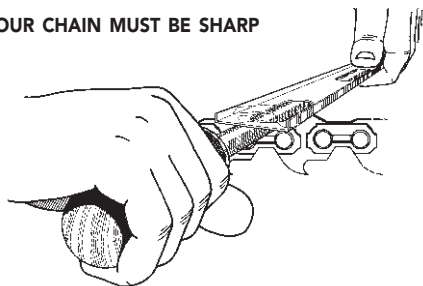

When your chain is sharp, it does the work. When it's not, you do the work – and your cutting attachments will wear more rapidly. See pages 22-26 for instructions on how to sharpen your chain. See pages 35-63 to find maintenance specifications for each Oregon® chain type.

## RULE NUMBER 4

**YOUR CHAIN'S DEPTH GAUGES MUST BE SET CORRECTLY**

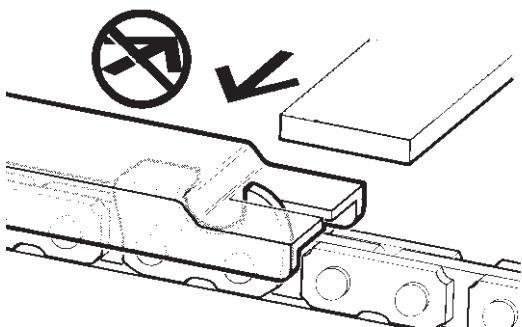

Depth-gauge setting and depth-gauge shape are critical to performance and safety. See pages 26-30 for instructions on how to set your chain's depth gauges.

**NOTE** See specific depth gauge maintenance for 72V, 73V and 75V Vanguard chains on pages 29-30.

## HOW TO MAINTAIN CHAIN

**ATTENTION:** Oregon® urges dealers, chainsaw users, and anyone who services saw chain to become familiar with proper chain-maintenance techniques and the possible dangers which can result if chain is not properly maintained.

### **WARNING**

Failure to follow the instructions below can result in severe injury to the saw operator, bystanders, or the person performing maintenance.

△ Always turn off your saw's engine before handling the chain, guide bar or sprocket.

△ Any one of the following conditions can increase a chain's potential kickback energy, increase the risk of a chain throwing itself off the bar, increase the chance of a chain breaking, or increase the risk of other hazards associated with chainsaw use.

- △ Loose chain tension
- △ Incorrect sharpening of chain angles
- △ Dull chain
- △ Alteration of kickback-reducing chain features
- △ Excessive chain depth-gauge settings
- △ Incorrect chain depth-gauge shapes
- △ Incorrectly installed chain parts
- △ Loose rivets, or cracks or breaks in any chain component

△ When performing maintenance on saw chain, follow **all** instructions provided with the chain, or on the page in this manual pertaining to your chain. Doing so can minimize the risk of injury.

# 18 Saw Chain

## HOW TO TENSION YOUR CHAIN

### Basic Chain-Tensioning Tasks

▲ Before use   ■ Often   ● Daily   ◆ Weekly   ⊘ Never

- ▲ Tension chain before each use
- Tension chain often, or at each refueling
- ⊘ Never tension your chain right after cutting. Chain tensioned while hot can cool and shrink, causing tension to be too tight. Let chain cool first.

**⚠ READ THE WARNING ON PAGE 17.**

**NOTE** Always wear protective gloves.



1. Turn the engine off.

2. Loosen bar-mounting nuts on the side of your saw.

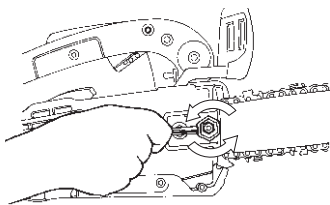

3. Adjust tension as follows:

If you have a **solid-nose bar**, follow 3a (below).

If you have a **sprocket-nose bar**, follow 3b (on next page). If you have an **Intenz™ bar** with the internal tensioning feature, follow 3c (page 20).

### 3a. IF YOU HAVE A SOLID-NOSE BAR

Pull the bar nose up, and keep it up as you adjust tension.



CONTINUED

## HOW TO TENSION YOUR CHAIN

(3a CONTINUED)

Turn your saw's tension-adjustment screw until the bottoms of the lowest tie straps and cutters come up and **just** touch the bottom of the bar rail.

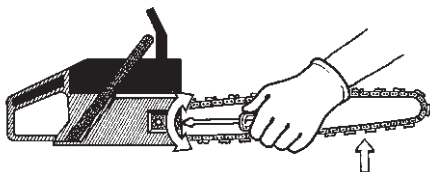

While still holding the nose up, tighten your saw's rear bar-mounting nut first, then tighten the front mounting nut.

### **3b. IF YOU HAVE A STANDARD SPROCKET-NOSE BAR**

Pull the bar nose up, and keep it up as you adjust tension.

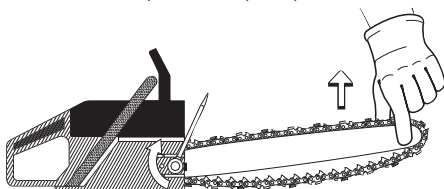

Tension must be tighter on a sprocket-nose bar than on a solid-nose bar. Turn your saw's tension-adjustment screw until the bottoms of the lowest tie straps and cutters come up and **solidly contact the bottom of the bar rail**. Then add an additional 1/4 turn of the adjustment screw.

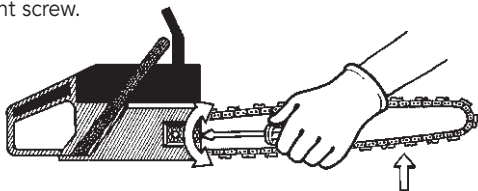

While still holding the nose up, tighten your saw's rear bar-mounting nut first, then tighten the front mounting nut.

CONTINUED

## 20 | Saw Chain

### HOW TO TENSION YOUR CHAIN (CONTINUED)

#### 3c. IF YOU HAVE AN INTENZ® SPROCKET-NOSE BAR

Turn the tension-adjust slot until the bottoms of the lowest cutters and tie straps come up and **solidly** contact the bottom of the bar rail.

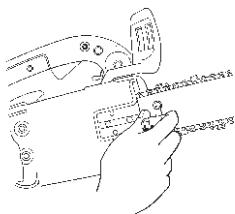

Tighten your saw's rear bar-mounting nut first, then tighten the front mounting nut. **It is not necessary to hold the nose up when adjusting tension on Intenz® bars.**

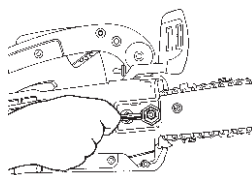

**NOTE** When replacing a standard bar with an Intenz® bar, the saw's adjustment pin must be removed. Contact your dealer if you need help.

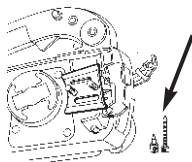
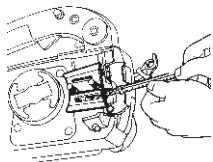

4.  Pull the chain by hand along the top of the bar several times, from the engine to the bar's tip. Chain should feel snug but still pull freely.

**NOTE** If you have a sprocket-nose bar you should now perform the snap test. Grasp the chain along the bottom of the bar, pull down, and let go. Chain should snap back to its original position, solidly contacting the bottom of the bar.

Continued...



5. Check tension often during operation, especially during the first half-hour. If chain loosens: stop, let chain cool, and readjust tension.

## HOW TO LUBRICATE YOUR CHAIN

### Basic Lubrication Tasks

▲ Before use   ■ Often   ● Daily   ◆ Weekly   ⊘ Never

- ▲ Each time you fill your gas tank, fill your oil reservoir with clean bar-and-chain oil.

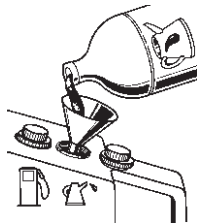

- Be sure your chain, bar, and sprocket are always receiving oil from the saw during operation.

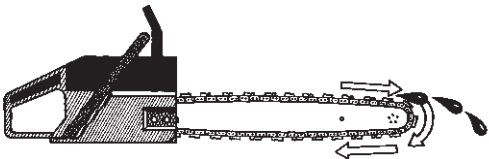

- ⊘ Never put used oil, or old motor oil, in your saw or on your chain.

- ▲ Before the first use, soak the chain overnight to allow oil to penetrate all chain components.

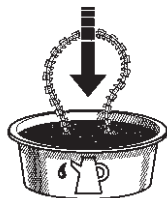

# 22 | Saw Chain

## HOW TO SHARPEN CHAIN

### Basic Sharpening Tasks

▲ Before use   ■ Often   ● Daily   ◆ Weekly   ⊘ Never

- ▲ Sharpen chain before each use.
- Sharpen chain often, or as needed.

**⚠ READ THE WARNING ON PAGE 17.**

### NOTES

- Sharpening your chain while it is on the saw requires proper chain tension, as shown on pages 18-21 prior to filing.
- Pages 35-63 show the correct maintenance specifications and the correct maintenance-tool part numbers for each of the Oregon® chain types. Find the page which gives the correct filing specifications for your Oregon® chain. To do so, use the Chain Identification chart on pages 9-11.
- If unsure of your Oregon® chain's type, or part number, ask your Oregon® saw chain dealer, or call the Oregon® technical services department at 503-653-4706 between the hours of 7:30 am and 4:00 pm, Pacific time, Monday through Friday.

### BEFORE & AFTER SHARPENING YOUR CHAIN

1. Before sharpening your chain, clean oil and grease from the chain. This will prevent build-up in your file's teeth, or on the wheel when grinding.
2. Before sharpening, inspect, repair, or replace damaged chain.
3. During your inspection, check for each of the following:
  - Proper installation of tie straps and drive links.
  - Cracked or broken cutters, cutter top plates, or tie straps.
  - Bent, cracked or burred drive links.
  - Severe abrasive damage.

CONTINUED...

- Abnormal chain wear.
- Wear patterns on the chain that may indicate a worn bar or sprocket.
- Loose rivets (if you can rotate the rivets with your fingers, they're too loose).

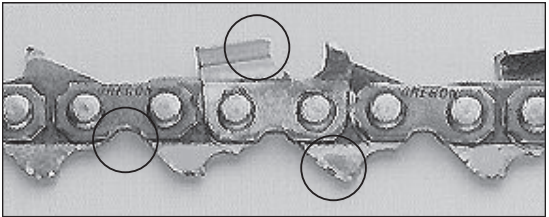

4. Use the correct sharpening specifications for your Oregon® chain type. See pages 35-63.
  - If unsure of your Oregon® chain's type, or part number, ask your Oregon® chain dealer.
  - For Sharpening Chain with a Grinder see below.
  - For Sharpening Chain with a Round File see pages 25-26.
5. After sharpening your chain, check and adjust depth gauges. See pages 26-30 for instructions.
6. After sharpening and adjusting depth gauges, clean off any particles of material, then lubricate the chain thoroughly with bar and chain oil. Soaking the chain overnight produces the best results.

## SHARPENING CHAIN WITH AN OREGON® GRINDER



**Note:** Wear safety goggles.

1. Set vise assembly to the proper **top plate filing angle** (See pages 35-63 for correct angles for each Oregon® chain type.)

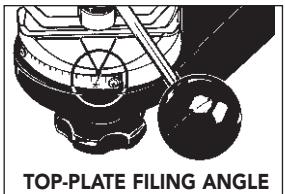

## 24 Saw Chain

2. To set the proper grinder head angle, use the recommended **top-plate cutting angle** (See pages 35-63 for correct angles for each Oregon® chain type.)

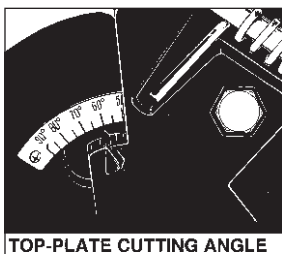
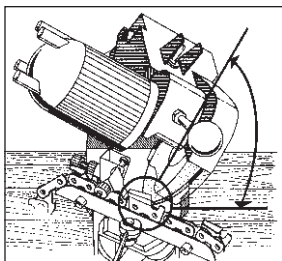

3. Dress vitrified grinding wheels often to maintain correct shape (see illustration). Use either a rotary wheel dresser or a dressing brick.

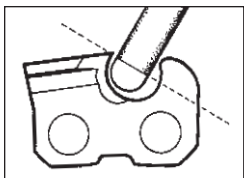

Full Radius, for all round-ground chains except 11H

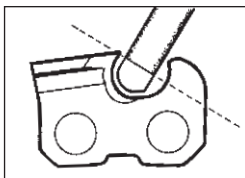

For 11H Chain Only:  
3/16" Partial Radius  
& 1/8" Flat

### NOTE:

- To avoid burning cutters, use light intermittent strokes.
- Never grind into other chain components.
- If damage is present on the chrome surface of top plates or side plates, grind back until such damage is removed.
- Keep all cutter lengths equal.

## SHARPENING WITH A ROUND FILE

1. Be sure 1/5th, or 20%, of the file's diameter is always held above the cutter's top plate. The best way to do this is with an Oregon® File Guide. The file guide automatically keeps 20% of the file's diameter above the cutter's top plate..



2. Keep the correct Top-plate Filing Angle line on your file guide parallel with your chain.

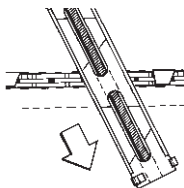

3. Sharpen cutters on one side of the chain first. File from the inside of each cutter to the outside. Then turn your saw around and repeat the process for cutters on the other side of the chain.

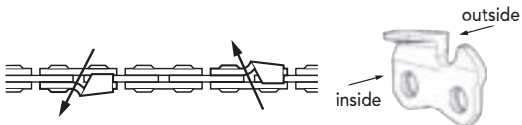

4. If damage is present on the chrome surface of top plates or side plates, file back until such damage is removed.



CONTINUED...

## 26 Saw Chain

5. Keep all cutter lengths equal.

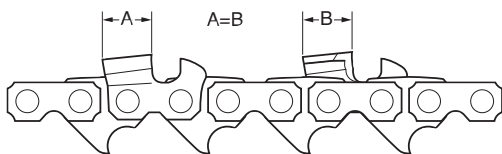

### HOW TO SET DEPTH GAUGES

#### Basic Depth-Gauge Tasks

▲ Before use   ■ Often   ● Daily   ◆ Weekly   ⊘ Never

- Set depth gauges often, every 3 or 4 sharpenings, or more often if needed.

**⚠ READ THE WARNING ON PAGE 17.**

#### NOTES

- Setting your depth gauges while the chain is on the saw requires proper chain tension, as shown on pages 18-21 prior to filing.
- Pages 35-63 show the correct depth-gauge setting and the part number of the correct depth-gauge tool for each of the different Oregon® chain types. Find the page which gives the correct filing specifications for your Oregon® chain. To do so, use the Chain Identification chart on pages 9-11.
- If unsure of your Oregon® chain's type, or part number, ask your Oregon® saw chain dealer, or call the Oregon® technical services department at 503-653-4706 between the hours of 7:30 am and 4:00 pm, Pacific time, Monday through Friday.

CONTINUED...

## HOW TO SET DEPTH GAUGES (CONTINUED)

- Most Oregon® chains have a number stamped on each depth gauge indicating the correct depth-gauge setting.

### EXAMPLE:

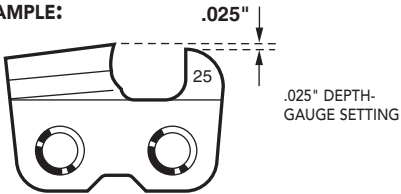

1. Use a depth-gauge tool with the correct built-in setting for your chain and check your depth gauges every 3 or 4 sharpenings or more often if needed.
2. Be sure the heel and toe of the cutter are both down, resting on the bar rail, before any filing is done. This is especially important on low-vibration chains, which have a "clipped heel" that rides above the rail slightly when the chain is properly tensioned.
3. Place the tool on top of your chain so one depth gauge protrudes through the slot in the tool.

**NOTE** Be aware that "standard" depth gauges and "wide-track Vanguard" depth gauges are set differently. See pages 29-30 for additional information on Vanguard depth gauges.

Standard depth gauge with drop-end gaugit tool.  
(Always file from the inside out.)

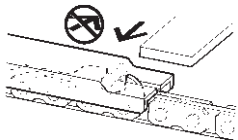

Vanguard wide-track-depth gauge with drop-center depth gauge tool.

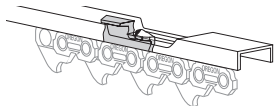

CONTINUED...

## 28 Saw Chain

### HOW TO SET DEPTH GAUGES (CONTINUED)

4. If the depth gauge extends above the slot, file the depth gauge down level with the top of the tool using a flat file. *Never file the depth gauge down so far that you exceed the depth-gauge setting specified in this manual for your Oregon® chain.*

⊘ Do not file or alter the tops of kickback-reducing bumper tie straps or bumper drive links, except on 33SL, 34SL, and 35SL chains. Only 33SL, 34SL, and 35SL require filing of the bumper tie straps. See page 39.

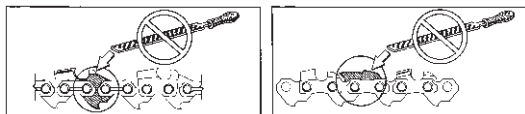

5. Rounding off depth gauges after lowering:

- The depth gauges on all non-Vanguard chains should be rounded off after they are filed down.
- Do not round off the depth gauges on Vanguard chain. See the next page for more details on setting Vanguard chain depth gauges.

After filing the depth gauge down, round off its leading edge and return the depth gauge to its original rounded or ramped shape\*\*. On chains with bumper links, it may be necessary to move the cutter to the bar's tip, or remove the chain from the bar, in order to re-shape the depth gauge.





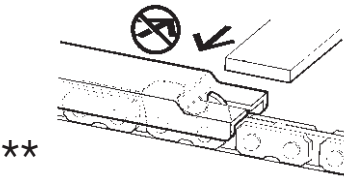

\*\*

\*\*Do not round off the depth gauges on Vanguard chain after filing them down.

**NOTE** On many chains, it may be helpful to tip the depth-gauge tool on end and place it in front of the cutting corner in order to protect the cutting surfaces when rounding off depth gauges.

## SETTING THE WIDE-TRACK DEPTH GAUGES ON VANGUARD CHAIN

Most experienced timber cutters know that if their newly-sharpened chain fails to cut, then the next step is to check and probably lower the depth gauges. With other Oregon® chains, there is normally sufficient margin for error that a chain with depth gauges set slightly too low will still cut well. However, with Vanguard chain, cutting performance does not improve with depth-gauge settings greater than .025". If your Vanguard depth gauges are set too low, the cutter top plates must be filed back to regain the .025" setting in order to obtain optimum cutting performance. Here are some additional points to remember when setting Vanguard depth gauges:

1. Use a .025" drop-center depth-gauge tool and follow instructions number 1 through 4 on pages 27-28.
2. Vanguard is a low-vibration chain. Be sure the cutter's clipped heel is down, resting on the bar rail, before doing any filing.

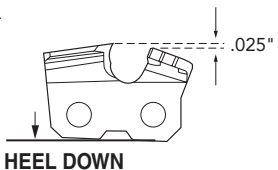

CONTINUED...

## 30 | Saw Chain

3. The area where depth-gauge filing occurs on Vanguard chain is identified by a witness mark. Do not file outside the witness mark and do not round off Vanguard depth gauges after lowering them.



3. Always file Vanguard depth gauges from the **inside out**.

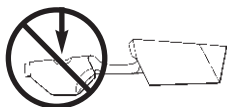

### HOW TO INSTALL NEW CHAIN PARTS

**⚠ READ THE WARNING ON PAGE 17.**

**NOTE** Use only new Oregon® parts to repair Oregon® chain. And only use parts which are the correct size and type for your chain.

1. Remove rivets, and parts to be replaced, as shown under "How to Break Out Rivets," pages 32-33. Never reassemble a chain with old preset tie straps – *always use new preset tie straps.*
2. If needed, file off the bottom of new parts to match existing worn parts. File new cutters back to match worn cutters. Do not file the tops of kickback-reducing bumper tie straps or bumper drive links (except on 33-34-35SL chains, see page 39).

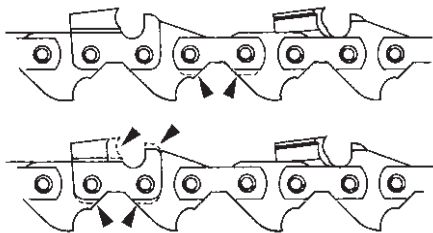

CONTINUED...

3. Place the preset tie strap on a flat outer surface of a chain-breaker anvil. Be sure the rivets are pointing up.

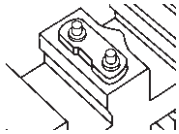

4. Assemble chain to the preset tie strap.

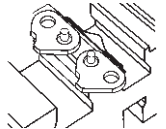

5. Assemble tie strap with dot, or Lubrilink™ contour face up, and the notch toward the drive-link tangs. Assemble bumper tie strap in the correct direction, with the notch toward the drive-link tangs.

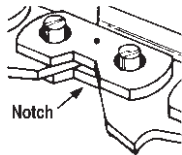

6. Be sure parts are assembled in the correct location, sequence and direction. Check the illustrations on pages 4 and 5. If unsure, ask your Oregon® dealer.

7. To form rivet heads, we recommend use of the Oregon® Rivet Spinner, part number 24549A, available from your chainsaw dealer. Follow the instructions packaged with the rivet spinner. If you must use a hammer, strike the rivet head repeatedly with the hammer's flat end at varying angles around the head – carefully forming it as shown. Be certain to strike only the rivet head.

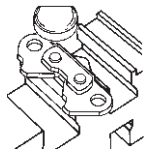

## CAUTION

△ Rivet heads must be snug and secure while still allowing all joined parts to move freely. Rapid wear leading to possible chain breakage and personal injury can be caused by rivet heads that are either too tight, or too loose.

## NOTE

New rivet heads may be smaller and shaped differently than factory-spun heads.

# 32 Saw Chain

## HOW TO BREAK OUT RIVETS

### CAUTION

△ Always wear approved safety accessories for hands and face when breaking out rivets.



1. Place the chain segment you wish to break in the correct slot of the anvil, according to pitch.

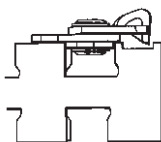

**NOTE** For Vanguard chain cutters with wide-track depth gauges, be sure that the depth gauge curls downward, into the recessed area of the anvil.

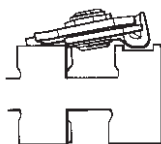

2. Position rivet head directly under the punch. Pull the handle down just far enough to push out the rivet, or hammer out the rivet if you're using a hand-held punch. Do not use excessive force. To avoid tight joints, replace worn or broken punches periodically and be sure the punch is centered when driving out rivets.

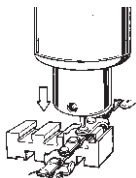
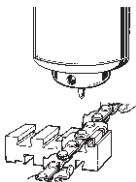

**NOTE** When breaking chain at a cutter, make sure the chain is positioned so that the drive links are between the anvil and the cutter.

CONTINUED...

## HOW TO BREAK OUT RIVETS (CONTINUED)

### REMOVING RIVETS FROM BROKEN DRIVE LINKS

1. When removing rivets from broken drive links, hold the two broken segments together in their original (unbroken) positions as you place the chain link in the anvil.

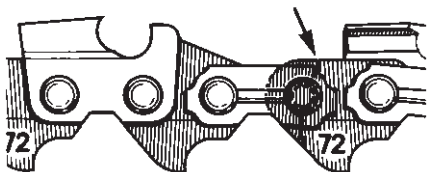
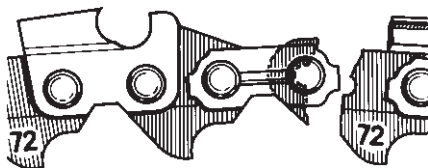

2. Perform steps 1 and 2 from "How to Break Out Rivets." on the previous page.

# 34 Saw Chain

## HOW TO BREAK IN A NEW CHAIN

### Basic Break-In Tasks

▲ Before use   ■ Often   ● Daily   ◆ Weekly   ⊘ Never

The life of your new chain can be extended by taking these few simple steps before using it.

- ▲ 1. Before the first use, soak the chain overnight to allow oil to penetrate all chain components.

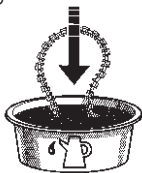

- ▲ 2. Run new chain at half throttle for several minutes before doing any cutting in order to allow oil to reach all parts of the bar and chain. Let sprocket, bar, and chain warm up fully.

- 3. Stop, let the chain cool, then check and

- ▲ adjust tension often (especially during the first half-hour of use) as shown on pages 18-21.

Keep the first several cuts light. Keep extra oil on the bar and chain during these first cuts, and do not apply heavy pressure.

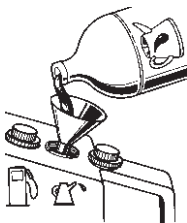



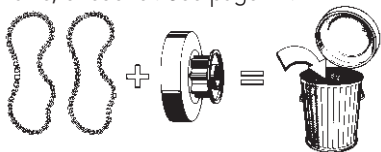

### NOTES

- ⊘ Never run any chain on an overworn drive sprocket, especially a new chain.
- ◆ Replace drive sprocket systems after every two chains, or sooner. See page 91.

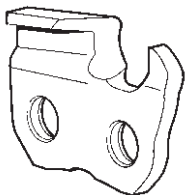

## MICRO CHISEL®



<b>Kickback Reducing Features</b> 	<b>End View</b> 	<b>Use</b> 
--	--	---

**Not a Low-kickback Chain**

<b>Chain Type</b>	<b>Gauge</b>
25AP	.050"

## FILING

① DEPTH-GAUGE SETTING

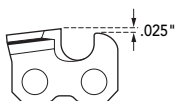

② TOP-PLATE CUTTING ANGLE

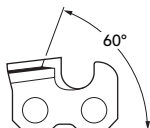

③ SIDE-PLATE ANGLE

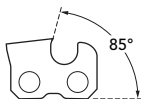

④ TOP-PLATE FILING ANGLE

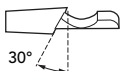

⑤ FILE-GUIDE ANGLE

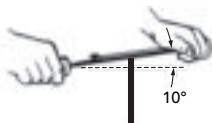

## TOOLS FOR FILING

Part No.	Description
70504	5/32" Round File (12-Pack)
37534	5/32" Assembled File Guide
22290	.025" Depth-gauge Tool
OR534-18	1/8" Grinding Wheel, 5-3/4" Dia.
OR4125-18	1/8" Grinding Wheel, 4-1/8" Dia.

Chains on this page are intended for use with saws up to 2.3 cu. in. displacement (38 cc), and bars up to 16 in. length (41 cm).

# 36 Micro Chisel® .325"

## MICRO CHISEL®

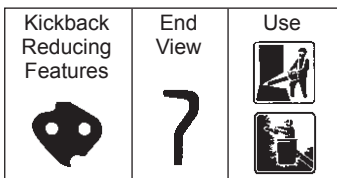
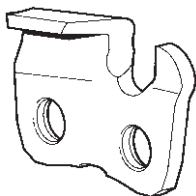

**Not a Low-kickback Chain**

**Low-vibration Chain**

Chain Type	Gauge
20BP	.050"
21BP	.058"
22BP	.063"

## FILING

① DEPTH-GAUGE SETTING

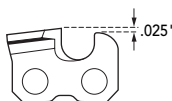

② TOP-PLATE CUTTING ANGLE

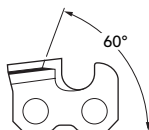

③ SIDE-PLATE ANGLE



④ TOP-PLATE FILING ANGLE



⑤ FILE-GUIDE ANGLE

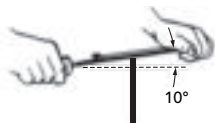

## TOOLS FOR FILING

Part No.	Description
70503	3/16" Round File (12-Pack)
31690	3/16" Assembled File Guide
31941	.025" Drop-Center Depth-gauge Tool
OR534-316	3/16" Grinding Wheel, 5-3/4" Dia.
OR4125-316	3/16" Grinding Wheel, 4-1/8" Dia.

Chains on this page are intended for use with saws up to 3.5 cu. in. displacement (58 cc), and bars up to 20 in. length (50 cm).



## CHISEL®

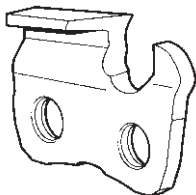

<b>Kickback Reducing Features</b> 	<b>End View</b> 	<b>Use</b> 
---------------------------------------	---------------------	----------------

**Not a Low-kickback Chain**

**Low-vibration Chain**

Chain Type	Gauge
20LP, M20LP	.050"
21LP, M21LP	.058"
22LP, M22LP	.063"

## FILING

① DEPTH-GAUGE SETTING

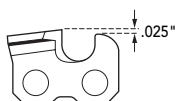

② TOP-PLATE CUTTING ANGLE

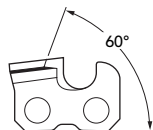

③ SIDE-PLATE ANGLE



④ TOP-PLATE FILING ANGLE

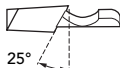

⑤ FILE-GUIDE ANGLE

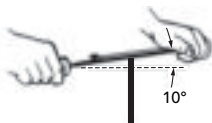

## TOOLS FOR FILING



Part No.	Description
70503	3/16" Round File (12-Pack)
31690	3/16" Assembled File Guide
31941	.025" Drop-Center Depth-gauge Tool
OR534-316	3/16" Grinding Wheel, 5-3/4" Dia.
OR4125-316	3/16" Grinding Wheel, 4-1/8" Dia.

Chains on this page are intended for use with saws up to 3.5 cu. in. displacement (58 cc), and bars up to 20 in. length (50 cm).

# 38 Super Guard® .325"

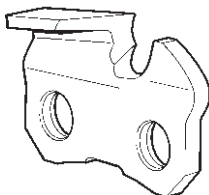
## CHISEL®



<b>Kickback Reducing Features</b> 	<b>End View</b> 	<b>Use</b> 
--	--	---

**Not a Low-kickback Chain**

**No Bumper Tie Straps**

**Low-vibration Chain**

Chain Type	Gauge
33LG	.050"
34LG	.058"
35LG	.063"

## FILING

① DEPTH-GAUGE SETTING

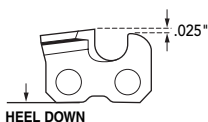

② TOP-PLATE CUTTING ANGLE

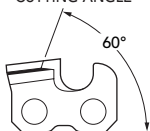

③ SIDE-PLATE ANGLE

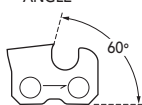

④ TOP-PLATE FILING ANGLE

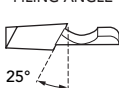

⑤ FILE-GUIDE ANGLE

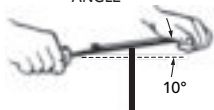

## TOOLS FOR FILING

Part No.	Description
70511	4.5 mm Round File (12-Pack)
31692	4.5 mm Assembled File Guide
31941	.025" Drop-Center Depth-gauge Tool
OR534-18	1/8" Grinding Wheel, 5-3/4" Dia.
OR4125-18	1/8" Grinding Wheel, 4-1/8" Dia.

Chains on this page are intended for use with saws up to 3.8 cu. in. displacement (62 cc), and bars up to 20 in. length (50 cm).

## CHISEL®

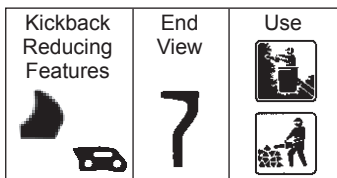
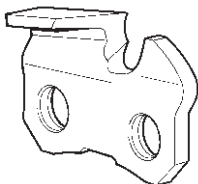

### **A Low-kickback Chain** **With Bumper Tie Straps**

Chain Type	Gauge
33SL	.050"
34SL	.058"
35SL	.063"

### **Low-vibration Chain**

## FILING

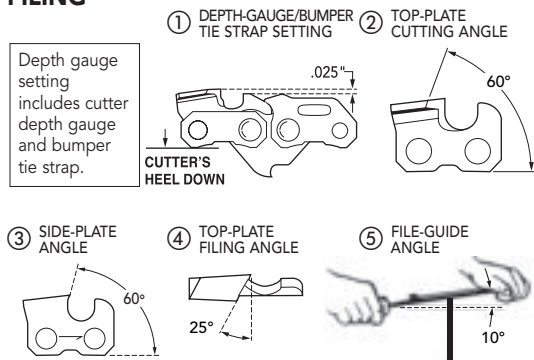





## TOOLS FOR FILING

Part No.	Description
70511	4.5 mm Round File (12-Pack)
31692	4.5 mm Assembled File Guide
31941	.025" Drop-Center Depth-gauge Tool
OR534-18	1/8" Grinding Wheel, 5-3/4" Dia.
OR4125-18	1/8" Grinding Wheel, 4-1/8" Dia.

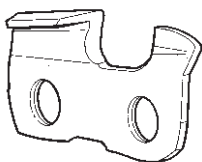
Chains on this page are intended for use with saws up to 3.5 cu. in. displacement (58 cc), and bars up to 20 in. length (50 cm).

## MICRO CHISEL®



<b>Kickback Reducing Features</b> 	<b>End View</b> 	<b>Use</b> 
--	--	---

**A Low-kickback Chain**

**Low-vibration Chain**

**Narrow-kerf Chain**

<b>Chain Type</b>	<b>Gauge</b>
95VP	.050"

## FILING

① DEPTH-GAUGE SETTING

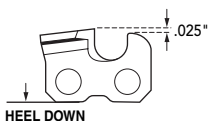

② TOP-PLATE CUTTING ANGLE

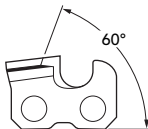

③ SIDE-PLATE ANGLE

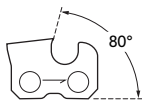

④ TOP-PLATE FILING ANGLE

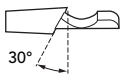

⑤ FILE-GUIDE ANGLE

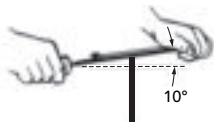

## TOOLS FOR FILING

Part No.	Description
70503	3/16" Round File (12-Pack)
31690	3/16" Assembled File Guide
31941	.025" Drop-Center Depth-gauge Tool
OR534-316	3/16" Grinding Wheel, 5-3/4" Dia.
OR4125-316	3/16" Grinding Wheel, 4-1/8" Dia.

Chains on this page are intended for use with saws up to 2.8 cu. in. displacement (45 cc), and bars up to 18 in. length (45 cm).

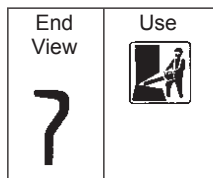
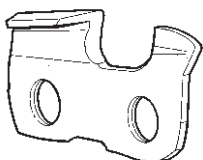
**MICRO CHISEL®**

**Not a Low-kickback Chain**

**Narrow-kerf Chain**

**Low-vibration Chain**

Chain Type	Gauge
95R (Micro-Lite™)	.050"

**FILING**

① DEPTH-GAUGE SETTING

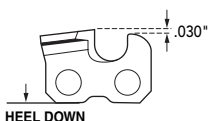

② TOP-PLATE CUTTING ANGLE

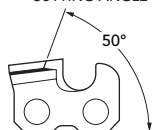

③ SIDE-PLATE ANGLE



④ TOP-PLATE FILING ANGLE

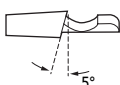

⑤ FILE-GUIDE ANGLE

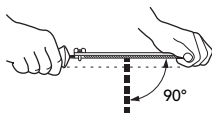
**TOOLS FOR FILING**

Part No.	Description
70503	3/16" Round File (12-Pack)
22291	.030" Depth-gauge Tool
OR534-316	3/16" Grinding Wheel, 5-3/4" Dia.
OR4125-316	3/16" Grinding Wheel, 4-1/8" Dia.

Ripping chains feature a special grind for use in ripping cuts only. Do not use these chains for any type of cutting other than ripping.

# 42 Oregon® Vanguard 3/8"

## OREGON® VANGUARD

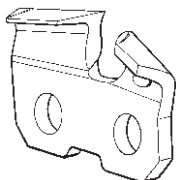

Kickback Reducing Features



End View



Use



Chain Type	Gauge
72V	.050"
73V	.058"
75V	.063"

### ***Low-kickback Performance*** ***Low-vibration Chain***

#### **FILING**

① DEPTH-GAUGE SETTING

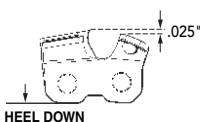

② TOP-PLATE CUTTING ANGLE

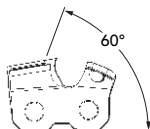

③ SIDE-PLATE ANGLE

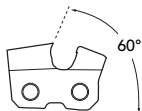

④ TOP-PLATE FILING ANGLE



⑤ FILE-GUIDE ANGLE

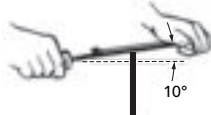



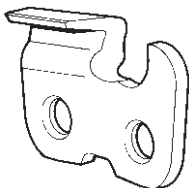

#### **TOOLS FOR FILING**

Part No.	Description
70502	7/32" Round File (12-Pack)
31686	7/32" Assembled File Guide
31941	.025" Drop-Center Depth-gauge Tool
OR534-316	3/16" Grinding Wheel, 5-3/4" Dia.
OR4125-316	3/16" Grinding Wheel, 4-1/8" Dia.

Chains on this page are intended for use with saws 3.0 to 6.0 cu. in. (50 cc - 100 cc) displacement and bars 12 in. to 32 in. (30 -81 cm) in length.

**SEMI CHISEL**

Kickback Reducing Features	End View	Use
		 

**Not a Low-kickback Chain**

Chain Type	Gauge
72AP, 72DP	.050"
73DP	.058"
75DP	.063"

**FILING**

① DEPTH-GAUGE SETTING

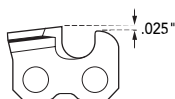

② TOP-PLATE CUTTING ANGLE

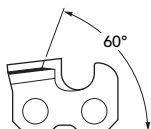

③ SIDE-PLATE ANGLE

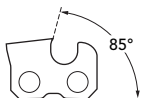

④ TOP-PLATE FILING ANGLE

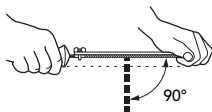

⑤ FILE-GUIDE ANGLE

**TOOLS FOR FILING**



Part No.	Description
70502	7/32" Round File (12-Pack)
31686	7/32" Assembled File Guide
22290	.025" Depth-gauge Tool
OR534-316	3/16" Grinding Wheel, 5-3/4" Dia.
OR4125-316	3/16" Grinding Wheel, 4-1/8" Dia.

Chains on this page are intended for use with saws up to 6.0 cu. in. displacement (100 cc), and bars up to 36 in. length (91 cm).

# 44 Speed Guard™ 3/8"

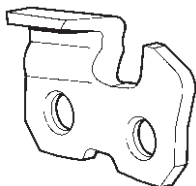
## SEMI CHISEL



<b>Kickback Reducing Features</b> 	<b>End View</b> 	<b>Use</b> 
--	--	---

### Not a Low-kickback Chain

Chain Type	Gauge
72DG*, 72DJ*	.050"
73DG*	.058"
75DG*	.063"

\*Recently obsoleted Oregon® chain part numbers

## FILING

① DEPTH-GAUGE SETTING

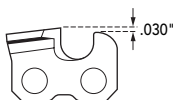

② TOP-PLATE CUTTING ANGLE

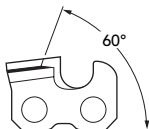

③ SIDE-PLATE ANGLE



④ TOP-PLATE FILING ANGLE

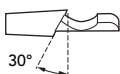

⑤ FILE-GUIDE ANGLE

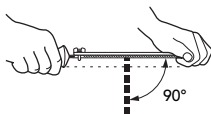

## TOOLS FOR FILING

Part No.	Description
70503	3/16" Round File (12-Pack)
31690	3/16" Assembled File Guide
22291	.030" Depth-gauge Tool
OR534-316	3/16" Grinding Wheel, 5-3/4" Dia.
OR4125-316	3/16" Grinding Wheel, 4-1/8" Dia.

Chains on this page are intended for use with saws up to 6.0 cu. in. displacement (100 cc), and bars up to 30 in. length (76 cm).



## CHISEL

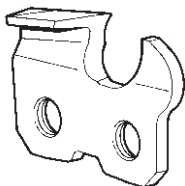

Kickback Reducing Features	End View	Use

**Not a Low-kickback Chain**

Chain Type	Gauge
72JG, 72LG	.050"
73JG, 73LG	.058"
75JG, 75LG	.063"

## FILING

① DEPTH-GAUGE SETTING

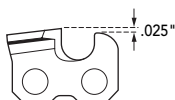

② TOP-PLATE CUTTING ANGLE

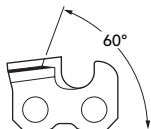

③ SIDE-PLATE ANGLE



④ TOP-PLATE FILING ANGLE



⑤ FILE-GUIDE ANGLE



## TOOLS FOR FILING



Part No.	Description
70502	7/32" Round File (12-Pack)
31686	7/32" Assembled File Guide
22290	.025" Depth-gauge Tool
OR534-316	3/16" Grinding Wheel, 5-3/4" Dia.
OR4125-316	3/16" Grinding Wheel, 4-1/8" Dia.

Chains on this page are intended for use with saws up to 6.0 cu. in. displacement (100 cc), and bars up to 36 in. length (91 cm).

# 46 Super 70 3/8"

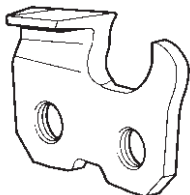
## CHISEL



Kickback Reducing Features 	End View 	Use 
---	---	--

**Not a Low-kickback Chain**

**Low-vibration Chain**

Chain Type	Gauge
72JP, 72LP, M72LP	.050"
73JP, 73LP, M73LP	.058"
75LP, M75LP	.063"

## FILING

① DEPTH-GAUGE SETTING

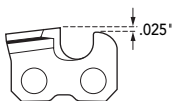

② TOP-PLATE CUTTING ANGLE

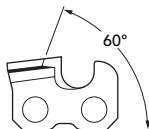

③ SIDE-PLATE ANGLE



④ TOP-PLATE FILING ANGLE

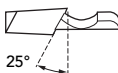

⑤ FILE-GUIDE ANGLE



## TOOLS FOR FILING

Part No.	Description
70502	7/32" Round File (12-Pack)
31686	7/32" Assembled File Guide
31941	.025" Drop-Center Depth-gauge Tool
OR534-316	3/16" Grinding Wheel, 5-3/4" Dia.
OR4125-316	3/16" Grinding Wheel, 4-1/8" Dia.

Chains on this page are intended for use with saws up to 6.0 cu. in. displacement (100 cc), and bars up to 36 in. length (91 cm).

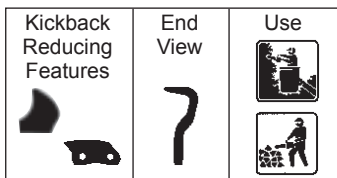
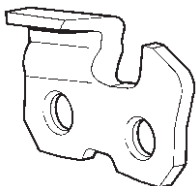
**SEMI CHISEL**

**A Low-kickback Chain**  
**With Bumper Tie Straps**

Chain Type	Gauge
72SG*	.050"
73SG*	.058"
75SG*	.063"

\*Recently obsoleted Oregon® chain part numbers

**FILING**

① DEPTH-GAUGE SETTING

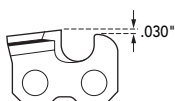

② TOP-PLATE CUTTING ANGLE

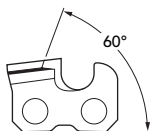

③ SIDE-PLATE ANGLE



④ TOP-PLATE FILING ANGLE

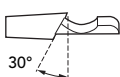

⑤ FILE-GUIDE ANGLE

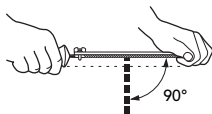
**TOOLS FOR FILING**



Part No.	Description
70503	3/16" Round File (12-Pack)
31690	3/16" Assembled File Guide
22291	.030" Depth-gauge Tool
OR534-316	3/16" Grinding Wheel, 5-3/4" Dia.
OR4125-316	3/16" Grinding Wheel, 4-1/8" Dia.

Chains on this page are intended for use with saws up to 4.3 cu. in. displacement (70 cc), and bars up to 24 in. length (61 cm).

# 48 Square-Ground Chain 3/8"

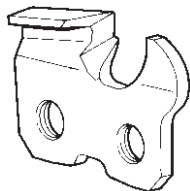
## CHISEL



<b>Kickback Reducing Features</b> 	<b>End View</b> 	<b>Use</b> 
--	--	---

**Not a Low-kickback Chain**

Chain Type	Gauge
72CJ, 72CJX, 72CK, 72CKX, 72CL, 72CLX	.050"
75CJ, 75CJX, 75CK, 75CKX, 75CL, 75CLX	.063"

## FILING

① DEPTH-GAUGE SETTING

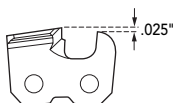

② TOP-PLATE CUTTING ANGLE

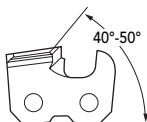

③ SIDE-PLATE ANGLE

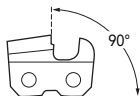

④ TOP-PLATE FILING ANGLE



⑤ GULLET FILING (SEE PAGE 66)



## TOOLS FOR FILING

Part No.	Description
22290	.025" Depth-gauge Tool
12211	Depth-gauge File (flat)

Chains on this page are intended for use with saws up to 6.0 cu. in. displacement (98 cc), and bars up to 36 in. length (91 cm).

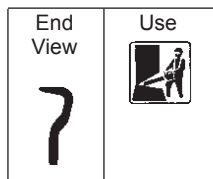
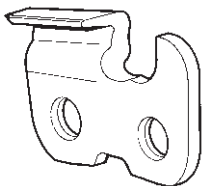
**SEMI CHISEL**

**Not a Low-kickback Chain**

Chain Type	Gauge
72RD	.050"
73RD	.058"
75RD	.063"

**FILING**

① DEPTH-GAUGE SETTING

② TOP-PLATE CUTTING ANGLE

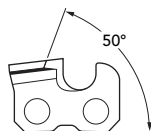
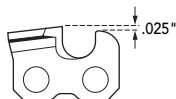

③ SIDE-PLATE ANGLE

④ TOP-PLATE FILING ANGLE

⑤ FILE-GUIDE ANGLE

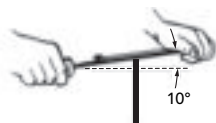
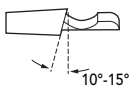
**TOOLS FOR FILING**

Part No.	Description
70502	7/32" Round File (12-Pack)
22290	.025" Depth-gauge Tool
OR534-316	3/16" Grinding Wheel, 5-3/4" Dia.
OR4125-316	3/16" Grinding Wheel, 4-1/8" Dia.

Ripping chains feature a special grind for use in ripping cuts only. Do not use these chains for any type of cutting other than ripping.

## CHAMFER CHISEL

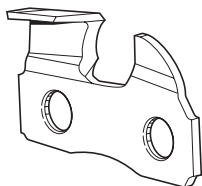

<b>Kickback Reducing Features</b> 	<b>End View</b> 	<b>Use</b> 
---------------------------------------	---------------------	----------------

**A Low-kickback Chain**

<b>Chain Type</b>	<b>Gauge</b>
90SG	.043"

**With Bumper Tie Straps**  
**Low-vibration Chain**  
**Narrow-kerf Chain**

## FILING

- ① DEPTH-GAUGE SETTING
- ② TOP-PLATE CUTTING ANGLE
- ③ SIDE-PLATE ANGLE
- ④ TOP-PLATE FILING ANGLE
- ⑤ FILE-GUIDE ANGLE

## TOOLS FOR FILING

Part No.	Description
70511	4.5mm Round File (12-Pack)
31692	4.5mm Assembled File Guide
31941	.025" Drop-Center Depth-gauge Tool
OR534-18	1/8" Grinding Wheel, 5-3/4" Dia.
OR4125-18	1/8" Grinding Wheel, 4-1/8" Dia.

Chains on this page are intended for use with saws up to 2.4 cu. in. displacement (40 cc), with bars for electric saws up to 16 in. (41 cm) and with bars for gasoline saws up to 14 in. (35 cm).

## CHAMFER CHISEL

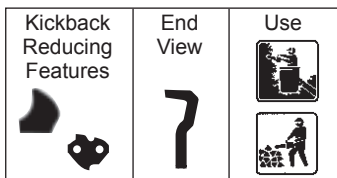
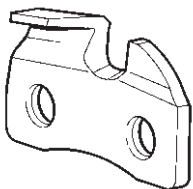

**A Low-kickback Chain**  
**With Bumper Drive Links**

<b>Chain Type</b>	<b>Gauge</b>
91P	.050"

## FILING

① DEPTH-GAUGE SETTING

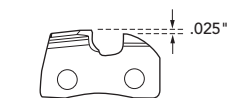

② TOP-PLATE CUTTING ANGLE

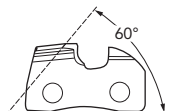

③ SIDE-PLATE ANGLE

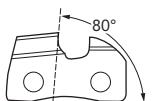

④ TOP-PLATE FILING ANGLE

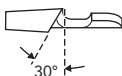

⑤ FILE-GUIDE ANGLE

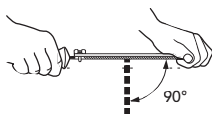

## TOOLS FOR FILING



Part No.	Description
70504	5/32" Round File (12-Pack)
37534	5/32" Assembled File Guide
31941	.025" Drop-Center Depth-gauge Tool
OR534-18	1/8" Grinding Wheel, 5-3/4" Dia.
OR4125-18	1/8" Grinding Wheel, 4-1/8" Dia.

Chains on this page are intended for use with saws up to 2.5 cu. in. displacement (41 cc), and bars up to 16 in. length (41 cm).

# 52 Low Profile 3/8"

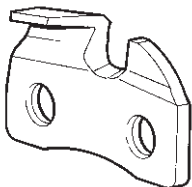
## CHAMFER CHISEL



<p>Kickback Reducing Features</p> 	<p>End View</p> 	<p>Use</p> 
---	---	--

**Not a Low-kickback Chain**

**No Bumper Tie Straps**  
**Low-vibration Chain**

<b>Chain Type</b>	<b>Gauge</b>
91VS, M91VS	.050"

## FILING

① DEPTH-GAUGE SETTING

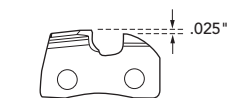

② TOP-PLATE CUTTING ANGLE

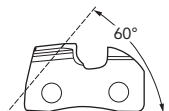

③ SIDE-PLATE ANGLE

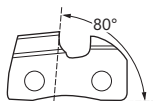

④ TOP-PLATE FILING ANGLE

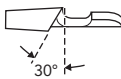

⑤ FILE-GUIDE ANGLE

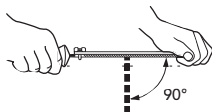

## TOOLS FOR FILING

Part No.	Description
70504	5/32" Round File (12-Pack)
37534	5/32" Assembled File Guide
31941	.025" Drop-Center Depth-gauge Tool
OR534-18	1/8" Grinding Wheel, 5-3/4" Dia.
OR4125-18	1/8" Grinding Wheel, 4-1/8" Dia.

Chains on this page are intended for use with saws up to 2.5 cu. in. displacement (41 cc), and bars up to 16 in. length (41 cm).

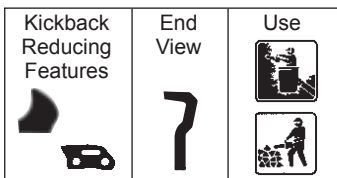
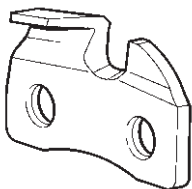

**CHAMFER CHISEL**

**A Low-kickback Chain**

**With Bumper Tie Straps**

**Low-vibration Chain**

<b>Chain Type</b>	<b>Gauge</b>
91VG	.050"

**FILING**

① DEPTH-GAUGE SETTING

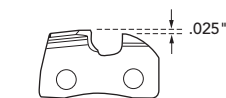

② TOP-PLATE CUTTING ANGLE

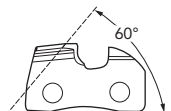

③ SIDE-PLATE ANGLE

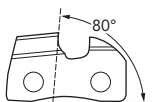

④ TOP-PLATE FILING ANGLE

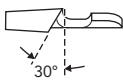

⑤ FILE-GUIDE ANGLE

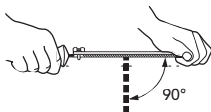
**TOOLS FOR FILING**

Part No.	Description
70504	5/32" Round File (12-Pack)
37534	5/32" Assembled File Guide
31941	.025" Drop-Center Depth-gauge Tool
OR534-18	1/8" Grinding Wheel, 5-3/4" Dia.
OR4125-18	1/8" Grinding Wheel, 4-1/8" Dia.





Chains on this page are intended for use with saws up to 2.5 cu. in. displacement (41 cc), and bars up to 16 in. length (41 cm).

# 54 Micro Chisel® .404"

## MICRO CHISEL



**Not a Low-kickback Chain**

<b>Kickback Reducing Features</b> 26P, 27P  26, 27, 27A 	<b>End View</b> 	<b>Use</b> 
--	--	---

Chain Type	Gauge
26, 26P	.058"
27, 27A, 27P	.063"

## FILING

① DEPTH-GAUGE SETTING

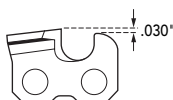

② TOP-PLATE CUTTING ANGLE

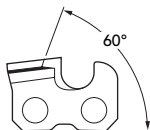

③ SIDE-PLATE ANGLE

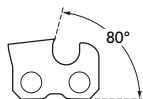

④ TOP-PLATE FILING ANGLE



⑤ FILE-GUIDE ANGLE

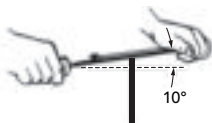

## TOOLS FOR FILING

Part No.	Description
70502	7/32" Round File (12-Pack)
31686	7/32" Assembled File Guide
22291	.030" Depth-gauge Tool
OR534-316	3/16" Grinding Wheel, 5-3/4" Dia.
OR4125-316	3/16" Grinding Wheel, 4-1/8" Dia.

Chains on this page are intended for use with saws 4.0 cu. in. displacement (65 cc) and larger, and with bars 20 in. (50 cm) and longer.

## MICRO CHISEL

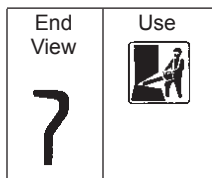
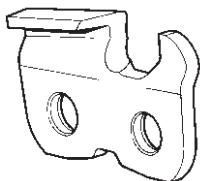

**Not a Low-kickback Chain**

Chain Type	Gauge
27R	.063"
27RA (skip)	.063"

## FILING

① DEPTH-GAUGE SETTING

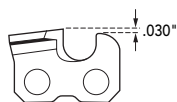

② TOP-PLATE CUTTING ANGLE

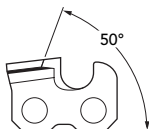

③ SIDE-PLATE ANGLE

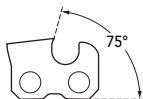

④ TOP-PLATE FILING ANGLE

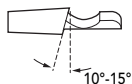

⑤ FILE-GUIDE ANGLE

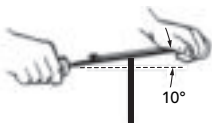

## TOOLS FOR FILING

Part No.	Description
70502	7/32" Round File (12-Pack)
22291	.030" Depth-gauge Tool
OR534-316	3/16" Grinding Wheel, 5-3/4" Dia.
OR4125-316	3/16" Grinding Wheel, 4-1/8" Dia.

Ripping chains feature a special grind for use in ripping cuts only. Do not use these chains for any type of cutting other than ripping.

# 56 Super Chisel™ .404"

## CHISEL

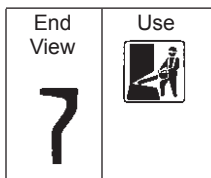
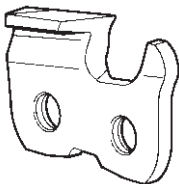

**Not a Low-kickback Chain**

Chain Type	Gauge
50L*	.050"
51L*	.058"
52L*	.063"

\*Recently obsoleted Oregon® chain part numbers

## FILING

① DEPTH-GAUGE SETTING

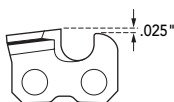

② TOP-PLATE CUTTING ANGLE

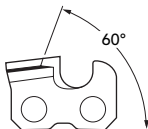

③ SIDE-PLATE ANGLE

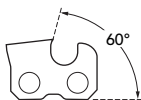

④ TOP-PLATE FILING ANGLE

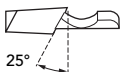

⑤ FILE-GUIDE ANGLE

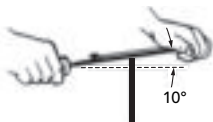

## TOOLS FOR FILING

Part No.	Description
70502	7/32" Round File (12-Pack)
31686	7/32" Assembled File Guide
22290	.025" Depth-gauge Tool
OR534-316	3/16" Grinding Wheel, 5-3/4" Dia.
OR4125-316	3/16" Grinding Wheel, 4-1/8" Dia.

Chains on this page are intended for use with saws 4.0 cu. in. displacement (65 cc) and larger, and with bars 20 in. (50 cm) and longer.

## CHIPPER

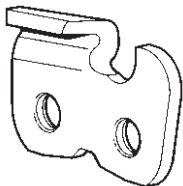

<b>Kickback Reducing Features</b> 	<b>End View</b> 	<b>Use</b> 
---------------------------------------	---------------------	----------------

**Not a Low-kickback Chain**

Chain Type	Gauge
58CP*	.058"
59CP*	.063"

\*Recently obsoleted Oregon® chain part numbers

## FILING

① DEPTH-GAUGE SETTING

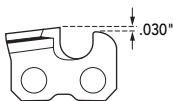

② TOP-PLATE CUTTING ANGLE

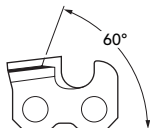

③ SIDE-PLATE ANGLE

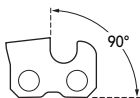

④ TOP-PLATE FILING ANGLE

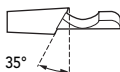

⑤ FILE-GUIDE ANGLE

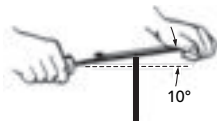

## TOOLS FOR FILING



Part No.	Description
70502	7/32" Round File (12-Pack)
31686	7/32" Assembled File Guide
22291	.030" Depth-gauge Tool
OR534-316	3/16" Grinding Wheel, 5-3/4" Dia.
OR4125-316	3/16" Grinding Wheel, 4-1/8" Dia.

Chains on this page are intended for use with saws 4.0 cu. in. displacement (65 cc) and larger, and with bars 20 in. (50 cm) and longer.

# 58 Super Guard® .404"

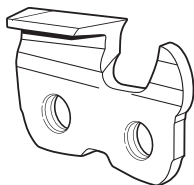
## CHISEL



Kickback Reducing Features 	End View 	Use 
---	---	--

### Not a Low-kickback Chain

Chain Type	Gauge
58J, 58L, 58LG*	.058"
59J, 59L, 59JG*, 59LG*	.063"

\*Recently obsoleted Oregon® chain part numbers

## FILING

① DEPTH-GAUGE SETTING

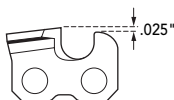

② TOP-PLATE CUTTING ANGLE

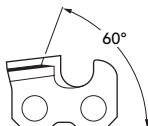

③ SIDE-PLATE ANGLE

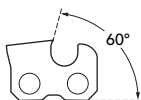

④ TOP-PLATE FILING ANGLE

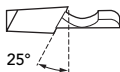

⑤ FILE-GUIDE ANGLE

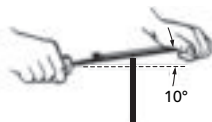

## TOOLS FOR FILING

Part No.	Description
70502	7/32" Round File (12-Pack)
31686	7/32" Assembled File Guide
31941	.025" Depth-gauge Tool, J & L Chains
22290	.025" Depth-gauge Tool, JG & LG Chains
OR534-316	3/16" Grinding Wheel, 5-3/4" Dia.
OR4125-316	3/16" Grinding Wheel, 4-1/8" Dia.

Chains on this page are intended for use with saws 4.0 cu. in. displacement (65 cc) and larger, and with bars 20 in. (50 cm) and longer.

## CHISEL

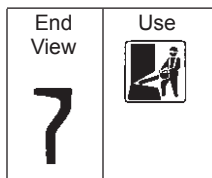
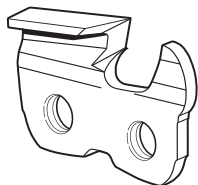

### Not a Low-kickback Chain

Chain Type	Gauge
50AJ*, 50AL*	.050"
58CJ, 58CL, 51AJ*, 51AL*	.058"
59CJ, 59CK, 59CL, 52AJ*, 52AK*, 52AL*	.063"

\*Recently obsoleted Oregon® chain part numbers

## FILING

① DEPTH-GAUGE SETTING

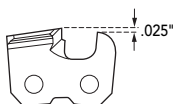

② TOP-PLATE CUTTING ANGLE

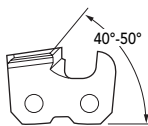

③ SIDE-PLATE ANGLE



④ TOP-PLATE FILING ANGLE



⑤ GULLET FILING (SEE PAGE 66)



## TOOLS FOR FILING

Part No.	Description
22290	.025" Depth-gauge Tool
12211	Depth-gauge File (flat)

Chains on this page are intended for use with saws 4.0 cu. in. displacement (65 cc) and larger, and bars 20 in. (50 cm) and longer.

# 60 Harvester Chain .404"

## CHIPPER

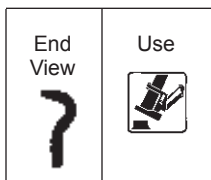
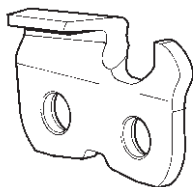

Chain Type	Gauge
59AA	.063"

***Harvester,  
no hand-held applications***

## FILING

① DEPTH-GAUGE SETTING

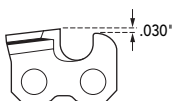

② TOP-PLATE CUTTING ANGLE

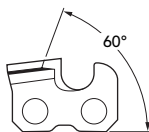

③ SIDE-PLATE ANGLE

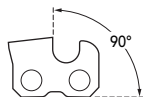

④ TOP-PLATE FILING ANGLE

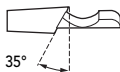

⑤ FILE-GUIDE ANGLE

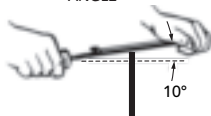

## TOOLS FOR FILING

Part No.	Description
70502	7/32" Round File (12-Pack)
31686	7/32" Assembled File Guide
22291	.030" Depth-gauge Tool
OR534-316	3/16" Grinding Wheel, 5-3/4" Dia.
OR4125-316	3/16" Grinding Wheel, 4-1/8" Dia.

**⚠ WARNING** For use on mechanized harvesting equipment only.

Do not use on hand-held cutting applications as severe injury to operator or bystanders may result.

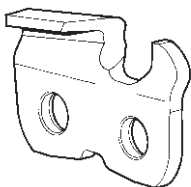

**MICRO CHISEL®**

**Harvester,**  
***no hand-held applications***

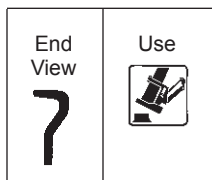

Chain Type	Gauge
16H	.063"
18H	.080"

**FILING**

① DEPTH-GAUGE SETTING

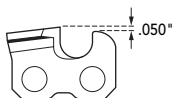

② TOP-PLATE CUTTING ANGLE

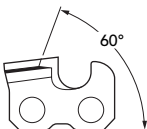

③ SIDE-PLATE ANGLE



④ TOP-PLATE FILING ANGLE



⑤ FILE-GUIDE ANGLE

**TOOLS FOR FILING**

Part No.	Description
70502	7/32" Round File (12-Pack)
31686	7/32" Assembled File Guide
38850	.050" Depth-gauge Tool
OR534-316	3/16" Grinding Wheel, 5-3/4" Dia.
OR4125-316	3/16" Grinding Wheel, 4-1/8" Dia.

**⚠ WARNING**

For use on mechanized harvesting equipment only.

Do not use on hand-held cutting applications as severe injury to operator or bystanders may result.

# 62 Harvester Chain 3/4"

## CHIPPER

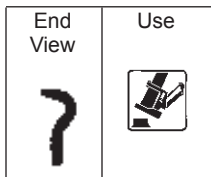
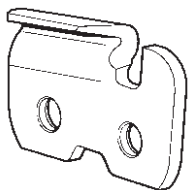

***Harvester,  
no hand-held applications***

Chain Type	Gauge
11BC	.122"

## FILING

① DEPTH-GAUGE SETTING

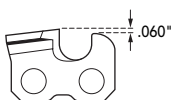

② TOP-PLATE CUTTING ANGLE

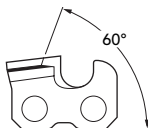

③ SIDE-PLATE ANGLE



④ TOP-PLATE FILING ANGLE



⑤ FILE-GUIDE ANGLE

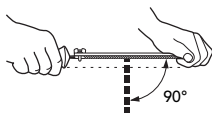

## TOOLS FOR FILING

Part No.	Description
90410	5/16" Round File (6-Pack)
26800	.060" Depth-gauge Tool
OR534-516	5/16" Grinding Wheel, 5-3/4" Dia.

**⚠ WARNING** For use on mechanized harvesting equipment only.

Do not use on hand-held cutting applications as severe injury to operator or bystanders may result.

## SEMI CHISEL

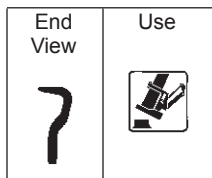
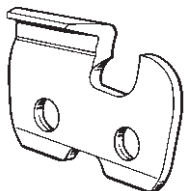

***Harvester,  
no hand-held applications***

Chain Type	Gauge
11H	.122"

## FILING

① DEPTH-GAUGE SETTING

② TOP-PLATE CUTTING ANGLE

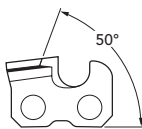
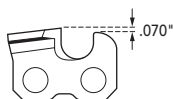

③ SIDE-PLATE ANGLE

④ TOP-PLATE FILING ANGLE

⑤ FILE-GUIDE ANGLE

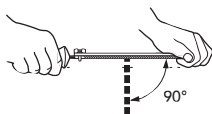
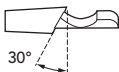
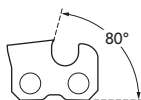

## TOOLS FOR FILING

Part No.	Description
90410	5/16" Round File (6-Pack)
107617	5/16" Assembled 11H File Guide
107529	.070" Depth-gauge Tool
OR534-516	5/16" Grinding Wheel, 5-3/4" Dia.

**⚠ WARNING**

For use on mechanized harvesting equipment only.

Do not use on hand-held cutting applications as severe injury to operator or bystanders may result.

# 64 Square-Ground Filing

## WHO SHOULD PERFORM SQUARE GROUND FILING?

Most chainsaw users will probably never need to use square ground chain, nor learn to perform square-ground filing. But in areas where the timber is larger and the guide bars used are longer, the performance advantages of square-ground chain can outweigh the fact that square-ground filing is more difficult and much less forgiving of filing errors.

## FILE POSITIONING

The file will sharpen the top plate, and the side plate, simultaneously. This creates a line, (A), where the top-plate cutting angle meets the side-plate angle. For best results, file so that the line joins the cutting corner (B).

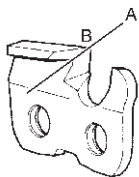

CORRECTLY  
FILED CORNER

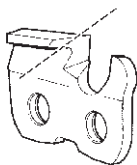

INCORRECT  
TOO HIGH

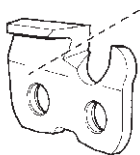

INCORRECT  
TOO LOW

To properly sharpen the cutter, use the correct filing position, as shown here from three different points of view:

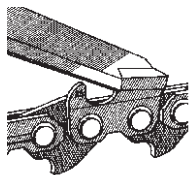

END VIEW  
TOP VIEW

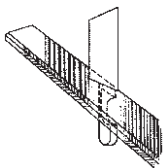
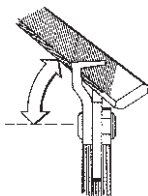

SIDE VIEW

# Square-Ground Filing | 65

## FILE DIRECTION

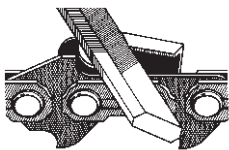

DOWNWARD FILING  
DIRECTION

Oregon® recommends that square-ground chain be filed from the outside in (in a downward direction). This leaves a better edge on the chromed cutting surfaces and makes it easier to keep the file's position, and the resulting cutting

edges, in correct alignment as shown in the preceding "File Positioning" section. However, filing from the outside in will wear out your file faster.

Some square-ground chain users may prefer to file from the inside out (in an upward direction). You should be aware that inside-out filing is much more difficult.

But whichever direction you choose, be sure your file and your cutting edges stay positioned as shown in the preceding "File Positioning" section. File all cutters on one side of the chain, then reverse the chain and repeat the process. Use the same file positions for cutters on the opposite side of the chain.

## TOOLS

Only use files specially designed for square-ground chisel cutters, available from your chainsaw dealer.



DOUBLE BEVEL



HEXAGON



"GOOFY"

# 66 Square-Ground Filing

## GULLET FILING

Approximately every 5th sharpening, clean out gullets by filing them back with a  $7/32$ " round file. File gullets from the inside out (the side opposite from sharpening). Always leave a  $1/8$ " shelf behind the gullet.



BEFORE

AFTER

If not cleaned out regularly, the outer edge of your gullets will eventually prevent the working corners of your cutters from getting an adequate bite into the wood.



Wrong

Right

Little or no clearance between the working corner and the gullet's outer edge.

Clearance is maintained between the working corner and the gullet's outer edge.

## DEPTH-GAUGE SETTING

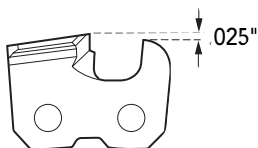

**NOTE** The depth-gauge setting for all square-ground chisel chain is  $.025$ ".

## SAW CHAIN TROUBLESHOOTING

Most chain problems are caused by three things: incorrect chain tension, incorrect filing, and lack of lubrication. *Look closely at your chain's cutters, and compare them to the following illustrations. See the following pages for "Remedies" to these problems.*

### PROBLEM

**Chain cuts slow, cuts rough, or won't hold an edge**

①



Light abrasive damage on side plates.

**Remedy:** See A.

②



Severe abrasive damage on side plates.

**Remedy:** See A.

③



Abrasive or impact damage to the top plate or working corner. **Remedy:** See A.

④

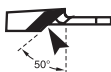

Too much top-plate filing angle.

**Remedy:** See B.

⑤

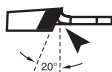

Too little top-plate filing angle.

**Remedy:** See B.

⑥



Too much top-plate-cutting angle.

**Remedy:** See C.

⑦



Too little top-plate-cutting angle.

**Remedy:** See D.

⑧



Too much hook in side plate.

**Remedy:** See C.

⑨



Backslope on side plate.

**Remedy:** See D.

CONTINUED...

# 68 | Saw Chain

## SAW-CHAIN TROUBLESHOOTING (CONTINUED)

⑩



Low depth gauges.

**Remedy:** See E.

⑪



High depth gauges.

**Remedy:** See F.

⑫



Square or blunt depth gauges.

**Remedy:** See G.

## REMEDIES

- A.** File cutters back until all damage is removed. This remedy applies to pictures ①, ② and ③.
- B.** Resharpener cutters while holding your file at the correct top-plate filing angle for your chain. Be sure your file guide is stamped with your chain's correct top-plate angle. This remedy applies to pictures ④ and ⑤.
- C.** Either your file was too small or it was held too low. Resharpener cutters with a file of the correct size, held in the correct position. Use the correct file guide. This remedy applies to pictures ⑥ and ⑧.
- D.** Either your file was too large or it was held too high. Resharpener cutters with a file of the correct size, held in the correct position. Use the correct file guide. This remedy applies to pictures ⑦ and ⑨.
- E.** In most cases, cutters cannot be filed back enough to correct for depth gauges that are too low. Replace the chain. This remedy applies to picture ⑩.
- F.** File depth gauges down to their correct height. This remedy applies to picture ⑪.
- G.** File the front corners of depth gauges parallel to their original rounded or ramped shape. This remedy applies to picture ⑫.

### NOTE

See pages 22-30 for the proper filing techniques to use when performing the remedies above.

CONTINUED...



## SAW-CHAIN TROUBLESHOOTING (CONTINUED)

### PROBLEM

Cutters and/or tie straps wear heavily or break

⑬



Excessive heel wear on cutters and opposite tie straps.

**Remedy:** See H.

⑭



Cracks under rear rivet holes on cutters and opposite tie straps.

**Remedy:** See H.

⑮



Tie straps broken in the center.

**Remedy:** See I.

⑯

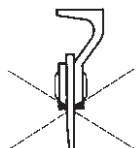
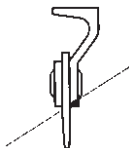

Bottoms of tie straps and cutters worn out of square. **Remedy:** See J.

## REMEDIES

**H.** Replace worn or cracked cutters and/or tie straps.

### NOTE

One or more of the following may be required to prevent future wear and/or cracks: (1) Refile cutters using the correct angles. (2) Keep more lubrication on the chain and bar. (3) Reduce the amount of depth-gauge setting (may require replacement of the chain). (4) Do not force dull chain to cut. (5) Do not force chain through frozen wood. (6) Keep cutters sharp. (7) Always maintain proper tension. This remedy applies to pictures ⑬ and ⑭.

**I.** See step 7, page 31 for the correct shaping of rivets. This remedy applies to picture ⑮.

### NOTE

Such breakage is usually caused by incorrect field assembly of tie straps. Breakage usually occurs on the preset tie strap.

CONTINUED...

# 70 | Saw Chain

## SAW-CHAIN TROUBLESHOOTING (CONTINUED)

### REMEDIES (CONTINUED)

- J. Dress the tops of the guide bar's rails square. If wear is minor, file the bottoms of tie straps and cutters square. If wear is extensive, replace the chain. This remedy applies to picture (16).

### PROBLEM

#### Drive links wear heavily or break

(17)



Straight bottoms.  
**Remedy:** See K.

(18)



Concave bottoms.  
**Remedy:** See K.

(19)



Battered and broken bottoms. **Remedy:** See L.

(20)



Peening in front or back.  
**Remedy:** See M.

(21)



Drive-link tang is turned up.  
**Remedy:** See N.

(22)



Worn fronts.  
**Remedy:** See O.

(23)



Sides worn round or thin at bottoms.  
**Remedy:** See P.

CONTINUED...

## SAW-CHAIN TROUBLESHOOTING (CONTINUED)

### REMEDIES: (K-P)

- K.** Check your guide bar (grooves in bar's body or nose have worn too shallow), and check your rim or spur drive sprocket (excessive wear is allowing drive links to bottom out). Replace bar, sprocket, or both. Sharpen drive-link tangs, as shown in the illustration on page 72, if possible. If not, replace the chain. This remedy applies to pictures (17) and (18).
- L.** Maintain proper tension to prevent chain from climbing out of spur drive sprocket. Replace drive links or replace entire chain if many drive links are damaged. This remedy applies to picture (19).
- M.** Sprocket has worn out of pitch, replace it. Replace chain. Do not attempt to run a new chain on an old sprocket, or an old chain on a new sprocket. This remedy applies to picture (20).
- N.** Drive sprocket has worn down until drive-link tangs hit bottom. Replace drive sprocket. Sharpen drive-link tangs as shown in the illustration below, if possible. If not, replace the chain. This remedy applies to picture (21).
- O.** Remove damage from sides of drive links with a flat file. Sharpen drive-link tangs as shown in the illustration below. Use a thin file to open the groove lead-in at the guide-bar's tail. This remedy applies to picture (22).
- P.** Bar rails have spread, or one rail has worn low, allowing chain to lean over. Have bar rails serviced by a dealer, otherwise replace bar. Replace chain if wear is extensive or if problem persists. This remedy applies to picture (23).

#### NOTE

Also check bottoms of tie straps (picture (16), page 69), and tops of bar rails (picture (31) page 84).

CONTINUED...

# 72 | Saw Chain

## SAW-CHAIN TROUBLESHOOTING (CONTINUED)

### SHARPENING DRIVE-LINK TANGS

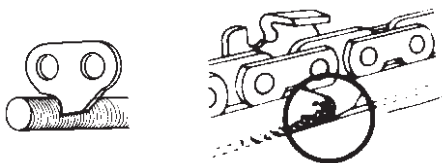

Pointed drive-link tangs help remove chips and debris from your bar groove. Sharpen damaged tangs back to original shape with a round file.

#### PROBLEM Chain has tight joints

*Tight joints are caused by either: loose tension, or an overworn drive sprocket. Look closely at your chain's chassis.*

②4



Peening on bottoms of cutters and tie straps. **Remedy:** See **Q**.

②5



Peening on front corners of cutters and tie straps. **Remedy:** See **Q**.

②6



Peening in notches of cutters and tie straps. **Remedy:** See **R**.

CONTINUED...

## SAW-CHAIN TROUBLESHOOTING (CONTINUED)

### REMEDIES: (Q-R)

- Q.** Chain with tight joints cannot be repaired. Replace the chain and maintain proper tension. Replace rim sprocket if worn. This remedy applies to pictures (24) and (25).
- R.** Replace the spur drive sprocket. Replace the chain. Always maintain proper tension and do not run chain on a worn drive sprocket. This remedy applies to picture (26).

### PROBLEM Chain cuts crooked

*Crooked cutting can be caused by your guide bar as well as your chain. Be sure to also check your bar's rails (pictures (29) through (34), pages 84-85).*

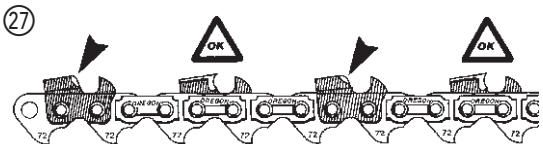

Damage to cutters on one side of the chain. **Remedy:** See **S**.

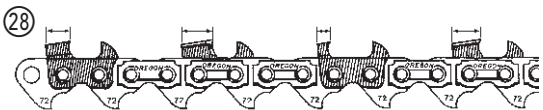

Inconsistent sharpening. **Remedy:** See **S**.

### REMEDY

- S.** File cutters back enough to remove all damage and incorrect angles. Keep cutter lengths and depth-gauge settings equal. This remedy applies to pictures (27) and (28).

# 74 | Guide Bars

## HERE'S HOW THE OREGON® SAW BAR



**\* 20      8      RN**

Length in Inches	Gauge	Oregon® Bar Type
12"	0=.050"	POWER MATCH® SYMMETRICAL SPROCKET-NOSE BAR
14"	8=.058"	<b>RN</b> = Symmetrical replaceable sprocket-nose
18"		GN= Symmetrical replaceable sprocket-nose with Guard Mate® holes
<b>20"</b>		
36" (Etc.)	3=.063"	REDUCED WEIGHT POWER MATCH® BAR
	4=.043"	RW= Symmetrical replaceable sprocket-nose
		POWER MATCH® DOUBLE GUARD® SPROCKET-NOSE BAR
		RG = Double Guard® replaceable sprocket-nose
		GG= Double Guard® replaceable sprocket-nose with Guard Mate® holes
		OREGON® PRO SYMMETRICAL SPROCKET-NOSE BAR
		PM= Symmetrical replaceable sprocket-nose
		LASER TIP SOLID-NOSE BAR
		AT = Solid nose with laser-welded stellite tip
		PRO-LITE® LAMINATED SPROCKET-NOSE BAR
		SL = Sprocket-nose
		GL = Sprocket-nose with Guard Mate® holes
		LASER-LITE™ LAMINATED SOLID-NOSE BAR
		LA = Solid nose with laser-welded stellite tip
		PRO 91® SYMMETRICAL SPROCKET-NOSE BAR
		SP = Symmetrical sprocket-nose
		GP = Symmetrical sprocket-nose with Guard Mate® holes
		MICRO-LITE™ LAMINATED SPROCKET-NOSE BAR
		MP= Professional narrow-kerf laminated sprocket-nose
		ML= Narrow-kerf laminated sprocket-nose (90 or 95)
		DOUBLE GUARD® CONSUMER SPROCKET-NOSE BAR
		PX = Double Guard® sprocket-nose (.325" and 3/8")
		GD= Double Guard® sprocket-nose with Guard Mate® holes (.325" and 3/8")
		SD = Double Guard® sprocket-nose (25 and 91)
		DG= Double Guard® sprocket-nose with Guard Mate® holes (25 and 91)

### GUARD MATE® HOLES

These holes are built into the noses of certain types of bars and allow the attachment of a Guard Mate® tip guard to help reduce the risk of kickback.

## PART-NUMBERING SYSTEM WORKS

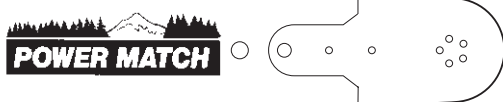

**D**      **D009**

Nose Size			Bar Mount
<b>Sprocket-nose Bars</b>			A218
	<b>Nose Pitch</b>	<b>Nose-sprocket Tooth Count</b>	A318
A	= 1/4"	= 10	A041
B	= .325"	= 10, 11, or 12	A061
<b>D</b>	= 3/8"	= 9, 10, or 11	A064
E	= 3/8"	= 7 or 9 (3/8" low profile "90" or "91" chains only)	A074
F	= .404"	= 10 or 11	A095
G	= .325"	= 12	<b>D009</b>
H	= 3/8"	= 11	D176 (Etc.)
<b>Solid-nose Laser Tip and Laser-Lite™ Bars</b>			**T041
		<b>Nose Radius</b>	**T061
X	= Extra Small (.95")		**T074
S	= Small (1.12")		**T095
M	= Medium (1.33")		**T218
L	= Large (1.65")		**T318

\* Oregon® bar part numbers are printed on the bar package, and have 10 digits. Here's what each digit means:

- The first two digits tell the bar's length.
- The third digit tells the bar's groove width or "gauge."
- The fourth and fifth digits tell the bar's type.
- The sixth digit tells either: (a) the nose pitch and nose-sprocket tooth count of any sprocket-nose bar – or – (b) the nose radius of any solid-nose Laser Tip or Laser-Lite™ bar.
- The last four digits identify the bar mount pattern.

\*\* Bars with "T" mounts have the Intenz™ tensioning feature

**20** = 20" bar length

**8** = .058" gauge

**RN** = Power Match® Symmetrical

**D** = 3/8" nose pitch with a 9-, 10-, or 11-tooth nose sprocket

**D009** = Bar mount, fits certain models of several brands

# 76 | Guide Bars

## OREGON® GUIDE-BAR TERMS

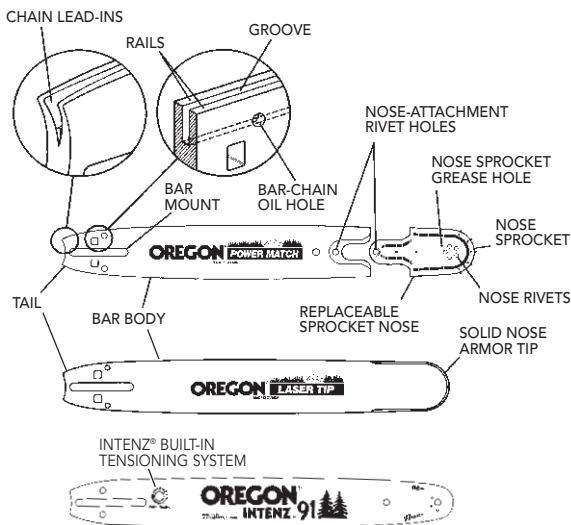

## OREGON® GUIDE-BAR-MAINTENANCE TOOLS



SPANNER WRENCH  
\*Asst'd. P/N's



FLAT FILE WITH HANDLE  
File P/N 12211



BAR RAIL DRESSER  
P/N 111439

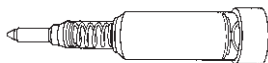

GREASE GUN  
P/N's 40469-A, 21939 OR 110534

\*Contact your Oregon® dealer for part numbers, wrench sizes and other help selecting the right tools for your bar.



## IMPORTANT INFORMATION ON OREGON® INTENZ® GUIDE BARS



Intenz® bars are those which have our patented Intenz® chain-tensioning mechanism built right into the bar itself.

Read and follow the information about Intenz® bars on this page, and provided inside the packaging sleeves of Intenz® bars.

### **Replacing the bar on saws currently equipped with an Intenz® bar**

Chainsaws originally equipped with an Intenz® bar do not have a "bar-adjustment pin" for tensioning the chain. And chainsaws which have been adapted to take an Intenz® bar have had the bar-adjustment pin removed. Since these saws have no bar-adjustment pin: ***always replace an Intenz® bar with another Intenz® bar or the ability to tension the chain will be lost.***

#### **⚠ WARNING**

Failure to tension chain correctly can cause serious injury to the saw operator or bystanders as a result of loose chain jumping off the bar.

Do not use standard-type non-Intenz® guide bars on chainsaws without a bar-adjustment pin. Chain tension can not be maintained on a non-Intenz® bar without the mechanical stop provided by the saw's bar-adjustment pin.

### **Replacing a standard bar with an Intenz® bar**

An Intenz® bar can be fitted to any chainsaw with a compatible bar-mount pattern. If the saw has a bar-adjustment pin, the pin **must** be removed. Carefully follow any instructions provided with replacement bars.

# 78 | Guide Bars

## OREGON® GUIDE-BAR MAINTENANCE

**ATTENTION:** Oregon® urges dealers, chainsaw users, and anyone who services guide bars to become familiar with proper bar-maintenance techniques and the possible dangers which can result if bars are not properly maintained.

**⚠ WARNING** Always turn off your saw's engine before handling the chain, guide bar or sprocket. Failure to do so can result in severe injury.

### NOTES

- Never use guide bar as a lever to lift, twist or pry.
- A guide bar requires a constant supply of oil during operation.
- For proper mounting of your guide bar, refer to the operator's manual for your chainsaw.

### BASIC GUIDE-BAR-MAINTENANCE TASKS

▲ Before use   ■ Often   ● Daily   ◆ Weekly   ⊘ Never



● Clean bar greasehole

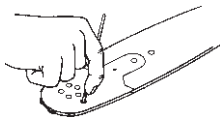

CONTINUED...

## BASIC GUIDE-BAR MAINTENANCE (CONTINUED)

■ Turn nose sprocket while pumping grease until whole sprocket has new grease. Do not push dirt into the hole.

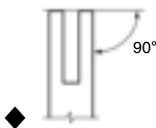
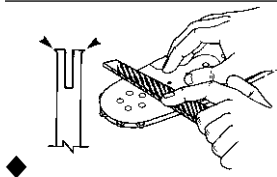
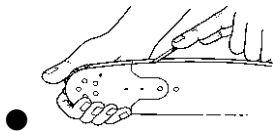
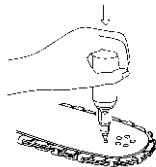

◆ With chain on the bar, hold a straightedge against the bar body and against a cutter side plate. A good groove will hold the chain straight, leaving a small gap between the straightedge and bar body.

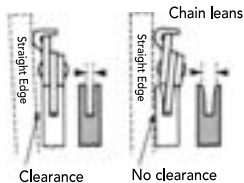

A worn groove will let the chain lean until straightedge is flush with bar body. Replace bar if groove is worn.

◆ On sprocket-nose bars, check for clearance around the bar's tip between the tops of rails and the bottoms of cutters or tie straps. Replace nose sprockets before cutters or tie straps contact the bar rails.

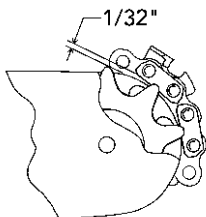

# 80 | Guide Bars

## HOW TO REPLACE OREGON® POWER MATCH BAR NOSES

**NOTE** Select a new Power Match® nose with the correct pitch for your bar and chain. Reduced-kickback Double Guard® replacement noses can be installed on any Power Match® bar and can be used with the same drive-link-count loop of chain.



1. Each Oregon® Power Match bar nose is marked, on one side only, with an "X." Always strike on the "X"-stamped side of Power Match® bar noses. Striking on the wrong side will damage the nose and bar body. Use a punch that will fit through the nose-rivet hole as shown to drive out the single attaching rivet.

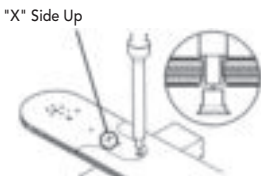

2. Remove the old nose. Clean the bar's attachment area.



3. Insert the new nose into the bar body. Insert the Power Match® rivet (part no. 34726) through the underside of the nose, opposite the "X" mark.

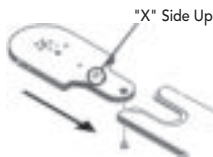

**NOTE** The rivet will not fit, and cannot be secured, if inserted through the "X" side.

## POWER MATCH® BAR NOSES (CONTINUED)

4. With the bar body, nose, and rivet solidly supported on a strong flat metal surface, peen the Power Match® rivet's head down with the flat end of a hammer. Do not hit the bar body, hit only the rivet head. Strike only on the "X" side.

To check installation, grip the bar body in one hand, the nose in the other hand, and twist. Nose and body should feel like a single, solid piece. If not (if any movement in the nose-bar joint area is felt – or if any clicking sound from the same area is heard), tighten the rivet with a few more hammer strokes.

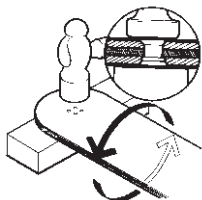

5. File down the rails of new noses to align with the rails of old bar bodies.

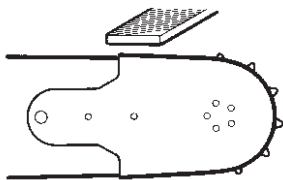

6. Grease the new nose sprocket. Pump grease into holes until excess grease appears around the nose-sprocket teeth of the guide bar.

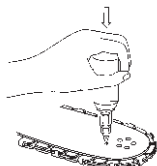
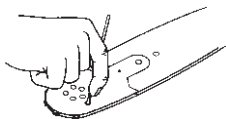

## 82 | Guide Bars

### HOW TO REPLACE NOSE SPROCKETS ON PRO-LITE®, AND MICRO-LITE™ PRO BARS

**NOTE** Select a new nose sprocket with the correct pitch for your bar and chain.



1. Drill or punch out heads from each of the nose-sprocket rivets. Punch out the remainder of the rivets. Use a punch narrow enough to keep from damaging rivet holes in the bar's nose.

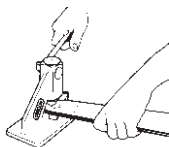

2. Use a small screwdriver to spread the bar-nose rails just enough to remove the old nose sprocket. Clean out debris from the sprocket area.

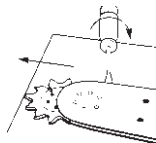

3. Inside the nose-sprocket package you'll find the new sprocket wrapped in a tissue. Be careful to keep the sprocket inside the tissue as you remove it from the package – bearings are easily lost. Slide the tissue and the new sprocket, together, into the bar's nose.



CONTINUED...

## PRO-LITE®/MICRO-LITE™ PRO NOSE SPROCKETS (CONTINUED)

4. Once fully inside the nose, hold the sprocket in place, then remove the tissue.

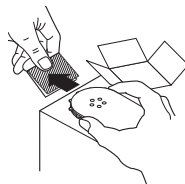

5. Align the sprocket's inner-race holes with the holes in the bar nose. Insert rivets into each hole through the bar. On used bars the nose rails may tend to spread apart. Use a small clamp to hold the nose rails together when inserting and securing the rivets.

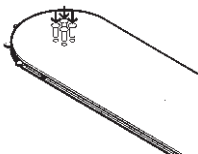

6. With the bar and rivets solidly supported on a strong, flat metal surface, carefullypeen the rivet heads down with the flat end of a hammer. Be careful to hit only the rivet head. Do not hit the bar body – this will pinch the nose sprocket. Rivet heads must be snug and secure while still allowing the sprocket to turn freely.

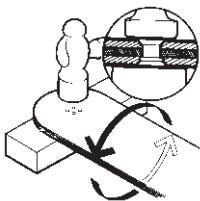

7. Grease the new nose sprocket. Pump grease into hole until excess grease appears around the nose-sprocket teeth of the guide bar.

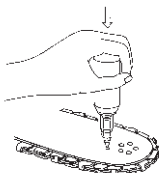
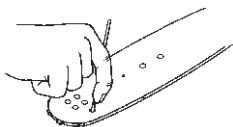

# 84 | Guide Bars

## GUIDE-BAR TROUBLESHOOTING

Most guide bar problems occur in the bar rails, and are caused by four things: incorrect chain tension, lack of lubrication, and accidents or irregular operating techniques which pinch the rails or push the drive links sideways against the bar rails.

Look closely at your guide bar and compare it to the following illustrations. See the following pages for remedies to these problems.

### PROBLEM Worn rail conditions

29



Rails are spread or worn down, groove becomes spread or shallow.

**Remedies:** See **T** and **U**.

30



Outsides or rails develop wire edges.

**Remedy:** See **T**.

31



Rail on one side is worn low.

**Remedy:** See **U**.

32

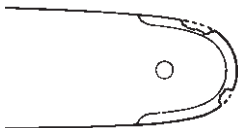

Rails around the tip of solid-nose bars show small cracks or broken-out sections.

**Remedy:** See **V**.

CONTINUED...



## GUIDE-BAR TROUBLESHOOTING (CONTINUED)

33

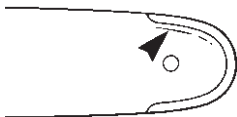

Rails around the tip of solid-nose bars are split at the bottom of the bar groove. **Remedy:** See V.

34

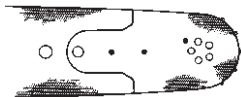

Rails along the bar body or around the tip of sprocket-nose bars show blue discoloration. **Remedy:** See W

### PROBLEM Bar sprocket-nose failure

35

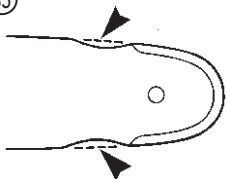

Chipped rails or excessive rail wear just behind the hard stellite alloy on solid-nose bars, or near the nose connection on replaceable-sprocket-nose bars. **Remedy:** See X.

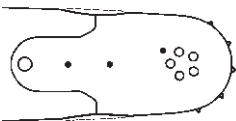

36

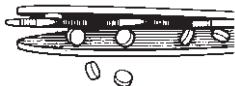

Rails in the tip of a sprocket-nose bar have spread, allowing loss of bearings. **Remedy:** See Y.

37

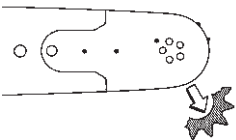

The sprocket in a sprocket-nose bar breaks. **Remedy:** See Y.

# 86 | Guide Bars

---

## GUIDE-BAR TROUBLESHOOTING (CONTINUED)

### REMEDIES: (T-Y)

- T.** Shallow grooves and wire edges are the result of inadequate lubrication, improper tension or normal wear over time. Use a flat file to square up the bar's rails and remove wire edges promptly. Left alone, wire edges can break off, chipping away good rail material. This remedy applies to pictures (29) and (30).
  
- U.** A low rail is caused by one of two things: (a) crooked-cutting chain or (b) chain leaning over in a worn groove. Replace the bar. Replace the chain as well if chain continues to lean in the new bar. (For more information on this problem and its causes, refer to pages 70-71, picture (23) and remedy P.) This remedy applies to pictures (29) and (31).
  
- V.** Accidents or irregular operating techniques which push the drive links sideways or place excessive pressure on the side of the nose can cause breaks or cracks in the rails of solid-nose bars. Your dealer may be able to repair minor damage on a relatively new bar. This remedy applies to pictures (32) and (33).
  
- W.** Pinched rails, lack of lubrication, or accidents and cutting techniques which push the drive links sideways in the groove can create extreme friction which causes blue discoloration. Blue spots on rails are soft and will wear rapidly. Replace the bar. This remedy applies to picture (34).

## GUIDE-BAR TROUBLESHOOTING (CONTINUED)

### REMEDIES: (T-Y) (CONTINUED)

- X.** Such wear or chipping near the nose often accompanies heavy limbing, but can also be caused by loose chain tension. Invert the bar on the saw periodically to reduce such wear. On replaceable-nose bars with minor wear, install a new nose and file down the nose's rails as shown on page 81, instruction number 5, for smooth chain flow. If wear is extensive (on solid-nose or replaceable-nose bars), replace the bar. This remedy applies to picture (35).
- Y.** Frequent boring cuts, loose chain tension, and accidents or irregular operating techniques which twist the nose or push the drive links sideways against the nose's rails will cause such breakage. Install a new replaceable-sprocket nose if possible, otherwise replace the bar. This remedy applies to pictures (36) and (37).

# 88 Drive Sprockets

## OREGON® SPROCKET TERMS

### RIM SPROCKET

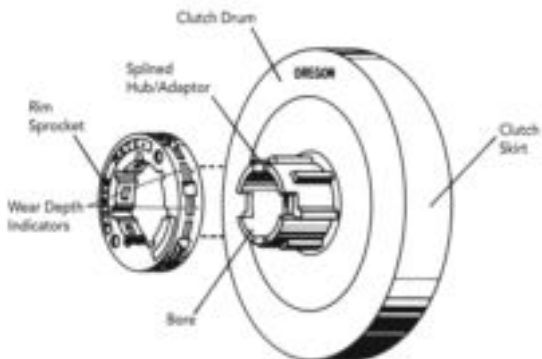

### SPUR SPROCKET

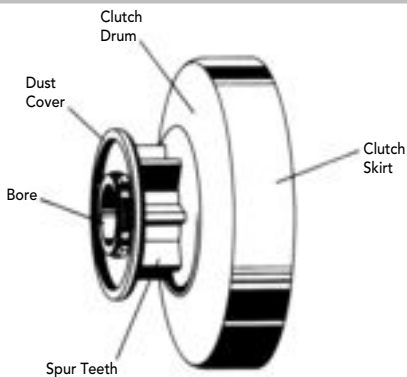

## OREGON® SPROCKET-MAINTENANCE TOOLS

### GREASE GUN

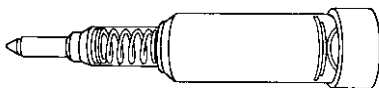

PART NUMBER, EACH: 40469-A  
40-PACK: 31187-A

## OREGON® RIM SPROCKETS WITH WEAR-DEPTH INDICATORS

The free-floating rim is the component of a sprocket system which is replaceable.

- Popular Oregon® rims have wear-depth indicators. When sprocket wear reaches the depth of the indicator, it's easy to see that it's time to replace the rim.

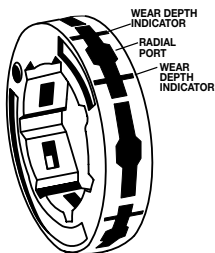

- Popular Oregon® rims also have a radially ported design which uses centrifugal force to throw off sawdust and debris.

## INSTALLING SPROCKETS

Oregon® sprockets can be installed on chainsaws having either inboard-clutch or outboard-clutch assemblies. Follow instructions in the operator's manual provided by your chainsaw's manufacturer for correct sprocket installation.

The illustrations below are for general reference only. Do not use them as instructions for sprocket or clutch assembly.

### INBOARD CLUTCH

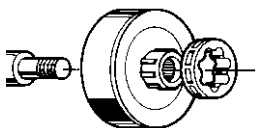

### OUTBOARD CLUTCH

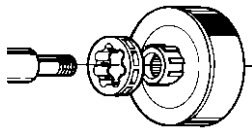

# 90 Drive Sprockets

## OREGON® SPROCKET MAINTENANCE

**ATTENTION:** Oregon® urges dealers, chainsaw users, and anyone who services sprockets to become familiar with proper sprocket-maintenance techniques and the possible dangers which can result if sprockets are not properly maintained.

### **⚠ WARNING**

Always turn off your saw's engine before handling the chain, guide bar or sprocket. Failure to do so can result in severe injury.

Your drive sprocket, the third member of the cutting team, deserves regular attention and maintenance just like your bar and chain. A misused sprocket will cause patterns of chain wear which can damage the guide bar and reduce the life of all three components. A damaged sprocket cannot be repaired, it can only be inspected and replaced. Here are the things to look for, and the steps to take.

### BASIC SPROCKET-MAINTENANCE TASKS

▲ Before use   ■ Often   ● Daily   ◆ Weekly   ⊘ Never

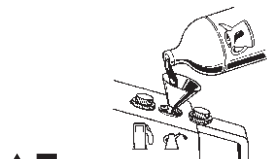
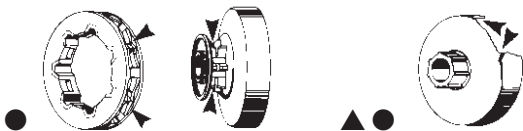

CONTINUED...

## BASIC SPROCKET-MAINTENANCE TASKS (CONTINUED)



▲ ■ Chain tension is especially important when the saw is tipped on its side during felling cuts. Loose chain (and rim-type sprocket, if used), will slide down and out of alignment with the bar. Loose chain tension is the leading cause of sprocket problems.

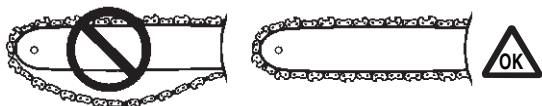

● Clean any buildup of sap or debris from splined hub so rim sprocket can float freely.

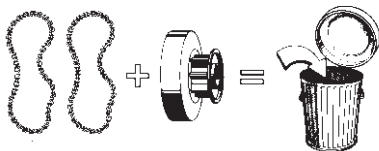

◆ Do not run old chain on a new sprocket, or a new chain on an old sprocket. Use two new chains in rotation with each new sprocket so all can wear together. Replace sprocket every two chains, or sooner.

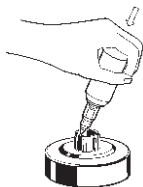

◆ Apply clean grease to the clutch drum's bearings each time the sprocket is removed.

# 92 | Drive Sprockets

## SPROCKET TROUBLESHOOTING

Most sprocket problems are caused by loose chain tension and failure to replace the sprocket or clutch drum when necessary.

Sprockets are inexpensive. One worn inexpensive sprocket can rapidly damage an expensive chain and bar. Do not try to save money by running new chains on old sprockets. Look for the conditions below and replace sprockets and clutch drums promptly.

**NOTE** If your saw has a chain brake, check the chain brake's action according to the instructions in your saw operator's manual. Be sure the chain-brake strap around your clutch skirt is not too tight when the brake is not engaged, which can lead to clutch-drum overheating and failure.

Look closely at your sprocket and compare it to the following illustrations. See the following page for remedies to these problems.

### PROBLEM Sprocket/Clutch drum failure

38

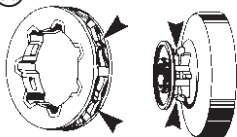

Worn outer surfaces on rim sprockets or spur sprockets.

**Remedy:** See **Z**.

39

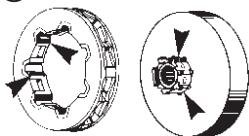

Worn inner surface on rim sprockets, or wear on the adapter's splines.

**Remedy:** See **AA**.

CONTINUED...



## SPROCKET TROUBLESHOOTING (CONTINUED)

40

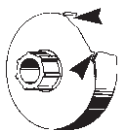

Cracks or breakage on the clutch drum. **Remedy:** See **BB**.

41



Obvious wear or discoloration around the outer circumference of the drum skirt. **Remedy:** See **CC**.

42



Excessive wear on the inside surface of the drum skirt. **Remedy:** See **DD**.

### REMEDIES: (Z-DD)

- Z.** Such outer surface wear is normal over time. Replace rim sprockets and spur sprockets when wear is 1/64" deep. Never run chain on severely worn sprockets. Severely worn sprockets could break during operation. This remedy applies to picture (38).
- AA.** Such wear indicates that chain drive links are bottoming out on the adapter's splines. Replace the clutch drum. Replace the rim sprocket. This remedy applies to picture (39).
- BB.** Do not attempt to repair cracked or broken clutch drums. Replace the drum. This remedy applies to picture (40).
- CC.** Replace the drum. Have your chainsaw dealer adjust the chain-brake strap. This remedy applies to picture (41).
- DD.** Replace the drum. Have your chainsaw dealer service the saw's clutch. This remedy applies to picture (42).

# 94 | Saw Chain

## HOW A CUTTER WORKS

Understanding how cutters work can help you see why proper chain maintenance is so important.

1. The depth gauge rides on the wood and controls the depth at which the cutting corner bites in.
2. The cutting corner and side plate sever the cross grains. This is the hardest part of the work.
3. The top-plate cutting angle chisels out the severed wood fibers, lifting them up and out of the kerf.

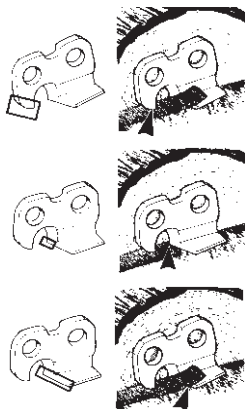

## HOW TO ORDER REPLACEMENT CHAIN

For the best possible service, have the following four items of information ready for your Oregon® dealer.

1. Your saw's make and model.

SAW MAN	1100-A
---------	--------

2. Your guide bar's cutting length.

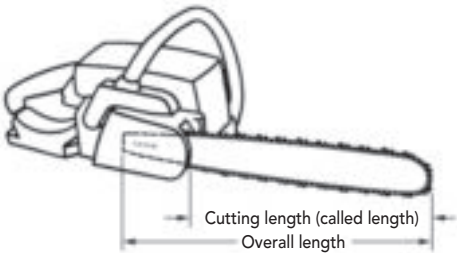

**NOTE** Your bar's cutting length (or "called length") is different from its overall length. The cutting length is the distance from the front of the saw to the tip of the farthest cutter.

3. Your chain's part number, 72LG for example. See pages 9-14 if you need help determining your Oregon® chain's part number.
4. Your chain loop's drive-link count, 68 for example. See page 5 if you need help identifying your chain's drive links.

**NOTE** A loop of replacement chain is usually ordered by combining the chain's part number with the loop's drive-link count.

**Example: 72LG - 68**

(Part No.) (Drive-Link Count)

# 96 | Saw Chain

**⚠ READ THE WARNING ON PAGE 17.**

**Cutting frozen wood will cause rapid wear and possible breakage around the rear rivet hole of cutters. Follow the steps below to keep cold-weather wear to a minimum.**



**OIL** – use a lighter weight of bar-chain oil, or dilute bar-chain oil 25 percent with clean kerosene or diesel oil. Use twice as much of this diluted oil during operation, and be certain your chain is receiving oil from the saw.

**TENSION** – Keep your chain correctly tensioned. Check and adjust often.

**CUTTERS** – Keep cutters sharp. Touch up every hour, more often if needed. Do not force dull chain to cut.

**DEPTH GAUGES** – Check and adjust your cutter's depth gauges at every sharpening.

**BAR** – keep the bar groove clean and oil hole open. Turn bars over to equalize rail wear.

**DRIVE SPROCKET** – Replace the sprocket after every two chains, or sooner.

## SOME GOOD SAW CHAIN ADVICE

Saw chain is made to cut only one thing: wood. Do not use saw chain to cut other materials, and never let your chain contact rocks or dirt during operation.

Never force dull chain to cut. When it is sharp, saw chain is designed to feed itself into the wood, and needs only light pressure to cut efficiently. Dull chain produces fine wood dust, which can clog your saw's air filter. Sharp chain produces wood chips.

## THE OREGON® CUSTOMER-SATISFACTION POLICY LIMITED WARRANTY

Oregon® (Oregon Cutting Systems Division, Blount, Inc.) warrants its products to be free from defects in materials and workmanship for as long as they are owned by the original retail purchaser.

If you like our products, please tell your friends. If you are not satisfied with our products, for any reason, please tell us. Oregon® wants to provide you with products that perform to your full satisfaction. We welcome you to contact us as shown below.

LIABILITY UNDER THIS WARRANTY IS LIMITED TO REPLACEMENT PARTS, AT THE OPTION OF YOUR OREGON® DISTRIBUTOR AND OREGON®. PLEASE CONTACT YOUR OREGON® DISTRIBUTOR OR US DIRECTLY. OREGON® PRODUCTS ARE NOT WARRANTED AGAINST USER ABUSE, IMPROPER MAINTENANCE, OR IMPROPER REPAIR.

REPLACEMENT OF DEFECTIVE PRODUCT IS THE EXCLUSIVE REMEDY UNDER THIS WARRANTY AND ANY APPLICABLE IMPLIED WARRANTY. THE REPLACEMENT WILL BE UNDERTAKEN AS SOON AS REASONABLY POSSIBLE AFTER RECEIPT OF THE DEFECTIVE PRODUCT. **TO THE EXTENT PERMITTED BY LAW, ANY IMPLIED WARRANTY OF MERCHANTABILITY OR FITNESS FOR A PARTICULAR PURPOSE APPLICABLE TO THIS PRODUCT IS LIMITED TO THE DURATION AND SCOPE OF THIS EXPRESS WARRANTY.** OREGON® SHALL NOT BE LIABLE FOR ANY CONSEQUENTIAL OR INCIDENTAL DAMAGES. SOME STATES DO NOT ALLOW LIMITATIONS ON HOW LONG AN IMPLIED WARRANTY LASTS OR DO NOT ALLOW THE EXCLUSION OF CONSEQUENTIAL DAMAGES, SO THE ABOVE LIMITATION OR EXCLUSION MAY NOT APPLY TO YOU. THIS WARRANTY GIVES THE ORIGINAL OWNER SPECIFIC LEGAL RIGHTS, AND YOU MAY ALSO HAVE OTHER RIGHTS WHICH VARY FROM STATE TO STATE.

To contact us in the U.S.A. regarding Forestry products (cutting chain, guide bars, sprockets, and accessories for chainsaws and mechanical timber harvesters), we welcome your calls between the hours of 7:30 a.m. and 4:00 p.m. (Pacific Time) Monday through Friday at 503-653-4706 or you can write to: Customer Service Department, Oregon Cutting Systems Division, Blount, Inc., P.O. Box 22127, Portland, Oregon 97269-2127, or you can contact us by visiting our website at [www.oregonchain.com](http://www.oregonchain.com) and using the "Technical Information" or "Technical Services" links.

# *Notes*

