

NEW METHOD OF IMPEDANCE MATCHING IN RADIO-FREQUENCY CIRCUITS.

Decimal Index 621.396.611.39

A new transformer method is described which is suitable both for matching circuits of unequal impedance and coupling symmetrical and unsymmetrical radio-frequency circuits. In contradistinction to conventional methods of impedance matching the frequency of the oscillations being transmitted can be varied over a wide range without the necessity of re-tuning.

THE impedances of the individual circuits of radio-frequency equipment are frequently unequal. In order to obviate the reflections and losses involved by mismatching, special matching devices have to be inserted between such dissimilar circuits for the transmission of energy. For instance, matching is necessary between the tubes of a transmitter output stage with high load resistance and the low-impedance antenna transmission line or feeder system. In the case of low frequencies transformers with a corresponding turns ratio can be employed. By reason of the unavoidable leakage inductance of the coupled transformer coils, high frequencies generally involve tuning by means of additional condensers, and should the working frequency be varied, corresponding re-tuning is therefore entailed.

For impedance matching purposes a quarter-wave Lecher wire system having a surge impedance which is the geometric mean between the two impedances to be matched can likewise be employed. Such matching sections must naturally also be re-tuned in the event of the frequency being altered, to correspond to the changed wave-length. Small frequency deviations are, however, permissible when the impedance transformation takes place in several steps adjusted to the mean frequency. — Another method of matching, the line with exponential taper, permits large frequency variations without re-tuning, but has amongst other things the drawback of taking up a large amount of space.

Special couplers are also necessary for transition from symmetrical to unsymmetrical circuits, e. g. between the symmetrical output of a push-pull transmitter stage and a coaxial antenna cable with earthed sheathing. Here, too, variation of the frequency generally involves re-tuning.

A new coupler which obviates re-tuning is shown in Fig. 1a. It comprises two superposed windings W_1 and W_2 separated by an insulating tube R . Given symmetrical currents i_1 (full-lined arrows) the magnetic fields produced by two closely-spaced superposed sections of conductor practically neutralize each other, i.e. the mutual inductance of two successive turns of a coil can be neglected, while it is possible to

replace the two windings by two straight conductors having the same cross-section, length, and spacing as the two developed windings. This Lecher wire system is represented in the equivalent diagram (Fig. 1b) by the equivalent line A .

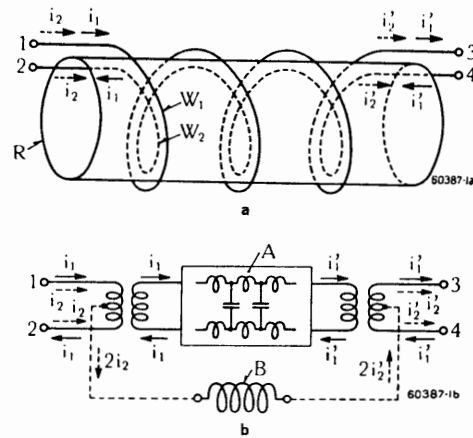

Figs. 1a and 1b. — Double-wire coil system with equivalent diagram.

- (a) The coil system comprises two superposed windings W_1 and W_2 separated by an insulating tube R .
- (b) According to this equivalent diagram, where symmetrical currents i_1 are concerned, the coil has the effect of a Lecher wire system A , but with unsymmetrical currents i_2 the nature of a choke coil B . The symmetrical and unsymmetrical currents are segregated by ideal centre-tapped transformers.

On the other hand, with unsymmetrical currents i_2 (dotted arrows), the field vectors produced by two superposed sections of the conductors are added together, with the result that the mutual inductance between the individual turns of the coil becomes an important factor. The double-wire coil system behaves here like a conventional choke coil, represented in the equivalent diagram by B . In this diagram the symmetrical and unsymmetrical currents i_1 and i_2 , respectively, are segregated by centre-tapped ideal transformers T . Given an adequate number of turns on the windings W_1 and W_2 the impedance of the equivalent choke coil B becomes so high that, even assuming unequal potentials between the centre tapings of the input and output coils, the unsymmetrical current i_2 can be neglected. In this case the described coil system forms an ideal transformer combined with an ideal line.

In view of the effect of this ideal transformer such a system S can now be employed, as shown for example in Fig. 2a, to couple a physically symmetrical circuit (connected to terminals 1 and 2) to a load resistance R_a having one pole earthed. By making

the coil of suitable dimensions the surge impedance Z_0 of the matching line (A in the equivalent diagram Fig. 1 b) represented by the coil system can be adapted to the pure load resistance R_a . In this case the input impedance R_e occurring between terminals 1 and 2 is equal to the surge impedance Z_0 and in consequence also to the load resistance R_a , immaterial of the actual working frequency.

The curves in Fig. 3 give the input impedance computed from the coil dimensions for conditions of short circuit and no-load. The measured impedance values are also given and agree with the curves to a high degree. These measurements, which demand great care, were made by a method specially developed for the purpose (cf. Fig. 1, page 293). The characteristic surge impedance can be determined from

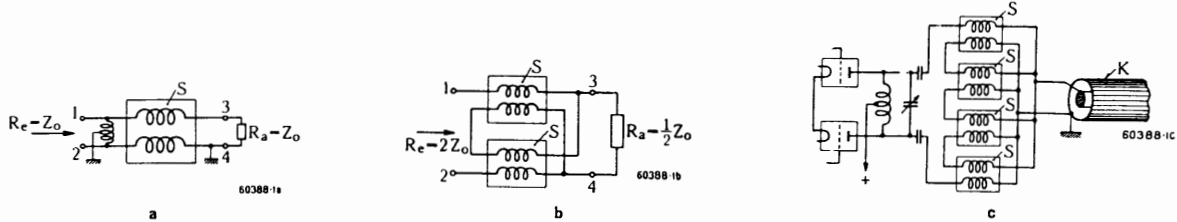

Fig. 2 a, b, and c. — Employment of double-wire coil systems for coupling and impedance matching purposes.

(a) Due to the suppression of the unsymmetrical currents by the series inductance of the coils such units can be used for coupling physically symmetrical circuits (connected to terminals 1 and 2) to circuits having one pole earthed (connected to terminals 3 and 4).

(b) By series-parallel connection of two coil systems S the load resistance $R_a = \frac{1}{2} Z_0$ is transformed to the input impedance $R_e = 2 Z_0$ ($Z_0 =$ surge impedance of a coil system).

(c) The antenna cable K and output stage are "matched" by the four coil systems S .

Surge impedance of coil systems = 240Ω .
 Surge impedance of cable = $240 \Omega : 4 = 60 \Omega$.
 Load impedance of output stage = $240 \Omega \times 4 = 960 \Omega$.

By series-parallel connection of two or more coil systems impedance matching is now also possible in a simple manner, independent of the frequency. Fig. 2b shows by way of example the input terminals of two systems of coils S connected in series and the output terminals in parallel. No objections can be raised to this practice provided the series inductance (B in the equivalent diagram in Fig. 1b) is large enough. The load resistance $R_a = \frac{1}{2} Z_0$ is thus transformed to the input impedance $2 Z_0$. Analogously, with n coil systems impedance transformation in the ratio $1 : n^2$ can be achieved.

In Fig. 2c, for instance, four coil systems are shown connected between a transmitter output stage and the high-frequency antenna cable K , the resulting impedance transformation being in the ratio $4^2 : 1 = 16 : 1$. With a coil system having a surge impedance $Z_0 = 240 \Omega$, for example, a transmitter output stage with a load impedance of $4 \times Z_0 = 960 \Omega$ can be coupled to an antenna cable of $Z_0 : 4 = 60 \Omega$. The coupled coil systems have the same effect as a transformer with separate windings, i.e. the symmetry of the anode circuit at the input end is not affected by single-pole earthing of the cable connected to the other end. Furthermore, the coupled coil systems behave like a Lecher wire system, i.e. the input impedance must follow a tangential function of the frequency when the terminals at the other end are open or short-circuited.

the geometric mean of the measured or computed short-circuit and no-load input impedances. In the present case it is about 240Ω . Fig. 4 gives the curve of the input impedance for a load impedance of about 53Ω . From the test points it is clear that the desired impedance transformation in the ratio of $1 : 16$ is actually possible over a very wide frequency range. The deviation of the plotted mean-value curve R_e from the theoretical curve 1 is due to the load

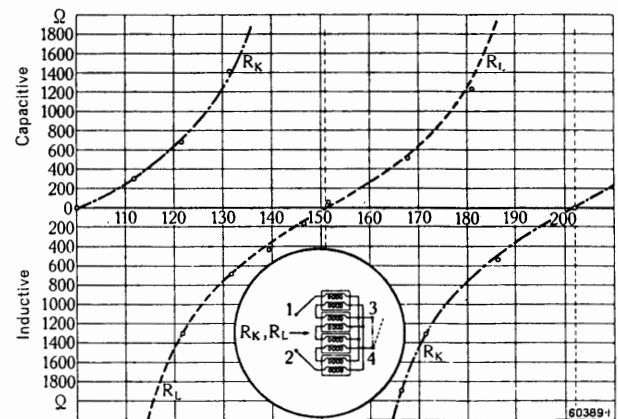

Fig. 3. — Input impedance of matching unit when output terminals short-circuited or open.

The matching unit comprises four double wire coils in series-parallel connection. The computed and measured primary impedances are plotted as a function of the frequency with the secondary terminals open and short-circuited.

--- } Computed curves. o. Test points.
 R_K . Input impedance with secondary terminals short-circuited.
 R_L . Input impedance with secondary terminals open.

impedance being slightly lower than the theoretical value, as well as to the inherent capacitance of the circuit.

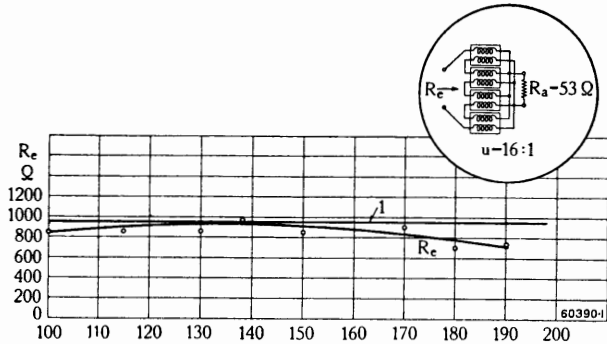

Fig. 4. — Theoretical and measured input impedance of a matching unit with a pure resistive load.

The matching unit comprises four double-wire coils in series-parallel connection. A surge impedance of 240 Ω was computed from the coil data and the measurements in Fig. 3, whence, assuming a pure resistive load of 60 Ω, the theoretical value of the input impedance is 960 Ω. The measured values of the input impedance are somewhat lower owing to the load impedance having been somewhat lower than theoretically assumed.

Theoretical value of $R_a = Z_0$. o. Test points for $R_a = 53 \Omega$.
Impedance transformation ratio 16:1.

The described method of matching is particularly suitable for application in the ultra-short-wave field, where it represents a big simplification compared

to conventional tuned matching devices. Fig. 5 shows the external appearance of an impedance transformer with four coils, employed as antenna coupler in a

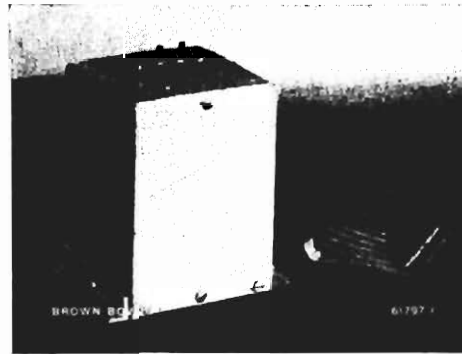

Fig. 5. — Matching unit with double-wire coils.

The system contains four double-wire coils for impedance transformation from 60 Ω to about 1000 Ω in the case of metre waves. With a power of over 100 W the losses are negligible.

medium-power transmitter. It requires little space and its losses are very low. This new component greatly simplifies the construction and operation of the equipment marketed by the Company.

(MS 564)

G. Guanella. (E. G. W.)

Electric Filters built up from Choke Coils and Condensers for Frequencies up to 60 kc.

Decimal Index 621.318.7

ELECTRIC filters are employed for the discrimination or segregation of individual frequencies or frequency bands. For frequencies over 60 kc crystal filters are now finding favour, whereas in the range below this figure coils and condensers are practically exclusively used as filter elements. The most commonly employed types are the low, high, and band-pass, so-called from the different positions of the pass and rejection regions in the frequency range. On the score of selectivity present-day demands are very exacting, that is:

1. In the pass frequency band as uniform a response to pass frequencies as possible with minimum attenuation.
2. Virtually complete rejection of the frequencies outside the pass region.
3. Transition from pass to rejection regions with as short a frequency interval as possible (sides of attenuation curve very steep, see Fig. 2).

High-class filters can only be built up from good quality components, i. e. coils and condensers with small loss angles and large time stability factors. Since suitable coils could not be found on the market, the Company took up the manufacture of moulded coil-cores of powdered iron¹. As a result filters of first-rate quality are

¹ See page 331.

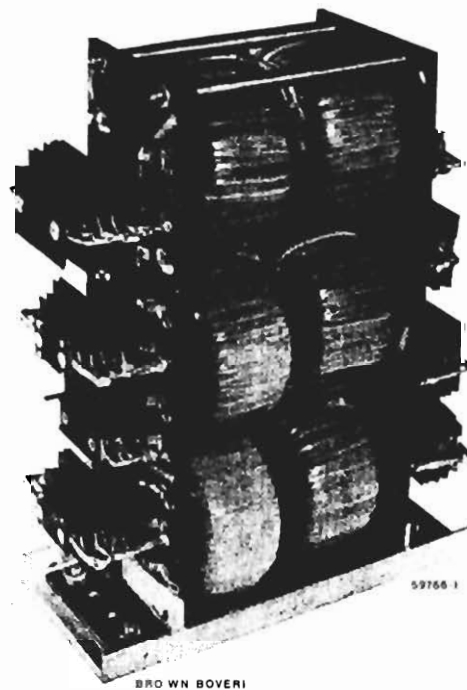

Fig. 1. — Band-pass filter for 2800–3200 cycle range.

Dimensions 11 × 17 × 5 cm. Such filters are built up from coils with Brown Boveri powdered-iron cores ($\mu = 50$) and mica condensers. The attenuation curve in Fig. 2 testifies to their high quality.

impedance being slightly lower than the theoretical value, as well as to the inherent capacitance of the circuit.

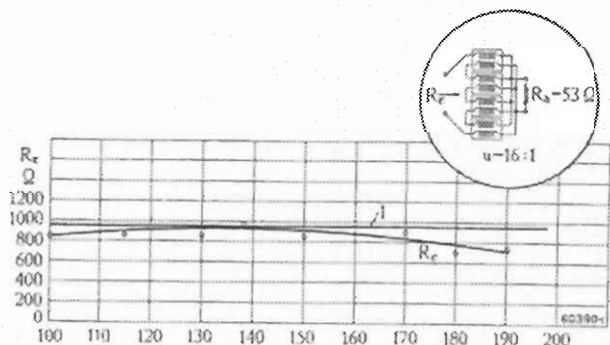

Fig. 4. — Theoretical and measured input impedance of a matching unit with a pure resistive load.

The matching unit comprises four double-wire coils in series-parallel connection. A surge impedance of 240 Ω was computed from the coil data and the measurements in Fig. 3, whence, assuming a pure resistive load of 60 Ω, the theoretical value of the input impedance is 960 Ω. The measured values of the input impedance are somewhat lower owing to the load impedance having been somewhat lower than theoretically assumed.

Theoretical value of $R_d = Z_s$. Test points for $R_d = 53 \Omega$. Impedance transformation ratio 16:1.

The described method of matching is particularly suitable for application in the ultra-short-wave field, where it represents a big simplification compared

to conventional tuned matching devices. Fig. 5 shows the external appearance of an impedance transformer with four coils, employed as antenna coupler in a

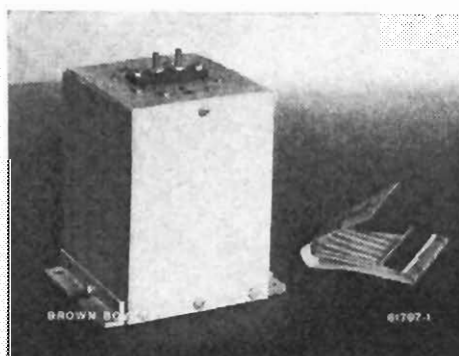

Fig. 5. — Matching unit with double-wire coils.

The system contains four double-wire coils for impedance transformation from 60 Ω to about 1000 Ω in the case of metre waves. With a power of over 100 W the losses are negligible.

medium-power transmitter. It requires little space and its losses are very low. This new component greatly simplifies the construction and operation of the equipment marketed by the Company.

(MS 564)

G. Guanella. (E. G. W.)

Electric Filters built up from Choke Coils and Condensers for Frequencies up to 60 kc.

Decimal Index 621.318.7

ELECTRIC filters are employed for the discrimination or segregation of individual frequencies or frequency bands. For frequencies over 60 kc crystal filters are now finding favour, whereas in the range below this figure coils and condensers are practically exclusively used as filter elements. The most commonly employed types are the low, high, and band-pass, so-called from the different positions of the pass and rejection regions in the frequency range. On the score of selectivity present-day demands are very exacting, that is:

1. In the pass frequency band as uniform a response to pass frequencies as possible with minimum attenuation.
2. Virtually complete rejection of the frequencies outside the pass region.
3. Transition from pass to rejection regions with as short a frequency interval as possible (sides of attenuation curve very steep, see Fig. 2).

High-class filters can only be built up from good quality components, i. e. coils and condensers with small loss angles and large time stability factors. Since suitable coils could not be found on the market, the Company took up the manufacture of moulded coil-cores of powdered iron¹. As a result filters of first-rate quality are

¹ See page 33.

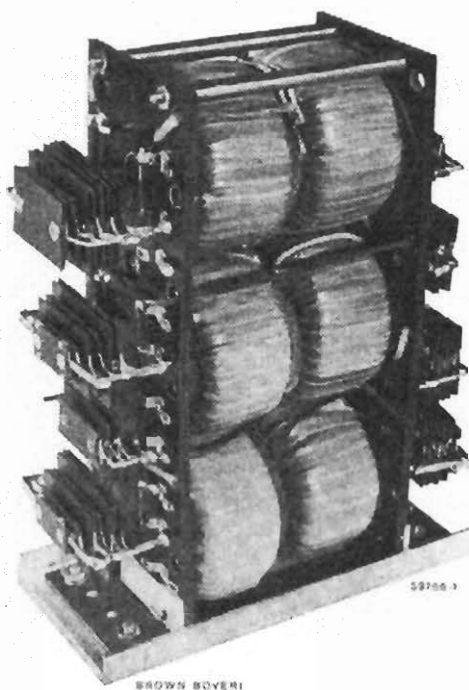

Fig. 1. — Band-pass filter for 2800-3200 cycle range.

Dimensions 11 × 17 × 5 cm. Such filters are built up from coils with Brown Boveri powdered-iron cores ($\mu = 50$) and mica condensers. The attenuation curve in Fig. 2 testifies to their high quality.