

### HPLC Troubleshooting Guide

How to identify, isolate, and correct the most common HPLC problems



*Although HPLC method development has been improved by advances in column technology and instrumentation, problems still arise. In this guide we offer you a systematic means of isolating, identifying, and correcting many typical problems.*

*The important segments of an HPLC system are the same, whether you use a modular system or a more sophisticated unit. Problems affecting overall system performance can arise in each component. Some common problems are discussed here. Solutions to these problems are presented in easy-to-use tables.*

E000648

#### CONTENTS:

Isolating HPLC Problems .....	2
How to Prevent Mobile Phase Problems .....	2
Isolating Pump Problems .....	3
Injector and Injection Solvents .....	3
Column Protection .....	3
Getting the Most from Your Analytical Column .....	3
Solving Detector Problems .....	4
Column Heater, Recorder .....	4
Keeping Accurate Records .....	4
Problem Index .....	4
HPLC Problems, Causes and Remedies .....	5-13
Restoring Your Column's Performance .....	14-15
Preventing and Solving Common Fitting Problems .....	16
A Selection of Column Protection Products .....	17-20

## Isolating HPLC Problems

In an HPLC system, problems can arise from many sources. First define the problem, then isolate the source.

Use Table 1 (page 5) to determine which component(s) may be causing the trouble. A process of elimination will usually enable you to pinpoint the specific cause and correct the problem.

## How to Prevent Mobile Phase Problems

Low sensitivity and rising baselines, noise, or spikes on the chromatogram can often be attributed to the mobile phase. Contaminants in the mobile phase are especially troublesome in gradient elution. The baseline may rise, and spurious peaks can appear as the level of the contaminated component increases.

Water is the most common source of contamination in reversed phase analyses. You should use only high purity distilled or deionized water when formulating mobile phases. However, several common deionizers introduce organic contaminants into the water. To remove these contaminants, pass the deionized water through activated charcoal or a preparative C18 column.

Use only *HPLC grade* solvents, salts, ion pair reagents, and base and acid modifiers. Cleaning lower quality solvents is time consuming, and trace levels of contaminants often remain. These trace contaminants can cause problems when you use a high sensitivity ultraviolet or fluorescence detector.

Because many aqueous buffers promote the growth of bacteria or algae, you should prepare these solutions fresh, and filter them (0.2  $\mu\text{m}$  or 0.45  $\mu\text{m}$  filter) before use. Filtering also will remove particles that could produce a noisy baseline, or plug the column. Prevent microorganism growth by adding about 100 ppm of sodium azide to aqueous buffers. Alternatively, these buffers may also be mixed with 20% or more of an organic solvent such as ethanol or acetonitrile.

To prevent bubbles in the system, degas the mobile phase. Generally an in-line degasser is a first choice, but sparging with helium can be an alternative if the mobile phase does not contain any volatile components.

Use ion pair reagents carefully. The optimum chain length and concentration of the reagent must be determined for each analysis. Concentrations can be as low as 0.2 mM, or as high as 150 mM, or more. In general, increasing the concentration or chain length increases retention times. High concentrations (>50%) of acetonitrile or some other organic solvents can precipitate ion pair reagents. Also, some salts of ion pair reagents are insoluble in water and will precipitate. Avoid this by using sodium-containing buffers in the presence of long chain sulfonic acids (e.g., sodium dodecyl sulfate), instead of potassium-containing buffers.

Volatile basic and acidic modifiers, such as triethylamine (TEA) and trifluoroacetic acid (TFA), are useful when you wish to recover a compound for further analysis. These modifiers also let you avoid problems associated with ion pair reagents. They can be added to the buffer at concentrations of 0.1 to 1.0% TEA or 0.01 to 0.15% TFA. Increasing the concentration may improve peak shape for certain compounds, but can alter retention times.

Recycling the mobile phase used for isocratic separations has become more popular in recent years as a means of reducing the cost of solvents, their disposal, and mobile phase preparation time. An apparatus such as the Supelco SRS-3000 or SRS-1000 Solvent Recovery System uses a microprocessor controlled switching valve to direct the solvent stream to waste when a peak is detected. When the baseline falls under the selected threshold, uncontaminated solvent is directed back to the solvent reservoir.

**Figure A. Components of an HPLC System**

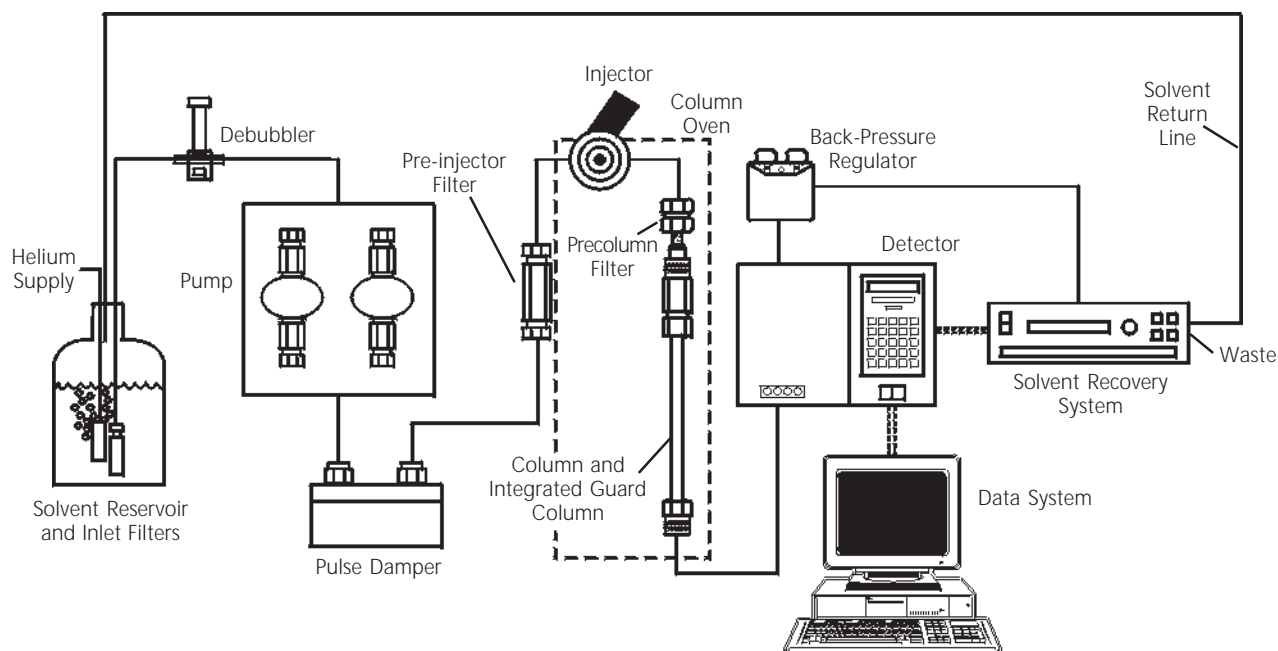

794-0746

## Isolating Pump Problems

The pump must deliver a constant flow of solvent to the column over a wide range of conditions. Modern HPLC pumps incorporate single or dual piston, syringe, or diaphragm pump designs.

Pumping system problems are usually easy to spot and correct. Some of the more common symptoms are erratic retention times, noisy baselines, or spikes in the chromatogram. Leaks at pump fittings or seals will result in poor chromatography. A sure sign of a leak is a buildup of salts at a pump connection. Buffer salts should be flushed from the system daily with fresh deionized water. To isolate and repair specific problems related to your apparatus, use the troubleshooting and maintenance sections of the operation manual. Pump seals require periodic replacement. You should perform regular maintenance rather than waiting for a problem to occur.

## Injector and Injection Solvents

The injector rapidly introduces the sample into the system with minimal disruption of the solvent flow. HPLC systems currently use variable loop, fixed loop, and syringe-type injectors. These are activated manually, pneumatically, or electrically.

Mechanical problems involving the injector (e.g., leaks, plugged capillary tubing, worn seals) are easy to spot and correct. Use a pre-column filter to prevent plugging of the column frit due to physical degradation of the injector seal. Other problems, such as irreproducible injections, are more difficult to solve.

Variable peak heights, split peaks, and broad peaks can be caused by incompletely filled sample loops, incompatibility of the injection solvent with the mobile phase, or poor sample solubility. Whenever possible, dissolve and inject samples in mobile phase. Otherwise, be sure the injection solvent is of lower eluting strength than the mobile phase (Table 3). Be aware that some autosamplers use separate syringe washing solutions. Make sure that the wash solution is compatible with and weaker than the mobile phase. This is especially important when switching between reversed and normal phase analyses.

## Column Protection

Although not an integral part of most equipment, mobile phase inlet filters, pre-injector and pre-column filters, and guard columns greatly reduce problems associated with complex separations. We recommend that all samples be filtered through 0.45  $\mu\text{m}$  or 0.2  $\mu\text{m}$  syringe filters. We strongly recommend the use of guard columns.

Filters and guard columns prevent particles and strongly retained compounds from accumulating on the analytical column. The useful life of these disposable products depends on mobile phase composition, sample purity, pH, etc. As these devices become contaminated or plugged with particles, pressure increases and peaks broaden or split. As an example, Figure B presents a clear case for the use of guard columns. For more about column protection, see the product pages of this guide and request Bulletin 781.

## Figure B. Supelguard Columns Prolong the Lifespan of Your Analytical Columns

column: SUPELCO SIL LC-PCN, 25 cm x 4.6 mm I.D., 5  $\mu\text{m}$  particles (with Supelguard LC-PCN guard column) (58378)  
mobile phase: 25:60:15, 0.01 M potassium phosphate (pH to 7 w/85% phosphoric acid):acetonitrile:methanol  
flow rate: 2 mL/min.  
temp.: 30 °C  
det.: UV, 215 nm  
injection: 100  $\mu\text{L}$  reconstituted SPE eluant (20 ng/mL each analyte and int. std. in serum)

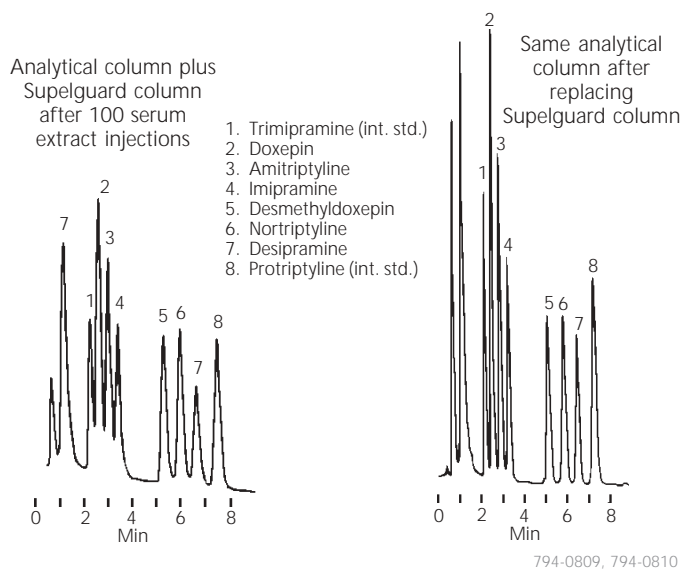

## Getting the Most from Your Analytical Column

Regardless of whether the column contains a bonded reversed or normal phase, ion exchange, affinity, hydrophobic interaction, size exclusion, or resin/silica based packing, the most common problem associated with analytical columns is deterioration. Symptoms of deterioration are poor peak shape, split peaks, shoulders, loss of resolution, decreased retention times, and high back pressure. These symptoms indicate contaminants have accumulated on the frit or column inlet, or there are voids, channels, or a depression in the packing bed.

Deterioration is more evident in higher efficiency columns. For example, a 3 micron packing retained by 0.5 micron frits is more susceptible to plugging than a 5 or 10 micron packing retained by 2 micron or larger frits. Proper column protection and sample preparation are essential to getting the most from each column.

Overloading a column can cause poor peak shapes and other problems. Column capacity depends on many factors, but typical values for total amounts of analytes on a column are:

Analytical column (25 cm x 4.6 mm)	<500 $\mu\text{g}$
Semi-preparative column (25 cm x 10 mm)	<100 mg
Preparative column (25 cm x 21 mm)	<500 mg

## Solving Detector Problems

Detector problems fall into two categories — electrical and mechanical/optical. For electrical problems, you should contact the instrument manufacturer. Mechanical or optical problems usually can be traced to the flow cell. Detector-related problems include leaks, air bubbles, and cell contamination. These usually produce spikes or baseline noise on the chromatograms or low sensitivity.

Some cells — especially those used in refractive index detectors — are sensitive to pressure. Flow rates or back pressures that exceed the manufacturer's recommendation will break the cell window. Old or defective lamps as well as incorrect detector rise time, gain, or attenuation will reduce sensitivity and peak height. Faulty or reversed cable connections can also be the source of problems.

## Column Heater, Recorder

These components seldom cause problems with the system. They will be discussed in the troubleshooting table (Table 1).

## Keeping Accurate Records

Most problems don't occur overnight, but develop gradually. Accurate record keeping, then, is vital to detecting and solving many problems.

Evaluate every column you receive, when you receive it and at regular intervals thereafter. By keeping a written history of column efficiency, mobile phases used, lamp current, pump performance, etc., you can monitor your system's performance.

Records also help prevent mistakes, such as introducing water into a silica column, or precipitating buffer in the system by adding too much organic solvent. Many analysts modify their HPLC systems in some way. Reliable records are the best way to ensure that a modification does not introduce problems. For problems relating to pumps, detectors, automatic samplers, and data systems, consult your instrument manual's troubleshooting guide.





## Problem Index

Problem	Problem No.
Baseline	
drift	12
noise, irregular	14
noise, regular	13
Column back pressure	
higher than usual	4
lower than usual	3
Ghost peaks	19
Peak shapes, incorrect	
broad	15
fronting	10
rounded	11
split	7
tailing	8, 9
Peaks	
height change	16
missing	2
negative	18
no peaks	1
unresolved	6
Retention times, variable	5
Selectivity change	17

### Trademarks

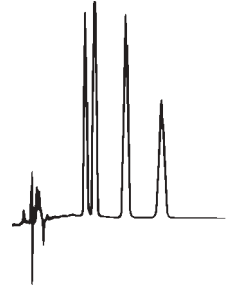
FPLC — Amersham Pharmacia Biotech  
Iso-Disc, Pelliguard, Sigma-Aldrich, Supelco,  
SUPELCOSIL, Supelguard, Trizma — Sigma-Aldrich Co.  
LO-Pulse — Scientific Systems, Inc.  
Rheodyne — Rheodyne, Inc.  
Swagelok — Crawford Fitting Co.  
Teflon — E.I. du Pont de Nemours & Co., Inc.

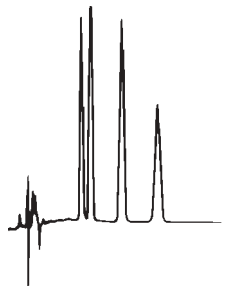
**Table 1. HPLC Problems, Probable Causes, and Remedies**

Problem	Probable Cause	Remedy/Comments
<b>Problem No. 1: No Peaks/Very Small Peaks</b>		
<p>Normal</p>  <p style="text-align: right;">794-0747</p>	<ol style="list-style-type: none"> <li>1. Detector lamp off.</li> <li>2. Loose/broken wire between detector and integrator or recorder.</li> <li>3. No mobile phase flow.</li> <li>4. No sample/deteriorated sample/ wrong sample.</li>   <li>5. Settings too high on detector or recorder.</li> </ol>	<ol style="list-style-type: none"> <li>1. Turn lamp on.</li> <li>2. Check electrical connections and cables.</li> <li>3. See "No Flow" (Problem No. 2).</li> <li>4. Be sure automatic sampler vials have sufficient liquid and no air bubbles in the sample. Evaluate system performance with fresh standard to confirm sample as source of problem.</li> <li>5. Check attenuation or gain settings. Check lamp status. Auto-zero if necessary.</li> </ol>
<p>Problem</p>  <p style="text-align: right;">794-0748</p>		
<p>Problem</p>  <p style="text-align: right;">794-0749</p>		
<b>Problem No. 2: No Flow</b>		
<p>Normal</p>  <p style="text-align: right;">794-0747</p>	<ol style="list-style-type: none"> <li>1. Pump off.</li> <li>2. Flow interrupted/obstructed.</li>   <li>3. Leak.</li>   <li>4. Air trapped in pump head. (Revealed by pressure fluctuations.)</li> </ol>	<ol style="list-style-type: none"> <li>1. Start pump.</li> <li>2. Check mobile phase level in reservoir(s). Check flow throughout system. Examine sample loop for obstruction or air lock. Make sure mobile phase components are miscible and mobile phase is properly degassed.</li> <li>3. Check system for loose fittings. Check pump for leaks, salt buildup, unusual noises. Change pump seals if necessary.</li> <li>4. Disconnect tubing at guard column (if present) or analytical column inlet. Check for flow. Purge pump at high flow rate (e.g., 5-10 mL/min.), prime system if necessary. (Prime each pump head separately.) If system has check valve, loosen valve to allow air to escape. If problem persists, flush system with 100% methanol or isopropanol. If problem still persists, contact system manufacturer.</li> </ol>
<p>Problem</p>  <p style="text-align: right;">794-0748</p>		

Problem	Probable Cause	Remedy/Comments
<b>Problem No. 3: No Pressure/Pressure Lower Than Usual</b>		

Normal

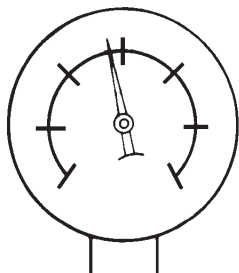

794-0750

1. Leak.
2. Mobile phase flow interrupted/ obstructed.
3. Air trapped in pump head. (Revealed by pressure fluctuations.)

1. Check system for loose fittings. Check pump for leaks, salt buildup, unusual noises. Change pump seals if necessary.
2. Check mobile phase level in reservoir(s). Check flow throughout system. Examine sample loop for obstruction or air lock. Make sure mobile phase components are miscible and mobile phase is properly degassed.
3. Disconnect tubing at guard column (if present) or analytical column inlet. Check for flow. Purge pump at high flow rate (e.g., 10 mL/min.), prime system if necessary. (Prime each pump head separately.) If system has check valve, loosen valve to allow air to escape.

Problem

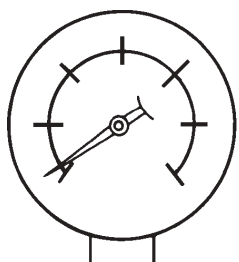

794-0751

4. Leak at column inlet end fitting.
5. Air trapped elsewhere in system.
6. Worn pump seal causing leaks around pump head.
7. Faulty check valve.
8. Faulty pump seals.

4. Reconnect column and pump solvent at double the flow rate. If pressure is still low, check for leaks at inlet fitting or column end fitting.
5. Disconnect guard and analytical column and purge system. Reconnect column(s). If problem persists, flush system with 100% methanol or isopropanol.
6. Replace seal. If problem persists, replace piston and seal.
7. Rebuild or replace valve.
8. Replace seals.

<b>Problem No. 4: Pressure Higher Than Usual</b>		
--	--	--

Normal

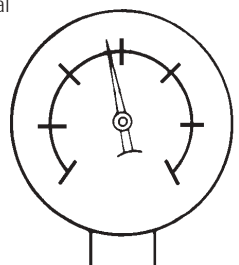

794-0750

1. Problem in pump, injector, in-line filter, or tubing.
2. Obstructed guard column or analytical column.

1. Remove guard column and analytical column from system. Replace with unions and 0.010" I.D. or larger tubing to reconnect injector to detector. Run pump at 2-5 mL/min. If pressure is minimal, see Cause 2. If not, isolate cause by systematically eliminating system components, starting with detector, then in-line filter, and working back to pump. Replace filter in pump if present.
2. Remove guard column (if present) and check pressure. Replace guard column if necessary. If analytical column is obstructed, reverse and flush the column, while disconnected from the detector (page 14). If problem persists, column may be clogged with strongly retained contaminants. Use appropriate restoration procedure (Table 2, page 14). If problem still persists, change inlet frit (page 16) or replace column.

Problem

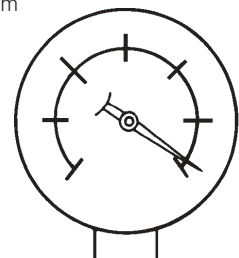

794-0752

Problem	Probable Cause	Remedy/Comments
<b>Problem No. 5: Variable Retention Times</b>		

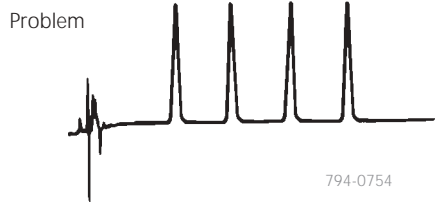
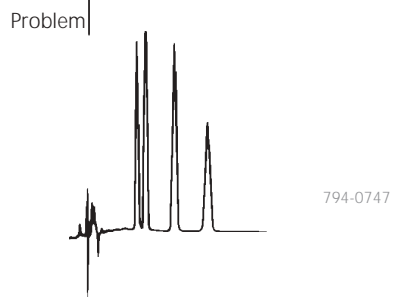
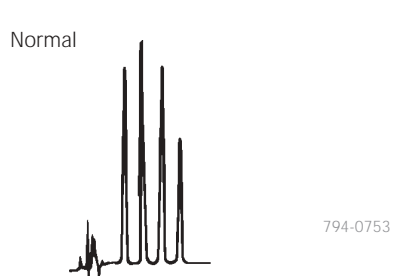

1. Leak.
2. Change in mobile phase composition. (Small changes can lead to large changes in retention times.)
3. Air trapped in pump. (Retention times increase and decrease at random times.)
4. Column temperature fluctuations (especially evident in ion exchange systems).
5. Column overloading. (Retention times usually decrease as mass of solute injected on column exceeds column capacity.)
6. Sample solvent incompatible with mobile phase.
7. Column problem. (Not a common cause of erratic retention. As a column ages, retention times *gradually* decrease.)

1. Check system for loose fittings. Check pump for leaks, salt buildup, unusual noises. Change pump seals if necessary.
2. Check make-up of mobile phase. If mobile phase is machine mixed using proportioning values, hand mix and supply from one reservoir.
3. Purge air from pump head or check valves. Change pump seals if necessary. Be sure mobile phase is degassed.
4. Use reliable column oven. (Note: higher column temperatures increase column efficiency. For optimum results, heat eluant before introducing it onto column.)
5. Inject smaller volume (e.g., 10  $\mu$ L vs. 100  $\mu$ L) or inject the same volume after 1:10 or 1:100 dilutions of sample.
6. Adjust solvent. Whenever possible, inject samples in mobile phase.
7. Substitute new column of same type to confirm column as cause. Discard old column if restoration procedures fail (see page 14).

<b>Problem No. 6: Loss of Resolution</b>		
--	--	--

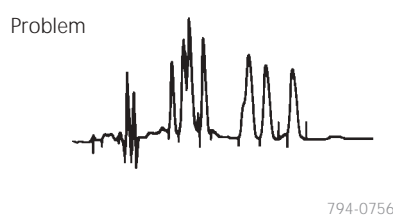
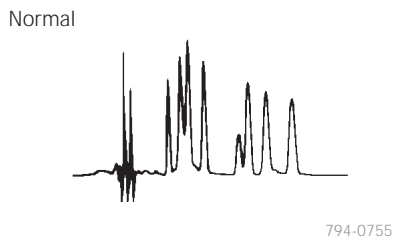

1. Mobile phase contaminated/deteriorated (causing retention times and/or selectivity to change).
2. Obstructed guard or analytical column.

1. Prepare fresh mobile phase (page 2).
2. Remove guard column (if present) and attempt analysis. Replace guard column if necessary. If analytical column is obstructed, reverse and flush (page 14). If problem persists, column may be clogged with strongly retained contaminants. Use appropriate restoration procedure (Table 2, page 14). If problem still persists, change inlet frit (page 16) or replace column.

Problem	Probable Cause	Remedy/Comments
---------	----------------	-----------------

**Problem No. 7: Split Peaks**

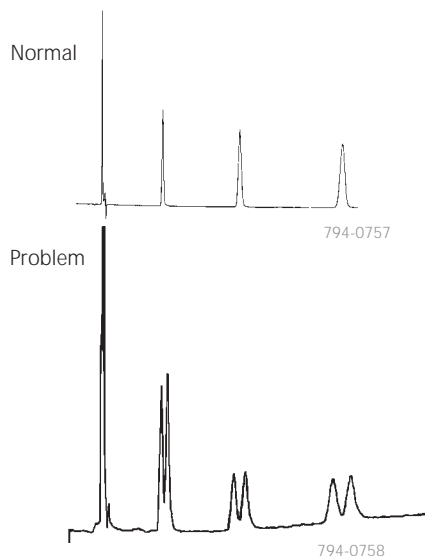

1. Contamination on guard or analytical column inlet.

1. Remove guard column (if present) and attempt analysis. Replace guard column if necessary. If analytical column is obstructed, reverse and flush (page 14). If problem persists, column may be clogged with strongly retained contaminants. Use appropriate restoration procedure (Table 2, page 14). If problem still persists, inlet frit is probably (partially) plugged. Change frit (page 16) or replace column.

2. Partially blocked frit.  
3. Small (uneven) void at column inlet.

2. Replace frit (see above)  
3. Repack top of column with pellicular particles of same bonded phase functionality. Continue using the column in reverse flow direction.  
4. Adjust solvent. Whenever possible, inject samples in mobile phase.

4. Sample solvent incompatible with mobile phase.

**Problem No. 8: Peaks Tail on Initial and Later Injections**

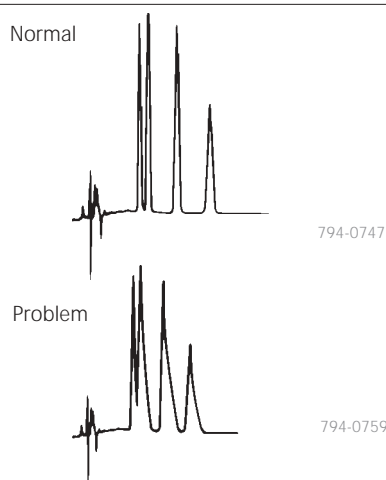

1. Sample reacting with active sites.

1. First check column performance with standard column test mixture. If results for test mix are good, add ion pair reagent or competing base or acid modifier (page 2).

2. Wrong mobile phase pH.

2. Adjust pH. For basic compounds, lower pH usually provides more symmetric peaks.

3. Wrong column type.

3. Try another column type (e.g., deactivated column for basic compounds).

4. Small (uneven) void at column inlet.  
5. Wrong injection solvent.

4. See Problem No. 7.  
5. Peaks can tail when sample is injected in stronger solvent than mobile phase. Dissolve sample in mobile phase.

**Problem No. 9: Tailing Peaks**

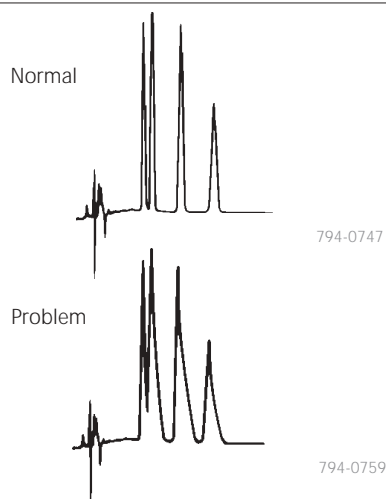

1. Guard or analytical column contaminated/worn out.

1. Remove guard column (if present) and attempt analysis. Replace guard column if necessary. If analytical column is source of problem, use appropriate restoration procedure (Table 2, page 14). If problem persists, replace column.

2. Mobile phase contaminated/deteriorated.

2. Check make-up of mobile phase (page 2).

3. Interfering components in sample.

3. Check column performance with standards.

Problem	Probable Cause	Remedy/Comments
<b>Problem No. 10: Fronting Peaks</b>		

Normal



794-0760

1. Column overloaded.
2. Sample solvent incompatible with mobile phase.
3. Shoulder or gradual baseline rise before a main peak may be another sample component.

1. Inject smaller volume (e.g., 10  $\mu\text{L}$  vs. 100  $\mu\text{L}$ ). Dilute the sample 1:10 or 1:100 fold in case of mass overload.
2. Adjust solvent. Whenever possible, inject samples in mobile phase. Flush polar bonded phase column with 50 column volumes HPLC grade ethyl acetate at 2-3 times the standard flow rate, then with intermediate polarity solvent prior to analysis.
3. Increase efficiency or change selectivity of system to improve resolution. Try another column type if necessary (e.g., switch from nonpolar C18 to polar cyano phase).

Problem

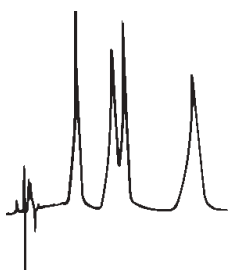

794-0761

<b>Problem No. 11: Rounded Peaks</b>		
--------------------------------------	--	--

Normal

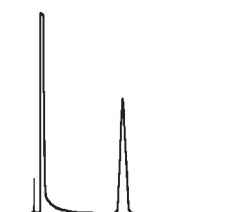

794-0762

1. Detector operating outside linear dynamic range.
2. Recorder gain set too low.
3. Column overloaded.
4. Sample-column interaction.

1. Reduce sample volume and/or concentration.
2. Adjust gain.
3. Inject smaller volume (e.g., 10  $\mu\text{L}$  vs. 100  $\mu\text{L}$ ) or 1:10 or 1:100 dilution of sample.
4. Change buffer strength, pH, or mobile phase composition. If necessary, raise column temperature or change column type. (Analysis of solute structure may help predict interaction.)
5. Reduce settings to lowest values or values at which no further improvements are seen.

Problem



794-0763

Problem	Probable Cause	Remedy/Comments
<b>Problem No. 12: Baseline Drift</b>		

Normal



Problem



1. Column temperature fluctuation. (Even small changes cause cyclic baseline rise and fall. Most often affects refractive index and conductivity detectors, UV detectors at high sensitivity or in indirect photometric mode.)
2. Nonhomogeneous mobile phase. (Drift usually to higher absorbance, rather than cyclic pattern from temperature fluctuation.)
3. Contaminant or air buildup in detector cell.
4. Plugged outlet line after detector. (High pressure cracks cell window, producing noisy baseline.)
5. Mobile phase mixing problem or change in flow rate.
6. Slow column equilibration, especially when changing mobile phase.
7. Mobile phase contaminated, deteriorated, or not prepared from high quality chemicals.
8. Strongly retained materials in sample (high  $k'$ ) can elute as very broad peaks and appear to be a rising baseline. (Gradient analyses can aggravate problem.)
9. Detector (UV) not set at absorbance maximum but at slope of curve.

1. Control column and mobile phase temperature, use heat exchanger before detector.
2. Use HPLC grade solvents, high purity salts, and additives. Degas mobile phase before use, sparge with helium during use.
3. Flush cell with methanol or other strong solvent. If necessary, clean cell with 1N  $\text{HNO}_3$  (never with HCl and never use nitric acid with PEEK tubing or fittings.)
4. Unplug or replace line. Refer to detector manual to replace window.
5. Correct composition/flow rate. To avoid problem, routinely monitor composition and flow rate.
6. Flush column with intermediate strength solvent, run 10-20 column volumes of new mobile phase through column before analysis.
7. Check make-up of mobile phase (page 2).
8. Use guard column. If necessary, flush column with strong solvent between injections or periodically during analysis.
9. Change wavelength to UV absorbance maximum.

<b>Problem No. 13: Baseline Noise (regular)</b>		
---	--	--

Normal



Problem



1. Air in mobile phase, detector cell, or pump.
2. Pump pulsations.
3. Incomplete mobile phase mixing.
4. Temperature effect (column at high temperature, detector unheated).
5. Other electronic equipment on same line.
6. Leak.

1. Degas mobile phase. Flush system to remove air from detector cell or pump.
2. Incorporate pulse damper into system.
3. Mix mobile phase by hand or use less viscous solvent.
4. Reduce differential or add heat exchanger.
5. Isolate LC, detector, recorder to determine if source of problem is external. Correct as necessary.
6. Check system for loose fittings. Check pump for leaks, salt buildup, unusual noises. Change pump seals if necessary.

Problem	Probable Cause	Remedy/Comments
<b>Problem No. 14: Baseline Noise (irregular)</b>		

Normal



Problem



- |   |   |
|---|---|
| <ol style="list-style-type: none"> <li>1. Leak.</li> <li>2. Mobile phase contaminated, deteriorated, or prepared from low quality materials.</li> <li>3. Detector/recorder electronics.</li> <li>4. Air trapped in system.</li> <li>5. Air bubbles in detector.</li> <li>6. Detector cell contaminated. (Even small amounts of contaminants can cause noise.)</li> <li>7. Weak detector lamp.</li> <li>8. Column leaking silica or packing material.</li> </ol> | <ol style="list-style-type: none"> <li>1. Check system for loose fittings. Check pump for leaks, salt buildup, unusual noises. Change pump seals if necessary.</li> <li>2. Check make-up of mobile phase. (page 2).</li> <li>3. Isolate detector and recorder electronically. Refer to instruction manual to correct problem.</li> <li>4. Flush system with strong solvent.</li> <li>5. Purge detector. Install back-pressure regulator after detector. Check the instrument manual, particularly for RI detectors (excessive backpressure can cause the flow cell to crack).</li> <li>6. Clean cell.</li> <li>7. Replace lamp.</li> <li>8. Replace column and clean system.</li> </ol> |
|---|---|

<b>Problem No. 15: Broad Peaks</b>		
------------------------------------	--	--

Normal

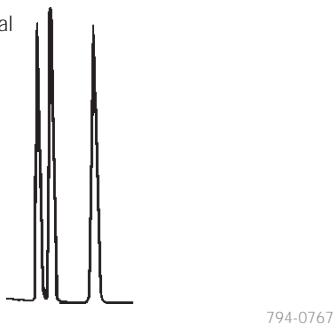

Problem

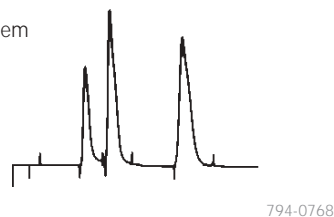

- |  |  |
|--|--|
| <ol style="list-style-type: none"> <li>1. Mobile phase composition changed.</li> <li>2. Mobile phase flow rate too low.</li> <li>3. Leak (especially between column and detector).</li> <li>4. Detector settings incorrect.</li> <li>5. Extra-column effects:               <ol style="list-style-type: none"> <li>a. Column overloaded</li> <li>b. Detector response time or cell volume too large.</li> <li>c. Tubing between column and detector too long or I.D. too large.</li> <li>d. Recorder response time too high.</li> </ol> </li> <li>6. Buffer concentration too low.</li> <li>7. Guard column contaminated/worn out.</li> <li>8. Column contaminated/worn out.</li> <li>9. Void at column inlet.</li> <li>10. Peak represents two or more poorly resolved compounds.</li> <li>11. Column temperature too low.</li> </ol> | <ol style="list-style-type: none"> <li>1. Prepare new mobile phase.</li> <li>2. Adjust flow rate.</li> <li>3. Check system for loose fittings. Check pump for leaks, salt buildup, and unusual noises. Change pump seals if necessary.</li> <li>4. Adjust settings.</li> <li>5.               <ol style="list-style-type: none"> <li>a. Inject smaller volume (e.g., 10 <math>\mu</math>L vs. 100 <math>\mu</math>L) or 1:10 and 1:100 dilutions of sample.</li> <li>b. Reduce response time or use smaller cell.</li> <li>c. Use as short a piece of 0.007-0.010" I.D. tubing as practical.</li> <li>d. Reduce response time.</li> </ol> </li> <li>6. Increase concentration.</li> <li>7. Replace guard column.</li> <li>8. Replace column with new one of same type. If new column does not provide narrow peaks, flush old column (Table 2, page 14), then retest.</li> <li>9. Replace column or open inlet end and fill void (page 16).</li> <li>10. Change column type to improve separation.</li> <li>11. Increase temperature. Do not exceed 75 °C unless higher temperatures are acceptable to column manufacturer.</li> </ol> |
|--|--|

Problem	Probable Cause	Remedy/Comments
<b>Problem No. 16: Change in Peak Height (one or more peaks)</b>		

Normal

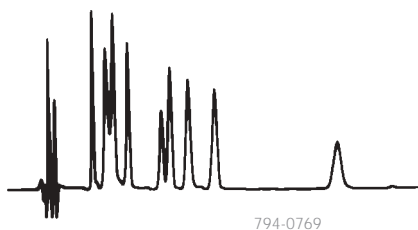

1. One or more sample components deteriorated or column activity changed.
2. Leak, especially between injection port and column inlet. (Retention also would change.)
3. Inconsistent sample volume.

1. Use fresh sample or standard to confirm sample as source of problem. If some or all peaks are still smaller than expected, replace column. If new column improves analysis, try to restore the old column, following appropriate procedure (Table 2, page 14). If performance does not improve, discard old column.
2. Check system for loose fittings. Check pump for leaks, salt buildup, unusual noises. Change pump seals if necessary.
3. Be sure samples are consistent. For fixed volume sample loop, use 2-3 times loop volume to ensure loop is completely filled. Be sure automatic sampler vials contain sufficient sample and no air bubbles. Check syringe-type injectors for air. In systems with wash or flushing step, be sure wash solution does not precipitate sample components.
4. Check settings.
5. Replace lamp.
6. Clean cell.

Problem

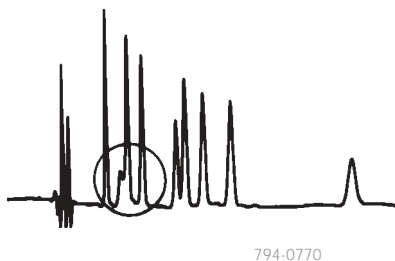

4. Detector or recorder setting changed.
5. Weak detector lamp.
6. Contamination in detector cell.

<b>Problem No. 17: Change in Selectivity</b>		
--	--	--

Normal

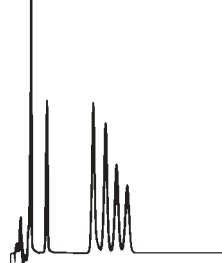

1. Increase or decrease solvent ionic strength, pH, or additive concentration (especially affects ionic solutes).
2. Column changed, new column has different selectivity from that of old column.
3. Sample injected in incorrect solvent or excessive amount (100-200  $\mu$ L) of strong solvent.
4. Column temperature change.

1. Check make-up of mobile phase (page 2).
2. Confirm identity of column packing. For reproducible analyses, use same column type. Establish whether change took place gradually. If so, bonded phase may have stripped. Column activity may have changed, or column may be contaminated.
3. Adjust solvent. Whenever possible, inject sample in mobile phase.
4. Adjust temperature. If needed, use column oven to maintain constant temperature.

Problem

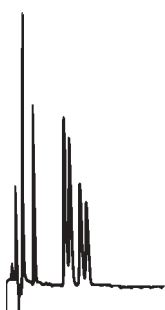

Problem	Probable Cause	Remedy/Comments
---------	----------------	-----------------

**Problem No. 18: Negative Peak(s)**

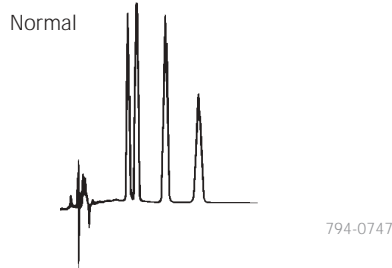

1. Recorder leads reversed.
2. Refractive index of solute less than that of mobile phase (RI detector).
3. Sample solvent and mobile phase differ greatly in composition (vacancy peaks).
4. Mobile phase more absorptive than sample components to UV wavelength.

1. Check polarity.
2. Use mobile phase with lower refractive index, or reverse recorder leads.
3. Adjust or change sample solvent. Dilute sample in mobile phase whenever possible.
4. a. Change polarity when using indirect UV detection, or  
b. Change UV wavelength or use mobile phase that does not adsorb chosen wavelength.

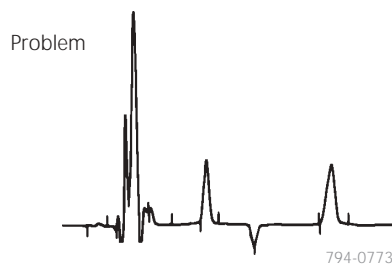

**Problem No. 19: Ghost Peak**

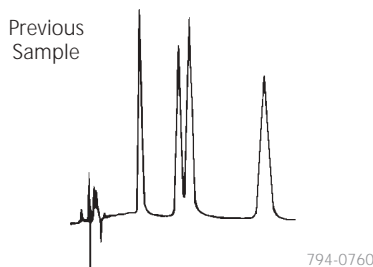

1. Contamination in injector or column.
2. Late eluting peak (usually broad) present in sample.

1. Flush injector between analyses (a good routine practice). If necessary, run strong solvent through column to remove late eluters. Include final wash step in gradient analyses, to remove strongly retained compounds.
2. a. Check sample preparation.  
b. Include (step) gradient to quickly elute component.

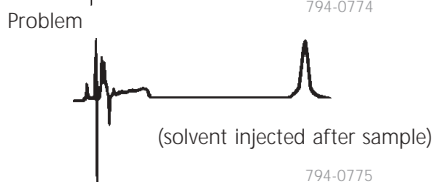
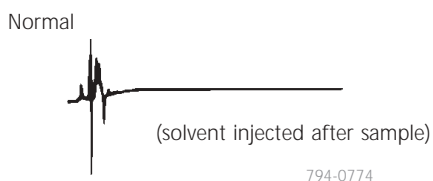

**Further Recommendations**

We also suggest referring to the maintenance and troubleshooting sections of your instrument manual. Modern HPLC systems often have self-diagnostic capabilities that help isolate the problem area within the instrument. For persistent problems relating to the column or your particular analysis, please contact Supelco's Technical Service Department.

The remaining pages in this guide include procedures for restoring column performance following loss in resolution, retention, or

selectivity (pages 14-15), suggestions on how to prevent and solve column hardware problems (page 16), and a selection of column protection products from the Supelco catalog. Please refer to our catalog for our complete line of accessories that prolong column life and, in general, simplify or improve your HPLC or FPLC® analysis.

Finally, phone us to request additional literature about our HPLC and FPLC products, or use our ChromFax service for immediate access to all our free technical literature.

## Restoring Your Column's Performance

The following procedures should rejuvenate a column whose performance has deteriorated due to sample contamination.

Disconnect and reverse the column. Connect it to the pump, but not the detector. Follow the appropriate flushing procedure in this table, using a flow rate that results in column back pressure of 1500-4500 psi, but never higher than the maximum recommended pressure in the manufacturer's instruction manual. If you have a SUPELCO<sup>®</sup>SIL column, analyze with the test mix and the conditions listed on the data sheet. Efficiency, symmetry, and capacity should be within 10-15% of the test sheet values. If not, repack the column inlet (page 16) or replace the column.

**Table 2. Column Restoration Procedures**

### Silica Column

Flush with the following:

1. 50 mL hexane
2. 50 mL methylene chloride
3. 50 mL 2-propanol
4. 50 mL methanol
5. 25 mL methylene chloride
6. 25 mL mobile phase

Evaluate column performance according to conditions specified by the manufacturer.

Note: See also the Silica Column Regeneration Solution listed on page 15 for rejuvenating a deactivated silica column.

### Silica-Based Reversed Phase Column (alkyl<sup>®</sup>, phenyl, or diphenyl column, SUPELCO<sup>®</sup>SIL LC-PAH column)

#### A. Water Soluble Samples

Flush with the following:

1. Flush with warm (60 °C) distilled water
2. 50 mL methanol
3. 50 mL acetonitrile
4. 30 mL tetrahydrofuran
5. 25 mL methanol
6. 25 mL mobile phase

Evaluate column performance.

#### B. Samples Not Soluble in Water

Flush with the following:

1. 50 mL 2-propanol
2. 50 mL tetrahydrofuran
3. 50 mL methylene chloride
4. 50 mL hexane
5. 25 mL isopropanol
6. 25 mL mobile phase

Evaluate column performance.

### Polar-Bonded Phase Column (amino, cyano, or diol column or Pirkle-type chiral columns).

For a column used in the reversed phase mode (e.g., organic solvent/aqueous buffer mobile phase), follow the same cleanup procedure as for silica-based reversed phase columns. For a column used with nonaqueous mobile phases, use the following scheme:

Flush with the following:

1. 50 mL chloroform
2. 50 mL methanol
3. 50 mL acetonitrile
4. 25 mL methylene chloride
5. 25 mL methanol
6. 25 mL mobile phase

Evaluate column performance.

**Note:** Volumes listed in Table 2 are for 25 cm x 4.6 mm I.D. columns, which have a column volume of 4.15 mL. When restoring a 4.6 mm I.D. column shorter or longer than 25 cm, multiply all volumes in Table 2 by the ratio of the column length to 25 (e.g., for a 15 cm column: 15/25, or 0.6 times the volumes in Table 2). When restoring a column of internal diameter other than 4.6 mm, multiply all volumes in Table 2 by the ratio of the square of the column I.D. to (4.6)<sup>2</sup> (e.g., for a 3.2 mm I.D. column: (3.2)<sup>2</sup>/(4.6)<sup>2</sup> = 10.24/21.16 = 0.48 times the values in Table 2).

### SUPELCO<sup>®</sup>SIL LC-PCN Column

#### A. To Remove Protein

Flush with 10 column volumes of acetonitrile:water, 50:50, containing 0.1% trifluoroacetic acid.

#### B. To Remove TCA

Flush with 10 column volumes of distilled water (adjust pH to 2.5 with H<sub>3</sub>PO<sub>4</sub>), then with 10 column volumes each of:

1. water (to remove salts)
2. methanol (to remove water)
3. methanol/methylene chloride, 50:50 (a general clean-up solution)
4. methanol

If column performance still is not acceptable, prepare the mobile phase buffer at 10X the concentration used for the analysis and recycle through the column overnight. \* Reequilibrate the column with mobile phase at the normal buffer concentration and reevaluate.

\*Use caution: with some buffer types and/or concentrations a 10-fold increase in concentration can cause precipitation.

### Silica-Based Ion Exchange Columns (strong or weak anion or cation exchange)

Most analyses involving ion exchange systems use ionic mobile phases. Compounds that may affect column performance are usually insoluble or only slightly soluble in water. The following procedure should be sufficient to remove these compounds.

Flush with the following:

1. 50 mL hot (40-60 °) distilled water
2. 50 mL methanol
3. 50 mL acetonitrile
4. 25 mL methylene chloride
5. 25 mL methanol
6. 25 mL mobile phase

Evaluate column performance.

### Silica-Based Columns for RPLC of Proteins and Peptides

Follow the protocol for silica-based reversed phase columns.

Alternatively, make one or more 100 µL injections of trifluoroethanol (determine the number of injections by evaluating column performance after each injection).

Evaluate column performance.

•C8, C18, etc.



## Preventing and Solving Common Hardware Problems

### Preventing Leaks

Leaks are a common problem in HPLC analyses. To minimize leaks in your system, avoid interchanging hardware and fittings from different manufacturers. Incompatible fittings can be forced to fit initially, but the separation may show problems and repeated connections may eventually cause the fitting to leak. If interchanging is absolutely necessary, use appropriate adapters and check all connections for leaks before proceeding.

Highly concentrated salts (>0.2 M) and caustic mobile phases can reduce pump seal efficiency. The lifetime of injector rotor seals also depends on mobile phase conditions, particularly operation at high pH. In some cases, prolonged use of ion pair reagents has a lubricating effect on pump pistons that may produce small leaks at the seal. Some seals do not perform well with certain solvents. Before using a pump under adverse conditions, read the instrument manufacturer's specifications. To replace seals, refer to the maintenance section of the pump manual.

### Unclogging the Column Frit

A clogged column frit is another common HPLC problem. To minimize this problem from the start, use a precolumn filter and guard column.

To clean the inlet, first disconnect and reverse the column. Connect it to the pump (but *not* to the detector), and pump solvent through at twice the standard flow rate. About 5-10 column volumes of solvent should be sufficient to dislodge small amounts of particulate material on the inlet frit. Evaluate the performance of the cleaned column using a standard test mixture.

### Replacing a Frit at the Column Inlet

Sometimes neither solvent flushing (see above) nor restoration procedures (see Table 2) restore a column's performance. If you've

isolated the column as the problem source, and other restorative procedures have failed, a void in the packing or a persistent obstruction on the inlet frit may exist.

*As a last resort*, open the *inlet* end of the column. **Caution:** opening the inlet end, and more so opening the outlet end, can permanently damage the packing bed. Before opening columns, consult the manufacturer's literature. (Never open either end of a *resin-filled* column).

### Use the following procedure to open a column.

1. Disconnect the column from the system. To prevent the packing from oozing out of the column, perform subsequent steps as quickly as possible.
2. Using a vise and wrench, or two wrenches, carefully remove the inlet end fitting (see Figure D). If the frit remains in the fitting, dislodge it by tapping the fitting on a hard surface. If the frit stays on the column, slide it off rather than lift it off. This will help preserve the integrity of the packing bed.

Modular columns may require a special tool (e.g., Cat. No. 55216), to remove the frit cap.

3. Examine the old frit. Compression of the frit against the stainless steel tubing will leave a ring around the edge on the column side of a properly seated frit. No ring can mean the ferrule is seated too near the tubing end. The resulting loose connection can leak silica or act as a mixing chamber.
4. Examine the packing bed. If it is depressed or fractured, you need a new column.
5. Replace the frit.
6. Replace the end fitting. Screw it down fingertight, then tighten 1/4 turn with a wrench.

**Figure D. Typical HPLC Column Designs**

#### A. Column with Conventional Endfittings

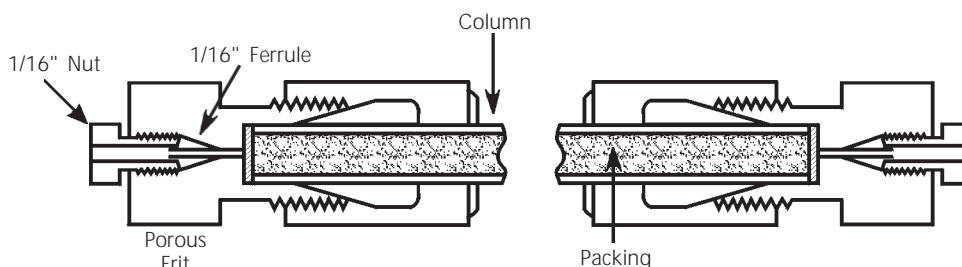

#### B. Modular Column with Reusable Endfittings

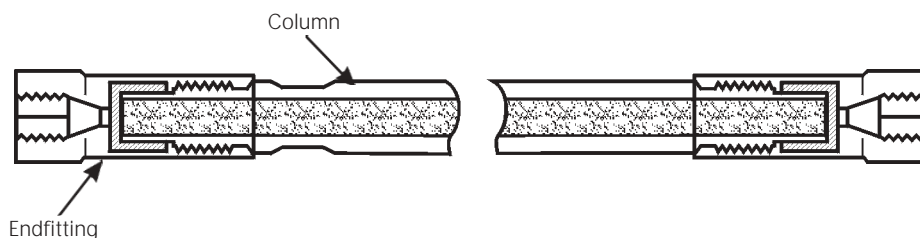

## A Selection of Column Protection Products

### Supelco™ Mobile Phase Filtration Apparatus (connect to aspiration line)

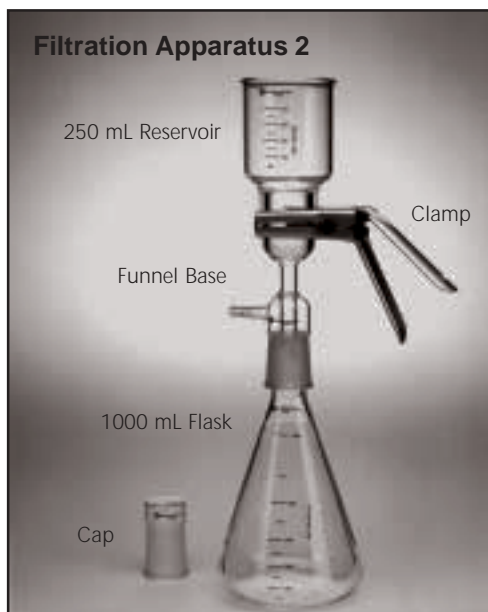

910-0113

Protect your instrument and columns by removing particles and gases from solvents and other mobile phase components. Nylon 66 membrane filters are compatible with all solvents commonly used in HPLC.

**Filtration Apparatus 1** (connects to 1000 mL sidearm flask)  
Includes 250 mL glass reservoir, funnel base and stopper, clamp, stainless steel holder and screen, 10 Teflon gaskets, 50 Nylon 66 filters (47 mm, 0.45 µm pores).

**Filtration Apparatus 2** (connects to aspiration line)  
Includes 250 mL glass reservoir, 34/45 tapered funnel base, 34/45 tapered 1000 mL flask and glass cap, clamp, stainless steel holder and screen, 10 Teflon gaskets, 50 Nylon 66 filters (47 mm, 0.45 µm pores).

Description	Cat. No.
<b>Supelco Mobile Phase Filtration Apparatus</b>	
Filtration Apparatus 1	58061
Filtration Apparatus 2	58062-U
<b>Replacement Glass Parts</b>	
For Filtration Apparatus 1	
Reservoir, 250 mL	58063
Reservoir, 500 mL	58074
Funnel Base and Stopper	58064
For Filtration Apparatus 2	
Tapered Funnel Base	58068
Tapered Flask, 1000 mL for Apparatus 2	58070-U
Tapered Flask, 2000 mL for Apparatus 2	58075
Cap for Flask for Apparatus 2	58071
<b>Replacement Filter Parts for Both Apparatus</b>	
Filter Holder and Screen, SS	58065
Gaskets, Teflon (pk. of 10)	58066
Filter, Nylon 66, 47 mm (pk. of 50)	
0.45 µm pores	58067
0.20 µm pores	58060-U
Clamp, Spring Action	58053

### Supelco Mobile Phase Degassing System

- 4 Channel
- 0-5 mL/min. Flow Range
- Validation output satisfies system compliance
- Smart sensor detects leaks and communicates with vacuum pump
- LED indicates degassing status
- Unprecedented 4 year warranty

The Supelco Mobile Phase Degassing system with its smart sensor not only detects and alerts you to leaks, it also communicates with the vacuum pump. If a change in vacuum is detected due to mobile phase flow rate changes, the pump can compensate by changing its speed. The validation output records vacuum level to satisfy system compliance and validation requirements. The degassing system has a Teflon® AF membrane, with NO-OX™ fittings and tubing.



E000923

Description	Cat. No.
Supelco Mobile Phase Degassing System	55018-U

Refer to the current Supelco catalog for many additional products, and for prices.

## Filters

A precolumn filter is essential for protecting HPLC columns against particulate matter which can accumulate on the column frit, leading to split peaks and high back pressure. Sources of particles include mobile phases (especially when buffers are mixed with organic solvents), pump and injector seals, and samples. Use a 2.0 µm frit to protect columns containing 5 µm or larger particles, or a 0.5 µm frit for columns with particles smaller than 5 µm.

### Supelco Filter

**Direct-connect; protects analytical and guard columns.** Our precolumn filter can be connected directly, hand-tight, into any HPLC column or guard column listed in our current catalog, or with any other column that has Valco-compatible endfittings. PEEK cap and body, 2 µm stainless steel frit. For a metal-free system, order PEEK/Teflon replacement frits (Cat. No. **57430-U**).



P000551

Description	Cat. No.
Supelco Precolumn Filter	<b>Z22732-3</b>
Frits (pk. of 5)	<b>Z29087-4</b>
0.5 µm pores	<b>Z22733-1</b>
2 µm pore	<b>57430-U</b>
PEEK/Teflon, 2 µm <sup>1</sup>	

<sup>1</sup>Biocompatible, metal-free.



P000548

### SSI High Pressure Precolumn Filter

**In-line installation.** The 316 stainless steel filter disc (0.5 µm pores) is easily replaced without removing the column end fitting. Maximum operating pressure: 15,000 psi (1054 kg/cm<sup>2</sup>). For 1/16" tubing.

Description	Cat. No.
SSI High Pressure Precolumn Filter	<b>59269</b>
10-32 Threads <sup>2</sup>	<b>59271</b>
Waters Threads	
Filter Elements and Seals (pk. of 10)	<b>59273</b>
0.5 µm pores	<b>59272</b>
2 µm pores	

<sup>2</sup> Most HPLC fittings, except SSI and some Waters fittings, have 10-32 threads.

### SSI High Pressure Preinjector Filter

Place between the pump and injector to provide final filtration for the mobile phase. Easily replaced 316 stainless steel filter element (0.5 µm pores). Maximum operating pressure: 15,000 psi (105MPa). For 1/16" O.D. tubing, 10-32 threads<sup>2</sup>.



P000547

Description	Cat. No.
SSI High Pressure Preinjector Filter	<b>59262-U</b>
Replacement Filter Elements and Seals (pk. of 2)	
0.5 µm pores	<b>59264</b>
2 µm pores	<b>59265</b>

<sup>2</sup> Most HPLC fittings, except SSI and some Waters fittings, have 10-32 threads.

### Valco Precolumn Frit and Screen Filters<sup>3</sup>

**In-line installation.** Efficient, low dead volume filters protect your columns from particles without reducing column performance. The replaceable 1/8" frit has 0.5 µm pores to protect 3 µm or 5 µm column packings, the replaceable screen has 2 µm pores. Choose the frit filter for higher filtration capacity (most applications) or the screen filter for less dead volume (e.g., with microbore columns). Use with 1/16" O.D. tubing; 1/16" fittings included.



P000550

Description	Cat. No.
Valco Precolumn Filters	
Frit Filter	<b>58420-U</b>
Screen Filter	<b>58279-U</b>
Frits (pk. of 10)	
0.5 µm pores	<b>59037</b>
2.0 µm pores	<b>59129</b>
Screens (pk. of 10)	<b>58284</b>

<sup>3</sup>Frits and screens should not be interchanged in these filters.

### Isolation Technologies Precolumn Filter

**In-line installation.** High capacity inlet filter minimizes dead volume and band broadening, to prevent loss of column efficiency while protecting your column. Frit porosity: 0.5 µm. Complete as shown.



P000549

Description	Cat. No.
Isolation Technologies Precolumn Filter	
with 3 mm frit (4.6 mm columns)	<b>57675-U</b>
with 1.5 mm frit (2.1 mm columns)	<b>57676-U</b>
Frits (pk. of 5)	
3 mm	<b>57677</b>
1.5 mm	<b>57678</b>

### Upchurch Precolumn Filter

**In-line installation.** Stainless steel body with inert polyetheretherketone (PEEK) endfittings and a 0.5 µm or 2 µm PEEK frit in one endfitting.



P000555

Description	Cat. No.
Upchurch Precolumn Filter	
0.5 µm frit	<b>55079</b>
2 µm frit	<b>55078</b>
Frits (pk. of 10)	
0.5 µm	<b>55080-U</b>
2 µm	<b>55081</b>

## Rheodyne Model 7725 and 7725i Injectors

The Rheodyne Model 7725 injector allows you to inject 1 µL-5 mL samples with accuracy and precision. The rugged, easily maintained design offers many advanced features:

- Patented continuous flow design (see figure) – flow is uninterrupted when you switch from LOAD to INJECT
- Easy seal adjustment using pressure screw on front of injector
- Wide port angle (30 °), for easy access to fittings

Injector includes a 20 µL sample loop and is supplied with a VESPEL rotor seal that can be replaced with a Tefzel rotor seal for operation at pH 0-14. Factory set at 5000 psi (345 bar), adjustable to 7000 psi (483 bar). Model 7725i has an internal position sensing switch.

### A Model 7725 Injector Reduces Wear and Tear on Your Columns

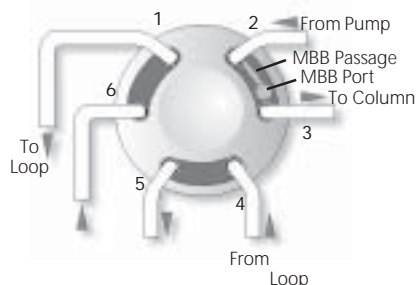

796-0423

A conventional HPLC valve momentarily interrupts flow during sample injection, subjecting your column to repetitive pressure shocks. Rheodyne's patented MBB (make-before-break) design makes the new connection before breaking the old one, providing uninterrupted flow.

Description	Cat. No.
Model 7725 Injector	57620-U
Model 7725i Injector	57621
Replacement Components	
VESPEL Rotor Seal	58830-U
Tefzel Rotor Seal	57633
Stator Face Assembly	57634
Needle Port Cleaner	57635
Valve Angle Bracket (for all metal Rheodyne valves)	57636
RheBuild Kit for 7725/7725i/7726	55049
Sample Loops (wide-angle ports; fittings included)	
2 µL	57622
5 µL	57623
10 µL	57624
20 µL	57625
50 µL	57626
100 µL	57627
200 µL	57628-U
500 µL	57629-U
1 mL	57630
2 mL	57631
5 mL	57632

**Note:** Use VESPEL seals to pH 10, Tefzel seals to pH 14.

Supelco is an authorized Rheodyne dealer.

### Optimize Technologies Pump Replacement Parts

A preventative maintenance program that includes routine replacement of pump parts that are subject to wear will help you avoid costly downtime. Our extensive selection of Optimize Technologies check valves, seals, and pistons meet or exceed pump manufacturers' specifications. For the most up-to-date selection of pump parts, refer to the current Supelco catalog, or call our Technical Service Department.

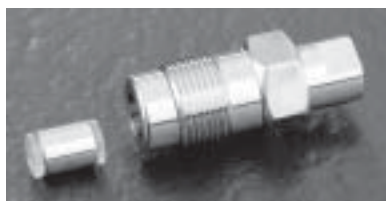

P000583

### SSI LO-Pulse Damper

A pulse damper controls pump pulsations for a more stable baseline. The SSI LO-Pulse damper is a patented unit compatible with single piston reciprocating HPLC pumps (Altex 110A, Eldex pumps, LDC Mini-Pump VS, SSI Models 200 and 300, etc.). At pressures from 500 psi to 6000 psi (35-420 kg/cm<sup>2</sup>), it improves precision of quantitative analyses and detection limits for trace sample components. Fittings and instructions included.

Description	Cat. No.
Pulse Damper	58455
Pulse Damper without Cabinet	58442

# Supelco™ Solvent Recovery Systems

SRS-3000



995-0148, 897-0035

SRS-1000



## Recover and reuse clean mobile phase, dispose of only contaminated mobile phase.

- Reduce solvent purchase and disposal costs
- Save money, mobile phase preparation time, and the environment

Supelco SRS-3000 and SRS-1000 Solvent Recovery Systems can save money and time in any isocratic analysis. A microprocessor-controlled solvent switching valve monitors detector output and directs the solvent to the waste reservoir only when a peak is detected. When the baseline falls below the threshold you select, the uncontaminated solvent is directed back to the mobile phase reservoir. In a typical isocratic analysis, 80-90% of the mobile phase is uncontaminated and can be recycled. Settings for threshold, detection range, and delay time enable you to precisely control the switching valve. In addition to the basic features mentioned above, the SRS-3000 unit offers validation output (included), an Autoclean option (see below), and storage for up to 10 method files. The validation output provides a continuous, auditable data trail of the solvent recycling valve position, for GMP, GLP, or ISO-9000 protocols. The valve position is recorded by superimposing tick marks over a separate copy of the chromatographic signal.

**Autoclean Valve** - The SRS-3000 system also is available with a valve that enables you to select a different solvent to flush the HPLC system. The Autoclean valve is especially useful if you are using a single pump with mobile phases containing buffer or other salts. The Autoclean valve installs between the mobile phase reservoir and the pump. It has two inlet lines, one for the mobile phase and one for the wash solvent. The valve can be factory installed, or you can order it separately and install it yourself.

**Economy-Priced Unit** - The economically priced SRS-1000 includes the same solvent-saving features as the SRS-3000 unit. A simpler display and *no advanced features* (no validation output, Autoclean option, or method storage memory) allow us to keep the price substantially lower.

**Both Systems are Ready to Use** - Both systems include a control unit with switching valve, a power cord, a 2-lead signal cable (+/-), Teflon tubing and fittings, and an instruction manual.

In addition to these components, the SRS-3000 system with the Autoclean valve has the wash valve, additional tubing and fittings, a wash start cable, and a pump remote stop cable.

The SRS-3000 and SRS-1000 units meet all CE requirements. The SRS-1000 units also meet UL and CSA requirements.

## Installation Is Simple

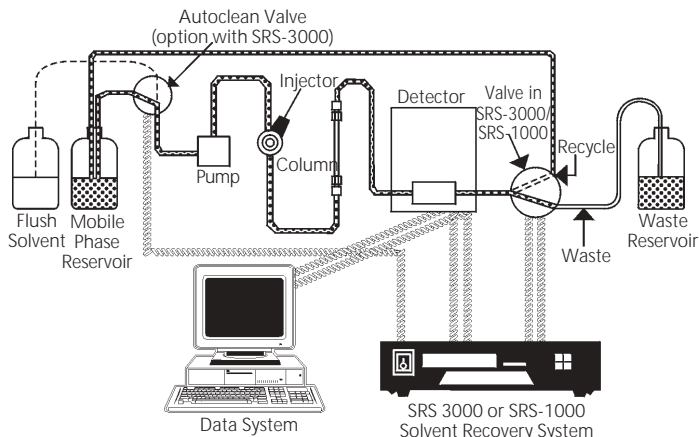

1. Connect SRS-3000 or SRS-1000 unit to detector signal output (cable is included).
2. Connect SRS-3000 or SRS-1000 unit to mobile phase and waste reservoirs and detector (Teflon tubing is included).
3. Set the threshold value and begin saving time and money.

795-0506

## Recover 80% or More of the Mobile Phase Used In an Isocratic Analysis

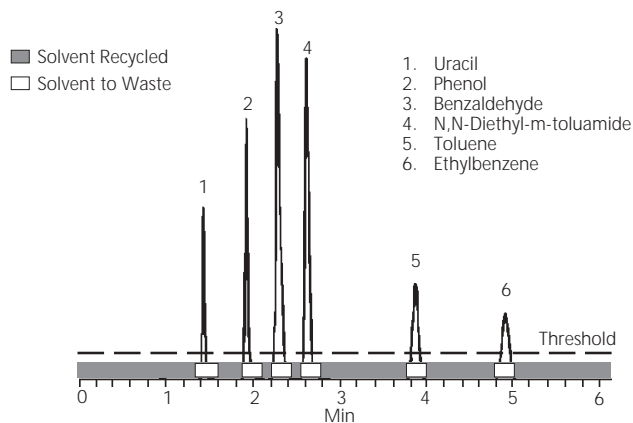

713-0516

Description	Cat. No.
SRS-3000 Solvent Recovery System <sup>1</sup>	57431
SRS-3000 System with Autoclean <sup>1</sup>	57432
Switching valve assembly for SRS-3000 unit	57435
SRS-1000 Solvent Recovery System <sup>1</sup>	506125
110VAC	506133
220VAC	

<sup>1</sup>CE approved.

Order/Customer Service 800-247-6628, 800-325-3010  
Fax 800-325-5052 • E-mail [supelco@sial.com](mailto:supelco@sial.com)

Technical Service 800-359-3041, 814-359-3041  
Fax 800-359-3044, 814-359-5468 • E-mail [techservice@sial.com](mailto:techservice@sial.com)

SUPELCO • 595 North Harrison Road, Bellefonte, PA 16823-0048 • 814-359-3441

We are committed to the success of our Customers, Employees and Shareholders through leadership in Life Science, High Technology and Service.  
The SIGMA-ALDRICH Family



SIGMA

ALDRICH

Fluka

Riedel-deHaen

SUPELCO

ISOTEC

**SUPELCO**

[sigma-aldrich.com/supelco](http://sigma-aldrich.com/supelco)

©2005 Sigma-Aldrich Co. Printed in USA. Supelco brand products are sold through Sigma-Aldrich, Inc. Sigma-Aldrich, Inc. warrants that its products conform to the information contained in this and other Sigma-Aldrich publications. Purchaser must determine the suitability of the product(s) for their particular use. Additional terms and conditions may apply. Please see reverse side of the invoice or packing slip. Supelco is a registered trademark of Sigma-Aldrich Co.

AIV 1100826D