



RTO TECHNICAL REPORT

TR-IST-050

HF Interference, Procedures and Tools

(Interférences HF, procédures et outils)

Final Report of NATO RTO Information Systems Technology (IST)
Panel Research Task Group IST-050/RTG-022
(or Research Task Group IST-050).

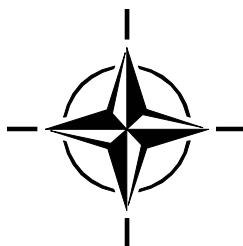

Published June 2007



NORTH ATLANTIC TREATY
ORGANISATION



AC/323(IST-050)TP/44

RESEARCH AND TECHNOLOGY
ORGANISATION



www.rto.nato.int

RTO TECHNICAL REPORT

TR-IST-050

HF Interference, Procedures and Tools

(Interférences HF, procédures et outils)

Final Report of NATO RTO Information Systems Technology (IST)

Panel Research Task Group IST-050/RTG-022

(or Research Task Group IST-050).

The Research and Technology Organisation (RTO) of NATO

RTO is the single focus in NATO for Defence Research and Technology activities. Its mission is to conduct and promote co-operative research and information exchange. The objective is to support the development and effective use of national defence research and technology and to meet the military needs of the Alliance, to maintain a technological lead, and to provide advice to NATO and national decision makers. The RTO performs its mission with the support of an extensive network of national experts. It also ensures effective co-ordination with other NATO bodies involved in R&T activities.

RTO reports both to the Military Committee of NATO and to the Conference of National Armament Directors. It comprises a Research and Technology Board (RTB) as the highest level of national representation and the Research and Technology Agency (RTA), a dedicated staff with its headquarters in Neuilly, near Paris, France. In order to facilitate contacts with the military users and other NATO activities, a small part of the RTA staff is located in NATO Headquarters in Brussels. The Brussels staff also co-ordinates RTO's co-operation with nations in Middle and Eastern Europe, to which RTO attaches particular importance especially as working together in the field of research is one of the more promising areas of co-operation.

The total spectrum of R&T activities is covered by the following 7 bodies:

- AVT Applied Vehicle Technology Panel
- HFM Human Factors and Medicine Panel
- IST Information Systems Technology Panel
- NMSG NATO Modelling and Simulation Group
- SAS System Analysis and Studies Panel
- SCI Systems Concepts and Integration Panel
- SET Sensors and Electronics Technology Panel

These bodies are made up of national representatives as well as generally recognised 'world class' scientists. They also provide a communication link to military users and other NATO bodies. RTO's scientific and technological work is carried out by Technical Teams, created for specific activities and with a specific duration. Such Technical Teams can organise workshops, symposia, field trials, lecture series and training courses. An important function of these Technical Teams is to ensure the continuity of the expert networks.

RTO builds upon earlier co-operation in defence research and technology as set-up under the Advisory Group for Aerospace Research and Development (AGARD) and the Defence Research Group (DRG). AGARD and the DRG share common roots in that they were both established at the initiative of Dr Theodore von Kármán, a leading aerospace scientist, who early on recognised the importance of scientific support for the Allied Armed Forces. RTO is capitalising on these common roots in order to provide the Alliance and the NATO nations with a strong scientific and technological basis that will guarantee a solid base for the future.

The content of this publication has been reproduced directly from material supplied by RTO or the authors.

Published June 2007

Copyright © RTO/NATO 2007
All Rights Reserved

ISBN 978-92-837-0069-2

Single copies of this publication or of a part of it may be made for individual use only. The approval of the RTA Information Management Systems Branch is required for more than one copy to be made or an extract included in another publication. Requests to do so should be sent to the address on the back cover.

Table of Contents

	Page
List of Figures	vii
List of Tables	x
Glossary	xi
List of Authors	xiv
Acknowledgements	xv
Executive Summary and Synthèse	ES-1
Chapter 1 – Introduction	1-1
1.1 Scope	1-1
1.2 History of the Work	1-1
1.3 Objectives	1-2
1.4 Overview of the Study	1-3
Chapter 2 – HF Radio	2-1
2.1 Characteristics	2-1
2.2 Users	2-2
2.2.1 Military	2-3
2.2.1.1 Land Forces	2-4
2.2.1.2 Air Forces	2-4
2.2.1.3 Maritime Forces	2-4
2.2.2 Broadcasting	2-4
2.2.3 Other Users	2-8
2.3 Noise Level	2-10
2.4 Protection Requirements	2-16
Chapter 3 – Characteristics of PLT and xDSL Transmission Systems	3-1
3.1 Transmission on Power Lines (PLT)	3-1
3.1.1 Power Line Systems	3-2
3.1.2 Medium (MV) and Low Voltage (LV) Systems	3-4
3.1.3 Access Systems	3-5
3.1.4 In-House Systems	3-7
3.1.5 Technical Characteristics with Respect to HF Radiation	3-11
3.1.6 Transmission Methods and Characteristics	3-11
3.1.6.1 OFDM (Orthogonal Frequency Division Multiplexing)	3-11
3.1.6.2 DSSS (Direct Sequence Spread Spectrum)	3-12
3.1.6.3 GMSK (Gaussian Minimum Shift Keying)	3-12

3.1.7	PLT Systems in Use	3-13
3.1.8	Example of an Access PLT System	3-15
3.2	Transmission on Telephone Lines (xDSL)	3-17
3.2.1	Telephone Line Systems	3-17
3.2.2	Technical Characteristics with Respect to HF Radiation	3-23
3.2.3	DSL Basics	3-24
3.2.4	xDSL Systems in Use	3-24

Chapter 4 – Limits for Wire-Line Transmission Systems 4-1

4.1	Existing Standards and Regulations	4-1
4.2	Proposed Limits	4-3
4.3	International Regulatory Status	4-5

Chapter 5 – Measurement of PLT Systems 5-1

5.1	Background	5-1
5.2	Measurement Evolution	5-1
5.2.1	Investigative Measurements for Access Systems	5-1
5.2.2	Regulatory Measurements for Access Systems	5-2
5.3	Observations	5-2
5.4	Recommendations	5-2
5.5	A Procedure to Evaluate PLT Impact on Military Systems	5-3
5.6	Evaluation of PLT Impact on Military Intelligence Systems	5-4
5.7	Electrical Safety	5-4
5.8	North American and European Measurement Differences	5-4
5.9	Typical Access System Investigative Measurements	5-6
5.9.1	Background	5-6
5.9.2	Measurement Considerations	5-6
5.9.2.1	Measurement Questions	5-6
5.9.2.2	Measurement Rationale	5-6
5.9.3	Equipment	5-7
5.9.3.1	Antennas	5-7
5.9.3.2	Indicating Instrument	5-7
5.9.3.3	Recommended Test Equipment for Measurements below 30 MHz	5-7
5.9.3.4	Recommended Test Equipment for Measurements above 30 MHz	5-7
5.9.3.5	General Test Equipment	5-7
5.9.4	Measurement Geometry	5-7
5.9.4.1	Basic Premise	5-7
5.9.4.2	Recommended Measurement Points	5-8
5.9.5	Practical Measurements	5-8
5.9.6	Measurement Records	5-8
5.10	Typical Access System Regulatory Measurements	5-9
5.10.1	General Measurement Principles for Access PLT and In-House PLT	5-9
5.10.2	Access PLT Measurement Principles	5-10
5.10.2.1	Test Environment	5-10
5.10.2.2	Radiated Emissions Measurement Principles for Overhead Line Installations	5-10

5.10.2.3	Radiated Emissions Measurement Principles for Underground Line Installations	5-10
5.10.2.4	Conducted Emissions Measurement Principles	5-11
5.10.3	In-House PLT Measurement Principles	5-11
5.10.3.1	Test Environment and Radiated Emissions Measurement Principles for <i>In-Situ</i> Testing	5-11
5.10.3.2	Additional Measurement Principles for <i>In-Situ</i> Testing with Overhead Lines	5-11

Chapter 6 – Propagation Path Loss Models **6-1**

6.1	Near Field Effects	6-1
6.2	Sky Wave Propagation	6-1
6.2.1	Different Prediction Methods	6-1
6.2.1.1	The IONCAP Family (REC533, VOACAP, ICEPAC)	6-1
6.2.1.2	Propwiz	6-3
6.2.1.3	Proplab-Pro	6-3
6.2.1.4	ASAPS and GRAFEX	6-4
6.2.1.5	HF-EEMS	6-4
6.2.1.6	Simple Reflection Model	6-4
6.2.2	Recommended Prediction Method	6-4
6.2.3	Relevant Input Parameters	6-4
6.3	Ground Wave Propagation	6-7
6.3.1	Different Prediction Methods	6-8
6.3.2	Recommended Prediction Method	6-8
6.3.3	Relevant Input Parameters	6-8

Chapter 7 – Modelling of Wire-Line Transmission Systems as HF Noise Sources **7-1**

7.1	Principal Aspects of the Radiated Power in the Far-Field	7-1
7.1.1	Antenna Gain Measurements	7-2
7.1.2	CMRR/LCL Measurements	7-3
7.1.3	Numerical Methods	7-3
7.1.4	Ampere’s Law	7-4
7.1.5	Impedance Discontinuities	7-4
7.2	PLT Line Modelling Techniques with Dipoles	7-5
7.2.1	Exact Solution of a Dipole	7-5
7.2.2	Field Computation Far Away from the PLT	7-7
7.2.3	Half-Wavelength Dipole Model	7-8
7.2.4	One-Wavelength Dipole Model	7-9
7.2.5	Small Dipole Model	7-9
7.2.6	The Two-Ray Method	7-10
7.2.7	Rationale and Justification for Using Exact Dipole Solution Expressions in the Vicinity of the Overhead PLT Line	7-14
7.2.7.1	Half-Wave Dipole Results	7-14
7.2.7.2	Full-Wave Dipole Results	7-15
7.2.7.3	Comments on Results	7-16

7.3	Recommended EIRP Estimation Methods	7-16
7.4	Distance Conversion Factor Near PLT	7-17
7.4.1	Documented Measurements and Regulatory Conversion Factors	7-17
7.4.2	Results from Modelling Calculations	7-18
7.4.2.1	Horizontal Reflection Coefficient Profile	7-19
7.4.2.2	Half-Wave Dipole Results	7-20
7.4.2.3	Full-Wave Dipole Results	7-24
7.4.2.4	Comments on Results	7-27
7.4.3	Determination of Distance Conversion Factor	7-27
7.4.3.1	Half-Wave Model	7-28
7.4.3.2	Full-Wave Model	7-30
7.4.4	Remarks	7-33
7.5	Representative PLT Sources	7-34
Chapter 8 – EMC Analysis Methods		8-1
8.1	Cumulative Effects Modelling Methods in the Far Field (Sky Wave)	8-1
8.1.1	“Cumulative PLT Tool”	8-2
8.1.2	Cumulative PLT Tool – Instructions on Use	8-3
8.1.3	Improvement Potentials Regarding Cumulative PLT Tool	8-5
8.2	Calculation of HF Radio Noise from PLT/xDSL Systems	8-6
8.2.1	Receiver Location in Bodø, Norway	8-6
8.2.2	Receiver Location in Winnipeg, Canada	8-11
8.2.3	Other Receiver Locations	8-13
8.3	Cumulative Effects by Ground Wave	8-18
8.4	Current PLT Market Penetration Information	8-18
Chapter 9 – Conclusions and Recommendations		9-1
9.1	Conclusions	9-1
9.2	Recommendations	9-2
Chapter 10 – References		10-1
Annex A – IST-050 RTG TAP		A
Annex B – IST-050 RTG Terms of Reference		B
Annex C – IST-050 RTG Programme of Work		C
Annex D – IST-050 RTG Work Schedule		D
Annex E – IST-050 RTG Members		E

List of Figures

Figure		Page
Figure 2.1-1	HF Radio Wave Propagation	2-1
Figure 2.2.2-1	HF Spectrum Measured in Germany during One Day in February 2003 (2 – 30 MHz, measurement bandwidth 100 Hz)	2-6
Figure 2.2.2-2	HF Spectrum Measured in Norway during One Day in November 2004 (2 – 30 MHz, measurement bandwidth 9 kHz, average energy measured over 10 ms intervals)	2-7
Figure 2.3-1	Median Values of Natural Noise Power for a Short Vertical Lossless Grounded Monopole Antenna	2-11
Figure 2.3-2	Median Values of Man-Made Noise Power for a Short Vertical Lossless Grounded Monopole Antenna	2-12
Figure 2.3-3	Low Natural Noise Measured in Germany	2-15
Figure 2.3-4	Minimum Natural Noise Measured in Germany 1985 and in UK 2001 and ITU-Recommendations for Median Natural and Man-Made Noise in Europe	2-16
Figure 3.1-1	Alternative Connections between Telecommunications and Energy Networks	3-2
Figure 3.1.1-1	Basic PLT System in Europe with Three Different Potential Connection Points for PLT Modems (arrows)	3-3
Figure 3.1.1-2	Basic BPL System	3-3
Figure 3.1.2-1	Power Line TN-C-S Network	3-5
Figure 3.1.3-1	Usual Low Voltage Electricity Distribution Network in Germany	3-6
Figure 3.1.3-2	Cable Types mostly used in German Access and In-House Systems	3-6
Figure 3.1.3-3	Sleeve for Power Line Distribution to the Premises	3-7
Figure 3.1.4-1	House Access Point in a House with 2 Apartments (Zähler = meter)	3-8
Figure 3.1.4-2	In-House Power Supply Installation (q: cross section)	3-9
Figure 3.1.4-3	Lamp Circuits with One- and Two-Way Wiring	3-10
Figure 3.1.6-1	Principle of OFDM Modulation	3-12
Figure 3.1.6-2	Principle of DSSS Modulation	3-12
Figure 3.1.6-3	Principle of GMSK Modulation	3-13
Figure 3.1.8-1	Integrated Amperion System	3-16
Figure 3.1.8-2	Amperion Overhead System Customer Termination	3-16
Figure 3.1.8-3	Amperion Injector/Extractor	3-16
Figure 3.2.1-1	Typical Telephone Access Network	3-18
Figure 3.2.1-2	Conductor Arrangements in Telecommunication Lines and Cables	3-19
Figure 3.2.1-3	xDSL Line (Telephone Access Network)	3-20

Figure 3.2.1-4	Basic Construction of a Cross-Connection Point	3-21
Figure 3.2.1-5	Photo of a Cross-Connection Point inside a Street Cabinet	3-21
Figure 3.2.1-6	Scheme of Telephone Line Branching Off by a Sleeve	3-22
Figure 3.2.1-7	House Access Point (HAP) for Telephone Lines	3-22
Figure 3.2.1-8	Simple House Installation with xDSL Access	3-23
Figure 4.1-1	Field Strength Limits Proposed for Broadband Wire-Line Telecommunication Networks	4-2
Figure 5.5-1	Measurement Arrangement	5-3
Figure 6.2-1	Area Predictions with TX in Stockholm at 5 MHz, 21UTC, using REC533, VOACAP and ICEPAC	6-3
Figure 6.2-2	Example ICEPAC Output with Input Parameters as Recommended by the Task Group, using a 4000 x 4000 km Great Circle Grid	6-6
Figure 6.2-3	Example ICEPAC Output with Input Parameters as Recommended by the Task Group, using a Lat/Long Grid	6-7
Figure 7.1-1	Simplified Model of a Wire-Line Transmission System, including Quantities Relevant to Far-Field Radiation	7-1
Figure 7.2.1-1	The Geometry of Dipole used in the Derivation of Fields	7-6
Figure 7.2.6-1	The Two-Ray Field Calculation Geometry	7-10
Figure 7.2.6-2	The Two-Ray Field Calculation Geometry near Dipole for Modelling PLT	7-11
Figure 7.2.7.1-1	Comparison of E_z Magnitudes – Half-Wave Dipole	7-15
Figure 7.2.7.2-1	Comparison of E_z Magnitudes – Full-Wave Dipole	7-16
Figure 7.4.2.1-1	Horizontal Reflection Coefficient Profile – PLT Line Height at 10 Metres	7-19
Figure 7.4.2.1-2	Horizontal Reflection Coefficient Profile – PLT Line Height at 15 Metres	7-20
Figure 7.4.2.2-1	Two-Ray Results – PLT Line Height at 10 Metres – $L = \lambda/2$	7-21
Figure 7.4.2.2-2	Single-Ray Results – PLT Line Height at 10 Metres – $L = \lambda/2$	7-21
Figure 7.4.2.2-3	Combined Results – PLT Line Height at 10 Metres – $L = \lambda/2$	7-22
Figure 7.4.2.2-4	Two-Ray Results – PLT Line Height at 15 Metres – $L = \lambda/2$	7-22
Figure 7.4.2.2-5	Single-Ray Results – PLT Line Height at 15 Metres – $L = \lambda/2$	7-23
Figure 7.4.2.2-6	Combined Results – PLT Line Height at 15 Metres – $L = \lambda/2$	7-23
Figure 7.4.2.3-1	Two-Ray Results – PLT Line Height at 10 Metres – $L = \lambda$	7-24
Figure 7.4.2.3-2	Single-Ray Results – PLT Line Height at 10 Metres – $L = \lambda$	7-25
Figure 7.4.2.3-3	Combined Results – PLT Line Height at 10 Metres – $L = \lambda$	7-25
Figure 7.4.2.3-4	Two-Ray Results – PLT Line Height at 15 Metres – $L = \lambda$	7-26
Figure 7.4.2.3-5	Single-Ray Results – PLT Line Height at 15 Metres – $L = \lambda$	7-26
Figure 7.4.2.3-6	Combined Results – PLT Line Height at 15 Metres – $L = \lambda$	7-27
Figure 8.1.2-1	Flow Chart of the Available Options in the User Interface of Cumulative PLT Tool	8-4

Figure 8.2.1-1	Predicted Cumulative PLT Noise Parameters, for example with Receiver in Bodø, Compared to Established Background Noise Levels	8-9
Figure 8.2.1-2	Upper Plot: Median Path Loss (dB) as Predicted by ICEPAC for a Certain Combination of Input Parameters with Receiver in Bodø; Middle Plot: Population per 0.25 x 0.25 Degrees Grid Square in dB ($10 \cdot \log_{10}(\text{population})$); Lower Plot: Product (dB-sum) of the Two above Plots	8-10
Figure 8.2.2-1	Predicted Cumulative PLT Noise Parameters, for example with Receiver in Winnipeg, Compared to Established Background Noise Levels	8-12
Figure 8.2.2-2	Upper Plot: Median Path Loss (dB) as Predicted by ICEPAC for a Certain Combination of Input Parameters with Receiver in Winnipeg; Middle Plot: Population per 0.25 x 0.25 Degrees Grid Square in dB ($10 \cdot \log_{10}(\text{population})$); Lower Plot: Product (dB-sum) of the Two above Plots	8-13
Figure 8.2.3-1	Percentage of Environmental Parameter Combinations where Estimated Cumulative PLT Noise Exceeds Different Noise Curves	8-15
Figure 8.2.3-2	Percentage of Environmental Parameter Combinations where Estimated Cumulative PLT Noise Exceeds the Absolute Protection Requirement of Section 2.4.	8-16
Figure 8.2.3-3	Predicted Cumulative PLT Noise Parameters, for example with Receiver in Augsburg, Compared to Established Background Noise Levels	8-17
Figure 8.2.3-4	Predicted Cumulative PLT Noise Parameters, for example with Receiver in Jacksonville, Compared to Established Background Noise Levels	8-18

List of Tables

Table		Page
Table 2.2.2-1	Allocated Broadcast HF Radio Bands	2-5
Table 2.2.3-1	Further Users of HF Spectrum	2-9
Table 2.3-1	Formulas Reflecting the Level of the Atmospheric Noise, 99.5% Value Exceeded	2-13
Table 2.3-2	The Constants c and d in Equation (2-6) for Various Types of Area	2-14
Table 3.1.3-1	Technical Data of the Lines shown in Figure 3.1.3-2	3-7
Table 3.1.7-1	Characteristics of PLT and xDSL Systems in Use	3-14
Table 3.2.1-1	Technical Data of Some Telecommunication Lines	3-19
Table 3.2.3-1	xDSL Classification	3-24
Table 5.8-1	Measurement Requirements Comparison	5-5
Table 7.4.3.1-1	$ E_z $ Values (dBV/m) – PLT Line at 10 Metres – $L = \lambda/2$	7-28
Table 7.4.3.1-2	$ E_z $ Values (dBV/m) – PLT Line at 15 Metres – $L = \lambda/2$	7-28
Table 7.4.3.1-3	Distance Conversion Factors – PLT Line at 10 Metres – $L = \lambda/2$	7-29
Table 7.4.3.1-4	Distance Conversion Factors – PLT Line at 15 Metres – $L = \lambda/2$	7-29
Table 7.4.3.1-5	Averaged Distance Conversion Factors – $L = \lambda/2$	7-30
Table 7.4.3.1-6	Distance Conversion Factors (dB/decade) – $L = \lambda/2$	7-30
Table 7.4.3.2-1	$ E_z $ Values (dBV/m) – PLT Line at 10 Metres – $L = \lambda$	7-31
Table 7.4.3.2-2	$ E_z $ Values (dBV/m) – PLT Line at 15 Metres – $L = \lambda$	7-31
Table 7.4.3.2-3	Distance Conversion Factors – PLT Line at 10 Metres – $L = \lambda$	7-32
Table 7.4.3.2-4	Distance Conversion Factors – PLT Line at 15 Metres – $L = \lambda$	7-32
Table 7.4.3.2-5	Averaged Distance Conversion Factors – $L = \lambda$	7-33
Table 7.4.3.2-6	Distance Conversion Factors (dB/decade) – $L = \lambda$	7-33
Table 8.2.3-1	Receiver Locations used in Simulations	8-14

Glossary

ADSL	Asymmetric Digital Subscriber Line
ALE	Automatic Link Establishment
AM	Amplitude Modulation
ATC	Air Traffic Control
BBC	British Broadcasting Corporation
BLOS	Beyond-Line-of-Sight
BPL	Broadband over Power Line
CEN	European Standardisation Committee
CENELEC	European Committee for Electrotechnical Standardisation
CEPT	European Conference of Postal and Telecommunications Administrations
CIS	Control Infra-Structure
CISPR	International Special Committee on Radio Interference
CM	Common Mode
CMRR	Common Mode Rejection Ratio
CNSC	Communication Network Sub-Committee
CO	Central Office
COMINT	Communications Intelligence
CP	Cross-Connection Point
CRC	Communications Research Centre (Canada)
CRO	Crisis Response Operations
DERA	Defence Evaluation & Research Agency
DM	Differential Mode
DP	Distribution Point
DRM	Digital Radio Mondiale
DSL	Digital Subscriber Line
DSLAM	DSL Access Multiplexer
DSSS	Direct Sequence Spread Spectrum
EBU	European Broadcasting Union
EC	European Commission
ECC	Electronic Communications Committee
EIRP	Equivalent (Effective) Isotropic Radiated Power
EMC	Electromagnetic Compatibility
EPM	Electronic Protection Measures
ERC	European Radiocommunications Committee
ET	Exploratory Team
ETSI	European Telecommunications Standards Institute
EU	Europe, European Union
EUT	Equipment Under Test
FCC	Federal Communications Commission
FFI	Forsvarets Forskningsinstitut (Norwegian Defence Research Establishment)

FGAN	Forschungsgesellschaft für Angewandte Naturwissenschaften e.V. (Research Establishment for Applied Science)
FKIE	Forschungsinstitut für Kommunikation, Informations-verarbeitung und Ergonomie
FMSC	Frequency Management Sub-Committee
FreqBZPV	F requenz b ereichszulassungs p lan v erordnung
GMDSS	Global Maritime Distress and Safety System
GMSK	Gaussian Minimum Shift Keying
GPIB	General Purpose Interface Bus
GPS	Global Positioning System
GSM	Global System for Mobile
JRCSC	Joint C3 Requirements and Concepts Sub-Committee
HAP	House Access Point
HF	High Frequency
HFR AHWG	HF Radio Ad Hoc Working Group
HV	High Voltage
ICED	Ionospheric Conductivity and Electron Density
ICEPAC	Ionospheric Communications Enhanced Profile Analysis and Circuit Prediction
IEC	International Electrotechnical Commission
IEEE	Institute of Electrical and Electronics Engineers
IF	Intermediate Frequency
IFFT	Inverse Fast Fourier Transform
IONCAP	Ionospheric Communications Analysis and Prediction
IP	Internet Protocol
ISDN	Integrated Services Digital Network
ISM	Industrial, Scientific and Medical
IST	Information Systems Technology
ITE	Information Technology Equipment
ITU	International Telecommunication Union
JWG	Joint Working Group
LCL	Longitudinal Conversion Loss
LUF	Lowest Usable Frequency
LV	Low Voltage
LVEDN	Low Voltage Electricity Distribution Network
MDF	Main Distribution Frame
MF	Medium Frequency
MSK	Minimum Shift Keying
MUF	Maximum Usable Frequency
MV	Medium Voltage
MVEDN	Medium Voltage Electricity Distribution Network
NATO	North Atlantic Treaty Organisation
NB 30	Nutzungsbestimmung 30
NEC	Numerical Electromagnetic Code

NHQC3S	NATO Headquarters Consultation, Command and Control Staff
NTIA	National Telecommunications and Information Administration
NVIS	Near Vertical Incidence Sky wave
OFDM	Orthogonal Frequency Division Multiplexing
ONU	Optical Network Unit
OPERA	Open PLC European Research Alliance
OR	Off Route service
PfP	Partnership for Peace
PLC	Power Line Communications
PLT	Power Line Telecommunications
POTS	Plain Old Telephony Service
PoW	Programme of Work
PSD	Power Spectral Density
PSTN	Public Switched Telephone Network
QinetiQ	part of DERA privatised
R	Route service
RF	Radio Frequency
RMS	Root Mean Square
RSGB	Radio Society of Great Britain
RTA	Research and Technology Agency (NATO)
RTB	Research and Technology Board (NATO)
RTG	Research Task Group (NATO)
RTO	Research and Technology Organisation (NATO)
SAR	Search and Rescue
SATCOM	Satellite Communications
SNR	Signal to Noise Ratio
SSB	Single Sideband
SSN	Sunspot Number
TAP	Technical Activity Proposal
ToR	Terms of Reference
TST	Telefunken Systemtechnik
UK	United Kingdom
USA	United States of America
VDSL	Very High Speed Digital Subscriber Line
VHF	Very High Frequency
VoIP	Voice over Internet Protocol
xDSL	various forms of Digital Subscriber Line
Z_0	impedance of free space

List of Authors

This Report of IST-050/RTG-022 was prepared by the following authors (in alphabetical order):

- Mr. Josef BENGER, FGAN, Germany, (RTG Member);
- Dr. Arto CHUBUKJIAN, CRC, Canada, (RTG Chair);
- Mr. Knut-Inge HVIDSTEN, formerly with FFI, Norway, (former RTG Member);
- Mr. Brian KASPER, Industry Canada, Canada, (Adjunct Expert); and
- Dr. Roald OTNES, FFI, Norway, (RTG Member).

Acknowledgements

The members of the Research Task Group (RTG) IST-050/RTG-022 would like to express their appreciations and acknowledge the assistance extended them by the management and staff of following organisations, over the course of this undertaking.

- NATO Research and Technology Organisation (RTO) and Agency (RTA) in Paris, France;
- Forschungsgesellschaft für Angewandte Naturwissenschaften (FGAN) in Wachtberg, Germany;
- Norwegian Defence Research Establishment (FFI) in Kjeller, Norway; and
- Communications Research Centre (CRC) in Ottawa, Canada.

Appreciations are also extended to ToriTech LLC of Tblisi, Georgia, and to the Telecommunications Systems Department of the Military Academy of Slovakia for providing their staff to attend the RTG meetings as the representatives of their respective nations.

Finally, the RTG would like express their many thanks and appreciations for the help and guidance received from the following RTO/RTA staff, throughout its mandate:

- LtCol. Alain Gouay, French Air Force, RTO Information Systems Technology (IST) Panel Executive;
- LtCol. Patrick Prodhome, French Air Force, RTO Information Systems Technology (IST) Panel Executive;
- Ms. Aysegül Apaydin, IST Panel Assistant;
- Ms. Jette Schmidt, RTO Publication Manager; and
- Ms. Kelly Edwards, RTO Editor.



HF Interference, Procedures and Tools

(RTO-TR-IST-050)

Executive Summary

This Report presents the results of the work carried out by IST-050/RTG-022, the Research Task Group (RTG) on “HF Interference, Procedures and Tools”, to address the concerns raised by the potential for unintentional radio interference to be caused by the widespread operation of broadband wire-line telecommunications systems.

PowerLine TeleCommunications (PLT, PLC) and various forms of Digital Subscriber Line (xDSL) transmissions use the existing mains electricity or telephone wiring including in-premises cables for telecommunications with data rates higher than 1 MBit/s. As these lines were not designed for such broadband transmissions, they will cause unintentional RF emissions which may adversely affect the established radio noise floor directly, or by cumulative propagation from many such sources. The existing HF background noise possibly may be increased via ground wave and/or sky wave propagation.

Increase of the existing HF noise floor by widespread use of PLT and/or xDSL will bring up problems for Military Radio Users as well as for HF Communication Intelligence (COMINT) in all NATO countries. The signal-to-noise ratio thus may be reduced for tactical and strategic HF radio as well as for fixed sensitive COMINT sites.

Exact calculations of HF radio noise emissions from the new broadband wire-line telecommunications networks were impossible because of missing models for these transmission systems. Therefore methods have been investigated to find procedures, models and tools applicable for being able to determine the influence of PLT and xDSL on reception of HF radio signals. These are described in this report.

The RTG addressed itself to the HF radio emission effects of the new broadband cable transmissions. It investigated and found means that allow calculation of cumulative field strengths of HF noise radiated by PLT or xDSL. This will enable NATO and its nations to determine the threat to military HF radio communications and COMINT systems from PLT and xDSL and to take the appropriate steps. It should be noted here that the determination of the nature and the severity of any possible detrimental effect upon the military systems was outside the RTG’s expertise and ToR.

The RTG chose to concentrate its work on the PLT issue rather than xDSL because PLT will produce the most problems regarding HF interference (power lines have less symmetry and will have impedance discontinuities), they will be deployed in large numbers, and finally the current versions of xDSL have no documented HF interference-causing problems, while the VDSL variants covering the entire HF range are still in the definition phase.

In the course of the studies, the RTG determined that ITU-R P.372-8 noise curves (based on measurements carried out in the 1970s) are still valid in Europe. Recent measurements carried out in Germany and Great Britain indicated that there is no remarkable difference between these measurements, specifically no increase of the ambient noise in quiet rural zones within the last 30 years.

Based on these measurement results, the cumulative interference field strengths far away from telecommunication networks should not be higher than **-15 dB μ V/m** (9 kHz bandwidth) across the entire

HF range, if no measurable increase in minimum noise levels are to be tolerated. The RTG refers to this criterion as the **Absolute Protection Requirement**. It should be noted that this value is in the range of 10 to 1 dB below the ITU-R P.372-8 Quiet Rural noise curve, which are median values, across the HF band.

A couple of important tasks in the RTG's work, namely, the appropriate measurement techniques and the most suitable propagation path loss models for interference studies, were addressed and completed.

The quantity of interest when considering cumulative effects in the far-field is the EIRP (equivalent (or effective) isotropic radiated power) per unit bandwidth caused by each signal source, in units of dBm/Hz, at different frequencies. The radiation pattern might also be of interest in some cases, but when summing up many different sources with different wiring geometries over a wide area, it is reasonable to approximate the average radiation pattern as isotropic (in elevation as well as in azimuth).

In modelling the emissions from an overhead Access PLT line, the PLT wires can be modelled as a successive set of dipoles, assuming that the standing waves present are the dominant emission source. Given the PLT geometry, the cylindrical coordinate system is more practical rather than the spherical coordinate system generally used in electromagnetics. In the vicinity of a PLT, up to 200 metres, the use of the expression for the exact solution of a dipole is recommended, which is valid at any distance in both near-field and far-field.

The RTG has developed a "Cumulative PLT Tool", which was used to perform cumulative PLT noise calculations at several hypothetical sensitive receiver locations. For each receiver location and frequency, the percentage of parameter combinations was computed where the estimated cumulative PLT noise level is above the quiet rural level, above quiet rural +6 dB, and above the rural noise level. The results indicated the following:

- a) High probability that PLT would cause increased noise levels at sensitive receiver sites given the projected market penetration; and
- b) The percentages are highly influenced by assumptions on transmitter EIRP, PLT market penetration, and duty cycle.

The percentage of parameter combinations was also computed where the estimated PLT noise level is above the Absolute Protection Requirement. Again, the probability of the cumulative effect of PLT exceeding the Absolute Protection Requirement is predicted to be relatively large for all frequencies and receiver locations investigated.

Currently, there are no commonly accepted regulatory emission limits from PLT. While it is highly desirable that the regulatory limits on PLT emissions be harmonised throughout the NATO countries, the RTG recognizes that NATO, by itself, has no regulatory authority over the emission limits. Therefore, it is recommended that NATO seek the implementation of this goal by working together with the national and international regulatory authorities.

Interférences HF, procédures et outils

(RTO-TR-IST-050)

Synthèse

Ce rapport rend compte des résultats du travail effectué par le groupe opérationnel de recherche (RTG) IST-050/RTG-022 sur les “Interférences HF, procédures et outils”. Il traite des questions soulevées par la génération involontaire possible d’interférences radio causées par l’exploitation généralisée de systèmes de télécommunications filaires à large bande. Les télécommunications via le réseau électrique courant, dites PowerLine Communications (PLT ou PLC) et diverses formes de transmissions xDSL (Digital Subscriber Line : ligne numérique d’abonné) utilisent le réseau électrique existant ou le téléphone filaire incluant les fils domestiques pour des télécommunications jusqu’à 1 Mo/s.

Comme ces lignes n’ont pas été conçues pour la transmission en large bande, elles généreront involontairement des émissions RF, qui auront un effet néfaste direct sur le plancher établi de bruit radio, ou par propagation cumulative de nombreuses sources de même type. Le bruit de fond HF existant risque d’être augmenté par propagation de l’onde terrestre et/ou aérienne.

L’augmentation du plancher de bruit HF existant par l’utilisation répandue des PLT et/ou xDSL engendrera des problèmes pour les utilisateurs de radio militaires, ainsi que pour le renseignement radio COMINT HF de toutes les nations de l’OTAN. Le rapport S/B peut ainsi être réduit pour la radio HF tactique ou stratégique, ainsi que pour les sites fixes, sensibles COMINT.

Le calcul exact des émissions de bruit radio HF à partir des réseaux de communication filaire en bande large a été impossible à cause du manque de modèles pour ces systèmes de transmission. Des méthodes ont donc été recherchées pour trouver des procédures, modèles et outils applicables, permettant de déterminer l’influence des communications PLT et xDSL sur la réception des signaux radio HF. Celles-ci sont décrites dans ce compte-rendu.

Le RTG s’est donc consacré à l’étude des effets des émissions radio HF des nouvelles transmissions filaires en bande large. Il a recherché et trouvé des moyens de calculer la force des champs cumulés de bruit HF rayonné par les PLT ou xDSL. Ceci permettra à l’OTAN et ses membres de déterminer la menace sur les communications radio HF et les systèmes de COMINT à partir des PLT et xDSL et, de prendre les mesures appropriées. Il faut noter ici que la détermination de la nature et de la gravité de tout effet néfaste possible sur les systèmes de communications militaires n’entre pas dans le champ de compétence du RTG ni du ToR.

Le RTG a décidé de se concentrer sur les problèmes PLT plutôt que xDSL, car la PLT générera le plus grand nombre de problèmes d’interférences HF – (les lignes électriques du réseau sont moins symétriques et souffriront de discontinuités d’impédance). Les PLT sont largement répandues, et en fin de compte, les problèmes d’interférences HF des versions courantes de la xDSL ne sont pas documentés, alors que les variantes VDSL couvrant toute la gamme HF sont encore en phase de définition.

Au cours de ces études, le RTG a déterminé que les courbes de bruit ITU-R P.372-8 (fondées sur des mesures effectuées au cours des années 1970) sont toujours valables en Europe. De récentes mesures effectuées en Allemagne et Grande Bretagne confirment qu’il n’existe pas de différences notables entre ces mesures : en particulier, il n’y a d’augmentation du bruit ambiant dans les zones rurales calmes sur les 30 dernières années.

En se fondant sur les résultats de ces mesures, la force des champs d'interférence cumulés très loin des réseaux de télécommunications ne devrait pas être supérieure à **-15 dB μ V/m** (bande passante = 9 kHz) sur toute la gamme HF, si aucune augmentation mesurable des niveaux de bruit minimaux ne doit être tolérée. Le RTG fait référence à ce critère comme **Exigence de Protection Absolue**. Il faut noter que cette valeur se situe dans la gamme des 10 à 1 dB en-dessous de la courbe de bruit en milieu rural silencieux ITU-R P.372-8, qui sont des valeurs médianes sur la bande HF.

Deux tâches importantes dans le travail du RTG, à savoir : les techniques appropriées de mesure et les modèles les plus souhaitables de perte de voie de propagation pour les études sur les interférences, ont aussi été traitées et achevées.

Quand on considère les effets cumulés dans le champ lointain, la mesure intéressante se trouve être la PIRE (Puissance Isotrope Rayonnée Équivalente/Efficace), par unité de bande passante générée par chaque source de signal, en dBm/Hz à différentes fréquences. Le diagramme de rayonnement peut aussi, dans certains cas, présenter quelque intérêt, mais en sommant de nombreuses sources variées, dotées de différentes géométries de câblage sur une zone étendue, il est raisonnable d'envisager ce diagramme comme isotrope (en site comme en azimut).

En modélisant les émissions à partir d'une ligne PLT aérienne, les fils PLT peuvent être considérés comme une succession de dipôles, en supposant que les ondes stationnaires présentes constituent la source dominante d'émission. Étant donné la géométrie de la PLT, le système de coordonnées cylindriques est plus pratique que les coordonnées sphériques généralement utilisées en électromagnétique. Au voisinage d'une PLT, jusqu'à 200 m, l'utilisation de l'expression pour la solution exacte d'un dipôle est recommandée, ce qui est valable pour toutes les distances, dans le champ proche aussi bien que lointain.

Le RTG a conçu un "Outil cumulatif PLT", qui a servi à calculer, en divers lieux hypothétiques de réception sensibles, le bruit cumulé PLT. Pour chaque lieu de réception et sa fréquence correspondante, le pourcentage de combinaisons de paramètres a été calculé, c'est-à-dire là où le niveau estimé de bruit cumulé PLT est au-dessus du niveau rural calme, soit au-dessus des +6 dB par rapport au niveau rural calme, soit au-dessus du niveau de bruit rural. Les résultats sont mentionnés ci-après :

- a) Forte probabilité que la PLT génère un surcroît de bruit sur des sites récepteurs sensibles, étant donné la pénétration projetée du marché ; et,
- b) Ces pourcentages sont très fortement influencés par les suppositions sur la PIRE de l'émetteur, la pénétration du marché PLT et son coefficient d'utilisation.

Le pourcentage des combinaisons de paramètres a aussi été calculé, là où le niveau estimé de bruit PLT est au-dessus de l'Exigence de Protection Absolue. Répétons-le, la probabilité de l'effet cumulatif de la PLT dépassant l'Exigence de Protection Absolue s'avère être relativement élevée pour toutes les fréquences et lieux de réception examinés.

A ce jour, il n'existe pas de limites réglementaires acceptées pour la PLT. Alors qu'il est très souhaitable que les limites réglementaires sur les émissions PLT soient harmonisées parmi tous les membres de l'OTAN, le RTG reconnaît que l'OTAN, en lui-même, ne dispose pas d'autorité réglementaire chargée de fixer ces limites d'émission. Il est donc recommandé que l'OTAN cherche la mise en œuvre d'un tel objectif en travaillant avec les autorités réglementaires nationales et internationales.

Chapter 1 – INTRODUCTION

1.1 SCOPE

This Report concerns radio services that operate in the range 1.6 MHz to 30 MHz called the High Frequency (HF) band, although it consists of the upper end of the conventional medium frequency band (MF: 0.3 MHz to 3 MHz) and the whole of conventional HF band (3 MHz to 30 MHz).

The HF band is an excellent means for direct near and far distance radio communications and its equipment is easily and rapidly deployable. It permits fully military-controlled command links across short and long distances (tactical/strategic) with secured transmissions, no subscriber costs and easy frequency co-ordination.

In recent years, the potential for unintentional radio interference to be caused by the operation of a range of signalling systems that may be mass-deployed has become of interest to national regulators, spectrum users and the network operators wishing to deploy them. Regulatory effort has largely concentrated upon the identification of suitable measurement methods and limits to be applied to the unintentional emissions from single systems, such that interference to radio reception may be controlled. There remains however the more general question concerning the widespread impact on the radio spectrum that mass deployment of such technologies may have.

PowerLine TeleCommunications (PLT, PLC) and various forms of Digital Subscriber Line (xDSL) transmissions use the existing mains electricity or telephone wiring including in-premises cables for telecommunications with data rates higher than 1 MBit/s. As these lines were not designed for such broadband transmissions, they will cause unintentional RF emissions which may adversely affect the established radio noise floor directly, or by cumulative propagation from many such sources. The existing HF background noise possibly may be increased via ground wave and/or sky wave propagation. The intensity of the cumulative PLT noise depends on the communications signal power injected into the lines, the electrical characteristics of the lines (balance, match, screening), the structure of the networks and the lengths of single lines with respect to the HF wavelengths, as well as on the density and area coverage of the new broadband data access systems.

Increase of the existing HF noise floor by widespread use of PLT and/or xDSL will bring up problems for Military Radio Users as well as for HF Communication Intelligence (COMINT) in all NATO countries. The signal-to-noise ratio thus may be reduced for tactical and strategic HF radio as well as for fixed sensitive COMINT sites. First measurements and estimations show that disturbing emissions from wire-line telecommunications networks may increase the HF radio noise level just near to the lines as well as at very great distances (up to several thousand km) and thus may have an international disturbing effect.

Exact calculations of HF radio noise emissions from the new broadband wire-line telecommunications networks were impossible because of missing models for these transmission systems. Therefore methods have been investigated to find procedures, models and tools applicable for being able to determine the influence of PLT and xDSL on reception of HF radio signals. These are described in this report.

1.2 HISTORY OF THE WORK

At its February 2001 meeting the Communication Network Sub-Committee (CNCS) noted a brief by the chairman of the HF Radio Ad Hoc Working Group (HFR AHWG) on the potential threat to HF radio users posed by new data systems using PLT and DSL [1]. CNCS's letter on its concerns over these new data systems was sent to NHQC3S. After discussion of these concerns, the IST Panel was asked for

INTRODUCTION

assistance, and at its October 2001 meeting, the Panel decided to create the Exploratory Team IST-ET-022 on “HF Interference, Procedures and Tools”, supported by four nations: Canada, Germany, Norway and the United Kingdom.

The Exploratory Team met twice in FGAN-FKIE (GE). The results of the kick-off meeting on 21 August 2002 were updated documents TAP and ToR and a first draft of the PoW. During the second meeting on 11-12 March 2003, TAP and ToR were reviewed and the draft of the PoW including its work schedule was discussed in detail.

The RTB approved the IST-50/RTG-022 on its fall meeting 2003. RTA sent the invitation letter to all NATO and PfP Nations. Three more nations, Georgia, Italy and Slovakia, declared their willingness to participate and nominated experts.

The inaugural meeting of the IST-050/RTG-022 was held at RTA in Paris, France on 29-31 March 2004, with the participation of Canada, Georgia, Germany, Norway and Slovakia. Subsequently, eight more meetings were held in various locations: August 2004 at FFI in Kjeller, Norway; January 2005 at FGAN-FKIE in Wachtberg, Germany; April 2005 at RTA in Paris, France; September 2005 at CRC in Ottawa, Canada; November 2005 at FFI in Kjeller, Norway; March 2006 at FGAN-FKIE in Wachtberg, Germany; June 2006 at CRC in Ottawa, Canada; and October 2006 at RTA in Paris, France.

On the matter of participation in the RTG’s work, United Kingdom and Italy were unable to carry through their initial commitment, and their representatives never attended a meeting nor contributed any material to the work, despite repeated requests. Therefore, their membership in this RTG was declared null and void, for all practical purposes. As for Slovakia, their expert had a career change after the second meeting, and was unable to participate any further. Unfortunately, he was not replaced and the RTG-022 carried on with the remaining members.

1.3 OBJECTIVES

The Task Group addressed itself to the HF radio emission effects of the new broadband cable transmissions. It investigated and found means that allow calculation of cumulative field strengths of HF noise radiated by PLT or xDSL. This will enable NATO and its nations to determine the threat to military HF radio communications and COMINT systems from PLT and xDSL and to take the appropriate steps. It should be noted here that the determination of the nature and the severity of any possible detrimental effect upon the military systems was outside the RTG’s expertise and ToR.

The work included investigations in the following areas:

- PLT and xDSL networks and their characteristics regarding HF radio noise emission;
- Methods to measure the emissions from PLT and xDSL networks;
- Propagation path loss models appropriate to HF spectrum;
- Procedures and means to model PLT and xDSL systems; and
- EMC analysis methods with respect to cumulative effects.

The Research Task Group chose to concentrate its work on the PLT issue rather than xDSL because:

- PLT will produce the most problems regarding HF interference since power lines have less symmetry and will have impedance discontinuities.
- A great number of PLT In-House systems are expected to be deployed. For example, more than 350000 In-House PLT modems had been sold in Germany by the end of 2004.

- VDSL variants covering the whole HF range are still in the definition phase. Eventual implementation of these systems may not be in sufficient numbers to raise potential interference issues, in the time frame of this RTG. Therefore, RTA is urged to consider a further RTG to deal with the VDSL impact on HF spectrum, if found necessary. The other versions of xDSL have no documented HF interference-causing problems.

1.4 OVERVIEW OF THE STUDY

Chapter 1	Is the introduction to present the background of PLT and xDSL and the objectives of the IST-050/RTG-022 studies.
Chapter 2	Gives an overview on HF radio, its propagation characteristics and users, as well as limiting factors existent and emerging.
Chapter 3	Describes the effects of PLT and xDSL networks contributing to HF radio noise and its technical characteristics, explains different methods used for PLT and xDSL and technical realizations, and finally defines representative PLT and xDSL systems for modelling.
Chapter 4	Deals with interference limits existing or proposed for wire line transmission systems.
Chapter 5	Provides methods of measuring HF radio noise emissions from PLT and xDSL.
Chapter 6	Describes HF propagation models useful for calculation of HF radio interference from distant sources.
Chapter 7	Deals with modelling of PLT and xDSL systems as HF noise sources.
Chapter 8	Describes a method to calculate cumulative HF radio interference from PLT and xDSL, and presents results for selected case studies.
Chapter 9	Presents the conclusions and the recommendations of the IST-050/RTG-022.
Chapter 10	Lists the selected bibliography, from among some 400 documents reviewed/studied by IST-050/RTG-022 over the course of its work timeframe.



Chapter 2 – HF RADIO

High Frequency (HF: 1.6 MHz to 30 MHz) radio is unique in that it can provide reliable long-distance communications, using simple and inexpensive equipment, both within a country and internationally from isolated areas where the communications infrastructure is either non-existent or where access is denied by disaster or military conflict. It is the only practicable means of bridging long distances (up to thousands of kilometres) without the need for intermediate relay facilities, such as satellite or telecommunications line providers. HF radio also includes more localised coverage. One example is military mobile communications including long and short range links to man-packs, vehicles, ships and aircraft.

HF communications are able to provide the services most likely needed, be they voice, data or video traffic at very low cost and with little preparatory work to establish a network. It has these unique properties because of the existence of a natural resource available to virtually everyone on the globe, the High Frequency spectrum and the ionosphere that provides the conduit for the exchange of information.

2.1 CHARACTERISTICS

Besides direct wave propagation, the HF band exhibits ground wave and sky wave propagation characteristics not apparent in other higher frequency bands (Figure 2.1-1). At the lower frequencies near to the transmitter, the ground wave is the dominant mechanism. In this mode, the radio wave essentially follows the curvature of the Earth. The range depends on factors such as transmitter power, frequency (lower frequency gives greater coverage) and surface conditions (wet ground gives greater coverage, with the best conditions for these frequencies being over seawater). The ground wave attenuation is lowest for vertical polarization and highest for horizontal polarization; therefore the antennas for ground wave propagation should be vertically polarized.

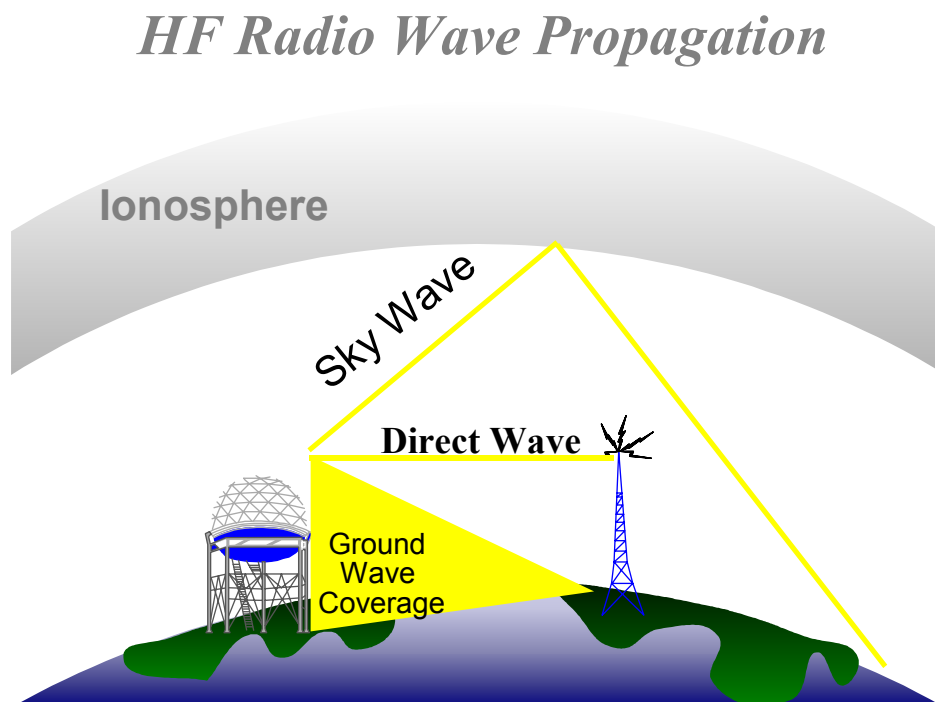

Figure 2.1-1: HF Radio Wave Propagation.

The dominant propagation mechanism in the HF band, where longer distances are involved, is the sky wave. In this mode, radio waves that enter the ionosphere (part of the upper atmosphere) are refracted back towards the earth (height between 100 km and 400 km). The exact amount of refraction depends on the frequency and ionospheric conditions which vary with geographic location, time of day, season and the 11-year sunspot cycle. Radio waves that are launched at high elevations may escape the atmosphere. However, at lower angles, the waves will be bent back down towards the earth and can travel very long distances, especially if they are reflected back up again off the Earth's surface for another 'hop'. Because of this, sky wave is ideal for international communications, including broadcasting. At the lower end of the HF band, virtually all radio waves are reflected back towards the Earth, which enables the use of Near Vertical Incidence Sky wave (NVIS). This is used for national broadcasting in some countries and also for some essential military purposes.

As sky waves change their polarization while propagating through the ionosphere (elliptical polarization) any linear polarization at the receiving antenna may be received. Often horizontally polarized receiving antennas are preferred because generally lower effort is required to obtain the same antenna gain compared to the vertically polarized case.

HF radio signal reception is limited by the ambient radio noise level (Section 2.3) underlying the same wave propagation conditions as the HF radio signals themselves. The variations of HF field strength at the receiving antenna as a function of transmitter power, gain and transmitting direction, frequency, ground conductivity, geographic locations of transmitter and receiver (including their distance), time of day, season (date), and sunspot number (SSN), as well as the ambient radio noise levels, have been extensively studied and are well understood (Sections 2.3 and 6). Modern technology has re-established HF as an important, reliable mode of communications.

The HF signal spectrum has two special features because of the excellent wave propagation conditions, an extremely high signal density (up to 600 signals within 1 MHz bandwidth) and a very high dynamic range (difference between the maximum and minimum signal levels at the input of a receiver, up to 120 dB). These features have to be considered when measuring the ambient radio noise level.

2.2 USERS

There are a number of important new developments that will ensure continued use of the HF spectrum. These involve automatic link establishment (ALE) as well as the replacement of conventional forms of modulation by new digital techniques that are optimised for the propagation characteristics of an HF radio path. These include a new digital broadcasting standard, Digital Radio Mondiale (DRM), which has been developed for high quality international HF broadcasting as well as for national Medium Frequency (MF) broadcasting. Other services such as military communications are using digital modulation techniques to provide reliable and secure long distance communications. A common characteristic to digital communication systems is that although most systems are resistant to interference from narrowband carriers, they are susceptible to interference from broad-band noise-like radio sources such as PLT and xDSL.

Radio frequencies and frequency bands are allocated to different services within the ITU (International Telecommunication Union) Radio Regulations. The International Radio Regulations divide the world into three "Regions":

- Region 1 covers Europe, the "old USSR" areas, and all of Africa;
- Region 2 is North and South America; and
- Region 3 is the rest of the World.

The radio frequency allocations can differ between the three regions.

The current and future use of frequencies in the HF band in Europe may be taken from [2].

2.2.1 Military

In view of the new strategic concept with its increased emphasis on dialogue, crisis management and the prevention of conflict, NATO forces need to possess military attributes such as readiness, deployability and inherent Command and Control capabilities [3]. Also the incorporation of potential non-NATO contributions in contingencies not related to collective defence will have to be accomplished. In addition to the requirements of the operational task and of the single services, there may be other requirements which will generate Control Infra-Structure (CIS) requirements.

Modern HF technology with its specific technical attributes and features can meet the requirements derived from these new roles of the Alliance.

In conclusion, the development of both the doctrine concerning CIS planning for Crisis Response Operations (CRO) and the advancement in modern HF technology will equally contribute to the increasing importance of military HF communications in the future.

Modern communications in the HF band have specific attributes which make it a viable solution for military requirements:

- HF can provide both short-range and beyond line-of-sight communications.
- It is capable of supporting data rates up to about 10 kbps.
- It can support varying degrees of Electronic Protection Measures (EPM) ranging from protection from natural electronic interference to substantial protection from deliberate jamming.
- It is generally available, rapidly and readily deployable.
- It is the only fully military-controlled command system used for long distance secure transmissions, with easy frequency coordination and without additional costs.
- It can be integrated or used in conjunction with many commercial hardware products.

According to [3] “the experience in military missions shows, that HF communication is the only way to distribute missions and progress reports without delays and without the danger of signal jamming. In addition, in case of a nuclear explosion, SATCOM links will be disrupted. By contrast, the HF links will still be available. Disruptions on HF links will be only for a short time”.

In general, adaptive radio systems are used which automatically choose the best frequencies in relation to the propagation conditions for the highest data throughput possible at the actual ambient noise floor situation.

Besides these HF radio links, special units such as crisis reaction forces are using low power radios for their internal communications.

Additionally the Armed Forces are using installations for Communications Intelligence (COMINT: Detection, radiolocation and monitoring of mostly weak signals) within the entire band from 1.6 MHz to 30 MHz.

The use of the HF radio service by the individual military services is as follows:

2.2.1.1 Land Forces

Land forces need HF communications to ensure effective Command, Control and Communications, both within NATO and with PfP Nations. In addition, HF Combat Net Radio communications are used at lower echelons as primary or secondary means where terrain, distance, or mobility requirements preclude reliance on Tactical Area Communications Systems.

2.2.1.2 Air Forces

HF radio is used in the Air environment as the primary beyond-line-of-sight (BLOS) communication means to aircraft, land and maritime mobile platforms. Information is exchanged via HF radio in voice, message and data link formats.

HF communications are used between Air Command and Control ground elements and aircraft for exchanging mission control and surveillance/sensor data at extended ranges and when other communications are not available due to equipment failure or interference. HF is also used for Air Traffic Control (ATC) purposes when beyond the range of VHF facilities.

HF communications between Air Command and Control elements and ground elements mainly are used in a back-up mode when primary and higher capacity means are not available. This includes:

- Backup to NATO Communications Systems;
- Links to PfP and non-NATO elements;
- Links to deployed/mobile entities; and
- Links to tactical formations.

2.2.1.3 Maritime Forces

The NATO maritime community, due to its mobility, uses HF for BLOS communication requirements. Consequently, NATO is modernising its Broadcast and Ship Shore systems. Air/Ground/Air HF communications within the maritime environment are supported by the NATO CIS infrastructure. Within the maritime community, HF is widely fitted throughout NATO and PfP nations, and is common to virtually all warships. Where HF equipment is already fitted, only inexpensive enhancements such as a modem and a PC are generally required to achieve near error-free communications at user data rates significantly better than those used prior to the development of digital signalling techniques.

2.2.2 Broadcasting

The ITU Radio Regulations define the HF broadcast bands whose allocations will not become official until the 2007 World Radio Conference. Currently broadcast band allocations vary from country to country. The Broadcasting service in the USA is covering a total of 3130 kHz in 9 different bands and in Europe a total of 3970 kHz in 11 different HF bands shown in Table 2.2.2-1.

Table 2.2.2-1: Allocated Broadcast HF Radio Bands

Band Name	USA Frequency Range	Europe (EU) Frequency Range	Tropical Bands Receivable in EU
125 Metres	–	–	2300 – 2498 kHz
90 Metres	–	–	3200 – 3400 kHz
75 Metres	–	3950 – 4000 kHz	–
62 Metres	–	–	4750 – 4995 kHz
60 Metres	–	–	5005 – 5060 kHz
49 Metres	5950 – 6200 kHz	5900 – 6200 kHz	–
42 Metres	7100 – 7300 kHz	7100 – 7350 kHz	–
31 Metres	9500 – 9900 kHz	9400 – 9900 kHz	–
25 Metres	11650 – 12050 kHz	11600 – 12100 kHz	–
22 Metres	13600 – 13800 kHz	13570 – 13870 kHz	–
19 Metres	15100 – 15600 kHz	15100 – 15800 kHz	–
17 Metres	17550 – 17900 kHz	17480 – 17900 kHz	–
16 Metres	–	18900 – 19020 kHz	–
14 Metres	21450 – 21850 kHz	21450 – 21850 kHz	–
12 Metres	25670 – 26100 kHz	25670 – 26100 kHz	–

Frequency allocations globally are in a state of transition, so parts of the bands listed may not yet be officially fully available and new ones have been added.

Figure 2.2.2-1 shows measurements of the HF spectrum taken in Germany (FGAN) on 24 to 25 February 2003. All European bands (tropical included) were in use; the lower ones at night, the medium ones all the day and the higher ones only in the day. The levels of receivable HF signals differed up to 100 dB.

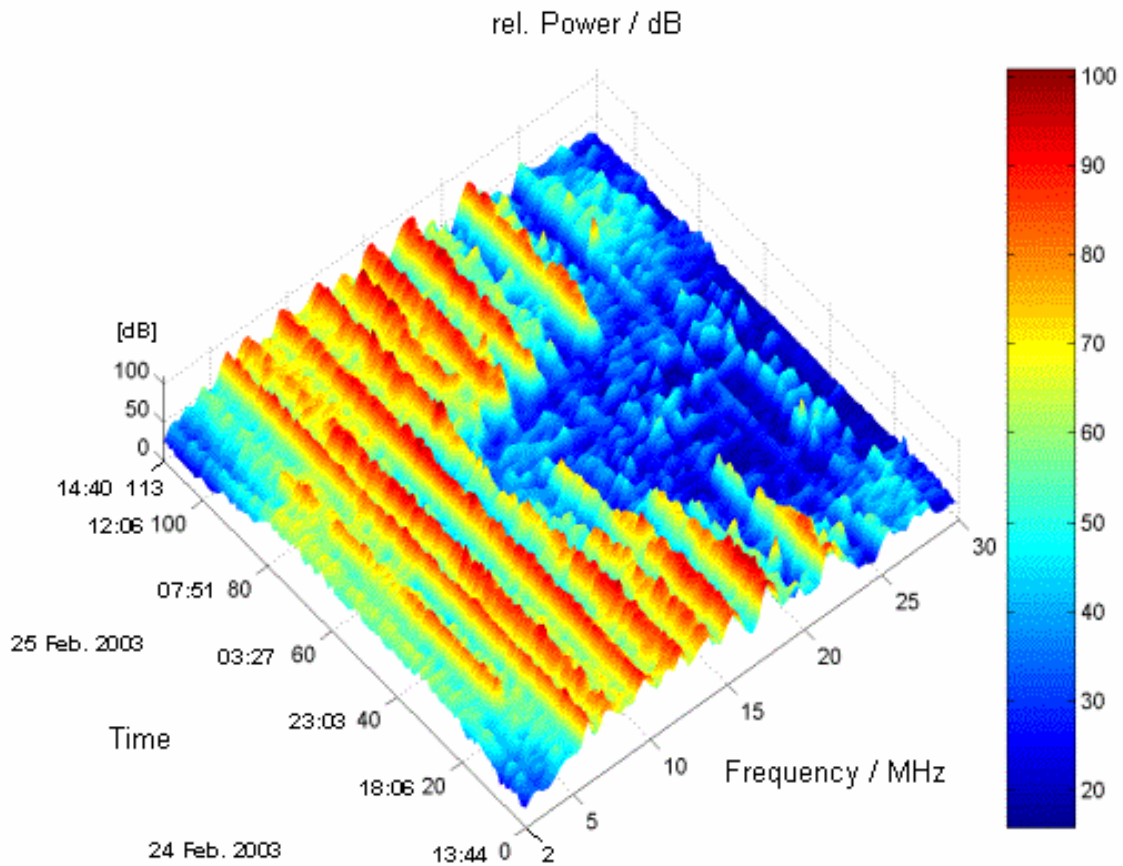

Figure 2.2.2-1: HF Spectrum Measured in Germany during One Day in February 2003 (2 – 30 MHz, measurement bandwidth 100 Hz).

Figure 2.2.2-2 shows similar measurements taken in Norway (by Norwegian Defence Systems Management Division) on 21 November 2004. Here, the measurement bandwidth was 9 kHz, and we see that the variation in measured noise level is 75 dB. This variation is 25 dB smaller than in the German measurements, illustrating the fact that a higher measurement bandwidth precludes measurement of noise only within the measurement bandwidth.

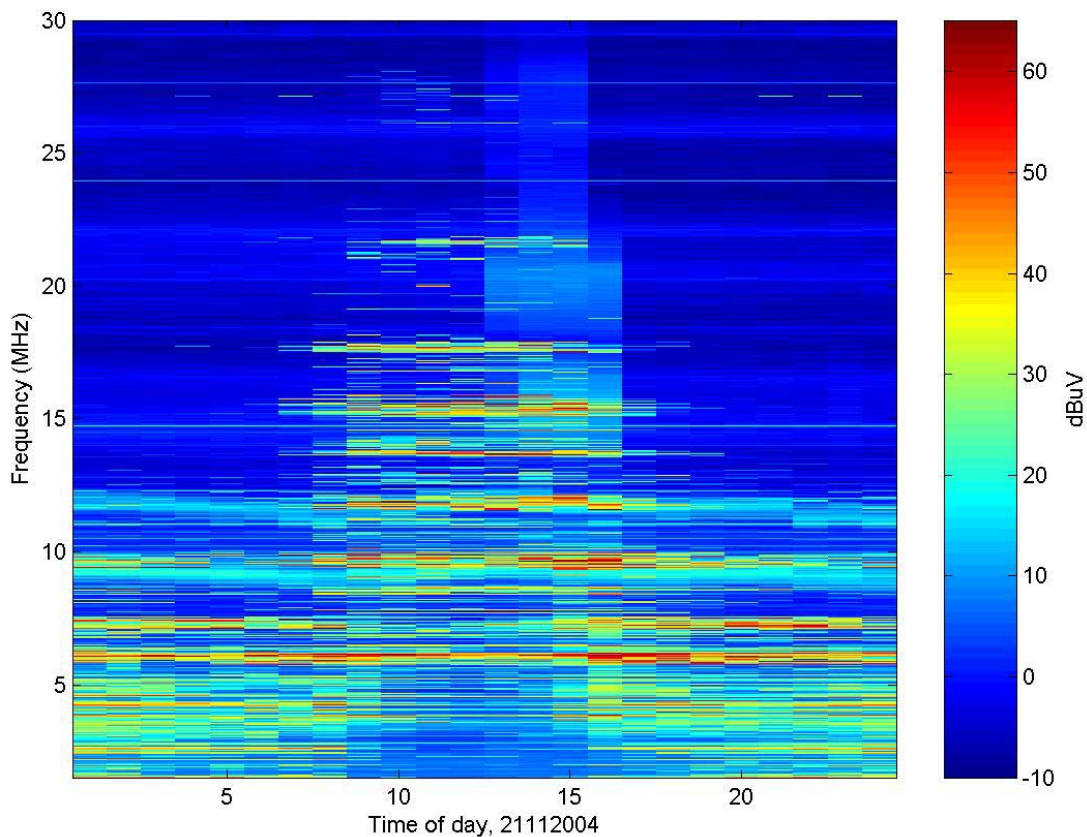

Figure 2.2.2-2: HF Spectrum Measured in Norway during One Day in November 2004 (2 – 30 MHz, measurement bandwidth 9 kHz, average energy measured over 10 ms intervals).

The recommendation ITU-R BS.703 sets out a specification of portable-receiver performance. For the HF band, it specifies that an audio signal-to-noise ratio (SNR) of 26 dB should be achieved for a signal of 40 dB μ V/m with 30% modulation, and that the SNR will increase linearly to at least 40 dB as the field strength is increased [4].

Any increase in the ‘noise floor’ that a particular listener experiences correspondingly will reduce the audible SNR of the station that he currently receives. This effect can also be manifested as a reduction in the choice of available stations, as the weaker ones fall below an acceptable SNR. To put this into context, it may be noted that ITU-R BS.560 sets out *minimum field strengths* for broadcast signals to which full protection against interference from other signals should be provided. For HF, it is specified to be 34 dB above the greater of the level of *atmospheric noise* (given in ITU-R P.372, see Section 2.3), or the *intrinsic receiver noise*, which it gives as 3.5 dB μ V/m (presumed to be RMS).

Most of operational HF broadcasting is currently analogue, using double-sideband amplitude modulation (AM). A very few transmissions are made using single-sideband (SSB) AM, which was proposed (and recommended by the ITU-R) as a replacement for conventional AM. However, this has been overtaken by recent developments in digital techniques. A consortium of broadcasters, manufacturers and operators called *Digital Radio Mondiale* (DRM) has developed a system which is adapted to the various needs of all types of broadcasting in the bands below 30 MHz (long and medium wave, as well as HF). Using the regular 10 kHz of RF bandwidth, DRM delivers an audio signal whose quality is comparable to that of mono FM, without audible background noise or audible effects of fading. It also offers much greater ease of use and will revolutionize long range/wide area broadcasting in terms of quality and

economy. DRM has been approved in the recommendation ITU-R BS.1514. Operational broadcasts started in 2003 using all HF broadcast bands of Table 2.2.2-1.

Under present circumstances DRM will permit some reduction of transmitter power compared with AM operations. This is partly a simple matter of definition. DRM signals are rated by their *mean* power, whereas AM signals are rated by their *carrier* power. Each is in turn related to the *peak* power of the signal, but the relationship for DRM is different from that for AM. If an existing AM transmitter is converted to DRM, the rated DRM power will be less than the rated AM power. This is for two reasons. First, the peak power rating of the transmitter must not be exceeded, and second the interference caused to other existing AM broadcasts must be no greater than that caused by the existing AM transmission that is being replaced. The precise values for the reduction in rated power, and the SNR requirements of DRM, are still being refined by the ITU-R. However, the system is, in effect, designed to work with the same noise floor as AM; any increase in the noise floor will have a deleterious effect. The effect of inadequate SNR on DRM reception will be quite marked: on a steady Gaussian channel reception will cease fairly abruptly as the SNR falls below the necessary level, whereas for a fading channel the proportion of ‘drop-outs’ will increase first, followed by a complete loss of reception. This is a normal characteristic of digitally modulated systems; it is the trade-off involved in reception being very greatly improved compared with AM once the SNR is adequate. However, if the noise floor is raised significantly, an adequate SNR for DRM reception will no longer be ensured. This would have a severe impact on the likelihood of the new system being introduced into service, risking the loss of its many advantages [4].

2.2.3 Other Users

There are a lot of different other users of the HF spectrum shown in Table 2.2.3-1. Details to the different frequency bands allocated and their usage may be taken from [2] and [5].

Table 2.2.3-1: Further Users of HF Spectrum

User	Total Bandwidth	Power	Remarks
Aeronautical Mobile (OR)	EU 1125 kHz USA 845 kHz rest 875 kHz	Base station: 1 kW aeroplanes: 400 W	OR : off route service, non civil aviation, helicopters, incl. "safety of life service"; frequencies all over the HF band
Aeronautical Mobile (R)	EU 1301 kHz USA 1331 kHz		R: route service with aeroplanes, incl. "safety of life service" (ATC, SAR, etc.); frequencies all over the HF band
Amateur	EU 3190 kHz USA 3750 kHz rest 3450 kHz	few W; max. 100 W – 1000 W	bands heavily used: SSB voice (SNR 6 dB) and A1A morse (SNR –6 dB); incl. "emergency nets"; new: digital voice, data, image; frequencies all over the HF band
Amateur - Satellite	2700 kHz		frequencies within the Amateur bands, but >7000 kHz
Fixed	EU 14195 kHz USA 14129 kHz rest 14409 kHz		very limited civil use; embassies, Interpol, Red Cross and similar; news, weather reports; all over the HF band; intensive use by military
Industrial, Scientific and Medical (ISM)	EU 370 kHz USA 652 kHz rest 326 kHz		short range devices
Land Mobile	EU 2554 kHz USA 3213 kHz rest 2150 kHz		limited use in Europe, but more outside; frequencies used <8100 kHz and >24000 kHz
Maritime Mobile	5140 kHz	coast: 1 – 10 kW	incl. Global Maritime Distress and Safety System (GMDSS)
Meteorological Aids	500 kHz		at 27500 – 28000 kHz in all 3 regions, additionally at 2025 – 2045 kHz in EU
Mobile	500 kHz		incl. distress and safety service
Mobile except aeronautical	895 kHz		
Mobile except aeronautical (R)	3259 kHz		intensive use by military
Radio Astronomy	170 kHz		in rural areas at 13360 – 14410 kHz and at 25550 – 25670 kHz; need protection
Radiolocation	30 kHz		below 2170 kHz; need to be protected
Standard Frequency and Time	90 kHz EU: 84 kHz		at 2500 ±5(EU±2) kHz, 5000±5 kHz, 10000±10 kHz, 15000±10 kHz, 20000±10 kHz, 25000±10 kHz

2.3 NOISE LEVEL

In all radio communications, the limiting factor is the ability to receive weak signals against the background noise. However, because of the characteristics of the HF band, this background noise is not the noise generated in the receiver (as it is on VHF and higher frequencies), but the ambient noise in the external environment. In effect this noise enters the receiver via the antenna along with the wanted signals, so that the radio environment is part of the receiving process.

The **ambient noise environment** consists of two parts, the irreducible residual **ambient noise** which is more or less constant in any particular location, and **incidental noise** from local man-made sources. The combination of these two determines the minimum usable signal level.

Contributing to the ambient noise environment are:

Natural Noise Sources:

- Atmospheric noise, a major source of which is almost continuous lightning activity around the equator (ca. 100/s have been measured) from which interference is propagated to the rest of the world by ionospheric reflection. The overall noise level depends on frequency, time of day, season of the year, sunspot number and location. In temperate zones, noise from this source is relatively low, compared to the equatorial zone, although there will be short bursts of noise from local electrical atmospheric activity (thunderstorm) at certain times.
- Cosmic noise originates from outer space. The main generator of radio noise is the sun, along with atmospheric gases and star clusters. In the HF band the cosmic noise reaching the antenna depends on the screening effect of the ionosphere. At lower HF frequencies (<10 MHz) it is impractical to distinguish between cosmic noise and the general background noise from other sources.

Man-Made Noise Sources:

Man-made noise derives from electrical, electronic or radio equipment and exhibits two effects. Firstly, there is the contribution from a large number of relatively distant sources. This noise is effectively “white” and one of the constituents of the ambient noise floor. Secondly, there is incidental noise from local sources the level of which varies, depending on the type of environment. Environments are classified as business, residential, rural and quiet rural [6],[85],[86]:

- “Business” areas are defined as any area where the predominant usage throughout the area is for any type of business (e.g., stores and offices, industrial parks, large shopping centres, main streets or highways lined with various business enterprises, etc.).
- “Residential” areas are defined as any area used predominantly for single or multiple family dwellings with a density of at least five single family units per hectare and no large or busy highways.
- “Rural” areas are defined as areas where dwellings are no more than one every two hectares.
- Carefully selected quiet receiving sites in “Quiet Rural” areas were selected for measurement of the “minimum” man-made noise.

From the radio users’ point of view, the difference between these environments is the level of the noise and the length of time for which it persists. Experience has shown that in industrial or business locations, HF communications is very much impaired by incidental noise which may be present at a high level all the time. In residential locations, the percentage of the time that severe incidental interference is evident on any particular band of frequencies is much less and HF communications is practical, though conditions are not ideal. In rural and quiet rural locations, incidental noise is rare and HF communications is optimal.

Figures 2.3-1 and 2.3-2 show the “natural noise” and the “man-made noise” according to measurements performed in the USA in the 1970s and recommended by ITU [86]. These are **median** values of the external noise figure F_a (F_{am} in Figure 2.3-2) for a short vertical monopole antenna above perfect ground. “For the atmospheric noise curves (Figure 2.3-1), all times of day, seasons and the entire Earth’s surface have been taken into account.” The median values of man-made noise power (Figure 2.3-2) are averaged over all times and a lot of different locations. The lower and upper decile deviations of the noise power with time are about -5 dB and $+10$ dB respectively, and the corresponding deviations with location are about ± 7 dB (Table 2 in [86]).

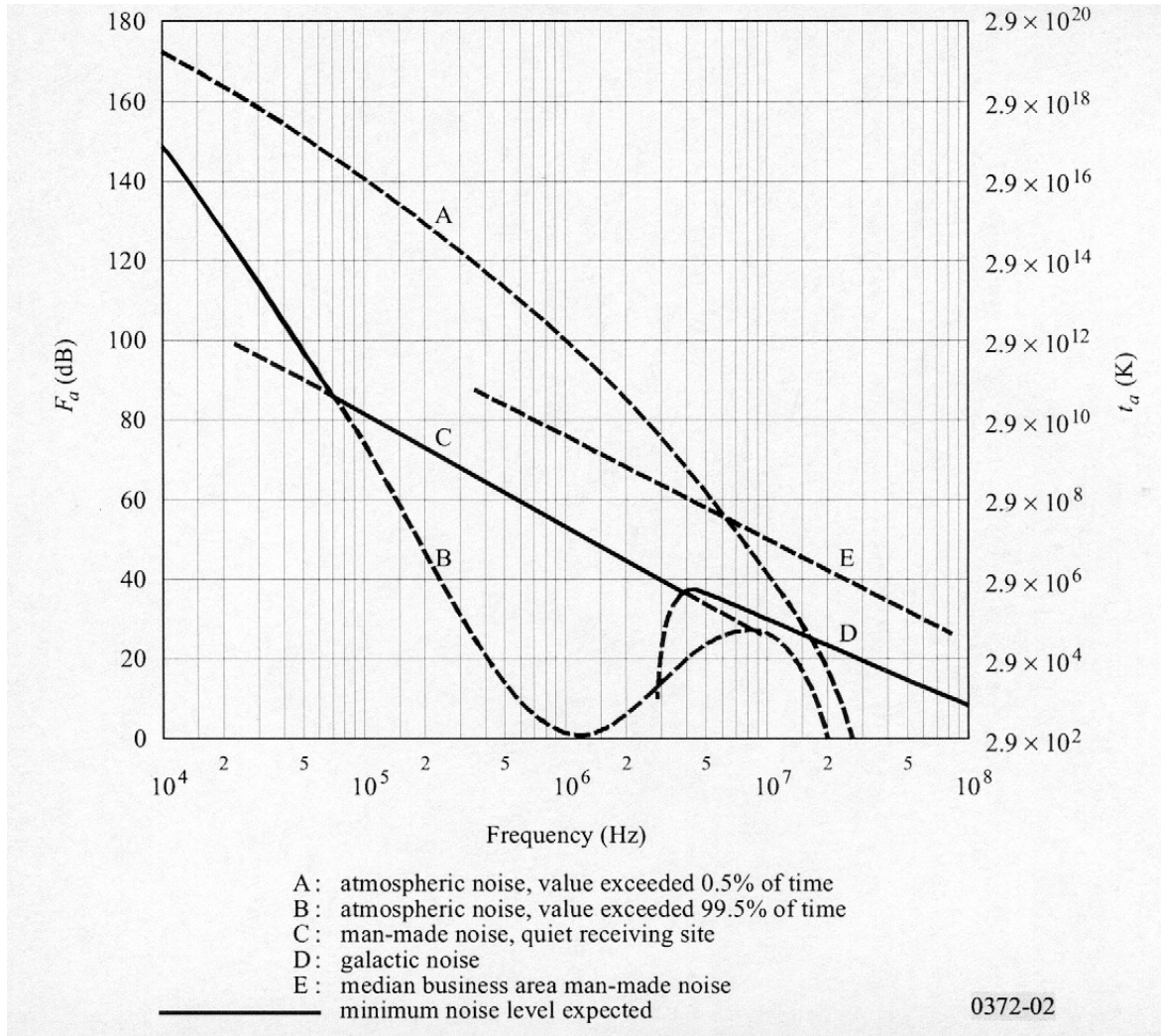

Figure 2.3-1: Median Values of Natural Noise Power for a Short Vertical Lossless Grounded Monopole Antenna.

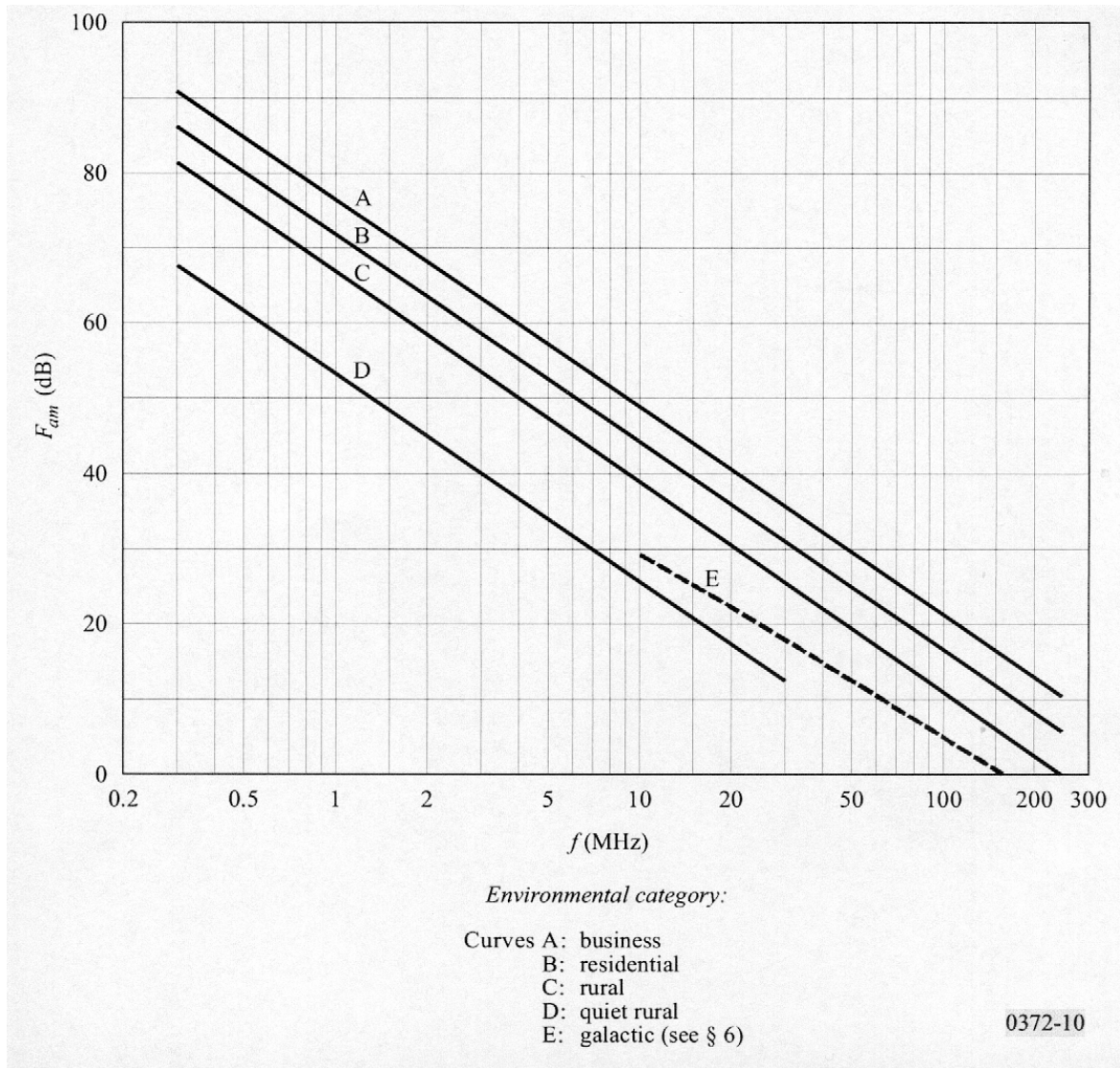

Figure 2.3-2: Median Values of Man-Made Noise Power for a Short Vertical Lossless Grounded Monopole Antenna.

The external noise figure is defined as:

$$F_a = 10 \cdot \log_{10} f_a \text{ dB} \tag{2-1}$$

with the external noise factor f_a defined as:

$$f_a = p_n / (k \cdot t_0 \cdot b) \tag{2-2}$$

p_n : available noise power from an equivalent lossless antenna

k : Boltzmann's constant = $1.38 \cdot 10^{-23}$ J/K

t_0 : reference temperature (K) taken as 290 K

b : noise power bandwidth of the receiving system (Hz)

Equation (2-2) can be written:

$$P_n = F_a + B - 204 \quad \text{dBW} \quad (2-3a)$$

where:

$$P_n = 10 \cdot \log_{10} p_n \quad \text{available power (W)}$$

$$B = 10 \cdot \log_{10} b$$

and $-204 = 10 \cdot \log_{10} (k \cdot t_0)$

The available noise power spectral density can hence be written

$$P_n = F_a - 174 \quad \text{dBm/Hz} \quad (2-3b)$$

For a short ($h \ll \lambda$) vertical monopole above a perfect ground plane, the vertical component of the RMS field strength is given by [86]:

$$E_n = F_a + 20 \cdot \log_{10} f_{\text{MHz}} + B - 95.5 \quad \text{dB}\mu\text{V/m} \quad (2-4)$$

where:

E_n : field strength in bandwidth b ,

and f_{MHz} : centre frequency (MHz).

Similarly for a half-wave dipole in free space [86]:

$$E_n = F_a + 20 \cdot \log_{10} f_{\text{MHz}} + B - 99.0 \quad \text{dB}\mu\text{V/m} \quad (2-5)$$

The atmospheric noise is modelled as shown in Table 2.3-1 [3]:

Table 2.3-1: Formulas Reflecting the Level of the Atmospheric Noise, 99.5% Value Exceeded

Frequency Range	Formulae
1.5 – 10 MHz	$F_a = 27.8 - 0.35 \cdot (8.2 - f_{\text{MHz}})^2$
10 – 15 MHz	$F_a = 46.4 - 1.98 \cdot f_{\text{MHz}}$
15 – 20 MHz	$F_a = 66.8 - 3.34 \cdot f_{\text{MHz}}$
20 – 30 MHz	0

These formulas were derived from Rec. ITU-R P 372-8 using a graph that represents the 99.5% of time value exceeded situation and f is frequency in MHz.

The man-made and galactic noise is modelled as:

$$F_{\text{am}} = c - d \cdot \log_{10} f_{\text{MHz}} \quad (2-6)$$

with values as shown in Table 2.3-2 for c and d :

Table 2.3-2: The Constants *c* and *d* in Equation (2-6) for Various Types of Area

Type of Area	<i>c</i>	<i>d</i>
Business	76.8	27.7
Residential	72.5	27.7
Rural	67.2	27.7
Quiet Rural	53.6	28.6
Galactic (10 – 30 MHz)	52.0	23.0

The ambient noise floor has been **measured** by several organisations including the ITU, the British BBC, DERA (Defence Evaluation & Research Agency, now QinetiQ) and RSGB (Radio Society of Great Britain) and the German TST (Telefunken Systemtechnik). Making these measurements requires great care. In particular it is essential to select a radio frequency that is not occupied by an existing radio signal. It is almost impossible to find spot frequencies where there is a 9 kHz band without any signals. Because of this congestion, sweeping the HF band using an EMC measuring receiver with a 9 kHz bandwidth does not measure the background noise level. Additionally, measurements made with a typical loop EMC measuring antenna will be limited by the noise of the receiver system, not the environmental noise.

To carry out a swept measurement of the true ambient noise floor at HF, a much narrower bandwidth than 9 kHz – something in the order of 100 – 200 Hz – should be used (compare Figures 2.2.2-1 and 2.2.2-2), and the noise produced by the measuring system itself has to be lower than the ambient noise to be measured. The results of the noise measurement are then converted to a 9 kHz bandwidth for comparison purposes with field strength limits (see Section 2.4) which rely on that bandwidth in the HF-range.

Usually, it is impractical to measure the ambient noise floor in industrial or business locations where the man-made noise will exceed the natural noise floor. The best locations for measuring the ambient noise floor without being influenced by man-made noise will be in rural or in quiet rural areas.

In interpreting published plots of the ambient noise floor, it is important to take into account the conditions of measurement, particularly the bandwidth and the detector used, peak, quasi-peak or average, and the type of antenna.

Figure 2.3-3 shows low natural noise measured in Germany at night and in the day. The measurements with 200 Hz measurement bandwidth were done in July 1971 (SSN = 80, medium), October 1979 (SSN = 180, high) and April 1985 (SSN = 20, low) in the same quiet rural area. There had been no remarkable change of the minimum noise level, so only the results of the measurements 1985 are shown.

Natural Noise: Minimum Values

Measured by Telefunken/TST 1985 in Germany (quiet rural), converted to bandwidth 9 kHz

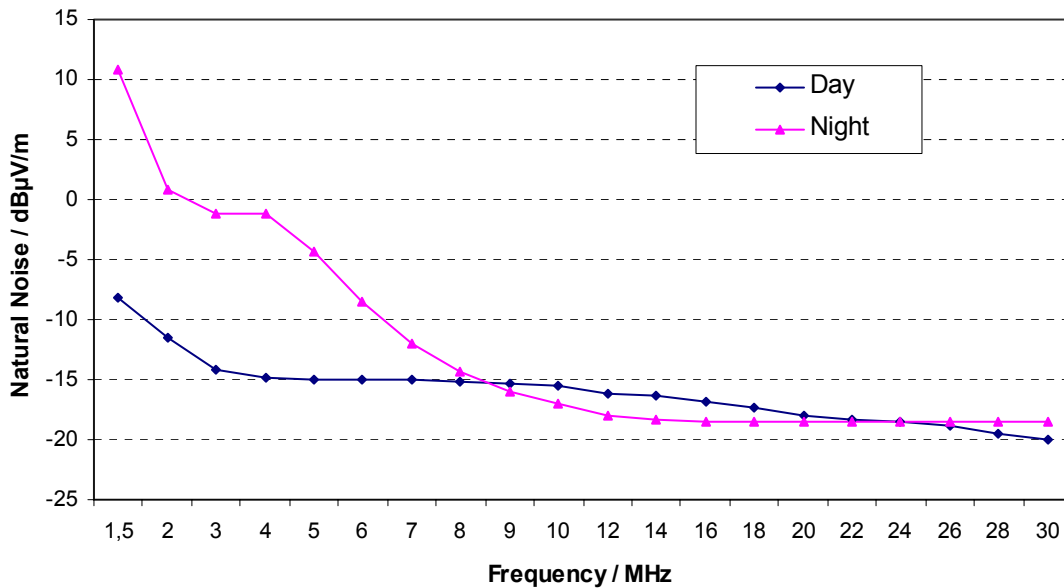

Figure 2.3-3: Low Natural Noise Measured in Germany.

In the lower HF-range the natural noise substantially differs between day and night because of the absorbing D-layer of the ionosphere (height ca. 60 – 90 km) missing at night. The signal absorption in this layer in the day decreases with increasing frequency.

The natural noise in the day should be fundamental to the protection requirements for HF-receivers (see Section 2.4).

Recently, European representatives of different interests, in presentations and discussions have argued (without being able to prove it) that the ITU Recommendations based on measurements carried out in the 1970s (Figures 2.3-1 and 2.3-2) are no longer valid, as the man-made and the ambient noise levels have increased since that time to considerable higher values (by up to 30 dB). Contrary to that, different noise measurements in Germany (1971, 1979 and 1985 by TST, as well as 2003 by the University of Karlsruhe [7],[87]) and in Great Britain ([4], Appendix N, Figure 2.3-4) have proven that the ITU Recommendations for natural and man-made noise in the HF-range are still valid in Europe. Figure 2.3-4 shows minimum field strengths measured in 1985 (and in the 1970s) in North Germany compared with corresponding measurements of 2001 in Southern Britain. There is no remarkable difference between the measurements, specifically **no increase of the ambient noise within the last 30 years**. The noise measurements by the University of Karlsruhe 2003 in rural zones in South-West Germany also indicated no increase compared to ITU-R P.372-8 (curve C in Figure 2.3-2). Figure 2.3-4 also shows median ambient noise field strengths recommended by the ITU for Central Europe in summer and winter in the day, as well as median man-made noise field strengths. These median values are about 5 – 10 dB higher than the measured minimum values, which is in accordance with ITU-R P.372-8 (Figures 17a/b/c – natural noise in Winter; Figures 29a/b/c – natural noise in Summer; and Table 2 – man-made noise). Thus, there is no increase in the ambient HF noise level actually measured in UK and Germany compared to the ITU Recommendations (based on measurements of the 1970s).

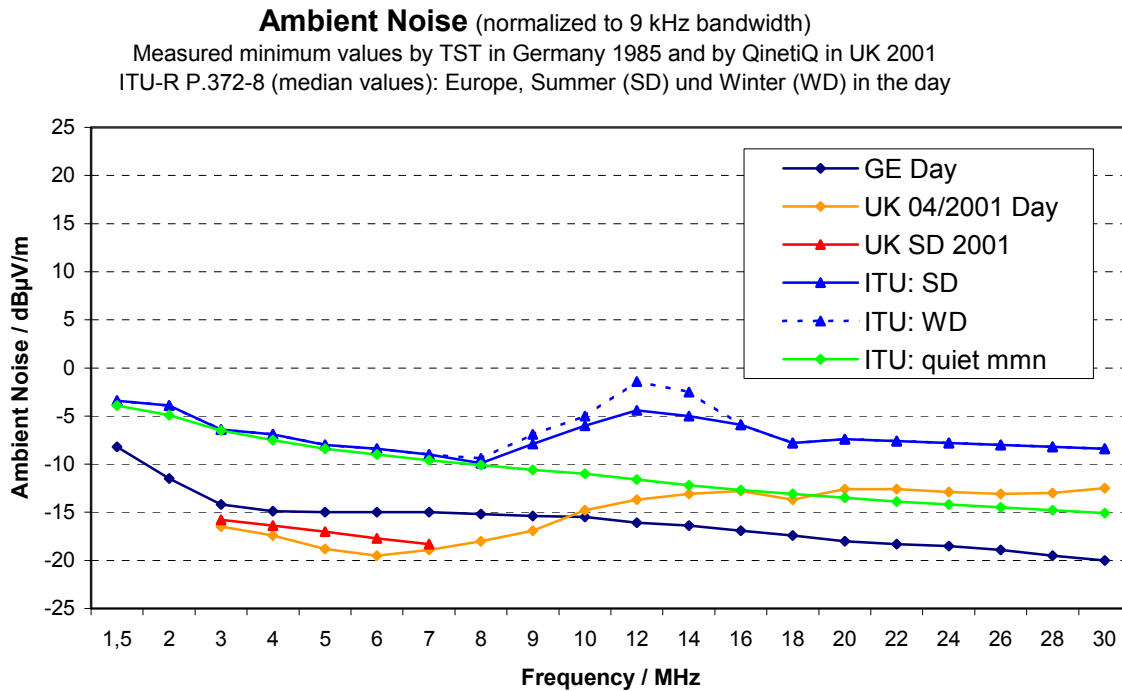

Figure 2.3-4: Minimum Natural Noise Measured in Germany 1985 and in UK 2001 and ITU-Recommendations for Median Natural and Man-Made Noise in Europe (mmn: median man-made noise in quiet rural areas).

2.4 PROTECTION REQUIREMENTS

The various HF radio services possibly affected by unwanted radiation from the new broadband wire-line telecommunication networks are described in Section 2.2.

As the sensitivity of HF receiving systems in general is determined by the ambient noise, the protection requirements are derived from the ambient noise levels specified in ITU-R P.372-8, as well as from the minimum noise measured in Europe.

PLT and xDSL will cause unintentional RF emissions which may increase the established radio noise floor directly nearby or by cumulative propagation far away from many such sources. This type of emission is quite different from that produced by electronic devices and equipment: it is broadband noise, most of the time with a high level, and extending over the HF band.

The incidental noise generated even by devices and equipment compliant with relevant EMC standards can greatly exceed the existing noise floor. Then, reception of low-level HF signals is possible only because of the statistical nature of this incidental noise. Many devices radiate near the limit of their standard on only a few discrete frequencies, or on a narrow band of frequencies. In addition most incidental noise is relatively short lived. HF communication services are opportunistic, i.e., frequencies and time are chosen to optimise the probability of a satisfactory signal-to-noise ratio. If incidental noise prevents communication at any particular time, the transmission is repeated at a later time when the interference has ceased. In automatic systems this is built into the operating protocol, but it doesn't work with a broadband noise floor steadily increased by PLT and/or xDSL.

Protection of HF radio-communications and -intelligence from interference by broadband wire-line telecommunications may be realized by limiting their emissions (Section 4). From the perspective of NATO, it is desirable that these limits be harmonized, for the following reasons:

- Emissions from wire-line communications travel long distances and past international boundaries, therefore, differences in emission limits introduce additional difficulties to the interference assessment and mitigation functions; and
- Different emission levels, thus different PLT-induced increases in ambient noise levels, have the potential to affect interoperability within NATO.

Therefore, it is necessary to find worldwide harmonized standards covering EMC aspects of wire-line telecommunication networks including their in-house extensions. These standards should ensure that broadband wire-line telecommunications will not degrade HF radio reception directly in the immediate vicinity of the wire-lines, as well as far away from mass-deployed telecommunication networks by cumulative interference.

Regarding possible increase of the existing HF noise floor by widespread use of PLT and/or xDSL, the minimum noise levels measured in Europe (Figure 2.3-4) should be fundamental to the protection of sensitive HF receivers. This is supported by UK conclusions from measurements ([4], Appendix N) that state: “An increase above 3 dB over the existing noise floor will reduce the availability on HF circuits and is likely to cause severe problems (... confirmed by the MoD)”. Based on above measurement results, the cumulative interference field strengths far away from telecommunication networks should not be higher than **-15 dB μ V/m** (9 kHz bandwidth) across the entire HF-range, if no measurable increase in minimum noise levels are to be tolerated. The Task Group will refer to this criterion as the **Absolute Protection Requirement**. It should be noted that this value is in the range of 10 to 1 dB below the ITU-R Quiet Rural noise curve, which are median values, across the HF band (Refer to Figure 8.2.1-1).



Chapter 3 – CHARACTERISTICS OF PLT AND xDSL TRANSMISSION SYSTEMS

Since 1998 there are many developments underway to give commercial and domestic users access to wideband high-data rate systems, some of which use the “existing copper infrastructure”, for example, electricity mains or telephone lines.

Signalling over the mains network has existed for many years at operating frequencies up to 148.5 kHz in Europe and 525 kHz in USA, Canada and Japan, in the form of low data rate transmissions. To achieve higher data rates, new developments in modem technology showed that it was possible to use higher frequencies and wider bandwidths to communicate along the mains, using frequencies from 1.6 to 30 MHz (USA and Canada: up to 80 MHz) and with data rates of several Mbps.

Telephone wires in particular have been used to provide Internet access for some time. The signals have been restricted to the voice band (300 Hz to 3.4 kHz) so that they can use the Public Switched Telephone Network (PSTN). To achieve higher data rates, greater bandwidth is needed, and this requires higher frequencies of transmission. Bandwidth utilisation has increased to over 10 MHz for Very high-speed Digital Subscriber Line (VDSL), one of the xDSL family, operating at higher speeds than Asymmetric Digital Subscriber Line (ADSL).

PLT potentially offers transmission of data and Voice over Internet Protocol (“VoIP”) via normal electrical power lines that are incorporated in every household. The main application of PLT also could be described as “Internet from the socket”. The benefit of PLT is that it uses the already existing and widely deployed electricity network, permitting new services without the need for additional wiring.

PLT technology is feeding a high data rate signal into a local mains power supply network to which all energy, as well as telecom customers, are connected in parallel.

Due to this, the transmission capacity of the system has to be shared among all telecom users who are operating simultaneously. In addition, even if only one telecom customer shall be supplied with a PLT-based data service, the whole area of the local power supply network is carrying the transmission signal and acting as an area radiator.

In contrast to PLT technology, DSL technology supplies each DSL customer separately with an individual telephone cable. The transmission capacity of the DSL system does not have to be shared among several telecom users operating simultaneously.

The electricity and telephone wirings used for broadband data transmission and its potential for unwanted HF emission are described in detail in the following paragraphs.

Parts of this chapter are based on [32].

3.1 TRANSMISSION ON POWER LINES (PLT)

Electricity usually is generated in remote power plants, transformed up to high voltage (HV, 230 – 400 kV, 50 or 60 Hz) and sent over long distance via overhead power lines to a grid exit. There substations step the voltage down and supply electricity to local power lines for distribution. Typically, the electricity is transformed to a sub-transmission voltage (66 – 132 kV) using interconnecting transformers and then transformed to medium voltage (MV, 1 – 50 kV). Finally, in the distribution substation, the power is transformed to low voltage (LV, 100 – 240 / 240 – 415 V) [26],[91],[31, Subpart G, Section 15.603].

Power Line Telecommunications use existing power lines to transmit broadband communications in home networking environments and to deliver telecommunication services to homes and businesses. Figure 3.1-1 shows different possible locations of connecting the telecommunications network to the energy network. Levels 1 – 3 are separated by different transformers and level 4 from level 3 by the house access point.

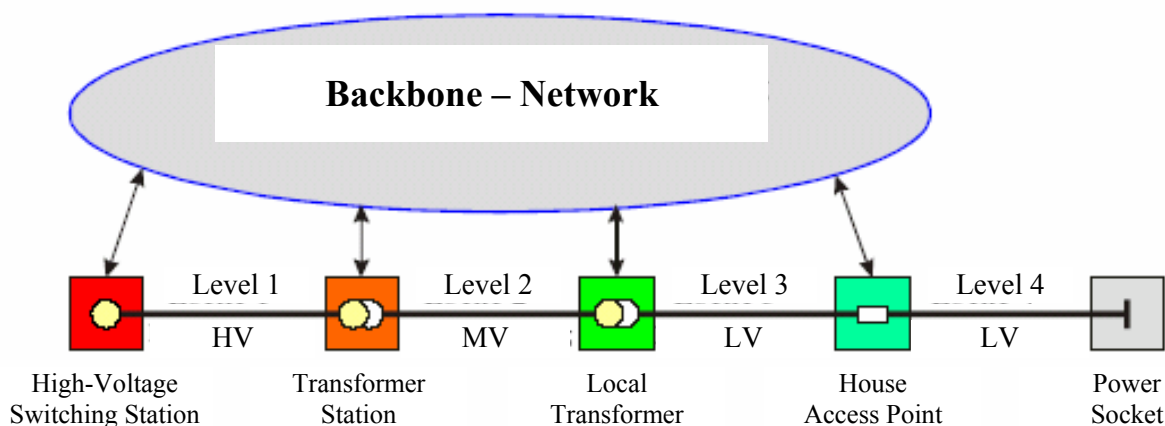

Figure 3.1-1: Alternative Connections between Telecommunications and Energy Networks.

3.1.1 Power Line Systems

Power Line Telecommunications technology (PLT, PLC), or Broadband over Power Line (BPL) in North America, uses the Medium Voltage (MV) or Low Voltage (LV) power distribution network as a telecommunication infrastructure for the transport of broadband HF signals. There presently exist two main families of PLT applications:

- Access PLT (outdoor PLT, connecting the home to the outside) whose target market is the “last mile” between substation and the subscriber, and therefore is an alternative solution for the access to the telecommunication local loop.
- In-House PLT whose aim is to distribute signals (coming for example from Access PLT or from DSL) to the electric plugs inside homes (home networking).

In Europe, PLT Access systems are, generally, overlaid on Low Voltage Electricity Distribution Networks (LVEDNs). The power lines from the LV-Transformer to the individual homes in business and residential areas are underground cables, and in rural and quiet rural zones they are mostly overhead lines. In general, European PLT Access systems utilize underground cables, as HF radiation from overhead power lines is supposed to be much too high. Figure 3.1.1-1 shows the broadband signal flow in a usual Access System (Transformer Substation – House Access Point), In-House System (House Access Point – Mains Sockets), and the potential connection points for PLT modems.

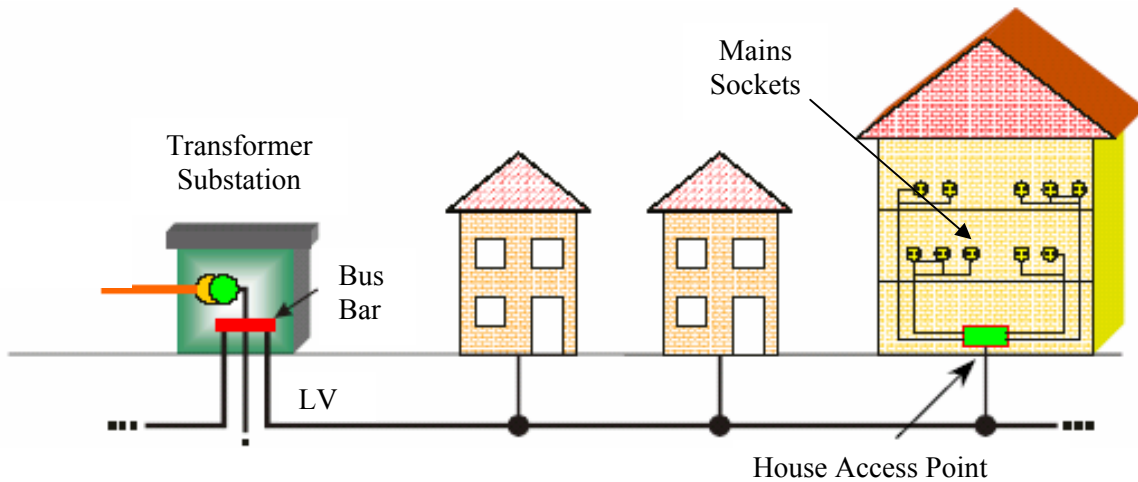

Figure 3.1.1-1: Basic PLT System in Europe with Three Different Potential Connection Points for PLT Modems (arrows).

In the USA, Canada, Japan and some other countries outside Europe, BPL (PLT) Access systems generally also include parts of the Medium Voltage Electricity Distribution Networks (MVEDNs). Figure 3.1.1-2 illustrates the basic BPL Access and In-House system, which can be deployed in cell-like fashion over a large area served by existing MV power lines. Access BPL equipment consists of injectors (also known as concentrators), repeaters and extractors. BPL injectors are tied to the Internet backbone via fibre or T1 lines and interface to the Medium Voltage power lines feeding the BPL service area.

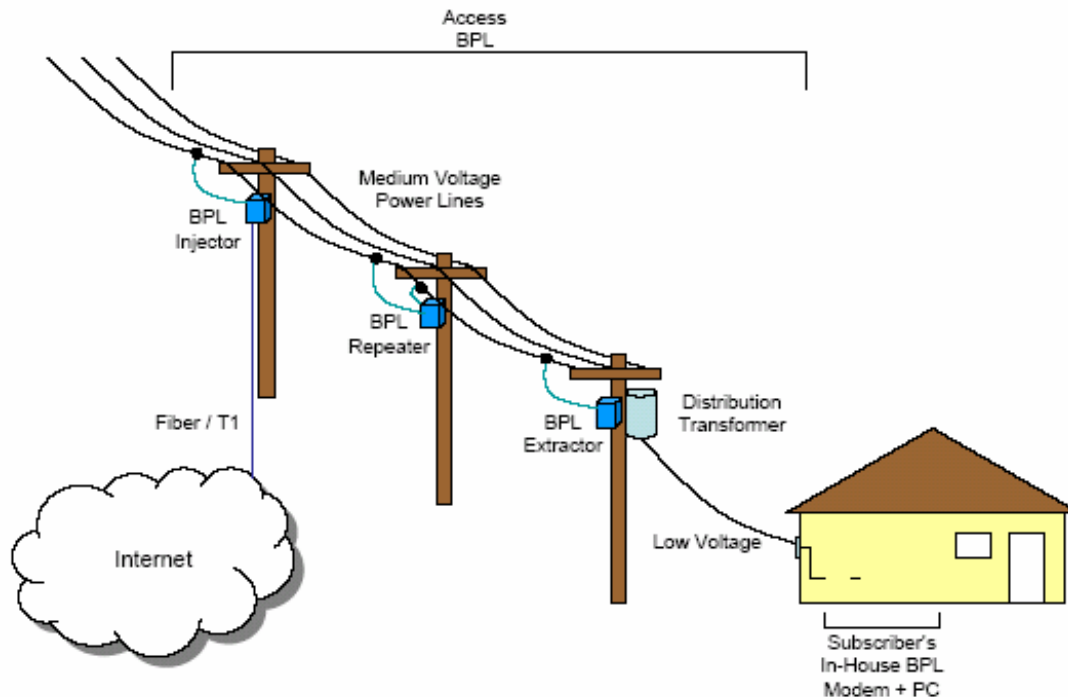

Figure 3.1.1-2: Basic BPL System.

3.1.2 Medium (MV) and Low Voltage (LV) Systems

In the USA, Canada and other countries outside Europe, MV power lines may be overhead on utility poles or underground in buried conduit. Overhead wiring is attached to utility poles that are typically 10 metres above the ground. Three phase wiring generally comprises an MV distribution circuit running from a substation, and these wires may be physically oriented on the utility pole in a number of configurations (e.g., horizontal, vertical, or triangular). This physical orientation may change from one pole to the next. One or more phase lines may branch out from the three phase lines to serve a number of customers.

A grounded neutral conductor is generally located below the phase conductors and runs between distribution transformers that provide Low Voltage (110/220 V) electric power for customer use. The neutral lines at LV consumers are earthed by connection to this grounded neutral conductor (TN-C, see below).

PLT signals may be injected onto power lines between two phase conductors, between a phase conductor and the neutral conductor, or between a single phase or neutral conductor and earth.

Extractors (see Figure 3.1.1-2) provide the interface between the MV power lines carrying PLT signals and the households within the service area. BPL extractors are usually located at each LV distribution transformer feeding a group of homes. Some extractors boost PLT signal strength sufficiently to allow transmission through LV transformers and others relay the PLT signal around the transformers via couplers on the proximate MV and LV power lines. Other kinds of extractors interface with non-PLT devices (e.g., Wireless Fidelity /WiFi™) that extend the PLT network to the customers' premises.

For long runs of MV power lines, signal attenuation or distortion through the power line may lead PLT service providers to employ repeaters to maintain the required PLT signal strength and fidelity.

Power distribution systems differ in handling Low Voltage N lines (Neutral) and PE lines (Protection Earth). Most European countries use the TN or TT system (first letter T: The transformer neutral is earthed; second letter N: The frames of the electrical loads are connected via earth conductors to the earth provided by the supplier; second letter T: The frames of the electrical loads are connected via earth conductors to a local ground connection). If the TN system uses one (combined) connector for N and PE (PEN), a "C" is added. Figure 3.1.2-1 shows a typical German TN-C-S network; the "S" added means that N and PE are separated out in the in-house installation. This is for separate in-house distribution of N and PE and in-house potential equalization (connections to local earth and metallic conduits).

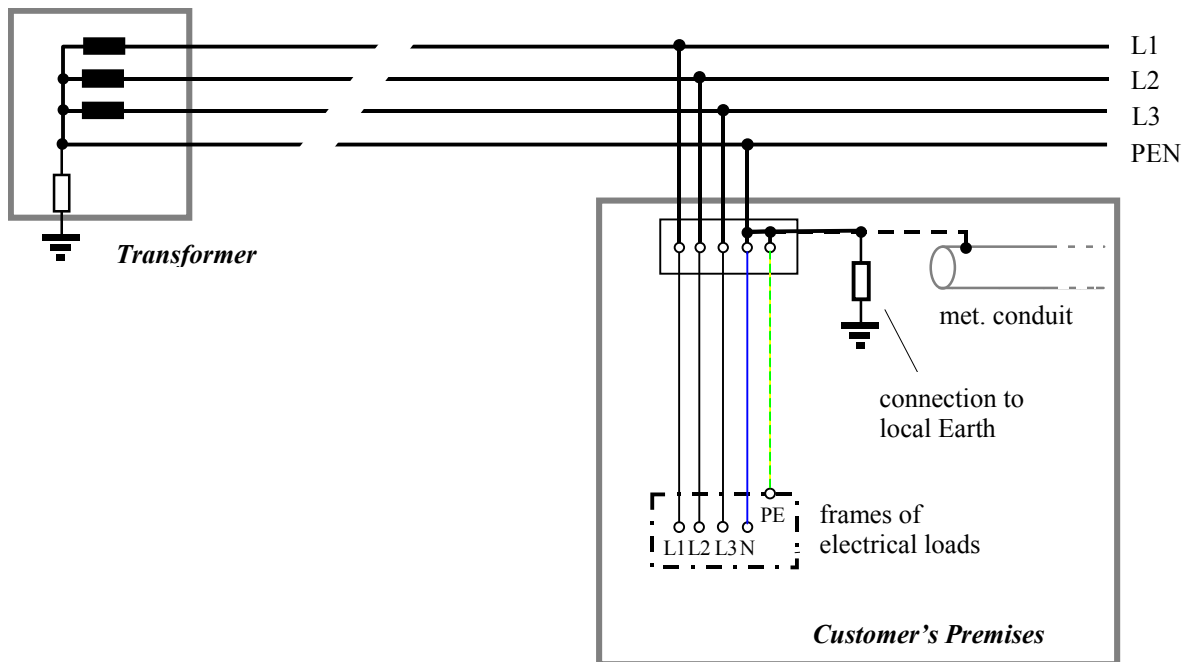

Figure 3.1.2-1: Power Line TN-C-S Network.

In Norway, the legacy power distribution system differs from most other countries in one important aspect: Other than most European countries, Norway and Albania use the IT system (I: Transformer Neutral is isolated) [26],[91]. In the IT system, ground is not distributed to the customers' premises, but established locally at each site by connecting to earth. IT systems may operate with ground fault (one of the phases connected to ground), and therefore ground faults in IT systems are not always detected. There is a possibility, which has not yet been investigated, that PLT over the IT system may impose more interference than over the TN system: The common-mode signal will be injected between the wiring and the earth, and in case of an undetected ground fault, the differential signal will actually be injected between the earth and the fault-free phase.

Power distribution installations to new houses in Norway use the TN system.

In the following paragraphs Access and In-House systems are described in detail with respect to possible impedance discontinuities, which are sources of HF radiation (see Section 3.1.5).

3.1.3 Access Systems

In Europe usually the local transformer (Figure 3.1-1) is connected to the backbone telecommunications network. The energy distribution system from the LV transformer to the consumers' premises forms the PLT Access system. For different reasons only underground cable systems are regarded.

Figure 3.1.3-1 shows a usual German Low Voltage Electricity Distribution Network (LVEDN) [32]. The LV transformer ("Trafo") is the centre of the network. Up to 10 power lines supply electricity to a maximum of about 400 premises (mean 100 – 200), each power line supplies 30 to 40 premises. The usual length of a line is less than 1 km. Most lines are underground; in rural areas few lines may be overhead with a tendency to be replaced by underground cables. Power supply to each premise is realized by splitting the cable in front of the premises via a sleeve. Additional cable distribution cabinets facilitate meshed networks for better handling of fault situations.

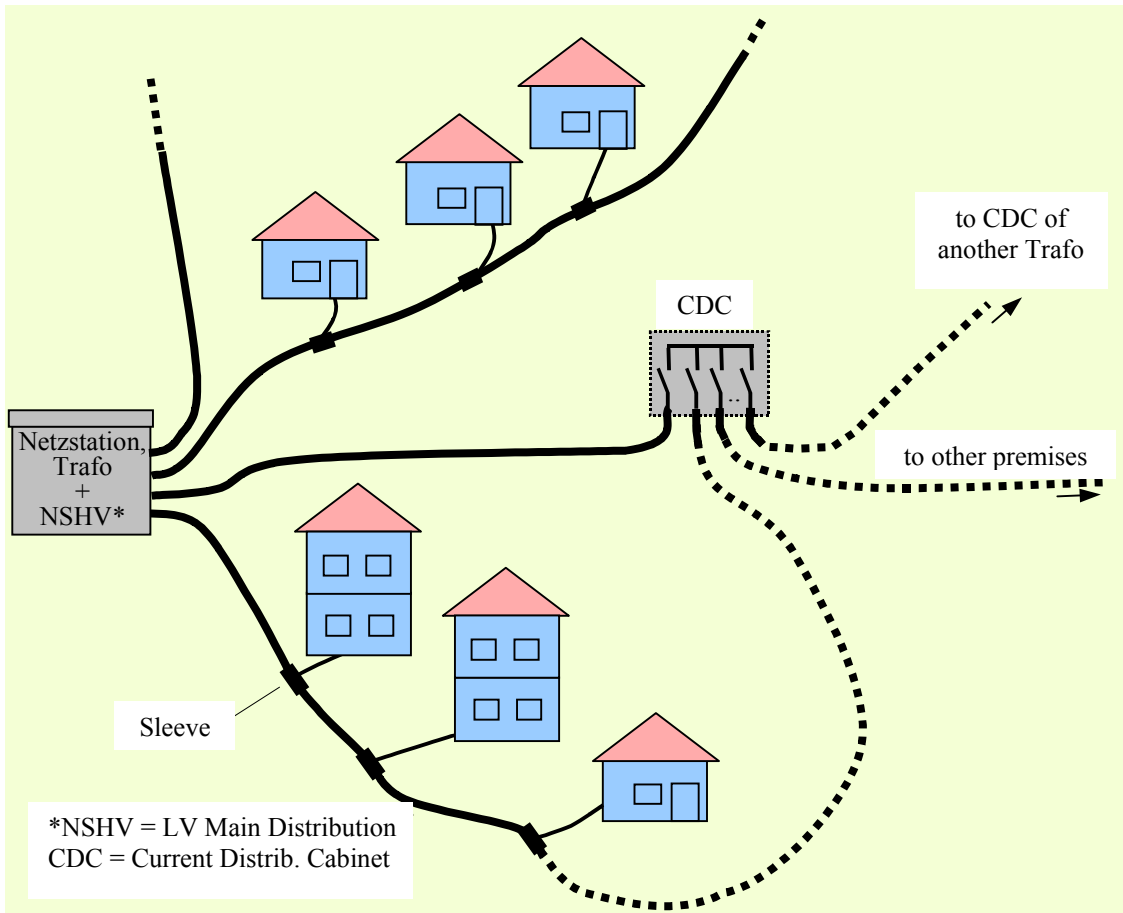

Figure 3.1.3-1: Usual Low Voltage Electricity Distribution Network in Germany.

The usual cables in German Access and In-House systems are of three different types: sector, non-metallic sheathed and flat-webbed wires (Figure 3.1.3-2). The lines leaving the LV transformer, as well as the connection lines from the sleeves to the premises (Table 3.1.3-1), are sector type with different cross sections. In-house wires are non-metallic sheathed or flat-webbed.

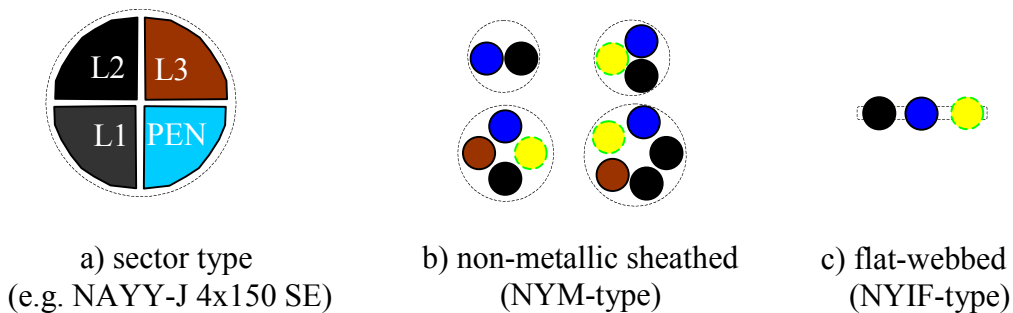

Figure 3.1.3-2: Cable Types mostly used in German Access and In-House Systems.

Table 3.1.3-1: Technical Data of the Lines shown in Figure 3.1.3-2

Type of Cable	Description	Characteristic Impedance	Attenuation in dB/km at 1, 10 and 20 MHz
NAYY-J 4 x 150 SE	4-wire underground main line (150 mm ²)	22 Ω at 1 MHz symmetric mode	12.9 / 46.5 / 51
NAYY-J 4 x 50 SE	4-wire underground line to the premises (50 mm ²)	29 Ω at 1 MHz symmetric mode	16.8 / 53.8 / 58.9
NYM-J 3G x 1.5	3-non-metallic sheathed wires (1.5 mm ²)	75 Ω at 150 kHz	17 / 85.5 / 146
NYIF-J 3G x 1.5 NYIF-J 5G x 1.5	3-flat-webbed wires (1.5 mm ²) 5-flat-webbed wires (1.5 mm ²)	183 Ω at 150 kHz from line to next line	23 / 105 / 180

Sector type cables are optimal for symmetric mode signal transmission [34]. The PLT signal has to be injected onto the two phase conductors L1 and L3. Asymmetric mode signal transmission should be used in-house to get the signal to the most mains sockets; the PLT has to be injected between one or more phase conductors and the neutral conductor.

Some HF signal transmission characteristics of the usual German power lines for “last mile” PLT signal transmission are given in Table 3.1.3-1. The characteristic impedances are quite different because of various line geometries. The attenuation of Access cables is remarkably smaller than that of In-House cables.

Each sleeve in the Access system forms a special power line discontinuity responsible for HF radiation. From the electrical point of view the structure of the sleeve is relative simple as only four wires have to be connected as shown in Figure 3.1.3-3 (see also Figure 3.1.2.-1).

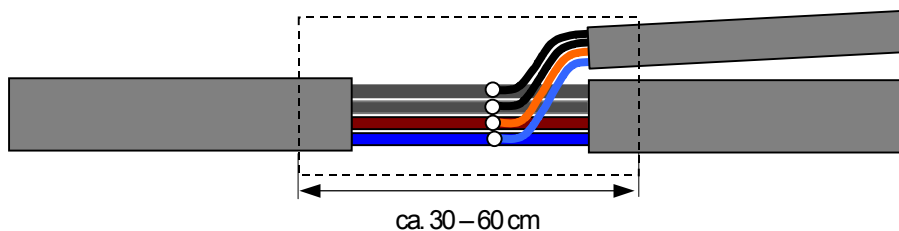

Figure 3.1.3-3: Sleeve for Power Line Distribution to the Premises.

3.1.4 In-House Systems

In this section is described how In-House PLT systems may be installed when Access PLT is used as the means of Internet access. Note, however, that In-House PLT can be used for in-house networking regardless of which method is used for Internet access.

The House Access Point (Figure 3.1.1-1) is the “interface” between the Access system and the In-House system. Figure 3.1.4-1 is an example of this point in case that two apartments have to be power supplied.

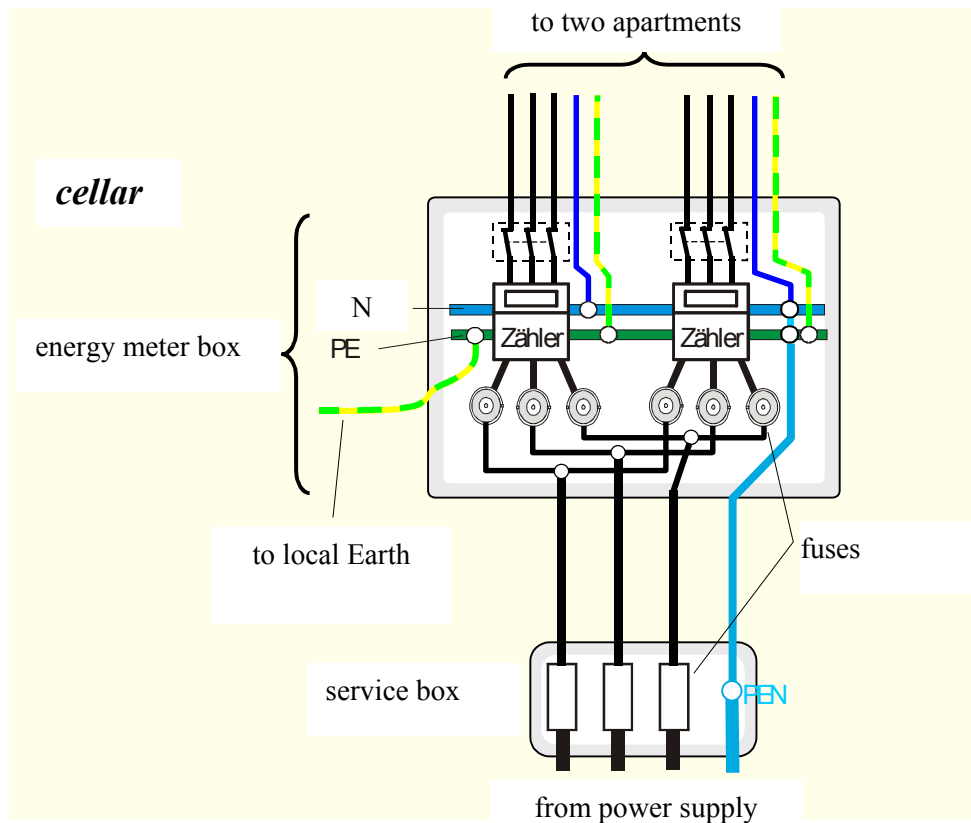

Figure 3.1.4-1: House Access Point in a House with 2 Apartments (Zähler = meter).

The main functions of the House Access Point are the junction of the Access underground cable to the in-house lines, the power distribution to different apartments, the energy meter for each apartment, the prevention of too high currents on the lines by fuses, the in-house separation of PE and N from PEN and the connection of PE to the local Earth (equipotential bonding).

Figure 3.1.4-2 in principle shows the complete in-house system of a house with two apartments, where for one apartment, the power distribution is shown in more detail.

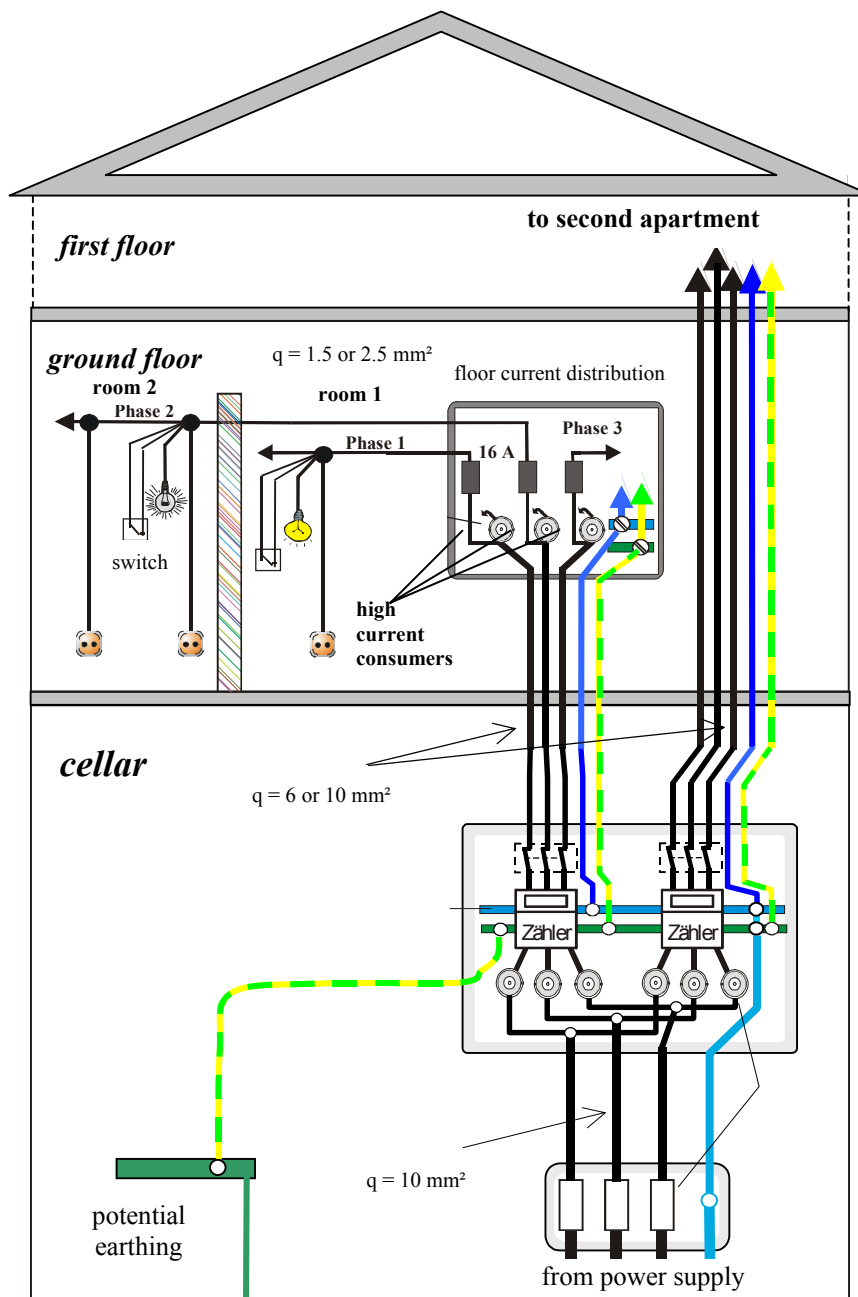

Figure 3.1.4-2: In-House Power Supply Installation (q : cross section).

From the central power distribution 5 lines (3 phases, N, PE) are going to each floor current distribution (apartment), where three lines (1 phase, N, PE) are further distributed to the single rooms of the apartment. The 3 phases are protected by fuses and should be distributed to all rooms of the apartment as equal as possible. Each room has one distribution box minimum; from here different lines are going to fixed installed consumers (e.g., lamps inclusive switches) as well as to wall plugs. High current consumers are supplied by 5 lines. All frames of the electrical loads are connected via PE to an earth connection. In most cases each apartment distribution additionally contains a fault-current circuit breaker; the sum of all currents (3 phases and N, normally about zero) is measured and breaks all circuits, when it deviates considerably from zero.

CHARACTERISTICS OF PLT AND xDSL TRANSMISSION SYSTEMS

As lamp circuits considerably contribute to HF radiation when PLT is used they are specially mentioned here, and as an example two different often used lamp circuits are shown in Figure 3.1.4-3.

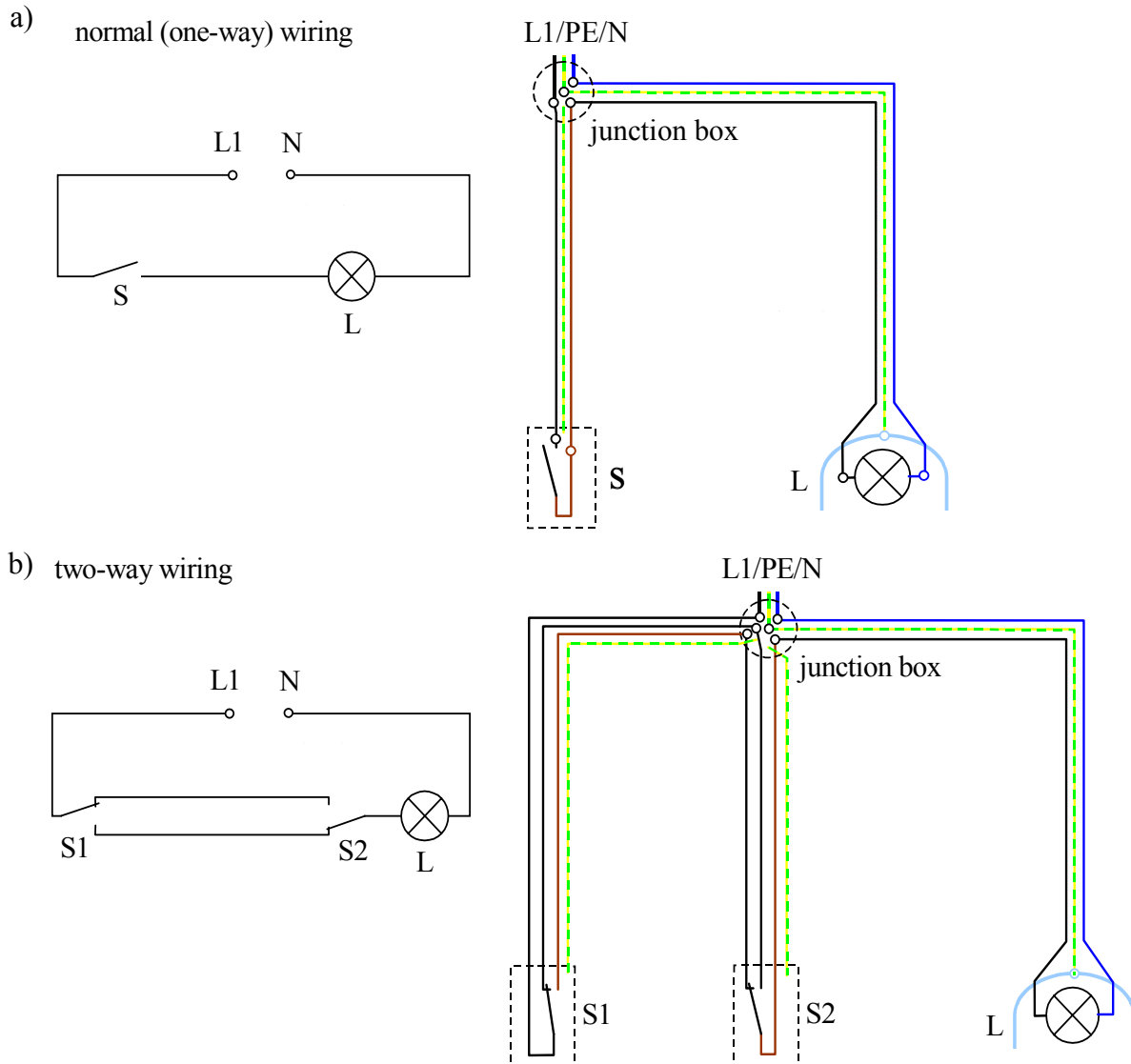

Figure 3.1.4-3: Lamp Circuits with One- and Two-Way Wiring.

In normal case (Figure 3.1.4-3 a)) only one on-off switch (S) is used. Then three wires (L1, PE, N) going to the lamp (L) and minimum two wires (L1, N) going to the switch are necessary. Sometimes an additional wall plug near to the switch is installed; then two more wires (N, PE) are used. When two switches (S1, S2, Figure 3.1.4-3 b)) are used, then a minimum of three wires going to each switch are necessary. The wiring to the lamp is the same as in the one-switch case. If more than two switches are used, then intermediate switches or even impulse relays are utilized (not shown here). Besides fixed lamp circuits shown here also mobile on-off switched electrical loads (stove, refrigerator, washer, percolator, PC equipment, etc.) plugged to mains sockets are in use. Here also one wire is switched; the wire may be Phase or Neutral, depending on the orientation of the plug.

3.1.5 Technical Characteristics with Respect to HF Radiation

PLT devices and the power lines that carry PLT signals have the potential to act as unintentional radiators. The amount of radiation depends on the symmetry of the network at radio frequencies. Symmetry is related to the difference in impedances between conductors and ground, where perfect symmetry corresponds to equal impedances. For a two wire line, if the impedance between each conductor and ground is equal, the line is symmetrical or balanced. A lack of symmetry leads to an unwanted, common mode signal. Common mode currents flow in parallel in both conductors, while return portions flow through ground. Balanced lines are necessary for differential mode transmission in which currents are equal in magnitude and flow in opposite directions on the signal conductors. The fields radiating from these conductors tend to cancel each other in the far-field area. On parallel or nearly parallel, non-concentric conductors, common mode currents at radio frequencies produce more radiation than differential mode currents [33].

PLT lines have poorer symmetry than xDSL lines and will also exhibit impedance discontinuities. Any impedance discontinuity in a transmission line, which may arise from a PLT coupling device, a transformer, a branch or a change in the direction of the line, may produce radiation directly or by reflections of signals forming standing waves that are radiated from the conductors. Even if the RF energy is injected into one of two or more conductors, the remaining wires generally act as parasitic radiators and, therefore, the lines can act as an array of antenna elements at certain frequencies. Radiation may come from one or more point radiators corresponding to the coupling devices, as well as one or more power lines [14].

It has also been recently discovered in Austria that PLT signals may induce higher emissions from mercury vapour street lamps in a broad range of frequencies spanning HF and up to 3 GHz. However, this issue is under further investigation [52].

3.1.6 Transmission Methods and Characteristics

A variety of PLT transmission systems with different characteristics exist, as PLT transmission methods have not been standardized by international bodies. Currently, it has been possible to identify systems using three substantially different modulation methods. All these methods are “modern” in the sense that they make quite efficient use of the spectrum, the transmitted power spectral density being more or less flat in the spectrum used for transmission.

Below, we briefly describe the principles of the different modulation methods used (for more details, the reader may consult any text book on Digital Communications) and some implications for interference with conventional usage of the HF radio spectrum.

3.1.6.1 OFDM (Orthogonal Frequency Division Multiplexing)

OFDM modulation is illustrated in Figure 3.1.6-1. The data is distributed over a large number of subcarriers, each modulated with a relatively low symbol rate R_s [symbols/s]. The frequency spacing between the subcarriers is approximately R_s [Hz], such that the spectra of adjacent subcarriers overlap. All the carriers can be modulated simultaneously in an efficient manner, using an IFFT. The overall transmitted spectrum can be changed relatively easy by using different amplitudes on different subcarriers, or by excluding some subcarriers altogether. This may be used to “silence” some frequencies if interference complaints are received, or to shape the spectrum to the most efficient shape (transmitting most power on high-SNR subcarriers). OFDM signals may exhibit large peak-to-average power ratios.

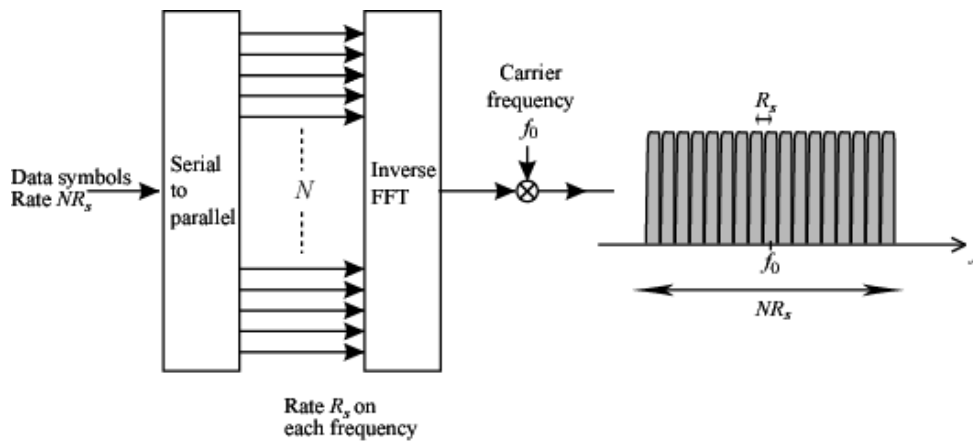

Figure 3.1.6-1: Principle of OFDM Modulation.

3.1.6.2 DSSS (Direct Sequence Spread Spectrum)

DSSS is illustrated in Figure 3.1.6-2. A signal modulated at a symbol rate R_s is spread out in frequency by multiplying with a spreading sequence at a much higher rate R_w . The total bandwidth of the modulated signal is hence approximately R_w , which is much higher than the minimum required bandwidth R_s . The benefits are that the power spectral density is decreased by a factor R_w/R_s due to the spreading, and that a number of users can share the same frequency band by using different spreading sequences. DSSS may still work if parts of the transmitted spectrum are “silenced” by use of notch filters; the information is spread out in the entire band and can still be detected after correlating with the spreading sequence in the demodulator. The peak-to-average power ratio of DSSS is smaller than for OFDM.

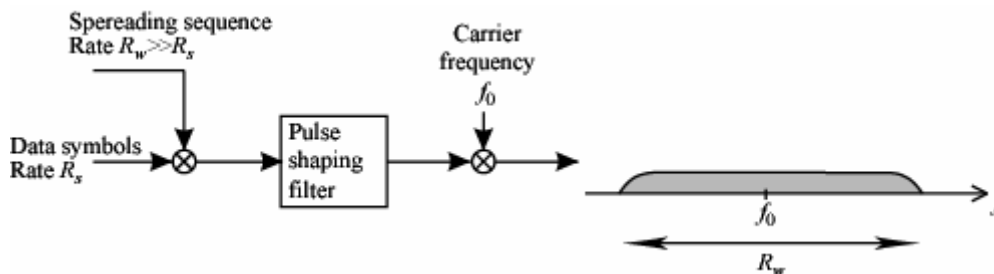

Figure 3.1.6-2: Principle of DSSS Modulation.

3.1.6.3 GMSK (Gaussian Minimum Shift Keying)

Frequency shift keying with the smallest possible modulation index (frequency shift relative to symbol rate) is called MSK (Minimum Shift Keying). MSK can also be viewed as a special case of phase modulation, where the phase is obtained by integrating the filtered input signal (this is a common practical implementation of MSK). In GMSK, illustrated in Figure 3.1.6-3, the pulse shaping filter has a Gaussian impulse response. GMSK is well known as being the modulation scheme used in the GSM cellular system. The total bandwidth of the modulated signal is approximately equal to the input bit rate R_s . The peak-to-average power ratio is small, since only the phase of the modulated signal carry information. There is little freedom in shaping the transmitted spectrum in GMSK; a notch within the transmitted spectrum would put severe requirements on the equalizer in the demodulator.

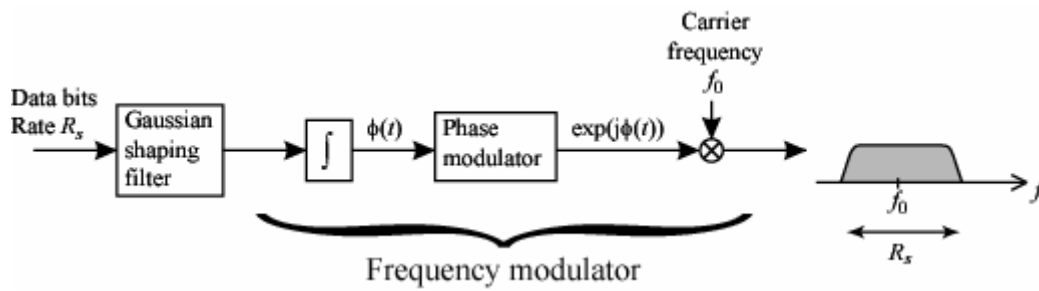

Figure 3.1.6-3: Principle of GMSK Modulation.

3.1.7 PLT Systems in Use

The information we have been able to obtain on different PLT systems is summarized in Table 3.1.7-1. We have observed that even though GMSK as well as DSSS were used in earlier PLT systems and trials, systems currently available (October 2006) seem to be exclusively based on OFDM.

CHARACTERISTICS OF PLT AND xDSL TRANSMISSION SYSTEMS

Table 3.1.7-1: Characteristics of PLT and xDSL Systems in Use

	<i>Frequency range</i>	<i>"Protected" frequencies</i>	<i>Injected PSD (dBm/Hz)</i>	<i>Modulation method and parameters</i>
In-house PLT systems				
ASCOM (2001 info) -discontinued	18.8-26.2 MHz	20.8-21.4; 23.4-24.2	< -72 (-4dBm, 6 MHz BW)	GMSK, 3 carriers, 2.5Mbps each, time-division duplex
ASCOM (2002 info) -discontinued	18.8-26.2 MHz	20.8-21.8; 23.8-24.2	< -72	GMSK, 3 carriers, 1.0Mbps each, time-division duplex
Current Technologies	2-34 MHz	Not specified	-58	OFDM, up to 1536 carriers, up to 205 Mbps
Main.Net DSSS - discontinued	4-25 MHz			DSSS
Main.Net OFDM	1.7-30 MHz	Not specified	Adaptive	Adaptive OFDM
HomePlug 1.0	4.3-21 MHz	Amateur bands	< -50	OFDM w/DQPSK, 84 carriers, 14 Mbps
HomePlug AV	2-28 MHz	Amateur bands	< -50	OFDM, PSK/QAM, 917 carriers, 200 Mbps
DS2 chipset	Programmable	Programmable		OFDM, 1280 carriers
Access PLT systems				
ASCOM (2001 info) -discontinued	1.4-11.8 MHz	3.4-3.8; 5.8-7.2; 9.4-9.8	< -66 (+2dBm, 6 MHz BW)	GMSK, 3 carriers, 2.5Mbps each, time-division duplex
ASCOM (2002 info) -discontinued	1.4-11.8 MHz	3.4-3.8; 5.8-7.2; 9.4-9.8	< -66	GMSK, 3 carriers, 1.0Mbps each, time-division duplex
Current Technologies	2-34 MHz	Not specified	< -50	OFDM, up to 1536 carriers, up to 205 Mbps
Main.Net DSSS - discontinued	4-25 MHz			DSSS
Main.Net OFDM	1.7-30 MHz	Not specified	Adaptive	Adaptive OFDM
HomePlug BPL - under development				
DS2 chipset	Programmable	Programmable	-74 to -50	OFDM, 1280 carriers
Amperion (North America)	3.75-48.75 MHz	Programmable	Adjustable	OFDM, 24 Mbits/sec, 2.5/4 MHz Bandwidth
Opera Technology Specification	10,20 or 30 MHz BW	Refers local regulations	Refers local regulations	OFDM w/ trellis-coded ADPSK, 1536 subcarriers, up to 205 Mbps
xDSL systems				
ADSL	Below 1.1 MHz			
ADSL2	Below 1.1 MHz			OFDM w/ trellis-coded QAM, 4 kbaud, 4312.5 Hz tone spacing
ADSL2+	Below 2.2 MHz			OFDM w/ trellis-coded QAM, 4 kbaud, 4312.5 Hz tone spacing
ADSL2++	Below 4.4 MHz			OFDM w/ trellis-coded QAM, 4 kbaud, 4312.5 Hz tone spacing
SDSL	Below 0.5 MHz			
HDSL	Below 0.5 MHz			
VDSL	Below 12 MHz	Amateur bands	<-53 (-60?) (-56?)	OFDM w/ adaptive QAM, 4 kbaud, 4312.5 Hz tone spacing

Ascom (<http://www.ascom.com>) had pilot systems in 2001 – 2002, using 3 GMSK-modulated carriers, below 12 MHz for Access systems and above 18 MHz for In-House systems. Later, Ascom has discontinued its PLT operations.

Current Communications (<http://www.currentgroup.com>) acquired the PLT assets of Ascom in 2006, forming the subsidiary Current Technologies (<http://www.currenttechnologies.ch/>). They deliver OFDM-based Access system, offering data rates up to 205 Mbps.

Main.Net (<http://www.mainnet-plc.com>) delivers systems called Plus (“Power Line Ultimate System”) for Access, as well as In-House networks. Earlier, their systems were based on DSSS technology [36], but they now offer products based entirely on OFDM.

Other PLT vendors are providing equipment built around the DS2 chipset (<http://www.ds2.es>). This is a flexible chipset based on OFDM modulation, with up to 1280 subcarriers. The frequency ranges used, and notches to protect certain frequencies from interference, are programmable.

Even though power line transmission technology has not yet been standardized by international bodies, a group of vendors called the HomePlug Powerline Alliance (<http://www.homeplug.org>) has agreed on a common industry standard for In-House PLT, HomePlug 1.0 [47]. These systems use OFDM modulation, obtaining an overall data rate of 14 Mbps. The Alliance finalized a new specification called HomePlug AV [48] in August 2005, designed specifically for in-house entertainment applications (e.g., home theater) and supporting a theoretical data rate of 200 Mbps, which would translate to a real-world speed of 70 – 120 Mbps. Products using this technology (e.g., Intellon chips) have been available since early 2006 [27]. These systems will also use OFDM modulation. Finally, the Alliance has recently started work on a specification for Access systems, called “HomePlug BPL”.

Other groups working on standardizing PLT systems include the Open PLC European Research Alliance (OPERA) and IEEE P1675. IEEE P1675 focus on other issues than modulation/signalling format or EMC [38], and are hence not considered further here. OPERA has published a technical specification for OFDM-based Access PLT systems [51]. Among the systems investigated above, Current Technologies seem to be the only one employing parameter combinations (number of subcarriers, bandwidths and maximum data rate) found in the OPERA specification, giving a strong indication that they adhere to the specification.

Detailed overviews of PLT systems available in 2004 and in 2006 can be found in [56] and [38], [76], respectively.

3.1.8 Example of an Access PLT System

In this section we describe the Amperion Access PLT system used in North America, as an example.

The system consists of three basic blocks. These are the injector, the extractor and the repeater/extractor. While these components are modified depending upon whether the application is for underground or overhead wiring, they perform the functions detailed below.

The Injector is the interface between the network access. Typically, one injector is installed per MV feeder. Once on the wire, the signal is either repeated to extend its reach or extracted to the customer. The Extractor is the device that connects the PLT network to the destination.

The Repeater/Extractor provides both extractor and repeater functionality. It fully receives a signal sent from an injector (or another repeater), error corrects for the noise, decodes the IP datagram, routes the packet and retransmits the packet down the MV feeder.

CHARACTERISTICS OF PLT AND xDSL TRANSMISSION SYSTEMS

Spacing is dependent upon the desired bandwidth, application, noise on the line and whether latency is within voice-fidelity limits.

The interface from the MV lines to the customer premise is via a 2.4 GHz (IEEE 802.11b) wireless link. A typical system showing the integration of all the components is shown in Figures 3.1.8-1 and 3.1.8-2 below.

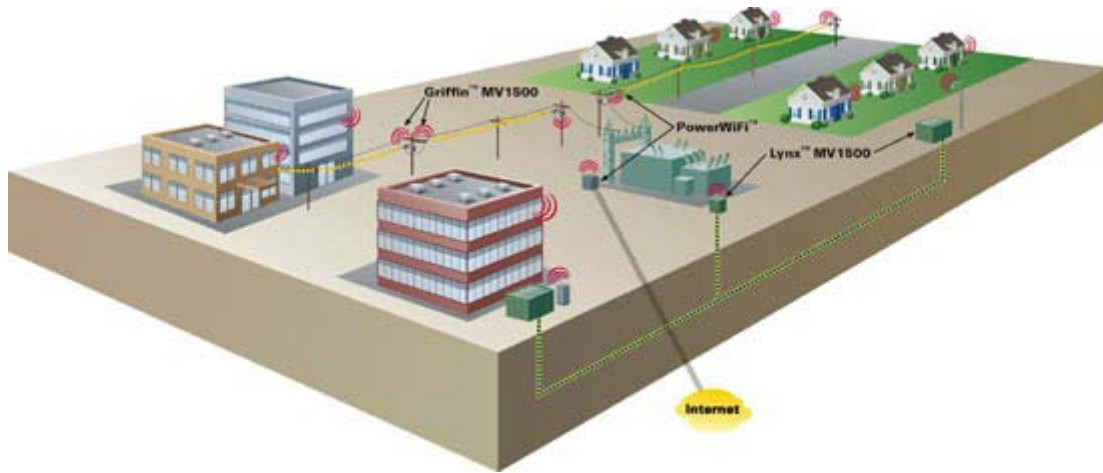

Figure 3.1.8-1: Integrated Amperion System.

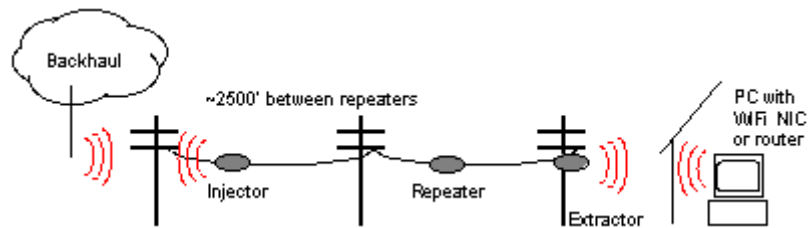

Figure 3.1.8-2: Amperion Overhead System Customer Termination.

A conceptual representation of the injection and extraction method is shown in Figure 3.1.8-3.

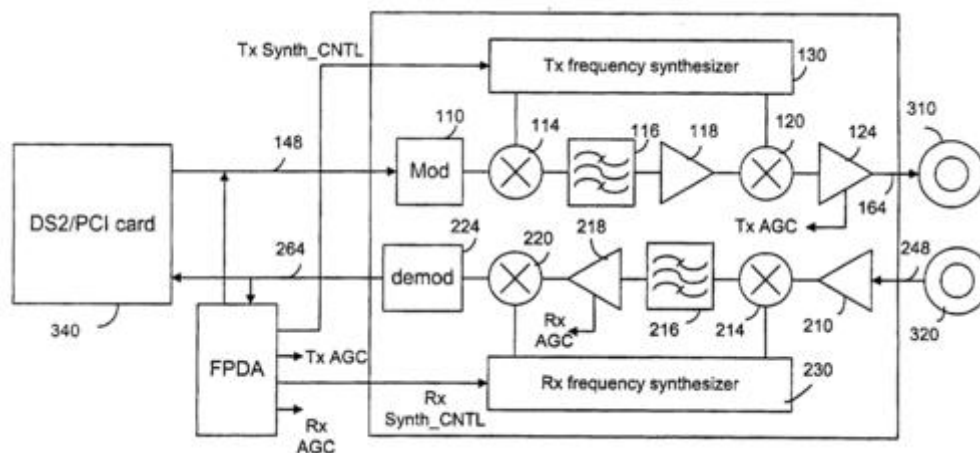

Figure 3.1.8-3: Amperion Injector/Extractor.

The injected signal at the point labelled 310 has a frequency range of 3.75 MHz to 48.75 MHz and an emission width of 2.75 MHz. The signal extracted at the point labelled 320 has a frequency range of 9.8 MHz to 47.8 MHz and an emission width of 3.75 MHz.

This system is frequency agile within the bounds mentioned. The modulated emission is Orthogonal Frequency Division Multiplexing. The OFDM signal comprises 1280 carriers with 1.1 kHz spacing. The downstream spectrum has 768 carriers and occupies a 3.75 MHz bandwidth. The upstream spectrum comprises 512 carriers with a 2.75 MHz bandwidth. The individual carrier components within the emission may be suppressed in order to provide interference mitigation.

The system is also capable of power agility with the maximum power spectral density of the order of -50 dBm/Hz. Over a majority of the PLT frequencies the transmitter only couples 5 to 10 dB less power than the transmitter is capable of. Typical transmitters will couple -60 to -55 dBm/Hz average power spectral density to the electrical line. The value of -60 dBm/Hz represents 25 nanowatts contained within a 2.5 kHz (nominal allocation for communication below 30 MHz) voice channel.

3.2 TRANSMISSION ON TELEPHONE LINES (xDSL)

The term xDSL covers various types of Digital Subscriber Line technology including Asymmetric DSL (ADSL) and Very high-speed DSL (VDSL). ADSL typically uses frequencies up to 1.1 MHz (special versions up to 4.4 MHz) whereas VDSL may use frequencies up to 30 MHz. ADSL provides a link from customers' premises all the way to the local telephone exchange, but VDSL only links customers' premises to an intermediate Optical Network Unit (ONU) up to 1 km away.

This section gives an overview of the telephone network environment that the xDSL systems operate in. Some important factors to consider in the Access network are: type and quality of the wires, length distribution of the wires, network topology and special impairments like bridged taps [35].

As the deployment of the telephone network has taken place over a very long time the quality and topology of the network differ greatly between different countries and between different regions within the country. Generally the quality of the network is much better in countries that developed their telephone systems later; the average length of the wires is shorter and the transmission characteristics are often found to be better. For example, the average length of the wires is shorter in most European countries than in the USA. The median length of the wires in the Access network in Germany is around 1700 m, in Sweden 1500 m, in Italy around 1200 m and in the USA approximately 2200 m. The length of the wire is a very important factor since a longer wire attenuates the signal more, resulting in lower bit rate capacity. Other important properties of the wires that determine the transmission characteristics are: dimension (gauge), isolation material (paper, PVC, polyethylene) and type of twisting. Some older telephone networks can have untwisted wire-pairs (also called flat twist), but modern Access networks generally consist of unshielded twisted-pair copper wires. Twisted-pair wires are less susceptible to crosstalk and to other types of interference.

3.2.1 Telephone Line Systems

Figure 3.2.1-1 shows the topology of a usual metallic Access network, where all telephone lines start at a Central Office (CO) or a smaller local exchange. A large CO can serve over 100000 customers; in Germany the mean number of customers is 5000. The big feeder cables emanate from the CO. As the network spreads out, the big cables branch off into smaller and smaller cables. At some junctions in the network there are so-called Cross-connection Points (CPs), where cross-connections between wires in the larger feeder cables and the smaller distribution cables can be made. The cross-connection points often reside in small street cabinets and are known by many names, such as a serving area interface, a flexibility point, or a

crossbox, etc. The gauge of the cables often changes in a cross-connection point, where smaller gauges are used closer to the customer premises. Most of the network is buried underground, especially the larger feeder cables, but overhead wires can also exist and they are more common further out in the network closer to the subscribers. However, buried wires are preferred since aerial wires are most susceptible to ingress noise and more likely to create egress problem.

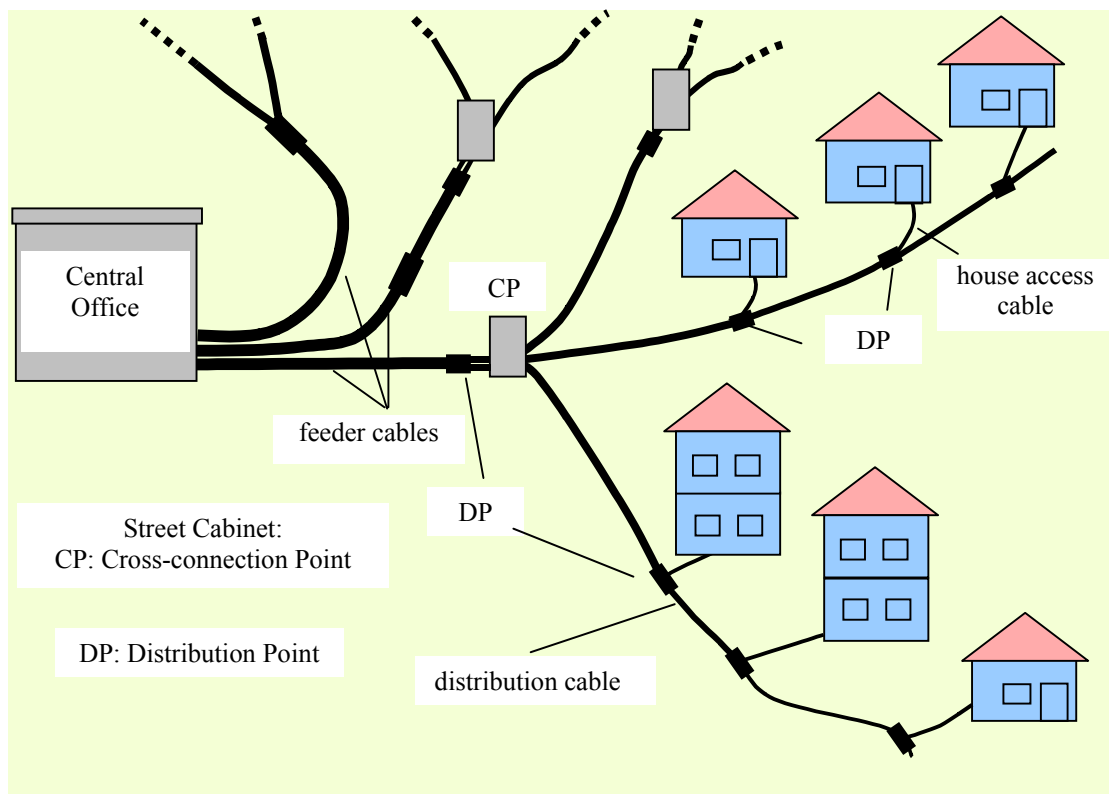

Figure 3.2.1-1: Typical Telephone Access Network.

Special types of impairments present in some Access networks are so-called bridged taps. A bridged tap is an unterminated line-segment that is spliced onto the telephone line at a Distribution Point (DP). This was made before, to allow reconfiguration of the network (disconnecting some and reconnecting other subscribers) if service demands would appear at other locations. Bridged taps are usually located closer to the customers than the central office and they are more common in North America than in Europe. It is estimated that up to 80% of the lines in the USA have bridged taps, but they can exist in Europe as well. If we consider the indoor wiring at the customer’s premises as part of the Access network (which is the case with a splitter-less DSL system), practically all lines have bridged taps. The effect of bridged taps on a VDSL signal is explained in Section 3.2.2.

In Germany the feeder cables from the CO to the CPs are on average 1400 m long and consist of up to 2000 wire-pairs. One cable feeds six to ten CPs. Each distribution cable is on average 300 m long, contains up to 100 wire-pairs and runs from the street cabinets to the customers’ premises. Each House Access cable is branched off the distribution cable at a Distribution Point by means of a cable jointing sleeve. It contains 10 to 20 wire-pairs, dependant on the number of apartments in the house and ends at the pedestal, inside or outside the building. Special wiring cables are running from the pedestal to each apartment, where the customer’s telecommunications network begins. The average wire-pair lengths in the customers’ building are 30 m.

The lines used for xDSL are generally symmetrical twisted pairs. Each customer has its own line up to the central office. Usual diameters of the single wires are 0.35 mm, 0.4 mm, 0.5 mm, 0.6 mm and 0.8 mm. Different types of lines and cables are used. Figure 3.2.1-2 shows the conductor arrangements in a few of them. Twin twisted wires are used as jumper wires. In telecommunication lines and cables often two twin wires are combined to a star quad to get high packing density. Since thirty years, trunking of telecommunication lines is typical: star quads are the elements. Five star quads are combined to a trunk element. The cable shown in Figure 3.2.1-2 contains ten such trunk elements.

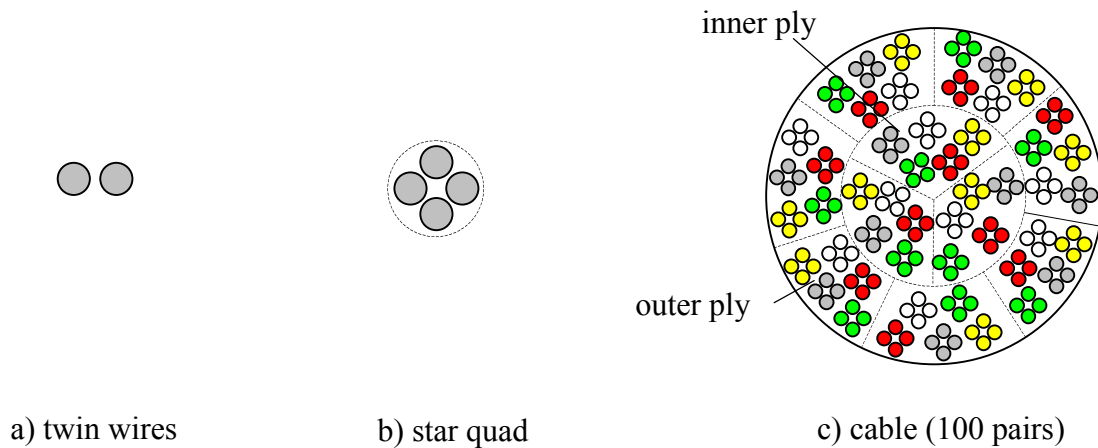

Figure 3.2.1-2: Conductor Arrangements in Telecommunication Lines and Cables.

The feeder and distribution cables differ in protection against humidity. The feeder cables are hermetically sealed and monitored by compressed air while the distribution cables are filled with a special gel. By that both cable types have about 15% different attenuation.

Table 3.2.1-1 shows technical data of some telecommunication lines of the telephone Access network used for xDSL. The characteristic impedance of usual lines at 1 MHz is between 110 Ω and 145 Ω; at higher frequencies it is slightly lower. The attenuation depends on wire diameter and on material for protection against humidity.

Table 3.2.1-1: Technical Data of Some Telecommunication Lines

Type of Line/Cable	Description	Characteristic Impedance at 1 MHz	Attenuation in dB/km at 1, 10 and 30 MHz
A-2YF(L)2Y 100 x 2 x 0.4	distribution cable (100-pairs) 0.4 mm	136 Ω	19.4 / 60.7 / 111.5
A-2YF(L)2Y 100 x 2 x 0.6	distribution cable (100-pairs) 0.6 mm	138.5 Ω	13 / 41.3 / 77
I-YY 10 x 2 x 0.6	indoor cable, 10-pairs (PVC) 0.6 mm, originally only for POTS		22 / 88.3 / 179
	twin wires	ca. 114 Ω	

CHARACTERISTICS OF PLT AND xDSL TRANSMISSION SYSTEMS

Next the elements of the telecommunications Access network are described which remarkably contribute to wave reflections and thereby to HF radiation (Figure 3.2.1-3). In the central office the xDSL two wires line starts with a modem, going through a DSL Access Multiplexer (DSLAM), splitter (separation of high frequency DSL signal from lower frequency analog and digital telephone signals), then going to the Main Distribution Frame (MDF). There the line is connected to a distribution cable (e.g., cable c) in Figure 3.2.1-2) by use of twisted twin wires. The distribution cable is combined with other ones in the cable cellar of the CO to a feeder cable by use of a sleeve.

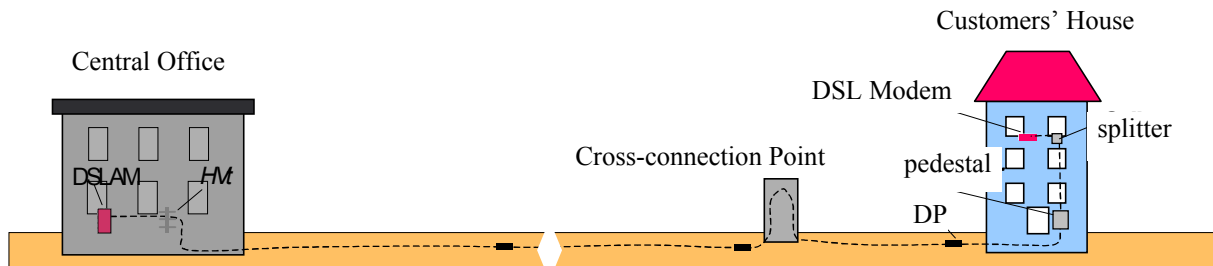

Figure 3.2.1-3: xDSL Line (Telephone Access Network).

At the Cross-connection Point (see Figure 3.2.1-1) the feeder cable is distributed to some distribution cables and eventually to another feeder cable. Figure 3.2.1-4 shows the basic construction of the Cross-connection Point inside a street cabinet. Shortly before entering the cabinet the feeder cable by sleeves is distributed to short cables with max. 100 pairs each. The termination of each short cable is contacted to the inputs of switchboards. The metallic base of each termination is fixed to the metal frame and thereby combined with the local cabinet earth. The cabinet is nearly full of switchboards and also shows the twin wires for connecting the incoming lines with the lines going to the customers.

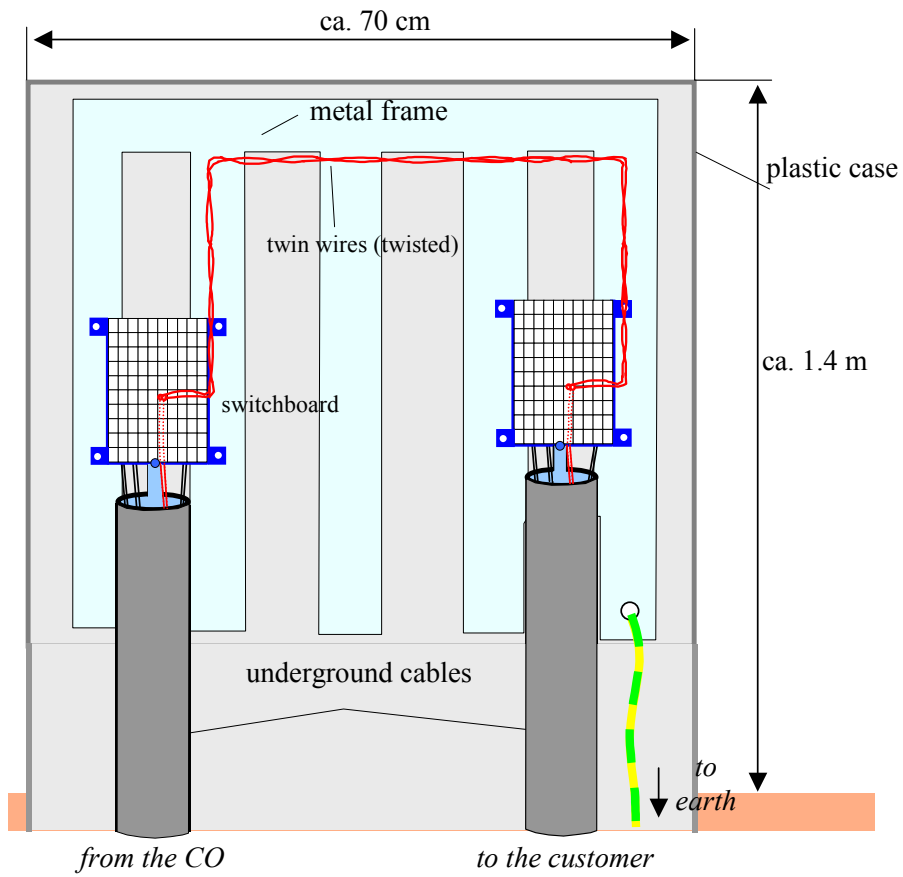

Figure 3.2.1-4: Basic Construction of a Cross-Connection Point.

Figure 3.2.1-5 is a photo of an open door street cabinet.

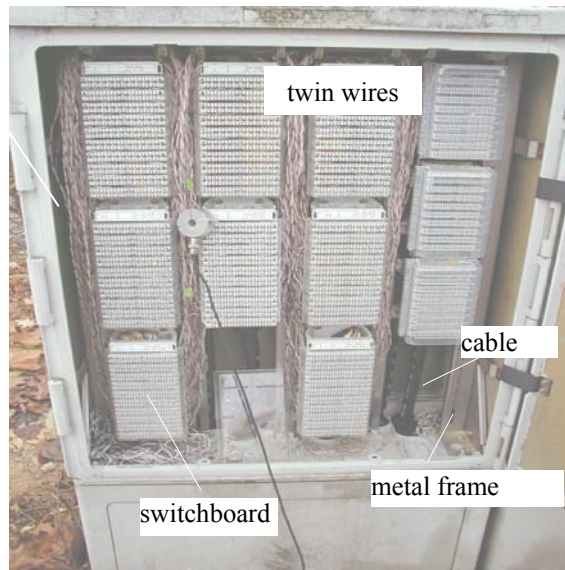

Figure 3.2.1-5: Photo of a Cross-Connection Point inside a Street Cabinet.

CHARACTERISTICS OF PLT AND xDSL TRANSMISSION SYSTEMS

The next basic elements of the distribution cables (Figure 3.2.1-1) are sleeves at the DPs. They are used for jointing or distributing cables. Figure 3.2.1-6 is a basic representation of branching off a customer line from the a distribution cable. Important are the realisation of uninterrupted cable shield, as well as the protection of the wires against humidity.

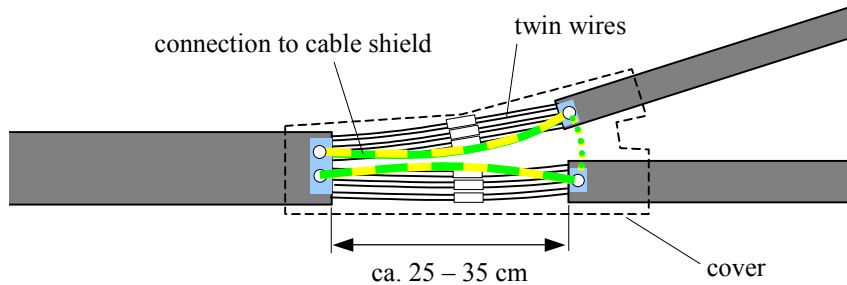

Figure 3.2.1-6: Scheme of Telephone Line Branching Off by a Sleeve.

The house access point is mounted inside or outside the house, usually in the cellar or ground floor. The basic construction of the pedestal with the house Access cable ending is shown in Figure 3.2.1-7. The twin wires at the end of this cable are connected with the different In-House telecommunication lines, one for each apartment (here only one). The cable shields as well as the local earthing system may be connected to the earth bar, but only a small part of the German pedestals do so. Modern in-house telecommunication lines contain several wire pairs, while older ones are star quads (Figure 3.2.1-2) or even twin wires.

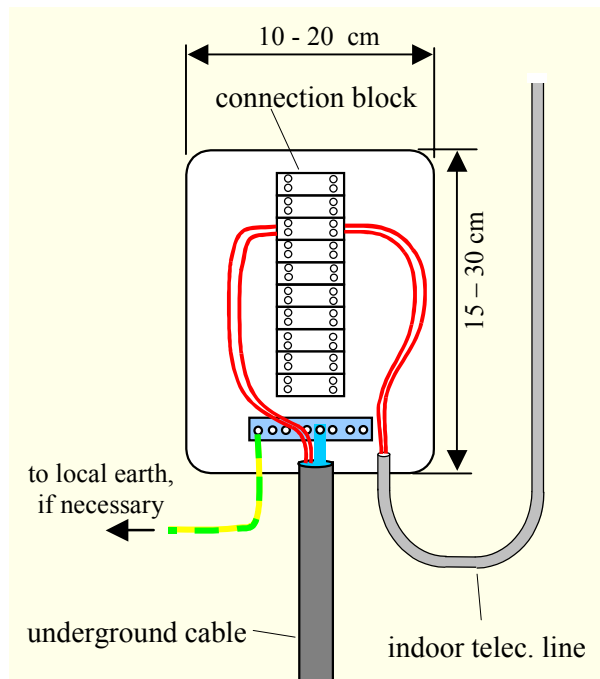

Figure 3.2.1-7: House Access Point (HAP) for Telephone Lines.

Figure 3.2.1-8 shows a typical phone line house installation with one phone jack (1st TAE) for connection of the customer's equipment. Up to three analog devices may be connected (telephone, fax, modem,

telecommunications device, ...). ISDN customers need a special network terminator basic interface (NTBA) for connection of a telecommunications device or other different terminals by use of a bus. DSL customers additionally need a splitter, a passive filter with 130 kHz limiting frequency to separate the high frequency DSL signals from the low frequency POTS- and ISDN-signals.

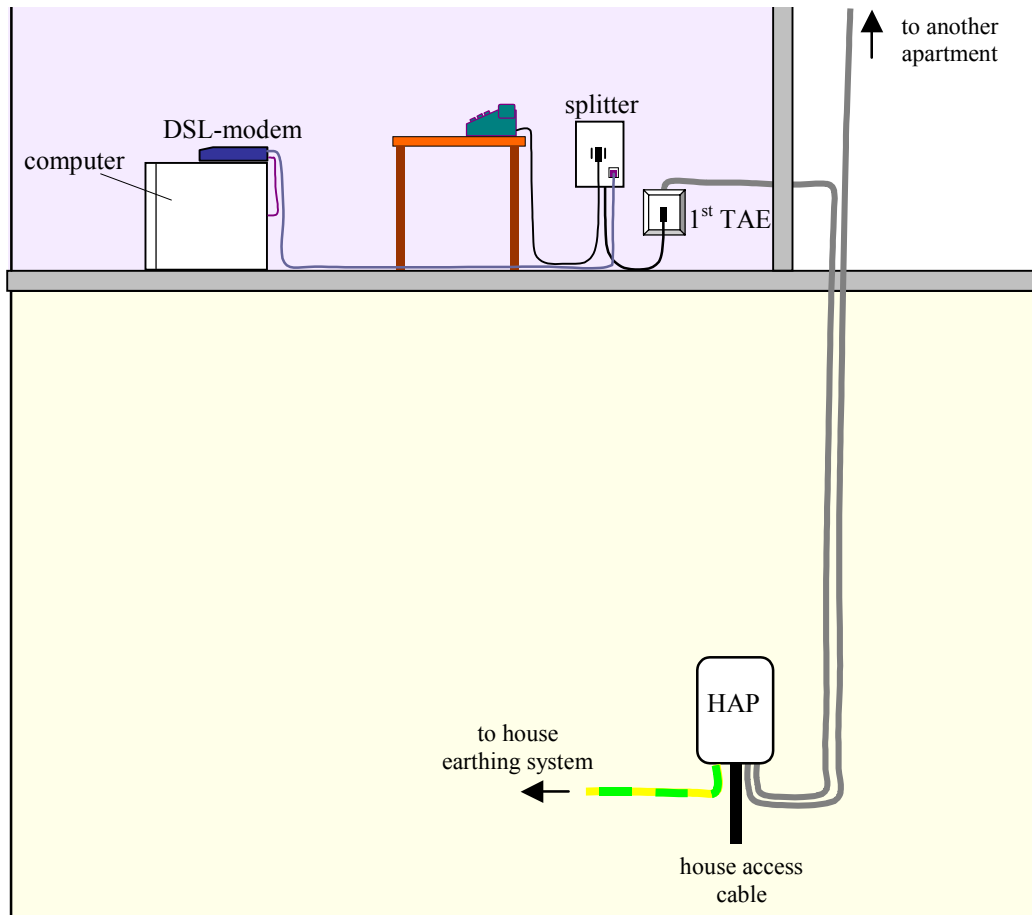

Figure 3.2.1-8: Simple House Installation with xDSL Access.

3.2.2 Technical Characteristics with Respect to HF Radiation

Theoretically symmetrical signal transmission on twisted-pair wires does not produce any radiation, but real telephone lines are not completely symmetrical. This is characterised by the so called asymmetric divergence: the higher the asymmetric divergence, the better is the symmetry of the signal transmission system and the lower is the signal emitted.

The asymmetric divergence of wire-line telecommunication networks contributing to signal emission may be defined, for example, by the Longitudinal Conversion Loss (LCL). LCL defines the amount of a symmetrical input voltage being converted to an asymmetrical voltage downstream, leading to signal radiation. $LCL = 0$ dB equals the characteristics of an infinitely bad cable pair, while $LCL = 60$ dB represents a good quality twisted pair.

Measurements in the HF range at several 100 m long 100 pair telephone cables with different wire diameters between 0.35 mm and 0.6 mm showed LCLs between 25 dB and 75 dB and median values between 38 dB and 50 dB [53]. Using the LCL for assessment of radio emission is applied only for

CHARACTERISTICS OF PLT AND xDSL TRANSMISSION SYSTEMS

telecommunication networks (not for PLT networks) because of the remarkably better electrical characteristics of their wire-lines and only for frequencies below resonance.

Causes for a low LCL may be discontinuities in wire diameter, twisting and distance to the cable screening along the wire-line. More important causes are impedance mismatches at different points along the line, such as Distribution and Cross-connection Points, Bridged Taps, House Access Points and within the house installation. The main factors affecting the level of radio emission are the imbalance of the customer's premises wiring and the DSL signal power injected into it. The house installation itself forms an efficient antenna for radiation of the common mode signal parts produced within the telephone line network, especially when its lines have resonant lengths of $\lambda/4$ or multiples thereof.

3.2.3 DSL Basics

The premises of DSL technology are that a copper wire can carry a wide range of frequencies well into the MHz range, with limitations only due to the physical characteristics of the wire, allowing data rates in the Mbps range.

Although a few MHz of frequencies can be transmitted on the cables, only frequencies in the range of 0 to 4000 Hz are used by telephone lines for voice communications; the rest of the frequencies are not used. It is these unused frequencies that xDSL exploits for Broadband Technology. xDSL Access technologies deploy either OFDM (*Orthogonal Frequency Division Multiplexing*) or *Echo-Cancelling* techniques to transmit and to receive data on a pair of copper wires. The Echo Cancelling technique not only requires sensitivity of Transmitter and Receiver to signals deemed useful, but also requires advanced digital signal processing (DSP) circuitry to achieve good results and is therefore not popular. It is most often superseded by OFDM wherein the entire available frequency bandwidth is divided into three or more frequency bands. Based on the upstream and downstream speeds, bit-rate, symmetry factor and number of copper pairs used, xDSL is classified as in Table 3.2.3-1. The transmission rates are a function of the thickness and the distance of the copper wire being used [75].

Table 3.2.3-1: xDSL Classification

xDSL	Upstream	Downstream	Symmetry	Copper Pairs
ADSL	~640 kbps	~2 Mbps	Asymm.	1
HDSL	~1.544 Mbps	~1.544 Mbps	Symm.	2
HDSL2	~1.544 Mbps	~1.544 Mbps	Symm.	1
SDSL	~1.544 Mbps	~1.544 Mbps	Symm.	1
VDSL	~2.3 Mbps	~52 Mbps	Asymm.	1

3.2.4 xDSL Systems in Use

xDSL transmission is standardized by international bodies like ITU-T, ANSI and ETSI. Information on different xDSL systems is summarized in Table 3.1.7-1. SDSL, HDSL, SHDSL, ADSL and ADSL2 systems are all constrained to frequencies below the HF range, and have therefore not been studied in detail by this RTG. The ADSL family is, however, expanding into the HF range through the extensions ADSL2+ and ADSL2++. VDSL systems are using large portions of the HF band.

ADSL2 (ITU-T G.992.3) [16] is an improvement to ADSL using the same frequency range (below 1.1 MHz), where data rates have been increased by using trellis-coded QAM (quadrature amplitude modulation) on each subcarrier. The frequency spacing between subcarriers is 4312.5 Hz, and the symbol rate on each subcarrier is 4000 symbols/s. ADSL2+ (ITU-T G.992.5) [17] is a further extension of ADSL2, using twice as many subcarriers to double the data rate. The frequency range used is hence up to 2.2 MHz. Doubling the number of subcarriers once more gives ADSL2++, using frequencies up to 4.4 MHz.

VDSL (ANSI T1.424, ITU-T G.993.1) [49] uses frequencies up to 12 MHz. QAM is used on each subcarrier, and the frequency spacing and symbol rate is the same as in the ADSL2 family, while the number of subcarriers is much larger. Annex 6 of reference [49] describes an extension where the data rate is doubled by doubling the symbol rate and the subcarrier frequency separation, while maintaining the same number of subcarriers. The frequency range used is then up to 24 MHz. An upgrade of the VDSL standard, VDSL2 (ITU-T G.993.2), also exists [93]. This standard includes several options for operation modes and band plans, some of them extending up to 30 MHz. As of February 2006, the band plans for Europe and North America are constrained to below 12 MHz, while band plans for Japan extend to 30 MHz.

According to reference [43], “most telcos have already deployed ADSL2+ in 2005 while VDSL is attracting less attention, but is likely to see more significant deployments in the 2006 to 2008 timeframe”. For example, the systems currently (October 2006) offered in Norway are only ADSL (up to ADSL2+, 16 Mbps), and SHDSL (Symmetric HDSL, up to 8 Mbps). According to Reference [37], in September 2005, there was widespread VDSL deployment in Korea and Japan only. In Germany T-Com (part of the Deutsche Telekom) realised VDSL2 (second generation) pilot systems in Hamburg, Hannover and Stuttgart [74]. In ten German cities, 50% of the households (2.9 million) are expected to be VDSL-capable up to mid 2006, and 90% (6 million households) up to the end of 2006.



Chapter 4 – LIMITS FOR WIRE-LINE TRANSMISSION SYSTEMS

HF radio services may be affected by unwanted radiation from the new broadband wire-line telecommunication networks. To fulfil the protection requirements described in Section 2.4, emission limits for these wire-line telecommunication networks have to be introduced.

4.1 EXISTING STANDARDS AND REGULATIONS

CISPR 22 is an international standard produced by CISPR (International Special Committee on Radio Interference, sub-committee of the International Electrotechnical Commission IEC). EN 55022 is its European counterpart and is a harmonised standard under the EMC Directive. Both standards deal with “Information Technology Equipment (ITE) – Radio disturbance characteristics – Limits and methods of measurement”. The limits given in both standards are equal.

The Information Technology Equipment has two terminals, the mains port and the telecommunication port, and the limits set for these ports are different. ITE is subdivided into two categories denoted Class A ITE and Class B ITE: Class B ITE is intended primarily for use in the domestic environment and has to satisfy the more stringent Class B ITE limits. Class A ITE is a category of all other ITE and has to satisfy the Class A ITE limits, which are less stringent.

In the HF range the Class B ITE limits are:

- | | | |
|---|-----------------------------|--|
| a) for the mains port:
(disturbance voltage) | 0.5 to 5 MHz
5 to 30 MHz | 56 dB μ V Quasi-peak
60 dB μ V Quasi-peak |
| b) for the telecommunication port:
(conducted common mode [asymmetric mode] current) | 0.5 to 30 MHz | 43 dB μ A Quasi-peak |

These limits may not be applicable to the new broadband wire-line telecommunication networks because of the differences of the radio signals emitted by equipments and networks: on one hand the characteristics of the interfering signals are quite different (bandwidth, duration, level vs. frequency, see Section 2.4), and on the other hand ITE and networks differ largely in their dimensions, and thus, in their effective antenna gain.

For that reason, activities had been initiated globally to find new limits for the broadband wire-line telecommunication networks. Nevertheless, for the networks, there is the tendency to settle on the same limits as for equipment.

Other international standards dealing with radio disturbance by different types of equipment are:

- CISPR 11 / EN 55011: “Radio disturbance characteristics of Industrial, Scientific and Medical (ISM) equipment”; and
- CISPR 15 / EN 55015: “Lighting Equipment – Radio disturbance characteristics – Limits and methods of measurement”.

The limits of these standards may be taken from Sections 4.2.1 and 4.2.2 in ECC Report 24 [3].

In Germany, field strength limits for emissions from wire-line telecommunications have to be fulfilled since 2001. These limits, known as Usage Provision 30 (Nutzungsbestimmung 30: NB 30), are part of the so called “Order on the Table of Frequency Allocations (German designation: FreqBZPV)”, were first

LIMITS FOR WIRE-LINE TRANSMISSION SYSTEMS

published on 26 April 2001, and set into order on 1 July 2001 [12]. Later, this national order had to be retracted and was reintroduced (republished October 2004) [88]. The NB 30 field strength limits specified at a 3 metre distance to the wire-line are shown (together with other limits proposed) in Figure 4.1-1. They had been chosen as a compromise between the interests of both parties: wire-line and radio users.

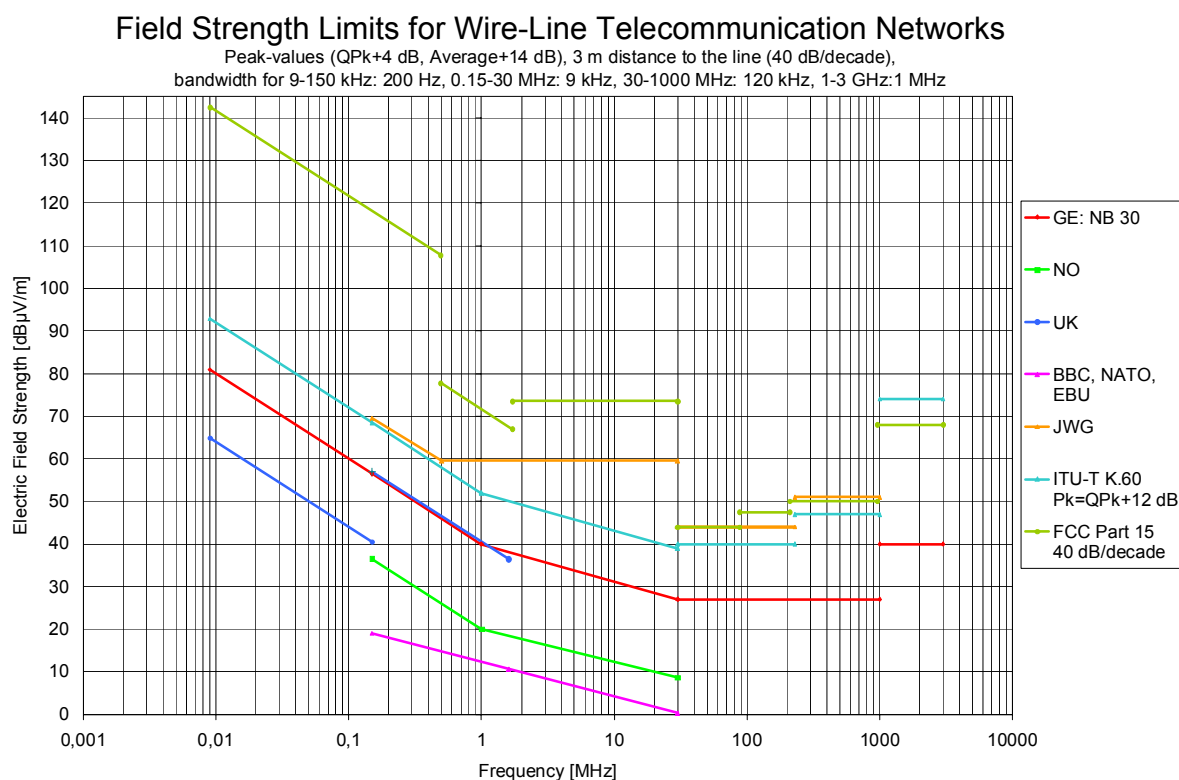

Figure 4.1-1: Field Strength Limits Proposed for Broadband Wire-Line Telecommunication Networks. All limits extrapolated to 3 metre measurement distance.

The general EMC requirements in the U.S.A. are set by the Federal Communications Commission (FCC). FCC Part 15 Rules cover equipment capable of (not deliberately) emitting RF energy in the range of 9 kHz – 200 GHz.

FCC Report and Order [31] published in October 2004, adopts new requirements and measurement guidelines for Access BPL (1.705 – 80 MHz). It states that the existing Part 15 radiated emission limits have to be applied to Access BPL systems. These limits, for comparison reasons, converted to Peak values and to a 3 metre measuring distance to the line, are shown in Figure 4.1-1 (Note: the conversion factor 40 dB/decade recommended by FCC for other measuring distances was not confirmed by measurements carried out by other organisations). In the HF range, the FCC limit of 73.5 dBµV/m is independent of frequency.

These new FCC regulations contain some requirements for adaptive interference mitigation techniques, as [31],[90], Section 15.611 (c):

- Remotely reduce power and adjust operating frequencies, in order to avoid site-specific, local use of the same spectrum by licensed services. These techniques may include adaptive or “notch” filtering, or complete avoidance of frequencies, or bands of frequencies, locally used by licensed radio operations. When a notch filter is used to avoid interference to a specific frequency band,

the Access BPL system shall be capable of attenuating emissions within that band to a level at least 20 dB (< 30 MHz) respectively 10 dB (> 30 MHz) below the applicable Part 15 limits.

- Comply with applicable radiated emission limits upon Access BPL system power-up following a fault condition, or during a start-up operation after a shut-off procedure, by the use of a non-volatile memory, or some other method, to immediately restore previous settings with programmed notches and excluded bands, to avoid time delay caused by the need for manual re-programming during which protected services may be vulnerable.
- Incorporate a remote-controllable shut-down feature to deactivate, from a central location, any unit found to cause harmful interference, if other interference mitigation techniques do not resolve the interference problem.

4.2 PROPOSED LIMITS

In Europe, deployment of power line communication systems is subject only to a general authorisation pursuant to Directive 2002/20/EC of the European Parliament and of the Council of 7 March 2002 on the authorisation of electronic communications networks and services.

In 2001, the European Commission (EC) called upon the European Standardisation Organisations to draft harmonised European standards for wire-line networks. It mandated a Joint Working Group (JWG) consisting of members from CEN (European Standardisation Committee), CENELEC (European Committee for Electrotechnical Standardisation) and ETSI (European Telecommunications Standards Institute) to prepare standards for the new broadband wire-line telecommunication networks, which “are currently operational or under development” [8]. According to this Mandate M/313, the JWG 2003 prepared a draft of harmonised standards for discussion, containing current and field strength limits as well as disturbance emission measurement methods [9]. The field strength limits in this draft were identical to that marked by “JWG” in Figure 4.1-1.

As agreement could not be reached regarding these standards, the EC in April 2004 drafted a “Technical Specification for electromagnetic emissions from access powerline communications networks” [10] and a “Guide for in situ measurements – In situ measurement of disturbance emission” [11], which was voted upon separately by CENELEC and ETSI, without reaching a consensus. In the HF range, the conducted common mode (asymmetric mode) current limit is 30 dBμA Quasi-peak and the corresponding magnetic field strength limit (using Biot-Savart’s law) at a 3 metre distance to the power line for a 9 kHz measurement bandwidth (method of measurement described in [10], paragraph 5.3 and in [11], paragraph 7) is 4 dBμA/m Quasi-peak. This limit, converted to electrical field strength in free space according to equation (4-1) and to Peak-value for comparison purposes with other field strength limits, is shown in Figure 4.1-1 (orange line marked JWG) for the frequency range 150 kHz – 1000 MHz. In the HF range this field strength limit is constant 59.5 dBμV/m.

$$E \text{ [V/m]} = H \text{ [A/m]} \cdot Z_0 \text{ [\Omega]} \tag{4-1}$$

with $Z_0 = (120 \cdot \pi) \Omega$ impedance of free space

The Technical Specifications [10] and [11] (regarding compliance verification) for Access power line communication networks aim at: (1) rapid and multiple deployment of broadband power line communication technology; and (2) to collect experience on radio interference. Therefore, these specifications allow relatively high field strength limits.

The majority of the CENELEC and ETSI members voted against the Technical Specifications [10] and [11], so these were rejected, and the JWG drafted a new “Product family emission standard for wire-line

LIMITS FOR WIRE-LINE TRANSMISSION SYSTEMS

telecommunication networks” [44],[92]. Closure dates for comments on this new draft were 2005-12-16 for CENELEC and 2005-11-18 for ETSI.

As of April 2005, the EC again recommended promotion of power line communications by its Member States, considering that power line communication systems fall within the scope of the EMC Directive:

- In case of radio interference, the national authorities should perform in situ measurements considering that only a common mode current limit now [44],[92] is prescribed in the HF range (30 dB μ A Quasi-peak, [10]); the corresponding field strength limit (59.5 dB μ V/m) is identical to the standards in CISPR 22 / EN 55022 for Class B ITE, once more recommended by the JWG for the wire-line telecommunication networks (orange line in Figure 4.1-1).
- Further the national authorities should recommend measures to reduce/avoid the interference.
- Finally they should report such cases to the EC every half year, beginning end of 2005.

As of February 2006, it was decided [50] that the draft emission standard [44],[92] should not be put to the vote at this time, but should be archived while the work on the draft emission standard was frozen. It should be resumed some time in the future when new technology was in place.

For the time being in Europe “there are therefore no limits for radiation from networks” [50].

On the European Commission Recommendation of 6 April 2005 the JWG also drafted a “Code of Practice” for PLT trials [62]. It deals with a number of issues relating to the deployment of PLT systems, but concentrates on measurement methodology and reporting, which should lead to an effective evaluation of the impact of PLT systems on radio communications services and other cable networks. The application of these principles is voluntary, but could assist the EC in any standardisation process and the collation of data received from Member States.

In case of complaints, national regulatory authorities are allowed to take special measures at a specific site in order to overcome the problem. In June 2005, CEPT adopted the ECC Recommendation (05)04 about the assessment of complaints caused by telecommunication networks. This Europe-wide recommendation reflects in principle the NB 30 requirements [64].

Austria and Germany together have proposed a “Notching Concept for PLC” recommending permanent, dynamic and programmable notching [63]. The Amateur Services frequency bands, as well as the Broadcasting bands, which are used 24 hour a day, all globally allocated according to ITU Radio Regulations, should be notched permanently. Broadcasting frequency bands used only part of the day or locally, also allocated worldwide according to ITU, should be notched dynamically. Security radio services, as well as Low Power Devices, should be protected by programmable notches. Notching depth should be at least 30 dB.

The effects of broadband wire-line telecommunication networks on radio services and applications were investigated in detail by CEPT ECC and are described in ECC Report 24 [3]. Figure 4.1-1 shows field strength limits for protection of radio reception proposed by different European countries and organisations and by ITU. Additionally it contains the U.S.-Standard FCC Part 15, valid for a 30 metre distance to the line and transformed here to a 3 metre distance on base of 40 dB/decade recommended by FCC because of near-field situation. The different limits in Figure 4.1-1 are:

- GE: NB 30 limits proposed by and valid in Germany since 2001 (Nutzungsbestimmung 30) and supported by several other European countries. According to [3], which was “adopted in CEPT by Competent National Authorities”, the tightened limits “are considered as maximum tolerable levels as far as radio services protection is concerned”. NB 30 limits are not valid for frequencies used by “safety and emergency related radio services” (no interference at all allowed).

- NO: Limits proposed by Norway and supported by some other CEPT administrations, approximately 20 dB below NB 30, “may be regarded as sufficient to protect radio services in the majority of cases” [3].
- BBC, NATO, EBU: limits proposed by BBC and NATO and “supported by the radio users (military, broadcasting/EBU, civil aviation, amateur...) of the LF, MF and HF bands” [3]: Degradation of Sensitivity no more than 0.5 dB (increase of total noise by interference 10 metre distant to the line, reference noise level to be considered is the mid-way noise level of quiet-rural and rural areas defined in the ITU-R P.372-8 [86]). DERA experiments [4] showed that even an accumulated 3 dB worsening of the background noise caused by deployed VDSL or PLT sources severely affected data rates and/or circuit availability. The Absolute Protection Requirement proposed in Section 2.4 is partly based on this finding. Subsequently, DERA advised that to prevent this overall effect, the noise floor at a 3 metre distance to the VDSL- or PLT-lines should be limited to that of the BBC, NATO-curve.
- JWG: These limits proposed by the EC for use in Europe are identical with CISPR 22 / EN 55022 limits valid for Class B ITE.
- ITU-T SG 5 limits approved and recommended internationally, 12 dB higher than NB 30. ITU additionally recommended Quasi-Peak limits equal to NB 30-values (Peak-limits), i.e., ITU-levels shown here perhaps should be 8 dB lower, as most organisations measured only 4 dB (instead of 12 dB) difference between QPeak- and Peak-values.
- FCC Part 15 limits valid in the U.S.A. for application to Broadband over Power Line (BPL: the North American term for PLT) systems [31],[90],[14].

In case of complaint, the methods of measuring conducted disturbance emissions from broadband wire-line telecommunications in the HF range regarding JWG-limits are described in [44],[92] and corresponding methods of field strength measurements for comparison with NB 30 limits are described in [12],[88]. Another guidance on field strength measurement method was developed and agreed to in the framework of CEPT/ECC/SE35 and issued by ITU [15]. In either case, these documents recommend that measurements should be carried out at a 3 metre distance to the line using a 9 kHz measurement bandwidth. Because of that high bandwidth, care should be taken that the measurements will not be influenced by HF radio signals.

4.3 INTERNATIONAL REGULATORY STATUS

The new broadband wire-line telecommunication technique is promoted globally, in order for everyone to have the means of exchanging lots of data via the Internet. The cheapest way is to use the existing wire-line infrastructure, i.e., power and/or telephone lines. Power lines are most widespread, but have the worst technical characteristics for emitting broadband noise-like signals, when transmitting high data rate signals (several Mbps). On one hand there is not much experience regarding radio interference by this new telecommunications technique, and on the other hand, there are big commercial interests promoting its realisation and multiple use.

The field strength- and common mode current-limits set in United States and proposed in Europe are relatively high (curves FCC Part 15 and JWG in Figure 4.1-1). However, FCC as well as the EC believe that these limits are appropriate to control the radio interference problem.

FCC and the EC recommend promotion of the BPL/PLT technique, its realisation and gathering experience with regard to radio interference. In case of radio interference, they both recommend measures to reduce/avoid the interference. After a period of having gathered experience, the existing limits again will be discussed.

LIMITS FOR WIRE-LINE TRANSMISSION SYSTEMS

Different nations in Africa (South Africa, etc.), Asia (Japan, South Korea, China, India, etc.) and Australia are in the experimental phase performing BPL/PLT field trials. Proposals by these nations for field strength or common mode current limits are not known to the Task Group. Australia seems to be on the way to set limits for protection of radio systems [46], but this work is in its early stages and no numbers are available yet.

Chapter 5 – MEASUREMENT OF PLT SYSTEMS

5.1 BACKGROUND

Until recently, carrier current systems most often operated within a dwelling to perform simple remote control functions or to provide an audio monitoring capability. These systems were generally unable to propagate past the first electrical transformer. Furthermore, they operated at frequencies below 2 MHz using narrowband analogue transmissions. For the most part, there was not a concentration of these devices nor were they pervasive. All of these things combined resulted in minimal impact on the allocated users of the spectrum they shared. Internet access via the power line was not feasible with these systems.

Present day Access systems use wideband digital signals that are capable of travelling well over several kilometres along the electrical lines. They have the ability to overcome the barriers previously imposed by electrical transformers and other line discontinuities. Some systems have repeaters that offer signal reconstruction, amplification and frequency translation. The use of wide bandwidths in the order of several MHz is commonplace to provide a higher data rate and better noise immunity. The frequencies used are commonly between 2 and 50 MHz although they may be capable up to 80 MHz and beyond. The Access systems have the capability to serve a neighbourhood, a city section or an entire city. Rural deployment is a strong possibility where no other high speed internet access is economically feasible.

The In-House systems available today are no longer based on simple analogue technology. Although they do not provide internet access, they may be capable of video transmission to home entertainment devices using the home owner's electrical wiring. Some In-House systems may be interoperable with Access systems with a special modem. Again, these are high bandwidth and high data rate systems spread over several MHz. As a general consideration, the In-House system emissions are mostly contained within the connected building or its immediate environs. However, the potential for leaked emissions remains high and would become more problematic if the popularity of these systems increases.

5.2 MEASUREMENT EVOLUTION

The initial measurements of Access PLT systems were generally investigative in nature. These measurements were conducted by interested parties, both pro and con, to assess the impact of leaked emissions on the incumbent users below 80 MHz. An example of a suite of investigative measurement is provided in Section 5.9. From these measurements came the basis of regulation and the attendant measurements to demonstrate compliance.

5.2.1 Investigative Measurements for Access Systems

Administrations in North America authorized several entrepreneurs to establish experimental PLT Access systems in selected cities. The regulatory agencies visited these installations and conducted measurements. Where no regulations exist, the nature of the measurements was to establish system operation characteristics, radiated power levels, spectral signature, and finally, interference mitigation capability.

Wideband digital emissions present as noise like emissions. Of interest is the width of the emission, the total power in the emission and the power spectral density over selected segments corresponding to an allocated channel in the spectrum of interest. These measurements were to be made with a RMS detector to obtain true power levels.

The investigation also established the measurement locations, separation distance, the spectral content, and the equipment needed. Of particular interest was determining the location of radiation nodes caused

by standing waves or discontinuities on the electrical lines. There was also interest in establishing the rate of decay with distance from the power line. Several computer models of power line systems required verification by measurement.

5.2.2 Regulatory Measurements for Access Systems

Regulatory measurements differ from investigative ones in many regards:

- They may be constrained by existing rules with respect to detectors, measurement bandwidths and separation distance.
- They treat the signal as an interfering source rather than a fundamental emission.
- Separation distance and elevation searches were never envisaged for sources that are elevated to over 10 metres.
- Measurement procedures below 30 MHz are not mature in many regulations.
- They may represent a compromise between advocates and detractors.

An example of a typical suite of regulatory measurements for North America is shown in Section 5.10. European variations may include differences in the measurement location and require measurements in three orthogonal planes. However, the general technical approach is very similar to the North American methods.

5.3 OBSERVATIONS

Regulatory measurements are useful only for the demonstration of compliance to an administration's rules. The evaluation of harm to a specific system will not be evident. There is an assumption that potential victims will continue to operate with minimal obstruction. The rules state emission limits. With the extrapolation of the maximum emission by calculation, one could estimate the field at a distance. However, the potential for interference must be assessed differently. These measurements are taken in close proximity to the radiator and the sky wave is not considered for the purpose of interference. Some PLT systems are power agile and alter the power across the emission bandwidth in order to maintain a signal to noise ratio of between 25 and 30 dB above the line noise. Anything less would result in data throughput reduction. Essentially, the emission is never constant, exasperating the measurement process when the PLT system is not under the explicit control of the investigator.

5.4 RECOMMENDATIONS

In order to assess the potential performance degradation of a communications system due to PLT presence, the entire system must be considered. For the most part, wideband digital emissions will present as noise to the victims and be perceived as a rise in the noise floor. Some PLT systems may operate in a burst or packet mode which will make the emission more audible and potentially more harmful. Analogue systems such as amplitude modulated or single sideband (SSB) voice channels will be most affected, and frequency modulated systems to a lesser extent. Systems that transmit digital information have an inherent advantage due to error correction algorithms and the processing gain associated with spread spectrum transmissions.

The Canadian experience with interference to HF communications revealed that SSB analogue voice transmissions in a 3 kHz channel are the most affected by systems attempting to share the spectrum. The thought was that if a SSB channel could be protected, then it would follow that other more advanced technologies would also be protected. For an interfering source consisting of a low rate burst emission,

laboratory tests have shown that a 3 kHz SSB communications channel will not tolerate more than 9 dB of interference above the ambient noise. At the 9 dB point, the conversation intelligibility is lost.

5.5 A PROCEDURE TO EVALUATE PLT IMPACT ON MILITARY SYSTEMS

Figure 5.5-1 shows the measurement arrangement. The noise generator simulates the ambient noise at the location of interest. Its presence provides a realistic measurement. The PLT source can be one of several configurations. A digital generator may be programmed to produce a PLT emission. Two arbitrary waveform generators (I and Q) may be combined and modulated by a suitable RF generator, or the most economical and least troublesome approach would be to acquire a PLT modem and couple it to the measurement system.

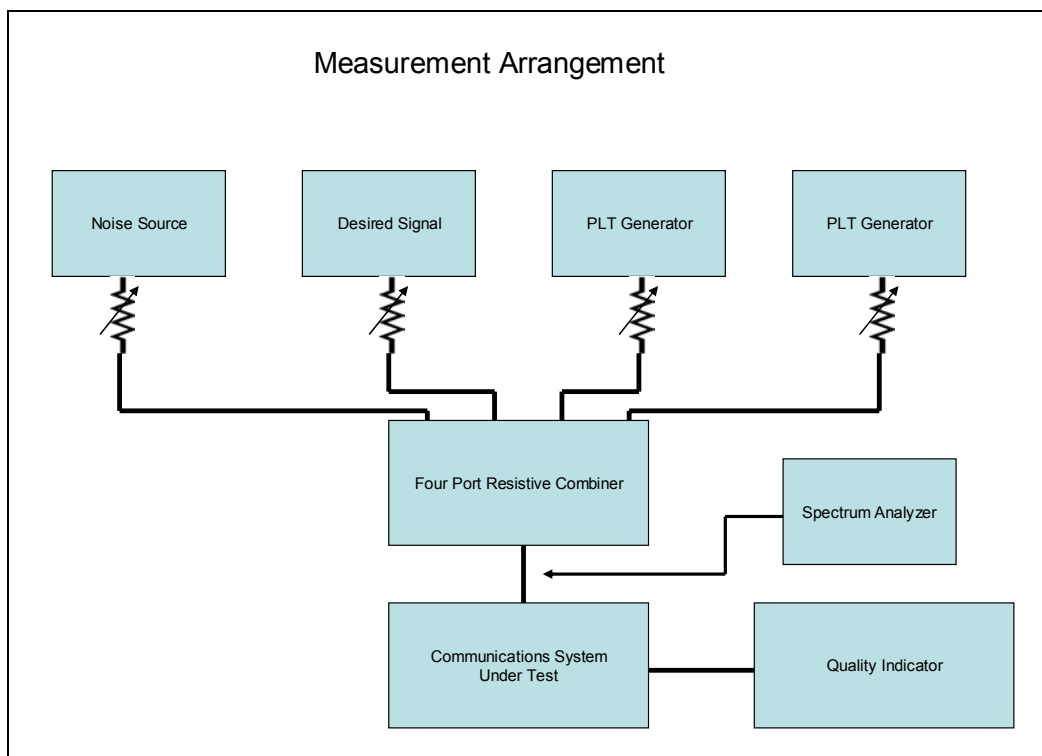

Figure 5.5-1: Measurement Arrangement.

Interference from multiple PLT emissions may be simulated by adding one or more PLT sources.

The procedure for communications systems is then as follows:

- Determine the bandwidth (B_{com}) of the communications channel.
- Set the noise generator to produce the local ambient noise as seen in B_{com} . This value is established from published values or may be measured locally.
- The PLT emission is off.
- Establish a communication link at a level that is deemed acceptable in terms of intelligibility or bit/frame error rate.
- Increase the level of the PLT emission(s) until the link has degraded to the minimum acceptable.

MEASUREMENT OF PLT SYSTEMS

- Care shall be taken that the inputs to the four port combiner do not produce intermodulation products at the output of the combiner. Should intermodulation be present, the levels must be reduced or a hybrid combiner employed.
- A measurement of the level of the PLT emission is then taken by summing the total power in the bandwidth B_{com} using a spectrum analyzer.

From this measurement, the field strength of a PLT emission required to cause impairment of the communications link may be established.

Further it can be calculated/modelled based on the known locations of PLT systems and the victim communications equipment whether a potential for interference exists.

5.6 EVALUATION OF PLT IMPACT ON MILITARY INTELLIGENCE SYSTEMS

Military intelligence gathering systems are designed to operate in electromagnetically quiet areas to receive low level signals. Any increase in ambient noise levels anywhere in the HF band will adversely affect their operations.

Any evaluation procedure dealing with intelligence systems is beyond the scope of this unclassified report. However, in Chapter 8, relevant techniques are presented to predict cumulative effects of PLT emissions.

5.7 ELECTRICAL SAFETY

MV and higher electrical distribution lines may cause serious injury or death through inadvertent contact. The labour laws regarding electrical workers are to be respected for each jurisdiction where measurements are made. For example, Canadian labour laws forbid non-electrical workers from approaching within three metres of a MV distribution line, and the distance increases with voltage. Should conducted measurements be made, the coupling device should bear the clearly visible mark of an electrical regulatory authority. No unlabeled equipment should be connected to the lines. It is advisable to contact the electrical utility operator in advance of the measurements.

5.8 NORTH AMERICAN AND EUROPEAN MEASUREMENT DIFFERENCES

The following table compares the measurement requirements of the United States and Germany for overhead systems (NOTE: In Germany, overhead PLT systems are not in use, but the table applies to telecommunications systems).

Table 5.8-1: Measurement Requirements Comparison

Item	United States	Germany
Power Level	Maximum	Maximum
Duty Cycle	Maximum	Maximum
Detectors	Burst rate >20 Hz Quasi-Peak Burst rate <20 Hz Peak	Quasi-Peak
Measurement Distance	10 metres horizontal corrected for slant distance	3 metres standard
Measurement Distance Correction >30 MHz	$20 \cdot \log(\text{slant range}/10)$	Complex antenna substitution method ... no correction
Measurement Distance Correction < 30 MHz	$40 \cdot \log(\text{slant range}/30)$	N/A
Measurements < 3 metres and < 30 MHz	N/A	Correct as $20 \cdot \log(d/3)$
Measurements > 3 metres and < 30 MHz	N/A	Curve fitted over numerous measurements
Antenna < 30 MHz	Loop	Loop
Antenna > 30 MHz	Linear Polarized E Field	Dipole
Antenna Height > 30 MHz	1 to 4 metres Optional 1 metre and add 5 dB correction	1 to 4 metres
Antenna Height < 30 MHz	1 metre Optimized in azimuth	1 metre
Measurement Location Access Systems	Every $\frac{1}{4} \lambda$ for 1λ from injection point/discontinuity Supplements measurements may be required	3 metres from the lines Local conditions allow for variation
Number of Measurements	Variable – report minimum of 6 highest	
Quasi Peak Correction	N/A	Correction if $(S+N)/N > 20$ dB
Peak Correction	N/A	Correction if $(S+N)/N > 20$ dB
Measurement Axis > 30 MHz	Vertical and Horizontal	XY
Measurement Axis < 30 MHz	Vertical Optimized in azimuth	XYZ (vector sum)

5.9 TYPICAL ACCESS SYSTEM INVESTIGATIVE MEASUREMENTS

5.9.1 Background

The PLT technology is an unintentional radiator communications system that has the potential to degrade the performance of receptors due to radio frequency energy escaping from the power lines over which it is propagated. All of the measurement efforts to date on PLT systems have focused on the issue of compliance and the subject of interference to other spectrum users. Some interest groups have advocated measurements that undoubtedly will present the technology in the worst light. While others attempt to apply techniques that are best used in a laboratory, under controlled conditions, that are unsuited to a field environment.

Others have suggested measurements be made in situations that present a physical danger to the testers.

Here is presented a measurement regimen that will be applicable to all PLT technology field measurements.

5.9.2 Measurement Considerations

A careful consideration of the emission characteristics is required first and foremost.

- Measure the input emission to the power line in advance of transmission for:
 - Spectral signature – total power in the emission.
 - 99% occupied bandwidth.
 - Power spectral density (PSD) 10 kHz spectral segment below 30 MHz and 25 kHz spectral segment above 30 MHz over the 99% width of the emission.
 - CISPR detected values over the 99 % width of the emission.
 - The presence of spectral lines.
 - Peak emissions above the average.
 - Power agility.
 - Minimum power required to communicate.

5.9.2.1 Measurement Questions

Has the presence of concentrators, injectors, extractors and band translators promoted spectral growth or distortion from the quantities measured before transmission?

Has the PSD been distorted by the environment? i.e., reflections, absorptions.

5.9.2.2 Measurement Rationale

Receivers respond very poorly to spectral lines within their channel. They will fare better in a whitened spectrum.

A peak emission that exceeds the average level may prove devastating to a receptor while the average emission power may not. This is a consideration that is only determined by measurement of the PLT system characteristics.

It is quite likely that the CISPR detected measurements will become the accepted method to demonstrate compliance. Essentially, the CISPR values are the most likely values to be used for demonstration of compliance. The other measurements are used to provide insight to the emission and its characteristics.

5.9.3 Equipment

5.9.3.1 Antennas

Below 30 MHz a passive loop is required. The compelling reasons for a passive loop are two fold. The rod antenna factors are not valid unless the rod is placed on a ground plane having a diameter of 1.2 metres which makes it impractical to use in an elevated position. An active loop is prone to undetected overload which will void the measurement.

Above 30 MHz any linearly polarized antenna is acceptable. However, it is wise to use a commonly available device that is generally accepted within the EMC community such as a biconical antenna. There has not been demonstrated a need to measure above an upper limit of 80 MHz.

5.9.3.2 Indicating Instrument

It is important that the indicating instrument be commercially available and conventionally equipped. For wideband evaluations, signature analysis and power spectral density measurement, a spectrum analyzer is the most desirable.

For CISPR measurements, a test receiver is required. Most receivers have a fixed pre-set suite of conditions that are enabled when the CISPR detector is selected, making the measurements ultimately defensible. A test receiver is better able to target a specified event than a spectrum analyzer. A CISPR enabled spectrum analyzer should not be used as the test results can be misleading without an intimate knowledge of how the instrument conducted the measurement in a swept environment.

5.9.3.3 Recommended Test Equipment for Measurements below 30 MHz

- A CISPR 16-1 compliant test receiver with General Purpose Interface Bus (GPIB) capability (9 kHz and 10 kHz IF bandwidth).
- A swept tuned spectrum analyzer with GPIB capability.
- A calibrated magnetic loop antenna.

5.9.3.4 Recommended Test Equipment for Measurements above 30 MHz

- A CISPR 16-1 compliant test receiver with GPIB capability.
- A swept tuned spectrum analyzer with GPIB capability.
- A calibrated biconical antenna.

5.9.3.5 General Test Equipment

- GPIB controller – laptop computer preferred.
- Cables and connectors.

5.9.4 Measurement Geometry

5.9.4.1 Basic Premise

- There are no receptors located directly underneath a power line.
- There are limited receptors located within 3 metres horizontally of a power line.

MEASUREMENT OF PLT SYSTEMS

- There are no receptors less than 1 metre above the ground.
- A measurement distance of 3 metres or less separation from the power line presents a safety of life issue.
- 10 metres horizontal separation is the next generally accepted measurement distance when 3 metres is discounted.
- Propagation is generally along the direction of the power line with lobes at the standing wave points.
- Impedance discontinuities on the power line will radiate and generate standing waves on the line.
- Horizontal and vertical polarizations are to be measured above 30 MHz.

5.9.4.2 Recommended Measurement Points

- The preliminary measurement is at an injector site test point for a wired connection.
- The first radiated measurement is at the power line next to the injector.
- Continue downstream for approximately 2 wavelengths, examining for nodes every $\frac{1}{4}$ wavelength.
- Measure at line discontinuities and operator installed equipment.

5.9.5 Practical Measurements

- Horizontal separation is 10 metres (or best fit if on a city street).
- Normalize the measurement to 10 metres.
- The sight to the power line is to be reasonably unobstructed.
- The height scan begins at 2 metres below the power line to 2 metres above the power line.
- First measurement is at an injector site.
- Determine the polarization and direction of the emission and record the largest value.
- The plane of the magnetic loop is to remain vertical.
- Measure at each $\frac{1}{4}$ wavelength down the power line for up to 2 wavelengths.
- Measure at impedance discontinuities such as transformers or other PLT equipment.
- Record the following parameters at each measurement site:
 - 99% occupied bandwidth (99% of the power contained within the bandwidth).
 - Power spectral density (PSD) 10 kHz spectral segment below 30 MHz and 25 kHz spectral segment above 30 MHz over the 99% width of the emission.
 - CISPR detected values over the 99% width of the emission.
 - Total power in the 99% emission width.
 - Distance with respect to an injector/extractor or other line discontinuity.
 - Height of the receive antenna feed point.
 - Horizontal separation from the power line.
 - Antenna polarization above 30 MHz.

5.9.6 Measurement Records

The details of the measurements are to be recorded such that they may be reproduced by anyone reading the report. They should include, but not be limited to, these items below:

- GPS position or location on a city map.
- List of all equipment and calibration dates.
- People in attendance.
- Height of the antenna with respect to the power line, where the measurement was taken.
- Numerical spectrum analyzer data. Trace values to re-confirm results.
- Analyzer settings including detector.
- Table of system gains and losses with respect to frequency.
- Photographs of a typical test setting.
- Antenna polarization.

5.10 TYPICAL ACCESS SYSTEM REGULATORY MEASUREMENTS

This Section presents an example of compliance measurements of Power Line Telecommunications (PLT) devices. For PLT systems, the measurement principles are based on the current understanding of PLT technology. Modifications may be necessary as measurement experience is gained.

5.10.1 General Measurement Principles for Access PLT and In-House PLT

- 1) Testing shall be performed with the power settings of the Equipment Under Test (EUT) set at the maximum level.
- 2) Testing shall be performed using the maximum RF injection duty factor (burst rate). Test modes or test software may be used for uplink and downlink transmissions.
- 3) Measurements should be made at a test site where the ambient signal level is 6 dB below the applicable limit.
- 4) If the data communications burst rate is at least 20 bursts per second, quasi-peak measurements shall be employed. If the data communications burst rate is 20 bursts per second or less, measurements shall be made using a peak detector.
- 5) For frequencies above 30 MHz, an electric field sensing antenna, such as a biconical antenna is used. The signal shall be maximized for antenna heights from 1 to 4 metres, for both horizontal and vertical polarizations. For Access PLT measurements only, as an alternative to varying antenna height from 1 to 4 metres, these measurements may be made at a height of 1 metre provided that the measured field strength values are increased by a factor of 5 dB to account for height effects.
- 6) For frequencies below 30 MHz, a passive magnetic loop is used. The magnetic loop antenna should be at 1 metre height with its plane oriented vertically and the emission maximized by rotating the antenna 180 degrees about its vertical axis.
- 7) The six highest radiated emissions relative to the limit and independent of antenna polarization shall be reported.
- 8) All operational modes should be tested including all frequency bands of operation.

5.10.2 Access PLT Measurement Principles

5.10.2.1 Test Environment

- 1) The Equipment Under Test (EUT) includes all PLT electronic devices, e.g., couplers, injectors, extractors, repeaters, boosters, concentrators and electric utility overhead or underground medium voltage lines.
- 2) *In-situ* testing shall be performed on three typical installations for overhead line(s) and three typical installations for underground line(s).

5.10.2.2 Radiated Emissions Measurement Principles for Overhead Line Installations

- 1) Measurements should normally be performed at a horizontal separation distance of 10 metres from the overhead line. If necessary, due to ambient emissions, measurements may be performed at a distance of 3 metres. Distance corrections are to be made.
- 2) Testing shall be performed at distances of 0, $\frac{1}{4}$, $\frac{1}{2}$, $\frac{3}{4}$ and 1 wavelength down the line from the PLT injection point on the power line. Wavelength spacing is based on the mid-band frequency used by the EUT. In addition, if the mid-band frequency exceeds the lowest frequency injected onto the power line by more than a factor of two, testing shall be extended in steps of $\frac{1}{2}$ wavelength of the **mid-band** frequency until the distance equals or exceeds $\frac{1}{2}$ wavelength of the **lowest** frequency injected. (For example, if the device injects frequencies from 3 to 27 MHz, the wavelength corresponding to the mid-band frequency of 15 MHz is 20 metres, and wavelength corresponding to the lowest injected frequency is 100 metres. Measurements are to be performed at 0, 5, 10, 15 and 20 metres down line – corresponding to zero to one wavelength at the mid-band frequency. Because the mid-band frequency exceeds the minimum frequency by more than a factor of two, additional measurements are required at 10-metre intervals until the distance down-line from the injection point equals or exceeds $\frac{1}{2}$ of 100 metres. Thus, additional measurement points are required at 30, 40 and 50 metres down line from the injection point).
- 3) Testing shall be repeated for each Access PLT component (injector, extractor, repeater, booster, concentrator, etc.).
- 4) The distance correction for the overhead-line measurements shall be based on the slant range distance, which is the line-of-sight distance from the measurement antenna to the overhead line. (For example, if the measurement is made at a horizontal distance of 10 metres with an antenna height of 1 metre and the height of the PLT-driven power line is 11 metres, the slant range distance is 14.1 metres [10 metres vertical distance and 10 metres horizontal distance]. [At frequencies below 30 MHz, the measurements are extrapolated to the required 30-metre reference distance by subtracting $40 \log(30/14.1)$, or 13.1 dB from the measured values. For frequencies above 30 MHz, the correction uses a 20 log factor and the reference distance is specified in regulation].

Note: In cases where Access PLT devices are coupled to low-voltage power lines (i.e., HomePlug or modem boosters), apply the overhead-line procedures as stated above along the low-voltage lines.

5.10.2.3 Radiated Emissions Measurement Principles for Underground Line Installations

- 1) Underground line installations are those in which the PLT device is mounted in, or attached to, a pad-mounted transformer housing or a ground-mounted junction box and couples directly only to underground cables.

- 2) Measurements should normally be performed at a separation distance of 10 metres from the in-ground power transformer that contains the PLT device(s). If necessary, due to ambient emissions, measurements may be performed at a distance of 3 metres. Distance corrections are to be made.
- 3) Measurements shall be made at positions around the perimeter of the in-ground power transformer where the maximum emissions occur. A minimum of 16 radial angles surrounding the EUT is required (In-ground transformer that contains the PLT device(s)). If directional radiation patterns are suspected, additional azimuth angles shall be examined.

5.10.2.4 Conducted Emissions Measurement Principles

- 1) Conducted emissions testing is not required for Access PLT.

5.10.3 In-House PLT Measurement Principles

- 1) *In-situ* testing is required for testing of the functions of the In-House PLT device.

5.10.3.1 Test Environment and Radiated Emissions Measurement Principles for *In-Situ* Testing

- 1) The Equipment under Test (EUT) includes In-House PLT modems used to transmit and receive carrier PLT signals on low-voltage lines, associated computer interface devices, building wiring and overhead or underground lines that connect to the electric utilities.
- 2) *In-situ* testing shall be performed with the EUT installed in a building on an outside wall on the ground floor or first floor. Testing shall be performed on three typical installations. The three installations shall include a combination of buildings with overhead-line(s) and underground line(s). The buildings shall not have aluminium or other metal siding, or shielded wiring (e.g., wiring installed through conduit, or BX electric cable).
- 3) Measurements shall be made at positions around the building perimeter where the maximum emissions occur. A minimum of 16 radial angles surrounding the EUT (building perimeter) are to be measured. If directional radiation patterns are suspected, additional azimuth angles shall be examined.
- 4) Measurements should normally be performed at a separation distance of 10 metres from the building perimeter. If necessary, due to ambient emissions, measurements may be performed a distance of 3 metres. Distance corrections are to be made.

5.10.3.2 Additional Measurement Principles for *In-Situ* Testing with Overhead Lines

- 1) In addition to testing radials around the building, testing shall be performed at three positions along the overhead line connecting to the building (i.e., the service wire). It is recommended that these measurements be performed starting at a distance 10 metres down the line from the connection to the building. If this test cannot be performed due to insufficient length of the service wire, a statement explaining the situation and test configuration shall be included in the technical report.
- 2) Measurements should normally be performed at a horizontal separation distance of 10 metres from the overhead line connecting to the building. If necessary, due to ambient emissions, measurements may be performed a distance of 3 metres. Distance corrections are to be made using the slant range distance.
- 3) The distance correction for the overhead-line measurements shall be based on the slant range distance, which is the line-of-sight distance from the measurement antenna to the overhead line.



Chapter 6 – PROPAGATION PATH LOSS MODELS

There are two major radio wave propagation mechanisms in the HF frequency range: “Sky waves”, in which the radio waves are refracted in the ionosphere, and “ground waves”, propagating along the ground. Generally, sky waves can reach farther, but there is a loss associated with the refraction and also by D-layer absorption. In this chapter we discuss models for predicting path loss of sky wave and ground wave propagation. We recommend one model for each propagation type, and discuss relevant input parameters when the models are used to predict propagation of PLT/xDSL signals.

6.1 NEAR FIELD EFFECTS

The HF noise level in the vicinity of PLT installations has been considered in numerous other studies, e.g., the report from Phase 1 of NTIA’s BPL study [14] and work by NHQC3S [13],[54]. The former study concludes that interference from PLT to a station receiving low-level signals is likely at distances up to 460 m from a single Access PLT installation using overhead power lines.

In the work of the present RTG, we focus on sensitive receiver sites where the user generally can be assumed to have control over the vicinities, such that a protection radius of up to 1 km, without PLT installations, can be employed. In this case, the cumulative effect of long-distance propagation from a large number of PLT installations may be a more serious problem that requires careful consideration. We have therefore chosen to focus on this less-studied problem in our work.

6.2 SKY WAVE PROPAGATION

Sky waves propagate by refraction in the E and F regions of the ionosphere. They may suffer absorption when passing through the D region (below the E region). The ionospheric conditions vary with time of day, time of year, and solar and geomagnetic activity. Different *prediction models* exist, in the form of software, to predict the propagation path loss at different frequencies as well as the MUF (maximum usable frequency) and LUF (lowest usable frequency) for propagation. The input parameters to such prediction programs are typically time of day, month, transmitter and receiver position, frequency, sunspot number, and possibly a geomagnetic index. Sunspot numbers and geomagnetic indices can be found on the Internet. The geomagnetic index is used in programs which use special models for high latitudes.

Due to the variations and uncertainty in ionospheric conditions, prediction programs can only give statistical information, e.g., “a signal-to-noise ratio exceeding xx dB will be received with a probability of yy %”.

6.2.1 Different Prediction Methods

The Task Group has evaluated different sky wave prediction programs for use in predicting long-range propagation of PLT/xDSL signals. The evaluation is partly based on previous work by FFI [19].

6.2.1.1 The IONCAP Family (REC533, VOACAP, ICEPAC)

The IONCAP (Ionospheric Communications Analysis and Prediction) program was developed by the ITS (Institute of Telecommunications Sciences) in Boulder, Colorado, in the 1970s. This program was used as a basis for the CCIR (now ITU-R) Recommendation REC533 [20] for prediction of ionospheric propagation. Later, the model was improved for the Voice of America (VOA), giving the VOACAP program.

PROPAGATION PATH LOSS MODELS

One weakness with REC533 and VOACAP is that the ionospheric model is inaccurate at high latitudes; it does not take geomagnetic effects (e.g., aurora) into account. To remedy this the ICEPAC (Ionospheric Communications Enhanced Profile Analysis and Circuit Prediction) program was developed with a much more elaborate high-latitude ionospheric model called ICED (Ionospheric Conductivity and Electron Density), taking the geomagnetic Q index as an additional input parameter.

In the doctoral work [21] ICEPAC predictions were compared with measurements on two high-latitude paths. Some discrepancies were found, e.g., the D layer electron density profile used in ICED was found to be too weak, giving too low predicted path loss in certain cases. Still, FFI has been using the ICEPAC program when doing propagation studies for the Norwegian Armed Forces, because it is the most advanced model within the IONCAP family.

The three programs of the IONCAP family do not produce identical results, as illustrated in Figure 6.2-1. Here, the same input parameters have been provided to all three programs, and we note that the predicted area coverage is different. REC533 predicts lower path loss than the other programs at short distances, and higher path loss than the others at long distances. VOACAP and ICEPAC produce similar results at low latitudes, but very different at high latitudes. This is because a geomagnetic index $Q = 8$ was used, corresponding to disturbed geomagnetic conditions with the auroral oval right north of Bodø in Northern Norway. When setting $Q = 0$, ICEPAC and VOACAP produce almost identical results.

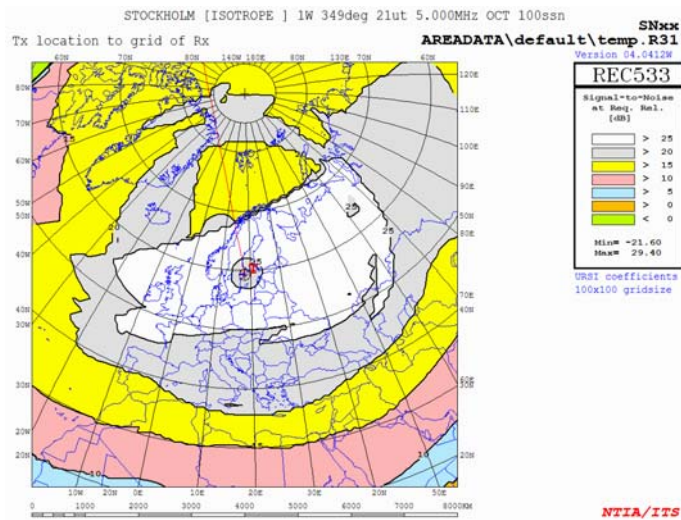

Input parameter settings:

- October, SSN = 100
- TX in Stockholm
- Noise level rural (-150 dBW/Hz @ 3 MHz)
- Required circuit reliability 50%
- Required SNR (1 Hz bandwidth): 30 dB
- TX power: 1 W (30 dBm)
- Ignore signal degradation by multipath
- Isotropic TX and RX antennas
- Minimum considered take-off angle 0.1 deg (3 deg for REC533)
- Geomagnetic index Q = 8 (ICEPAC only)

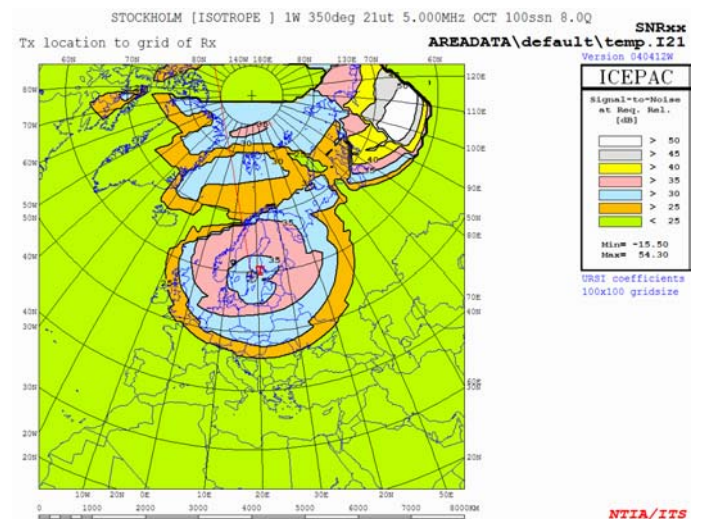
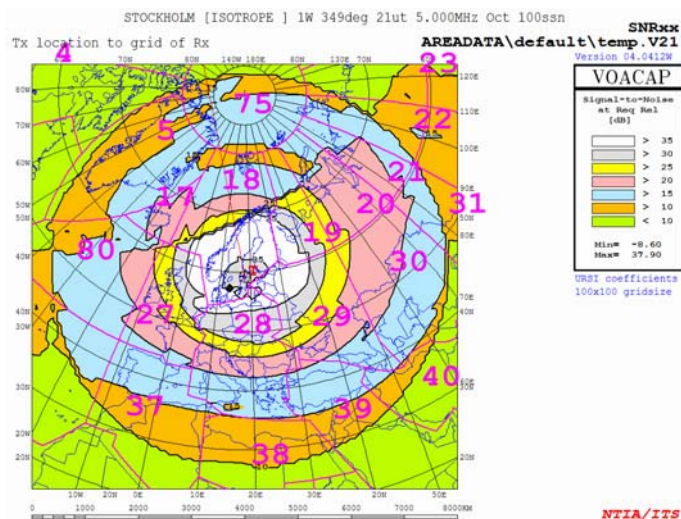

Figure 6.2-1: Area Predictions with TX in Stockholm at 5 MHz, 21UTC, using (from top left to bottom right) REC533, VOACAP and ICEPAC. Note the different scaling of the colour codes.

The programs in the IONCAP family can be downloaded free of charge from <http://elbert.its.blrdoc.gov/hf.html>. The user interface is relatively intuitive.

6.2.1.2 Propwiz

The Propwiz program was developed by Rohde&Schwarz. A demo version can be downloaded free of charge from R&S’ web page, but since it does not support operating systems newer than Windows NT at the time of writing, we have not considered it further here.

6.2.1.3 Proplab-Pro

Proplab-Pro is a very advanced program developed by Solar Terrestrial Dispatch. It includes two different “ray-tracing” techniques, called simple and complex. Our experience is that the program is very unstable when running under Windows XP, and even the “simple” technique takes an excess amount of time to run. However, when using ray-tracing one gets a good visualization of how sky wave propagation works. The program can be downloaded for a fee of USD 150 from <http://www.spacew.com/www/proplab.html>.

6.2.1.4 ASAPS and GRAFEX

These programs use a propagation model developed by IPS Radio and Space Services in Australia, <http://www.ips.gov.au/>. ASAPS (Advanced Stand Alone Prediction Systems) can be installed locally on a PC, while GRAFEX is a Java program running on IPS' Web server. A demo version of ASAPS can be downloaded free of charge, the full version costs AUD 350.

The user interface of ASAPS is quite advanced, including databases of transmitter and receiver positions, as well as available equipment. The ionospheric model used in ASAPS and GRAFEX is parameterised by the so-called T index rather than sunspot number (SSN). The T index is an "equivalent sunspot number" obtained by observing ionospheric propagation and mapping to a propagation model parameterised by SSN. This approach will to a certain extent compensate for geomagnetic conditions at high latitudes. In the demo version of ASAPS it is not possible to change the T index from the default value of 50.

6.2.1.5 HF-EEMS

The HF-EEMS program is developed by DERA (now QinetiQ) in the UK. The program combines a model for sky wave propagation (can choose between REC533 and a ray-tracing model called SMART using an ionospheric model called PIM) and the GRWAVE program for groundwave propagation. In the user interface you can in addition to positioning the transmitter and the receiver also give the position of a jammer, in order to assess the vulnerability to jamming. The program can be purchased through BAE Systems, UK.

6.2.1.6 Simple Reflection Model

A simple sky wave propagation model often used in the PLT literature was proposed by Stott in [55]. The ionosphere is modelled as a reflector at height h above ground (e.g., 300 km). The path loss is computed as the free space loss for the total distance from transmitter to reflection point and back down to receiver (i.e., a distance of at least $2h$). An additional loss (e.g., 10 dB) associated with the reflection is also included. This model is an analytical expression which is very easy to use, but does not take into account diurnal or seasonal variations, and does not include any means to model skip zone effects. By skip zone is meant that sky wave propagation under some conditions is only possible at distances larger than a certain threshold called the skip distance, given by the critical reflection angle of the ionosphere.

6.2.2 Recommended Prediction Method

Among the prediction models described above, our first recommendation is to use one of the programs of the IONCAP family. This recommendation is based on the facts that these programs are well-proven in practice by many users. Among the three programs of the IONCAP family, we recommend using ICEPAC because it is the newest and therefore most advanced model, and effectively has been used for frequency planning by the administrations of several of the countries involved in the Task Group.

6.2.3 Relevant Input Parameters

Assume that we are primarily interested in predicting the cumulative interference at a particular sensitive receiver location, from interference sources in different regions. By the reciprocity theorem, this is the "reverse" problem of the area coverage maps in Figure 6.2-1 (which are relevant for broadcast planning). To generate area coverage maps for the path loss from different regions where PLT might be installed to a specific sensitive receiver site, we should therefore use executable ICEAREA INVERSE, which has reversed the role of TX and RX compared to the executable ICEAREA.

ICEPAC is able to predict received SNR relative to the background noise level. We do, however, *not* recommend using this method to predict the increase in noise level caused by PLT/xDSL interference,

since when computing the cumulative interference from larger regions, the received interference should be summed up before comparing to the background noise level. For these reasons, predicted path loss rather than SNR is the output result of interest.

The Task Group recommends running the executable ICEAREA INVERSE (ICEPAC inverse area prediction) and selecting input parameters as follows:

- Parameters: LOSS (predicts the path loss directly).
- Grid Type: Either Great Circle (to use a geometrically square grid) or Lat/Long (to use a geographical latitude/longitude grid). Lat/Long grid is of convenience if the result is to be used in conjunction with gridded population density data (see Chapter 8).
- Grid Size: Depends on desired grid resolution and X-range and Y-range, see under “X-range and Y-range” below.
- Path: Short.
- Coefficients: URSI88 (we have not seen large difference when using CCIR coefficients, but recommend using URSI88 since these are the newest).
- Method: Auto select.
- Receiver: Set equal to sensitive receiver location.
- Plot Centre: Set equal to Receiver.
- X-range and Y-range:
 - For Great Circle Grid: –4000 km to +4000 km should be sufficient (approximately the maximum distance for single-hop propagation, limited by the Earth’s curvature), unless interference from farther-away regions is of particular interest. If it is known that PLT/xDSL is installed only in some regions, X-range and Y-range can be adjusted accordingly in order to reduce computation time. If 50 km resolution is required and X-range and Y-range is ± 4000 km, grid size should be 161 x 161.
 - For Lat/Long Grid: Examine the map to find proper values of minimum/maximum latitude and longitude. Ensure that the difference between maximum and minimum value is the same for latitude and for longitude (e.g., longitudes from –20 to 50 degrees and latitudes from 10 to 80 degrees to cover Europe and Northern Africa) such that the angular resolution becomes identical in both directions. To ensure direct compatibility with gridded population density data (see Chapter 8), select grid size such that the resolution is 0.25 degrees (e.g., 281 x 281 for the values given above).
- Groups: Select the frequencies and times of year and day of interest. Unless interested in special propagation conditions, select SSN = 100 and Q = 0.
- System: Min. angle = 0.1 deg, multipath power tolerance = 10 dB, maximum tolerable time delay = 15 ms (the latter two values are increased from the defaults in order to account for different propagation paths). The other system parameters, including transmitter power, are irrelevant when predicting path loss only.
- Fprob: Keep default values.
- TX antenna: default/isotrope
- RX antenna: default/isotrope, or insert knowledge about antenna at the sensitive receiver location.

PROPAGATION PATH LOSS MODELS

If only one case is selected under “Groups”, run “Save/Calculate/Screen”. The result will be output to a map on screen and saved to a file *xxx.igl*. If several cases are selected under “Groups”, run “Save/Calculate”. The results will be saved to files *xxx.igl*, *xxx.ig2*, *xxx.ig3* and so on. The output files *xxx.igx* are text files which can be used in further post-processing to evaluate cumulative effects.

In Figure 6.2-2 and 6.2-3 is shown an example output from ICEPAC using input parameters as recommended here. Here, we consider a hypothetical sensitive receiver location in Bodø, at 18 UTC in June. Operating frequency of interest is 11.85 MHz and the sunspot number is 100. For this example, we see that densely populated areas in Europe, where widespread PLT/xDSL installations may be deployed, fall within the region of path loss lower than 140 dB (orange and green). Note that the predicted path loss is a median value.

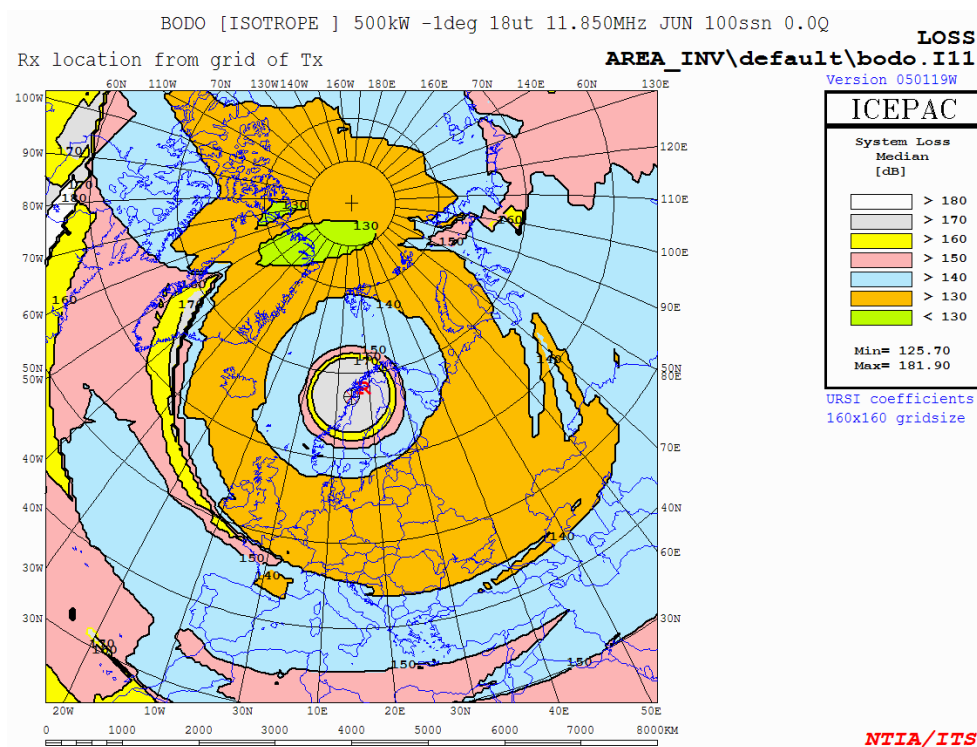

Figure 6.2-2: Example ICEPAC Output with Input Parameters as Recommended by the Task Group, using a 4000 x 4000 km Great Circle Grid.

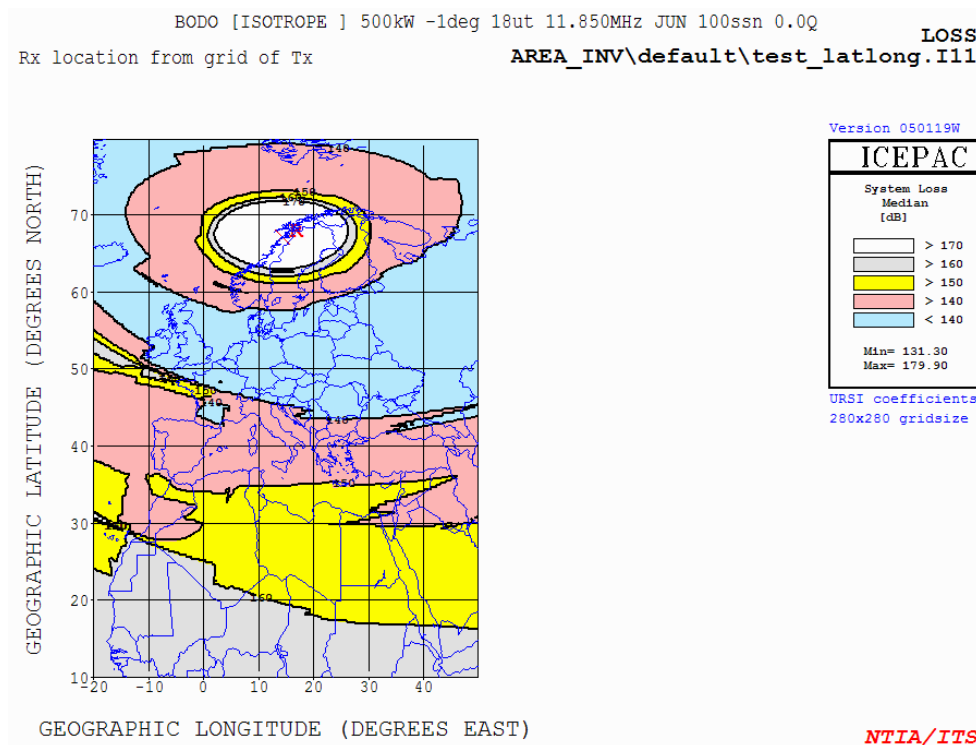

Figure 6.2-3: Example ICEPAC Output with Input Parameters as Recommended by the Task Group, using a Lat/Long Grid. Note that the results are identical to Figure 6.2-2 except from the representation (grid, projection and colour coding is different).

6.3 GROUND WAVE PROPAGATION

Ground waves propagate near the ground in the form of space and surface waves. The space wave consists of a direct wave and a reflected wave, normally cancelling each other in the HF range: Due to low grazing angles, the reflection coefficient is close to -1 , and the difference in path length between the direct and reflected wave is short compared to the wave length. Therefore, the surface wave is dominant. It can be described as a current induced in the transition between air and ground.

Surface waves are most dominant in the lower part of the HF frequency range (and below) and for vertically polarized transmitter/receivers close to the ground (compared to the wavelength). When the frequency is increased (or antennas elevated), the space wave gains importance.

The electrical characteristics of the ground (conductivity, permittivity and permeability) are important in predicting the received field strength, and tables and figures connecting ground types to conductivity/permittivity can be found in [25] and [80]. Permeability is normally assumed to be that of free space.

Ground conductivities in the world may be taken from [28].

The attenuation from terrain obstacles decreases with decreasing frequency. Models as well as measurements indicate that the terrain profile may be considerably less important than ground constants at the lower HF frequencies.

Time variability of the ground wave path loss is much less than that of the sky wave. Main causes of variation are changes in ground moisture content from heavy rainfall or snow/ground frost at land, and waves and tidal variations at sea.

6.3.1 Different Prediction Methods

A range of different models exist for modelling ground wave propagation in general, or at HF frequencies in particular. Some are available as separate computer programs, or as a part of larger frequency planning software.

In the case that the earth can be considered smooth (no terrain obstacles) and homogenous (a single set of ground constants), the theoretical model GRWAVE by Rotheram has been verified and found to be highly accurate [29]. A software implementation is available for free download at <http://www.itu.int/ITU-R/study-groups/software/rsg3-grwave.zip>. ITU-R P.368-7 shows ground-wave propagation curves for frequencies between 10 kHz and 30 MHz [30].

For changes in ground constants (for instance sea-land paths), GRWAVE is not applicable in itself. However, Millington's method [22] can be used in such cases as an extension to GRWAVE for good results. Millington's method is a semi-empirical method that uses sections of uniform ground conditions (where e.g., GRWAVE can be used) while ensuring reciprocity.

Detvag90, used in WRAP, can be used for paths that contain both changes in ground constants through Millington's method, as well as terrain obstacles by combining surface wave loss and space wave loss (diffraction) in the square root model by Blomquist and Ladell [23].

WAGSLAB [24] can also take ground-changes as well as terrain obstacles, although numerical instability may make it less suitable at the higher end of the HF range.

6.3.2 Recommended Prediction Method

The Task Group recommends GRWAVE for our application, since it has been thoroughly verified and does not require any detailed terrain information. The limiting factor in predictions will often be the available data, meaning that a more sophisticated model cannot necessarily give significantly more accurate predictions, even though such a model may be more accurate in isolated cases. However, one should be aware of the limitations of GRWAVE and use caution when utilizing it outside its validity range.

In certain cases, such as mixed sea/land paths, where there is a need for more than one ground conductivity/permittivity, the group recommends using Millington's method.

6.3.3 Relevant Input Parameters

GRWAVE can be run from a command line window on a Windows computer using text files as input and output. Parameter-name/value pairs are entered as separate lines. Important parameters are described below.

- **HTT**: The height of transmitter (in meters).
- **HRR**: The height of receiver (in meters).
- **IPOLRN**: Polarity of transmitter antenna. Use 1 (if both polarisations are present, use vertical polarisation for worst case prediction due to lower path-loss).
- **FREQ**: Frequency [MHz].
- **SIGMA**: Ground conductivity [S/m].
- **EPSLON**: Ground permittivity.
- **dmin**, **dmax** and **dstep**: minimum, maximum and step size of calculated path distances.

Chapter 7 – MODELLING OF WIRE-LINE TRANSMISSION SYSTEMS AS HF NOISE SOURCES

In this Chapter, the general foundation of modelling wire-line transmission systems is presented. In Section 7.1, the principal aspects or mechanisms of the radiated power is addressed, including results from studies and measurement projects. In Section 7.2, the rigorous theoretical basis of PLT modelling by means of dipoles is outlined. In Section 7.3, radiated power estimation from measured electric field is presented. In Section 7.4, the distance conversion factor near a PLT is investigated and compared with measured results. Finally, in Section 7.5, representative PLT sources are listed.

7.1 PRINCIPAL ASPECTS OF THE RADIATED POWER IN THE FAR-FIELD

Figure 7.1-1 shows a simplified model of a wire-line transmission system. The transmitter (PLT or xDSL) injects the signal differentially between two wires, with a power spectral density (PSD) measured in units of dBm/Hz. With an ideal transmission line, there would be no common mode (CM) signal relative to ground caused by the differentially injected signal, but in reality there is. The ratio between CM and differential mode (DM) signal is given by the Common Mode Rejection Ratio (CMRR) or Longitudinal Conversion Loss (LCL). For the differential signal the contribution from the two wires will cancel out in the far-field. This is not the case for the CM signal, which therefore will be the most prominent radiation source.

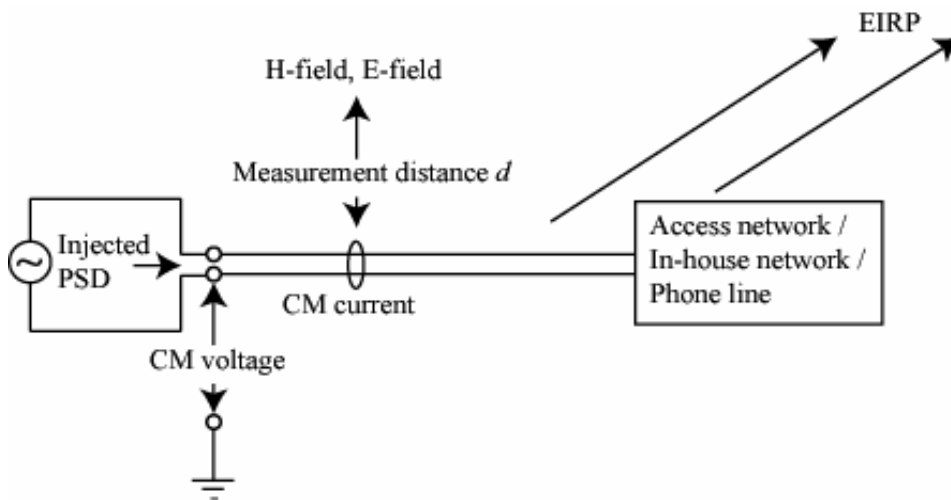

Figure 7.1-1: Simplified Model of a Wire-Line Transmission System, including Quantities Relevant to Far-Field Radiation.

The CM signal consists of a CM current and CM voltage propagating along the line. The ratio between the two is given by the common mode impedance, and the return path for the CM current is through ground. The proposed PLT regulations in Europe define an upper limit on the CM current. In case of reflections and standing waves, caused by impedance discontinuities in the network, the measured CM current level will be different at different positions along the line.

The radiation limits in the German NB30 and the US FCC Part 15 are defined as the field strength at a measurement distance d of 3 m and 10 m, respectively. Even though the limit is defined as an electrical field strength in units of dB μ V/m (in a specified measurement bandwidth), the actual measurement

procedures below 30 MHz *by definition* measure the magnetic field strength and converts the number to an electric field strength using the far-field free-space impedance of $Z_0 = 120 \pi$ ohms. Even though this relationship is not exact in the near field, it may still be a good indicator of the ratio between the *maximum* electric and magnetic field strengths [94].

The quantity of interest when considering cumulative effects in the far-field is the EIRP (equivalent (or effective) isotropic radiated power) per unit bandwidth caused by each signal source, in units of dBm/Hz, at different frequencies. The radiation pattern might also be of interest in some cases, but when summing up many different sources with different wiring geometries over a wide area, it is reasonable to approximate the average radiation pattern as isotropic in elevation as well as in azimuth [61],[89]. In the following sections we discuss how the EIRP can be estimated based on available information on injected PSD, CM current, or field strength at some measurement distance.

7.1.1 Antenna Gain Measurements

The antenna gain of a wire-line transmission system is defined as the ratio between EIRP and injected power. For power line systems, several measurement results are reported in the literature, using two principally different measurement methods:

- One method is to inject a signal of known power onto the line and measure the received signal strength at horizontal distances of some km (with ground wave propagation) or overhead in an airplane (with direct wave propagation). Adding the estimated path loss (using GRWAVE or free-space formulas, respectively) to the received signal strength gives an estimate of the EIRP directly. The uncertainty related to the path loss estimate is higher for ground wave than for direct wave.
- The other method is to use the power network as a receiver antenna for remote broadcast transmissions and measure the received signal strength at the injection point. This measurement can be compared with a simultaneous collocated measurement of the same broadcast signal using a calibrated reference antenna, and the difference between the two measurements compared to reference antenna gain gives the antenna gain directly. Assuming reciprocity of the radio channel and power line network, the receive antenna gain is equal to the transmit antenna gain. This method is easier than the first method, but the measurements can only be conducted at frequencies and directions given by the broadcast transmitters.

Ref. [55] assumes the antenna gain for power line systems to be -20 dBi, referring to airborne measurements.

Ref. [57] reports measured antenna gains in the range -20 dBi to -50 dBi, based on received broadcast signals. The measurements close to -20 dBi were for In-House systems, while those close to -50 dBi were for underground Access cables.

Ref. [58] reports measured antenna gains in the range -30 dBi to -50 dBi, based on measured ground wave radiation. The measurements close to -30 dBi were for In-House systems, while those close to -50 dBi were for underground Access cables.

Ref. [59] reports antenna gains for In-House systems to be approximately -30 dBi, based on received broadcast signals.

Ref. [60] estimates the measured gain of a sample house wiring to be in the range -20 to -30 dBi, based on radiated measurements 10 m from the wall outside the house.

Reference [61] mentions a worst-case antenna gain for power line systems of -15 dBi.

Measurements with 9 kHz bandwidth presented in [68] over a wide range of European power line networks show that on average an injected power level of 0 dBm leads to an electrical field strength of about 60 dB μ V/m at 3 m measurement distance.

Gain measurements of In-House grids by the university of Karlsruhe [7, p. 83], based on received broadcast signals, show mean values of -40 dBi for $f < 10$ MHz and -30 dBi for $f > 10$ MHz.

According to discussions cited in minutes from a SE35 meeting in 2001 [66], “It was generally felt that this gain is in the order of -20 dBi for aerial cables and of -30 to -40 dBi for buried cables.”

Based on these references, the Task Group recommends using the following antenna gains:

- -30 dBi for In-House systems;
- -15 dBi for overhead Access systems; and
- -50 dBi for underground Access systems.

It should be recognized that there are uncertainties in these numbers of the order of ± 5 to ± 10 dB due to statistical spread. Furthermore, in the case of overhead Access system power lines, at resonant frequencies the antenna gain may be higher by $10 - 13$ dB [73].

7.1.2 CMRR/LCL Measurements

CMRR/LCL values are generally measured as the ratio between the DM and CM voltages *at the injection point*. This may not be a representative measurement with respect to radiation, since impedance mismatches and standing waves can cause large variations in the CM current along the line.

A measurement procedure for LCL of PLT systems is presented in [95].

Measurements presented in [67] over a wide range of European power line networks show average LCL values of about 30 dB.

Measurements presented in [69] show large variations in the CM current at different positions in a house (and also at different frequencies). For an injected power level of about 0 dBm the CM current varies between 10 dB μ A and -30 dB dB μ A at the same frequency.

Simulation results presented in [65] indicate that, for the case of a single straight power line with no branches, a LCL of 24 dB (asymmetrical loading) will cause the radiated power to increase by $50 - 70$ dB compared to symmetrical loading. For more complicated network geometries, the increase in radiation due to asymmetrical loading is similar for low HF frequencies and higher for high HF frequencies. According to [70], the CM currents along the line can not be deduced from the CM signal at the feed point due to this kind of variations, and therefore the LCL can not directly be used to estimate the radiated fields in case of PLC. Similar arguments are given in [71].

7.1.3 Numerical Methods

Several works have used numerical methods, e.g., Numerical Electromagnetic Code (NEC), to model radiation from wire-line networks. Based on a modelled network geometry and signal injection point, it is possible to compute the field strength at any point in space, the CM current at any point along the line, and the far-field radiation in all directions. This approach is very exact if the model is realistic, and can give direct estimates of the ratio between EIRP and field strength at measurement distance, or between EIRP and common mode current.

The downside to this approach is that it only gives results for a single geometry, and general conclusions may be hard to draw. An example of general conclusions is found in [61], which reported that summation of radiation patterns of NEC models for a large number of houses in London gives an average radiation pattern that is close to isotropic in azimuth as well as in elevation (at 90° elevation the radiation pattern is 6 dB below the maximum).

In [73], a detailed simulation of an example overhead wiring geometry is presented, using an FDTD (finite difference time domain) method. Among other things, this simulation predicts that an injected power spectral level of -50 dBm/Hz can give rise to field strength levels of 65 dBμV/m at a distance $d = 10$ m from the line, in a 3.5 kHz measurement bandwidth in the frequency range 21 – 24 MHz. This corresponds to a PSD (EIRP/Hz) of -55.2 dBm/Hz, or an equivalent antenna gain of -5.2 dBi. This value is higher than the recommended -15 dBi, but it is not known if the wiring geometry was resonant at the frequency of simulation. However, it is within the aforementioned uncertainty criteria.

Other numerical simulations of PLT systems are found in [96],[97].

7.1.4 Ampere's Law

For the case of a static (DC) common mode current on a long straight wire, the relationship between the CM current I_{CM} and the magnetic field H at measurement distance d would be given by Ampere's law (or from the Biot-Savart law): $H(d) = I_{CM} / 2\pi d$.

For alternating fields, this formula is not exact, but is a good approximation only for $d \ll \lambda$. It was used by the European JWG when converting field strength limits to CM current limits.

7.1.5 Impedance Discontinuities

In Annex 4 of [3] expressions are developed in the far-field, for the relationship between the EIRP and the field strength measured with a magnetic loop, at a measurement distance d , assuming that the radiation source is a small electric or magnetic dipole (in theory infinitesimal, in practice very small compared to the wavelength). These may be good models for radiation caused by impedance discontinuities, but are obviously inexact for radiation from long wires.

The derivations assume that the field strength is measured using a magnetic loop antenna and converted to electric field $E(d)$, in units of V/m, using the free-space impedance of 120π ohms (by definition).

Assuming a small electric dipole, the relationship is shown to be

$$\text{EIRP} = \frac{d^4}{d^2 + \left(\frac{\lambda}{2\pi}\right)^2} \frac{[E(d)]^2}{30} \quad (7-1)$$

Assuming a small magnetic dipole, the relationship is shown to be

$$\text{EIRP} = \frac{d^6}{\left(\frac{\lambda}{2\pi}\right)^4 - \left(\frac{\lambda}{2\pi}\right)^2 d^2 + d^4} \frac{[E(d)]^2}{30} \quad (7-2)$$

where $E(d)$ is in V/m, d and λ are in metres, 30 is in ohms, and EIRP is in Watts.

Figures in Annex 4 of [3] show that for $d = 3$ m, the two models are relatively close (within 3 dB) above 8 MHz, but differ by 15 dB at 3 MHz (the electric dipole model predicting the highest EIRP). For $d = 10$ m, the difference between the two models is within 3 dB in the entire HF frequency range.

If this approach is applied, it is recommended that the above formula (7-1) for an electric dipole be used, since power lines are more likely to behave as electric than magnetic antennas. However, it should be noted that this formula is inexact for radiation from wires of length comparable to the wavelength, or longer. The approach is therefore likely to be more suitable for In-House systems than for Access systems. For overhead PLT lines of Access systems, the expression given in Section 7.3 is the appropriate one.

7.2 PLT LINE MODELLING TECHNIQUES WITH DIPOLES

In modelling the emissions from a PLT line, one of the best techniques is to model the PLT wires as a successive set of dipoles, assuming that the standing waves present are the dominant emission source. As the PLT is basically a wire, the dipole is the nearest model to a wire. To implement such an approach, the dipole formulation needs to be addressed first. As to the dipole type, both half-wavelength and one-wavelength dipoles are suitable; however, the half-wavelength has the wider half-power beamwidth (78 degrees vs. 48 degrees), therefore it is preferable (the wider the beamwidth, the smoother the pattern overlap).

There are two main issues:

- a) the determination of the field strength roll-off with respect to distance away from the PLT (the distance conversion factor); and
- b) the general profile of the field strength at various distances away from the PLT in order to assess the interference effects.

It should be noted that the following modelling techniques apply to overhead Access PLT systems. In-House systems contain both vertical and horizontal lines. To model these lines, numerical electromagnetic computational models have to be used. In view of the great variety of in-house wiring geometries, a universal model is not possible. Therefore, measurement results obtained by various groups are used (see Section 7.4.1).

7.2.1 Exact Solution of a Dipole

The exact solution of a dipole, valid at any distance in both near-field and far-field, can be carried out by means of the geometry shown in Figure 7.2.1-1. Given the PLT geometry, the cylindrical coordinate system is more practical in this case rather than the spherical coordinate system generally used in electromagnetics.

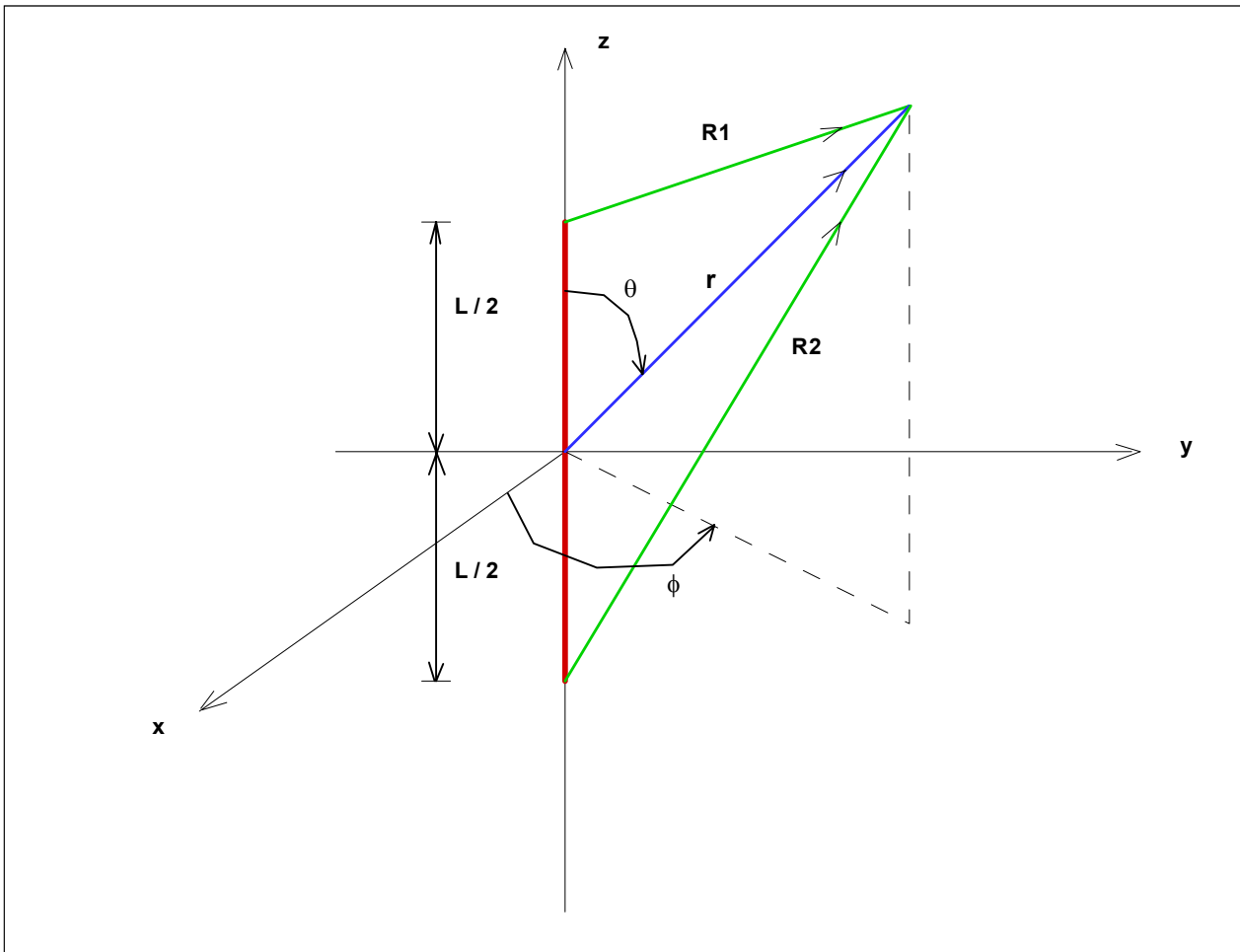

Figure 7.2.1-1: The Geometry of Dipole used in the Derivation of Fields.

Assuming a sinusoidal current distribution along each half of a dipole of any length L , along the z -coordinate axis:

$$\begin{aligned}
 I(x', y', z') &= I_0 \sin\left(k\left(\frac{L}{2} - z'\right)\right) \hat{z} & 0 \leq z' \leq \frac{L}{2} \\
 I(x', y', z') &= I_0 \sin\left(k\left(\frac{L}{2} + z'\right)\right) \hat{z} & -\frac{L}{2} \leq z' \leq 0
 \end{aligned}
 \tag{7-3}$$

where k is the free-space wave number (or propagation constant) and is given by: $k = \frac{2\pi}{\lambda}$, and I_0 is the line current.

In cylindrical coordinates, the field components are then represented by the following exact solution expressions [81]. Similar expressions can also be found in older texts [82], [83].

$$H_{\phi} = j \frac{I_0}{4\pi\rho} \left(e^{-jkR1} + e^{-jkR2} - 2 \cos\left(\frac{kL}{2}\right) e^{-jkr} \right) \quad (7-4)$$

$$E_{\rho} = j \frac{\eta I_0}{4\pi\rho} \left(\left(z - \frac{L}{2} \right) \frac{e^{-jkR1}}{R1} + \left(z + \frac{L}{2} \right) \frac{e^{-jkR2}}{R2} - 2z \cos\left(\frac{kL}{2}\right) \frac{e^{-jkr}}{r} \right) \quad (7-5)$$

$$E_z = -j \frac{\eta I_0}{4\pi} \left(\frac{e^{-jkR1}}{R1} + \frac{e^{-jkR2}}{R2} - 2 \cos\left(\frac{kL}{2}\right) \frac{e^{-jkr}}{r} \right) \quad (7-6)$$

where ρ is the radial part of cylindrical coordinates (ρ, ϕ, z) , and η is the intrinsic impedance of free-space.

$R1$, $R2$ and r are given by:

$$R1 = \left(x^2 + y^2 + \left(z - \frac{L}{2} \right)^2 \right)^{\frac{1}{2}} \quad (7-7)$$

$$R2 = \left(x^2 + y^2 + \left(z + \frac{L}{2} \right)^2 \right)^{\frac{1}{2}} \quad (7-8)$$

$$r = \left(x^2 + y^2 + z^2 \right)^{\frac{1}{2}} \quad (7-9)$$

The radial component of the electric field E_{ρ} dies out quickly away from the antenna. The electric field along the z axis, E_z is the field that will be used in the modelling.

7.2.2 Field Computation Far Away from the PLT

The electric field E_z far away from the PLT can be determined by applying the far-field approximations to equation (7-6), as follows:

For amplitude: $R1 \approx R2 \approx r$; for phase: $R1 = r - (L/2)\cos\theta$ and $R2 = r + (L/2)\cos\theta$. Then we obtain:

$$E_z = -j \frac{\eta I_0 e^{-jkr}}{2\pi r} \left(\cos\left(\frac{kL}{2} \cos\theta\right) - \cos\left(\frac{kL}{2}\right) \right) \quad (7-10)$$

Further, applying the cylindrical-spherical relationship $z = r \cos \theta$, we obtain,

$$E_z = -j \frac{\eta I_0 e^{-jk r}}{2\pi r} \left(\cos \left(\frac{kLz}{2r} \right) - \cos \left(\frac{kL}{2} \right) \right) \quad (7-11)$$

Alternately, one can apply the spherical-to-cylindrical coordinate transformation to the dipole electric field far-field expressions available in any textbook on antennas, namely:

$$E_z = E_r \cos \theta - E_\theta \sin \theta \quad (7-12)$$

E_r is approximately zero in the far-field, while in spherical coordinates E_θ in the far-field is given by:

$$E_\theta = j \frac{\eta I_0 e^{-jk r}}{2\pi r} \left(\frac{\cos \left(\frac{kL}{2} \cos \theta \right) - \cos \left(\frac{kL}{2} \right)}{\sin \theta} \right) \quad (7-13)$$

Therefore, multiplication of (7-13) by $-\sin \theta$ will yield (7-10).

7.2.3 Half-Wavelength Dipole Model

The electric field general exact solution and the far-field approximation solution expressions in cylindrical coordinates are given by (7-6) and (7-11) respectively. For the half-wavelength dipole model, equivalent expressions can be obtained readily by substituting $\lambda/2$ for L . Thus, $\frac{kL}{2} = \frac{1}{2} * \frac{2\pi}{\lambda} * \frac{\lambda}{2} = \frac{\pi}{2}$ and $\cos \left(\frac{kL}{2} \right) = \cos \left(\frac{\pi}{2} \right) = 0$.

Therefore, we obtain,

$$E_z = -j \frac{\eta I_0}{4\pi} \left(\frac{e^{-jkR1}}{R1} + \frac{e^{-jkR2}}{R2} \right) \quad (7-14)$$

for the exact solution case, and

$$E_z = -j \frac{\eta I_0 e^{-jk r}}{2\pi r} \cos \left(\frac{\pi z}{2r} \right) \quad (7-15)$$

for the far-field approximation case.

7.2.4 One-Wavelength Dipole Model

Similarly, for the one-wavelength dipole model, equivalent expressions can be obtained readily by substituting λ for L in (7-6) and (7-11). Thus, $\frac{kL}{2} = \frac{1}{2} * \frac{2\pi}{\lambda} * \lambda = \pi$ and $\cos\left(\frac{kL}{2}\right) = \cos(\pi) = -1$.

$$E_z = -j \frac{\eta I_0}{4\pi} \left(\frac{e^{-jkR1}}{R1} + \frac{e^{-jkR2}}{R2} + 2 \frac{e^{-jkr}}{r} \right) \quad (7-16)$$

for the exact solution case, and

$$E_z = -j \frac{\eta I_0 e^{-jkr}}{2\pi r} \left(\cos\left(\frac{\pi z}{r}\right) + 1 \right) \quad (7-17)$$

for the far-field approximation case.

7.2.5 Small Dipole Model

While modelling PLTs with small dipoles is not recommended, in the interest of completeness, exact expressions for small dipoles are provided in this section. The criterion defining small dipoles is $\frac{\lambda}{50} \leq L \leq \frac{\lambda}{10}$.

In spherical coordinates, the exact solutions for the electric and magnetic fields are given by:

$$H_\phi = \frac{I_0 L \sin\theta}{8\pi r} \left(jk + \frac{1}{r} \right) e^{-jkr} \quad (7-18)$$

$$E_r = -j \frac{2I_0 \eta L \cos\theta}{8\pi k r^2} \left(jk + \frac{1}{r} \right) e^{-jkr} \quad (7-19)$$

$$E_\theta = j \frac{I_0 \eta L \sin\theta}{8\pi k r} \left(k^2 - j \frac{k}{r} - \frac{1}{r^2} \right) e^{-jkr} \quad (7-20)$$

Because the cylindrical coordinates are more suitable to the PLT geometry, the exact electric field component E_z , valid at any distance, can be obtained by means of spherical-to-cylindrical coordinate transformation using (7-12), and the spherical-cylindrical relationships $\rho = r \sin\theta$ and $z = r \cos\theta$.

$$E_z = -j \frac{I_0 \eta L}{8\pi r^3} \left(k\rho^2 + \left(\frac{2z^2 - \rho^2}{r} \right) \left(j + \frac{1}{kr} \right) \right) e^{-jkr} \quad (7-21)$$

For the far-field approximation case, this simplifies to:

$$E_z = -j \frac{I_0 \eta L k \rho^2}{8 \pi r^3} e^{-jkr} \quad (7-22)$$

7.2.6 The Two-Ray Method

In the vicinity of the PLT, the proper determination of the conversion factor with distance requires that the reflected field from the ground be also taken into consideration. Therefore, the best method for such an assessment is the two-ray method illustrated in Figure 7.2.6-1. The proper application of the method in conjunction with E_z is illustrated in Figure 7.2.6-2.

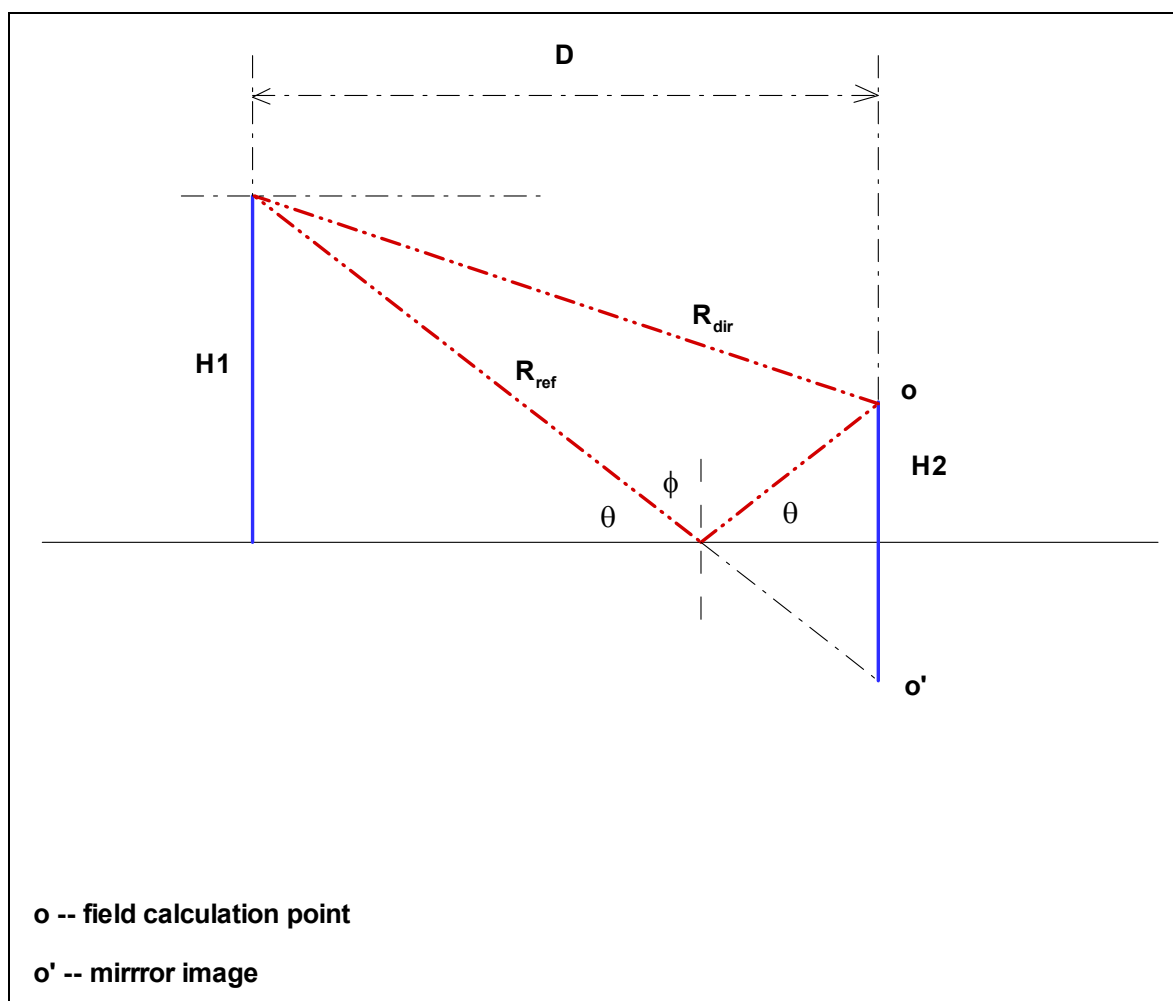

Figure 7.2.6-1: The Two-Ray Field Calculation Geometry.

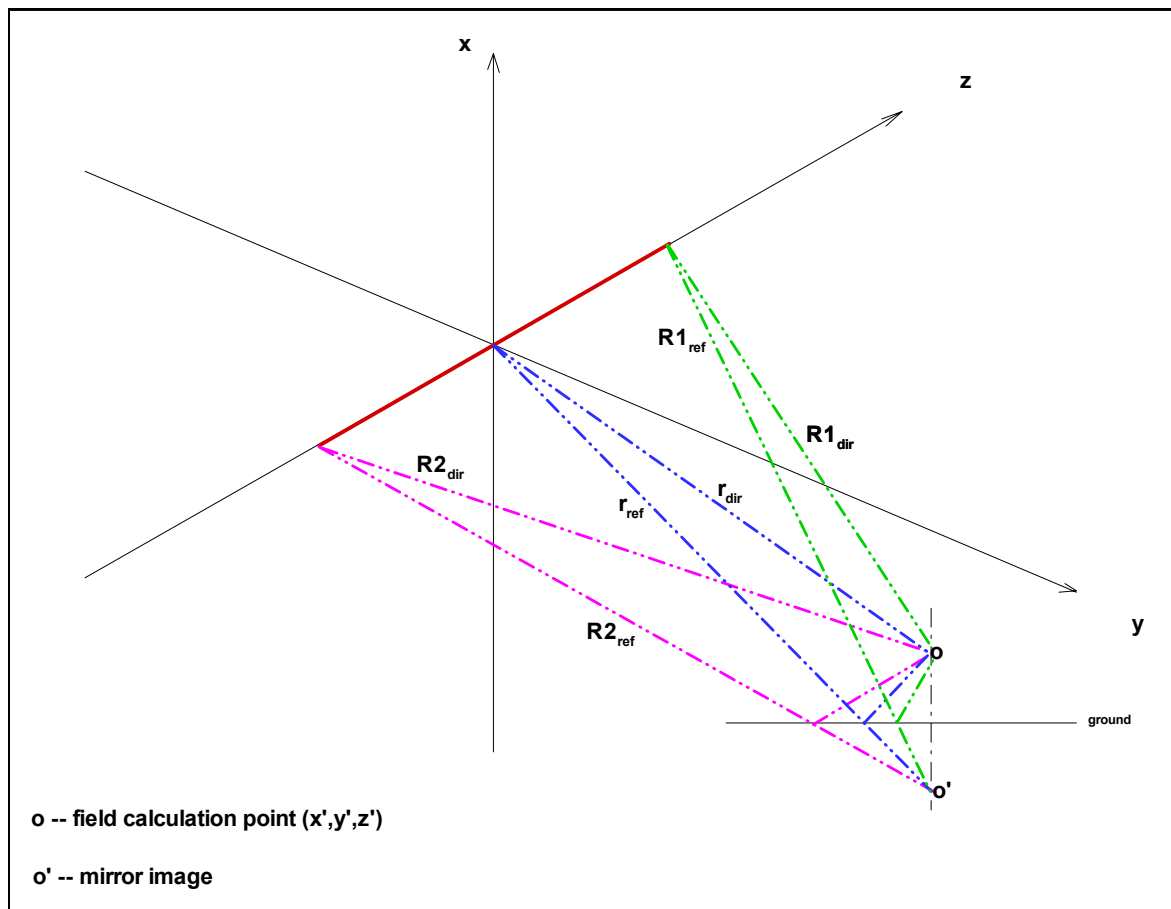

Figure 7.2.6-2: The Two-Ray Field Calculation Geometry near Dipole for Modelling PLT.

In any investigation involving the determination of electromagnetic field strength variation with respect to distance from the source, it is best to work with the geometry that yields the maximum field values. In this case, the maximum value of E_z occurs at $z = 0$ in cylindrical coordinates (in spherical coordinates, for E_θ this occurs at $\theta = 90$ degrees). In aperture antennas, which are highly directive, this is called the antenna boresight. For a dipole, the term is used loosely to indicate the maximum field strength direction. The height above ground is represented by the x-coordinate, while the horizontal distance away from the dipole (PLT) is represented by the y-coordinate.

When we choose the boresight case for maximum E_z , $z = 0$, and R1, R2 and r expressions of Section 7.2.1 reduce to:

$$r = \left(x^2 + y^2 \right)^{\frac{1}{2}} \quad (7-23)$$

$$R1 = R2 = \left(x^2 + y^2 + \frac{L^2}{4} \right)^{\frac{1}{2}} = \left(r^2 + \frac{L^2}{4} \right)^{\frac{1}{2}} \quad (7-24)$$

From the simple geometry of Figure 7.2.6-1, where the dipole is placed at height H1 and pointing into the page, we have:

$$R_{\text{dir}} = \left(D^2 + (H1 - H2)^2 \right)^{\frac{1}{2}} \quad (7-25)$$

$$R_{\text{ref}} = \left(D^2 + (H1 + H2)^2 \right)^{\frac{1}{2}} \quad (7-26)$$

$$\sin \phi = \frac{D}{R_{\text{ref}}} \quad (7-27)$$

$$\cos \phi = \frac{H1 + H2}{R_{\text{ref}}} \quad (7-28)$$

In adapting the expressions (7-23) through (7-28) to the geometry of the dipole-modelled PLT shown in Figure 7.2.6-2, we can either place the origin point (0,0,0) on the dipole above ground, or we can place the origin point on the ground. For ease of arithmetic and typography, the latter option is preferable.

The dipole-modelled PLT is located at $x = H1$, the field calculation point is located at $x = H2$, and the horizontal distance from the PLT is located at $y = D$. Then we have,

$$r_{\text{dir}} = \left((H1 - H2)^2 + D^2 \right)^{\frac{1}{2}} \quad (7-29)$$

$$r_{\text{ref}} = \left((H1 + H2)^2 + D^2 \right)^{\frac{1}{2}} \quad (7-30)$$

$$R1_{\text{dir}} = R2_{\text{dir}} = \left((H1 - H2)^2 + D^2 + \frac{L^2}{4} \right)^{\frac{1}{2}} = \left(r_{\text{dir}}^2 + \frac{L^2}{4} \right)^{\frac{1}{2}} \quad (7-31)$$

$$R1_{\text{ref}} = R2_{\text{ref}} = \left((H1 + H2)^2 + D^2 + \frac{L^2}{4} \right)^{\frac{1}{2}} = \left(r_{\text{ref}}^2 + \frac{L^2}{4} \right)^{\frac{1}{2}} \quad (7-32)$$

The total field at the point of calculation is the sum of direct field plus the product of the reflected field with the proper reflection coefficient. Referring to Figure 7.2.6-1, as E_z is perpendicular to the plane of incidence, i.e., the page, or in other words, parallel to the surface of incidence, i.e., the ground, the proper reflection coefficient is the horizontal reflection coefficient. In an air/ground medium, this is given by:

$$\Gamma_H = \frac{\left(\frac{j\omega\mu_0}{\sigma + j\omega\epsilon_0\epsilon_r}\right)^{\frac{1}{2}} \cos\phi - \left(\left(\frac{\mu_0}{\epsilon_0}\right)\left(1 + \frac{\omega^2\mu_0\epsilon_0 \sin^2\phi}{j\omega\mu_0(\sigma + j\omega\epsilon_0\epsilon_r)}\right)\right)^{\frac{1}{2}}}{\left(\frac{j\omega\mu_0}{\sigma + j\omega\epsilon_0\epsilon_r}\right)^{\frac{1}{2}} \cos\phi + \left(\left(\frac{\mu_0}{\epsilon_0}\right)\left(1 + \frac{\omega^2\mu_0\epsilon_0 \sin^2\phi}{j\omega\mu_0(\sigma + j\omega\epsilon_0\epsilon_r)}\right)\right)^{\frac{1}{2}}} \quad (7-33)$$

This can be simplified to:

$$\Gamma_H = \frac{\cos\phi - \left(\left(\epsilon_r - \sin^2\phi\right) - j\frac{\sigma}{\omega\epsilon_0}\right)^{\frac{1}{2}}}{\cos\phi + \left(\left(\epsilon_r - \sin^2\phi\right) - j\frac{\sigma}{\omega\epsilon_0}\right)^{\frac{1}{2}}} \quad (7-34)$$

Finally, by the substitution of (7-27) and (7-28) we have:

$$\Gamma_H = \frac{\left(\frac{H1 + H2}{r_{ref}}\right) - \left(\left(\epsilon_r - \left(\frac{D}{r_{ref}}\right)^2\right) - j\frac{\sigma}{\omega\epsilon_0}\right)^{\frac{1}{2}}}{\left(\frac{H1 + H2}{r_{ref}}\right) + \left(\left(\epsilon_r - \left(\frac{D}{r_{ref}}\right)^2\right) - j\frac{\sigma}{\omega\epsilon_0}\right)^{\frac{1}{2}}} \quad (7-35)$$

The proper values of ϵ_r and σ for a particular location of assessment can be obtained from [28] and [80].

The total field at any point is:

$$E_z^{total} = E_z^{dir} + \Gamma_H E_z^{ref} \quad (7-36)$$

where the appropriate expressions (7-29) to (7-32) are used in equation (7-6). Also,

$$\left|E_z^{total}\right| = \left(E_z^{total} \times (E_z^{total})^*\right)^{\frac{1}{2}} \quad (7-37)$$

It should be noted that the two-ray method is only useful within a short distance, perhaps up to 200 metres, given typical PLT line heights (10 – 15 m), and frequencies in the HF range. There are two reasons for this: one theoretical, the other practical. In the first case, ignoring the ground irregularities, at large

distances the grazing angle θ in Figure 7.2.6-1 will become very small, causing the value of the horizontal reflection coefficient to approach -1 , and the direct and reflected path lengths to become comparable; all of these effects will cause the total field E_z to approach zero. In the second case, due to many obstacles in and around the wires, the field will not maintain its original polarization indefinitely. Therefore, beyond 200 metres, and also for cases involving skyward propagation of E field, it is advisable to compute the total field E_z by applying a single-ray approach, using equation (7-11). Again, the magnitude of the total field can be computed as before by means of equation (7-37).

7.2.7 Rationale and Justification for Using Exact Dipole Solution Expressions in the Vicinity of the Overhead PLT Line

As stated before, in the vicinity of the PLT and including the near-field, proper modelling is very important. This can only be implemented by using the exact solution expressions when the PLT is modelled by dipoles, because these expressions yield correct results for cases involving the near-field. A comparison of the respective results obtained by the exact solution and the far-field approximation expressions in the vicinity of a PLT will be illustrative.

Again, the boresight case is applied ($z = 0$) which yields the maximum E_z values. The line current I_0 is 1 ampere. Both half-wavelength (half-wave or $\lambda/2$) and one-wavelength (full-wave or λ) dipoles are modelled.

When $z = 0$, $R_1 = R_2 = R$ and is given by (7-24), and r is the radial distance from the centre of the dipole, in the boresight direction, and is given by (7-23). L is the dipole length.

7.2.7.1 Half-Wave Dipole Results

For the above set-up, the exact solution given by (7-14) is simplified further to:

$$E_z = -j \frac{2\eta I_0}{4\pi} \left(\frac{e^{-jkR}}{R} \right) = -j60 \frac{e^{-jkR}}{R} \quad (7-38)$$

The far-field approximation solution is given by (7-15), and simplified further to:

$$E_z = -j \frac{\eta I_0 e^{-jkr}}{2\pi r} \cos\left(\frac{\pi z}{2r}\right) = -j60 \frac{e^{-jkr}}{r} \quad (7-39)$$

Examining these two similar expressions, it can be seen readily that the far-field approximation solution does not have frequency dependence, while the exact solution does, because R is a function of L , itself a function of frequency. Figure 7.2.7.1-1 below illustrates the comparison.

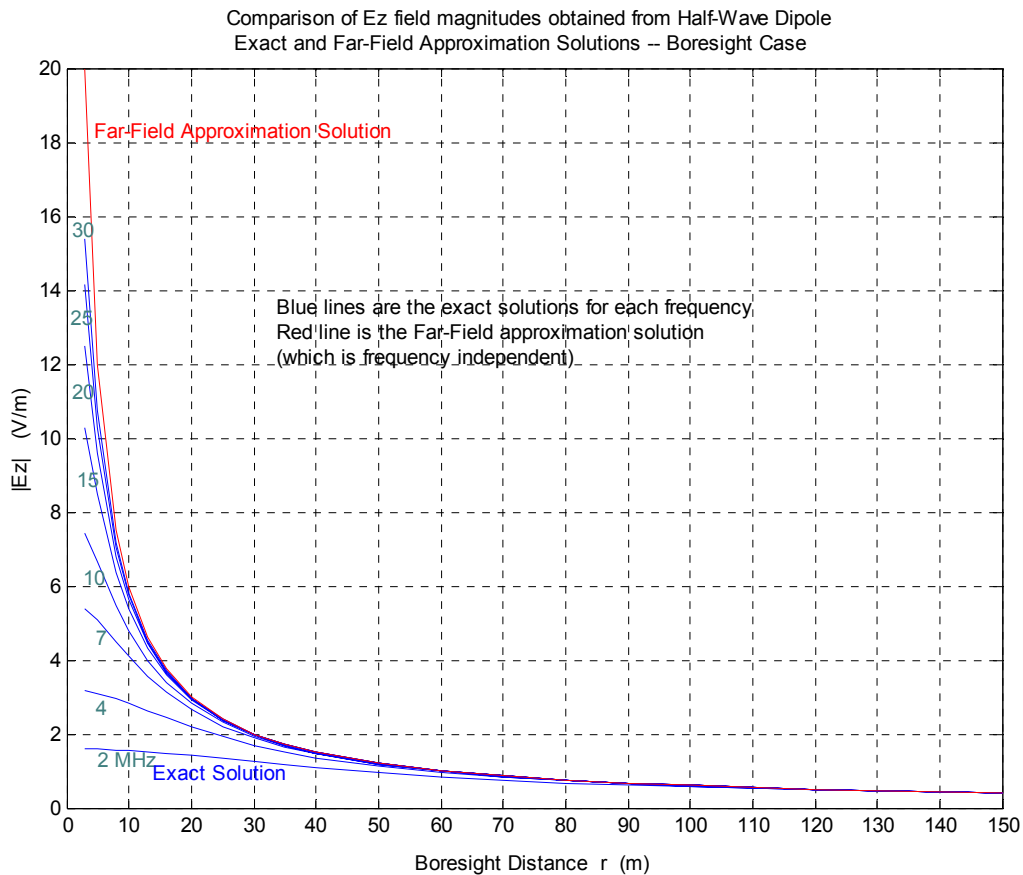

Figure 7.2.7.1-1: Comparison of E_z Magnitudes – Half-Wave Dipole.

7.2.7.2 Full-Wave Dipole Results

For the above set-up, the exact solution given by (7-16) is simplified further to:

$$E_z = -j \frac{2\eta I_0}{4\pi} \left(\frac{e^{-jkR}}{R} + \frac{e^{-jkr}}{r} \right) = -j60 \left(\frac{e^{-jkR}}{R} + \frac{e^{-jkr}}{r} \right) \quad (7-40)$$

The far-field approximation solution is given by (7-17), and simplified further to:

$$E_z = -j \frac{2\eta I_0 e^{-jkr}}{2\pi r} = -j120 \frac{e^{-jkr}}{r} \quad (7-41)$$

The observation in 7.2.7.1 about the respective frequency dependence of the solutions is equally true similarly, for the observation. Figure 7.2.7.2-1 below illustrates the comparison.

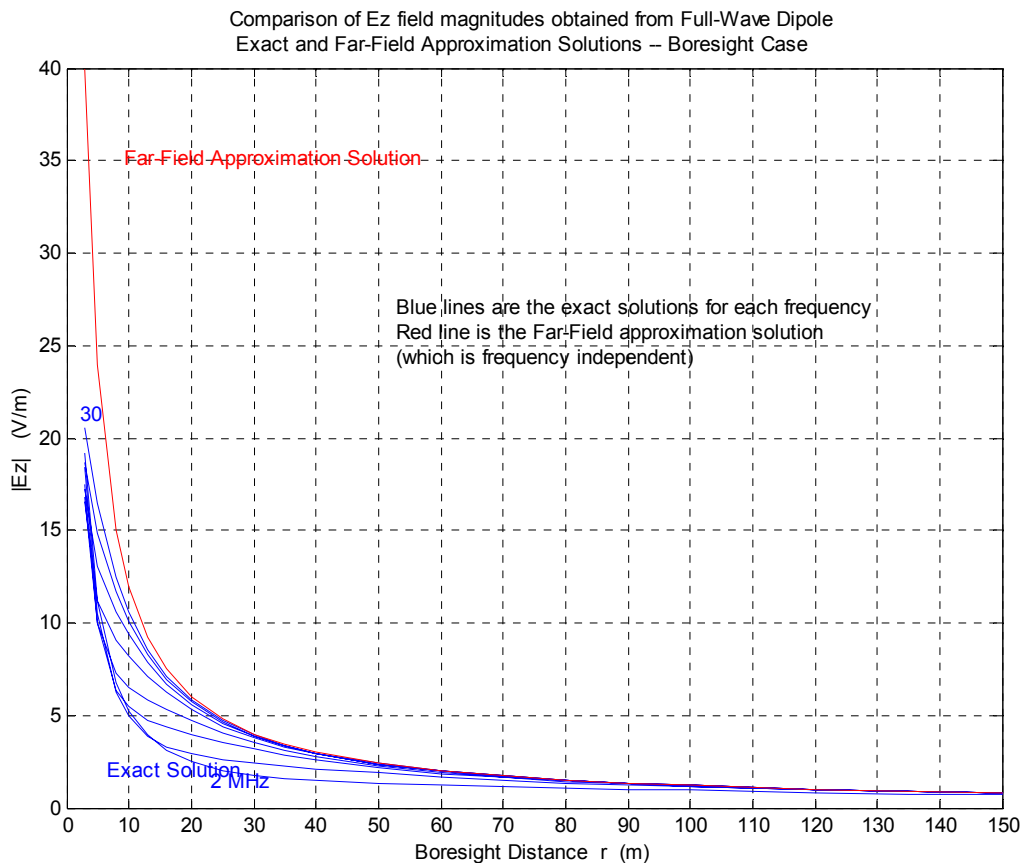

Figure 7.2.7.2-1: Comparison of E_z Magnitudes – Full-Wave Dipole.

7.2.7.3 Comments on Results

Observation: The expressions for E_z are basically Green’s Function multiplied by a constant!

It can be seen that near the antenna, the results obtained with the far-field approximation expression will be in error by a considerable margin. Naturally, some distance away from the antenna, the two expressions yield similar results. Also, the frequency dependence disappears because with increasing r , both R and r become comparable in length.

In the HF range, at some distance away from the antenna, the far-field approximation solution is very suitable. On the other hand, near the antenna, the exact expression should always be used for accurate results.

7.3 RECOMMENDED EIRP ESTIMATION METHODS

In the computation of cumulative effects of PLT transmissions, the Task Group recommends that these be computed always using a source defined in terms of EIRP rather than in terms of electric field strength. The cumulative effects assessment described in Chapter 8 use EIRP values.

If the EIRP of the PLT is not known, then the electric field strength could be obtained by means of expressions (7-6) or (7-11) in general, or by means of expressions (7-14) and (7-15) respectively, if a half-wave dipole is selected as a model for the PLT. Then the EIRP could readily be obtained from the following conventional expression:

$$\text{EIRP} = \frac{(E(r) * r)^2}{30} \quad (7-42)$$

where E(r) is in V/m, r is in metres, 30 is in ohms, and EIRP is in Watts.

If the source is defined in terms of injected PSD, the EIRP per unit bandwidth is the product of the injected PSD and antenna gain. The Task Group recommends using an antenna gain of –30 dBi for In-House systems, –15 dBi for overhead Access systems, and –50 dBi for underground Access systems.

The use of the EIRP determination formula provided in Annex 4 of [3],

$$\text{EIRP} = \frac{r^4}{r^2 + \left(\frac{\lambda}{2\pi}\right)^2} \frac{[E(r)]^2}{30} = \frac{r^2}{1 + \left(\frac{\left(\frac{\lambda}{2\pi}\right)^2}{r^2}\right)} \frac{[E(r)]^2}{30} \quad \left(r \geq \frac{\lambda}{2\pi}\right) \quad (7-43)$$

where E(r) is in V/m, r and λ are in metres, 30 is in ohms, and EIRP is in Watts, is not recommended for Access PLT systems, due to the following reasons:

- a) In Annex 4, one critical piece of information is left out. $\frac{\lambda}{2\pi}$ is the far-field boundary (the end of near-field) for electrically-small antennas (i.e., largest dimension < wavelength) such as dipoles. Because (7-43) is a far-field expression, there should have been a qualifier next to it in Annex 4, such as $(r \geq \frac{\lambda}{2\pi})$, as shown above.
- b) It can be seen that, when $r \gg \frac{\lambda}{2\pi}$, the results obtained by (7-42) and (7-43) will be very similar. However, when r and $\frac{\lambda}{2\pi}$ are comparable, the results from (7-43) will be in error, from 50% (when $r = \frac{\lambda}{2\pi}$) to some small %. Even when r is at several times the boundary distance, there will be significant error.

7.4 DISTANCE CONVERSION FACTOR NEAR PLT

In this section, measured and modelled distance conversion factors are presented.

The measurement data are from various sources, while the modelling results are obtained from half-wave and full-wave dipole models.

7.4.1 Documented Measurements and Regulatory Conversion Factors

The following conversion factors are from various sources:

a) Ofcom – Ascom PLT Measurements in Winchester [39]:

4.4 MHz:	1 to 3 metres	20 dB/decade
	1 to 10 metres	25 dB/decade
	1 to 30 metres	25 dB/decade
19.8 MHz:	1 to 3/10/30/100 m	20 dB/decade
25.2 MHz:	1 to 3/10/30/100 m	23 dB/decade
Section 6:	< 30 MHz	1 to 100 m 20 dB/decade

b) Ofcom – Amperion PLT Measurements in Crieff [40]:

20 – 23.5 MHz: Magnetic Field Emission	1 to 30 m	28 dB/decade
	1 to 100 m	28 dB/decade
	1 to 300 m	27 dB/decade
Electric Field Emission	1 to 30 m	16 dB/decade
	1 to 100 m	21 dB/decade
	1 to 300 m	17 dB/decade
Section 6: < 30 MHz	Magn. Field Em.	1 to 300 m 27 dB/decade
	Electr. Field Em.	1 to 300 m 10 – 21 dB/decade

Values below 20 dB/decade due to reflections.

c) VERON EMC Committee [79]:

Outside field strength measurements in the NL at 10 m and 20 m from the house wall were related to averaged In-House measurements at 3 m distance to power lines according to NB 30 rules. The mean variations of field strength with distance for different frequencies were ([79] – Table 8, Figures 7 and 8) between 37.5 dB/decade at 1.84 MHz and 12.0 dB/decade at 28.4 MHz. Further, in General Conclusions, it is stated “These wide spectrum signals have a roll-off of 20 dB/decade...”.

d) The University of Karlsruhe made field strength measurements at different distances from 3 m to 110 m to PLT In-House systems [7],[87]. The mean variations of field strength with distance for frequencies below 6 MHz were 25 – 30 dB/decade, and for frequencies higher than 6 MHz 20 dB/decade of distance.

e) The German “Specification for the Measurement of Disturbance Fields...” [12] recommends 3 m as standard distance for NB 30 limits (magnetic field strength measurement). For smaller distances down to 1 m the conversion factor is 20 dB/decade. For greater distances than 3 m the conversion factor should be estimated by measuring at two or more (if necessary) distances, and linear interpolation in a logarithmic plot of field strength over distance.

f) FCC in the United States specifies 40 dB/decade for slant ranges up to 30 metres, below 30 MHz [31],[90]. It should be noted that this conversion factor has been questioned by several authors, e.g., [98],[99].

7.4.2 Results from Modelling Calculations

To determine the distance conversion factor theoretically, the exact solution expression for E_z is used, as the far-field approximation expression will not be suitable in the vicinity of the PLT line. The PLT line is

horizontal. The two-ray technique described in Section 7.2.6 is utilized. The boresight case is applied ($z = 0$) which yields the maximum E_z values. The line current I_0 is 1 ampere. Both half-wavelength (half-wave or $\lambda/2$) and one-wavelength (full-wave or λ) dipoles are modelled.

When $z = 0$, $R1 = R2 = R$ and is given by (7-24), and r is the radial distance from the centre of the dipole, in the boresight direction, and is given by (7-23). L is the dipole length.

PLT line was placed at two heights, $H1$ at 10 and 15 metres above ground. These heights represent the typical PLT line height range above ground. The observation point $H2$ was placed at 1 metre above ground. The horizontal distance from PLT line, D , varied from 1 to 300 metres, in 1 metre increments. The direct and reflected path expressions for r , $R1$ and $R2$ are given by (7-29) through (7-31). **Note:** r_{dir} , (7-29), is the so-called slant range in the FCC documents. The horizontal reflection coefficient Γ_H is given by (7-35). Six frequencies were used: 2, 3, 5, 10, 20, 30 MHz, with $\epsilon_r = 15$, and $\sigma = 0.005$. The total E_z field magnitude was obtained by using (7-36) and (7-37). Finally, both half-wave and full-wave dipole models were utilized.

All of the results are plotted against r_{dir} , the slant range between the PLT line and observation point. Furthermore, for comparison purposes, the single-ray case is also shown, which is actually the magnitude of E_z obtained by the direct path.

7.4.2.1 Horizontal Reflection Coefficient Profile

The horizontal reflection coefficient Γ_H behaviour is independent of the dipole model used. Therefore, the following profiles apply equally to both half-wave and full-wave dipole models. Figures 7.4.2.1-1 and 7.4.2.1-2 show the horizontal reflection coefficient real and imaginary parts, for PLT line heights of 10 and 15 metres, respectively. As mentioned before in Section 7.2.6, the air/ground medium is the case here, and the results are obtained from Equation (7-35).

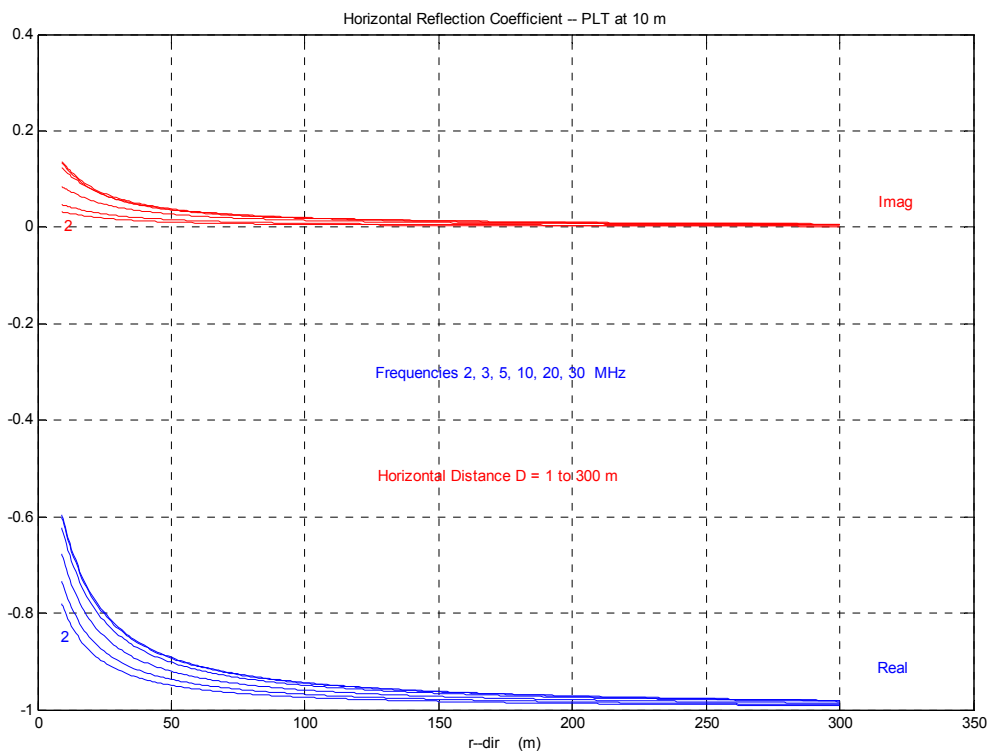

Figure 7.4.2.1-1: Horizontal Reflection Coefficient Profile – PLT Line Height at 10 Metres.

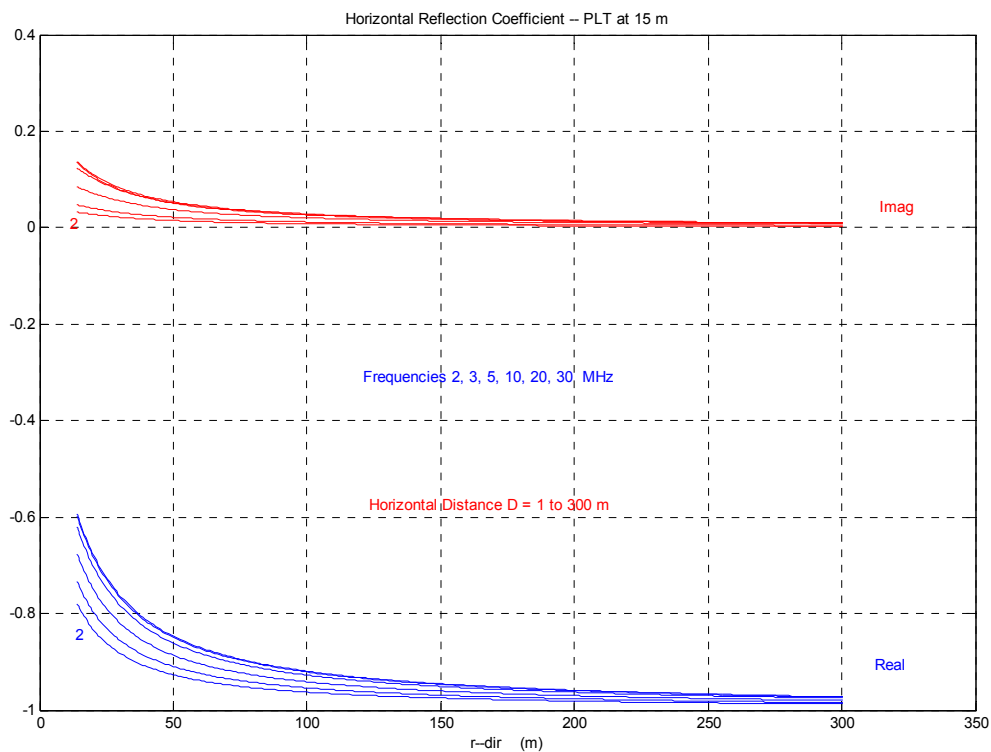

Figure 7.4.2.1-2: Horizontal Reflection Coefficient Profile – PLT Line Height at 15 Metres.

7.4.2.2 Half-Wave Dipole Results

The general exact expression used for E_z is given by (7-38). The results obtained are plotted in the following Figures. Figures 7.4.2.2-1 to 7.4.2.2-3 show the two-ray, single-ray and combined plots, respectively, when PLT line is at 10 metres above ground. Figures 7.4.2.2-4 to 7.4.2.2-6 show the two-ray, single-ray and combined plots, respectively, when PLT line is at 15 metres above ground.

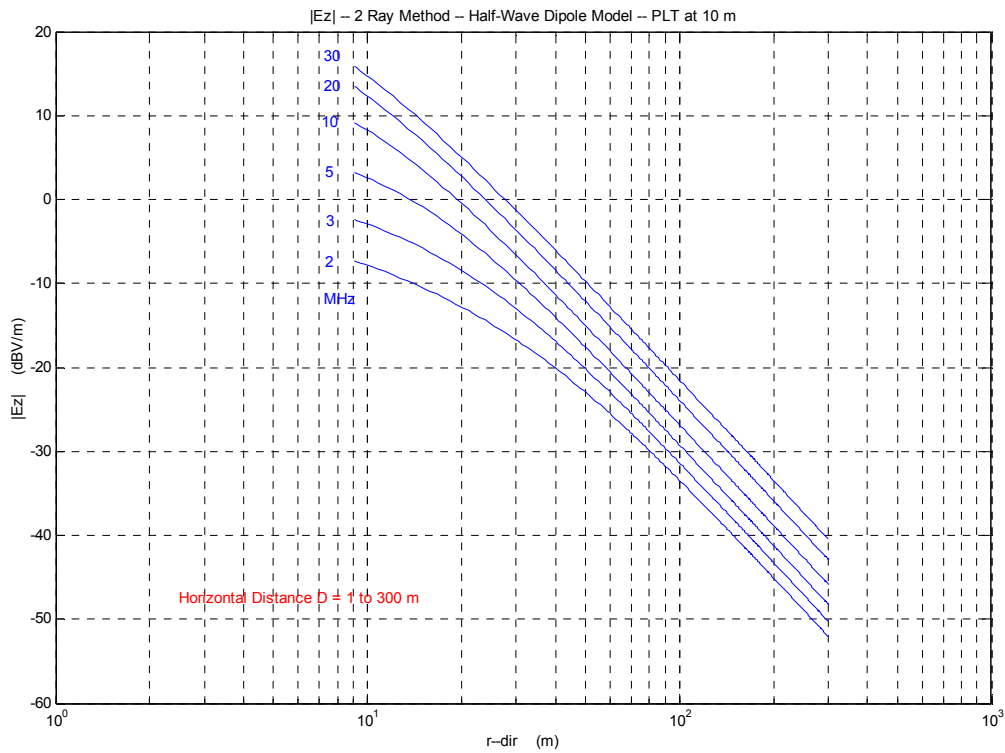

Figure 7.4.2.2-1: Two-Ray Results – PLT Line Height at 10 Metres – $L = \lambda/2$.

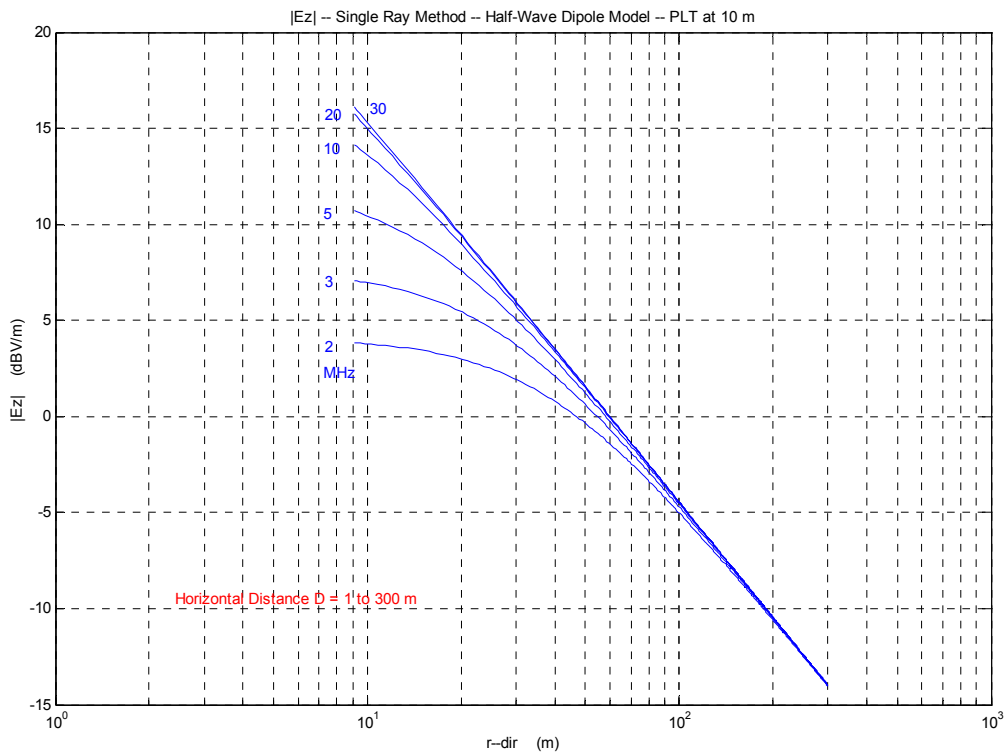

Figure 7.4.2.2-2: Single-Ray Results – PLT Line Height at 10 Metres – $L = \lambda/2$.

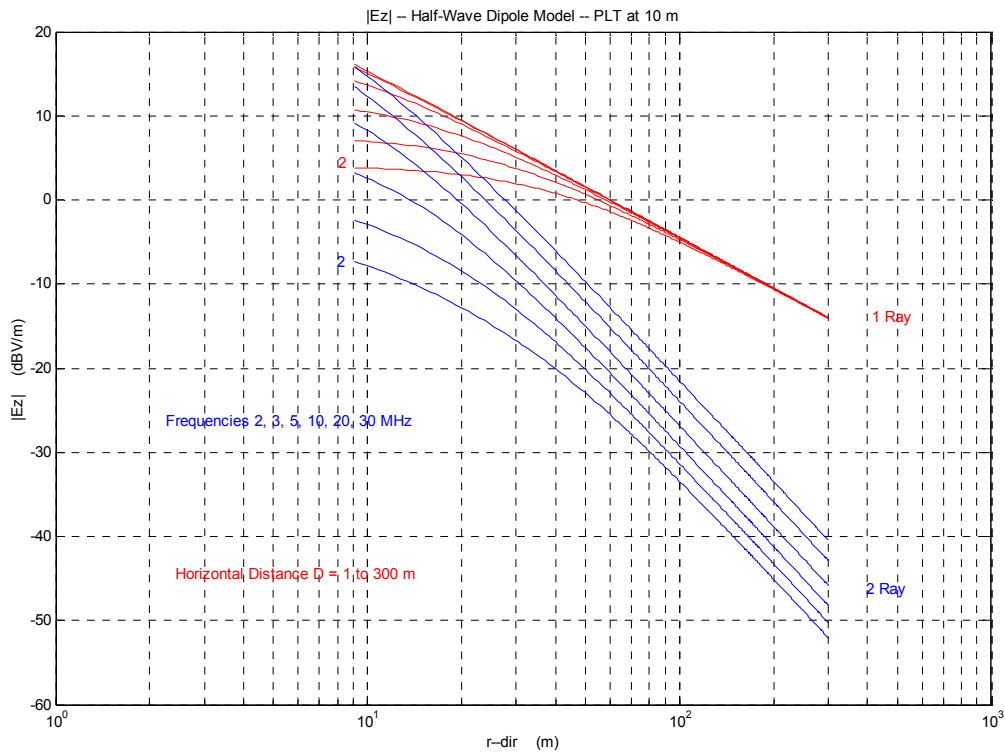

Figure 7.4.2.2-3: Combined Results – PLT Line Height at 10 Metres – $L = \lambda/2$.

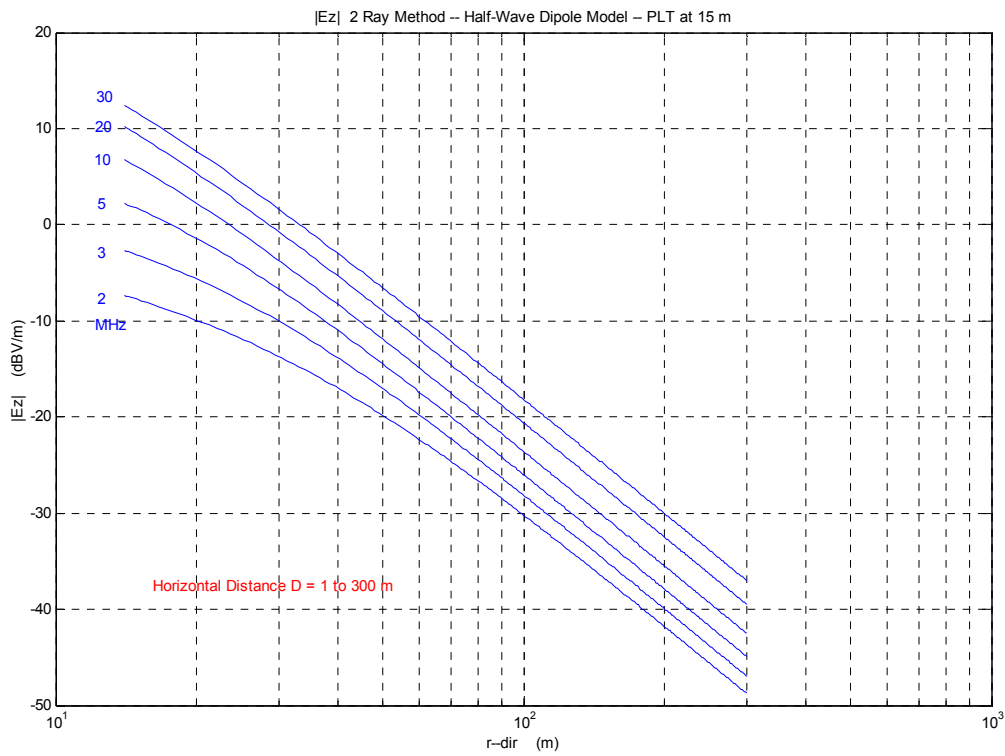

Figure 7.4.2.2-4: Two-Ray Results – PLT Line Height at 15 Metres – $L = \lambda/2$.

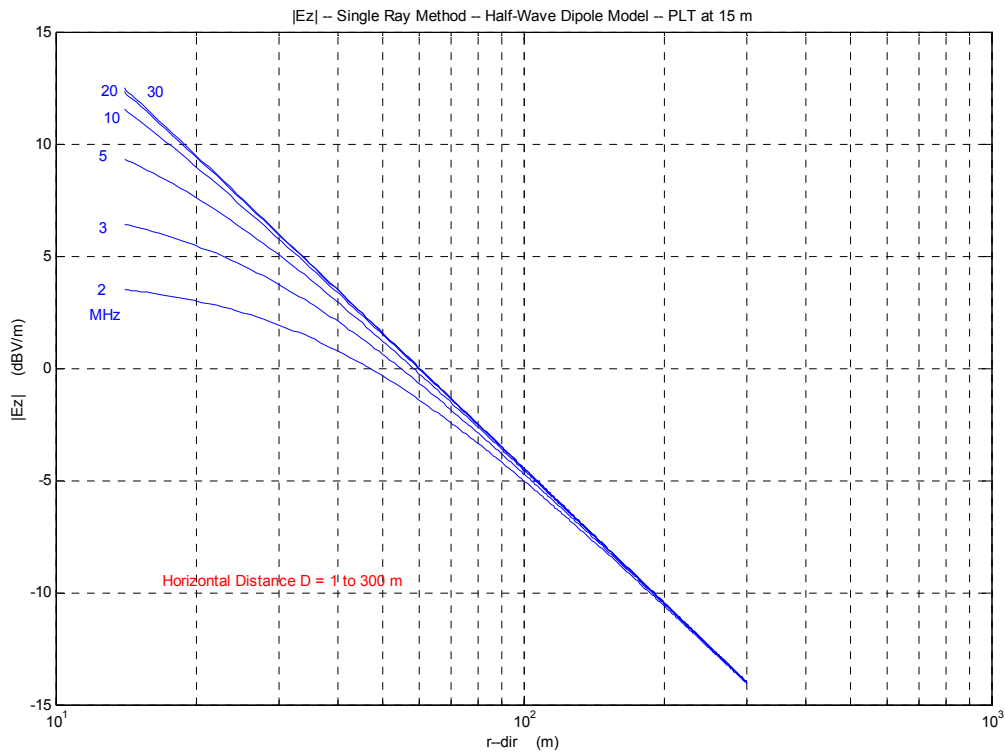

Figure 7.4.2.2-5: Single-Ray Results – PLT Line Height at 15 Metres – $L = \lambda/2$.

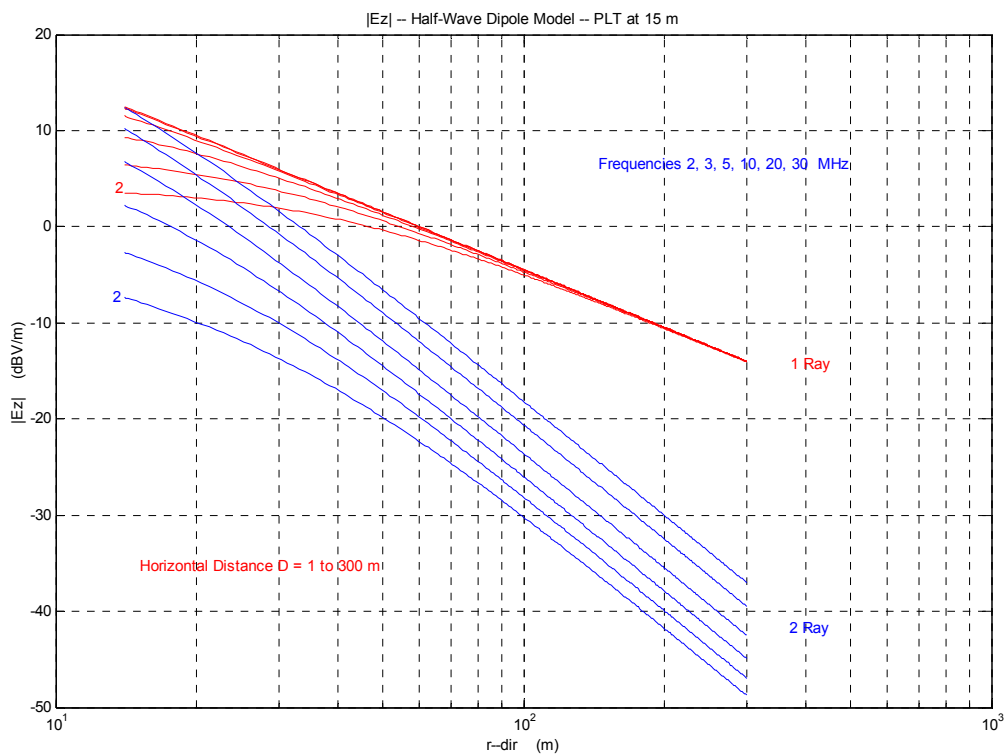

Figure 7.4.2.2-6: Combined Results – PLT Line Height at 15 Metres – $L = \lambda/2$.

7.4.2.3 Full-Wave Dipole Results

The general exact expression used for E_z is given by (7-40). The results obtained are plotted in the following Figures. Figures 7.4.2.3-1 to 7.4.2.3-3 show the two-ray, single-ray and combined plots, respectively, when PLT line is at 10 metres above ground. Figures 7.4.2.3-4 to 7.4.2.3-6 show the two-ray, single-ray and combined plots, respectively, when PLT line is at 15 metres above ground.

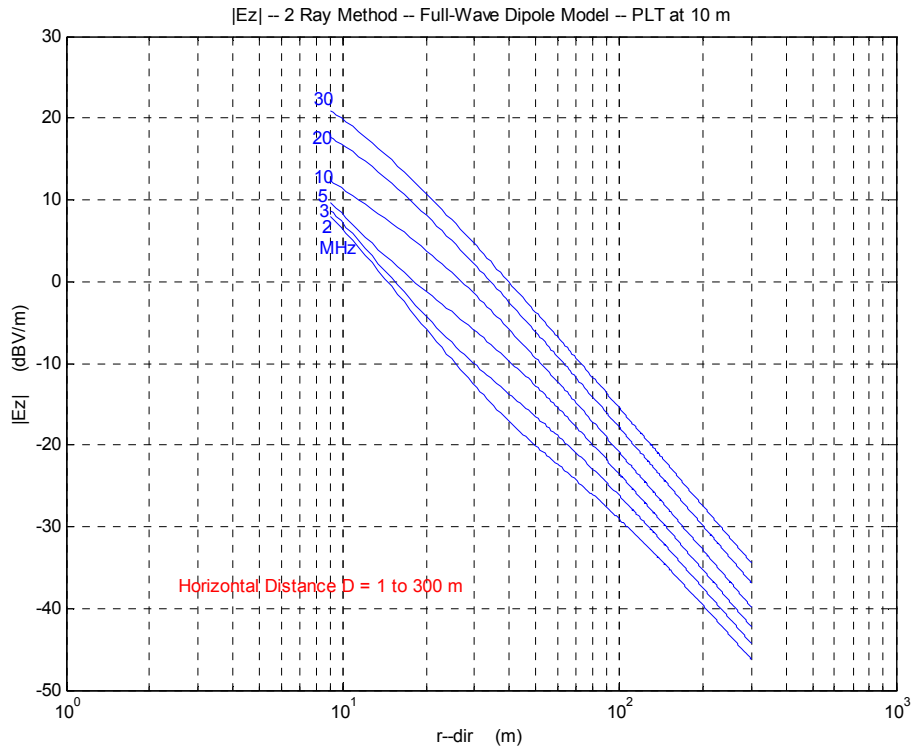

Figure 7.4.2.3-1: Two-Ray Results – PLT Line Height at 10 Metres – $L = \lambda$.

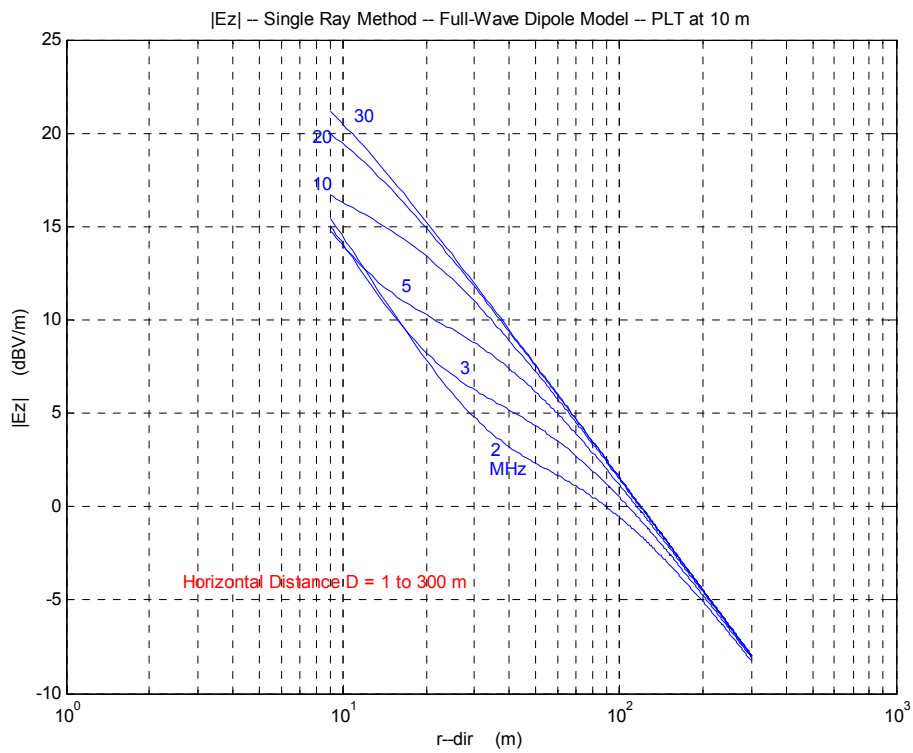

Figure 7.4.2.3-2: Single-Ray Results – PLT Line Height at 10 Metres – $L = \lambda$.

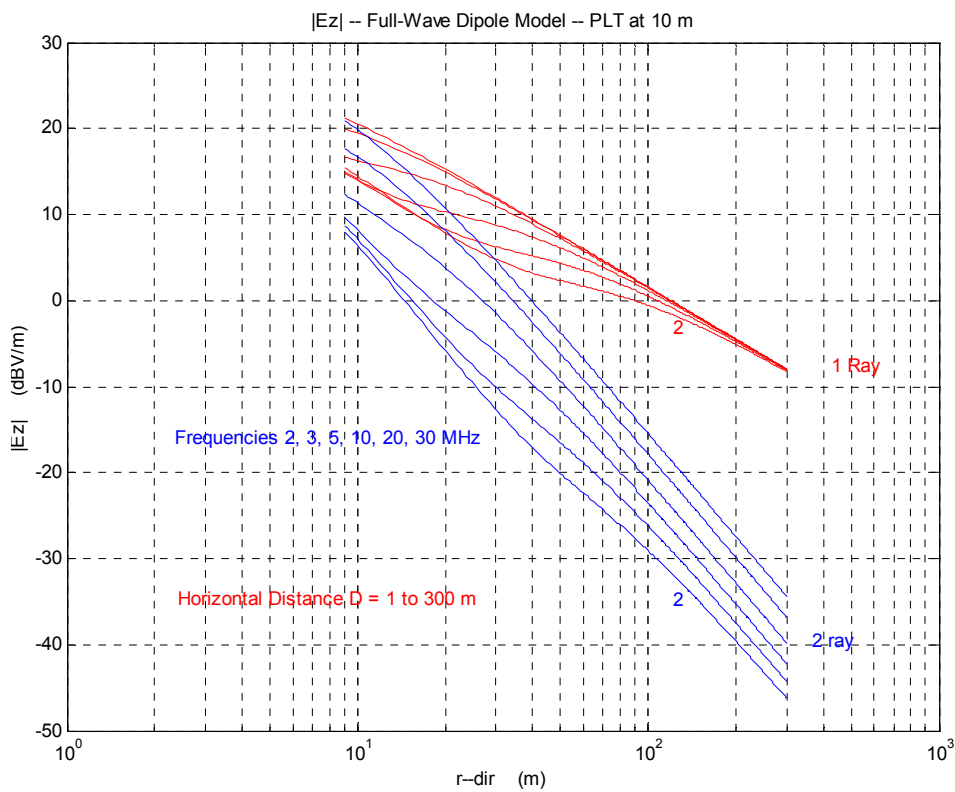

Figure 7.4.2.3-3: Combined Results – PLT Line Height at 10 Metres – $L = \lambda$.

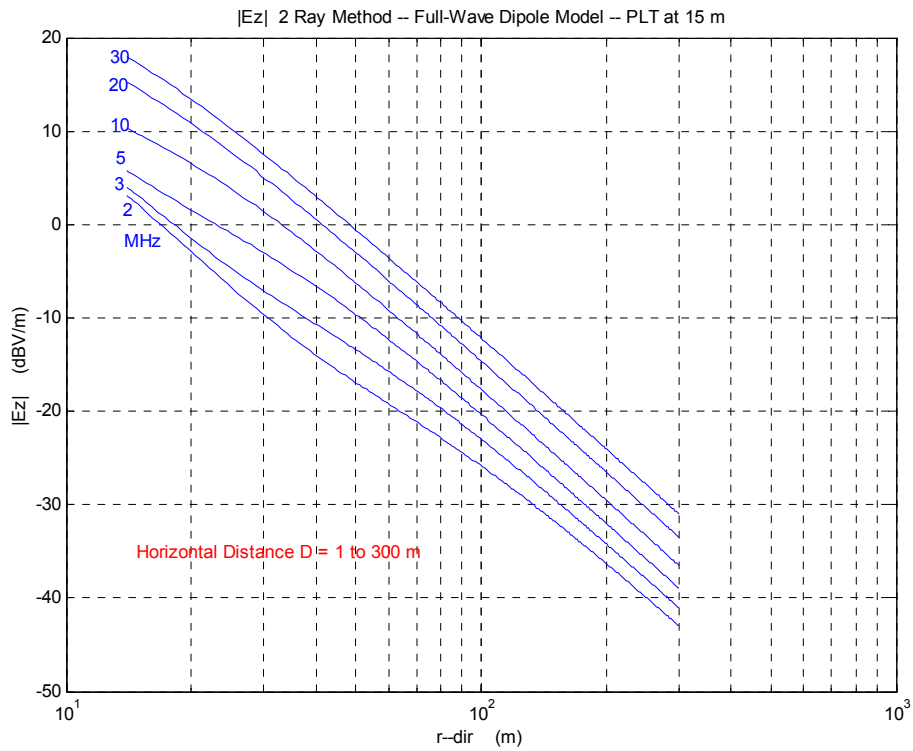

Figure 7.4.2.3-4: Two-Ray Results – PLT Line Height at 15 Metres – $L = \lambda$.

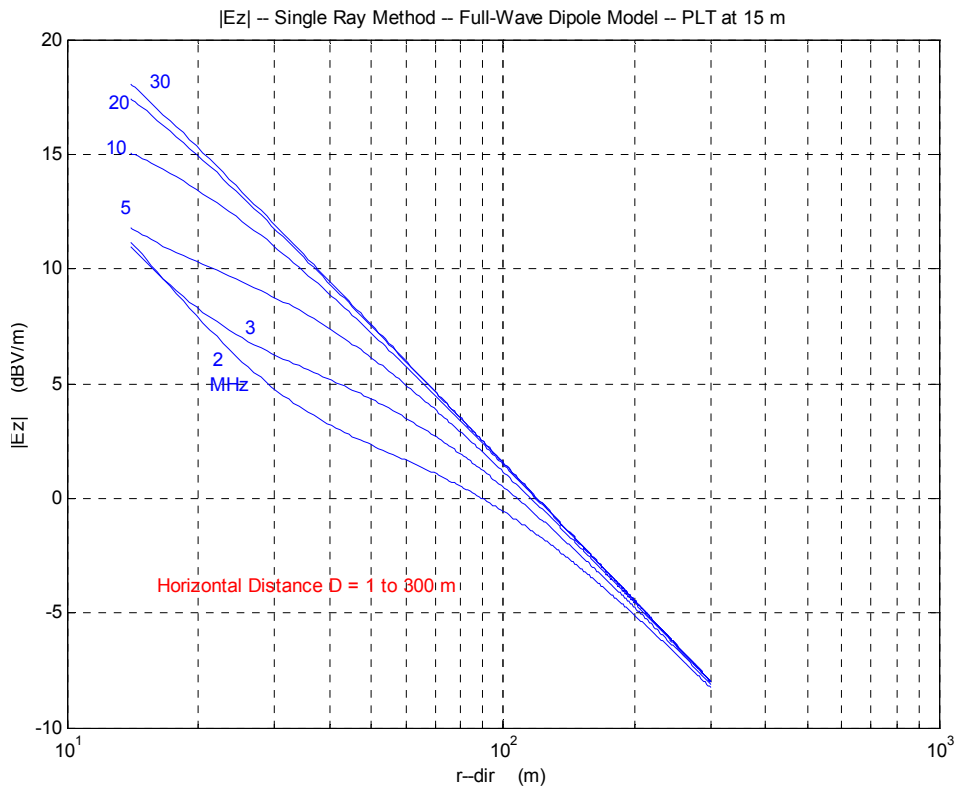

Figure 7.4.2.3-5: Single-Ray Results – PLT Line Height at 15 Metres – $L = \lambda$.

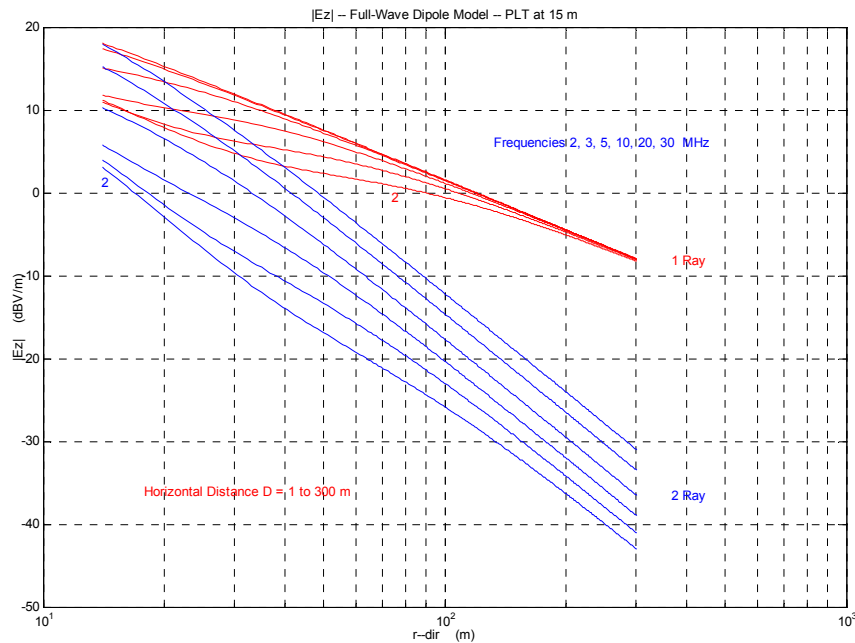

Figure 7.4.2.3-6: Combined Results – PLT Line Height at 15 Metres – $L = \lambda$.

7.4.2.4 Comments on Results

The following comments can be made about the above results:

- a) For the horizontal polarization case as we have with the PLT line, the total E_z field magnitude obtained with the two-ray method will always be smaller than for the single-ray approach, because of the effect of the reflection coefficient (negative real part predominates).
- b) The effects of geometry (D , $H1$, $H2$) and frequency on the reflection coefficient is the reason why there is a family of curves with the two-ray method, and, unlike the case for the single-ray, they do not converge within the calculation range utilized here.
- c) In the single-ray case, the results are practically indistinguishable, with the minor differences due to PLT line heights of 10 and 15 metres. At some distance away from the antenna, E_z varies inversely with r_{dir} (20 dB/decade), and as expected, the frequency dependence disappears. It is logical to take 200 metres as this limit, as indicated in Section 7.2.6, last paragraph.
- d) Obviously, near the antenna, the two-ray case will be in force. At some distance away, the single-ray case will be applicable. Therefore, the distance conversion factor will have to be a composite of the two cases.

7.4.3 Determination of Distance Conversion Factor

To obtain the distance conversion factor, we can use the following expression:

$$|E_z|(1) + X \cdot \log_{10}[r_{dir}(1)/r_{dir}(2)] = |E_z|(2) \text{ or}$$

$$X = \{|E_z|(2) - |E_z|(1)\} / \log_{10}[r_{dir}(1)/r_{dir}(2)] \quad (7-45)$$

where X is the distance conversion factor in dB/decade.

7.4.3.1 Half-Wave Model

From the MATLAB results for Figures 7.4.2.2-1 and 7.4.2.2-4, the following information is excised to help identify the distance conversion factor figures. The numbers under the frequencies are the values of $|E_z|$ in dBV/m. The * in the Tables indicates extrapolated numbers read off the Figures 7.4.2.2-1 and 7.4.2.2-4 (from the original MATLAB large-size graphs).

Table 7.4.3.1-1: $|E_z|$ Values (dBV/m) – PLT Line at 10 Metres – $L = \lambda/2$

r_dir (m)	2 MHz	3 MHz	5 MHz	10 MHz	20 MHz	30 MHz
9.05	-7.31	-2.38	3.27	9.19	13.48	15.88
20.13	-12.86	-8.49	-4.22	-0.53	2.62	4.95
30.37	-16.87	-13.18	-9.81	-6.84	-3.88	-1.52
49.82	-22.93	-20.12	-17.53	-14.97	-12.07	-9.69
100.40	-33.51	-31.44	-29.30	-26.90	-23.98	-21.58
200.20	-45.07	-43.23	-41.19	-38.81	-35.87	-33.44
300.14	-52.04	-50.23	-48.21	-45.83	-42.87	-40.44
500.00*	-60.9	-59.0	-57.1	-54.8	-51.4	-49.0

Table 7.4.3.1-2: $|E_z|$ Values (dBV/m) – PLT Line at 15 Metres – $L = \lambda/2$

r_dir (m)	2 MHz	3 MHz	5 MHz	10 MHz	20 MHz	30 MHz
14.04	-7.37	-2.70	2.24	6.75	10.19	12.41
19.80	-9.86	-5.52	-1.29	2.37	5.51	7.80
30.41	-13.85	-10.20	-6.88	-3.94	-0.95	1.40
50.00	-19.82	-17.04	-14.47	-11.92	-8.97	-6.57
99.99	-30.20	-28.13	-25.99	-23.58	-20.60	-18.16
200.49	-41.82	-39.98	-37.94	-35.53	-32.52	-30.06
300.33	-48.76	-46.96	-44.93	-42.51	-39.49	-37.02
500.00*	-57.2	-55.8	-53.8	-51.5	-48.5	-46.0

Table 7.4.3.1-3: Distance Conversion Factors – PLT Line at 10 Metres – $L = \lambda/2$

r_dir (1)	r_dir (2)	2 MHz	3 MHz	5 MHz	10 MHz	20 MHz	30 MHz
9.05	20.13	16.0	17.6	21.6	28.0	31.3	31.5
20.13	30.37	22.5	26.3	31.3	35.3	36.4	36.2
20.13	100.40	29.6	32.9	35.9	37.8	38.1	38.0
20.13	200.20	32.3	34.8	37.1	38.4	38.6	38.5
30.37	100.40	32.0	35.2	37.5	38.6	38.7	38.6
30.37	300.14	35.4	37.2	38.6	39.2	39.2	39.1
49.82	500.00*	37.9	38.8	39.5	39.8	39.3	39.3

Table 7.4.3.1-4: Distance Conversion Factors – PLT Line at 15 Metres – $L = \lambda/2$

r_dir (1)	r_dir (2)	2 MHz	3 MHz	5 MHz	10 MHz	20 MHz	30 MHz
14.04	19.80	16.7	18.9	23.6	29.3	31.4	30.9
19.80	30.41	21.4	25.1	30.0	33.9	34.7	34.3
19.80	99.99	28.9	32.2	35.1	36.9	37.1	36.9
19.80	200.49	31.8	34.3	36.5	37.7	37.8	37.7
30.41	99.99	31.6	34.7	37.0	38.0	38.0	37.8
30.41	300.33	35.1	37.0	38.3	38.8	38.8	38.6
50.00	500.00*	37.4	38.8	39.3	39.6	39.5	39.4

It can readily be seen that the PLT line height does not affect the distance conversion factor results appreciably. Therefore, the values in Tables 7.4.3.1-3 and 7.4.3.1-4 can be averaged to obtain typical values, as shown in Table 7.4.3.1-5.

Table 7.4.3.1-5: Averaged Distance Conversion Factors – $L = \lambda/2$

r_dir (m)	2 MHz	3 MHz	5 MHz	10 MHz	20 MHz	30 MHz
Up to 20	16.4	18.3	22.6	28.7	31.4	31.2
20 – 30	22.0	25.7	30.7	34.6	35.6	35.3
20 – 100	29.3	32.6	35.5	37.4	37.6	37.5
20 – 200	32.1	34.6	36.8	38.1	38.2	38.1
30 – 100	31.8	35.0	37.3	38.3	38.4	38.2
30 – 300	35.3	37.1	38.5	39.0	39.0	38.9
50 – 500	37.7	38.8	39.4	39.7	39.4	39.4

A careful review indicates that these averaged results can be further refined into four zones in terms of slant range and frequency, as shown in Table 7.4.3.1-6 (values are in dB/decade):

Table 7.4.3.1-6: Distance Conversion Factors (dB/decade) – $L = \lambda/2$

Zone (m)	2 MHz	3 MHz	5 MHz	10 – 30 MHz
$r_{dir} \leq 20$	16	18	23	29 - 31
$20 < r_{dir} \leq 30$	22	26	31	35
$30 < r_{dir} \leq 200$	32	35	37	38
$r_{dir} > 200$	20	20	20	20

Beyond 200 metres, the single-ray method and its factor (20 dB/decade) is applicable, as mentioned in Section 7.4.2.4, paragraph c).

7.4.3.2 Full-Wave Model

From the MATLAB results for Figures 7.4.2.3-1 and 7.4.2.3-4, the following information is excised to help identify the distance conversion factor figures. The numbers under the frequencies are the values of $|E_z|$ in dBV/m. The * in the Tables indicates extrapolated numbers read off the Figures 7.4.2.3-1 and 7.4.2.3-4 (from the original MATLAB large-size graphs).

Table 7.4.3.2-1: $|E_z|$ Values (dBV/m) – PLT Line at 10 Metres – $L = \lambda$

r_dir (m)	2 MHz	3 MHz	5 MHz	10 MHz	20 MHz	30 MHz
9.05	7.99	8.72	9.61	12.30	17.65	20.88
20.13	-5.87	-4.36	-1.26	3.78	8.07	10.71
30.37	-12.93	-10.28	-6.18	-1.73	1.88	4.37
49.82	-20.06	-16.51	-12.74	-9.33	-6.15	-3.72
100.40	-29.13	-26.29	-23.63	-20.98	-17.99	-15.57
200.20	-39.57	-37.45	-35.26	-32.82	-29.85	-27.42
300.14	-46.26	-44.32	-42.23	-39.82	-36.85	-34.42
500.00*	-54.5	-53.1	-51.0	-48.8	-45.7	-43.1

Table 7.4.3.2-2: $|E_z|$ Values (dBV/m) – PLT Line at 15 Metres – $L = \lambda$

r_dir (m)	2 MHz	3 MHz	5 MHz	10 MHz	20 MHz	30 MHz
14.04	3.10	4.02	5.77	10.26	15.22	17.95
19.80	-2.75	-1.32	1.67	6.66	10.96	13.55
30.41	-9.91	-7.29	-3.23	1.18	4.81	7.30
50.00	-16.94	-13.41	-9.67	-6.27	-3.05	-0.59
99.99	-25.84	-22.99	-20.33	-17.65	-14.61	-12.16
200.49	-36.32	-34.20	-32.01	-29.53	-26.51	-24.04
300.33	-42.98	-41.05	-38.95	-36.50	-33.47	-31.00
500.00*	-51.3	-49.2	-47.5	-44.7	-41.9	-39.4

Table 7.4.3.2-3: Distance Conversion Factors – PLT Line at 10 Metres – $L = \lambda$

r_dir (1)	r_dir (2)	2 MHz	3 MHz	5 MHz	10 MHz	20 MHz	30 MHz
9.05	20.13	39.9	37.7	31.3	24.5	27.6	29.3
20.13	30.37	39.5	33.2	27.6	30.9	34.7	35.5
20.13	100.40	33.3	31.4	32.1	35.5	37.3	37.7
20.13	200.20	33.8	33.2	34.1	36.7	38.0	38.2
30.37	100.40	31.2	30.8	33.6	37.1	38.3	38.4
30.37	300.14	33.5	34.2	36.2	38.3	38.9	39.0
49.82	500.00*	34.4	36.5	38.2	39.4	39.5	39.3

Table 7.4.3.2-4: Distance Conversion Factors – PLT Line at 15 Metres – $L = \lambda$

r_dir (1)	r_dir (2)	2 MHz	3 MHz	5 MHz	10 MHz	20 MHz	30 MHz
14.04	19.80	39.2	35.8	27.5	24.1	28.5	29.5
19.80	30.41	38.4	32.0	26.3	29.4	33.0	33.5
19.80	99.99	32.8	30.8	31.3	34.6	36.4	36.6
19.80	200.49	33.4	32.7	33.5	36.0	37.3	37.4
30.41	99.99	30.8	30.4	33.1	36.4	37.6	37.6
30.41	300.33	33.3	33.9	35.9	37.9	38.5	38.5
50.00	500.00*	34.4	35.8	37.8	38.4	38.9	38.8

Again, it can readily be seen that the PLT line height does not affect the distance conversion factor results appreciably. Therefore, the values in Tables 7.4.3.2-3 and 7.4.3.2-4 can be averaged to obtain typical values, as shown in Table 7.4.3.2-5.

Table 7.4.3.2-5: Averaged Distance Conversion Factors – $L = \lambda$

r_dir (m)	2 MHz	3 MHz	5 MHz	10 MHz	20 MHz	30 MHz
Up to 20	39.6	36.8	29.4	24.3	28.1	29.4
20 – 30	39.0	32.6	27.0	30.2	33.9	34.5
20 – 100	33.1	31.1	31.7	35.1	36.9	37.2
20 – 200	33.6	33.0	33.8	36.4	37.7	37.8
30 – 100	31.0	30.6	33.4	36.8	38.0	38.0
30 – 300	33.4	34.1	36.1	38.1	38.7	38.8
50 – 500	34.4	36.2	38.0	38.9	39.2	39.1

The contents of Table 7.4.3.2-5 can be further refined into four zones in terms of slant range and frequency, as shown in Table 7.4.3.2-6 (values are in dB/decade). However, the full-wave model exhibits more complicated results, as seen in the figures of Section 7.4.2.3.

Table 7.4.3.2-6: Distance Conversion Factors (dB/decade) – $L = \lambda$

Zone (m)	2 MHz	3 MHz	5 MHz	10 MHz	20 – 30 MHz
$r_{dir} \leq 20$	40	37	29	24	28 – 29
$20 < r_{dir} \leq 30$	39	33	27	30	34
$30 < r_{dir} \leq 200$	31 – 33	31 – 33	33	36	38
$r_{dir} > 200$	20	20	20	20	20

Beyond 200 metres, the single-ray method and its factor (20 dB/decade) is applicable, as mentioned in Section 7.4.2.4, paragraph c).

One important observation is that the E_z field magnitudes obtained with full-wave dipole model are several dB higher than those obtained with the half-wave dipole model. The reason for this is the higher directivity of the full-wave dipole due to its narrower beamwidth.

7.4.4 Remarks

As indicated in Section 7.2, the half-wave dipole is preferable to the full-wave dipole as a modelling tool. Accordingly, the distance conversion factors listed in Table 7.4.3.1-6 are selected for the theoretical results.

A direct comparison of measured and theoretical results is not practical due to the many uncertainties involved in the various measurement techniques, instruments, positional (locational) variables, and so on.

It should also be noted that some of the measurement results shown in Section 7.4.1 are for In-House systems and are not comparable. Nevertheless, both sets of results show a commonality of values and similar variation with frequency and distance.

7.5 REPRESENTATIVE PLT SOURCES

In order to be able to predict cumulative effects of PLT in Chapter 8, the EIRP of PLT systems must be estimated. Below, different values are proposed for use in this regard.

Based on injected PSD:

- HomePlug systems (1.0 or AV): Injected PSD -50 dBm/Hz, antenna gain -30 dBi, average duty cycle 30% (considering the multitude of usages for an In-House network; media distribution, computer networking, etc.).
- Amperion Access system: Injected PSD -50 dBm/Hz, antenna gain -15 dBi, average duty cycle 15%.

Based on limits (see Chapter 4 for numerical values, and then use conversion methods recommended in Section 7.3 to obtain EIRP):

- NB30.
- FCC Part 15.
- Proposed European common mode current limits are not applicable, as no method to estimate EIRP from common mode current has been properly established.

Chapter 8 – EMC ANALYSIS METHODS

As mentioned in Section 6.1, the Task Group has for various reasons chosen to focus on cumulative effects in the far field.

8.1 CUMULATIVE EFFECTS MODELLING METHODS IN THE FAR FIELD (SKY WAVE)

In this section a comprehensive methodology is proposed to predict the cumulative effect at any particular receiver location. Given accurate knowledge of all relevant input parameters, the methodology would give accurate predictions.

It is well established and easy to explain (see e.g., [55],[84],[3, Annex 7]) that the cumulative effect from a large number of unintentional radiators (e.g., PLT installations), as received at a sensitive receiver site, can be written:

$$p_{Cum}(f, t) = \iint_{x,y} \frac{g_{RX}(x, y, f)}{L(x, y, f, t)} p_{TX}(f) D_A(x, y) \eta_{PEN}(x, y) \eta_{USAGE}(t) dA \quad (8-1)$$

- $p_{Cum}(f, t)$ is the total received power spectral density [W/Hz], at frequency f and time instant t .
- The integral is done over an area with geographical coordinates (x, y) .
- The integral (summation) is performed incoherently, i.e., on a power basis rather than on an amplitude basis. This corresponds to the emitted signals not being coherent with each other. Coherent sources could cause a higher total power if they add in phase.
- $g_{RX}(x, y, f)$ is the receiver antenna directivity in the direction (azimuth and elevation) of signals originating from a transmitter at point (x, y) . It is important to use directivity rather than gain, in order to be able to compare easily the result to established background noise levels.
- $L(x, y, f, t)$ is the basic transmission loss from point (x, y) to the sensitive receiver site (see Chapter 6). For each frequency it varies with time (as function of solar activity and time of day and year). We propose to use the median transmission loss “LOSS” as predicted by ICEPAC, which gives a prediction of the cumulative PLT noise under *median* propagation conditions for the given input parameters. Note that this proposal contrasts with some previous works on cumulative effect prediction (e.g., [55],[84] and [3, Annex 7]), where a simple reflection model is used to predict ionospheric propagation loss (see also Section 6.2.1).
- Note that ICEPAC can estimate $L(x, y, f, t) / g_{RX}(x, y, f)$ directly, if given the receiver antenna diagram, which in this case should be normalized by the antenna efficiency to give antenna directivity rather than gain. In the absence of knowledge of receiver antenna, an isotropic antenna can be assumed, $g_{RX}(x, y, f) = 1$.
- $p_{TX}(f)$ is the average EIRP spectral density [W/Hz] of a single PLT installation (see Chapter 7).
- $D_A(x, y)$ is the population density (persons per unit area). Such demographic data (actual numbers from 2005 and predicted numbers for 2010 and 2015) can be downloaded free of charge from the database “Gridded population of the world” [72]. It is recommended to download “Population Grid” data, which contains the number of people in each grid square, at a grid

resolution of 0.25 degrees. These data implicitly take into account the different areas of grid squares at different latitudes (and that some grid squares have smaller land areas since they contain partly sea), and hence contain $D_A(x, y)dA$ directly.

- $\eta_{PEN}(x, y)$ is the market penetration (PLT installations per capita).
- $\eta_{USAGE}(t)$ is the duty cycle; the average fraction of time each PLT installation is transmitting. This will be different for different times of day and week; for home installations it is likely to be larger when people are not at work. When considering In-House PLT systems, the market penetration would refer to the number of modems installed, while the duty cycle be averaged over the number of modems (and hence will not exceed 50%, considering that there always will be at least one modem listening to a transmitting modem).
- There will undoubtedly be large uncertainties in any kind of estimates of $\eta_{PEN}(x, y)$ and $\eta_{USAGE}(t)$, since this kind of market information is difficult to obtain access to and hard to predict into the future.

To estimate the potential of cumulative effect problems at a sensitive receiver site, the Task Group recommends the following methodology:

- 1) Download and import population density data $D_A(x, y)dA$.
- 2) Estimate $\eta_{PEN}(x, y)$ based on available market information.
- 3) Select a number of representative operating frequencies, times of day and year, sunspot numbers and levels of geomagnetic activity. For each combination of these, do the remaining points.
- 4) Run ICEPAC (ICEAREA_INV) to obtain median values of $L(x, y, f, t) / g_{RX}(x, y, f)$.
- 5) Estimate values of $p_{TX}(f)$ and $\eta_{USAGE}(t)$, based on available information.
- 6) Evaluate the integral numerically.
- 7) Compare the result with the background noise level (see Chapter 2, or use knowledge of noise levels at specific receiver site).

8.1.1 “Cumulative PLT Tool”

When implementing the methodology described above, one soon runs into the problem that the user interface of ICEAREA INVERSE only allows sweeping over 9 different combinations of input parameters, which makes it cumbersome to perform comprehensive analyses. The number of input parameters is five (month, time of day, sunspot number, geomagnetic Q index and frequency), such that the total number of parameter combinations easily exceeds 1000, even with a modest number of alternatives for each parameter.

To overcome this problem, the Task Group has developed a MATLAB-based tool “Cumulative PLT Tool” which will bypass the ICEAREA INVERSE user interface and rather call the program directly in batch mode for an arbitrarily large number of parameter combinations, by modifying the input files before issuing the DOS command to call the program without user interface. Note that the ICEPAC user interface also does include the option of starting a batch job, but that requires manual pre-configuration of input files.

For each parameter combination, Cumulative PLT Tool will perform items 1, 4, 6 and 7 in the methodology outlined above, and save the resulting cumulative PLT noise level to a text file which can easily be opened in Excel, MATLAB, or any other program for post-processing and display. The text file will also contain

existing ITU-R noise levels and the Absolute Protection Requirement proposed in Section 2.4. The Absolute Protection Requirement of -15 dB μ V/m per 9 kHz bandwidth is converted to dBm/Hz using equations (2-4) and (2-3b), which are frequency-dependent.

Also, under certain rare circumstances it turns out that ICEPAC predicts path losses smaller than 30 dB from certain regions to the receiver site. This is clearly unphysical and is likely to be due to some flaw in ICEPAC. Cumulative PLT Tool will discard any ICEPAC runs which predict the path loss to any region to be smaller than 50 dB, and tag the predicted cumulative PLT noise level as NaN (Not a Number) to indicate missing data. In the examples described below, this occurred at 107 out of a total of 7992 ICEPAC runs.

Before running the tool, ICEAREA INVERSE should be run once in order to define receiver location and transmitter location grid, and set up the input files (which the tool will later modify) accordingly. The transmitter location grid must be a Latitude/Longitude grid with 0.25 degrees resolution in both directions (see Section 6.2.3), and the result should be saved in the “default\” subdirectory.

Due to time constraints, the tool is equipped with a text-based user interface rather than a graphical user interface (GUI). Also, $p_{TX}(f)$, $\eta_{PEN}(x,y)$ and $\eta_{USAGE}(t)$ are constant input parameters, such that variation in these parameters over frequency, location and time is not implemented.

8.1.2 Cumulative PLT Tool – Instructions on Use

IMPORTANT: Software files for the Cumulative PLT Tool have been made available with this report – they can be found in the folder named “TR-IST-050-Cumulative-Tool-Software-Files”.

The user interface of the tool is intended to be reasonably self-explanatory. For an example on how to use the tool, see Section 8.2 below.

To start using the tool, do the following:

- 1) Run ICEAREA INVERSE once in order to set up the receiver location and transmitter location grid:
 - a) Start ICEAREA INVERSE
 - b) Push “Receiver” to select receiver location
 - c) Push “Plot Center”, → “Set to receiver”, and select the X-range and Y-range for the transmitter grid. Ensure that the X-range and Y-range covers the same number of degrees.
 - d) Push “Grid”, select Grid Type = “1 Lat/Lon”, and select the grid size such that each grid cell is 0.25 x 0.25 degrees; e.g., if X-range and Y-range cover 70 x 70 degrees, select a grid size of 281 x 281.
 - e) Select “Run” → “Map only” in order to see the extent of the transmitter grid.
 - f) Set up “Coefficients” and “System parameters”, e.g., as suggested in Section 6.2.3 (Coefficients = URSI88, Min. angle = 0.1 deg, multipath power tolerance = 10 dB, maximum tolerable time delay = 15 ms).
 - g) Select transmitter and receiver antennas (e.g., default/isotrope).
 - h) Ensure that there is only one parameter combination under “Groups” (the actual parameter values here are irrelevant).
 - i) Select “Run” → “Calculate” → “Save/Calculate/Screen”

- j) When prompted for input file name, go to the subfolder named “default” and enter a meaningful file name.
 - k) The program should now perform calculations and produce a plot on the screen.
 - l) Close the program and all windows it has generated. The files generated by the program will be used by the Cumulative PLT Tool.
- 2) Start MATLAB, go to the installation folder and enter “cumulative_plt_tool” in order to start the tool. Follow the on-screen instructions.
- a) The input procedures are intended to be relatively failsafe; in case of unexpected inputs the tool should repeat the question.
 - b) The options of the text-based user interface are illustrated in Figure 8.2.1-1.
 - c) When prompted to select population data file, note that, e.g., the file name glp05ag15.bil corresponds to population data from 2005, and glp10ag15.bil to 2010 (the middle digits of the file name denotes year).
 - d) Be aware that large amounts of processing time and hard disk space may be required if running a large number of parameter combinations.

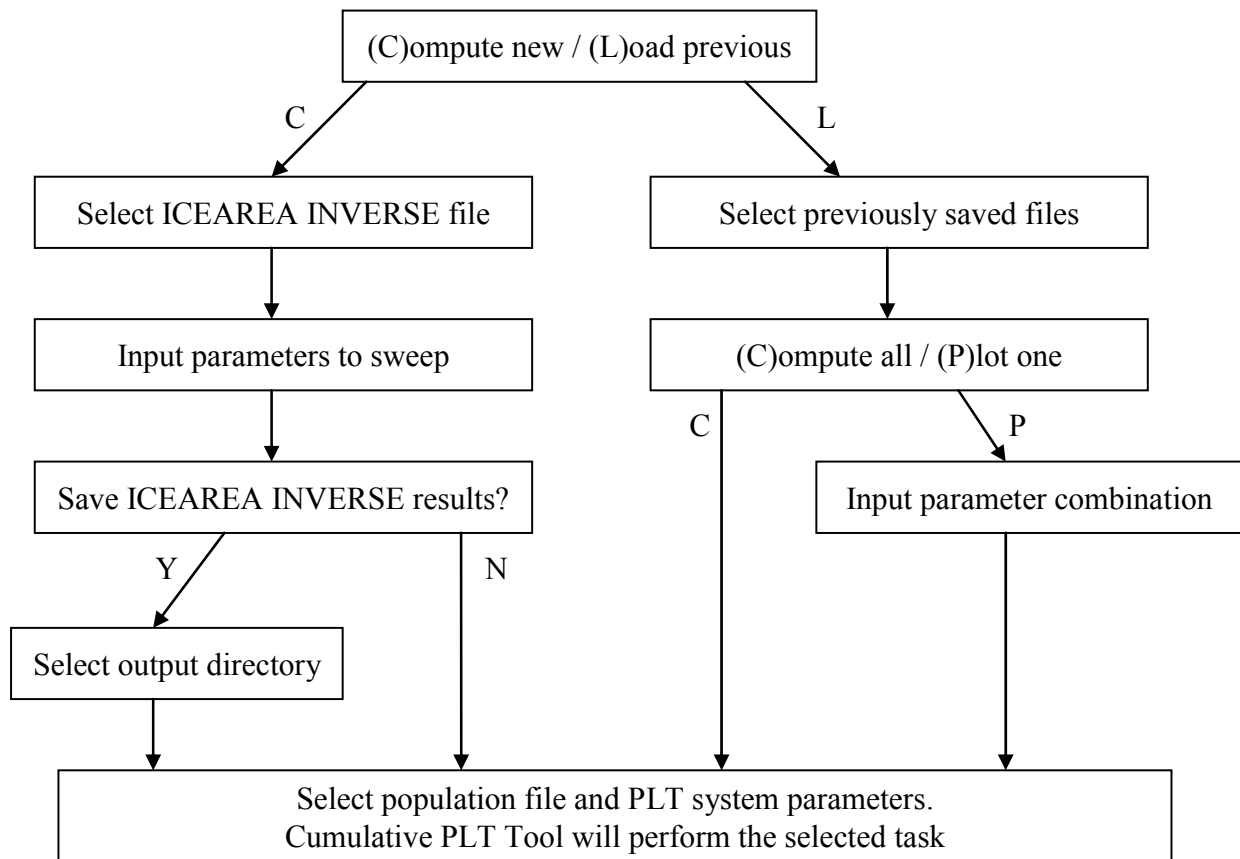

Figure 8.1.2-1: Flow Chart of the Available Options in the User Interface of Cumulative PLT Tool.

The tool has three different modes of operation:

- 1) “Compute new”: The tool will go through a number of parameter combinations and do the following for each parameter combination:
 - a) Call ICEAREA INVERSE.
 - b) Store the result file generated by ICEAREA INVERSE for later use (optional).
 - c) Estimate the cumulative PLT noise level and compare with ITU-R noise curves and with the Absolute Protection Requirement of Section 2.4.
 - d) Write the resulting numbers to a text file.
- 2) “Load previous / Compute all”: The tool will go through files previously generated by ICEAREA INVERSE under mode 1 and do the following for each file:
 - a) Load ICEAREA INVERSE result file into memory.
 - b) Estimate the cumulative PLT noise level and compare with ITU-R noise curves with the Absolute Protection Requirement of Section 2.4.
 - c) Write the resulting numbers to a text file.
- 3) “Load previous / Plot one”: The tool will prompt the user to select one of the previously computed parameter combinations and produce the type of figure/map shown in Figures. 8.2.1-2 and 8.2.2-2.

The following files are produced when running the tool:

- 1) “xxx_summary.txt”: Text file containing the estimated cumulative PLT noise level compared to background noise curves for each parameter combination.
- 2) “xxx_swept_parameters.mat”: MATLAB data file containing information on which parameter combinations were simulated (to be used in the “Load previous” modes).
- 3) (Optional) “xxx_00001.ig1”, “xxx_00002.ig1”, and so on: Results generated by ICEAREA INVERSE. One file per parameter combination.

8.1.3 Improvement Potentials Regarding Cumulative PLT Tool

Due to time constraints, Cumulative PLT Tool is equipped with a text-based user interface rather than a graphical user interface (GUI). Also, $p_{TX}(f)$, $\eta_{PEN}(x, y)$ and $\eta_{USAGE}(t)$ are constant input parameters, such that variation in these parameters over frequency, location and time is not implemented.

In case it should be required to improve the tool to address these shortcomings, a short overview of what would be required is given here:

- Equipping the tool with a GUI:
In addition to designing the GUI, a substantial rewrite of the program would be required, since the text-based user interface has been implemented as an integrated part of the program.
- Allowing $p_{TX}(f)$ to vary with frequency:
A procedure should be implemented to import the EIRP at each of the frequencies to be simulated, and store in a MATLAB vector `EIRP` containing one value per frequency. A counter `Freq_index` should be included, and the statement
`EIRP_per_capita = EIRP(Freq_index) + marketfactor;`
should be placed in the inner loop of the program.

- Allowing $\eta_{USAGE}(t)$ to vary with time of day (and possibly with time of year):
Implementation of this would follow the lines of implementing frequency variation as described above, but be slightly more complicated.
- Allowing $\eta_{PEN}(x, y)$ to vary with geographical location:
In this regard, the most cumbersome challenge would be how to specify the variation in market penetration as function of location, e.g., based on maps combined with information on different penetration in different countries or regions. Once the market penetration is stored in a MATLAB array `penetration` covering the same area as the ICEAREA INVERSE results with of 0.25 x 0.25 degrees grid resolution, the information could be incorporated by changing the second last line in the subfunction `cumulative_integral.m` to `product = loss_used.*pop_used.*penetration;` and remove any current reference to `penetration` in the main program.
- Reducing storage requirements:
Replacing the text files produced by ICEAREA INVERSE by binary files, and retaining only the estimated path loss (disregarding all other estimated parameters), would significantly reduce the disk storage requirements.

8.2 CALCULATION OF HF RADIO NOISE FROM PLT/xDSL SYSTEMS

In this section, we present examples where Cumulative PLT Tool is used to evaluate the interference potential at hypothetical sensitive receiver locations. The locations were selected on the basis that they should be cities (for easy reference) with lots of nearby countryside (where sensitive receiver sites might be located, and where comparison with “quiet rural” noise curves is natural). Any correspondence with real-world sensitive receiver sites is purely coincidental.

8.2.1 Receiver Location in Bodø, Norway

In this first example, the hypothetical receiver location is Bodø, Norway. The analysis is performed under the following assumptions:

- Average EIRP per PLT installation is $p_{TX} = -80$ dBm/Hz (e.g., -50 dBm/Hz HomePlug modems and equivalent antenna gain from wiring of -30 dBi. Please refer to Chapter 7, Section 7.5).
- Market penetration is $\eta_{PEN} = 0.05$ PLT modems per capita.
- Duty cycle of each modem is $\eta_{USAGE} = 0.3$.
- The transmitter location grid used extends from -20 to 50 degrees longitude and 10 to 80 degrees latitude, and PLT modems outside this area are disregarded.
- No knowledge of receiver antenna characteristics is assumed, hence an isotropic receiver antenna is used in the analysis.
- Population data predictions from 2010 is used.

Cumulative PLT Tool is run as follows:

```
-----  
Cumulative PLT Tool  
Roald Otnes, Norwegian Defence Research Establishment (FFI), October 2006  
NATO RTO IST-050/RTG-022 on HF Interference, Procedures and Tools  
-----
```

This program will estimate the cumulative effects from PLT, based on ICEPAC sky wave path loss predictions and population data from "Gridded population of the world" (gpwv3) database

The program has been tested on MATLAB versions 6.5 and 7.1, and with ICEPAC version 05.0119WW

Please run ICEAREA INVERSE one time as normal to set up all parameters, before running this program to sweep some of the parameters. ICEAREA INVERSE will then be called (batch mode) for all chosen parameter combinations.

Use of text-based interface:

Enter will provide default parameters.
Use MATLAB syntax for the parameters to be swept.
Be aware that using default values for all swept parameters will take very long time to run.
Ctrl-C in MATLAB window to abort.
Do NOT close down the ICEPAC window that pops up; that will make Windows confused.

```
ICEAREA INVERSE batch calculation: (C)ompute new or (L)oad previous? c  
ICEPAC installation directory [c:\itshfbc\]:  
ICEPACfile =  
BODO_ISO  
Swept months [2:2:12]: 2:2:12  
Swept UTCs [0:4:20]: 0:4:20  
Swept SSNs [50 100 200]: [50 100 200]  
Swept Qs [0 5]: [0 5]  
Swept freqs [2 4 8 16 24]: [2 4 8 16 20 24]  
Total number of ICEAREA INVERSE runs planned: 1512  
Save ICEAREA INVERSE results for later use (disk space required: 20267.1 MB). [Y]/N? y  
Output directory [.\ICEPAC\]: .\temp\  
-----
```

```
EIRP per PLT modem (dBm/Hz) [-80]:  
Market penetration (PLT modems per capita) [0.05]:  
Duty cycle (fraction of time each PLT modem is transmitting) [0.3]:  
Market factor (penetration * duty cycle): -18.2 dB  
EIRP per capita: -98.2 dBm/Hz  
-----
```

Results will be saved to file .\temp\BODO_ISO_summary.txt

```
Month: 2 / UTC: 0 / SSN: 50 / Q: 0 / Freq: 2.00  
Modifying ICEAREA INVERSE input files  
copy c:\itshfbc\run\temp1.txt c:\itshfbc\run\iceareax.da1  
1 file(s) copied.  
copy c:\itshfbc\run\temp2.txt c:\itshfbc\area_inv\default\BODO_ISO.ice  
1 file(s) copied.  
c:\itshfbc\bin_win\ICEPACw.exe c:\itshfbc\ INV CALC default\BODO_ISO.ice  
copy c:\itshfbc\area_inv\default\BODO_ISO.ig1 .\temp\BODO_ISO_00001.ig1  
1 file(s) copied.
```

Integral of population / loss over entire area: -32.5 dB
Received PLT noise: -130.8 dBm/Hz

Atmospheric noise lower limit: -159.7 dBm/Hz
Man-made, rural: -115.0 dBm/Hz

EMC ANALYSIS METHODS

Man-made, quiet rural: -129.0 dBm/Hz
 Absolute protection requirement: -139.1 dBm/Hz

and so on for 1511 other parameter combinations...

The MATLAB text dump presented above starts with documentation and usage explanation, followed by user input of parameters and brief reports from individual ICEPAC runs. Above is only shown the first of 1512 runs (for 6*6*3*2*7 parameter combinations), for which the estimated PLT noise happened to be close to the ITU-R value for man-made noise at this frequency (2 MHz) in quiet rural locations. The 1512 ICEPAC runs with the 281 x 281 grid used here took a total of about 22 hours on a standard desktop computer which was new in January 2006, and filled 20 GB of disk space when the detailed ICEPAC results were saved (optional) for later use.

As the input value “EIRP per PLT modem” is bandwidth normalized and given in units of dBm/Hz, the resulting estimate of the cumulative PLT noise is also given in units of dBm/Hz.

The results are saved to a tabulator-separated text file, one line per ICEPAC run, starting like this (in case of discarded ICEPAC runs, the number in the “PLT noise” column will be replaced by “NaN”):

```
BODO [ISOTROPE ], 2010 population data, EIRP = -98.2 dBm/Hz per capita
Month UTC   SSN   Q     Freq  PLT noise  Atm (low)  Rural  Quiet rural  Abs. prot. req.
2      0      50    0     2.000  -130.80  -159.65  -114.99      -129.01      -139.06
2      0      50    0     4.000  -132.92  -152.37  -123.18      -137.62      -145.08
2      0      50    0     8.000  -139.34  -146.21  -131.36      -146.23      -151.10
2      0      50    0    12.000  -160.30  -151.36  -136.15      -151.26      -154.63
2      0      50    0    16.000  -193.54  -160.64  -139.55      -154.84      -157.12
2      0      50    0    20.000  -215.27  -174.00  -142.19      -157.61      -159.06
2      0      50    0    24.000  -217.12  -187.36  -144.34      -159.87      -160.65
2      0      50    5     2.000  -128.02  -159.65  -114.99      -129.01      -139.06
2      0      50    5     4.000  -133.04  -152.37  -123.18      -137.62      -145.08
2      0      50    5     8.000  -140.58  -146.21  -131.36      -146.23      -151.10...
```

This file can be opened in Excel or MATLAB or any other program for further post-processing and display. A simple example is given in Figure 8.2.1-1, where for each frequency is shown the spread in estimated PLT noise (for combinations of the 4 remaining parameters). Using MATLAB to count the number of measured values above and below the red line in this example, it is found that 45% of the estimated median PLT noise levels exceed the median quiet rural man-made noise level (7% at 2 MHz, 31% at 4 MHz, 62% at 8 MHz, 75% at 12 MHz, 65% at 16 MHz, 48% at 20 MHz and 29% at 24 MHz), see also Figures 8.2.3-1 and 8.2.3-2. **Note that these percentages will be highly influenced by assumptions on transmitter EIRP, PLT market penetration and duty cycle.** A change in any of these parameters will shift all estimated cumulative PLT noise levels up or down by the corresponding number of dBs.

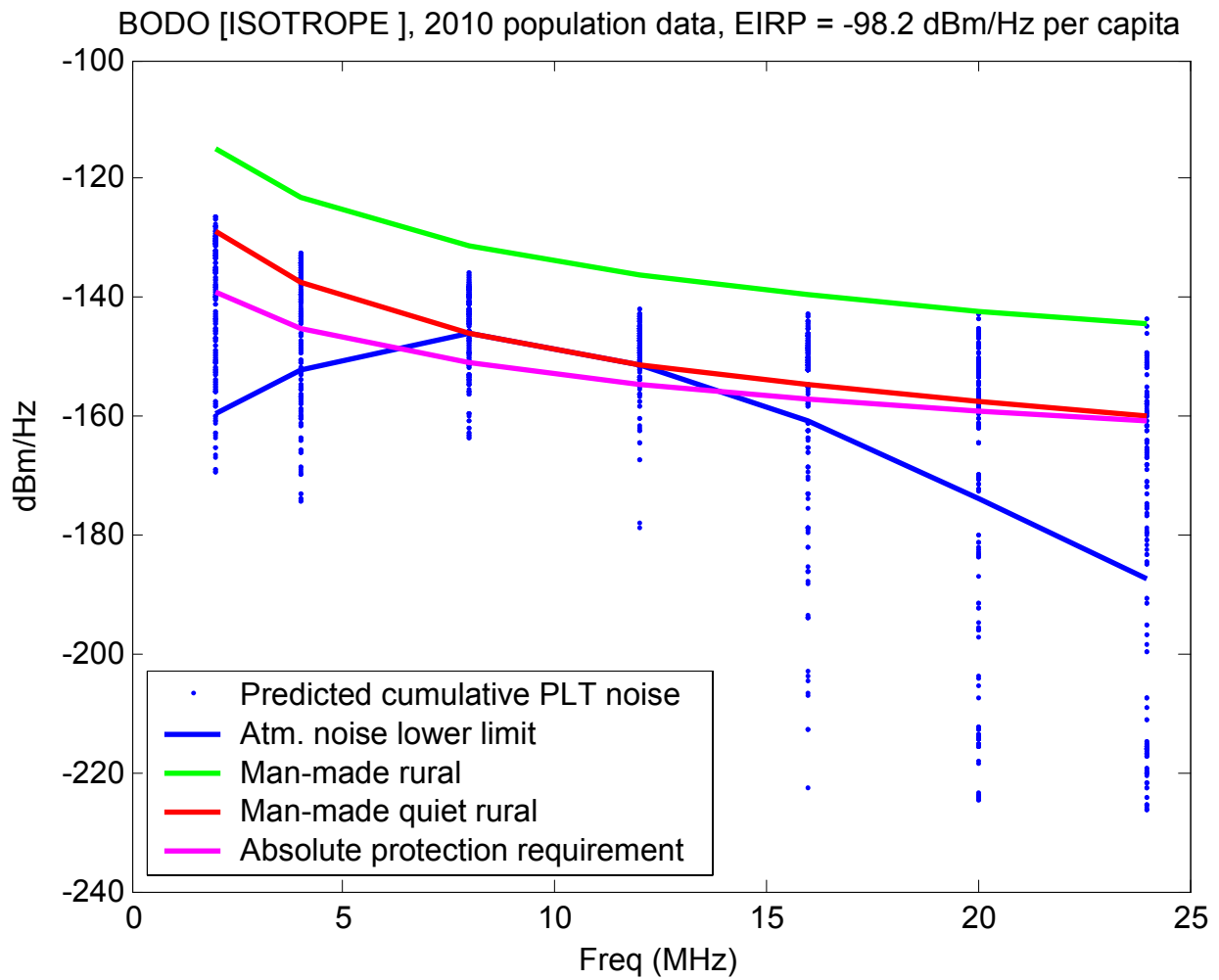

Figure 8.2.1-1: Predicted Cumulative PLT Noise Parameters, for example with Receiver in Bodø, Compared to Established Background Noise Levels.

Cumulative PLT Tool also provides the option of plotting “maps” illustrating the correspondence between ICEPAC path loss and population density. This requires that the detailed ICEPAC results have been saved to disk. An example for a case where the predicted PLT noise exceeds the median quiet rural man-made noise by more than 10 dB is shown in Figure 8.2.1-2 below.

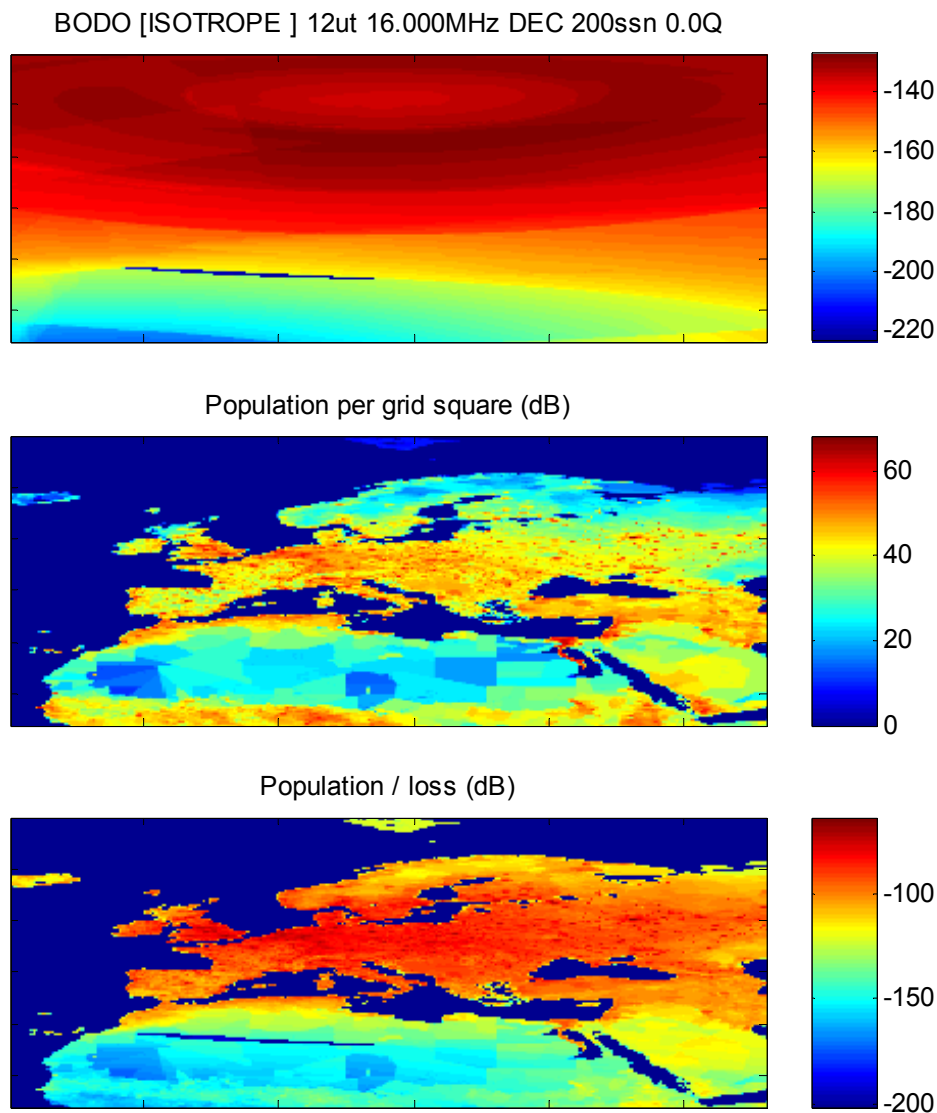

Figure 8.2.1-2: Upper Plot: Median Path Loss (dB) as Predicted by ICEPAC for a Certain Combination of Input Parameters with Receiver in Bodø; Middle Plot: Population per 0.25 x 0.25 Degrees Grid Square in dB ($10 \cdot \log_{10}(\text{population})$); Lower Plot: Product (dB-sum) of the Two above Plots.

In general, high predicted PLT noise levels correspond to cases where there is low path loss from densely populated regions.

The maps in Figure 8.2.1-2 are generated using Cumulative PLT Tool in the following fashion:

```
ICEAREA INVERSE batch calculation: (C)ompute new or (L)oad previous? l
ICEPACfile =
BODO_ISO
(C)ompute cumulative PLT noise for all files, or (P)lot One? p
Select month, one of (2 4 6 8 10 12): 12
Select UTC, one of (0 4 8 12 16 20): 12
Select SSN, one of (50 100 200): 200
Select Q, one of (0 5): 0
Select Freq, one of (2 4 8 12 16 20 24): 16
-----
```

```
EIRP per PLT modem (dBm/Hz) [-80]:
Market penetration (PLT modems per capita) [0.05]:
Duty cycle (fraction of time each PLT modem is transmitting) [0.3]:
Market factor (penetration * duty cycle): -18.2 dB
EIRP per capita: -98.2 dBm/Hz
-----
Month: 12 / UTC: 12 / SSN: 200 / Q: 0 / Freq: 16.00

Integral of population / loss over entire area: -44.5 dB
Received PLT noise: -142.7 dBm/Hz

Atmospheric noise lower limit: -160.6 dBm/Hz
Man-made, rural: -139.6 dBm/Hz
Man-made, quiet rural: -154.8 dBm/Hz
Absolute protection requirement: -157.1 dBm/Hz
-----
```

8.2.2 Receiver Location in Winnipeg, Canada

In the second example, the hypothetical receiver location is in Winnipeg, Canada. The analysis is performed under the same assumptions as above, except that the transmitter location grid used extends from -125 to -65 degrees longitude and 0 to 60 degrees latitude. In this example, details on usage of Cumulative PLT Tool are not included, as it is similar to the previous example.

Compared to the previous example, we increased the number of frequencies probed from 7 to 9, and the number of hours probed from 6 (every fourth hour) to 12 (every second hour). The result from the same post-processing method as used for Figure 8.2.1-1 is shown in Figure 8.2.2-1. In this example, 52% of the estimated median PLT noise levels exceed the median quiet rural man-made noise level (14% at 2 MHz, 46% at 4 MHz, 57% at 6 MHz, 65% at 8 MHz, 73% at 10 MHz, 77% at 12 MHz, 65% at 16 MHz, 41% at 20 MHz and 27% at 24 MHz), see also Figures 8.2.3-1 and 8.2.3-2. Note that also in this example, these percentages will be highly influenced by assumptions on transmitter EIRP, PLT market penetration and duty cycle.

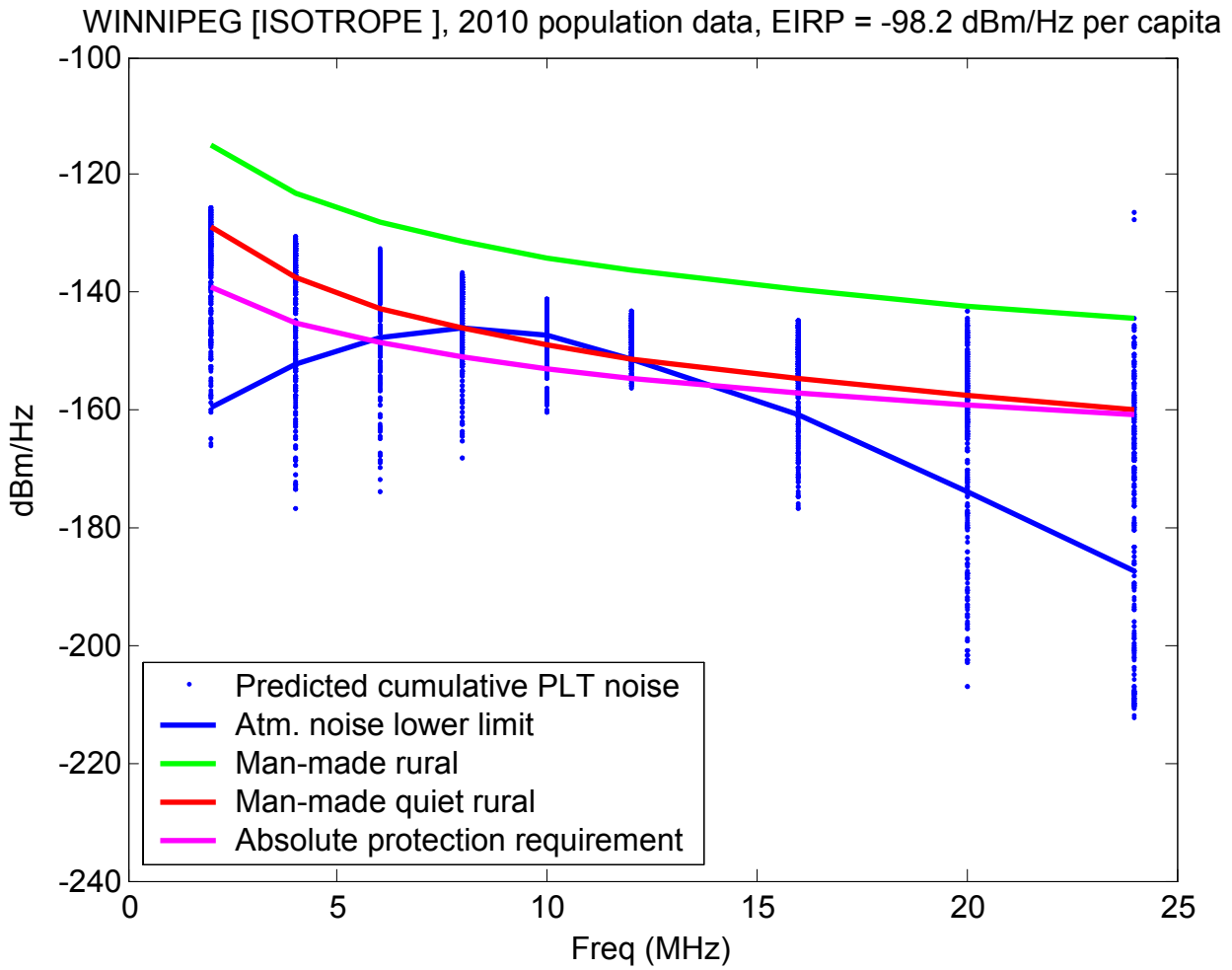

Figure 8.2.2-1: Predicted Cumulative PLT Noise Parameters, for example with Receiver in Winnipeg, Compared to Established Background Noise Levels.

In Figure 8.2.2-2 is shown an illustrating map of the same type as Figure 8.2.1-2, for a case where the predicted PLT noise is -136.8 dBm/Hz while the median quiet rural noise level is -146.2 dBm/Hz.

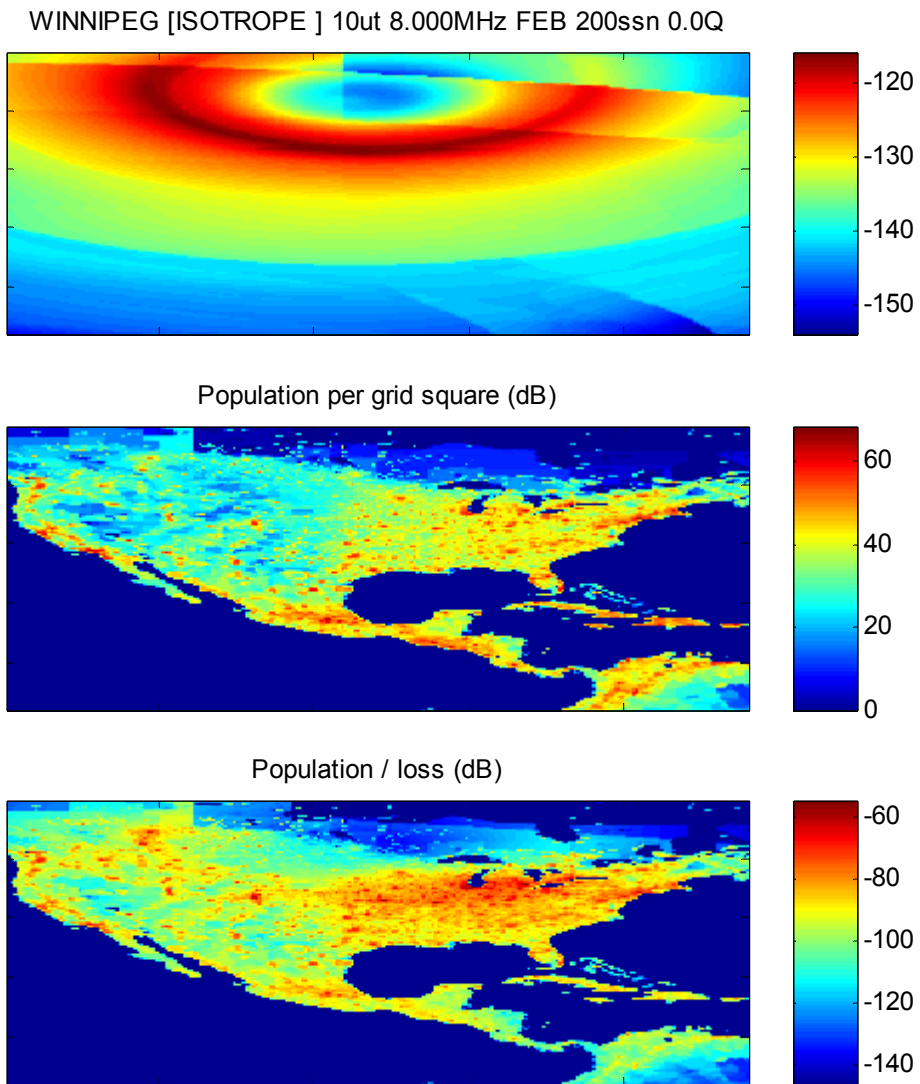

Figure 8.2.2-2: Upper Plot: Median Path Loss (dB) as Predicted by ICEPAC for a Certain Combination of Input Parameters with Receiver in Winnipeg; Middle Plot: Population per 0.25 x 0.25 Degrees Grid Square in dB ($10 \cdot \log_{10}(\text{population})$); Lower Plot: Product (dB-sum) of the Two above Plots.

The striking point of these two examples is the similarity of the results (given the same assumptions on input parameters) despite the disparate geographical locations, as seen by comparing Figures 8.2.1-1 and 8.2.2-1. The one thing these two locations have in common are that they are so far North that there are no heavily populated regions nearby, except for the city itself.

8.2.3 Other Receiver Locations

We repeated the procedure outlined above for two more receiver locations. The receiver locations (including the two locations previously described in detail) are summarized in Table 8.2.3-1.

Table 8.2.3-1: Receiver Locations used in Simulations

Location name	Transmitter grid area (lat/long)	Total # parameter combinations	# failed ICEPAC runs	Frequencies simulated (MHz)
Bodø, Norway	10N-80N / 20W-50E	1512	8	2,4,8,12,16,20,24
Winnipeg, Canada	0-60N / 125W-65W	3888	29	2,4,6,8,10,12,16,20,24
Augsburg, Germany	0-70N / 15W-55E	1080	14	2,4,8,16,24
Jacksonville, NC, USA	35S-55N / 125-35W	1512	56	2,4,8,12,16,20,24

We retain the same assumptions as previously, repeated here:

- Average EIRP per PLT installation is $p_{TX} = -80$ dBm/Hz (e.g., -50 dBm/Hz HomePlug modems and equivalent antenna gain from wiring of -30 dBi. Please refer to Chapter 7, Section 7.5).
- Market penetration is $\eta_{PEN} = 0.05$ PLT modems per capita.
- Duty cycle of each modem is $\eta_{USAGE} = 0.3$.
- PLT modems outside the transmitter location grid area are disregarded.
- No knowledge of receiver antenna characteristics is assumed, hence an isotropic receiver antenna is used in the analysis.
- Population data predictions from 2010 is used.

For each receiver location and frequency, we computed the percentage of parameter combinations where the estimated PLT noise level is above the quiet rural level, above quiet rural + 6 dB, and above the rural noise level (all these noise curves represent median values and the cumulative PLT noise levels are estimated from median propagation loss per parameter combination). The results are summarized in Figure 8.2.3-1. It should be kept in mind that the percentages are highly influenced by assumptions on transmitter EIRP, PLT market penetration and duty cycle.

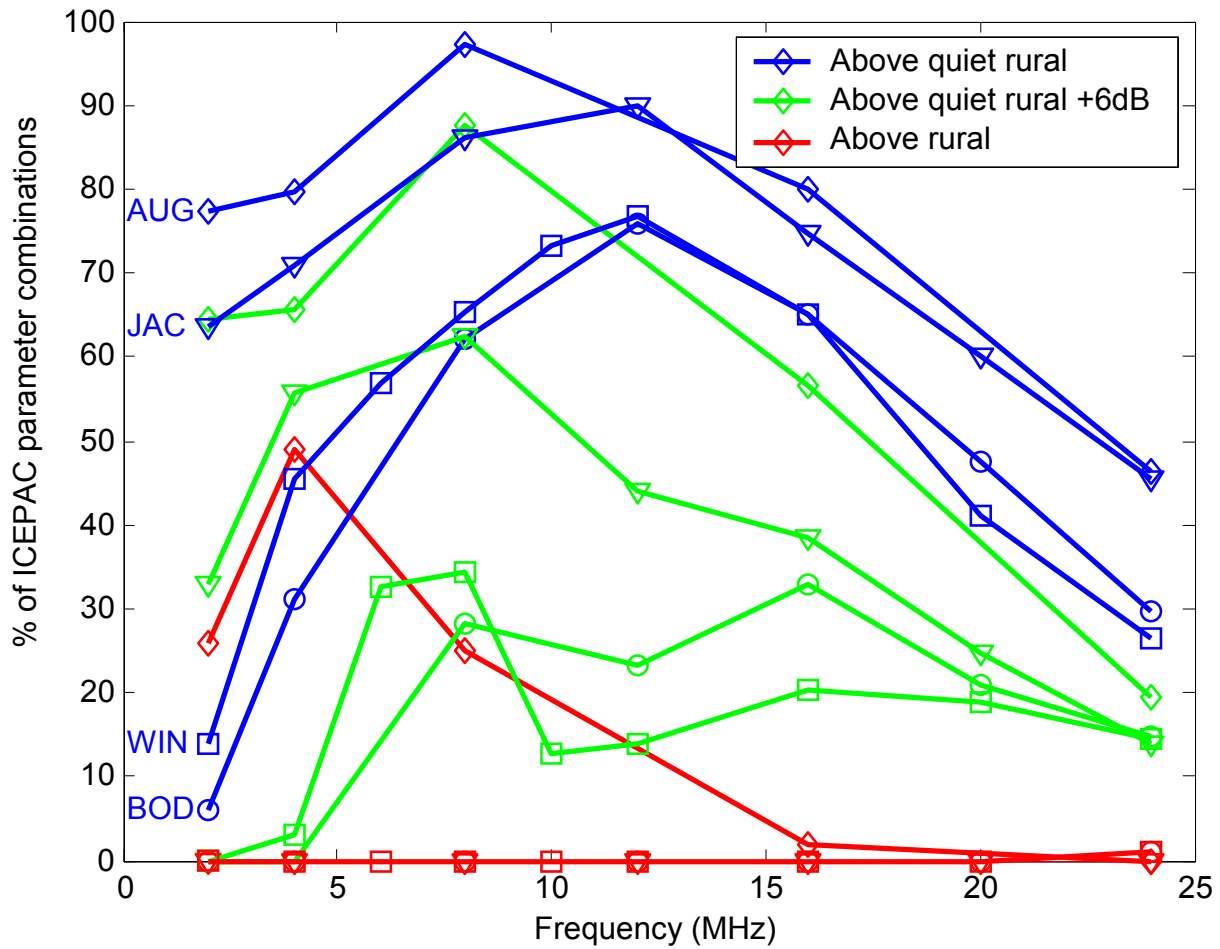

Figure 8.2.3-1: Percentage of Environmental Parameter Combinations where Estimated Cumulative PLT Noise Exceeds Different Noise Curves. Different receiver locations are denoted by different markers and annotated on the left-hand side (BODø, WINnipeg, AUGsborg, JACKsonville).

From Figure 8.2.3-1 we note that while the simulated cumulative effect of PLT is similar for the Northern locations of Bodø and Winnipeg, the problem is predicted to be larger in Augsburg in central Europe: With the chosen assumptions on PLT systems, 97% of the parameter combinations at 8 MHz exceed the median quiet rural noise curve, and 49 % of the parameter combinations at 4 MHz even exceed the median rural noise curve. The result for Jacksonville on the US East Coast is between Augsburg and the Northern sites.

In Figure 8.2.3-2 we computed the percentage of parameter combinations where the estimated PLT noise level is above the Absolute Protection Requirement of Section 2.4. It should be kept in mind that the percentages are highly influenced by assumptions on transmitter EIRP, PLT market penetration and duty cycle. Note that with the chosen assumptions on these values, the probability of the cumulative effect of PLT exceeding the Absolute Protection Requirement is predicted to be relatively large for all frequencies and receiver locations simulated.

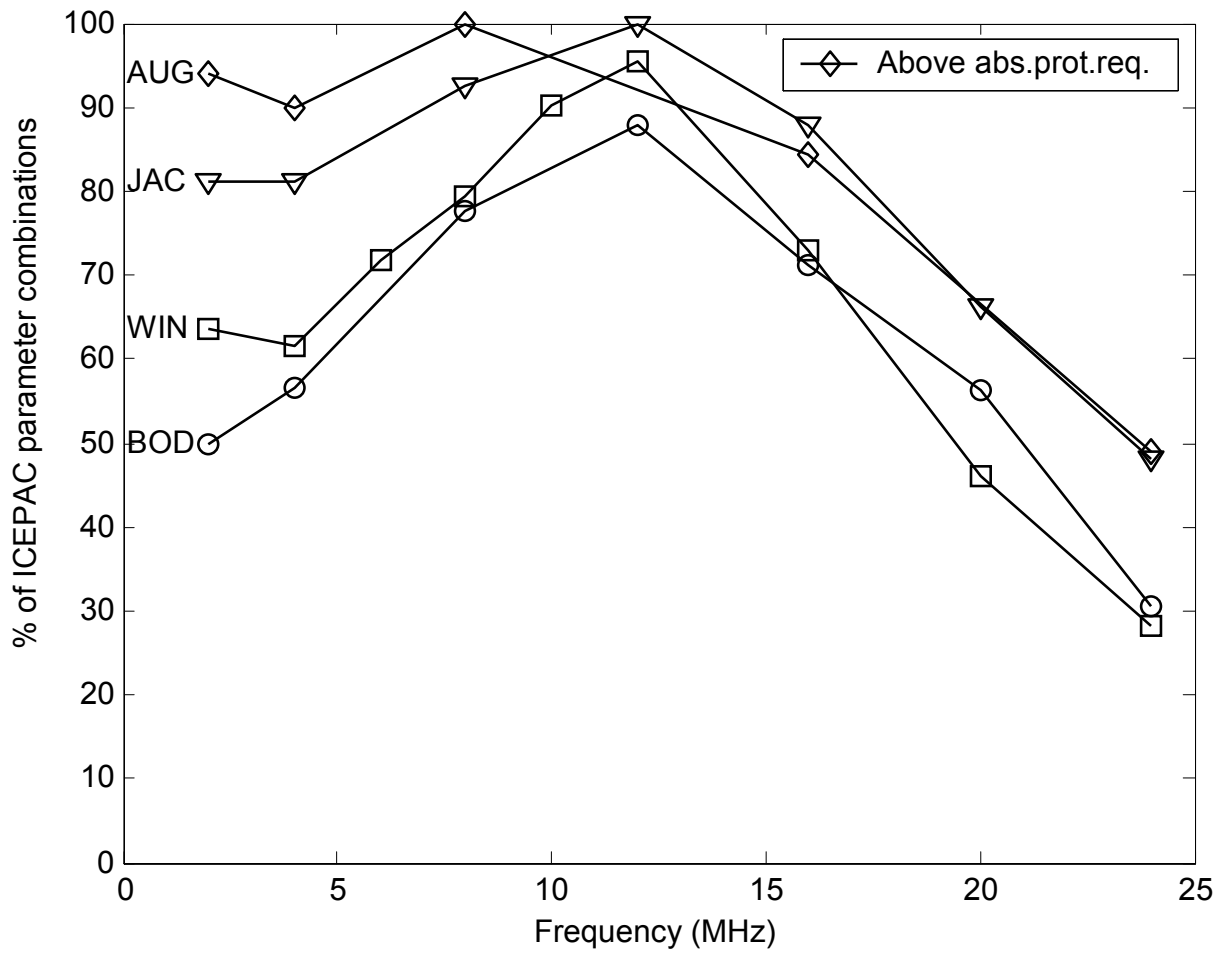

Figure 8.2.3-2: Percentage of Environmental Parameter Combinations where Estimated Cumulative PLT Noise Exceeds the Absolute Protection Requirement of Section 2.4. Different receiver locations are denoted by different markers and annotated on the left-hand side (BODø, WINnipeg, AUGsburg, JACKsonville).

For completeness, we show plots of the same type as Figure 8.2.1-1 and 8.2.2-1 also for the two last examples, Augsburg and Jacksonville where the results are in dB units. These are shown in Figures 8.2.3-3 and 8.2.3-4.

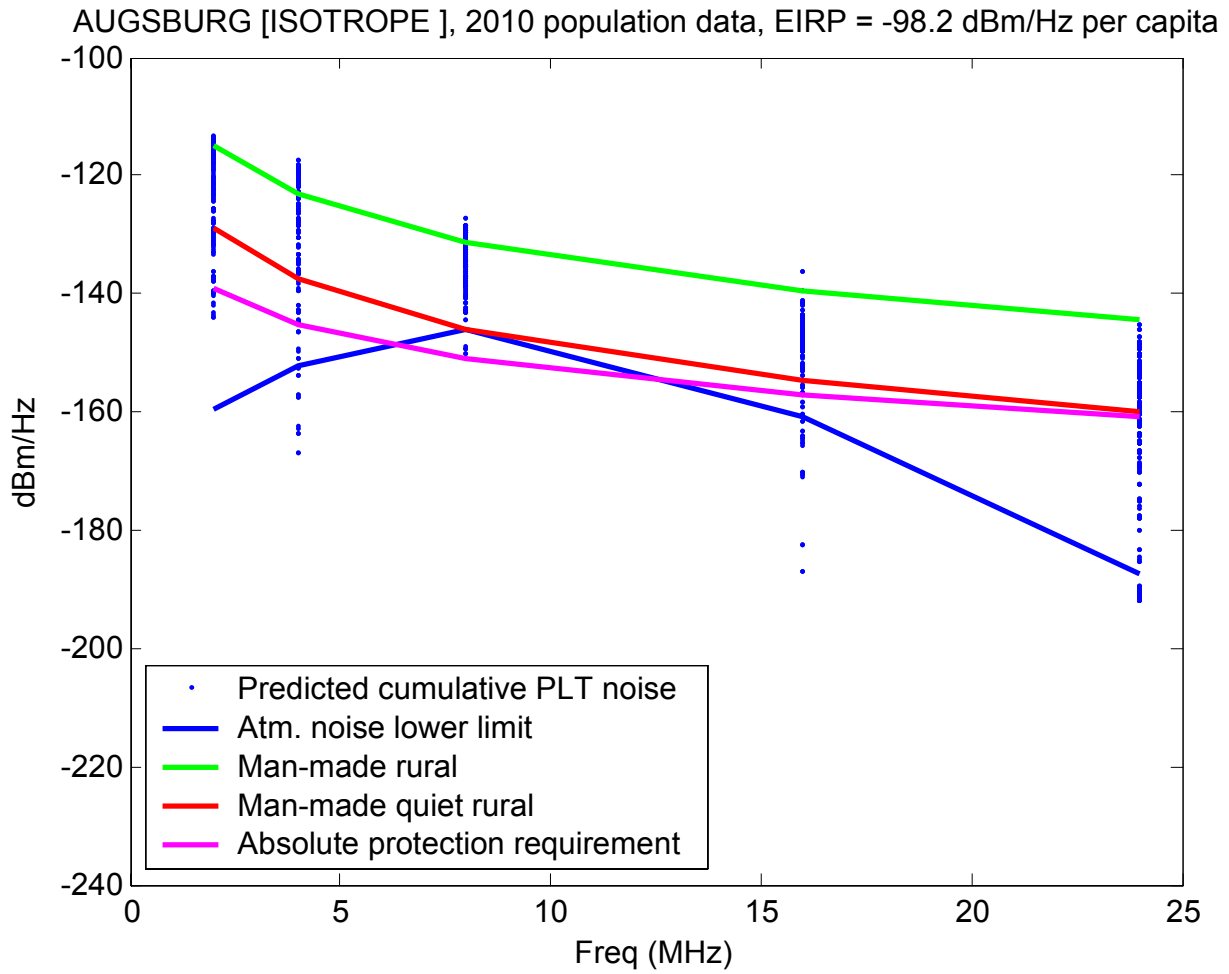

Figure 8.2.3-3: Predicted Cumulative PLT Noise Parameters, for example with Receiver in Augsburg, Compared to Established Background Noise Levels.

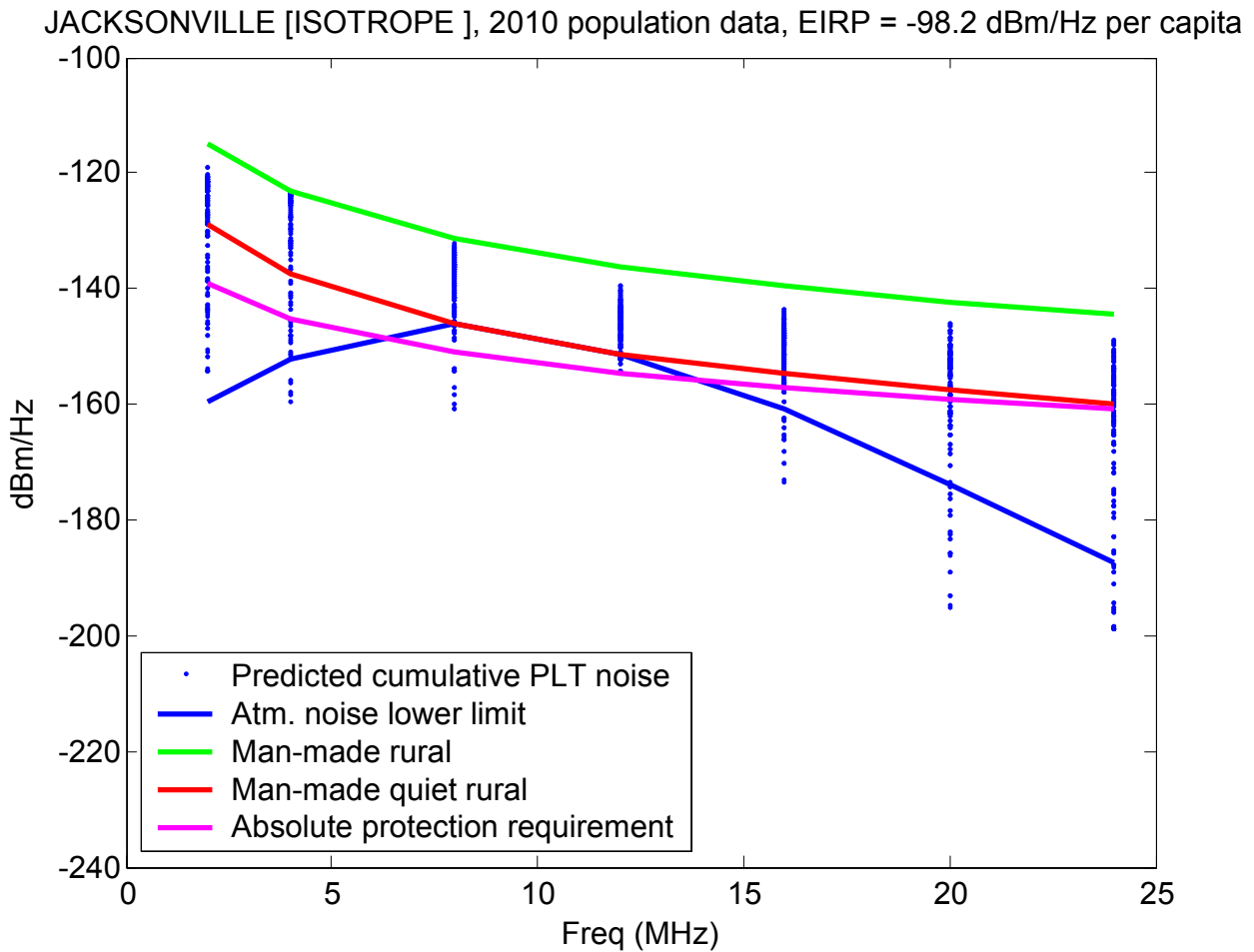

Figure 8.2.3-4: Predicted Cumulative PLT Noise Parameters, for example with Receiver in Jacksonville, Compared to Established Background Noise Levels.

Reference [101] also estimates the cumulative effect over different combinations of environmental parameters. The underlying assumptions are not directly comparable with those made above. However, both results show a similarity in that, the predicted cumulative PLT noise level for some of the parameter combinations are predicted to be above and some below the background noise level.

8.3 CUMULATIVE EFFECTS BY GROUND WAVE

The Task Group has not investigated cumulative effects of PLT by ground wave, but notes that other authors have found a protection region of 1500 m around sensitive receiver sites being sufficient in this regard [100].

8.4 CURRENT PLT MARKET PENETRATION INFORMATION

Market information is generally difficult to obtain access to and hard to predict into the future, since vendors do not disseminate this information readily, and the technology is still in development.

An attempt to predict the market development for PLT is given in [38], which predicts that by 2010 there will be between 2.5 and 5 million Access PLT (BPL) subscribers in USA. This corresponds to a market penetration of 0.9 – 1.7 % of the population.

In Germany, the number of HomePlug devices “on the market” in February 2005 was 300000, and in February 2006 it was 800000 [77]. This information was given to the Task Group from the German BITKOM (industry) via the German Ministry of Commerce. The population in Germany is 82 million, thus the HomePlug market penetration as of February 2006 is 0.01 modems per capita.

As of April 2006, Intellon had sold 10 million HomePlug chipsets worldwide and shipped 5 million of those [78]. Intellon is one of the three major vendors of PLT chipsets; the other two are DS2 and Panasonic.



Chapter 9 – CONCLUSIONS AND RECOMMENDATIONS

Over its mandated three-year work programme, the RTG accomplished the specified tasks with diligence, dedication, professionalism and competence. In many areas, it investigated and produced a product that exceeded specific requirements.

Naturally, a work of this complexity cannot be reduced to a few simple point-form highlights. The entire Report ought to be consulted for full benefit.

In the following paragraphs, a few salient findings are presented.

9.1 CONCLUSIONS

- a) The cumulative noise field strength due to the PLT emissions may have a possible detrimental effect upon military HF radio communications and COMINT systems. This is particularly the case if In-House PLT systems should become widely popular. However, it should be noted here that the determination of the nature and the severity of any possible detrimental effect upon the military systems was outside the RTG's expertise and ToR.
- b) The HF noise level in the vicinity of PLT installations has been considered in numerous other studies. One study concludes that interference from PLT to a station receiving low-level signals is likely at distances up to 460 m from a single Access PLT installation using overhead power lines. On the other hand, in sensitive receiver sites, the user generally can be assumed to have control over the vicinities, such that a protection radius of up to 1 km, without PLT installations, can be employed. In this case, the cumulative effect of long-distance propagation from a large number of PLT installations may be a more serious problem that requires careful consideration. Therefore, the RTG chose to focus on this less-studied problem.
- c) PLT rather than xDSL will cause the most problems regarding HF interference because:
 - PLT devices and the power lines that carry PLT signals have the potential to act as unintentional radiators. The amount of radiation depends on the symmetry of the network at radio frequencies. Symmetry is related to the difference in impedances between conductors and ground, where perfect symmetry corresponds to equal impedances. PLT lines have poorer symmetry than xDSL lines, and will also exhibit impedance discontinuities. Any impedance discontinuity in a transmission line, which may arise from a PLT coupling device, a transformer, a branch or a change in the direction of the line, may produce radiation directly or by reflections of signals forming standing waves that are radiated from the conductors. Even if the RF energy is injected into one of two or more conductors, the remaining wires generally act as parasitic radiators and, therefore, the lines can act as an array of antenna elements at certain frequencies. Radiation may come from one or more point radiators corresponding to the coupling devices, as well as one or more power lines.
 - A great number of PLT In-House systems (e.g., HomePlug) are expected to be deployed. Such products are readily available on the market and can be installed by anyone, with no verification of the quality of the installation.
 - VDSL variants covering the whole HF range are still in the definition phase. Eventual implementation of these systems has not been in sufficient numbers to raise potential interference issues, in the time frame of this RTG. The other versions of xDSL have no documented HF interference-causing problems, therefore the RTG chose to focus on PLT as a noise source.

CONCLUSIONS AND RECOMMENDATIONS

- d) ITU-R P.372-8 noise curves (based on measurements carried out in the 1970s) are still valid in Europe. Recent measurements carried out in Germany and Great Britain indicated that there is no remarkable difference between these measurements, specifically no increase of the ambient noise in quiet rural zones within the last 30 years.
- e) Based on these measurement results, the cumulative interference field strengths far away from telecommunication networks should not be higher than **-15 dB μ V/m** (9 kHz bandwidth) across the entire HF-range, if no measurable increase in minimum noise levels is to be tolerated. The RTG refers to this criterion as the **Absolute Protection Requirement**. It should be noted that this value is in the range of 10 to 1 dB below the ITU-R P.372-8 Quiet Rural noise curve, which are median values, across the HF band.
- f) A survey of available information indicated that OFDM is the modulation of choice for PLT and xDSL systems.
- g) Similarly, from the same sources, the maximum injected PSD is given as -50 dBm/Hz for PLT.
- h) On the subject of emission limits, FCC in the U.S.A. updated CFR 47 Part 15 Rules to address Access BPL systems. In Europe, the work is still on-going, and in the interim, for cases involving complaints, NB30 is to be used.
- i) The quantity of interest when considering cumulative effects in the far-field is the EIRP (equivalent (or effective) isotropic radiated power) per unit bandwidth caused by each signal source, in units of dBm/Hz, at different frequencies. The radiation pattern might also be of interest in some cases, but when summing up many different sources with different wiring geometries over a wide area, it is reasonable to approximate the average radiation pattern as isotropic (in elevation as well as in azimuth).
- j) Cumulative PLT noise simulations were carried out at several hypothetical sensitive receiver locations, using the Cumulative PLT Tool developed by the RTG. For each receiver location and frequency, the percentage of parameter combinations was computed where the estimated PLT noise level is above the quiet rural level, above quiet rural +6 dB, and above the rural noise level (all these noise curves represent median values, and the cumulative PLT noise levels are estimated from median propagation loss per parameter combination). The results indicated the following:
- High probability of PLT to cause increased noise levels at sensitive receiver sites given the projected market penetration.
 - It should be kept in mind that the percentages are highly influenced by assumptions on transmitter EIRP, PLT market penetration and duty cycle.

The percentage of parameter combinations was also computed where the estimated PLT noise level is above the Absolute Protection Requirement. Again, the probability of the cumulative effect of PLT exceeding the Absolute Protection Requirement is predicted to be relatively large for all frequencies and receiver locations simulated.

9.2 RECOMMENDATIONS

- a) Absolute Protection Requirement outlined in Section 2.4: Should NATO decide that no increase in minimum noise levels are to be tolerated, then the application of this criterion is recommended by the RTG (Note that ITU-R P.372-8 noise curves are for median values, while this requirement reflects minimum values).
- b) From the RTG's perspective, it is highly desirable that the regulatory limits on PLT emissions be harmonised throughout the NATO countries, for the following reasons:

- Emissions from wire-line communications travel long distances and past international boundaries, therefore, differences in emission limits introduce additional difficulties to the interference assessment and mitigation functions.
- Different emission levels, thus different PLT-induced increases in ambient noise levels, have the potential to affect interoperability within NATO:
 - Directly in the immediate vicinity of the wire-lines; as well as
 - Far away from mass-deployed telecommunication networks by cumulative interference.
- Therefore it is necessary to find worldwide harmonized standards covering EMC aspects of wire-line telecommunication networks including their in-house extensions. These standards should ensure that broadband wire-line telecommunications will not degrade HF radio reception.

The RTG recognizes that NATO, by itself, has no regulatory authority over the emission limits. Therefore, it is recommended that NATO seek the implementation of the above-mentioned goal by working together with the national and international regulatory authorities.

- c) Measurement techniques presented in Chapter 5 be considered the most appropriate procedure whenever measurement of PLT emissions is found necessary.
- d) For propagation prediction requirements, RTG recommends the use of ICEPAC for sky wave propagation prediction with parameter settings as described in Section 6.2.3, and the use of GRWAVE (augmented by Millington's method when necessary) for ground wave propagation prediction.
- e) The antenna gain of a wire-line transmission system is defined as the ratio between EIRP and injected power. Based on a comprehensive review of the available information, the RTG recommends the following values:
 - -30 dBi for In-House systems;
 - -15 dBi for overhead Access systems; and
 - -50 dBi for underground Access systems.

It should be recognized that there are uncertainties in these numbers of the order of ± 5 to ± 10 dB due to statistical spread. Furthermore, in the case of overhead Access system power lines, at resonant frequencies the antenna gain may be higher by 10 to 13 dB.

- f) CMRR/LCL values are generally measured as the ratio between the DM and CM voltages *at the injection point*. This may not be a representative measurement with respect to radiation, since impedance mismatches and standing waves can cause large variations in the CM current along the line.
- g) For measurement of radiation caused by impedance discontinuities occurring with In-House systems, the RTG recommends the use of a magnetic loop antenna and the EIRP obtained from the electric field expression (7-2).
- h) In modelling the emissions from an overhead Access PLT line, the PLT wires can be modelled as a successive set of dipoles, assuming that the standing waves present are the dominant emission source. As to the dipole type, both half-wavelength and one-wavelength dipoles are suitable; however, the half-wavelength has the wider half-power beamwidth (78 degrees vs. 48 degrees), therefore it is preferable (the wider the beamwidth, the smoother the pattern overlap). The RTG recommends the following:
 - Given the PLT geometry, the cylindrical coordinate system is more practical rather than the spherical coordinate system generally used in electromagnetics.

CONCLUSIONS AND RECOMMENDATIONS

- In the vicinity of a PLT, up to 200 metres, the use of the expression for the exact solution of a dipole, which is valid at any distance in both near-field and far-field.
 - Again, in the vicinity of the PLT, the proper determination of the conversion factor with distance requires that the reflected field from the ground be also taken into consideration. The two-ray method using the exact solution expression is the best technique for such an assessment.
 - Beyond 200 metres, the single-ray technique using the far-field approximation expression is suitable.
- i) In the computation of cumulative effects of PLT transmissions, the RTG recommends that these be computed always using a source defined in terms of EIRP rather than in terms of electric field strength. The EIRP values, if not available, could be obtained from the electric field strength calculated with the appropriate expression (exact or far-field) of the selected PLT dipole model.
- j) The distance conversion factor is a composite of the results obtained from two-ray (PLT vicinity) and single-ray (further away) techniques. The RTG recommends the distance conversion factors listed in Table 7.4.3.1-6.
- k) A direct comparison of measured and theoretical results for distance conversion factor is not recommended due to the many uncertainties involved in the various measurement techniques, instruments, positional (locational) variables, and so on. Nevertheless, it is observed that both sets of results show a commonality of values, and similar variation with frequency and distance.
- l) In the assessment/prediction of PLT cumulative noise level by sky wave at a particular receiver site of interest (sensitive or otherwise), the RTG strongly recommends the use of the Cumulative PLT Tool (CPT) developed in the course of its work.
- m) Recognizing that certain improvements to the CPT would provide more user flexibility and ease of use, the RTG recommends that the proposed CPT improvements listed in the Report be followed through by NATO.
- n) RTA is urged to consider forming a further RTG to deal with the VDSL impact on HF spectrum, if this is found necessary.

Chapter 10 – REFERENCES

- [1] NATO AC/322(SC/6)L/125, Annex 2.
- [2] ERC Report 107: Current and Future Use of Frequencies in the LF-, MF- and HF-Bands; Interlaken, 2001.
- [3] ECC Report 24: PLT, DSL, Cable Communications (including cable TV), LANS and their effect on radio services; Cavtat, May 2003.
- [4] UK Radiocommunications Agency Technical Working Group (TWG(07)09rev4): Compatibility of VDSL&PLT with Radio Services in the Range 1.6 MHz to 30 MHz; Final Report, October 2002.
- [5] US And International Tables of Frequency Allocations (Rev.9/95); <http://www.csgnetwork.com/internatfreqtable.html>.
- [6] International Telecommunication Union, CCIR-Report 258-5: Man-made Radio Noise. Study Programme 29C/6, 1990.
- [7] K. Dostert and F. Weinmann: Universität Karlsruhe, Institut für Industrielle Informationstechnik: Ermittlung der Störwirkung von PLC im Fernfeld, 01.07.2002 – 30.06.2003; Investigation of the Interference Potential of PLC in the Far Field: Additional Studies for Verification of Results Obtained on Theoretical and Simulative Basis – Abstract of the Final Report, <http://www.bmwi.de/BMWi/Redaktion/PDF/B/br-plc-studie-enderbericht-english,property=pdf,bereich=bmwi,sprache=de,rwb=true.pdf>.
- [8] European Commission: Standardisation Mandate addressed to CEN, CENELEC and ETSI concerning electromagnetic compatibility (EMC), Telecommunications Networks; M/313, 07.08.2001.
- [9] ETSI/ERMEMC-JWG(03)09_08: Electromagnetic Compatibility (EMC) – Product family emission standard for telecommunication networks, 30 May 2003, Document for Discussion.
- [10] CENELEC: CLC/prTS 50437 – Technical Specification “Electromagnetic emissions from access powerline communications networks”, Final Draft for vote, April 2004.
- [11] CENELEC: CLC/prTS 50217 – Technical Specification “Guide for in situ measurements – In situ measurement of disturbance emission”, Final Draft for vote, April 2004.
- [12] Regulatory Authority for Telecommunications and Posts, Bonn: Reg TP 322 MV 05 Part 1 – Specification for the Measurement of Disturbance Fields from Telecommunications Systems and Networks in the Frequency Range 9 kHz to 3 GHz. For application in accordance with paragraph (1) of Usage Provision No 30 (NB 30) as in the Frequency Band Allocation Ordinance (FreqBZPV) Part B: Usage Provisions; Issue October 2001, Reference Number: 501 322 005-2.
- [13] K.S. Kho: “Protection requirements for military HF radio services based on a generic sharing criteria for HF systems”, Proc. IEEE Int. Symp. On: Electromagnetic Compatibility, EMC 2003, May 2003.
- [14] U.S. Department of Commerce, National Telecommunications and Information Administration: NTIA Report 04-413, Potential Interference from Broadband over Power Line (BPL) Systems to Federal Government Radiocommunications at 1.7 – 80 MHz, April 2004.

REFERENCES

- [15] ITU-Radiocommunication Study Groups – Document 1C/TEMP/18-E, Working Party 1C, Preliminary Draft New Recommendation, Question ITU-R 218/1: Techniques for measurement of radiation from high data rate telecommunication systems using electricity power supply or telephone distribution, 22 July 2002.
- [16] Rec. ITU-T G.992.3: “Asymmetric digital subscriber line transceivers 2 (ADSL2)”.
- [17] Rec. ITU-T G.992.5: “Asymmetrical Digital Subscriber Line (ADSL) transceivers-Extended bandwidth ADSL2 (ADSL2+)”.
- [18] American National Standard ANSI T1.424: “Very-high-bit-rate Digital Subscriber Lines (VDSL) Metallic Interface”.
- [19] FFI/RAPPORT-2003/02353: “Romvær – informasjon fra Internet til nytte for operative HF-brukere”, Bjørn Jacobsen, Vivianne Jodalen, and Bodil Farsund, Norwegian Defence Research Establishment. Information and links also available online at <http://www.mil.no/felles/ffi/hf/start/prediksjon/program/>. In Norwegian.
- [20] Rec. ITU-R P.533: “HF propagation prediction method”.
- [21] FFI/PUBLICATION-96/01107: “A study of observed and predicted HF propagation characteristics at high latitudes”, Vivianne Jodalen, Norwegian Defence Research Establishment.
- [22] Telecommunication Journal Vol.42 III/1975: “Some graphical considerations on Millington’s method for calculating field strength over inhomogenous earth”, Knut N. Stokke.
- [23] FOA-R Scientific report: “Detvag-90 – Final Report”, Borje Asp, Gunnar Eriksson and Peter Holm.
- [24] NTIA Report 82-114: “HF ground wave propagation over forested and built-up terrain”, D.A. Hill, December 1982.
- [25] ITU-R Report 879-1: “Methods for estimating effective electrical characteristics of the surface of the Earth”, 1990.
- [26] Cahier Technique Merlin Gerin n° 173: Earthing systems worldwide and evolutions, E/CT 173, first issued September 1995.
- [27] Plugtek Powerline Network eLibrary, January 13 2005.
- [28] Rec. ITU-R P.832-2: “World Atlas of Ground Conductivities”, 1999.
- [29] Rotheram: “Ground-wave propagation”, Marconi rev., 1982, pp. 18-48.
- [30] Rec. ITU-R P.368-7: “Ground-wave propagation curves for frequencies between 10 kHz and 30 MHz”, 1992.
- [31] Federal Communications Commission, FCC 04-245, Report and Order: In the Matter of Amendment of Part 15 regarding new requirements and measurement guidelines for Access Broadband over Power Line Systems, ET Docket No. 04-37, Carrier Current Systems, including Broadband over Power Line Systems, ET Docket No. 03-104, Released: October 28, 2004, and Erratum, Released: November 12, 2004.
- [32] T-Systems Technologiezentrum: C. Tudziers, B. Marx, P. Muggenthaler: “Abschlussbericht zum Projekt, Störpotenzial Netze”, Version 1.3, Stand 20.02.04.

- [33] M. Gebhardt, F. Weinman, K. Dostert: “Physical and Regulatory Constraints for Communication over the Power Supply Grid”, IEEE Communications Magazine, May 2003, pp. 84-90.
- [34] K. Dostert: “Powerline Communications”, ISBN 0-13-029342-3, Prentice Hall PTR, 2001.
- [35] Frank Sjöberg: “A VDSL Tutorial”, Luleå Tekniska Universitet, Research Report 2000:02, ISSN: 1402-1528, ISRN: LTU-FR--00/02—SE.
- [36] Rochester Public Utilities (RPU): BPL trial starting in July 2004, page 4, “July 13, 2004” (<http://www.rarchams.org/bpl.htm>).
- [37] “ADSL versus VDSL – The next big thing?”, White Paper, Quick Eagle Networks, September 2005.
- [38] G. Held: “Understanding Broadband over Power Line”, Auerbach Publications, 2006.
- [39] Ofcom: “Ascom PLT Measurements in Winchester”, UK, Publication date: 11 May 2005.
- [40] Ofcom: “Amperion PLT Measurements in Crieff”, UK, Publication date: 11 May 2005; Version 2, Publication date: 20 September 2005.
- [41] Ofcom: “DS2 PLT Measurements in Crieff”, UK, Publication date: 11 May 2005.
- [42] NATO AC/322(SC/6-AHWG/1)N(2005)0013: “RF Noise Measurements in The Netherlands”, 18 May 2005.
- [43] Heavy Reading, Vol. 3, No. 5, March 2005, “Next-Generation Broadband in Europe”, executive summary: http://img.lightreading.com/heavyreading/pdf/hr20050317_esum.pdf.
- [44] CENELEC: “Draft prEN 50471 – Electromagnetic Compatibility (EMC) – Product family emission standard for wire-line telecommunication networks”, June 2005.
- [45] Official Journal of the European Union, L 93/42: “COMMISSION RECOMMENDATION of 6 April 2005 on broadband electronic communications through powerlines (2005/292/EC)”, 12.4.2005.
- [46] ITU Document 6E/254-E: “Australia – Preliminary Draft New Recommendation – Protection requirements of broadcasting systems against interference caused by wired telecommunication systems, using an electric power supply”, 19 September 2005.
- [47] M.K. Lee, R.E. Newman, H.A. Latchman, S. Katar, and L. Yonge: “HomePlug 1.0 powerline communication LANs – protocol description and performance results”, Int. J. Commun. Syst., **16**(5), June 2003, pp. 447-473.
- [48] H. Kaywan, Afkhamie, Srinivas Katar, Larry Yonge and Richard Newman: “An Overview of the upcoming HomePlug AV Standard”, Proc. 2005 Int. Symp. Power Line Communications and its applications, Victoria, BC, Canada, IEEE, April 2005, pp. 400-404.
- [49] Rec. ITU-T G.993.1: “Very high speed digital subscriber line”, 06/2004.
- [50] CENELEC/ETSI Joint Working Group on EMC of Conducted Transmission Networks: “Confirmed Minutes of the 16th Meeting of the JWG on 21 & 22 February 2006 at ETSI, Sophia Antipolis”, CLC/ETSI JWG17_TD02r1, April 2006.
- [51] OPERA Specification – Part I: Technology, version 1.0, January 2006.

REFERENCES

- [52] CENELEC/ETSI JWG(06)16_09: “PLC interference; Report about measurements concerning power line communication systems (PLC), and harmful interference caused by PLC in the HF bands 2000 – 30000 kHz.”, 16 February 2006.
- [53] M. Pollakowski: Deutsche Telekom AG: “Elektromagnetische Verträglichkeit von VDSL”, Der Fernmelde-Ingenieur, 51. Jahrgang, 3/’97
- [54] K.S. Kho: “Protection Requirements for Military HF Radio Services based on a Generic Sharing Criteria for HF Systems”, CEPT/ERC PT SE35(01)106 Rev1, Helsinki, December 2001.
- [55] J. Stott, BBC R&D: “Protection of ‘sensitive’ receiving sites”, Paper for RA Working Group on HF Mains Signalling, JHS 21 October 1999, BBC R&D 1282C(99).
- [56] M. Schneider, P. Favre and M. Rubinstein: “EMC analysis of powerline systems”, Final report, May 2004, TCOM.
- [57] “Measured Skywave Radiation Characteristics of Low Voltage Distribution Networks Excited by PLC Systems Transmitting in the HF-Band (FAFIRA Report No 2)”, OFCOM (Switzerland) and ASCOM, CEPT/ERC PT SE35(01)22, London, January 2001.
- [58] “Measured Groundwave Radiation Characteristics of Low Voltage Distribution Networks Excited by PLC Systems Transmitting in the HF-Band (FAFIRA Report No 5)”, OFCOM (Switzerland) and ASCOM, CEPT/ERC PT SE35(01)24, London, January 2001.
- [59] J.-P. van Assche and J. Coenraads: “Information on radiating properties of mains networks”, CISPR/I/WG3 Red Bank meeting, February 2003.
- [60] D.M. Lauder and Y. Sun: “Radiated emission characteristics of communication systems using unshielded cables”, EMC York 99, Conf. Publ. No. 464, IEEE, 1999.
- [61] D.W. Welsh, I.D. Flintoft and A.D. Papatsoris: “Cumulative Effect Of Radiated Emissions From Metallic Data Distribution Systems On Radio Based Services”, York EMC services, Doc. No. R/00/026, Deliverable AY3525 for Radiocommunications Agency, May 2000.
- [62] JWG17_TD03_Draft CoP, Technical Report: “Broadband Electronic Communications through Powerlines: A Code of Practice Relating to the Standardisation of the Measurement of Emission, Data Collection and Reporting of Results”, Draft ETSI TR 102552 V0.0.3 (2004-mm), October 2006.
- [63] M. Zwingl and W. Reuter: “Proposed Notching Concept for PLC”, Austrian Amateur Radio Association / T-Systems, Deutsche Telekom Group Spectrum Management, 21 March 2006.
- [64] B. Wirth: “Regulation of PLC in Europe – The structure of European Telecommunications Regulation in general and PLC specific aspects”, 2006 IEEE ISPLC, March 26-29 2006, Orlando, Florida.
- [65] Mosshamer and Dunker: “Störfeldstärkeuntersuchungen an Zweidrahtleitungen und Netzen bis 30 MHz”, Berlin, October 2003.
- [66] “Draft minutes of the seventh SE35 meeting”, December 2001, CEPT/ERC PT SE35(01)144rev1.
- [67] “PowerLine Telecommunications (PLT); LCL review and statistical analysis”, ETSI TR 102 258 v1.1.1, 2003.

- [68] "PowerLine Telecommunications (PLT); EMI review and statistical analysis", ETSI TR 102 259 v1.1.1, 2003.
- [69] J. Schuurmans, TNO: "Report of injected common mode current measurements and field strength measurements in a mains supply network", JWG_11(04)_07, May 2004.
- [70] Ralf Vick: "Estimating the radiated emissions of domestic main wiring caused by power-line communication systems", February 2003 EMC Zürich Conference, pp. 87-92.
- [71] Diethard Hansen: "Review of EMC mains aspects in fast PLC including some history", Proc. IEEE Int. Symp. on Electromagnetic Compatibility, EMC 2003, pp. 184-192, May 2003.
- [72] Center for International Earth Science Information Network (CIESIN), Columbia University; and Centro Internacional de Agricultura Tropical (CIAT). 2005. Gridded Population of the World Version 3 (GPWv3): Population Grids. Palisades, NY: Socioeconomic Data and Applications Center (SEDAC), Columbia University. Available at <http://sedac.ciesin.columbia.edu/gpw>.
- [73] Ming Zhang and Wilfred Lauber: "Evaluation of the interference potential of PLC systems", Proc. IEEE Int. Symp. on Power Line Communications and its applications, ISPLC 2006, Orlando, FL, USA, pp. 296-301, March 2006.
- [74] Andreas Bluschke: "Zukunft der Breitbandkommunikation", NET 4/06, pp.45-47.
- [75] Naresh Kurada: "Technological Advances in DSL", IEEE Canadian Review, Fall 2005, pp. 6-8.
- [76] BPL Today, March 27, 2006, pp. 7-8.
- [77] BITKOM-Informationen zu Anwendungen der Powerline-Technologie, Stand März 2006.
- [78] BPL Today, April 11, 2006, p. 3.
- [79] Koos Fockens, VERON EMC Committee: "PLC Measurements", Date: 5/7/2002, The radio amateur and the effects of the use of the 230 Volt power line for broadband data communication (PLC).
- [80] Rec. ITU-R P.527-3: "Electrical Characteristics of the Surface of the Earth", 1992.
- [81] C.A. Balanis: "Antenna Theory-Analysis and Design", First Edition, Harper & Row, Publishers, New York, 1982.
- [82] E.C. Jordan: "Electromagnetic Waves and Radiating Systems", First Edition, Constable and Company, Ltd., London, 1953.
- [83] E.C. Jordan and K.G. Balmain: "Electromagnetic Waves and Radiating Systems", Second Edition, Prentice-Hall, Inc., 1968.
- [84] F. Weinmann and K. Dostert: "Cumulative effect of power line communication installations in the far field", Proc. Int. Wroclaw Symp. and Exh. on Electromagnetic Compatibility, EMC 2002.
- [85] International Telecommunication Union, CCIR-Report 322-2: Characteristics and Applications of Atmospheric Radio Noise Data; Geneva, 1983.
- [86] International Telecommunication Union, Recommendation ITU-R P.372-8: Radio noise, 2003.

REFERENCES

- [87] International Journal of Electronics and Communications (AEÜ) 60 (2006) 208-216: “Verification of background noise in the short wave frequency range according to recommendation ITU-R p. 372”, F. Weinmann, K. Dostert, www.elsevier.de/aeue.
- [88] Bundesgesetzblatt Jahrgang 2004 Teil I Nr. 53, ausgegeben zu Bonn am 6. Oktober 2004: “Frequenzbereichszuweisungsplanverordnung (FreqBZPV) Vom 28. September 2004”, Teil B (Nutzungsbestimmungen), 30; pp. 2550-2551.
- [89] D. Welsh, A.D. Papatsoris, I.D. Flintoft and A.C. Marvin: “Investigation of the likely increases in established radio noise floor due to widespread deployment of PLT, ADSL and VDSL broadband access technologies”, 14th International Zurich Symposium and Technical Exhibition on EMC, Zurich, pp. 595-600, 20-22 February 2001.
- [90] FCC Part 15 regulations, updates and changes adopted and released by the Commission as of February 16, 2006.
- [91] CISPR/I/186/DC: “PT PLT: Limits and method of measurement of broadband telecommunication equipment over power lines”, 2006-03-17, International Electrotechnical Commission (IEC).
- [92] ETSI: “Draft ETSI EN 302 262 V1.1.1 (2005-2007) – Electromagnetic compatibility and Radio spectrum Matters (ERM); Product family emission standard for wire-line telecommunication networks”.
- [93] Rec. ITU-T G.993.2: “Very high speed digital subscriber line transceivers 2 (VDSL2)”, 02/2006.
- [94] Ed Hare: “Measurements and Calculations of BPL Emissions”, IEEE Int. Symp. On Electromagnetic Compatibility, EMC 2005, August 2005.
- [95] ETSI TR 102 175 V1.1.1 (2003-03), Technical Report: “Power Line Telecommunications (PLT): Channel characterization and measurement methods”.
- [96] G. Vos and J. Verpoorte: “Electromagnetic modeling of power line communications: Computation of the electric and magnetic fields radiated by power distribution networks”, NLR-CR-2-3-125, National Aerospace Laboratory NLR.
- [97] P. Amirshahi and M. Kavehrad: “Medium Voltage Overhead power-line broadband communications; Transmission capacity and electromagnetic interference”, Proc. 2005 Int. Symp. on Power Line Systems and Its Applications, pp. 2-6.
- [98] Robert G. Olsen: “Technical Overview of Broadband Powerline (BPL) Communication Systems”, IEEE Int. Symp. On Electromagnetic Compatibility, EMC 2005, August 2005.
- [99] Ed Hare: “EMC Factors Applicable to Broadband Over Power Line Systems”, IEEE Int. Symp. on Electromagnetic Compatibility, EMC 2005, August 2005.
- [100] Paul A. Brown and David Fenton: “Some Practical Measurements of Far Field Radiated Emissions from a PLT Cell and an Estimation of the Cumulative Ground-Wave Effects of PLT Deployment on a Sensitive HF Surveillance Site protected by a Non-Deployment Area of Radius 1500m”, CEPT/ERC PT SE35(01)117rev1, February 2002, White Box Solutions.
- [101] Hanspeter Widmer: “On The Global EMC Aspect of Broadband Power Line Communications Using the “HF” Frequency Band”, Proc. 2000 Int. Zurich Seminar on Broadband Communications, Zurich, Switzerland, February 2000, pp. 179-184.

Annex A – IST-050 RTG TAP

ACTIVITY	IST-050	HF INTERFERENCE, PROCEDURES AND TOOLS											2003		
Activity REF. Number	RTG-022												April 2003		
PRINCIPAL MILITARY REQUIREMENTS	1	2	3	4	5	6				UU	December 2006				
MILITARY FUNCTIONS	1	2	3				7				11	12	13	14	
PANEL AND COORDINATION	IST (Information Systems Technology)														
LOCATION AND DATES	01 Mtg: RTA Paris (FRA), 29-31 March 2004 02 Mtg: Kjeller (NOR), 23-26 August 2004 03 Mtg: Wachtberg (DEU), 18-21 January 2005 04 Mtg: RTA Paris (FRA), 26-29 April 2005 05 Mtg: Ottawa (CAN), 20-23 Sept. 2005 06 Mtg: Kjeller (NOR), 28 Nov. - 01 Dec. 2005 07 Mtg: Wachtberg (DEU), 13-16 March 2006 08 Mtg: Ottawa (CAN), 13-16 June 2006 09 Mtg: RTA Paris (FRA), 23-27 October 2006										P-I				
PUBLICATION DATA	TR (Final Report)						2007		200		UU				
KEYWORDS	Power Line		PLT			PLC			HF Communications						
	Digital Subscriber Line (xDSL)		COMINT			Reconnaissance			EMC						

I. BACKGROUND AND JUSTIFICATION (RELEVANCE TO NATO)

Power Line TeleCommunications (PLT, PLC) and various forms of Digital Subscriber Line (xDSL) transmissions are recent and rapidly evolving technologies using the existing electricity power or telephone lines for data transmission with rates higher than 1 MBit/s. As these lines were not designed for transmission of high data rates, they will produce noiselike interferences in the HF-range. The intensity depends on the electrical characteristics of the lines (balance, match, screening) as well as on the density and area coverage of these new systems. Exact calculations are impossible at this time because of missing models for the new wirebound communication systems with respect to emission of radio noise in HF band. First measurements and estimations show that radio noise from PLT and xDSL will bring up big problems for military HF radio communications and Communication Intelligence (COMINT) in all NATO countries. HF is still and will be further used for near (ground wave) and far (sky wave) distance communications, as its equipment is easily and rapidly deployable. It permits fully military-controlled command links across long distances with secured transmissions without additional costs and easy frequency co-ordination.

II. OBJECTIVE(S)

The objective of this task group will be to find out procedures, models and tools for being able to calculate and measure radio noise produced by PLT and xDSL systems in HF range. This will then enable NATO and its countries to determine the threat to military HF radio communications and COMINT systems by PLT and xDSL and to take the appropriate steps.

III. TOPIC TO BE COVERED

Identify the effects of PLT and xDSL systems contributing to HF radio noise.

Find out technical characteristics of PLT and xDSL systems that may be modelled as HF radio noise sources.

Establish the corresponding models including procedures and tools for determination of the technical parameters describing the HF radio noise sources (power, antenna characteristic, gain).

Determine these technical parameters theoretically and by measurement.

IV. DELIVERABLE

Technical Report.

V. TECHNICAL TEAM LEADER AND LEAD NATION

Chair: Dr. Arto CHUBUKJIAN Canada.

Lead Nation: Canada.

VI. NATIONS WILLING/INVITED TO PARTICIPATE

Canada, Georgia, Germany, Norway, Slovak Republic.

VII. NATIONAL AND/OR NATO RESOURCES NEEDED

Nations are expected to fund the travel and subsistence of the participants and to provide access to relevant national data, experimental sensors, test beds, computer models, computer time, national range facilities, etc.

Host Nations will provide meeting arrangements. No special needs are foreseen except for Internet access.

VIII. RTA RESOURCES NEEDED

Support could be asked if needed for one of two Consultants per year.

IX. ADDITIONAL INFORMATION

Liaison Members:

Dr. Malcolm R. VANT, Canada.

Limited Participation Technical Team:

No.

Annex B – IST-050 RTG TERMS OF REFERENCE

HF Interference, Procedures and Tools IST-050/RTG-022

I. ORIGIN

A. Background

Power Line TeleCommunications (PLT, PLC) and various forms of Digital Subscriber Line (DSL) transmissions are rapidly evolving technologies using the existing mains electricity or telephone wiring for telecommunications with data rates higher than 1 MBit/s. As these lines were not designed for transmission of such high data rates, they will cause unintentional RF emissions which may adversely affect the established radio noise floor directly or by cumulative propagation from many such sources. The natural background noise possibly may be increased via groundwave and/or skywave propagation, the intensity of which depends on the electrical characteristics of the lines (balance, match, screening) as well as on the density and area coverage of the new broadband data access systems. Change of the noise floor due to this effect may happen up to several thousand km distance to these new noise sources.

Exact calculations of HF radio noise emission by the new wide bandwidth lines are impossible at this time because of missing models for these transmission systems. The new Task Group will have to investigate this and to find procedures, models and tools applicable for being able to determine the influence of PLT and DSL on reception of HF radio signals.

B. Military Benefit

Increase of the natural HF noise floor by widespread use of PLC and/or DSL will bring up problems for Military Radio Users as well as for HF Communication Intelligence (COMINT) in all NATO countries. The signal-to-noise ratio thus may be reduced for tactical and strategic HF radio as well as for fixed COMINT sites. First measurements and estimations show that HF radio noise emitted by broadband cable transmissions may increase just near to the lines as well as at very great distances and thus will have an international effect.

II. OBJECTIVES

(1) Area of Research and Scope

The proposed Task Group will address itself to the HF radio emission effects of the new broadband cable transmissions. It will investigate and find means that allow calculation of field strengths of HF noise radiated by PLT or DSL. This will then enable NATO and its nations to determine the threat to military HF radio communications and COMINT systems by PLT and DSL and to take the appropriate steps.

The work will include investigations in the following areas:

- Analyze existing and planned PLT and DSL networks and their characteristics regarding HF radio noise emission.
- Investigate methods of measuring the emissions from PLT and DSL networks.
- Investigate procedures and means to model PLT and DSL systems.
- Investigate methods to verify the models found.

(2) The Specific Goals and Topics to be Covered by the Task Group

The Task Group on HF Interference, Procedures and Tools will investigate the topics defined above under “Scope” and will conduct its research according to the attached Programme of Work. After that, NATO and its nations will be able to determine degradation of its HF radio communications and COMINT systems by PLT and/or DSL and in case of that will arrange for measures to be taken.

(3) Expected End Products and/or Deliverables

The deliverable of this research programme will be a final technical report summarizing the results of the study, to be published no later than December 2006.

(4) Overall Duration of the Task Group

The proposed Task Group will be performed under a three-year review cycle starting in January 2004, complying with the policies of the RTO and will follow a schedule to be drawn up as attachment to the PoW.

III. RESOURCES**A. Membership**

Chair : Dr. Arto CHUBUKJIAN Canada.

B. Nations Willing/Invited to Participate

Canada, Georgia, Germany, Norway, Slovak Republic.

(1) Membership

This study will require broad NATO participation, with the membership ideally drawing on expertise in telecommunications, radio communications, antennas and radiowave propagation. IST Panel Members CA, GE, NO and UK have already declared their willingness to support this new Task Group. It is anticipated that additional members from other nations will participate.

(2) National and/or NATO Resources Needed

Each participating nation is expected to provide at least 2 person-years/year of effort towards the goals of this RTG, plus funds to allow their experts to travel to two RTG meetings per year. Members of the Task Group should have a suitable scientific background and be expected to devote a significant proportion of their time to supporting the goals of the Task Group. Nations are expected to fund the travel and subsistence of the participants and to provide access to relevant national data, experimental sensors, test beds, computer models, computer time, national range facilities etc.

In addition, Internet access is required for unclassified information exchange and collaborative activities. Identified RTA resources would be limited to standard support for publishing the final report. RTA support for consultants may also be requested. Support could be asked if needed for one or two Consultants per year.

IV. SECURITY CLASSIFICATION LEVEL

The security level will be Unclassified/Unlimited.

V. PARTICIPATION BY PARTNER NATIONS AND OTHER NATIONS

This Activity is open to Pfp.

VI. LIAISON

The work of the Task Group will be coordinated with other panels and activities within the RTO which deal with telecommunications, HF radio communications and/or modelling.

The work will also draw upon the “ECC report on PLT, DSL, cable communications (including cable TV), LANs and their effect on radio services” at the moment drafted by CEPT/ECC Project Team SE35 (European Postal and Telecommunications Administrations Conference/Electronic Communications Committee).

It will be useful to follow ITU-R activities related to this problem (ITU-R Study Group 1).

VII. REFERENCE

IST Exploratory Team IST-ET-050.



Annex C – IST-050 RTG PROGRAMME OF WORK

30 March 2004

NATO AC/323 IST

Task Group on HF Interference, Procedures and Tools (IST-050 / RTG-022)

1. MAJOR ITEMS OF WORK

The objectives of the Task Group are to investigate and find out procedures, models and tools for being able to calculate and measure radio noise generated by PLT and xDSL networks in the HF range. This work will consist of the following tasks:

- Task 1: Describe the effects of PLT and xDSL networks contributing to HF radio noise, and the current background noise levels.
- Task 2: Describe power line and telephone line systems in different countries, which will be used for PLT and xDSL, and their special characteristics regarding HF radio noise emission.
- Task 3: There are used different methods for PLT as well as for xDSL. Describe them from the technical point of view. Explain their different characteristics emitting HF radio noise. Identify technical realizations (manufacturer, name, type, technical data, provider, etc.).
- Task 4: Define representative PLT and xDSL systems or parts of them to be modelled as basis for the calculation and measurement of HF radio noise. Find real networks, which best fit to the representative ones.
- Task 5: Investigate methods of measuring the emissions from PLT and xDSL networks operating within the HF range. Determine the ranges for measurement of field strength close to and far from PLT and xDSL networks and the relations of the field strengths of both ranges to each other.
- Task 6: Review and recommend propagation path loss models to be used.
- Task 7: Investigate ways and means to model PLT and xDSL systems. The models should allow calculation of the electric and magnetic field strengths of HF radio noise emitted by the PLT and xDSL networks. Find tools applicable to this modelling. Determine the kind of modelling for the representative PLT and xDSL systems found in (4).
- Task 8: Establish models for the representative PLT and xDSL networks or parts of them found in (4). Calculate HF radio noise field strengths at near and far distances, using the established models.
- Task 9: Verify the models found in (8) by measuring HF radio noise field strengths using methods specified in (5), and comparing them with the field strengths calculated in (8).

2. TIME SCALE

The Task Group on *HF Interference, Procedures and Tools* will address the tasks listed above over a three-year period beginning 2004.

It is planned that three meetings per calendar year will be held at research establishments within participating nations. A final report will be provided after completion of the tasks.

3. PARTICIPATING NATIONS

Membership is sought from all NATO and PfP nations of the IST Panel. Canada, Georgia, Germany, Italy, Norway, Slovakia and United Kingdom have appointed members to the Task Group at the time of the kick-off meeting.

4. PARTICIPANTS

A complete list of participants is provided in Annex E.

Annex D – IST-050 RTG WORK SCHEDULE

Work Schedule (PoW) of IST-050 / RTG-022 on HF Interference, Procedures and Tools
27 October 2006

Activity	2004												2005												2006											
	1	2	3	4	5	6	7	8	9	10	11	12	1	2	3	4	5	6	7	8	9	10	11	12	1	2	3	4	5	6	7	8	9	10	11	12
Task 1: Radiation effects by PLT/xDSL	-----												-----												-----											
Task 2: Description of power and telephone lines in use	-----												-----												-----											
Task 3: PLT/xDSL techniques / systems	-----												-----												-----											
Task 4: Typical PLT/xDSL systems (modeling)	-----												-----												-----											
Task 5: PLT/xDSL noise measurement methods	-----												-----												-----											
Task 6: Propagation path loss models	-----												-----												-----											
Task 7: Modeling PLT/xDSL noise sources	-----												-----												-----											
Task 8: Models of typical PLT/xDSL systems	-----												-----												-----											
Final report	-----												-----												-----											



Annex E – IST-050 RTG MEMBERS

IST-050/RTG-022 HF Interference, Procedures and Tools

Research Task Group Chairman

CANADA

Dr. Arto CHUBUKJIAN
Electromagnetics and Compatibility
Communications Research Centre
P.O. Box 11490, Station H
3701 Carling Avenue
Ottawa, Ontario K2H 8S2
e-mail: Arto.Chubukjian@ieee.org
Tel: +1 613 998 2213
Fax: +1 613 998 4077

Research Task Group Members

GEORGIA

Mr. Iuri SADOEV
ToriTech LLC
Head of IT Department
17 Nutsbidze Plateau
1stMR.0183
TBLISI
e-mail: sadoev_rtc@dsl.ge
Tel: +995 99 212118
Fax: +995 32 275086

GERMANY

Mr. Joseph BENGER
Forschungsgesellschaft für Angewandte Naturwissenschaften (FGAN)
Neuenahrer Str. 20.
53343 WACHTBERG
e-mail: benger@fgan.de
Tel: +49 (228) 94 35 818
Fax: +49 (228) 85 62 77

NORWAY

Dr. Roald OTNES
Norwegian Defence Research Establishment (FFI)
PO Box 115
NO-3191 Horten
e-mail: Roald.Otnes@ffi.no
Tel: +47 33 03 39 89
Fax: +47 33 04 78 34

SLOVAKIA

LTC Ing. Miroslav DULIK
Military Academy
Telecommunications Systems Department
PO Box 46/402
031 01 Liptovský Mikuláš
e-mail: dulik@valm.sk
Tel: +421 960 42 25 30

Former Research Task Group Members

NORWAY

Mr Knut Inge HVIDSTEN (formerly with Norwegian Defence Research Establishment (FFI))

SLOVAKIA

Dr. Pavel ŠIMON (formerly with Military Technical Institute (MTI))

REPORT DOCUMENTATION PAGE																											
1. Recipient's Reference	2. Originator's References	3. Further Reference	4. Security Classification of Document																								
	RTO-TR-IST-050 AC/323(IST-050)TP/44	ISBN 978-92-837-0069-2	UNCLASSIFIED/ UNLIMITED																								
5. Originator	Research and Technology Organisation North Atlantic Treaty Organisation BP 25, F-92201 Neuilly-sur-Seine Cedex, France																										
6. Title	HF Interference, Procedures and Tools																										
7. Presented at/Sponsored by	Final Report of NATO RTO Information Systems Technology (IST) Panel Research Task Group IST-050/RTG-022 (or Research Task Group IST-050).																										
8. Author(s)/Editor(s)	Multiple		9. Date June 2007																								
10. Author's/Editor's Address	Multiple		11. Pages 176																								
12. Distribution Statement	There are no restrictions on the distribution of this document. Information about the availability of this and other RTO unclassified publications is given on the back cover.																										
13. Keywords/Descriptors	<table style="width: 100%; border: none;"> <tr> <td style="width: 33%;">Absolute protection requirement</td> <td style="width: 33%;">Electromagnetic interference</td> <td style="width: 33%;">Models</td> </tr> <tr> <td>Access</td> <td>Emissions</td> <td>Noise floor</td> </tr> <tr> <td>Ambient noise</td> <td>Ground wave</td> <td>PLC</td> </tr> <tr> <td>Cumulative effects</td> <td>HF band</td> <td>PLT</td> </tr> <tr> <td>Device penetration rate</td> <td>ICEPAC</td> <td>Radio communication</td> </tr> <tr> <td>Distance conversion factor</td> <td>In-house</td> <td>Signal-to-noise ratio</td> </tr> <tr> <td>Electromagnetic compatibility</td> <td>Measurements</td> <td>Sky wave</td> </tr> <tr> <td>Electromagnetic environments</td> <td>Modelling</td> <td>xDSL</td> </tr> </table>			Absolute protection requirement	Electromagnetic interference	Models	Access	Emissions	Noise floor	Ambient noise	Ground wave	PLC	Cumulative effects	HF band	PLT	Device penetration rate	ICEPAC	Radio communication	Distance conversion factor	In-house	Signal-to-noise ratio	Electromagnetic compatibility	Measurements	Sky wave	Electromagnetic environments	Modelling	xDSL
Absolute protection requirement	Electromagnetic interference	Models																									
Access	Emissions	Noise floor																									
Ambient noise	Ground wave	PLC																									
Cumulative effects	HF band	PLT																									
Device penetration rate	ICEPAC	Radio communication																									
Distance conversion factor	In-house	Signal-to-noise ratio																									
Electromagnetic compatibility	Measurements	Sky wave																									
Electromagnetic environments	Modelling	xDSL																									
14. Abstract	<p>This Report presents the results of the work carried out by IST-050/RTG-022, the Research Task Group (RTG) on "HF Interference, Procedures and Tools", to address the concerns raised by the potential for unintentional radio interference to be caused by the widespread operation of broadband wire-line telecommunications systems, such as PowerLine TeleCommunications (PLT, PLC) and various forms of Digital Subscriber Line (xDSL).</p> <p>Increase of the existing HF noise floor by widespread use of PLT and/or xDSL will bring up problems for Military Radio Users as well as for HF Communication Intelligence (COMINT) in all NATO countries. The signal-to-noise ratio thus may be reduced for tactical and strategic HF radio as well as for fixed sensitive COMINT sites.</p> <p>Each Chapter of the Report addresses specific topics, namely, introduction, HF radio, characteristics of PLT and xDSL systems, emission limits, measurement methods, propagation models, EMC modelling, and EMC analysis, culminating in conclusions and recommendations. The Report also provides a comprehensive list of references and a software tool (electronically available).</p> <p>Briefly, the findings of the RTG do indicate that the PLT emissions have the potential to cause appreciable degradation in the exploitation of the HF spectrum by military users.</p>																										





BP 25
F-92201 NEUILLY-SUR-SEINE CEDEX • FRANCE
Télécopie 0(1)55.61.22.99 • E-mail mailbox@rta.nato.int



DIFFUSION DES PUBLICATIONS
RTO NON CLASSIFIEES

Les publications de l'AGARD et de la RTO peuvent parfois être obtenues auprès des centres nationaux de distribution indiqués ci-dessous. Si vous souhaitez recevoir toutes les publications de la RTO, ou simplement celles qui concernent certains Panels, vous pouvez demander d'être inclus soit à titre personnel, soit au nom de votre organisation, sur la liste d'envoi.

Les publications de la RTO et de l'AGARD sont également en vente auprès des agences de vente indiquées ci-dessous.

Les demandes de documents RTO ou AGARD doivent comporter la dénomination « RTO » ou « AGARD » selon le cas, suivi du numéro de série. Des informations analogues, telles que le titre et la date de publication sont souhaitables.

Si vous souhaitez recevoir une notification électronique de la disponibilité des rapports de la RTO au fur et à mesure de leur publication, vous pouvez consulter notre site Web (www.rta.nato.int) et vous abonner à ce service.

CENTRES DE DIFFUSION NATIONAUX

ALLEMAGNE

Streitkräfteamt / Abteilung III
Fachinformationszentrum der Bundeswehr
(FIZBw)
Gorch-Fock-Straße 7, D-53229 Bonn

BELGIQUE

Royal High Institute for Defence – KHID/IRSD/RHID
Management of Scientific & Technological Research
for Defence, National RTO Coordinator
Royal Military Academy – Campus Renaissance
Renaissancelaan 30
1000 Bruxelles

CANADA

DSIGRD2 – Bibliothécaire des ressources du savoir
R et D pour la défense Canada
Ministère de la Défense nationale
305, rue Rideau, 9^e étage
Ottawa, Ontario K1A 0K2

DANEMARK

Danish Acquisition and Logistics Organization
(DALO)
Lautrupbjerg 1-5
2750 Ballerup

ESPAGNE

SDG TECEN / DGAM
C/ Arturo Soria 289
Madrid 28033

ETATS-UNIS

NASA Center for AeroSpace Information (CASI)
7115 Standard Drive
Hanover, MD 21076-1320

FRANCE

O.N.E.R.A. (ISP)
29, Avenue de la Division Leclerc
BP 72, 92322 Châtillon Cedex

GRECE (Correspondant)

Defence Industry & Research General
Directorate, Research Directorate
Fakinos Base Camp, S.T.G. 1020
Holargos, Athens

HONGRIE

Department for Scientific Analysis
Institute of Military Technology
Ministry of Defence
P O Box 26
H-1525 Budapest

ISLANDE

Director of Aviation
c/o Flugrad
Reykjavik

ITALIE

General Secretariat of Defence and
National Armaments Directorate
5th Department – Technological
Research
Via XX Settembre 123
00187 Roma

LUXEMBOURG

Voir Belgique

NORVEGE

Norwegian Defence Research
Establishment
Attn: Biblioteket
P.O. Box 25
NO-2007 Kjeller

PAYS-BAS

Royal Netherlands Military
Academy Library
P.O. Box 90.002
4800 PA Breda

POLOGNE

Centralny Ośrodek Naukowej
Informacji Wojskowej
Al. Jerozolimskie 97
00-909 Warszawa

PORTUGAL

Estado Maior da Força Aérea
SDFA – Centro de Documentação
Alfragide
P-2720 Amadora

REPUBLIQUE TCHEQUE

LOM PRAHA s. p.
o. z. VTÚLaPVO
Mladoboleslavská 944
PO Box 18
197 21 Praha 9

ROUMANIE

Romanian National Distribution
Centre
Armaments Department
9-11, Drumul Taberei Street
Sector 6
061353, Bucharest

ROYAUME-UNI

Dstl Knowledge Services
Information Centre
Building 247
Dstl Porton Down
Salisbury
Wiltshire SP4 0JQ

TURQUIE

Milli Savunma Bakanlığı (MSB)
ARGE ve Teknoloji Dairesi
Başkanlığı
06650 Bakanlıklar
Ankara

AGENCES DE VENTE

NASA Center for AeroSpace Information (CASI)

7115 Standard Drive
Hanover, MD 21076-1320
ETATS-UNIS

The British Library Document Supply Centre

Boston Spa, Wetherby
West Yorkshire LS23 7BQ
ROYAUME-UNI

Canada Institute for Scientific and Technical Information (CISTI)

National Research Council Acquisitions
Montreal Road, Building M-55
Ottawa K1A 0S2, CANADA

Les demandes de documents RTO ou AGARD doivent comporter la dénomination « RTO » ou « AGARD » selon le cas, suivie du numéro de série (par exemple AGARD-AG-315). Des informations analogues, telles que le titre et la date de publication sont souhaitables. Des références bibliographiques complètes ainsi que des résumés des publications RTO et AGARD figurent dans les journaux suivants :

Scientific and Technical Aerospace Reports (STAR)

STAR peut être consulté en ligne au localisateur de ressources uniformes (URL) suivant :

<http://www.sti.nasa.gov/Pubs/star/Star.html>

STAR est édité par CASI dans le cadre du programme NASA d'information scientifique et technique (STI)
STI Program Office, MS 157A
NASA Langley Research Center
Hampton, Virginia 23681-0001
ETATS-UNIS

Government Reports Announcements & Index (GRA&I)

publié par le National Technical Information Service
Springfield

Virginia 2216

ETATS-UNIS

(accessible également en mode interactif dans la base de données bibliographiques en ligne du NTIS, et sur CD-ROM)



BP 25

F-92201 NEUILLY-SUR-SEINE CEDEX • FRANCE
Télécopie 0(1)55.61.22.99 • E-mail mailbox@rta.nato.int



**DISTRIBUTION OF UNCLASSIFIED
RTO PUBLICATIONS**

AGARD & RTO publications are sometimes available from the National Distribution Centres listed below. If you wish to receive all RTO reports, or just those relating to one or more specific RTO Panels, they may be willing to include you (or your Organisation) in their distribution.

RTO and AGARD reports may also be purchased from the Sales Agencies listed below.

Requests for RTO or AGARD documents should include the word 'RTO' or 'AGARD', as appropriate, followed by the serial number. Collateral information such as title and publication date is desirable.

If you wish to receive electronic notification of RTO reports as they are published, please visit our website (www.rta.nato.int) from where you can register for this service.

NATIONAL DISTRIBUTION CENTRES

BELGIUM

Royal High Institute for Defence – KHID/IRSD/RHID
Management of Scientific & Technological Research
for Defence, National RTO Coordinator
Royal Military Academy – Campus Renaissance
Renaissancelaan 30
1000 Brussels

CANADA

DRDKIM2
Knowledge Resources Librarian
Defence R&D Canada
Department of National Defence
305 Rideau Street, 9th Floor
Ottawa, Ontario K1A 0K2

CZECH REPUBLIC

LOM PRAHA s. p.
o. z. VTÚLaPVO
Mladoboleslavská 944
PO Box 18
197 21 Praha 9

DENMARK

Danish Acquisition and Logistics Organization
(DALO)
Lautrupbjerg 1-5
2750 Ballerup

FRANCE

O.N.E.R.A. (ISP)
29, Avenue de la Division Leclerc
BP 72
92322 Châtillon Cedex

GERMANY

Streitkräfteamt / Abteilung III
Fachinformationszentrum der Bundeswehr
(FIZBw)
Gorch-Fock-Straße 7
D-53229 Bonn

GREECE (Point of Contact)

Defence Industry & Research
General Directorate
Research Directorate
Fakinos Base Camp
S.T.G. 1020
Holargos, Athens

HUNGARY

Department for Scientific Analysis
Institute of Military Technology
Ministry of Defence
P O Box 26
H-1525 Budapest

ICELAND

Director of Aviation
c/o Flugrad, Reykjavik

ITALY

General Secretariat of Defence and
National Armaments Directorate
5th Department – Technological
Research
Via XX Settembre 123
00187 Roma

LUXEMBOURG

See Belgium

NETHERLANDS

Royal Netherlands Military
Academy Library
P.O. Box 90.002
4800 PA Breda

NORWAY

Norwegian Defence Research
Establishment, Attn: Biblioteket
P.O. Box 25
NO-2007 Kjeller

POLAND

Centralny Ośrodek Naukowej
Informacji Wojskowej
Al. Jerozolimskie 97
00-909 Warszawa

PORTUGAL

Estado Maior da Força Aérea
SDFA – Centro de Documentação
Alfragide
P-2720 Amadora

ROMANIA

Romanian National Distribution
Centre
Armaments Department
9-11, Drumul Taberei Street
Sector 6, 061353, Bucharest

SPAIN

SDG TECEN / DGAM
C/ Arturo Soria 289
Madrid 28033

TURKEY

Milli Savunma Bakanlığı (MSB)
ARGE ve Teknoloji Dairesi
Başkanlığı
06650 Bakanlıklar – Ankara

UNITED KINGDOM

Dstl Knowledge Services
Information Centre
Building 247, Dstl Porton Down
Salisbury, Wiltshire SP4 0JQ

UNITED STATES

NASA Center for AeroSpace
Information (CASI)
7115 Standard Drive
Hanover, MD 21076-1320

SALES AGENCIES

NASA Center for AeroSpace

Information (CASI)
7115 Standard Drive
Hanover, MD 21076-1320
UNITED STATES

**The British Library Document
Supply Centre**

Boston Spa, Wetherby
West Yorkshire LS23 7BQ
UNITED KINGDOM

**Canada Institute for Scientific and
Technical Information (CISTI)**

National Research Council Acquisitions
Montreal Road, Building M-55
Ottawa K1A 0S2, CANADA

Requests for RTO or AGARD documents should include the word 'RTO' or 'AGARD', as appropriate, followed by the serial number (for example AGARD-AG-315). Collateral information such as title and publication date is desirable. Full bibliographical references and abstracts of RTO and AGARD publications are given in the following journals:

Scientific and Technical Aerospace Reports (STAR)

STAR is available on-line at the following uniform resource locator:

<http://www.sti.nasa.gov/Pubs/star/Star.html>

STAR is published by CASI for the NASA Scientific and Technical Information (STI) Program
STI Program Office, MS 157A
NASA Langley Research Center
Hampton, Virginia 23681-0001
UNITED STATES

Government Reports Announcements & Index (GRA&I)

published by the National Technical Information Service
Springfield
Virginia 2216
UNITED STATES
(also available online in the NTIS Bibliographic Database or on CD-ROM)