

EMULATOR II+ OWNERS MANUAL

By Craig Anderton



OS Version 3.1 and 3.1 HD

© 1985, 1986, 1987 E-mu Systems, Inc., Scotts Valley, CA • All Rights Reserved
Restored by the Emulator Archive • www.emulatorarchive.com

CONTENTS

CONTENTS

INTRODUCTION	11
WHAT'S AN EMULATOR II?	12
WELCOME TO THE EII+ and EII+HD	13
MANUAL RESTORATION NOTES	13
SEND IN YOUR WARRANTY CARD NOW!	14
HOW TO USE THIS MANUAL	17
DEFINITIONS: HOW THE EMULATOR II ORGANIZES SOUND	18
Sampling Basics	18
The Emulator II "Map"	19
The Bank	21
The Voice	21
The Preset	21
Voice Processing	22
The Disk Archives	23
The Keyboard	24
The Output Channels	24
Re-cap	24
Always Remember to Save Your Work	24
OTHER DEFINITIONS	25
THE GUIDED TOURS	26
HOW TO USE THE GUIDED TOURS	27
GETTING READY FOR THE GUIDED TOURS.....	27
GUIDED TOUR #1: MEET THE EMULATOR	28
DISK HANDLING.....	28
LOADING A PERFORMANCE DISK	28
SELECTING DIFFERENT PRESETS	28
THE EMULATOR II's "MODULAR" PHILOSOPHY.....	29
ACTIVATING and DE-ACTIVATING MODULES, SELECTING FUNCTIONS	30
LOADING OTHER PERFORMANCE DISKS.....	30
TUNING THE EMULATOR II TO OTHER INSTRUMENTS.....	31
TRANSPOSING THE KEYBOARD	31
FORMATTING DISKS	31
GUIDED TOUR #2: SPECIFYING THE "CURRENT VOICE"	32
BACKGROUND.....	32
IDENTIFYING WHICH KEYBOARD KEYS BELONG TO WHICH VOICE	32
GUIDED TOUR #3: THE FILTER and VCA/LFO MODULE.....	36
BACKGROUND.....	36
SPECIFYING THE CURRENT VOICE.....	36

CONTENTS

FILTER FUNCTION 1: CHANGING CUTOFF FREQUENCY, Q, and ENVELOPE	36
FILTER FUNCTION 2: LFO AMOUNT AND KEYBOARD TRACKING	37
FILTER FUNCTION 3: ADSR SETTINGS	37
VCA/LFO FUNCTION 1: ADSR SETTINGS	38
VCA/LFO FUNCTION 2: LFO SETTINGS	38
GUIDED TOUR #4: REAL TIME CONTROL and VIBRATO DEPTH.....	39
BACKGROUND.....	39
SELECTING A CONTROL SOURCE and CONTROL DESTINATION	40
REAL TIME FUNCTIONS	40
PROGRAMMING VIBRATO DEPTH	41
GUIDED TOUR #5: THE DYNAMIC KEYBOARD.....	42
BACKGROUND.....	42
ASSIGNING KEYBOARD VELOCITY TO DYNAMICS	42
GUIDED TOUR #6: BASIC SAMPLING.....	43
SETUP.....	43
GUIDED TOUR #7: DIGITALLY PROCESSING SAMPLES	45
PLAYING A VOICE BACKWARDS	46
TRUNCATING A VOICE	46
LOOPING A VOICE.....	47
SPLICING VOICES	47
COMBINING VOICES.....	47
SAVING VOICES	47
GUIDED TOUR #8: OTHER VOICE DEFINITION FUNCTIONS	48
CHECKING SOUND LENGTH.....	48
SOLO MODE.....	48
VOICE ATTENUATION AND TUNING	48
CONTROL ENABLE.....	48
GUIDED TOUR #9: MANAGING THE BANK	49
WHAT'S IN THE BANK?	49
COPYING AND ERASING WITHIN THE BANK.....	49
GUIDED TOUR #10: CREATING PRESETS and LIBRARY DISKS.....	50
GENERAL INSTRUCTIONS.....	51
1 - SELECTING THE CURRENT PRESET	52
2 - ASSIGNING THE CURRENT VOICE.....	53
3 - EXITING A FUNCTION	55
4 - LIBRARY DISK VOICE NUMBERING PROTOCOL.....	55
5 - DISK HANDLING.....	56
Common Courtesy for Disks	56
Disk Type.....	56
The Disk Drive.....	56

CONTENTS

Labeling Disks	56
Write-Protecting Disks	57
Single-drive vs. Dual-drive Emulator II's.....	58
Inserting the Disk in the Drive	58
Always have a Disk in the Top Drive!.....	58
6 - SELECTING REAL TIME CONTROL FUNCTIONS.....	59
7 - CATALOGUING.....	60
8 - KEYBOARD NUMBERING PROTOCOL.....	61
MASTER CONTROL MODULE.....	62
DYNAMIC ALLOCATION	63
TUNE	63
TRANSPOSE.....	64
DOUBLE MEMORY	65
DOUBLE MEMORY HARD DISK SAVES.....	66
FILTER MODULE.....	67
0 - CHANGE CURRENT VOICE	68
1 - FREQUENCY, Q, ENVELOPE AMOUNT	68
2 - LFO AMOUNT, KEYBOARD AMOUNT.....	69
3 - ADSR SETTINGS	70
LFO/VCA MODULE.....	71
0 - CHANGE CURRENT VOICE	72
1 - ADSR SETTINGS	72
2 - LFO PARAMETERS AND VCA AMOUNT.....	73
VOICE DEFINITION MODULE	74
00 - CHANGE CURRENT VOICE	75
11 - TRUNCATE START and END of SAMPLE	76
12 - SET LOOP START and LOOP LENGTH POINTS.....	80
About Autolooping	83

CONTENTS

13 - FORWARD/REVERSE LOOP	87
14 - SPLICE	89
About Autosplicing.....	91
15 - SOUND LENGTH.....	93
21 - VELOCITY ASSIGNMENT TO LEVEL and ATTACK.....	94
22 - VELOCITY ASSIGNMENT TO FILTER.....	96
23 - VIBRATO DEPTH	98
24 - VOICE ATTENUATE/TUNE	98
25 - SOLO MODE	99
26 - LOOP IN RELEASE.....	99
27 - BACKWARDS MODE.....	100
28 - COMBINE VOICES.....	101
28 - COMBINE VOICES.....	102
29 - CONTROL ENABLE.....	103
30 - SAVE VOICE TO DISK.....	104
PRESET DEFINITION MODULE	105
11 - GET VOICE.....	106
12 - COPY/NAME VOICE.....	107
13 - ERASE VOICE.....	108
14 - ERASE SEQUENCE.....	109
15 - ERASE PRESET.....	110
16 - ERASE BANK.....	111
17 - CATALOG VOICES	111
18 - CATALOG SEQUENCES	112
19 - CATALOG PRESETS.....	112
20 - MEMORY REMAINING.....	113

CONTENTS

21 - CREATE PRESET	114
22 - ASSIGN VOICE	115
23 - EDIT ASSIGNMENT	117
24 - DE-ASSIGN VOICE	119
25 - VELOCITY SWITCH	120
26 - VELOCITY CROSSFADE	121
27 - POSITIONAL CROSSFADE	122
28 - NONTRANSPOSE	123
29 - ARPEGGIATOR.....	124
30 - MIDI SETUP	126
31 - COPY/RENAME PRESET.....	130
32 - REPLICATE PRESET.....	131
SAMPLE MODULE.....	132
1 - VU MODE	133
2 - DEFINE VOICE	133
3 - GAIN SET	135
4 - THRESHOLD SET	135
5 - SAMPLE LENGTH.....	136
7 - ARM SAMPLING	136
9 - FORCE SAMPLING	137
0 - STOP SAMPLING.....	137
DISK MODULE	138
1 - GET BANK DISK 1	139
2 - GET BANK DISK 2	140
3 - SPACE REMAINING.....	141
3 - DISK IDENTITY	142

CONTENTS

4 - COPY DISK	142
5 - CATALOG VOICE.....	144
6 - ERASE VOICE.....	144
7 - SAVE BANK	146
8 - FORMATTING A PERFORMANCE OR LIBRARY DISKETTE	147
HARD DISK SUPPLEMENT	149
BACKGROUND : WHY HARD DISKS.....	150
THE HARD DISK PERSONALITY	150
POWER-ON WITH HARD DISK MODEL.....	151
HARD DISK SECTION NOTES.....	151
DISK 2 - GETTING A BANK FROM HARD DISK	152
DISK 7 - SAVING A BANK TO HARD DISK.....	153
DISK 8 - FORMATTING FLOPPIES IN A HARD DISK SYSTEM.....	154
HARD DISK SPECIAL FUNCTIONS.....	155
SPECIAL 22 - FORMATTING	155
Important Note: Errors.....	157
SPECIAL 21 - SHOW HARD DISK ERROR LOCATION	158
SPECIAL 20 - ERROR SCAN	159
SPECIAL 19 - ENTER ERROR LIST	160
SPECIAL 18 - AUTO HARD DISK BACKUP	161
SPECIAL 17 - COPY HARD DISK SOFTWARE	161
REALTIME CONTROL MODULE.....	162
CONTROL 0 - Destination: OFF	163
CONTROL 1 - Destination: PITCH.....	163
CONTROL 2 - Destination: FILTER Fc.....	163
CONTROL 3 - Function: LEVEL	164

CONTENTS

CONTROL 4 - Function: LFO to PITCH.....	164
CONTROL 5 - Function: LFO to FILTER Fc.....	165
CONTROL 6 - Function: LFO to LEVEL.....	165
CONTROL 7 - Function: ATTACK RATE	166
FOOTSWITCH 0 - Function: OFF	166
FOOTSWITCH 1 - Function: SEQ CTRL	166
FOOTSWITCH 2 - Function: SUSTAIN.....	166
FOOTSWITCH 3 - Function: RELEASE.....	167
FOOTSWITCH 4 - Function: SUSTENUTO	167
FOOTSWITCH 5 - Function: ADVANCE PRESET.....	167
ENTER MODULE	168
ENTER DATA	169
SEQUENCER MODULE	170
BACKGROUND	171
WORKING WITH A SEQUENCE	171
ACTIVATING AND DE-ACTIVATING THE MODULE.....	172
THE "CURRENT SEQUENCE"	172
NOTES, PRESETS, TRACKS, and CHANNELS.....	172
SETUP PROTOCOL	173
SEQUENCER EXT CLOCK	174
DEFINE 1 - Function: CREATE SEQUENCE.....	178
DEFINE 2 - Function: TIME SIGNATURE.....	179
DEFINE 3 - Function: SEQUENCE LENGTH.....	180
DEFINE 4 - SUPERMODE	181
SETUP 1 - Function: SELECT TRACK.....	183
SETUP 2 - Function: TEMPO.....	184
SETUP 3 - Function: AUTO CORRECT.....	184
SETUP 4 - Function: CUE.....	185

CONTENTS

SETUP 5 - Function: SMPTE START	186
SETUP 6 - COUNTDOWN	186
RECORD, PLAY and STOP.....	187
Record.....	187
Playback.....	187
Stop	187
SELECT SEQUENCE	188
EDIT 1 - ERASE TRACK	189
EDIT 2 – PUNCH-IN.....	190
EDIT 3 – BOUNCE TRACKS	191
EDIT 4 - STORE CONTROLS.....	192
EDIT 5 – REASSIGN PRESET.....	193
EDIT 6 – APPEND SEQUENCE.....	193
ADVANCED APPLICATIONS	194
THE ART OF SAMPLING	195
PART 1: TAKING THE BEST POSSIBLE SAMPLE.....	196
GENERAL TIPS	196
SAMPLING FROM TAPES	197
PART 2: MANIPULATING THE SAMPLE.....	198
TIPS ON MANIPULATING SYNTHESIZER SAMPLES.....	199
“SIGNAL PROCESSING” WITH THE EMULATOR II	199
PART 3: EFFICIENTLY COMBINING SAMPLES INTO PRESETS	201
I. The Situation	201
II. Getting ready.....	201
III. Sampling the Voices.....	202
PART 4: CREATING MULTI-INSTRUMENT PRESETS	204
MIDI SUPPLEMENT	207
BASICS: QUESTIONS AND ANSWERS ABOUT MIDI	208
What does the MIDI cable do?	208
How can information control a synthesizer?	208
How does MIDI differentiate between different MIDI instruments?.....	209
16 channels, huh? Sounds like a lot of patch cords to me!.....	209
What kind of words does the MIDI language include?	209
TYPICAL MIDI APPLICATIONS	210

CONTENTS

CREATING A “MIDI PRESET” WITH THE EMULATOR II	211
FINDING OUT ABOUT OTHER SYNTHESIZER’S MIDI CAPABILITIES	212
DEALING WITH “MIDIOSYNCRACIES”	213
SMPTE SUPPLEMENT	214
SMPTE OVERVIEW	215
SMPTE PROTOCOL	215
APPENDICES	217
APPENDIX A: GLOSSARY OF TERMS	218
APPENDIX B: EMULATOR II FUNCTIONS, DEFAULT SETTINGS, and CONTROL RANGES	220
APPENDIX C: EMULATOR II ERROR MESSAGES	224
Emulator II Credits	226

INTRODUCTION

INTRODUCTION

INTRODUCTION

WHAT'S AN EMULATOR II?

The Emulator II is a responsive, surprisingly easy-to-use musical instrument with staggering creative possibilities. It's also a sound effects designer's dream come true, a composer's personal orchestra, a recording studio's chance to have hundreds of acoustic and electronic instruments "on call" at any time, a university's research tool...but most of all, it provides the means for some truly special musical experiences. To give you a better idea of its capabilities, here are just some of the Emulator II's highlights.

* * * * *

Rather than synthesizing sounds, the Emulator II digitally records ("samples") real-world sounds into its memory. If you want the Emulator II to sound like a piano, sample a piano; if you want it to sound like a barking dog, sample a dog.

These sounds may then be modified with the Emulator II's analog synthesizer processors and/or state-of-the-art digital processors. The analog-type processors include:

- Lowpass voltage-controlled filter (VCF) with ADSR envelope generator
- Voltage-controlled amplifier (VCA) with ADSR envelope generator
- LFO with adjustable rate, delay, and speed variation
- Two programmable modulation wheels for real-time control over pitch, filter cutoff, ADSR attack rate, level, LFO modulation, etc.
- Two programmable footswitches for real-time control over sustain, release, sustenuto, "patch" change, and Sequencer
- Velocity-sensitive keyboard, where keyboard dynamics can control any or all of the following: VCA level, VCA attack, VCF cutoff, VCF attack, and VCF Q.

The keyboard can play up to eight notes simultaneously. Like standard analog synthesizers, there is a complete set of modifiers for each note; so, when we refer to the "filter" or we are really talking about eight filters and VCA's.

Digital processing techniques include:

- Truncation (shortening the beginning and/or end of the sample)
- Looping the sample (or any portion thereof)
- Digitally combining (mixing) two samples
- Sound reversal ("backwards tape" effects)
- Splicing two samples together (imagine a soprano voice changing into a guitar note...)
- Advanced split capabilities -- assign a different sample to each note of the keyboard, or split in more conventional ways (i.e. cellos in lower octaves, violins in upper octaves).
- Easy doubling, plus velocity-controlled crossfading and switching between doubled samples
- Individual tuning and attenuation for each sample
- Ultra-flexible, programmable arpeggiation
- Eight channel sequencer with (among other features) auto correct, track bounce, cuing, punch-in/punch out, and the ability to drive eight MIDI instruments. It also responds to dynamics and remembers modulation wheel settings.

INTRODUCTION

Sounds are stored on commonly available double-sided, double-density (DS/DD) 5.25" floppy disks (as used with many personal computers). Thanks to sophisticated disk management techniques, it's easy to save, organize, retrieve, rename, and catalog various sounds. In fact, if the Emulator II was just a computer it would be pretty impressive: There's almost four times more RAM (memory) than a basic IBM PC, and the two disk drives store as much data as fourteen Commodore-64s!

For outside-world interfacing, the built-in eight-track sequencer (and the arpeggiator) can sync up to a 24, 48, or 96 pulses-per-quarter note click track, SMPTE time code, or MIDI; there's also a complete complement of MIDI functions, as well as an RS-422 port for control via external computer.

Despite all this flexibility the Emulator II is nonetheless not that hard to learn...as you will see during the course of this manual.

WELCOME TO THE EII+ and EII+HD

If you have purchase the enhanced version of the Emulator II, it has all the features of the original with new expanded capabilities as well. Throughout this manual, you'll find references to the Emulator II. Just ignore the name difference. All instructions for the operation of the Emulator II are compatible with those for the Emulator II+ and Emulator II+HD, except for the Double Memory and Hard Disk sections described later in this manual. Please refer to specific sections for the instructions on procedures that you are not familiar with.

If you have just purchased an Emulator II+ or Emulator II+HD, please refer to the Double Memory Section in this manual for operating instructions.

If you have just purchased an Emulator II+HD please refer to the Hard Disk Supplement in this manual for operating instructions and other pertinent advice.

MANUAL RESTORATION NOTES

This manual is a collation of all the known User Instructions for the EII, EII+ and EII+HD. It includes information on all operating systems release up until the final OS 3.1 and OS 3.1 HD versions of late 1987. It is based around the Owners Manual for OS 2.3 - the last full manual released by E-mu Systems in 1985. All original errors have been corrected, except for the sampling rate, which is incorrectly stated as 27,500 Hz rather than the actual sample rate of 27,777Hz.

The manual was restored in June 2002 by the Emulator Archive - www.emulatorarchive.com. We have tried to keep as much of the original style as possible, but we have made it easier to use and included all the supplements as sections. This manual is not for resale or reproduction and it is FREE.

Rob Keeble
Sussex, UK
June 2002

Thanks to Craig Anderton for writing a great manual.
Thanks to E-mu Systems for the best sampler in the universe.

INTRODUCTION

SEND IN YOUR WARRANTY CARD NOW!

It is vital that you send in your warranty card so that we can notify you of enhancements, new features, and (nobody's perfect) software bugs & cures. Sending in the warranty card also entitles you to a free one-year subscription to "The Emu-Letter", a bi-monthly company bulletin carried in Electronic Musician (formerly Polyphony) magazine. You also become a part of the Emulator II Users Group, your passport to the near- legendary annual parties where (among other things) Emulator II owners swap disks, gossip, and tips.

But none of these wonderful things will happen to you unless you send in your warranty card. Don't miss out: Send it in now!

Warranty Registration
Please return this card within ten days of purchase.

Model #: _____ SERIAL # _____ Date Purchased: _____
Phone Number: _____

Product: _____
Dealer's Name: _____
Dealer's City, State & Country: _____
Purchaser's Name: _____
Address: _____

What is your association with the music industry? Professional or Amateur
Band Member Bozo Lounge Musician Studio Engineer Studio Musician Composer/Songwriter
Other

Do you wish to participate in our User's Groups? _____

Which of the following music and recording magazines do you read?
International Musician Output Mix Recording Engineer/Producer Keyboard Musician On Location
Modern Recording

Where did you first hear of this E-mu Systems product?
Down Beat Others

What other product(s) would you like to see marketed by E-mu Systems, Inc.?

How would you rate the service that you received from our dealer?

Comments: _____

© 1985, 1986, 1987 E-mu Systems, Inc.

INTRODUCTION

INSTANT GRATIFICATION!

If you just can't wait another second before hearing the Emulator II, we understand. Follow the directions below EXACTLY as given and get ready to hear some great sounds. (Incidentally, in case you make a mistake or run into problems, don't worry. This process is described in greater detail in Guided Tour #1.)

1. Making sure that the Emulator II is unplugged; patch the rear panel MIX OUT jack to the input of a high quality amplification system.
2. Turn the front panel MIX OUT volume control (located near the Emulator II logo) fully counter-clockwise.
3. Check that the rear panel voltage selector is set for the correct voltage in your part of the world.
4. Plug the Emulator II line cord into an AC outlet.
5. If you are not familiar with how to handle computer disks, you will have to delay your Instant Gratification somewhat. Please turn to the GENERAL INSTRUCTIONS section and read the part labeled GENERAL INSTRUCTIONS 5 on proper disk handling. If you know how to treat disks with the proper loving care, then proceed.
6. Check that there are no disks currently in the disk drive(s). If there are, or if the disk drives contain cardboard packing materials, turn the drive latches to their counter-clockwise positions (see **Fig. GENINS-3** in the GENERAL INSTRUCTIONS section), remove the disks or packing materials, and put them in a safe place.
7. Turn on power. All LED's will flash for a moment, except for the disk drive LED's which will continue to flash. The display will say Insert Diskette.
8. Select one of the factory disks supplied with the Emulator II, and insert it label side ~ with the label going in last into the top disk drive (or the only disk drive with a single-drive Emulator). **Fig. GENINS-4** in the GENERAL INSTRUCTIONS section shows how to insert a disk. When the disk is seated in the drive, turn the disk drive latch clockwise until it is pointing straight down. The drive LED will turn on steadily, and the display will start communicating with you.
9. When the drive LED turns off, turn up the MIX OUT control and start playing the keyboard. All right!! The display will show you the number (P followed by two digits) and name of the sound you are playing. These sounds are called Presets, for reasons that will become clear later.
10. Use the calculator-type keypad underneath the display to call up different Presets. Press a two-digit number; start with 01 and play the keyboard for a while, then press 02 and play, 03, 04, etc. At some point you will run out of factory Presets, and the display will say NOT FOUND.

If you want, vary the modulation wheels towards the left hand side of the keyboard. They perform different functions with different Presets.

INTRODUCTION

11. To try out Presets from other factory disks, open the latch, remove the existing disk, and insert another factory disk. Close the latch. Now, find the portion of the front panel labeled "DISK" (towards the lower-right hand corner). Press its switch, and its LED will light up. Now press 1 on the keypad. The disk drive will start making noises, and you will be on your way to loading another bunch of sounds into the Emulator II. When the drive LED goes out, press the DISK switch once more, then start playing the keyboard and selecting more Presets.

* * * * *

By now you should be pretty impressed, but there's much more to come...so keep reading, and you'll find out all about it.

INTRODUCTION

HOW TO USE THIS MANUAL

The Emulator II is not an instrument that can be mastered in a few days. Therefore, this manual is organized so that you can take “guided tours” of different sections of the Emulator II and learn at your own pace.

The manual comprises five major parts:

1. **Definitions** This section explains how the Emulator II organizes sounds. It’s not exactly easy reading, but pay close attention - it lays vital groundwork for the rest of the manual.
2. **Guided Tours** This part describes several “guided tours” you can take through the Emulator manual’s Reference Section to help learn the instrument’s operation. Each tour gives any necessary background information, and then directs you to particular parts of the Reference Section where concepts are further developed. By following these tours in the order presented, subjects are introduced logically and build on previously introduced material.
3. **Reference Section** This is the heart of the manual, and describes every function available on the Emulator II.
4. **Advanced Applications (the Art of Sampling, MIDI and SMPTE supplements)**
This includes information on how to get the most out of the Emulator II.
5. **Appendix** If you’re not sure what a VCF is, or what Q really means, relax...the answers are here. Whenever you see a technical word or abbreviation that you don’t know, check this section for the definition.

Caution: Much of the manual presents material as a series of steps. Always read to the end of each numbered step before pushing any buttons! Sometimes a step presents several alternatives, and tells you which one to choose at the end.

INTRODUCTION

DEFINITIONS: HOW THE EMULATOR II ORGANIZES SOUND

Forget everything you've ever learned about voices, presets, and channels: The Emulator II does things differently from traditional keyboard instruments.

Sampling Basics

The Emulator II is conceptually like a tape recorder in that it records sound. However, the recording process is very different since the Emulator II is recording into computer memory.

Computers can accept information only in the form of numbers, so the Emulator converts audio signals into numbers. It does this by examining (sampling) the incoming signal level 27,500 times a second, and sequentially recording these different levels in computer memory. **Figure 1** shows a one-second percussive sound being sampled. The magnified view shows how the samples define the instantaneous level of the signal. Once stored in the Emulator II's memory bank, these samples may be played back (in the proper sequence, of course) to reconstruct the original signal. If a two second sound was being sampled, it would require $2 \times 27,500$ or 55,000 samples. Shorter sounds require fewer samples.

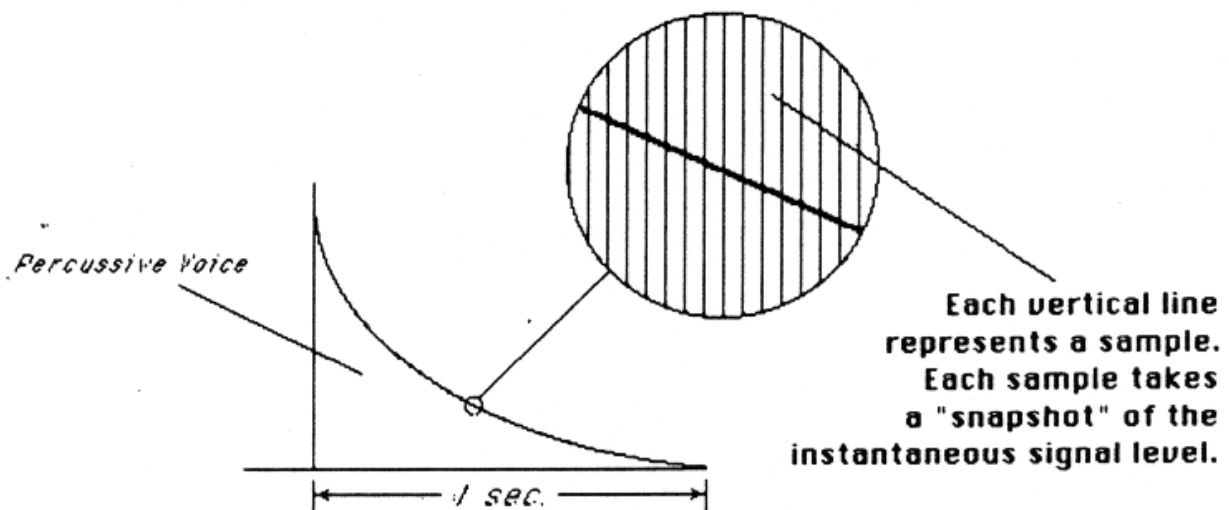

Figure 1

Just like tape, a sound can be manipulated once it has been recorded. Playing back, the samples in the reverse order from which they were stored plays the sound backwards. Playing back the samples at a faster rate than the rate at which they were stored raises pitch; playing back at a slower rate lowers pitch (like a tape recorder's variable speed control).

INTRODUCTION

The Emulator II “Map”

Sure, you're anxious to start coaxing wonderful sounds from the instrument -- but like ground school for pilots, the following is a necessary part of learning how to play the Emulator II. It is important to understand how the Emulator II organizes sounds in order to make best use of the instrument in the shortest possible time. Also, many terms will be introduced now that will show up later in the manual.

You can think of the Emulator II as resembling a collection of modules, linked by various pathways (see the Map in **Figure 2**). These paths indicate how information flows within the Emulator II; let's take a closer look at what makes up this information, and how it is transferred from one section of the instrument to another.

INTRODUCTION

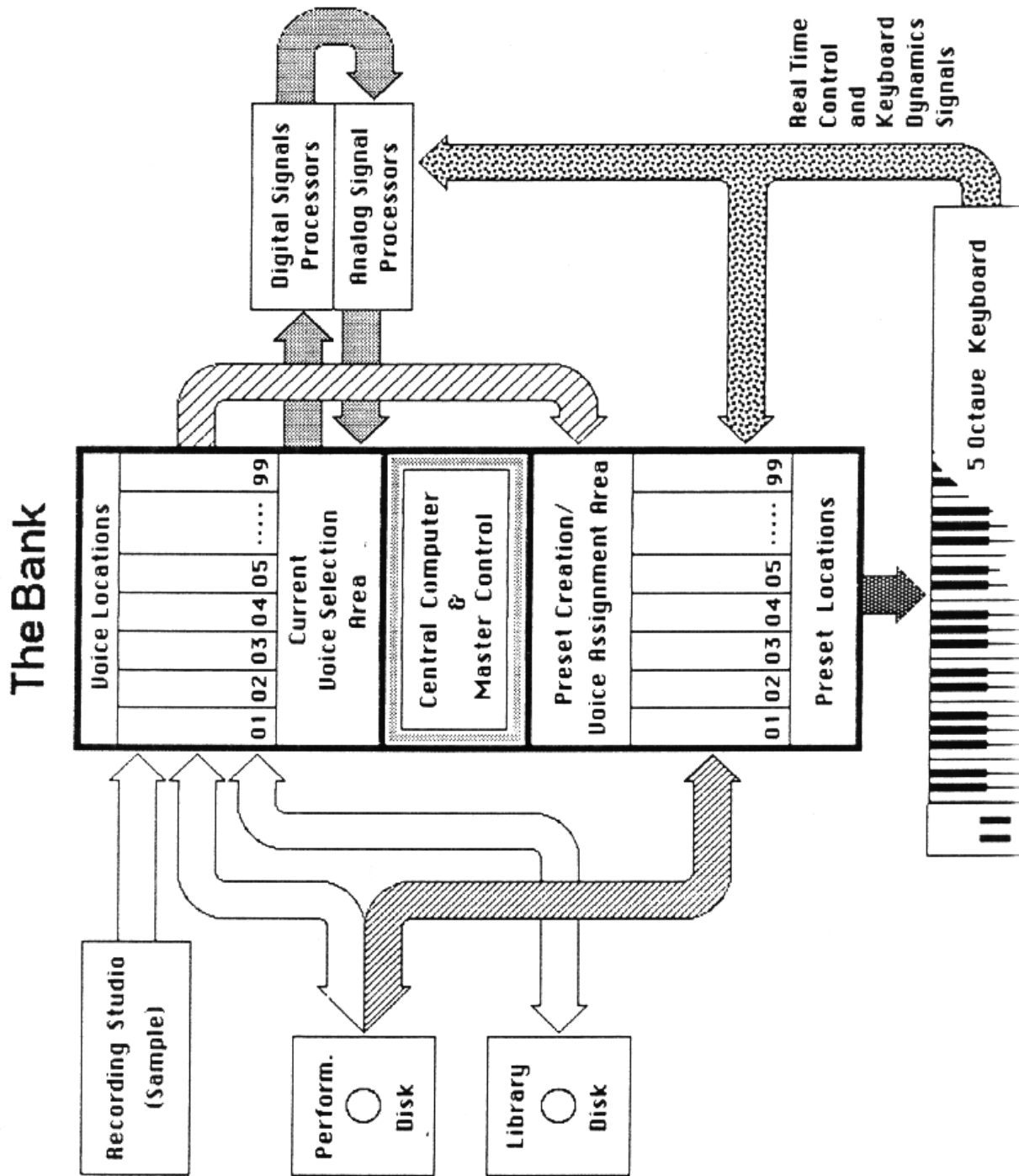

INTRODUCTION

The Bank

The Bank contains all of the Emulator II's memory (where, among other things, the sounds are recorded), plus a high-performance Central Computer. The Bank is the central storehouse for all of the Emulator II's data. Although the memory is volatile, meaning that the data disappears when you turn off power, the Bank data can be saved permanently on disk to keep a record of your work. (This process is somewhat like saving the data in a regular polyphonic synthesizer to cassette, but using disks results in far more efficient operation.)

Also note that because the memory is volatile, when you first turn on the Emulator II there's nothing in the Bank. Before you can make any sounds, data must be loaded into the Bank from disk or by sampling sounds.

Since we now have a place to store information temporarily (the Bank), and a way to store information permanently (saving to disk), let's take a look at the different kinds of information being stored.

The Voice

Sampling a sound using the instrument's "Recording Studio" capabilities (upper left-hand block) creates what the Emulator II calls a Voice, the "raw material" with which the instrument works. (Voices can also be loaded in the Bank from disks, as described later.) This Voice could be a sampled drum sound, violin note, jet plane, zither, oboe, steam press, or whatever. And if having the entire world, as a potential sound source isn't enough for you, the Emulator II can also process Voices in a wide variety of ways (as we'll discuss in "Voice Processing").

The Bank can store up to 99 Voices, each with its own two-digit Voice number and name (i.e. V21 Grand Piano). The total available sampling time is 17.6 seconds (484,000 samples); the Bank Voices can divide up the 17.6 seconds any way you like (i.e. ten 1.76 second samples, eighty-eight 200 millisecond samples, one 17.6 second sample, etc.).

A Voice can be assigned to a single note on the keyboard, but may be transposed polyphonically to cover up to a two-octave range. The process of assigning, and optionally transposing, Voices to specific ranges of the keyboard is called making a Preset. Note: It is often necessary to use multiple Voices to make up a Preset, since wide-range transposition alters the Voice's timbre. Therefore, using multiple samples and transposing each over a small range usually gives the most realistic sound.

The Preset

Making a Preset is a three-step process:

1. Give the Preset a number (i.e. P03) and name. The Bank can hold up to 99 Presets.
2. Assign the desired Bank Voices to different ranges of the keyboard (for example, with five Voices you could assign each Voice to cover one octave of the keyboard.) This is represented in **Figure 2** by the path connecting the Voice Locations to the Preset Creation/Voice Assignment Area. Note that the same Voice can be assigned to more than one range of the keyboard in a given Preset, and also, Voices can be combined in more than one way to make more than one Preset.

INTRODUCTION

3. Choose from a number of options that further define the Preset, such as assigning Voices to partially or fully overlap other Voices (thus producing doubling effects), assigning dynamic control to individual Voices in a Preset, erasing Presets you don't like, cataloguing Presets, cataloguing the Bank Voices to see what's available for making up a Preset, adding arpeggiation, setting up MIDI parameters, etc.

Note that a Preset does not store the actual sounds that make up the Voices in the Preset; rather, it stores data about the Voices (which ones to use, where they are assigned on the keyboard, whether they should respond to keyboard dynamics, and the like). Because of this, Presets do not take up as much Bank memory as Voices since data takes up less memory space than sounds. (For an analogy, think of the cassette interface in a digital drum machine. In just a few seconds, the cassette can record all of the patch data for the entire machine; it would take far longer to record the actual sounds of all the drum machine patterns and sequences.)

OK...that's the story on creating Voices and assigned them to the keyboard to make up a Preset or Presets. Now let's take a look at processing Voices.

Voice Processing

Once a Voice is loaded in the Bank and assigned to a Preset, it can be sent to the Analog and Digital Processing modules. However, since (as mentioned earlier) a Preset typically contains several Voices, we need to specify which Voice, or Voices, we want to process. This is called selecting the Current Voice, another three-step process:

1. Call up a Preset that contains the Voice(s) to be processed.
2. Choose the Voice to be processed, or select several Voices and group them together so that they are all processed simultaneously (this group of Voices is still referred to as the "Current Voice").
3. Send the Current Voice through the Analog and Digital Processing modules, whereupon they return back to the Bank in their modified form. All Presets containing these Voices will reflect the changes caused by processing.

The Current Preset

As you found out in the "Instant Gratification" section, as soon as a Performance disk is loaded a Preset will be ready to go. This is the Current Preset. If you select another Preset, or create a Preset, this becomes the Current Preset.

When you sample a sound to create a Voice, the Voice is automatically assigned to the two lowest octaves (unless you specify otherwise) of the Current Preset. If the Bank was not empty and you had a Preset selected, the sample will replace whatever sample was already in the lowest two octaves of this Current Preset. (However, you do not over-write the Voice itself, which stays safely tucked away in the Bank; you are simply over-writing the Voice assignment in that particular Preset.)

If the Bank was empty prior to sampling (it's generally best to clear the memory before sampling; among other advantages, this allows for the maximum possible sampling time), the Bank will automatically create a "NULL PRESET" into which it will assign the Voices that you sample. Each successive Voice you sample will be assigned to the lowest two octaves of the

INTRODUCTION

keyboard (unless you specify otherwise), and over-write the previous Voice assignment (although as mentioned in the end of the last paragraph, the sampled Voices themselves remain in memory).

The Disk Archives

So far, we've loaded a bunch of Voices into the Bank, created some Presets containing those Voices, and done some Voice processing. However, remember that the Bank only retains this information for as long as the Emulator II is plugged in and turned on. Of course, we don't expect you to leave the thing on all the time, which brings us to the subject of saving data on disks.

There are two types of Emulator II disks, Performance disks and Library disks.

Commanding the Central Computer to "Save Bank" causes it to shuttle all the Bank data (Voices, Presets, and Sequencer Sequences) on to a Performance disk. This disk permanently stores data so that even after turning off the Emulator II. The disk will contain a record of your work.

IF YOU DO NOT SAVE A BANK TO DISK, ALL BANK DATA WILL BE LOST WHEN YOU TURN OFF THE EMULATOR II. Do not wait until the end of a session to save -- save your work periodically in case of power failure or some other unforeseen circumstance which might erase the Bank's memory.

Since the Performance disk contains a record of the Bank data, loading the disk back into the Bank transfers all the Voice, Preset, and Sequencer data into the Bank (this will replace the existing Bank data, if any). Therefore, you can work a Bank of sounds out at leisure, and save the results of your work on disk; when you go to a gig, simply take the Performance disk with you and load all your hard work from disk into the Emulator II in a few seconds.

Library disks record and play back Voices only (unprocessed or processed), and contain no Preset information. They are useful when building up a library of raw sounds. For example, you might want to sample an instrument, but are unclear about what kind of Presets you want to make up from these sampled Voices. Simply save the individual Voices to the Library disk, and then load them into the Bank at a later date when you want to create some Presets. And, if while creating the Preset you process the Voices too heavily and wish that you had the originals back, no problem...they are still preserved on the Library disk.

Think of the Performance disk as something you take with you on gigs, and of the Library disk as a means of storing a collection of raw sounds which can be used later on to make up Performance disks. Note: With either disk type, if you pull a Voice or Preset from a disk, alter it, and then save it to that same disk without changing its identifying number, the disk will erase the original version and replace it with the processed version.

Incidentally, the process of having new data erase and replace old data is called over-writing.

INTRODUCTION

The Keyboard

Note the two paths coming from the keyboard in **Figure 2**; the LFO, VCA, VCF, and ADSR Analog Signal Processors are tied to keyboard dynamics (for example, playing harder can alter the loudness, attack time, filter cutoff, etc.), as are some Preset assignment characteristics (i.e. playing louder assigns a different Voice to a particular key).

The Output Channels

The Central Computer assigns keyboard keys to the output channels. When you play a key, that key's sound is assigned to Output Channel 1. If you hold this key and play another key, the new key's sound will be assigned to Output Channel 2. The Emulator II includes eight channels, so you can play up to eight sounds simultaneously. Each channel has its own output jack, and there is also a master output jack, which mixes the eight channels together. Individual Voices can also be restricted to particular channels, which will be covered in detail later when we discuss the Emulator II's sequencer.

Re-cap

One more time: A Voice is a sampled sound. It is temporarily stored in the Emulator II's Bank and may be permanently stored on a Library disk. While a sampled Voice must be assigned to a Preset prior to processing, a sampled Voice may nonetheless be processed immediately after sampling since the Emulator automatically assigns the sampled Voice to a Preset it creates, called the Null Preset.

To create a new Preset, make sure you have all the Voices required for the Preset in the Bank, number and name a Preset, then assign combinations of Voices from the Bank to specific sections of the keyboard. By specifying one or more of these Voices as the Current Voice, the Current Voice may then be processed by the Emulator II's analog and digital signal processors.

Since loading in a Performance disk fills the Bank with Voices and Presets, you can group these Voices into new Presets, process the Voices, or alter the existing Presets.

Always Remember to Save Your Work

Once a Bank contains the desired Presets and Voices, it must be saved to a Performance disk. Specific Voices can be saved to a Performance disk as part of a Bank, or saved individually to a Library disk.

INTRODUCTION

OTHER DEFINITIONS

Booting the Emulator II is not a repair technique; rather, it is a computer term that means “putting a disk in the disk drive after you first turn it on, and having the computer read software necessary for its operation from that disk”. (It’s easy to see why this was shortened to “booting”.) To boot, insert a Performance or Library disk in the drive before, or just after, you turn on the Emulator II. Closing the disk drive latch tells the Emulator to start reading the software. Once booted, the instrument is ready to go. (Note: Booting from a Performance disk takes longer than booting from a Library disk since after booting, the Emulator II loads the Performance disk Bank data.)

A Default setting is what we’ve judged to be a useful initial setting, and remains in effect until you change it. For example, the mic preamp in the sampling section defaults to zero gain when you first turn on the Emulator II. Had it defaulted to the maximum gain position, this might have blasted your ears off if you accidentally put in a line level signal, so we figured zero gain was better.

The display’s cursor, a small line, will flash when it wants data from you about the number or letter under which it is located. Entering a new value over-write the old one, whereupon the cursor moves on to the next number or letter (if applicable).

Note: If the Emulator II is expecting a two or three-digit number, you must enter all the required digits even if some of these are zeroes (called “leading zeroes”). For example, if the Emulator II is expecting a three-digit number and you want to enter 8, you would enter 008. If it were expecting a single-digit number, entering 8 would be sufficient.

Saving is the important process of saving your work to disk. Despite what computer manufacturers would like you to believe, computers are not infallible and besides, the world sometimes plays cruel tricks (like a power surge in the middle of a sampling session). To help defy Murphy’s Law (“if anything can go wrong, it will”), whenever you have done enough work on a Voice or Bank that you would hate to lose it, save it on at least one disk. Should you improve the Voice or Bank later, you can always replace the original with the revised version -- and if something goes wrong, the original will still be available to save you the hassle of starting from scratch.

THE GUIDED TOURS

THE GUIDED TOURS

THE GUIDED TOURS

HOW TO USE THE GUIDED TOURS

Occasionally during a tour you will be told to refer to something like PRESET DEFINITION 11, DISK 8, SAMPLE 2, or some other name. This means that you will find more information in the specified section of the manual's Reference Section. For example, PRESET DEFINITION 11 indicates that the information is in the Preset Definition chapter under section 11; DISK 2 indicates that the information is in the Disk chapter under section 2. Note that these chapters are arranged in the same order as you encounter the Emulator II front panel "modules" if you move from left to right along the top row of modules, then move from right to left along the lower row of modules.

Figures are referred to by a shorthand name for the chapter and a number. For example, **Fig. GENINS-3** would be the third figure in the GENERAL INSTRUCTIONS chapter.

GETTING READY FOR THE GUIDED TOURS

Have you sent in your warranty card yet? Listen, we're not kidding! Send it in!!

Okay. Now you can proceed.

1. Set up the Emulator II as described earlier under Instant Gratification. After completing step 6, return to this section.

Remember - at this point playing the keyboard will not produce sound. In order to hear anything, you must "load" a sound into the Emulator II from disk (which we'll describe shortly).

2. Make sure you have about a half-dozen 5.25" blank disks (double-sided/double-density, 48 TPI) on hand, plus a paper and pencil for taking notes.

THE GUIDED TOURS

GUIDED TOUR #1: MEET THE EMULATOR

This tour covers how to:

- Care for diskettes
- Load a Bank from a Performance disk when first turning on power
- Select different Presets from the Bank
- Load additional Performance disks
- Tune the Emulator II to other instruments
- Transpose the keyboard

...and also discusses the Emulator II's "modular" design philosophy.

DISK HANDLING

Disks are delicate and store valuable data. Before proceeding, carefully read GENERAL INSTRUCTIONS 5 ("Disk Handling") for important information on how to care for your disks.

LOADING A PERFORMANCE DISK

1. Turn on the Emulator II, then insert the Grand Piano disk in Drive 1 according to the instructions given in the next to last section of GENERAL INSTRUCTIONS 5 ("Disk Handling").
2. After about 20 seconds of loading time, the display will show the Current Preset number and name (the cursor will flash underneath the first digit). Start playing the keyboard and turn up the MIX OUT control for a comfortable listening level.

SELECTING DIFFERENT PRESETS

1. The Bank you just loaded contains several Presets. To call up a new Current Preset, use the keypad underneath the display. Note that "leading zeroes" must be entered for Preset numbers (i.e. type 0 and 2, not just 2, to call up Preset 02). Now type 0 then 2 on the keypad; these will replace the numbers indicated by the flashing cursor.
2. The display says P02 Piano #2. Play the keyboard...hey, it sounds just like a piano!
3. Now call up more Presets (refer to GENERAL INSTRUCTIONS 1, "Selecting the Current Preset"), steps 1 and 2). If you make a mistake and enter a number for which there is no Preset, the display will list the entered Preset number and say NOT FOUND; try calling up the desired Preset again. To find out what Presets are available on the disk, refer to PRESET DEFINITION 19, "Catalog Presets".

When you're ready to check out some more sounds, proceed.

THE GUIDED TOURS

THE EMULATOR II's "MODULAR" PHILOSOPHY

The Emulator II front panel is divided into modules. Each module will be discussed in detail later on; the following is intended mostly as background information. Each module affects a certain area of the Emulator II's operation. Refer to the map (Fig. **INTRO-2**) to see how some of these modules fit into the Emulator II's overall structure.

Master Control. This includes controls that affect the entire keyboard (such as Tune, Volume, and Transpose), a ten-digit calculator-like keypad with numbers printed above the keys, the display, and four sliders, which set variable parameters (described later). Note that keypad switch 7 doubles as a NO button and keypad switch 9 doubles as a YES button (sometimes the Emulator II will ask you yes-no questions, and this is how to communicate with it).

Sequencer. This module is an eight-track solid state recorder with sophisticated features such as SMPTE and MIDI control, punch-in and erase, track bounce, cue, and auto correct.

Filter. You can dynamically change the timbre of any Voice or group of Voices (in other words, the Current Voice) via lowpass filtering. The filter features variable cutoff, variable Q, variable envelope amount (normal or inverted), variable keyboard tracking, LFO modulation, and includes its own ADSR envelope generator.

VCA/LFO. You may change the attack/decay/sustain/release characteristics of the Current Voice by modulating the VCA with its associated ADSR envelope generator. This module also sets most LFO parameters.

Voice Definition. With this powerful module, you may edit a Voice's length, loop (e.g. infinitely sustain) any portion of the Voice (with several different looping options), have the Emulator II automatically find the best loop points ("AutoLoop"), adjust the relative mix of various Voices, save Voices to disk, and perform other Voice-related operations. This module also sets independent keyboard touch sensitivity for each of several filter and VCA destinations (dynamics, cutoff frequency, Q, attack time) and programs the mix (audio balance) for each individual Voice in the Preset.

After modifying Voices, don't forget that the only way to keep these modifications is to save them to disk. Otherwise, any changes will be lost as soon as power to the Emulator II is interrupted.

Preset Definition Does all the "housekeeping" for the Emulator II: You may name Voices or Presets, erase them, copy them, assign Voices to different places on the keyboard, "catalog" the names of Voices and Presets stored in the Bank, etc. Other Preset Definition functions include MIDI and arpeggiator selection as well as three keyboard-related special effects (velocity switch, velocity crossfade, and positional crossfade).

Sample. This "recording studio" module records sounds from the outside world into the Bank. Features include adjustable preamp gain, variable threshold setting, and adjustable sample length.

Disk. The DISK module archival data traffic between the Emulator II and its disks. Sounds may be stored on disk, read back from disk, catalogued, and more.

THE GUIDED TOURS

Special. This module mostly contains test routines. However, because of its computer-based nature, the Emulator II can be updated easily. This module will also access any new functions dreamed up by the wizards at E-mu. Calling up its Catalog will tell you what special functions are present.

Real-Time Control. This assigns different destinations (pitch, filter cutoff, VCA attack, etc.) to your choice of the two modulation wheels (located at the left of the keyboard), foot pedal, three MIDI control channels, and dual programmable footswitches.

Enter. Just as you can activate a module to tell the Emulator II something you want to do, the Emulator II can activate this module when it wants to signal ~ to do something. It communicates in one of two ways: by flashing the **ENTER** light, or turning it on steadily. The significance of the two states will be explained later.

ACTIVATING and DE-ACTIVATING MODULES, SELECTING FUNCTIONS

Here's important background information on how to access the various module functions. In the next section of this tour, we'll relate this information to a practical example.

Activating: Each module, except for Master Control and Sequencer, includes a switch and accompanying LED. Pushing this switch "activates" the module, as indicated by the LED lighting up. (Note: There must be a disk in the drive when you activate any module; the disk drive may run for a second or two before the module LED lights up.) The display's top line will give a Module Identifier (such as "VCA/LFO", "Disk", "VoiceDef", or the like), followed by the range of possible numbers you may enter to call up various module functions (see below).

Selecting functions: Each module includes a printed list of functions on the front panel; these functions are available when the module is active. Selecting a module function requires keying in its associated number with the keypad. We will shortly give an example of how this all works.

De-activating: When you're finished with the module either press its button again to de-activate, or simply activate a new module.

Hint: Any time you make a mistake, get confused, or otherwise get "lost in the module" and need to bail out, simply de-activate the module. Then, re-activate and try again.

LOADING OTHER PERFORMANCE DISKS

So far, so good...now it's time to move on from the piano. The following instructions are for a dual-drive Emulator II; see the end of this section for single-drive Emulator II instructions.

1. Select the Performance disk of your choice and insert it into the disk drive of your choice.
2. If the Performance disk was inserted in Drive 1, refer to DISK 1. ("Get Bank Disk 1"). If the Performance disk was inserted in Drive 2, refer to DISK 2 ("Get Bank Disk 2") instead. After following the directions in the indicated section, return to this section.

THE GUIDED TOURS

Note: You can have different Performance disks in both drives, and load a Bank from either disk (but not both simultaneously) by using the appropriate command (GET BANK DISK 1 or GET BANK DISK 2). **Loading in a new Bank will erase any currently loaded Bank.**

Loading instructions for single-drive Emulator II:

1. Remove the old Performance disk from Drive 1, then insert and latch the new Performance disk into Drive 1.
2. Refer to DISK 1 ("Get Bank Disk 1"), follow the instructions, and then return to this section.

TUNING THE EMULATOR II TO OTHER INSTRUMENTS

Refer to MASTER CONTROL - TUNE. This function demonstrates how the Emulator II uses the slide controls to set parameters. In this case, only one of the four sliders is used. However, when setting such parameters as ADSR values for the filter or VCA, all four sliders are used.

TRANSPOSING THE KEYBOARD

Refer to MASTER CONTROL - TRANSPOSE.

FORMATTING DISKS

Format an equal number of Performance and Library disks (at least two of each) according to the instructions given in DISK 8, "Formatting a Performance or Library Disk". These will come in handy during future guided tours.

THE GUIDED TOURS

GUIDED TOUR #2: SPECIFYING THE “CURRENT VOICE”

BACKGROUND

The Emulator II has three main Voice processing modules:

1. **Filter** varies a Voice’s harmonic content via a four pole, low pass filter and associated ADSR envelope generator.
2. **VCA/LFO** varies the Voice’s LFO parameters as well as the amplitude attack, decay, sustain, and release characteristics.
3. **Voice Definition** provides sophisticated digital processing and also sets the keyboard dynamics.

Each Voice stored in a Bank can have its own individual Filter, VCA/LFO, and Voice Definition settings. Therefore, we need a way to specify the Current Voice, which is the individual Voice (or collection of individual Voices) to be processed.

The concept of the Current Voice is important. To process one Voice out of a Preset, assign the Current Voice to be that one Voice, and process it. To process more than one Voice at a time, specify a group of Voices to be the Current Voice and process all Voices simultaneously.’

This section covers how to identify which keyboard keys belong to which Voice, and how to specify which Voice or Voices make up the Current Voice. For a short form version of this tour, see GENERAL INSTRUCTIONS 2 (“Assigning the Current Voice”).

To begin, if the Grand Piano Performance disk described in Guided Tour #1 has not been loaded, load it from Drive 1 and select Preset 01. Also, read ENTER (the last chapter in the Reference Section) on the function of the ENTER button, as it will be used during this and most subsequent tours.

IDENTIFYING WHICH KEYBOARD KEYS BELONG TO WHICH VOICE

Once the Emulator II Bank has sounds in it, activate the Filter, VCA/LFO, or Voice Definition module; its LED will light. If a Voice has not been previously selected, the display will say:

No Current Voice
Play a Key

If so, move on to step 2. If a Current Voice has been previously assigned, the display’s top line will give the Module Identifier. The bottom line will give the Voice number (V followed by two digits), and the Voice name (such as PIANO A.2). If this is the

THE GUIDED TOURS

case, before proceeding, to step 2 initiate the CHANGE CURRENT VOICE function by keying in 00 if the Voice Definition module is active, or 0 if the Filter or VCA/LFO module is active.

Note: We hereby formally apologize that the Voice Definition CHANGE CURRENT VOICE function (00) is not printed on the front panel label. This is because we had the labels printed up before the function was implemented, and since we have over 1,000 pricey custom labels sitting in the warehouse and we aren't about to throw them out...well, you get the picture.

1. Play a key. The display's top line will now give the Voice number and name of the Voice assigned to that key; the bottom line will most likely say "Play a Key". The **ENTER** LED will be flashing.

Example: Play a note in the lowest octave, and the display identifies the Voice...



V01 Piano A1*
Play a Key

* or possibly A2

If the bottom line reads "Again2nd Voice" instead of "Play a Key", it means that another Voice overlaps ("doubles") this key. Press the same key again; the display's top line will show the overlapping Voice, and the bottom line will say Again=2nd Voice.

2. Play different keys, one at a time, over the full range of the keyboard. The display will give the Voice number and name to which each key belongs, and (if appropriate) indicate when it is being doubled by another Voice. Take a minute or two and note where the various Voices begin and end, and which Voices are at which locations on the keyboard.

Hint: Most Emulator II owners list the pitch of the originally sampled note with a Voice name. In the previous example, Voice 01 was a piano note originally sampled at pitch of A, lowest octave (A1). Octaves are referenced so that the left-most octave spans C1-B1, the next octave to the right C2-B2, and so on until the right-most octave spans C5-C6. (Note: Early Grand Piano disks have the octave numbers offset by one. These disks are identical to newer versions in all other respects.)

3. When the display shows the Voice (or one of the Voices) to be processed, press ENTER. For now, choose any Voice and press **ENTER**; this Voice has now been assigned as the Current Voice.

THE GUIDED TOURS

4. The display now asks:

```
V01 Piano A1*  
Addl Voices? Y/N
```

* or Voice to be modified

There are two possible choices. To make this single Voice the Current Voice, press NO to tell the Emulator II you want no additional Voices; when you select a processing module, it will process only this Voice. To specify additional Voices as part of the Current Voice, press YES. For now, press YES to see how this process works.

5. The display asks:

```
V01 Piano A1*  
Entire Kybd? Y/N
```

* or Voice to be modified

To assign all Voices on the keyboard as the Current Voice, press YES; when you select a processing module, it will affect all Voices on the keyboard simultaneously. To assign additional Voices (but not the entire keyboard) as the Current Voice, press NO. For now, press NO.

6. The display asks:

```
V01 Piano A1*  
Play Addl Voice
```

* Voice numbers you just assigned

As you play additional Voices, a new Voice number and name will appear on the display's top line, while the bottom line says Play a Key. Play various keys; when the display shows a Voice you want to modify, press ENTER to make it part of the Current Voice. Before proceeding to the next step, choose a Voice and press ENTER.

7. The display now updates the Current Voice listing (top line) by displaying both of the Voice numbers chosen for processing, while the bottom line says Play Addl Voice. Continue playing additional Voices and pressing ENTER until you have assigned all of the Voices that make up the Current Voice (for now, assign one more Voice). To finish the Current Voice assignment, press ENTER once more.

Note: If you assign more than five Voices as the Current Voice, the display will list the first five Voices assigned. An additional + symbol indicates there are more Voices assigned than the display can list.

THE GUIDED TOURS

8. If all is well, the display should look something like:

Module Identifier
XX*

* Voice numbers you just assigned

9. The assigned Current Voice will remain as is until you change the Current Voice assignment, change Presets, or load another Bank. If you switch between modules, the Current Voice remains as assigned.

To change the Current Voice, initiate the CHANGE CURRENT VOICE function by keying in 00 for the Voice Definition module (see VOICE DEFINITION 00) or 0 for the Filter or VCA/LFO module (see FILTER 0 or VCA/LFO 0 respectively), then return to step 2.

Now that you know what a Current Voice is all about and how to specify it, we've reached the end of this tour (although you may need to come back from time to time to refresh your memory). In the next tour, we'll see how to modify Voices with the VCF and VCA/LFO.

THE GUIDED TOURS

GUIDED TOUR #3: THE FILTER and VCA/LFO MODULE

BACKGROUND

The filter module contains eight 24dB/octave low pass filters (one per channel) that vary a sound's high frequency content.

The VCA/LFO module contains eight VCA's that control a sound's amplitude envelope, and eight LFO's that provide modulation to the filters or VCA's.

We suggest loading in the synthesizer disk and selecting Preset 01 (arpeggiated bass/synth) to most clearly hear the filter and VCA/LFO effects, however, any other sustaining sound (strings, piano, etc.) is acceptable. We will cover the filter module first, and then proceed to the VCA/LFO module.

SPECIFYING THE CURRENT VOICE

1. Activate the Filter module (if it is not already) by pushing its button.
2. Assign the Current Voice according to the instructions given in GENERAL INSTRUCTIONS2 ("Assigning the Current Voice"); the filter will affect this Voice or these Voices. If you loaded the synthesizer disk, you may process the entire synthesizer by specifying V16, V17, V18, and V19 as the Current Voice.

To specify a different Current Voice, refer to FILTER 0.

FILTER FUNCTION 1: CHANGING CUTOFF FREQUENCY, Q, and ENVELOPE

1. After specifying the Current Voice, the display will give the Module Identifier in the top line and list the assigned Voices in the bottom line.
2. Now follow the instructions in FILTER 1 ("Frequency, Q, Envelope Amount"). When it describes how sliders A, B, and C affect the sound, vary these sliders while playing the keyboard to hear the results.

Important note: Any slider setting change will not affect the note(s) being held down (except with the Master Tune function); you must hit a new note or re-trigger the same one to hear any effect.

Since we do not yet want to exit this function, after reading step 1 in FILTER I return to this section starting with step 3.

3. After playing with the three sliders, before proceeding to the next section set Freq to 000, Q to 50, and Env to +40. Then exit the function by pressing ENTER (as described in GENERAL

THE GUIDED TOURS

FILTER FUNCTION 2: LFO AMOUNT AND KEYBOARD TRACKING

1. Follow the instructions in FILTER 2. When it describes how sliders A and B affect the sound, vary these sliders while playing the keyboard to hear the results.

As mentioned previously, slider-setting changes will not affect the note(s) being held down; you must hit a new note to hear any effect.

Since we do not yet want to exit this function, after reading step 1 in FILTER 2 return to this section starting with step 2.

2. After playing with the two sliders, before proceeding to the next section set LFO Amt to 00 and KBD Amt to 1.00, then exit the function by pressing ENTER (as described in GENERAL INSTRUCTIONS 3, "Exiting a Function").

FILTER FUNCTION 3: ADSR SETTINGS

1. Follow the instructions in FILTER 3; when it describes how sliders A, B, C, and D affect the sound; vary these sliders while playing the keyboard to hear the results. Remember, slider setting changes will not affect the note(s) being held down so you must hit a new note to hear any effect. (Since you've probably figured this out after all our repeated warnings, from now on we'll give you a break and not mention the bit about having to hit new notes anymore.)

Since we do not yet want to exit this function, after reading step 1 in FILTER 3 return to this section starting with step 2.

2. After playing with the four sliders, before proceeding to the next section set Atk = 01, Dec 01, Sus = 32, and Rel = 32. This opens up the filter all the way, and makes it easier to observe the effects of changing the VCA settings. Exit the function by pressing ENTER to return to the Module Identifier, or even more conveniently, go directly to the VCA/LFO module by activating it (as described in GENERAL INSTRUCTIONS 3, "Exiting the Function").

Since you have no doubt figured out how to Exit a Function by now, we'll stop putting in all these references to GENERAL INSTRUCTIONS 3.

THE GUIDED TOURS

VCA/LFO FUNCTION 1: ADSR SETTINGS

1. Assuming that you have the same Current Voice as specified during the previous part of the tour, the display's top line will give the Module Identifier and the bottom line will list the Voices that make up the Current Voice.
2. Follow the instructions in VCA/LFO 1; when it describes how sliders A, B, C, and D affect the sound, vary these sliders while playing the keyboard to hear the results.

Since we do not yet want to exit this function, after reading step 1 in VCA/LFO 2 return to this section starting with step 3.

3. After playing with the four sliders, before proceeding to the next section set Atk = 01, Dec = 01, Sus = 30, and Rel = 30 and press ENTER to exit the function. Entering these values lets the VCA stay open long enough to easily observe the effects of changing the LFO settings.

VCA/LFO FUNCTION 2: LFO SETTINGS

1. Follow the instructions in VCA/LFO 2, but before playing with any of the sliders, move Slider D up to maximum. This gives maximum VCA modulation, thus making it easier to hear the effects of varying sliders A-C. As you vary these three sliders, play the keyboard to hear the results, and then experiment with slider D. The Emulator II's sine wave LFO is typically used to add vibrato.

Since we do not yet want to exit this function, after reading step 1 in section VCA/LFO 2 return to this section starting with step 2.

2. After playing with the four sliders, this might be a good time to experiment some more with the Filter and VCA/LFO module settings. Or, de-activate VCA/LFO, load in a new disk, and then experiment with the Filter and VCA/LFO controls. Whatever, have a good time and when you want to find out how to use the keyboard dynamics and get into real-time modulation control, proceed to the next tour.

THE GUIDED TOURS

GUIDED TOUR #4: REAL TIME CONTROL and VIBRATO DEPTH

BACKGROUND

Ever wanted to add vibrato to a grand piano? Or bend its pitch? The Real Time Control module can do this, and lots more. Incidentally, for future reference GENERAL INSTRUCTIONS 6 ("Selecting Real Time Control Functions") contains a short form version of the material presented in the first part of this tour.

Note: The Emulator II offers two vibrato functions: Pre-programmed (which adds a constant, selectable amount of vibrato), and Real-time (where the player adds in vibrato by using one of the modulation wheels). These two are mutually exclusive; if you specify real-time vibrato, the pre-programmed vibrato will become inactive and vice-versa.

To make "live" playing as simple as possible, the display works somewhat differently for this module. Load in the disk of your choice (preferably with fairly long and sustained sounds), then activate the Real Time Control module. The display shows eight pairs of numbers:

1:0	2:0	3:0	4:0
5:0	6:0	7:0	8:0

The first number of each pair stands for one of the eight possible control sources (the left-hand column of functions printed in the module), namely:

1. Left modulation wheel (center detent, spring return type)
2. Right modulation wheel (continuously variable type)
3. Control voltage pedal (plugs into rear panel PEDAL A/D jack; also accepts any 0 to +10V control voltage source)
4. MIDI control channel A
5. MIDI control channel B
6. MIDI control channel C
7. Footswitch 1 (plugs into rear panel FOOT SW1 jack)
8. Footswitch 2 (plugs into rear panel FOOT SW2 jack)

The second number of the pair represents a control destination (the right-hand column of functions printed in the module) that you assign to a control source.

Each of the destinations printed in the upper right-hand column (0 - 7) can be controlled by control source 1, 2, or 3 or via data sent through any of the three MIDI control channels. Each destination can be controlled by only a single source; assigning a destination to another source de-assigns it from the previous source to which it was assigned.

THE GUIDED TOURS

MIDI Controls 4,5 and 6 are described more fully in PRESET DEFINITION 30, "MIDI Setup", and in the Advanced Applications section of this manual.

Each of the destinations printed in the lower right-hand column (0 - 5) can be controlled by sources 7 and 8. Each destination can be controlled only by a single source.

You'll be happy to know that Realtime control settings are memorized for each Preset. Thus, if desired each Preset can react to the real time controls and MIDI control channels in different ways.

Note: Real-time functions usually control all Voices on the keyboard. However, when making up a Preset, it is possible to exempt individual Voices from real-time control. This is described fully in VOICE DEFINITION 29 ("Control Enable").

SELECTING A CONTROL SOURCE and CONTROL DESTINATION

1. With the Real Time Control module activated, select a control source (wheel, pedal, or footswitch) by keying in its associated number. For now, enter 1 for Left wheel; the cursor will flash underneath the number to the right of the chosen control source number, thus indicating that the Emulator II is ready for you to key in the control source's destination.
2. Enter the desired destination number. For now, enter 1 so that the previously chosen Left wheel controls pitch. The flashing cursor will disappear and you will now be able to select another control source if desired. (If a control source has been previously assigned, the old assignment will be replaced with the new one.)
3. Experiment with using the Left Wheel to bend pitch, and then proceed.

REAL TIME FUNCTIONS

To learn about the real time functions, refer to the REAL TIME CONTROL section in the Reference Section. Practice assigning various destinations to the two wheels and to the footpedal (sources 1, 2, and 3 respectively).

Note: When assigning the footpedal, make sure it's plugged in to prevent unpredictable results.

Before experimenting with the footswitches (sources 7 and 8), we need to understand the difference between looped and unlooped sounds. Looping is described more fully in VOICE DEFINITION 12 and VOICE DEFINITION 13, but basically, a looped sound is one where a portion of the sound is put into an "infinite repeat" loop for as long as you hold down the key. This is similar to the infinite repeat function on digital delay lines. Looping allows for sustaining a normally non-sustaining sound for as long as you like. An unlooped sound is not artificially sustained, and therefore lasts its normal length.

Keeping this in mind, refer to REAL TIME (FOOTSWITCH DESTINATION) 0 through REAL TIME (FOOTSWITCH DESTINATION) 5 and assign various functions to the footswitches. Note

THE GUIDED TOURS

that some sounds lend themselves to these functions better than other sounds, so feel free to experiment with loading different disks to experience the full range of real time control options.

PROGRAMMING VIBRATO DEPTH

While real time control is invaluable for such applications as adding expressiveness to solo lines, for those times when you want to add a pre-programmed (constant amount) of vibrato (i.e. adding vibrato to something like a string section, preferably using vibrato delay and variation effects described later in this manual), refer to VOICE DEFINITION 23 (“Vibrato Depth”).

THE GUIDED TOURS

GUIDED TOUR #5: THE DYNAMIC KEYBOARD

BACKGROUND

The Emulator II not only delivers polyphonic dynamics, but for maximum expressiveness also allows for dynamic control over several other parameters.

The following steps set up the synthesizer sound so that any changes in dynamics are very noticeable.

1. Load the bass/synthesizer Factory Disk into the Emulator II (see section DISK 1 and DISK 2, "Get Bank from Disk"), and specify Preset 01 (arpeggiated bass/synth).
2. Activate the filter module, and specify Voices V16, V17, V18, and V19 (the synthesizer Voices) as the Current Voice; then call up FILTER 1 and set Freq120, Q30, and Env +00.
3. Activate the VCA/LFO module and select VCA/LFO 1. Set Atk01, Dec01, Sus=32, and Rel15.

ASSIGNING KEYBOARD VELOCITY TO DYNAMICS

1. Activate the Voice Definition module. Voices V16 - V19 should make up the Current Voice; if not, key in 00 to change the Voice assignment and assign these Voices (see GENERAL INSTRUCTIONS 2, "Assigning the Current Voice").
2. Follow the instructions in VOICE DEFINITION 21 and play the keyboard. Note how varying Slider A varies the overall dynamics, while varying Slider B controls how the attack time is affected by how you play the keyboard.
3. Since we do not yet want to exit this function, after reading step 1 in VOICE DEFINITION 21 proceed to VOICE DEFINITION 22 on assigning keyboard velocity to filter parameters.
4. 'When you reach step 2 in VOICE DEFINITION 22, congratulations! By this point in the Guided Tours, you have learned the rudiments of loading and modifying sounds. Proceed to the next section -- the one you've been waiting for -- on how to sample.

THE GUIDED TOURS

GUIDED TOUR #6: BASIC SAMPLING

Sampling does not just involve sticking a microphone in front of something; sampling is an art. As a result, we've devoted a whole section to the art of sampling in the Advanced Applications section of this manual. Meanwhile, this Guided Tour gives you the basics, and also lays the groundwork for guided tours of the Voice Definition and Preset Definition modules.

SETUP

1. Plug a microphone into the rear panel SAMPLE IN jack (an instrument can also be used, but a mic is easier to work with for now).
2. Format a Performance or Library disk (see DISK 8, "Format Disk"), then insert and latch it into Drive 1. The maximum available sampling time (with nothing stored in memory) is 17.6 seconds; sampling reduces this memory until all 17.6 seconds are used up. To free up as much sampling space as possible, clear out the existing memory just before sampling (to clear memory, refer to PRESET DEFINITION 16, "Erase Bank", then return). The 17.6 seconds can be divided any way you want -- one long sample, or several shorter samples. To monitor how much memory is left, refer to PRESET DEFINITION 20 ("Memory Remaining").
3. Now it's time to start the sampling process. Begin by setting levels as described in SAMPLE 1 ("VU Mode") and SAMPLE 3 ("Gain Set"), then set the threshold as described in SAMPLE 4 ("Threshold Set").
4. The Emulator II default assignment places the original sampled sound on key C2, and transposes it across the range from C1 to C3. Leave this as is for now (to change this default assignment, see SAMPLE 2, "Define Voice").
5. Once the levels, threshold, and assignment are set, begin sampling (see SAMPLE 7, "Arm Sampling"). Either sample the entire 17.6 seconds, or press 0 to stop sampling. Do not deactivate the module after the sample is complete.
6. Play the keyboard in the assigned range to hear the results of your sampling.
7. Now experiment with more sampling: Try setting a particular sample length (SAMPLE 5), using forced sampling instead of threshold-sensitive sampling (SAMPLE 9), assigning the sampled sound to other portions of the keyboard (SAMPLE 2), and also, practice terminating the sampling process (SAMPLE 0). As long as you do not de-activate the module, new samples will replace previous samples.
8. To save a Voice in memory and move on to sampling another Voice, de-activate the Sample module. The previously sampled Voice, identified with the Voice number assigned during SAMPLE 2 ("Define Voice"), will be saved in memory. Upon activating the sample module, either the top line of the display will give a number for the new Voice to be sampled, or the bottom line will say NEED MORE ROOM. The latter doesn't mean that the Emulator II is getting claustrophobic, but rather, that you've used up all the memory on previous samples. To continue experimenting, first save anything you need to save on disk (see DISK 7, "Save Bank" and VOICE DEFINITION 30, "Save Voice to

THE GUIDED TOURS

Disk”), and then create additional room by erasing all memory (see PRESET DEFINITION 16, “Erase Bank”).

9. Remember, this Guided Tour is intended simply as an overview to give you a “feel” for the sampling process. Later on, we will learn how to organize these Voices in a musically useful way.

THE GUIDED TOURS

GUIDED TOUR #7: DIGITALLY PROCESSING SAMPLES

Digital processing allows for radically altering Voices stored in the Bank. In this Guided Tour, we'll learn -- among other topics -- how to truncate, loop, reverse, splice, and mix samples. First, though, we need to take a couple of samples with which we can practice.

1. If the Emulator II has been turned off, insert a formatted Performance or Library disk in Drive 1 and boot the instrument. After booting, or if the instrument was already on, check that there is nothing in memory you want to save. If there is, save it. If not, clear the Bank memory by activating the Preset Definition module then pressing 16, YES, and YES. Finally, deactivate the module.
2. Make a sample of yourself speaking some words by doing the following:
 - a. Plug a microphone into the SAMPLE INPUT jack.
 - b. Activate the sample module and turn up the sample module GAIN control.
 - c. Talk into the mic. If the display's VU meter reads a low signal level, press 3 to increase the gain. Move Slider A until the display shows an input gain of 40 dB, then press ENTER.
 - d. While continuing to talk into the mic, adjust GAIN for the strongest possible VU meter signal short of overload.
 - e. Press 4 and use Slider A to set a threshold above the background noise present at the mic. Then press ENTER.
 - f. Press 5 and use Slider A to select about a 3 second sampling time.
 - g. Press 7 to arm sampling, and begin talking. If the sample is not good or you want to try again, press 7 and take another sample.
 - h. Play C2. You should hear your sample. Now play in the range of C1 through C3 to hear the transposed sample.
 - i. If you're not satisfied with the sample, erase it with PRESET DEFINITION 13 and try again. Once you're satisfied with the sample, de-activate the sample module. The sample you just recorded is Voice V01.
3. We will need a second sample of you talking, so...
 - j. Activate the sample module. Talk into the microphone to check for level; the level should already be correctly set from the last sample. Note that the sample module will remember the +40 dB preamp gain setting until you change it or turn off the Emulator. If the level is not correct, repeat steps C and D above.
 - k. Press 4 and use Slider A to set a threshold above the background noise present at the mic. Then press ENTER.
 - l. Press 5 and use Slider A to select about a 3 second sampling time.
 - m. We want to assign this new sample to a different range of the keyboard, so press 2.
 - n. Press C4 (this becomes the original pitch), then C3 (this sets the lowest transposition from the original pitch), then C5 (this sets the highest transposition from the original pitch).

THE GUIDED TOURS

- o. The display now identifies this Voice as NEW VOICE V02. If you want to call it by a different number, you could do so by pressing the appropriate numbers of the keypad; but for now, V02 is just fine. Press ENTER.
- p. Press 7 to arm sampling, and begin talking. If the sample is not good or you want to try again, press 7 and take another sample.
- q. Play C4. You should hear your sample. Now play in the range of C3 through C5 to hear the transposed sample. Note: The new sample's lowest key, C3, is the same as V01's highest key. When sampling, if a new sample is assigned to the same key range as an older sample, the new sample will override the old sample.
- r. If you're not satisfied with the sample, erase it with PRESET DEFINITION 13 and try again. Once you're satisfied with the sample, de-activate the sample module. You now have two samples, V01 and V02.

PLAYING A VOICE BACKWARDS

1. You can play samples backwards as well as forwards. Activate the Voice Definition module and refer to VOICE DEFINITION 27.

TRUNCATING A VOICE

1. Activate the Voice Definition module. Assign the first sample as the Current Voice by playing a key in the range of C1 - B2, then pressing ENTER (for more details, see GENERAL INSTRUCTIONS 2, "Assigning the Current Voice"). Truncating involves cutting off the beginning or end of a sample; proceed to VOICE DEFINITION 11 and adjust the sliders to hear how truncation works.
2. Practice truncating by isolating individual words from the sample. This will give you a feel for the truncation process. This may seem difficult at first, but with practice, truncation becomes second nature.
3. When you reach step 6 in VOICE DEFINITION 11, press YES to cancel the truncation so that the full sample is available for subsequent experiments in this tour.
4. If desired, change the Current Voice to V02 and experiment with truncating this sample as well as V01. Again, upon reaching step 6 in VOICE DEFINITION 11, press YES to cancel the truncation so that the full sample is available for subsequent experiments in this tour.

THE GUIDED TOURS

LOOPING A VOICE

1. Activate the Voice Definition module if it is not already, and assign V01 as the Current Voice.
2. Refer to VOICE DEFINITION 12 to graphically see how looping affects a sample. Experiment with looping different parts of the sample; try looping individual words or sentence fragments.

Please remember that looping is a very complex process that requires a great deal of practice for proficiency. The only way to fully understand looping is to practice with a variety of signals. The purpose of this Guided Tour is to acquaint you with the concept of looping, but there is much more to the subject than simply fooling around with looping words from a spoken sample. For more information, refer to the Advanced Applications section of this manual.

3. After establishing a loop, refer to VOICE DEFINITION 13 for how to change the loop to a backwards/forwards loop.
4. After establishing a looped Voice, activate the VCA/LFO module, and press 1 to adjust the ADSR parameters. Set attack and decay to 01, sustain to 32, and release for a long release time (i.e. 26) in accordance with VCA/LFO 1.

Next, play the Voice until you start hearing the looped section. Release your finger from the key; note how the Voice continues to loop. This is because the Emulator II defaults to "loop in release" mode, where the loop continues to play -- even after you lift your finger off the key -- for as long as the VCA release lasts. To selectively activate or deactivate this mode, refer to VOICE DEFINITION 26.

SPLICING VOICES

Splicing marks an end point in one sample and a start point in a second sample; the first sample end and second sample start are then joined together. See VOICE DEFINITION 14 to graphically see how this process works, then follow the instructions given to splice the two samples together. When you reach step 9, read all the way through but make sure you press NO in order to keep the original samples intact for subsequent exercises. (Of course, you could always press YES and re-record two samples for the next part.)

COMBINING VOICES

Combining mixes two samples together digitally into a single sample whose length equals that of the longer sample. Assuming you still have two samples on the keyboard, follow the instructions in VOICE DEFINITION 14 and combine them. If not, clear the Bank memory and record two samples as instructed at the beginning of this section.

SAVING VOICES

Maybe you haven't created a masterpiece of a Voice, but maybe you have. If you'd like to save the Voice, take a formatted Library disk and put it in Drive 1 (if you have a dual-drive Emulator II and already have a disk in Drive 1, feel free to put the formatted Library disk in Drive 2). Then follow the instructions in VOICE DEFINITION 30 to save the Voice to disk.

THE GUIDED TOURS

GUIDED TOUR #8: OTHER VOICE DEFINITION FUNCTIONS

We will now cover the remaining Voice Definition functions. Begin by selecting the Bass + Synth disk, inserting it in Drive 1, activating the Disk module, and pressing 1 to load the disk into the Bank. Select Preset 01 if it is not already.

CHECKING SOUND LENGTH

1. To familiarize yourself with this process, assign a Current Voice and follow the steps under VOICE DEFINITION 15.

SOLO MODE

1. Activate the Voice Definition module, and assign all synth Voices (V16, V17, V18, and V19 -- the top split of the keyboard) as the Current Voice.
2. Follow the steps under VOICE DEFINITION 25.
3. Before proceeding, cancel Solo Mode by activating the Voice Definition module, keying in 25, pressing NO, and then ENTER.

VOICE ATTENUATION AND TUNING

The Current Voice can be made softer than the other Voices on the keyboard, and its tuning can also be changed with respect to the other Voices.

1. Follow the steps given in VOICE DEFINITION 24. Play the synthesizer part of the keyboard as you vary Slider A; note how the amplitude of the Current Voice changes with respect to the other Voices. Then vary Slider B and note how the tuning changes.
2. Return to 00 attenuation and 00 cents tuning variation before proceeding.

CONTROL ENABLE

Control enable exempts particular Voices from Real Time control.

Example: To bend pitch in the upper register of the keyboard but not the lower register, exempt the lower register Voices from the pitch bend function.

1. Activate the Voice Definition module and follow the steps in VOICE DEFINITION 29. Practice enabling and disabling various real time control functions for different Voices.

THE GUIDED TOURS

GUIDED TOUR #9: MANAGING THE BANK

These are Preset Definition functions that don't necessarily do glamorous things, but are very useful. This Guided Tour acquaints you with these utilitarian functions.

Begin by loading a Performance disk (see DISK 1 or DISK 2).

WHAT'S IN THE BANK?

1. Refer to PRESET DEFINITION 19, which tells how to catalog the various Presets in the Bank.
2. Next, refer to PRESET DEFINITION 17, which tells how to catalog the various Voices in the Bank.
3. To find out if there is any space left in memory for doing more experiments, refer to PRESET DEFINITION 20.

COPYING AND ERASING WITHIN THE BANK

1. Now's the time to learn how to copy and rename Voices. Refer to PRESET DEFINITION 12', and select the highest-numbered Voice on the disk with Slider A. Copy it into the next highest Voice number, and give it a name. If there's "Not Enough Memory", try another Voice or boot up a different disk.
2. Next, eliminate the copy you just made of the Bank Voice in step 1 by referring to PRESET DEFINITION 13 ("Erase Voice").
3. Copy and rename a Preset by referring to PRESET DEFINITION 31. If there's "Not Enough Memory", try copying a different Preset or boot up a different disk.
4. Eliminate the copy you just made of the Preset by referring to PRESET DEFINITION 15 ("Erase Preset").
5. While we're at it, let's cover replication. Replicate a Preset by referring to PRESET DEFINITION 22, and then catalog the Voices (PRESET DEFINITION 17). Note how a new set of Voices has been created through replication, as indicated by an * after the Voice name.

Clear memory (PRESET DEFINITION 16), before embarking on the next Guided Tour.

THE GUIDED TOURS

GUIDED TOUR #10: CREATING PRESETS and LIBRARY DISKS

In the following tour, we'll make up a Preset from Voices. We recommend that you sample four or five Voices, use these to create a Preset, then save them to disk. Alternately, you can load a Performance disk and use those Voices to create Presets; however, you will not be able to check out the Library disk functions presented in this tour.

Incidentally, the process of sampling and creating a good Preset is a lengthy one. It can take hours to end up with a great Preset, and a couple more hours to "tweak" it up and create additional Presets. For the sake of getting through these exercises in a reasonable amount of time, make simple vocal samples using a microphone and create simple Presets.

1. If you have not already, clear the Bank (PRESET DEFINITION 16). Then, sample five or six different Voices into the Bank. Refer to the previous Guided Tour on sampling, and the SAMPLE MODULE Reference section for details. If you've already created a Library disk of Voices, you may load some of these into the Bank instead -- see PRESET DEFINITION 11.
2. Create a Preset (PRESET DEFINITION 21), renaming if desired, then assign the Bank Voices to the Preset (PRESET DEFINITION 22). Make sure to overlap some of the Voices so that you can check out the Velocity Crossfade (PRESET DEFINITION 26), Velocity Switch (PRESET DEFINITION 25), and Positional Crossfade (PRESET DEFINITION 27) functions.
3. Now experiment with other Preset Definitions. Edit a Voice assignment (PRESET DEFINITION 23), de-assign a Voice (PRESET DEFINITION 24), and put a Voice in Nontranspose mode (PRESET DEFINITION 28).
4. Save one of the Voices to a Library disk by specifying a current Voice and then referring to VOICE DEFINITION 30. Save the remaining Voices in a similar manner.
5. Still looking for more fun? Call up the arpeggiator (PRESET DEFINITION 29). That should keep you occupied for a while.
6. For information on how to transfer Voices from various Performance and Library disks to a single Performance disk, thus creating a multi-instrument Performance disk, refer to Part 4 in the section on Advanced Applications.

This has been a very fast, and somewhat superficial, tour of the world of Library disks and Presets. For tips and techniques on how to make best use of the Emulator II's resources when creating Presets, Banks, Performance disks, and Library disks, refer to the Advanced Applications section of this manual.

GENERAL INSTRUCTIONS

GENERAL INSTRUCTIONS

- 1 - SELECTING THE CURRENT PRESET**
- 2 - ASSIGNING THE CURRENT VOICE**
- 3 - EXITING A FUNCTION**
- 4 - LIBRARY DISKS**
- 5 - DISK HANDLING**
- 6 - REALTIME FUNCTIONS**
- 7 - CATALOGUING**
- 8 - KEYBOARD NUMBERING PROTOCOL**

GENERAL INSTRUCTIONS

1 - SELECTING THE CURRENT PRESET

This function chooses one of the available Bank Presets.

1. With no modules active, the display will show the Current Preset name and number. The blinking cursor will appear under the first digit of the Preset number.
2. To change the Current Preset, enter a two-digit number with the keypad. If you enter a number for which there is no Preset, the display lower line will give the illegal Preset number and say NOT FOUND. Try again.
3. To determine the Current Preset at any time, de-activate any active modules. The Current Preset name and number will show in the display.

GENERAL INSTRUCTIONS

2 - ASSIGNING THE CURRENT VOICE

The processing modules (Filter, VCA/LFO, and Voice Definition) can process each Voice in a Preset, as well as groups of Voices in the Preset, individually. Therefore, it is necessary to specify the Voice, or group of Voices, to be processed. This Voice or group of Voices is called the Current Voice.

1. To assign the Current Voice, one of the processing modules must be active and the bottom display line must say Play a Key. If the display says something else, before proceeding to step 2 initiate the CHANGE CURRENT VOICE function by keying in 00 if the Voice Definition module is active (remember, this function is not printed on the front panel label), or 0 if the Filter or VCA/LFO module is active (refer to sections VOICE DEFINITION 00, FILTER 0, or VCA/LFO 0 respectively).
2. Play a key. The display's top line will now give the Voice number and name to which that key belongs; the bottom line will most likely say, "Play a Key".

If the bottom line reads "Again2nd Voice" instead of "Play a Key", it means that another Voice overlaps ("doubles") this key. Press the same key again; the display's top line will show the overlapping Voice, and the bottom line will say "Again2nd Voice".

3. As you play different keys, one at a time, the display will give the Voice number and name to which each key belongs, and (if appropriate) indicate when it is being doubled by another Voice.
4. When the display shows the Voice (or one of the Voices) to be processed, press ENTER.
5. The display now asks:

V01 Bass E1
Addl Voices? Y/N

GENERAL INSTRUCTIONS

There are two choices. To select this one Voice as the Current Voice, press NO to tell the Emulator II you want no additional Voices; the display will return to the Module Identifier and the Current Voice assignment process is complete. When you select a processing module, it will process only this Voice.

To specify additional Voices as part of the Current Voice¹, press YES. The display then asks:

```
V01 Bass E1
Entire Kybd? Y/N
```

6. Again, there are two choices. To specify all Voices on the keyboard as the Current Voice, press YES; the display will return to the Module Identifier and the Current Voice assignment process is complete. When you select a processing module, it will affect all Voices on the keyboard simultaneously. To specify additional Voices (but not the entire keyboard) as the Current Voice, press NO.

7. The display now asks:

```
V01 Bass E1
Play Addl Voice
```

As you play additional Voices, a new Voice number and name will appear on the display's top line, while the bottom line says Play a Key. Play various keys; when the display shows a Voice you want to assign to the Current Voice, press ENTER. The display will update the Current Voice listing (top line) by displaying both of the assigned Voice numbers, while the bottom line says Play Addl Voice. Continue playing additional Voices and pressing ENTER until you have assigned all desired Voices to the Current Voice. To finish the Current Voice assignment process, press ENTER once more.

Note: If you specify a Current Voice with more than five Voices, the display will list the first five Voices assigned. An additional + symbol indicates there are more Voices assigned than the display can list.

8. The specified Current Voice will remain as is until you either change the Voice assignment (see FILTER 0, VCA/LFO 0, and VOICE DEFINITION 00), change Presets, or load another Bank. If you switch between modules, the Current Voice remains as assigned.

¹ VOICE DEFINITION 11 and 12 (Truncate and Loop) can process only one Voice at a time. When the Current Voice consists of more than one Voice, these functions will process only the first Voice listed in the display.

GENERAL INSTRUCTIONS

3 - EXITING A FUNCTION

After modifying a Current Voice or Preset by adjusting any of its parameters, you have three options on how to proceed.

1. Press **ENTER**. You will remain in the currently selected module, ready to select another function. The display top line will show the Module Identifier.
2. De-activate the module (Emulator II returns to Current Preset).
3. Activate another function within the module or activate another module.

Remember: A modified Voice or Preset is saved in the Bank, which loses its memory when the power goes off. To permanently save modified individual Voices and complete Banks, save to Library and Performance disks respectively.

4 - LIBRARY DISK VOICE NUMBERING PROTOCOL

Voices are stored in the Bank under Voice numbers, which range from V01 to V99. When a Voice is saved to a Library disk, the Voice number designation is replaced with a File number designation, and the Voice is stored on the disk under the lowest available File number.

The reason for changing from a Voice to File number is that many times, different Voices from different Banks will have the same Voice number (for example, with one Bank Voice 10 might be a piano sound; in another Bank, Voice 10 could be a snare drum). Saving these like-numbered Voices to disk would cause problems (i.e. should a like-numbered Voice over-write an existing Voice, change its Voice number, or what?); also, loading Voices from a Library disk would also be more complicated (if you had two Voices on disk named V01 and tried to load V01 into the Bank, which would be the proper one to load?).

Using File numbers solves these problems. When loading Voices from a Library disk (PRESET DEFINITION 11, "Get Voice"), specify the File number of the Voice to be loaded, then assign the Bank Voice number into which you want to load the Voice. Once in the Bank, the Voice is referred to only by its Voice number.

GENERAL INSTRUCTIONS

5 - DISK HANDLING

Disks represent the sum total of your experience with the Emulator II, and should be handled with care.

Common Courtesy for Disks

Disks should never be:

- Bent or sat on
- Exposed to strong magnetic fields (TV's, speakers, etc.)
- Subjected to temperature extremes
- Left out in the sun
- Touched where any of the inner plastic disc is exposed
- Used for coasters or Frisbees.

Disks should always be:

- Stored vertically in their protective jackets
- Kept away from dust, dirt, and smoke
- Treated carefully and gently.

Disk Type

The Emulator II requires double-sided, double-density, 48 tracks- per-inch (TPI) 5.25" floppy disks.

The Disk Drive

Before transporting the Emulator II (even if it's only across the room), always insert and latch either the original packing material (see SETUP in the Introduction) or a "scrap" disk into each drive. This protects the drive from vibration. Do not use a good disk, as it could become damaged during transit.

When active, the Drive's LED will light. Do not try to operate the Emulator II controls when the LED is on. The mechanism will occasionally make whirring and "clunking" sounds; these are normal.

Labeling Disks

Write on the adhesive label before attaching it to the disk. Writing on a label attached to a disk can damage it; but if you're the gambling type, at least use a felt-tip pen and apply very little pressure.

GENERAL INSTRUCTIONS

Write-Protecting Disks

Write-protecting a disk turns off the disk drive's ability to record on to the disk, thus preventing accidental erasure. To write-protect a disk, fold a small adhesive tab (usually supplied with the disk) over both sides of the disk so that the write-protect notch (see **Fig. GENINS-1**) is completely covered (see **Fig. GENINS-2**). As long as the notch is covered, you will not be able to accidentally record over the disk.

If you try to write on a disk and cannot, check whether it is write-protected before proceeding.

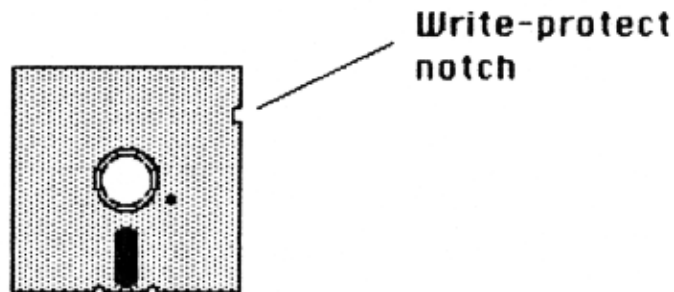

Fig. GENINS-1

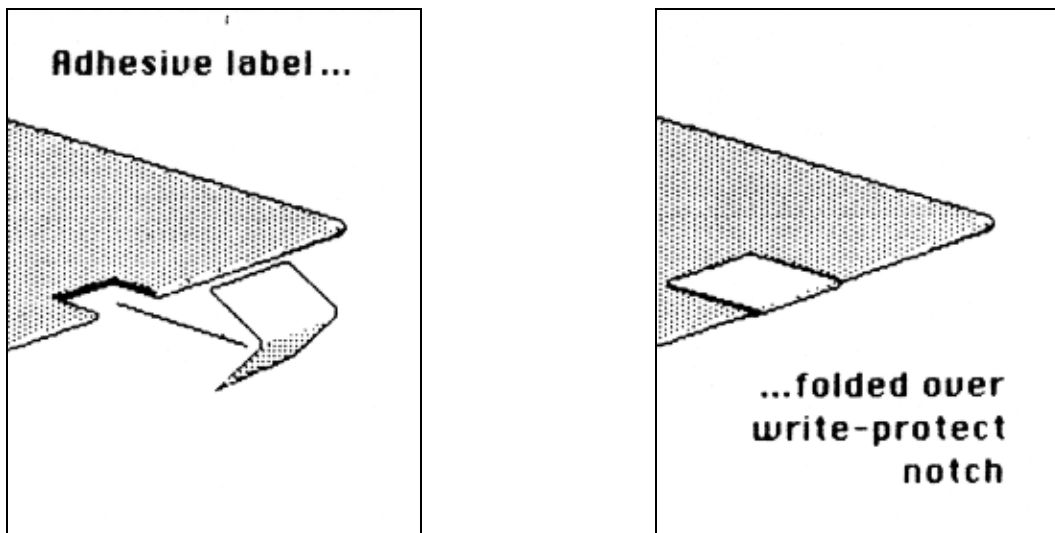

Fig. GENINS-2

GENERAL INSTRUCTIONS

Single-drive vs. Dual-drive Emulator II's

A dual-drive Emulator II offers more convenience than a single-drive Emulator II, particularly for copying disks. In this manual, we will assume a dual-drive Emulator II (with the top drive = Drive 1 and the lower drive = Drive 2) except where noted.

Inserting the Disk in the Drive

Referring to **Fig. GENINS-3**, first make sure that the latch is in the open position. Next, insert an Emulator II disk label side up with the labelled side going in last (see **Fig. GENINS-4**). Gently push the disk all the way in until it can go no further, then turn the latch clockwise 90 degrees until it clicks into place (straight down position).

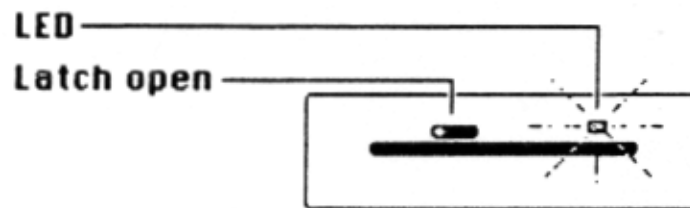

Fig. GENINS-3

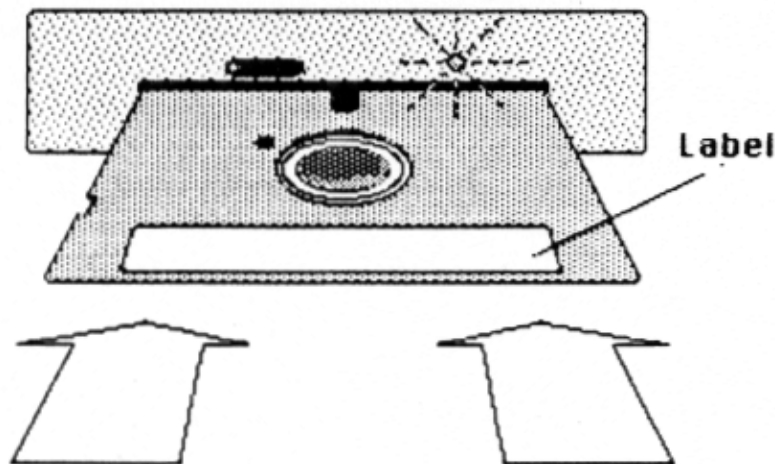

Fig. GENINS-4

Always have a Disk in the Top Drive!

Because Emulator II disks contain Operating System software that is occasionally referenced by the computer, there must always be either a Performance disk or Library disk in the top drive.

GENERAL INSTRUCTIONS

6 - SELECTING REAL TIME CONTROL FUNCTIONS

Real time functions are designed for fast, easy selection while playing live. Each Preset can have its own unique set of pre-programmed real time functions.

1. Activate the Real Time Control module.
2. The display shows each control source as a pair of numbers. The first digit of each pair represents the control source, the second digit the control source's destination. Select the control source to which you want to assign a destination by keying in the appropriate control source number:
 - 1: Left modulation wheel (center detent, spring return type)
 - 2: Right modulation wheel (continuously variable type)
 - 3: Control voltage pedal (plugs into rear panel PEDAL A/D jack; also accepts any 0 to +10V control voltage source)
 - 4: MIDI control channel A
 - 5: MIDI control channel B
 - 6: MIDI control channel C
 - 7: Footswitch 1 (plugs into rear panel FOOT SW1 jack)
 - 8: Footswitch 2 (plugs into rear panel FOOT SW2 jack)
3. Each of destinations 0 - 7 printed in the upper right-hand column of the module can be controlled by control source 1, 2, or 3. Each destination can be controlled by only a single source.
4. In addition to being controlled via the Emulator II's controllers, these destinations can also be controlled via MIDI. First, up to three destinations are assigned to the three MIDI control sources (4, 5, and 6). Second, these MIDI control sources are given controller numbers (see PRESET DEFINITION 30). These numbers match up with the numbers of the controllers "transmitting" data from a MIDI unit into the Emulator II. For more information, see the MIDI supplement.
5. Each of destinations 0 - 5 printed in the lower right-hand column of the module can be controlled by sources 7 and 8. Each destination can be controlled only by a single source.
6. The cursor will flash under the second number of the pair, indicating that you may now select one of the destinations printed on the right-hand side of the module (and listed in the REAL TIME CONTROL section of this manual). There are eight destinations (0-7) available for the first six control sources, and six additional destinations (0 - 5) available for control sources 7 and 8 (footswitches). Sources cannot share destinations.

Note: Real-time functions usually control all Voices on the keyboard. However, when making up a Preset, it is possible to exempt Voices from real-time control. This is described fully in VOICE DEFINITION 29 ("Control Enable").

Note: For some Presets on factory disks, default destinations will already have been selected. For other Presets, all control sources will be turned OFF (0).

GENERAL INSTRUCTIONS

7 - CATALOGUING

Several commands allow you to catalog the Voices, Presets, and Sequences in a Bank. For example, when erasing a Voice, you can catalog the Voices to make sure you are erasing the right one.

In each case, cataloguing occurs by moving Slider A. The slider motion corresponds to moving a list of Voices, Presets, or Sequences underneath the display window (see **Fig. GENINS-5**). In other words, moving the slider up will cause progressively higher Voice or Preset numbers to be visible in the display, while moving the slider downwards will cause progressively lower Voice or Preset numbers to be visible in the display.

Note: Some functions ask you to enter a particular Voice, Preset, or Sequence number either via the keypad or by cataloguing. When cataloguing, to enter a Voice, Preset, or Sequence, simply press ENTER whenever the desired Voice, Preset, or Sequence appears.

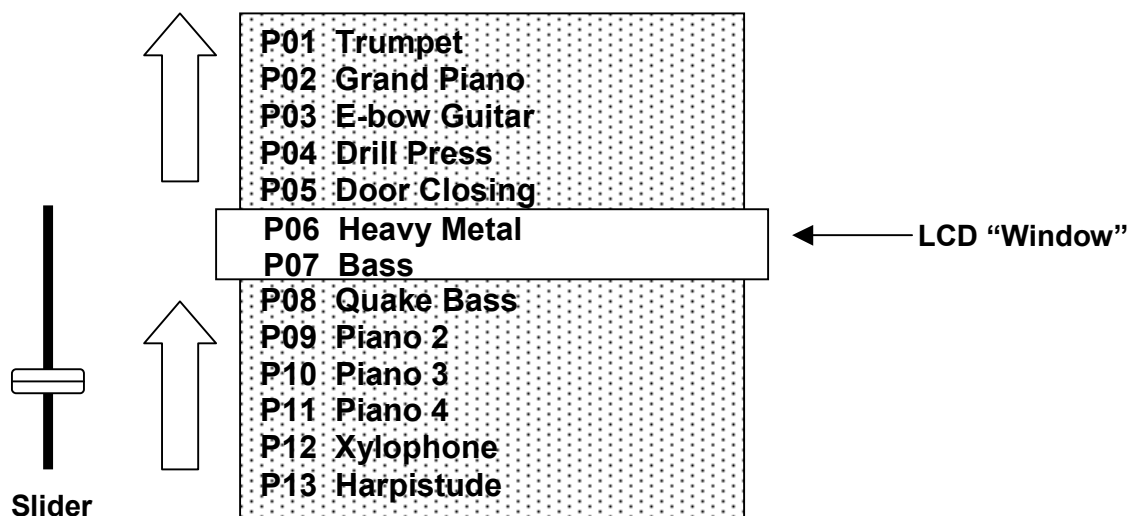

Fig. GENINS-5

Moving the slider up moves the list of Voices or Presets up underneath the LCD "window".

Note: Some functions ask you to enter a particular Voice, Preset or Sequence number either via the keypad or by cataloguing. When cataloguing, to enter a Voice, Preset or Sequence, simply press ENTER whenever the desired Voice, Preset or Sequence appears.

GENERAL INSTRUCTIONS

8 - KEYBOARD NUMBERING PROTOCOL

Several functions reference particular keyboard keys. E-mu numbers the keyboard keys as follows.

The left-most (lowest) C is C1. The next highest note is C#1, then D1, D#1, E1, etc. through to B1. After B1, the next higher C is C2. Notes proceed upwards from C2 (C#2, D2, D#2, E2, etc.) until the next higher C, which is C3. Notes count upwards in a similar fashion until reaching the very highest C, which is C6.

In summary:

The lowest octave spans the range C1 - B1.
The next octave higher spans the range of C2 - B2.
The next octave higher spans the range of C3 - B3.
The next octave higher spans the range of C4 - B4.
The next octave higher spans the range of C5 - B5.
The very highest note is C6.

MASTER CONTROL MODULE

MASTER CONTROL MODULE

DYNAMIC ALLOCATION

TUNE

TRANSPOSE

DOUBLE MEMORY

MASTER CONTROL MODULE

DYNAMIC ALLOCATION

This function bypasses existing Voice to Output Channel assignments, and makes all Voices available at all Channels (as if all Voices were assigned to Channels 1 – 8, refer to PRESET DEFINITION 22, “Assign Voice”).

Application: Audition all Voice sounds without having to listen to specific Channels.

1. Press DYNAMIC ALLOCATION to override Voice Output Channel assignments; press again to de-activate.

TUNE

This function enables tuning the Emulator II to other instruments.

1. Press TUNE. The display says:

**TUNING YXX CENTS
USE SLIDER**

..where XX is a two-digit number and Y indicates plus or minus.

2. As you play the keyboard, vary slider A to change tuning. The display will indicate whether you are sharp (+) or flat (-) compared to the normal keyboard pitch, and by how many cents (up to +48 cents, -50 cents). Note that the tunings of individual Voices can also be varied (see VOICE DEFINITION 24).
3. Press TUNE again to store the new tuning and de-activate the tune function.

MASTER CONTROL MODULE

TRANSPOSE

This function transposes the keyboard in half-step intervals up to \pm one octave.

Applications: Use one key's fingerings in a different key. Modulate to a different key without having to use different fingerings.

1. Press and hold TRANSPOSE; its LED will light. The display says:

TRANSPOSED C2
PLAY A KEY

2. The display shows the amount of transposition referenced to C2 (see GENERAL INSTRUCTIONS 8), the second C from the left-hand side of the keyboard. Therefore, if the display says C2 there is no transposition.
3. To transpose: Continue to hold TRANSPOSE and press a key between C1 and C3. The display shows which keyboard key you have selected for the transposition ratio (compared to C2).
4. To retain the transposition: Release TRANSPOSE (its LED stays lit to remind you the Emulator II is transposed).
5. To cancel the transposition: Press and hold TRANSPOSE, press C2, and then release TRANSPOSE (its LED should now be off).

Note: When transposing, remember that a Voice cannot be transposed more than ± 1 octave. Therefore, if you transpose the keyboard in such a way that the highest note of the highest Voice is lower than the highest note of the keyboard (or the lowest note of the lowest Voice is higher than the lowest note of the keyboard), transposition will not occur beyond this limit. Under these conditions, rather than leaving blank keys the Emulator II fills the beyond-transposition-limit keys with notes from the closest available octave.

We know this sounds pretty complicated - and the following example sounds pretty complicated, too - but once you actually try transposing the Emulator II keyboard it should all make sense.

Example: Suppose a Voice is assigned with its lowest note as C4, its original note as C5, and its highest note as C6. If you transpose up a fifth (G2), the note that was formerly G5 will end up at C5, and the highest note (formerly C6) will end up at F5. The Voice cannot "manufacture" new notes higher than the highest note (formerly C6, now F5), so the Voice will not be transposed between F5 and C6. Instead, the Emulator II fills up these keys with notes from the nearest available octave. In this case, G5 has the same pitch as G4, A5 has the same pitch as A4, and so on.

MASTER CONTROL MODULE

DOUBLE MEMORY

The Emulator II+ is available in three models: a single-disk drive version, a dual disk drive version, and a hard disk version. Each model is equipped with a feature we call “Double Memory”. This function allows you to load and access two floppy disk sound banks in the machine’s memory, by switching from one bank to the other. The overall operation and performance of the instrument is otherwise not affected.

To use, turn on the Emulator II+ with a floppy disk in the disk drive (the top one, if you have a dual drive model.) We’ll use disk #4 “Grand Piano” as an example. Wait for the Emulator II+ to finish booting. You have now loaded the Grand Piano into Sound Bank A.

Press Preset 00 on the keypad to switch banks. Because there is nothing loaded into the second bank, the display should read:

```
P01 NULL PRESET  
Swapped>Bank B
```

Now load another floppy into Bank B, for example disk #5, “Marcato Strings”, by pressing Disk Module 1 (or 2 if you have a dual drive model, and have the disk in the second drive.)

Press 00 again to return to Sound Bank A. The display should read:

```
P01 Piano #1  
Swapped>Bank A
```

Press 00 to access Bank B again. The display should read:

```
P01 Marcato Strg  
Swapped>Bank B
```

Both banks are now loaded with sounds, and available for use.

Note: Double Memory is not contiguous - either bank can be saved to disk, but not both simultaneously.

You’ll need to save each bank to a separate floppy disk. (Whenever you press Disk 7 you will save to disk the bank currently active.)

1. Insert a blank formatted floppy disk (see Guided Tour #1 for formatting instructions) in the disk drive and secure the latch.
2. Press Disk 7
3. Press Disk 1 for single-drive EII+ owners, or Disk 1 or 2 for dual-drive owners. (Depending on the location of the floppy disk being saved to.)
4. When the first sound bank has been saved, swap banks (Preset 00) and repeat the procedure described above.

MASTER CONTROL MODULE

DOUBLE MEMORY HARD DISK SAVES

Hard disk EII+ owners have the option of also saving each Double Memory sound bank to hard disk for quick access. Follow the procedure for saving to the floppy disk drive:

1. Select the Bank to be saved,
2. Press Disk 7
3. Press Disk 02 - 47 (available hard disk banks in EII+ memory)
4. Swap Double Memory sound banks (Preset 00), and repeat the hard disk save procedure.

Please see the Hard Disk Supplement for details on saving sounds to hard disk.

FILTER MODULE

FILTER MODULE

0 - CHANGE CURRENT VOICE

1 - FREQUENCY, Q, ENVELOPE AMOUNT

2 - LFO AMOUNT, KEYBOARD AMOUNT

3 - ADSR SETTINGS

FILTER MODULE

0 - CHANGE CURRENT VOICE

This function lets you change the Current Voice assignment.

1. To change the Current Voice, with the module active, key in 0.
2. The display's top line lists which Voices make up the current Voice. If more than five Voices have been assigned, the display shows the first five assigned Voices and a + symbol. The bottom line invites you to Play a Key.
3. Follow the Voice assignment process described in GENERAL INSTRUCTIONS 2.

1 - FREQUENCY, Q, ENVELOPE AMOUNT

This function determines the filters initial cutoff frequency and Q (sharpness), as well as the extent to which the associated ADSR envelope affects the filter cutoff frequency.

Application: Change the timbral quality of a sound.

1. With the module active, Current Voice assigned (see GENERAL INSTRUCTIONS 2), and the ENTER LED either lit steadily or off, key in 1. The display says:

Freq	Q	Env
XXX	XX	XXX

...where X is a numeral.

Freq, controlled by Slider A, ranges from 000 to 120. Higher values correspond to higher filter cutoff frequencies. Its maximum sweep range is most obvious with Env set to +00.

Q, controlled by Slider B, ranges from 00 to 99. Higher values correspond to increased resonance, which gives a sharper, more whistling sound.

Env, controlled by Slider C, ranges from -50 (maximum inverted envelope) to +00 (no envelope) to +50 (maximum positive envelope). It is usually necessary to raise the filter cutoff value when using inverted envelopes.

2. To exit to another function, see GENERAL INSTRUCTIONS 3 ("Exiting a Function").

FILTER MODULE

2 - LFO AMOUNT, KEYBOARD AMOUNT

This function determines the extent to which the LFO modulates the filter cutoff frequency, and also sets keyboard tracking between 0.00 (minimum) and 1.87 (maximum).

Application (Keyboard Tracking): With no tracking, a sound will become progressively less bright as you play higher on the keyboard. This is useful with some bass sounds, where you don't want the high notes to sound too trebly. With normal tracking (keyboard amount 1.00), the timbre of a sound remains constant as you play up the keyboard. This is generally used to give the most realistic synthesizer and instrument sounds. With overtracking (keyboard amount greater than 1.00), the overall timbre becomes brighter as you play higher up on the keyboard. This is useful for playing upper keyboard register leads that really "cut" while also playing a more sedate, muted line in the lower registers.

1. With the module active, Current Voice assigned (see GENERAL INSTRUCTIONS 2), and the ENTER LED either lit steadily or off, key in 2. The display says:

LFO Amt	KBD Amt
XX	X.XX

...where x is a numeral.

LFO Amt, controlled by Slider A, determines the extent to which the LFO modulates the filter cutoff frequency. Range is from 00 to 15, with higher values giving more modulation.

Note: LFO rate, delay, and variation are set from the VCA/LFO module (see VCA/LFO 2).

KBD Amt, controlled by Slider B, sets the filter tracking from 0.00 (no tracking) to 1.87 (overtracking). With 0.00 tracking, the filter cutoff will not be affected by the keyboard pitch. With 1.00 tracking, the filter cutoff will precisely track the keyboard pitch. With 1.87 tracking, the filter cutoff will change at almost twice as fast a rate as keyboard pitch changes.

2. To exit to another function, see GENERAL INSTRUCTIONS 3 ("Exiting a Function").

FILTER MODULE

3 - ADSR SETTINGS

This function sets the attack, decay, sustain, and release characteristics of the filter ADSR envelope generator.

Application: Change the filter cutoff frequency dynamically with respect to time.

1. With the module active, Current Voice assigned (see GENERAL INSTRUCTIONS 2), and the ENTER LED either lit steadily or off, key in 3. The display says:

Atk	Dec	Sus	Rel
XX	XX	XX	XX

...where X is a numeral.

Hint: Filter and VCA settings interact. For example, if the VCA is set for an extremely short decay, then you won't hear the effects of setting a long filter attack or decay.

Atk, controlled by Slider A, varies the filter envelope attack time from 01 to 32 (higher values increase the attack time).

Dec, controlled by Slider B, varies the filter envelope initial decay time from 01 to 32 (higher values increase the initial decay time). 32 gives "infinite decay" (envelope stays at maximum amplitude for as long as you hold down keys).

Sus, controlled by Slider C, varies the filter envelope sustain level from 01 to 32 (higher values give higher sustain levels).

Rel, controlled by Slider D, varies the filter envelope release time from 01 to 32 (higher values increase the release time). A setting of 32 inhibits the release phase of the envelope, thus keeping the filter open at the previously selected Sustain level. This is useful if you want to trigger a long sound by simply tapping a key.

Note: If the VCA and filter release are both at 32 (also see VCA/LFO 1), a key will sustain at the sustain level even after you take your fingers off the keys. This is like the HOLD function found on standard synthesizers. The sound will continue to sustain unless you play more notes than there are available channels, in which case previously assigned channels will be assigned to newly played notes.

2. To exit to another function, see GENERAL INSTRUCTIONS 3 ("Exiting a Function").

LFO/VCA MODULE

LFO/VCA MODULE

0 – CHANGE CURRENT VOICE

1 – ADSR SETTINGS

2 – LFO PARAMETERS AND VCA AMOUNT

LFO/VCA MODULE

0 - CHANGE CURRENT VOICE

This function lets you change the **Current Voice assignment**.

1. To specify the Current Voice, with the module active key in 0.
2. The display's top line lists which Voices make up the current Voice. If more than five Voices have been assigned, the display shows the first five assigned Voices and a + symbol. The bottom line invites you to Play a Key.
3. Follow the Voice assignment process described in GENERAL INSTRUCTIONS 2.

1 - ADSR SETTINGS

This function sets the **attack, decay, sustain, and release characteristics of the VCA's ADSR envelope generator**.

Application: Change a Voice's dynamics with respect to time.

1. With the module active, Current Voice assigned (see GENERAL INSTRUCTIONS 2), and the ENTER LED either lit steadily or off, key in 1. The display says:

Atk	Dec	Sus	Rel
XX	XX	XX	XX

...where X is a numeral.

Hint: Filter and VCA settings interact. For example, if the VCA is set for an extremely short decay, then you won't hear the effects of setting a long filter decay.

Atk, controlled by Slider A, varies the VCA envelope attack time from 01 to 32 (higher values increase the attack time).

Dec, controlled by Slider B, varies the VCA envelope initial decay time from 01 to 32 (higher values increase the initial decay time). 32 gives "infinite decay" (envelope stays at maximum amplitude for as long as you hold down keys).

Sus, controlled by Slider C, varies the VCA envelope sustain level from 01 to 32 (higher values give higher sustain levels).

Rel, controlled by Slider D, varies the VCA envelope release time from 01 to 32 (higher values increase the release time). A setting of 32 inhibits the release phase of the envelope, thus keeping the VCA open at the previously selected Sustain level.

Note: If the filter and VCA release are both at 32 (also see FILTER 3), a key will sustain at the sustain level even after you take your fingers off the keys. This is like the HOLD

LFO/VCA MODULE

function found on standard synthesizers. The sound will continue to sustain unless you play more notes that there are available channels, in which case previously assigned channels will be assigned to newly played notes.

2. To exit to another function, see GENERAL INSTRUCTIONS 3 (“Exiting a Function”).

2 - LFO PARAMETERS AND VCA AMOUNT

This function sets three LFO parameters (initial rate, delay before onset of LFO modulation, and LFO variation), and also determines the extent to which the LFO modulates the VCA.

Application: After pressing a key(s), LFO delay (function 2B) delays the onset of vibrato by an adjustable amount. This simulates an effect often used by string players, where the vibrato is brought in only after the initial note pitch has been clearly established.

Application: LFO variation (function 2C) adds a randomised quality to ensemble sounds by providing slightly different vibrato rates for each key being held down. This can make orchestral Voices sound truly polyphonic.

Application: LFO modulating VCA (function 2D) provides tremolo effects, as used for years in guitar amplifiers.

1. With the module active, Current Voice assigned (see GENERAL INSTRUCTIONS 2), and the ENTER LED either lit steadily or off, key in 2. The display says:

Rate	Del	Var	VCA
XX	XX	XX	XX

...where x is a numeral.

Slider A controls the LFO Rate from 01 to 99 (higher values give a faster modulation rate).

Slider B controls LFO Delay (the amount of time between hitting a key and the onset of modulation). Range is from 00 to 99, with 99 giving an approximate 2 second delay.

Slider C controls LFO Variation. In addition to having true, one-LFO-per-Voice polyphonic modulation, the Emulator II also has a great new feature called variation. With 00 variation, each key will have the same vibrato rate. Increasing variation (to a maximum of 15) alters the LFO rate every time you hit a key; the higher the number, the greater the variation in LFO frequency. For effects such as ensemble playing, the variation feature is invaluable as it creates the illusion of multiple players, each having their own vibrato rate.

Slider D determines the extent to which the LFO modulates the VCA level.

VOICE DEFINITION MODULE

VOICE DEFINITION MODULE

- 00 - CHANGE CURRENT VOICE
- 11 - TRUNCATE START AND END OF SAMPLE
- 12 - SET LOOP START AND LOOP LENGTH POINTS
- 13 - FORWARD/REVERSE LOOP
- 14 - SPLICE
- 15 - SOUND LENGTH
- 21 - VELOCITY ASSIGNMENT TO LEVEL AND ATTACK
- 22 - VELOCITY ASSIGNMENT TO FILTER
- 23 - VIBRATO DEPTH
- 24 - VOICE ATTENUATE/TUNE
- 25 - SOLO MODE
- 26 - LOOP IN RELEASE
- 27 - BACKWARDS MODE
- 28 - COMBINE VOICES
- 29 - CONTROL ENABLE
- 30 - SAVE VOICE TO DISK

VOICE DEFINITION MODULE

00 - CHANGE CURRENT VOICE

This function lets you change the Current Voice assignment. A special prize will be awarded to any Emulator II owner who finds this function printed on the front panel label.

1. To change the Current Voice, with the module active, key in 00.
2. The display's top line lists which Voices make up the current Voice. If more than five Voices have been assigned, the display shows the first five assigned Voices and a + symbol. The bottom line invites you to Play a Key.
3. Follow the Voice assignment process described in GENERAL INSTRUCTIONS 2.

VOICE DEFINITION MODULE

11 - TRUNCATE START and END of SAMPLE

Truncation shortens a Voice's length by trimming off parts of the beginning and/or end.

Applications: Cut off unneeded portions of a Voice to conserve memory. Change instrument characteristics (i.e. remove the attack from a plucked string note). Cut off long decay (i.e. simulate noise-gated reverb effect on drums). Use to isolate a particular section of a sample.

1. With the module active, assign the Current Voice (see GENERAL INSTRUCTIONS 2).
Note: Truncation works on only one Voice at a time. If the Current Voice contains more than one Voice, the first Voice listed in the display will be truncated.
2. After assigning the Current Voice (the ENTER LED will be off), key in 11. The display says:

```
Trun Start 000000
Trun End 000000
```

...and the ENTER light will flash.

Hint: It is good practice to move sliders A and B all the way down, and sliders C and D all the way up, before truncating. This puts them in their "no truncation" positions.

3. The six digits in the upper display line indicate, in samples, how much is being cut off the start of the Voice. Slider A gives coarse control over the start truncation, Slider B fine control. Moving the sliders upwards increases the amount of truncation. Example: Adjusting these sliders so that the bottom line indicates Trun Start 027500 cuts one second off the beginning of the sample (see **Fig. VDEF-1**).

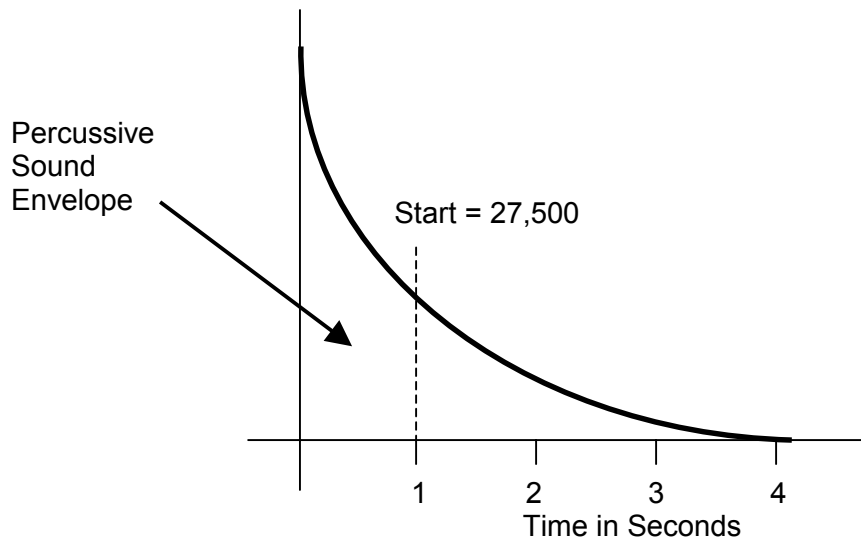

Fig. VDEF- 1

VOICE DEFINITION MODULE

Note that samples are truncated in groups rather than one sample at a time, even with the fine truncation slider. Also note that activating Slider B may alter Slider A's initial setting; readjust Slider A to compensate. Go back and forth between these two controls until you find the ideal start truncation point.

4. The six digits in the lower display line indicate, in samples, how much is being cut off the end of the sample. Slider C gives coarse control over end truncation, Slider D fine control. Moving the sliders downwards increases the amount of truncation.

Example: Adjusting these sliders so that the top line indicates Trun End 027500 cuts one second off the end of the sample (see **Fig. VDEF-2**).

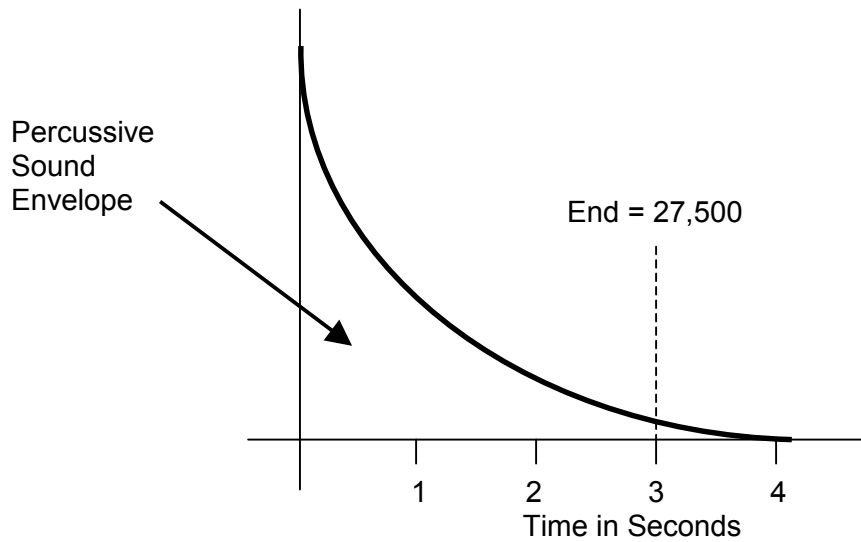

Fig. VDEF- 2

VOICE DEFINITION MODULE

As with start truncation, samples are truncated in groups rather than one at a time, even with the fine truncation slider. Also, activating Slider D may alter Slider C's initial setting; readjust Slider D to compensate. Go back and forth between these two controls until you find the ideal end truncation point.

5. After setting the desired truncation points, press ENTER. The display asks:

**Cancel
Truncation? Y/N**

Now's your chance to bail out, if need be, and start over again. Press YES to cancel truncation and return to the Module Identifier. Otherwise, press NO and proceed.

6. The display now asks:

**Make Truncation
Permanent? Y/N**

To permanently erase the truncated sections, press YES. To retain the truncated information in memory (so that you can truncate the sample again later in a different way), press NO. Either response will return you to the Module Identifier.

Note: If you want to erase the truncated sections to conserve Bank memory, yet keep a copy the untruncated Voice, save it to a Library disk (see VOICE DEFINITION 30).

7. If you try to truncate a sample which has already been truncated, but for which the truncation has not been made permanent, display will first ask:

**Cancel
Truncation? Y/N**

If you press YES, the Emulator II assumes you didn't really want to truncate the sample and returns to the Module Identifier. If you press NO, the display will read the current truncation settings. You may continue to play with truncation, or exit to another function as described in GENERAL INSTRUCTIONS 3 ("Exiting a Function").

VOICE DEFINITION MODULE

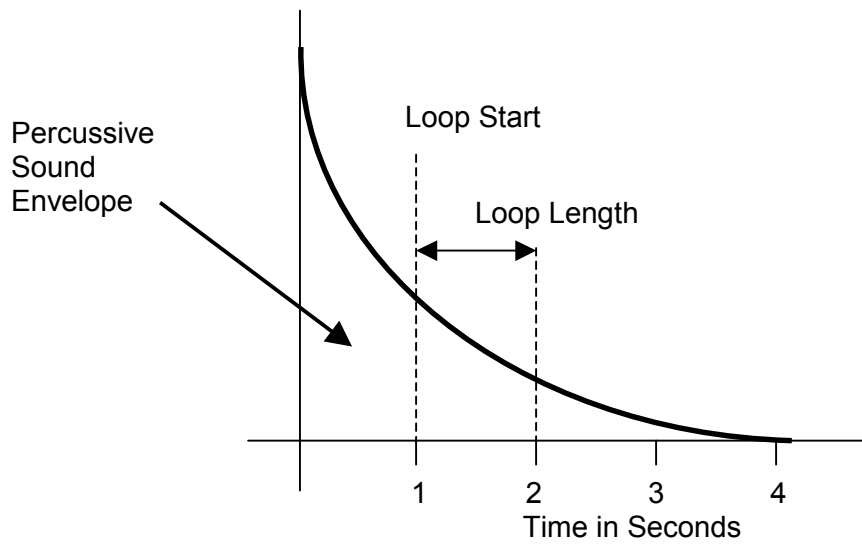

Fig. VDEF- 3

VOICE DEFINITION MODULE

12 - SET LOOP START and LOOP LENGTH POINTS

“Looping” lets you mark off a section (called a loop) of a Voice with a Start point and loop Length (see Fig. VDEF-3). When you press a key, the Voice plays normally until it reaches the end of the loop. It then jumps back to the Start point and re-plays through the loop. Upon reaching the loop end, it again re-plays the loop. This looping process continues for as long as the key is pressed. Fig. VDEF-4 indicates a typical looping action. (Note: VOICE DEFINITION 26 lets the loop continue even after you remove your fingers from the keys to accommodate sounds with long release times. VOICE DEFINITION 13 provides an alternate looping action where the loop plays both backwards and forwards. Refer to these sections for specifics.)

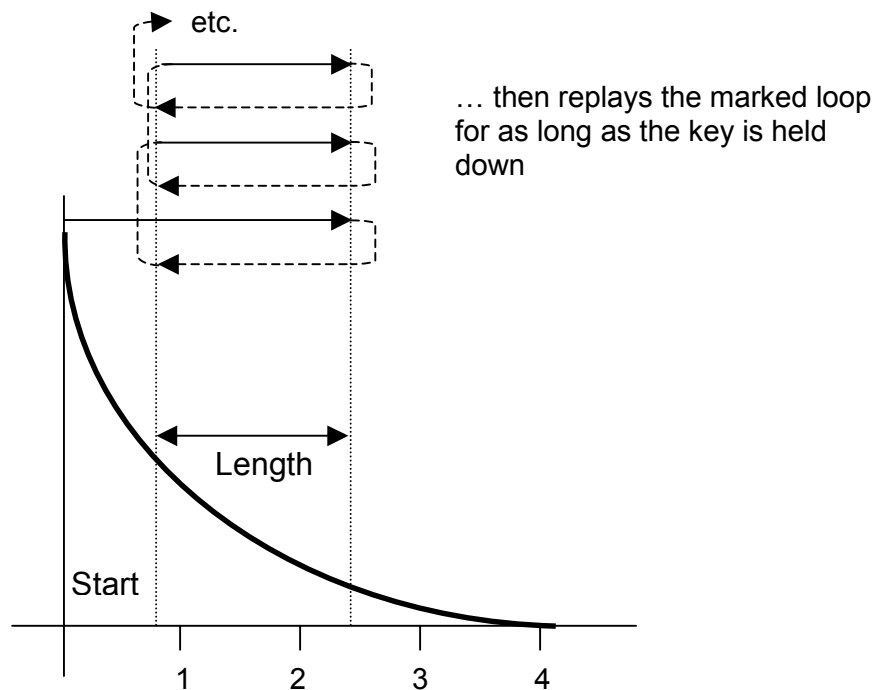

Fig. VDEF-4

Applications: Looping provides “infinite sustain” effects, extends short samples, and if the loop is rhythmically related to a composition, produces interesting rhythmic effects.

1. With the module active, assign the Current Voice (see GENERAL INSTRUCTIONS 2).

Note: Looping works on only one Voice at a time. If you specify more than one Voice as the Current Voice, the first Voice listed in the display will be looped.

2. After assigning the Current Voice (the ENTER LED will be off), key in 12. The display says:

VOICE DEFINITION MODULE

S000004 LXXXXX
AutoLp:Press Yes

...and the ENTER light flashes. S is the Start point of the loop, and L is the loop Length in samples. Initially, S is set to the beginning of the Voice (approximately 000000) and L equals the length of the sample.

3. **Remember** -- L sets the Length, not the end point, of the loop. Example: Consider the loop in **Fig. VDEF- 5**. When S moves, the loop end point (as determined by the loop Length) moves in tandem with S.

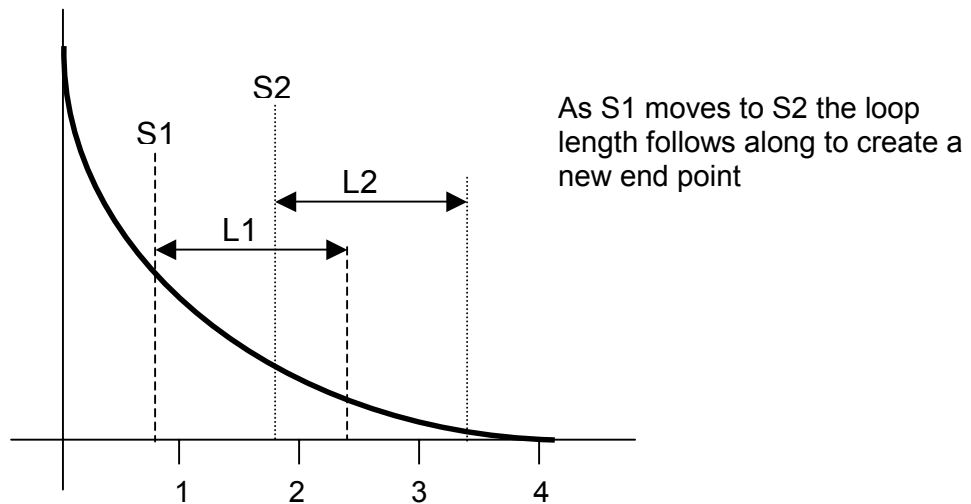

Fig. VDEF- 5

Hint: If the loop Length is at maximum (as occurs when you first call up a Voice for looping), you cannot set a new S point since that would force the loop to “run out of sample” (see **Fig. VDEF- 6**). Shorten the Length before moving the S point.

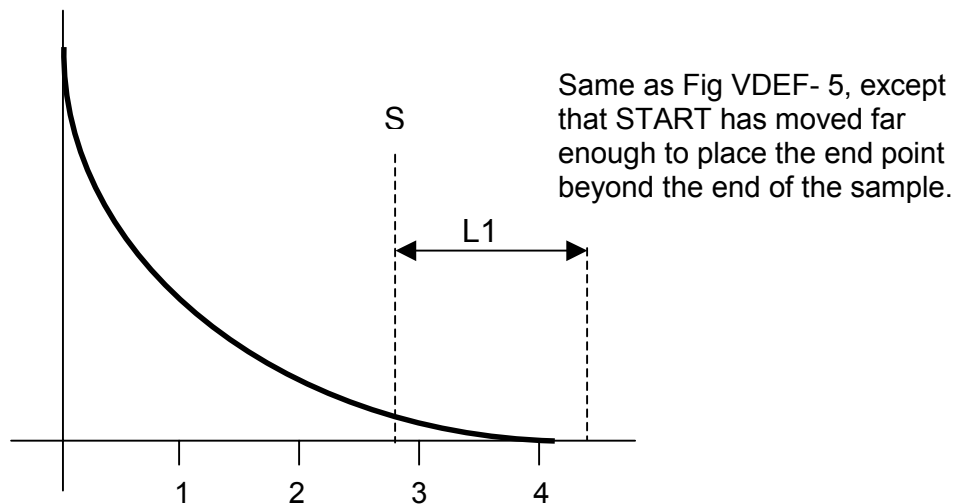

Fig. VDEF- 6

VOICE DEFINITION MODULE

Hint: It is good practice to move sliders A through D all the way down before looping. This sets the Start point to the beginning of the sample and the loop Length to 000000. With a loop Length of 000000, there is nothing to loop; therefore, when you press a key, the sample will stop playing as soon as it encounters the loop. This makes it easier to set the loop Start point.

4. The six digits following the S indicate, in samples, where the loop starts. Slider A gives coarse control over the Start point; Slider B gives fine control. Moving the sliders upwards moves the Start point closer to the end of the sample.

Example: Adjusting these sliders so that the top line reads S027500 means that the Start point is located one second into the sample (see Fig. VDEF- 7).

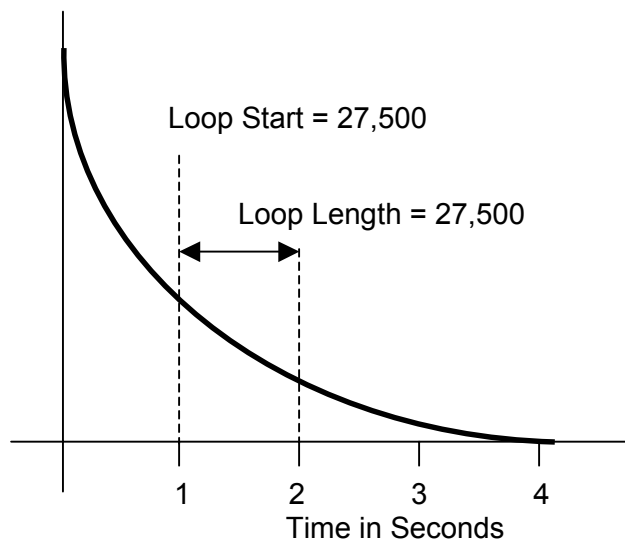

Fig. VDEF- 7

Note: The Start time is adjusted in groups of samples rather than one sample at a time, even with fine control Slider B. Also note that activating Slider B may alter Slider A's initial setting; re-adjust Slider A to compensate. Go back and forth between these two controls until you find the desired Start point.

5. The six digits following the L indicate, in samples, the loop Length. Slider C gives coarse control over the loop Length, Slider D fine control. Moving the sliders upwards increases the loop Length.

Example: Adjusting these sliders so that the top line reads L027500 means that the loop is one second long (see Fig. VDEF- 7).

Note: The Length is adjusted in groups of samples rather than one sample at a time, even with the fine control slider D. Also note that activating Slider D may alter Slider C's initial setting; re-adjust Slider C to compensate. Go back and forth between these two sliders until you find the desired Length point.

VOICE DEFINITION MODULE

Before proceeding, study the following background information about Autolooping.

About Autolooping

Looping performs an electronic “cut and paste” (splice) which sometimes produces annoying glitches. Here’s why.

Refer to **Fig. VDEF- 8**, which shows the waveform where a sample is to be looped. As the signal loops, note the discontinuity at the “splice point”. This can produce an annoying ticking or popping sound.

Fortunately, the Emulator II is a smart instrument and can help find the optimum splice point for you. Set the S and L points as best you can with the sliders, then press YES to invoke Autoloop. The computer will look for nearby points that can be spliced together with minimum discontinuity. Example: If you invoke Autoloop for the sample given in **Fig. VDEF- 9**, the computer will find a good splice point in the vicinity of the S and L points you programmed (see **Fig. VDEF-10**). The display will update to reflect the computer-chosen S and L points.

How well does Autolooping work? Incredibly well, once you get the hang of it (getting the most out of this function does require practice). Autoloop can save you much time when doing looped samples, and is remarkably effective with short, sustained samples.

VOICE DEFINITION MODULE

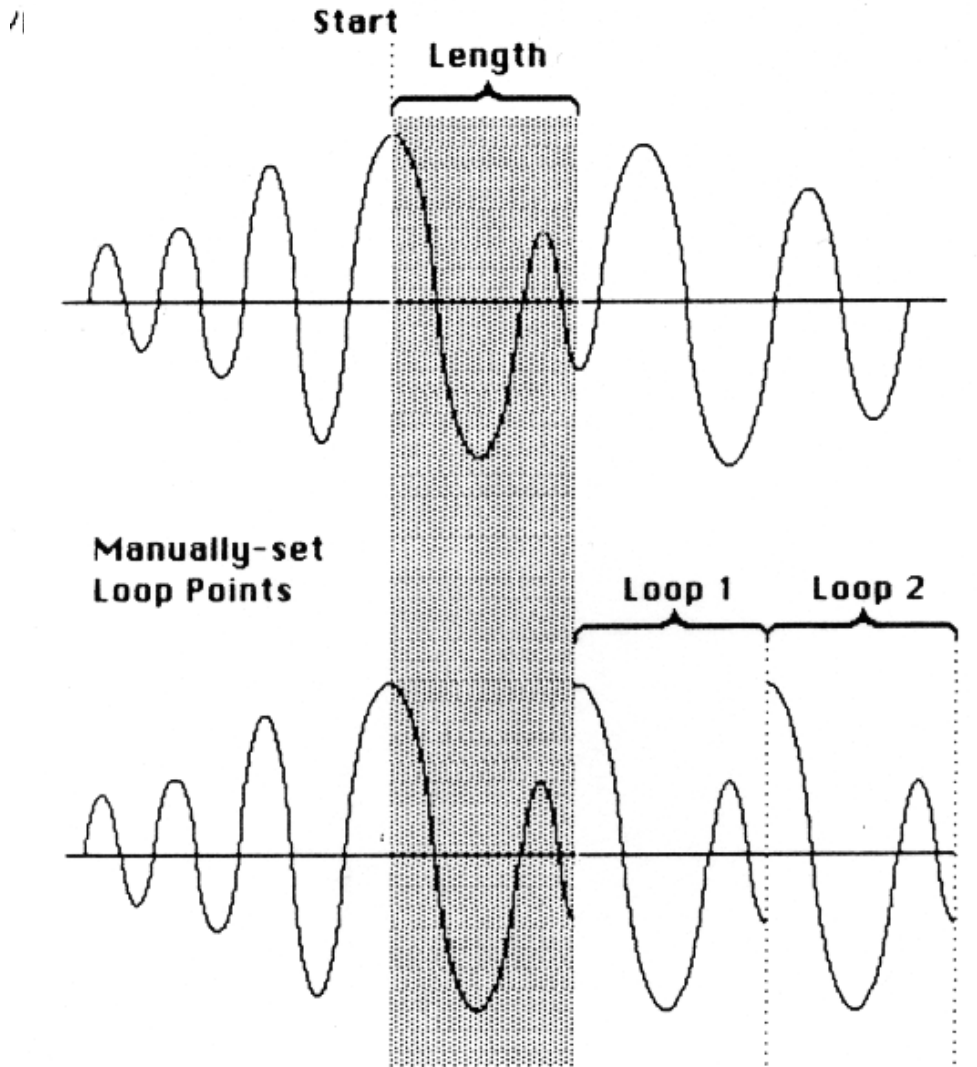

Fig. VDEF- 8

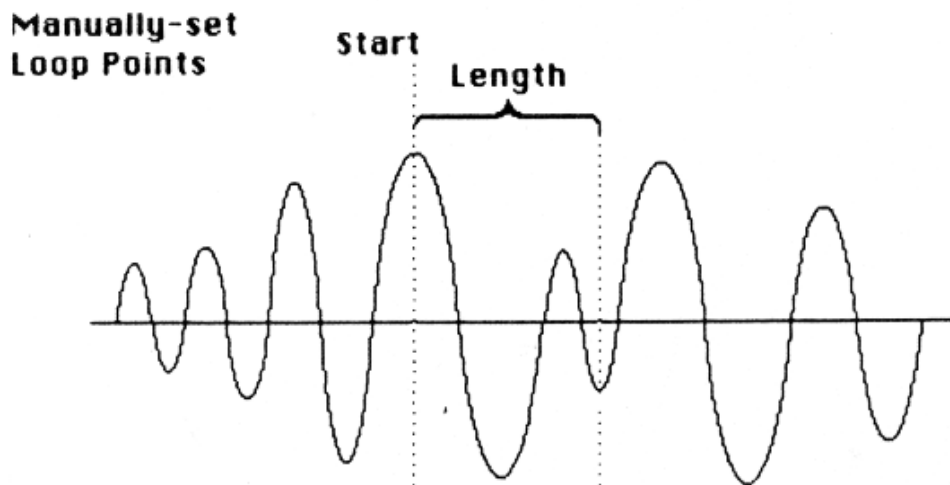

Fig. VDEF- 9

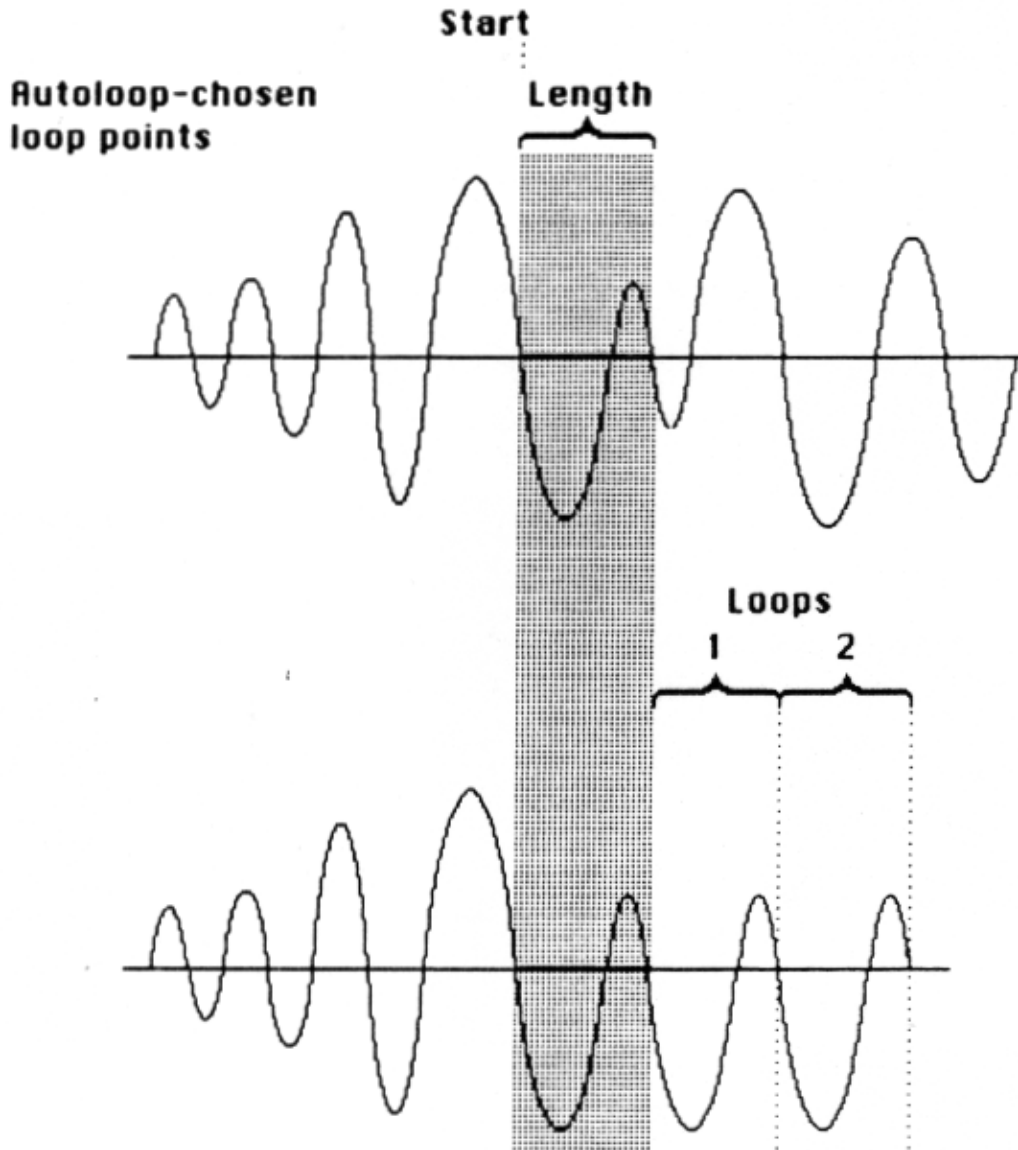

Fig. VDEF-10

6. After finding good loop S and L points, see if Autoloop can produce an even better loop. Press YES at any point during the looping process to invoke Autoloop.

Note: The Emulator II is very intelligent, but not quite as hip as a human. So, sometimes it will choose the correct splice point from a technical standpoint, not a musical one. Therefore, if you find a good splice point, write down the S and L numbers before invoking Autoloop. That way, if by some chance Autolooping produces an inferior splice point, you can regain your original setting (or close to it) by moving the sliders.

VOICE DEFINITION MODULE

7. To try for another splice point, move the sliders and press YES again for Autoloop. Continue moving the sliders in small increments and pressing YES until you end up with a glitch-free loop.

Note: Sometimes it will be impossible for you or the computer to find a perfect splice point. When you first try looping, you will probably think this is a common occurrence. However, you'll generally find that Autoloop, combined with practice and experimentation, can usually produce smooth, glitch-free loops.

8. After establishing the desired loop points, press ENTER The display asks:

Remove Loop?
Press Y/N

9. To remove the loop and return to the Module Identifier, press YES. If you don't want to remove the loop, press NO; the display then asks:

Trunc After Loop
Press Y/N

10. This gives the option of discarding all of the Voice data after the loop end point. Pressing YES will help conserve memory; however, if you might want to use the same sample later with a different loop point, either save it to a Library disk (VOICE DEFINITION 30) before pressing YES, or press NO to keep the entire sample intact. Pressing NO returns you to the Module Identifier.

11. If you press YES in step 8, the display asks:

Set Lp in RIs?
Press Y/N

12. This lets you select the Loop in Release function. Press NO, and when you lift your fingers off the keys the Voice will play through to the end of the loop and then stop. Press YES, and the loop will continue playing after you release the key(s) if any release time has been programmed. For more information on Loop in Release, see VOICE DEFINITION 26. Pressing either NO or YES returns you to the Module Identifier.

VOICE DEFINITION MODULE

13 - FORWARD/REVERSE LOOP

See VOICE DEFINITION 12 for a description of standard looping. With forward/reverse looping, upon reaching the end of the loop the loop plays “backwards” to the loop Start point, then forwards to the end of the loop, then backwards to the loop Start point, etc. See Fig. VDEF-11.

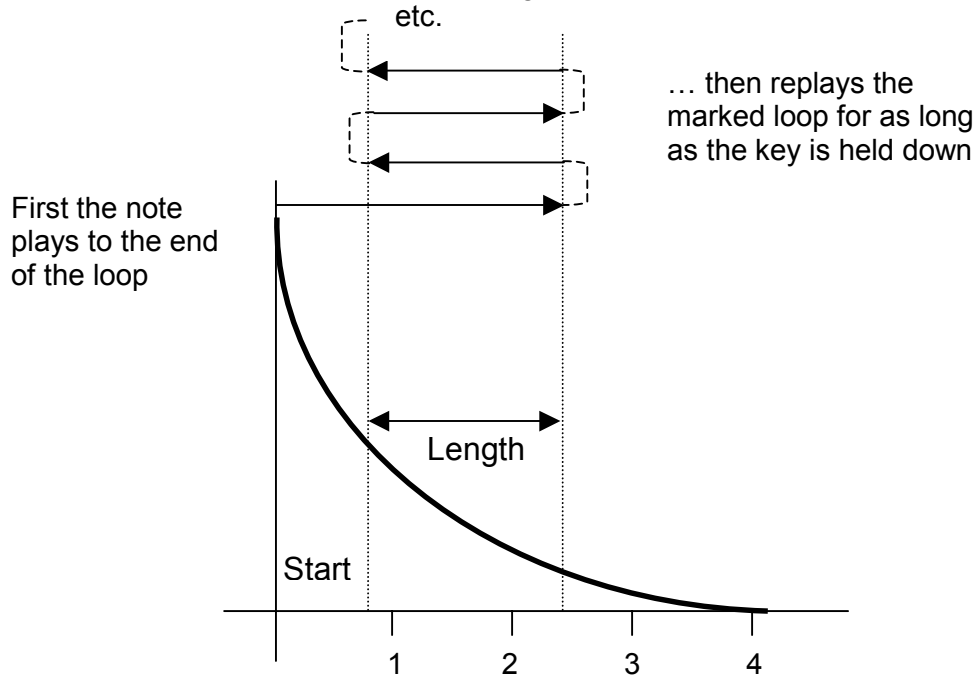

Fig. VDEF-11

Application: Some sustained sounds (string section, fuzz guitar, and long samples) loop more smoothly with this looping mode. Experiment when looping to determine if this mode gives better results.

1. With the module active, assign the Current Voice (see GENERAL INSTRUCTIONS 2). Unlike truncation and normal looping, when specifying forward/reverse looping the Current Voice can consist of more than one Voice.

After assigning the Current Voice (the ENTER LED will be off), key in 13. The display gives the default setting (forward/reverse loop off):

```
**Mode:  no
Press Y/N
```

...and the ENTER light will flash. To select the forward/reverse loop, press YES. To cancel a previously initiated forward/reverse loop, press NO. Either answer returns you to the Module Identifier.

Note: When in Forward/Reverse mode, the loop Length display for the loop function (the second set of numbers in VOICE DEFINITION 12's display)

VOICE DEFINITION MODULE

changes to show the loop End point. This is more appropriate since the loop begins its repeat from the End point. Because of the display change, while in VOICE DEFINITION 12 you can easily tell whether the loop is forward/reverse or normal --just check whether the second set of digits begins with E or L.

VOICE DEFINITION MODULE

14 - SPLICE

Splicing marks an End point in one sample and a Start point in a second sample, then joins the end of the first sample to the start of the second sample. Portions of the samples not used in the spliced version are discarded, and any loops are ignored. Fig. VDEF-12 summarizes how splicing works.

Applications: Splice an unusual attack to one sample, or unusual decay on to another. Do multiple short splices on multiple samples, one splice at a time, to create complex "tape collage" effects.

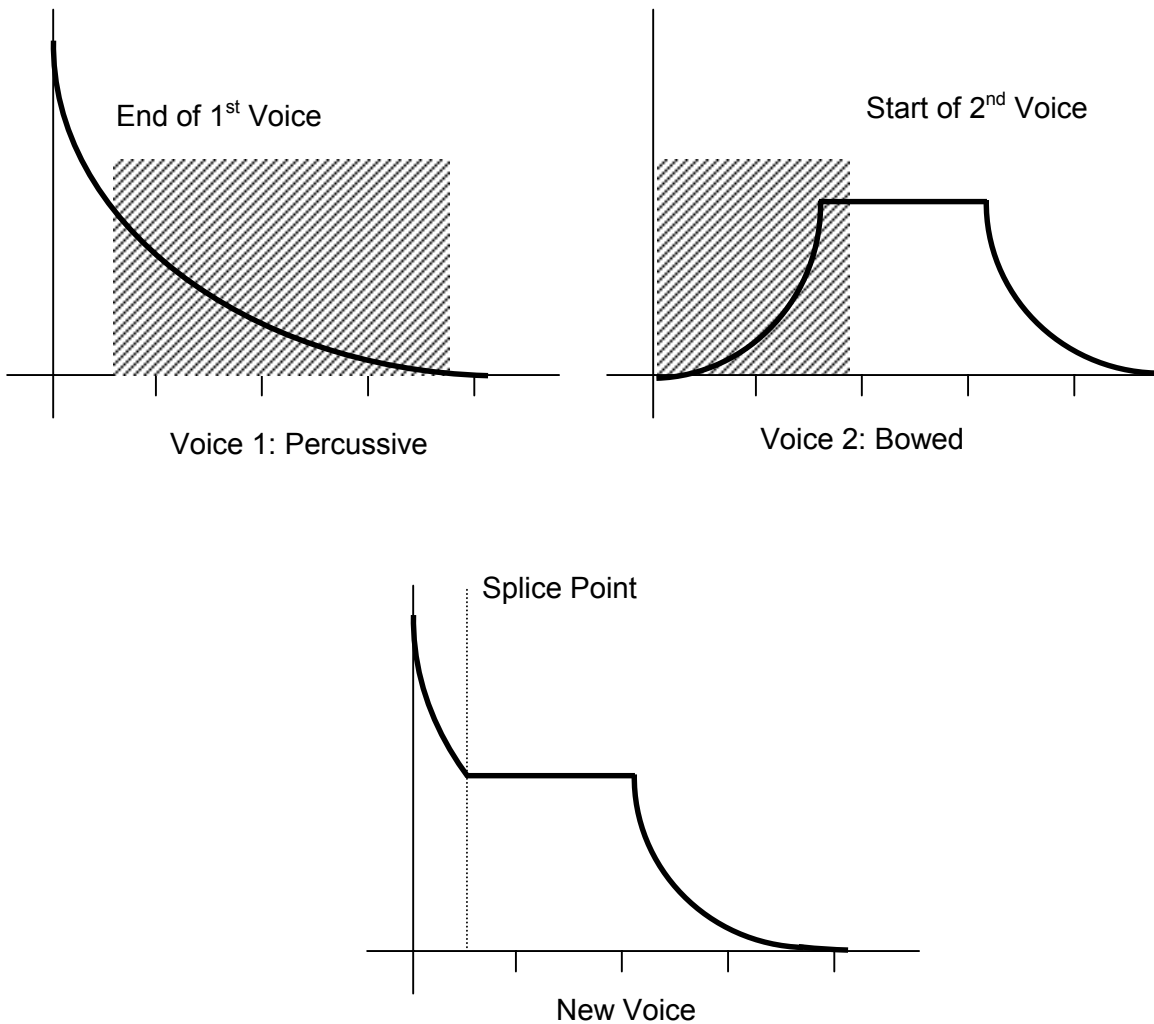

Fig. VDEF-12

VOICE DEFINITION MODULE

1. With the module active, assign the Current Voice (see GENERAL INSTRUCTIONS 2). This Voice provides the first part of the spliced sound.
2. After assigning the Current Voice (the ENTER LED will be off), key in 14. The display asks:

Splice with V__
Use Slider A

...and the ENTER light will flash. Either use the keypad to specify the Voice number that will provide the second half of the splice, or move Slider A to catalog (see GENERAL INSTRUCTIONS 7) the Voices available for splicing. When the display shows the Voice to be spliced on to the initially selected Voice, press ENTER.

3. The display now says:

EXXXXXX S000000
AutoSp: Press Yes

...where XXXXXX is the initial End point of the first Voice and 000000 is the initial Start point of the second Voice.

Hint: It is good practice to move sliders A through D all the way up before splicing. This turns off the second Voice (by setting its Start point at the end of the Voice), thus making it easier to concentrate on setting the proper End point in the first Voice.

4. The six digits following the E indicate, in samples, the first Voice's End point. Slider A gives coarse control over the End point; Slider B gives fine control. Moving the sliders downwards shifts the End point closer to the beginning of the sample. Example: Adjusting these sliders for a reading of E027500 means that the end point is located one second into the sample.

Note: The End point is adjusted in groups of samples rather than one sample at a time, even with the fine control Slider B. Also note that activating Slider B may alter Slider A's initial setting; re-adjust Slider A to compensate. Go back and forth between these two controls until you find the desired End point.

5. The six digits following the S indicate, in samples, the second Voice's Start point. Slider C gives coarse control over the Start point; Slider D gives fine control. Moving the sliders downwards shifts the Start point closer to the beginning of the Voice. Example: Adjusting these sliders so that the top line reads SO27500 means that the Start point is one second into the second Voice.

Note: The Start point is adjusted in groups of samples rather than one sample at a time, even with the fine control Slider D. Also note that activating Slider D may alter Slider C's initial setting; re-adjust Slider C to compensate. Go back and forth between these two controls until you find the desired End point.

VOICE DEFINITION MODULE

Before proceeding, study the following background information On Autosplicing.

About Autosplicing

Splicing two Voices together can sometimes produce an annoying glitch at the splice point. Consider **Fig. VDEF-13**, which shows two samples being spliced together; note the discontinuity at the "splice point". This can produce an annoying ticking or popping sound.

As with Autolooping, the Emulator II can help you find the optimum splice point. Set the splice points as best you can with the sliders, then press YES to invoke Autosplice. The computer will look for places within the Voices that can be spliced together with minimum discontinuity. Example: If you call up Autosplice for the sample given in **Fig. VDEF-14**, the computer will find a good splice point in the vicinity of the E and S points you chose (see **Fig. VDEF-15**). The display will update to reflect the computer-chosen E and S points.

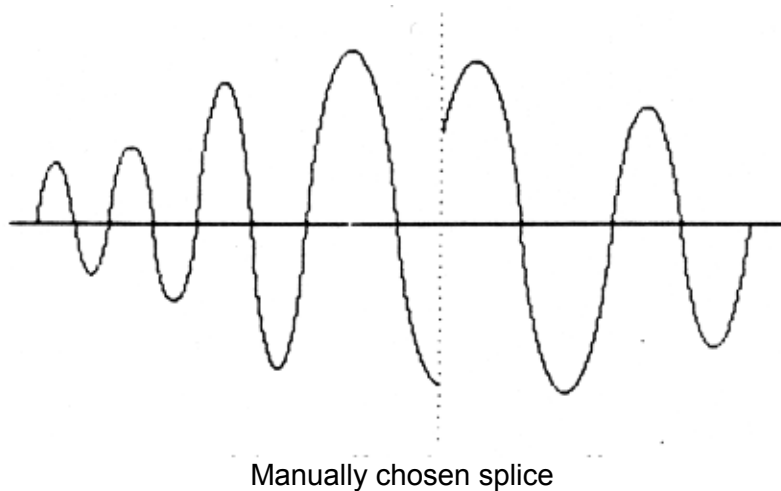
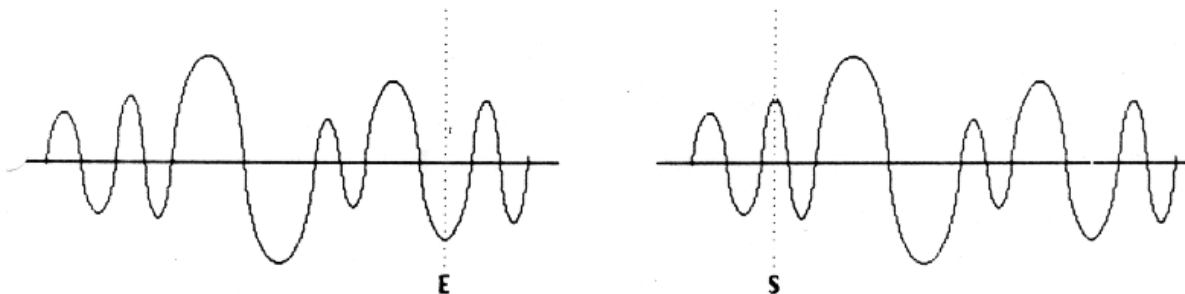

Fig. VDEF-13



Manually chosen E and S points

Fig. VDEF-14

VOICE DEFINITION MODULE

6. After finding good E and S points, see if Autosplice can produce an even better splice. Press YES at any point during the splicing process to invoke Autosplice.

Note: Sometimes the Emulator II will choose the correct splice point from a technical standpoint, not a musical one. Therefore, if you find a good splice point, write down the E and S numbers before invoking Autosplice. That way, if by some chance Autosplicing produces an inferior splice point, you can regain your original setting (or close to it) by moving the sliders.

6. To try for another splice point, move the sliders and press YES again for Autosplice. Continue moving the sliders in small increments and pressing YES until you end up with a glitch-free splice.

Note: Sometimes it will be impossible for you or the computer to find a perfect splice point. However, you will generally find that Autosplice, combined with practice and experimentation, will produce smooth, glitch-free splices.

7. After establishing the desired splice points, press ENTER. The display asks:

**Make Permanent?
(Kills Origs) Y/N**

To permanently join the two samples together, press YES. This replaces each Voice with the spliced Voice and returns you to the Module Identifier. Example: If you spliced V01 and V02 together, both V01 and V02 will now contain the spliced version.

If you do not want to eliminate the originals, or otherwise change your mind about the splice, press NO to return to the Module Identifier.

8. To continue splicing other Voices on to the Voice you just spliced, you must first erase one of the spliced versions of the Voice. (In the example given in step 8, you would erase either V01 or V02 and continue splicing on to the remaining Voice.)

Hint: Before doing a splice, copy the Voices to be spliced to new Voice numbers (see PRESET DEFINITION 12). Thus, if you make the splice permanent but don't like the results, you can always retrieve the original Voices.

VOICE DEFINITION MODULE

15 - SOUND LENGTH

This function lets you know the length of the specified Voice.

Applications: Check Voice length to make sure it will fit in the space remaining on a Library disk. Compare different Voice lengths when sampling.

1. With the module active, assign one Voice as the Current Voice.
2. Key in 15. The display's lower line indicates the length of the specified Voice in bytes (samples). If more than one Voice is assigned to the Current Voice, the display will show the length of the first Voice assigned.

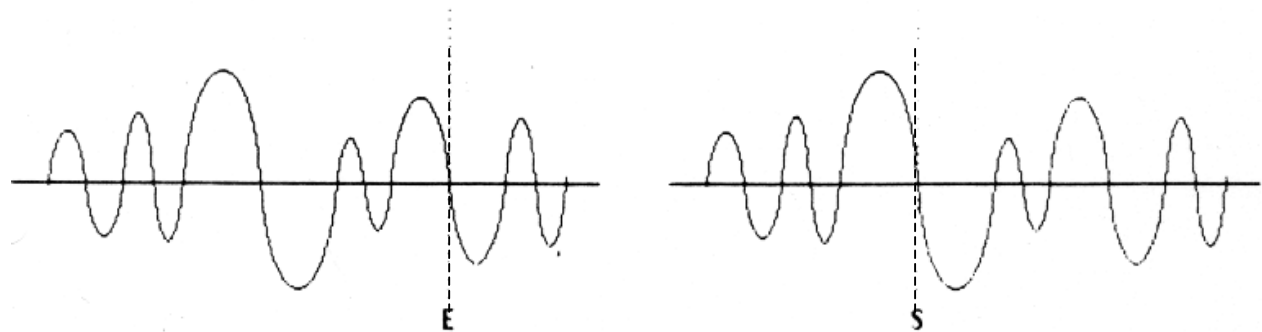

Autosplice chosen loop points

Fig. VDEF-15

VOICE DEFINITION MODULE

21 - VELOCITY ASSIGNMENT TO LEVEL and ATTACK

This function ties overall dynamics (level) and/or VCA attack time to how forcefully you play the keyboard.

Application: Sample sounds from an instrument (i.e. older synthesizers) without dynamics, and assign dynamics.

Application: Keyboard-controlled VCA attack is excellent for string and horn sounds, where bowing or blowing softly produces a slower attack than rapid bowing or blowing, which produces a much faster attack.

Application: Since each Voice in a Preset can have its own keyboard dynamics settings, lower register bass sounds can have minimum dynamics to provide a constant bottom, while upper register lead sounds can be played more dynamically.

1. With the module active, Current Voice assigned (see GENERAL INSTRUCTIONS 2), and the ENTER LED either lit steadily or off, key in 21. The display says:

Vel-Lvl	Vel-Atk
XX	XX

...where XX is a two digit number between 00 and 15. Slider A determines the extent to which keyboard velocity controls dynamics. When set to 00, the overall level is at maximum (loudest possible dynamics) no matter how forcefully or softly you play the keyboard. Progressively higher values give a progressively wider dynamic range by making soft sounds softer (see **Fig. VDEF-16**). Example: When set to 05, softly played notes sound somewhat quieter than forcefully played notes; when set to 15, softly played notes sound drastically quieter than forcefully played notes.

Slider B determines the extent to which keyboard velocity controls attack time. When set to 00, no matter how hard or soft you play the attack time will remain as set by VCA/LFO parameter 1A. Increasing the value causes the attack time to increase as you play more softly. A setting of 15 gives the greatest variation in attack times between hard and soft playing.

2. To exit to another function, see GENERAL INSTRUCTIONS 3 (“Exiting a Function”).

VOICE DEFINITION MODULE

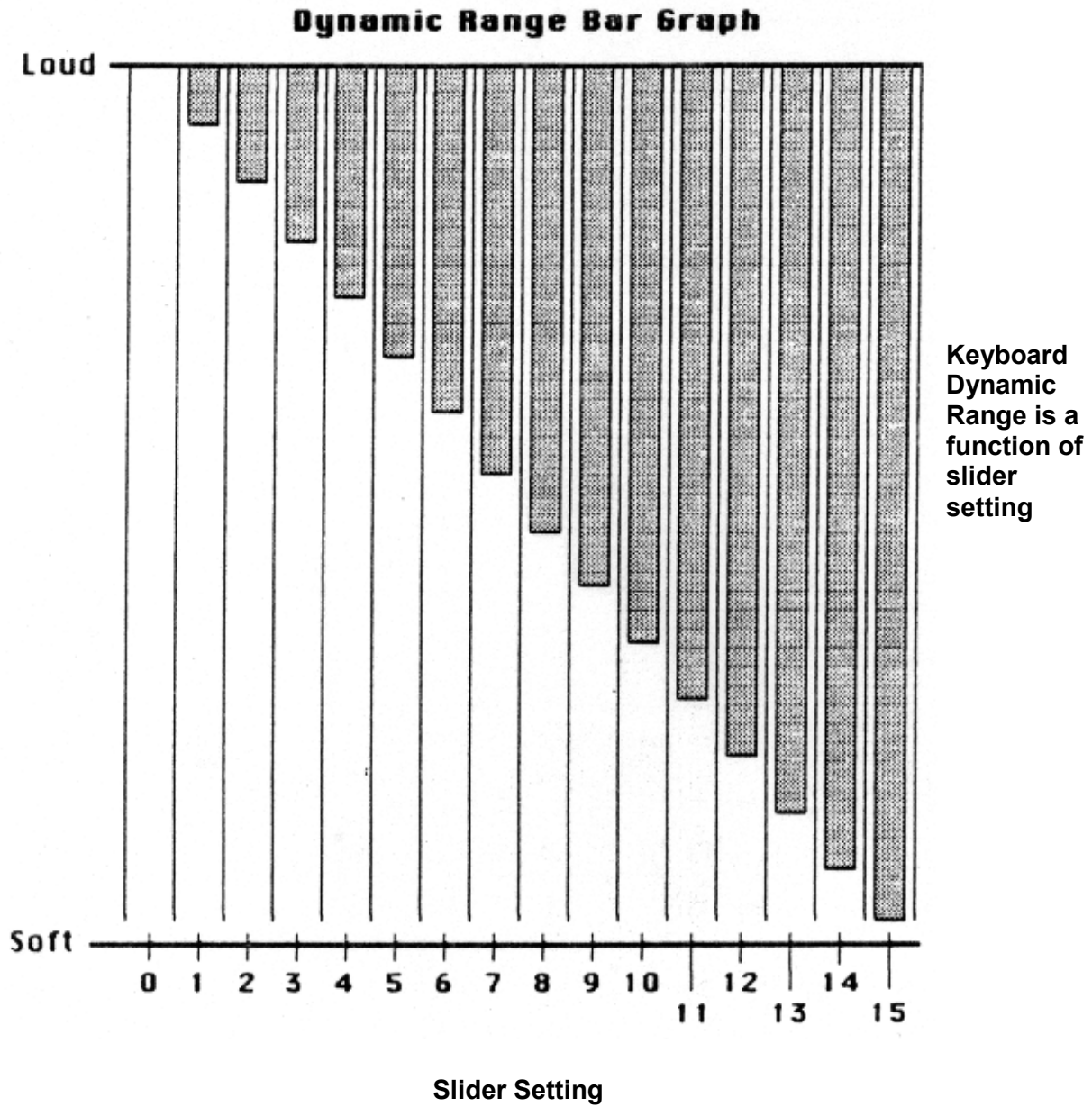

Fig. VDEF-16

VOICE DEFINITION MODULE

22 - VELOCITY ASSIGNMENT TO FILTER

This function ties the filter cutoff frequency and/or filter ADSR attack and/or filter Q to how forcefully you play the keyboard.

Application: Acoustic instruments often sound brighter when played forcefully. The Emulator II can simulate this effect by tying filter cutoff to keyboard dynamics.

Application: Tying keyboard dynamics to filter ADSR attack is very useful with string parts when you want legato sections to sound more timbrally muted than percussive sections.

Application: Increasing Q with increasing velocity thins out a sound, yet also increases its sharpness. This can work well with percussive Voices when you want a more intense, but not necessarily louder, sound.

1. With the module active, Current Voice assigned (GENERAL INSTRUCTIONS 2), and the ENTER LED either lit steadily or off, key in 22. The display says:

Vel-Freq	Atk	Q
00	00	+00

Slider A determines the extent to which keyboard velocity controls filter cutoff frequency. When set to 00, the filter cutoff frequency remains constant no matter how forcefully or softly you play the keyboard. Progressively higher values give a wider cutoff frequency range by lowering the cutoff frequency for softer playing (see **Fig. VDEF-17**). Example: When set to 05, softly played notes have a somewhat lower cutoff frequency than forcefully played notes; when set to 15, softly played notes have a drastically lower cutoff frequency.

Slider B determines the extent to which keyboard velocity controls filter attack time. When set to 00, no matter how hard or soft you play the filter attack time will remain as set by Filter parameter 3A. Increasing the value causes the filter attack time to increase as you play more softly. A setting of 15 gives the greatest variation in attack times between hard and soft playing.

Slider C determines the extent to which keyboard velocity controls filter Q. When set to 00, no matter how hard or soft you play the Q stays constant. With positive values (up to +15), playing more forcefully increases the Q. With, negative values (down to -15), playing more forcefully decreases Q. Note that overall volume levels can change with changes in Q; this is normal.

Note: The above settings all interact with the Filter module controls. You will probably need to “tweak” the Filter module settings for optimum results.

2. To exit to another function, see GENERAL INSTRUCTIONS 3 (“Exiting a Function”).

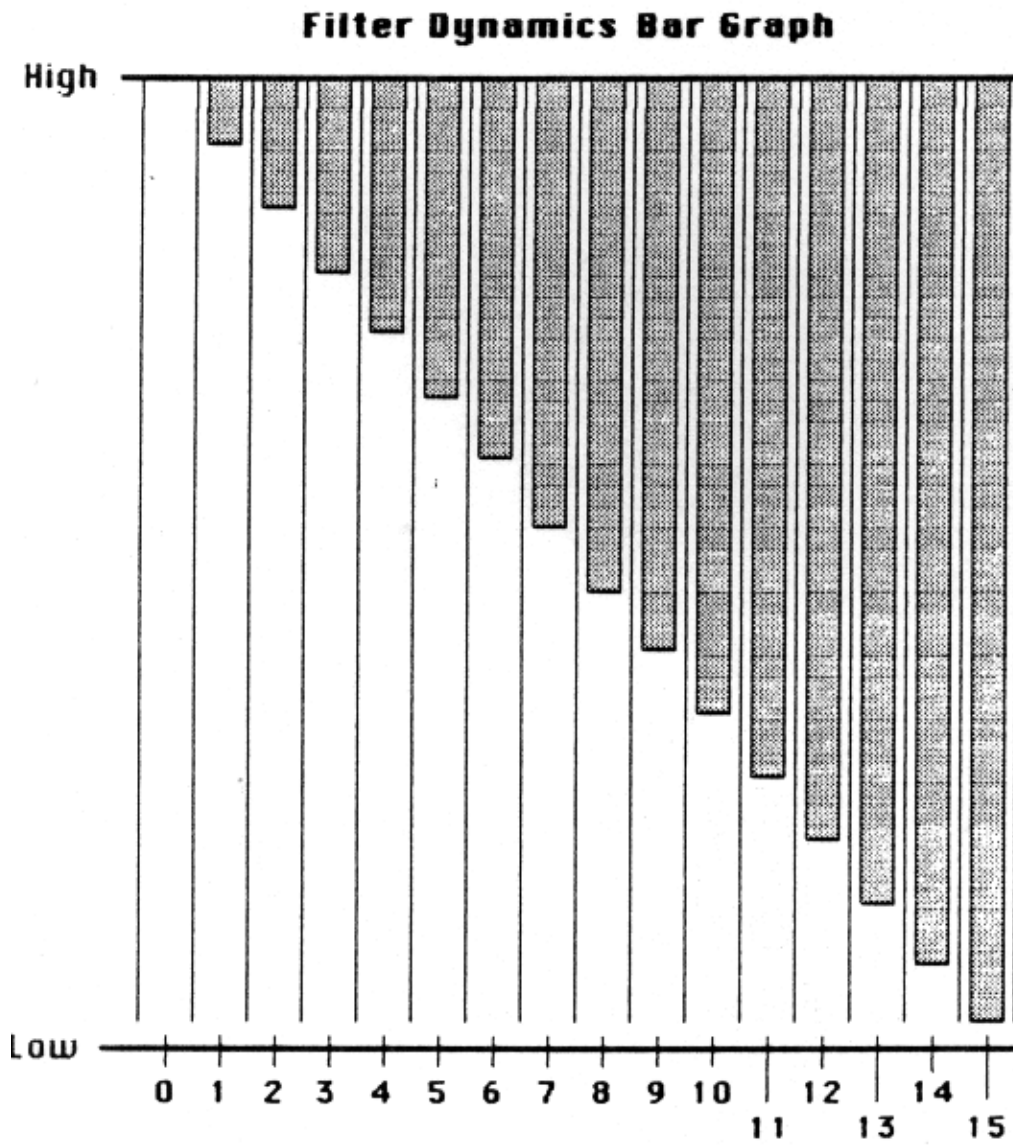

The extent to which filter cutoff changes according to keyboard dynamics as a function of slider setting.

Fig. VDEF-17

VOICE DEFINITION MODULE

23 - VIBRATO DEPTH

This function determines the extent to which the LFO (vibrato) signal modulates the Current Voice pitch.

1. With the module active, Current Voice assigned (see GENERAL INSTRUCTIONS 2), and the ENTER LED either lit steadily or off, key in 23. The display says:

Vibrato Depth 00

Slider A determines the extent to which the LFO modulates the Current Voice pitch, with higher values (up to 15) giving greater vibrato depth. Vibrato rate, delay, and variation are set in the VCA/LFO module (see VCA/LFO 2).

Note: This control interacts with the Real Time Control module vibrato control (see REAL TIME 4). Selecting Real Time vibrato disables this function, and vice-versa.

2. To exit to another function, see GENERAL INSTRUCTIONS 3 (“Exiting a Function”).

24 - VOICE ATTENUATE/TUNE

This function attenuates selected Voices assigned to a Preset, thus attaining a proper balance between all Voices; the tuning of each Voice can also be trimmed \pm approximately one half-step.

1. With the module active, Current Voice assigned (see GENERAL INSTRUCTIONS 2), and the ENTER LED either lit steadily or off, key in 24. The display says:

Atten Pitch
-XXdB YXXCents

...where Y indicates + or -, and XX is a value between 00 and approximately 48.

2. Adjust Slider A to attenuate the Current Voice relative to the other Voices.
3. Adjust Slider B to change the pitch of the Current Voice relative to the other Voices.
4. To exit to another function, see GENERAL INSTRUCTIONS 3 (“Exiting a Function”).

VOICE DEFINITION MODULE

25 - SOLO MODE

This function provides the playing action of a monophonic synthesizer with single triggering and last-note priority. With single triggering, you must lift your finger off a key to initiate a new envelope.

Application: Produce more realistic effects when working with monophonic instrument sounds (i.e. solo trumpet, flute, sax, etc.) since this mode does not allow you to play a chord. Simulate the keying action of monophonic synthesizers.

1. With the module active, assign the Current Voice (see GENERAL INSTRUCTIONS 2). Next, key in 25. The display says:

Solo Mode: no
Press Y/N

This confirms that the default setting is NO. To activate solo mode, press YES.

2. To exit to another function, see GENERAL INSTRUCTIONS 3 (“Exiting a Function”).

26 - LOOP IN RELEASE

With a looped Voice, after releasing a key the Voice will play to the end of the loop, play through any sound (if not already truncated) past the loop end point, and stop. This can create a problem with long release times since the signal will cut off abruptly after the loop ends; and if you specified a long release, you clearly wanted the sound to fade away slowly and gently. This function provides a “Loop in Release” mode, where the loop continues to play -- even after you lift your finger off the key -- for as long as the VCA release lasts.

1. With the module active, assign the Current Voice (see GENERAL INSTRUCTIONS 2). Next, key in 26. The display says:

Lp in Rls:yes
Press Y/N

This confirms that the default setting is YES. To de-activate Loop in Release for the Current Voice, press NO. After making your choice, exit to another function as described in GENERAL INSTRUCTIONS 3 (“Exiting a Function”).

VOICE DEFINITION MODULE

27 - BACKWARDS MODE

This function reads the Voice out of memory in the reverse order from which it was stored. .derots saw ti hcihw morf redro esrever eht ni yromem fo tuo ecioV eht sdaer noitcnuf sihT

Applications: Backwards tape effects simulation. Reverse attack and decay characteristics of Voices.

1. With the module active, assign the Current Voice (see GENERAL INSTRUCTIONS 2).
2. After assigning the Current Voice (the ENTER LED will be off), key in 27. The display says:

Backwards: no
Press Y/N

...and the ENTER light will flash. This confirms that the default setting is NO. To initiate Backwards mode, press YES then ENTER To cancel a previously initiated backwards mode, press NO then ENTER Either answer will return you to the Module Identifier.

Note: When backwards mode encounters a loop, it will play backwards to the loop Start point, then jump to the loop end point and play through to the Start again. With VOICE DEFINITION 13 (forward/reverse loop), the sample will play backwards to the Start point, then forwards to the loop end, then backwards to the Start point, etc. (see **Fig. VDEF-18**).

VOICE DEFINITION MODULE

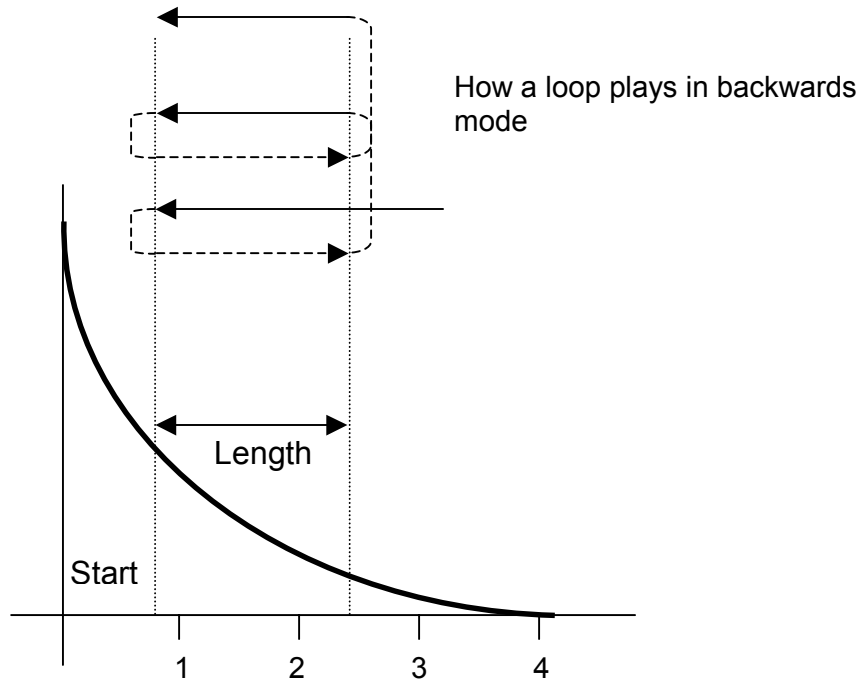

Fig. VDEF-18

Hint: If backwards mode doesn't appear to work, make sure that the sample doesn't have a loop towards the end of its decay. Consider **Fig. VDEF-19**. Playing this sample backwards will give a low-level, continuously repeating sound that is probably not what you had in mind. To play a Voice backwards from end to beginning, remove any loops.

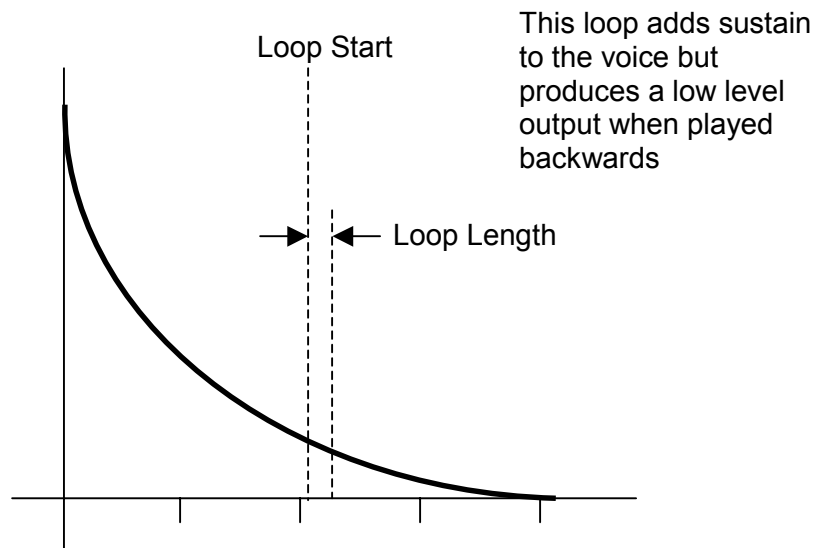

Fig. VDEF-19

VOICE DEFINITION MODULE

28 - COMBINE VOICES

Combining Voices mixes one sample with another, thus producing a more complex Voice. The combined Voice ignores any looping, tuning, or level changes programmed in the individual Voices; it works solely on the original digital Voice information. To loop the combined Voice, it is necessary to treat it as a single Voice and set loop points as described in VOICE DEFINITION 12.

Applications: Mix octave higher Voices in with a guitar's original Voices to create a 12-string guitar effect. Mix synthesized drum sounds in with acoustic drum sounds. Mix synthesized strings in with real strings to add "body". Combine two Voices into one Voice to conserve memory.

1. With the module active, specify one Voice as the Current Voice. After combining, the Current Voice will contain the mix of the two combined Voices.
2. After assigning the Current Voice (the ENTER LED will be off), key in 28. The display says:

Combine With V__
Use Slider A

...and the ENTER light will flash. Either enter the Voice number to be combined with the Current Voice via the keypad, or move Slider A to catalog (see GENERAL INSTRUCTIONS 7) the Voices available for combining. When the display shows the desired Voice, press ENTER

3. The display now says:

OK To Replace
Orig Voice? Y/N

If it's not OK, press NO to return to the Module Identifier. Copy the Current Voice to another number (see PRESET DEFINITION 12) if you don't want to lose it during the combining process. If it is OK, press YES. The display says:

This Will Take
A While

...and it's not kidding; combining does take some time so don't think anything is wrong with 'the instrument. The display will then return to the Module Identifier.

VOICE DEFINITION MODULE

29 - CONTROL ENABLE

This unique function allows you to exempt specific Voices from certain Real Time control functions.

Application: Exempt bass notes with long release times from pitch bending by disabling pitch bend for the bass Voices. You may then bend pitch in the upper range without affecting the bass notes.

1. With the module active, Current Voice assigned (see GENERAL INSTRUCTIONS 2), and the ENTER LED either lit steadily or off, key in 29. The display says:

Control Enable
Use Slider A

2. Adjust Slider A. Moving the slider from the bottom of its travel to the top scans the various real time control destinations in the following order: Pitch, LFO to Pitch, LFO to Filter, LFO to VCA, Filter cutoff frequency, Level, and Attack.
3. The default setting for all destinations is YES. To exempt the Current Voice from a particular control destination, press NO. Example: To exempt the Current Voice from being pitch-bent, press NO when the display shows Pitch.
4. After disabling the unwanted control destinations from a Voice, exit to another function as described in GENERAL INSTRUCTIONS 3 ("Exiting a Function").

VOICE DEFINITION MODULE

30 - SAVE VOICE TO DISK

This function lets you save an individual Voice to a Library disk.

1. Check that there is sufficient space on the Library disk to hold the Voice by inserting a formatted Library disk in one of the Emulator II drives, then referring to DISK 3.
2. After invoking DISK 3, the display will show the remaining amount of Library disk space in Bytes (samples). Note this reading. If the space remaining is expressed in Banks, then you have inserted a Performance disk instead of a Library disk. Insert a Library disk and repeat step 1.
3. Activate the Voice Definition module and assign the Voice you want to save as the Current Voice. Refer to VOICE DEFINITION 15 to check the length of the Current Voice. You can save the Voice as long as the SndLength number in the display is less than the space remaining on the Library disk and greater than 5500.

CAUTION, WARNING, CAREFUL, CUIDADO, LOOK OUT, BEWARE: ATTEMPTING TO SAVE A VOICE WHICH IS SHORTER THAN 5500 SAMPLES TO A LIBRARY DISK WILL CAUSE A CATASTROPHIC DISK ERROL YOU WILL LOSE ALL VOICES STORED ON THE LIBRARY DISK, AND THE DISK WILL NEED TO BE RE-FORMATTED.

Sorry about that, but it's due to the way that disks store data and there's nothing we can do about it right now.

4. Key in 30 to save. The display asks:

Save Voice to
Disk? Y/N

Pressing NO returns you to the Module Identifier. Press YES to save the Voice to disk. The lower display line will say "Just a Moment...". After saving, you will return to the Module Identifier.

PRESET DEFINITION MODULE

PRESET DEFINITION MODULE

11 - GET VOICE

12 - COPY/NAME VOICE

13 - ERASE VOICE

14 - ERASE SEQUENCE

15 - ERASE PRESET

16 - ERASE BANK

17 - CATALOG VOICES

18 - CATALOG SEQUENCES

19 - CATALOG PRESETS

20 - MEMORY REMAINING

21 - CREATE PRESET

22 - ASSIGN VOICE

23 - EDIT ASSIGNMENT

24 - DE-ASSIGN VOICE

25 - VELOCITY CROSS SWITCH

26 - VELOCITY CROSSFADE

27 - POSITIONAL CROSSFADE

28 - NONTRANSPOSE

29 - ARPEGGIATOR

30 - MIDI SETUP

31 - COPY/RENAME PRESET

32 - REPLICATE PRESET

PRESET DEFINITION MODULE

11 - GET VOICE

This fetches the specified Voice from a Library disk and loads it into the Bank.

Application: Before creating Presets, you must load the Voices that make up the Preset(s) into the Bank.

1. With the module active, key in 11. The display says:

Get Voice __
(01 – 99)/Slider A

...and the ENTER light will be flashing. Either use the keypad to specify the Voice File to be loaded, or move Slider A to catalog (see GENERAL INSTRUCTIONS 7) the Voice Files available for loading. When the display shows the desired Voice, press ENTER.

2. The display now says:

FXX (Voice Name)
Into Voice VV

...where XX is the two-digit Voice file number (see GENERAL INSTRUCTIONS 4 on Library disk Voice numbering protocol), and VV is the lowest-numbered Voice number available in the Bank. The display will always default to the lowest available Bank Voice number. To assign this number to the Voice, press ENTER. To assign a different Voice number, use the keypad and then press ENTER.

3. The disk drive will whirr for a bit and load the Voice file into the Bank. After loading, the Module Identifier appears.

PRESET DEFINITION MODULE

12 - COPY/NAME VOICE

This function copies a Voice, assigns a new Voice number, and allows for renaming the Voice. The original Voice remains intact.

Applications: To make a “back-up” copy of a Voice in the Bank before permanently altering it. To create a modified version of an existing Voice without altering the original. To rename an existing Voice by copying it to itself.

1. With the module active, key in 12. The display says:

Copy Voice __
(01 - 99)/Slider A

...and the ENTER light will be flashing. Either use the keypad to specify the Voice number to be copied, or move Slider A to catalog (see GENERAL INSTRUCTIONS 7) the Bank Voices. When the display shows the Voice to be copied, press ENTER.

2. The display now says:

Copy Voice XX
Into Voice __

...where XX is the Voice number you chose in step 1. Use the keypad to enter the copy's Voice number. The display will confirm your choice and the ENTER LED will start flashing. Press ENTER to copy the Voice.

3. The display now asks:

V01*
Rename? Y/N

* or Voice to be renamed

...unless there isn't enough memory left for the additional Voice, in which case the display will say “Not Enough Memory”. If you don't want to rename, press NO. To rename, press YES (you can rename a currently existing Preset by copying it to itself). Slider B positions the cursor under the letter you want to change, while Slider A chooses between lower case letters, capital letters, numerals 0 - 9, #, and space (top slider position). Continue positioning the cursor and entering letters until the name is complete. To exit to another function, see GENERAL INSTRUCTIONS 3 (“Exiting a Function”).

PRESET DEFINITION MODULE

13 - ERASE VOICE

This command erases a specified Voice from the Bank. Caution: Once erased, a Voice will be gone from any Preset in which it appears.

Application: Erase an improperly sampled or unneeded Voice, or free up more memory.

1. With the module active, key in 13. The display says:

Erase Voice
(01 – 99)/Slider A

...and the ENTER light will be flashing. Either use the keypad to specify the Voice number to be erased, or move Slider A to catalog (see GENERAL INSTRUCTIONS 7) the Bank Voices. When the display shows the Voice number to be erased, press ENTER.

2. The Emulator II wants to make sure you think twice before blanking out parts of its memory, so it asks:

Erase Voice VXX
You Sure? Y/N

...where VXX is the previously selected Voice number. If you have any doubts about the wisdom of erasing the Voice, press NO. Otherwise, press YES to erase the Voice. Pressing either YES or NO returns you to the Module Identifier.

PRESET DEFINITION MODULE

14 - ERASE SEQUENCE

This command erases a specified Sequence from the Bank.

Application: Erase an unneeded Sequence, or free up more memory space.

1. With the module active, key in 14. The display says:

Erase Seque
(01- 99)/Slider A

...and the ENTER light will be flashing. Either use the keypad to specify the Sequence number to be erased, or move Slider A to catalog (see GENERAL INSTRUCTIONS 7, "Cataloguing") the Bank Sequences. When the display shows the Sequence number to be erased, press ENTER.

2. The Emulator II wants to make sure you really do want to erase the Sequence, so it asks:

EraseSequenceXX
You Sure? Y/N

...where XX is the previously selected Sequence number. If you have any doubts about the wisdom of erasing the Sequence, press NO. Otherwise, press YES to erase the Sequence. Pressing either YES or NO returns you to the Module Identifier.

PRESET DEFINITION MODULE

15 - ERASE PRESET

This command erases a specified Preset from the Bank.

1. With the module active, key in 15. The display says:

**Erase Preset
(01 - 99)/Slider A**

...and the ENTER light will be flashing. Either use the keypad to specify the Preset to be erased, or move Slider A to catalog (see GENERAL INSTRUCTIONS 7) the Bank Presets. When the display shows the Preset to be erased, press ENTER.

2. The display now asks you an important question:

**Erase Voices Too?
Press Y/N**

If you don't want to erase the Voices but only the particular Preset containing those Voices, proceed to step 3. If you do want to erase the Voices that make up the Preset, press YES. Since this is a somewhat drastic move (if these Voices appear in other Presets, the Voices will be erased from those Presets as well as the Current Preset), the display will ask...

**Erase Preset XX
& Vcs - Sure? Y/N**

...where XX is the Preset number you entered. Pressing NO gives you a chance to cover yourself if you really wanted to keep the Voices after all. To erase the Voices, press YES. Either answer returns you to the Module Identifier.

3. If you don't want to erase the Voices but only the Preset containing those Voices, press NO in step 2. The display asks if you're sure about all this:

**Erase Preset XX
You Sure? Y/N**

...where XX is the previously specified Preset number. This is your last chance to reconsider. Pressing NO returns you to the Module Identifier; pressing YES erases the Preset from the Bank and returns you to the Module Identifier.

PRESET DEFINITION MODULE

16 - ERASE BANK

This procedure clears out the Emulator II's memory Bank.

Application: Allows for fresh start when creating new Banks and Presets from Library disks, or when sampling.

1. With the module active, key in 16. The display says:

Erase ALLMemory
Press Yes or No

and its LED will be lit steadily.

2. Pressing NO returns you to the Module Identifier. If you press YES, the display says:

Erase ALLMemory
You SURE? Y/N

...and the module LED will still be lit. If you're sure there's nothing in the Bank you need to save, press YES. The memory will be cleared and the display will return to the Module Identifier.

17 - CATALOG VOICES

This command lists the Voice number and name of every Bank Voice.

1. With the module active, key in 17. The display says:

To Catalog
Use Slider A

...and the ENTER light will be lit.

2. Move Slider A; the display will catalog (see GENERAL INSTRUCTIONS 7) all Bank Voices. After cataloguing, to exit to another function see GENERAL INSTRUCTIONS 3 ("Exiting a Function").

Note: Voices followed by an * and a number were created with the Replicate Preset function; see PRESET DEFINITION 32 for details.

PRESET DEFINITION MODULE

18 - CATALOG SEQUENCES

This command lists the Sequence number and name of every Sequence in the Bank.

1. With the module active, key in 18. The display says:

To Catalog
Use Slider A

...and the ENTER light will be lit.

2. Move Slider A; the display will catalog (see GENERAL INSTRUCTIONS 7, "Cataloguing") all Bank Sequences. After cataloguing, to exit to another function see GENERAL INSTRUCTIONS 3 ("Exiting a Function").

19 - CATALOG PRESETS

This command lists the Preset number and name of every Bank Preset.

1. With the module active, key in 19. The display says:

To Catalog
Use Slider A

...and the ENTER light will be lit.

2. Move Slider A; the display will catalog (see GENERAL INSTRUCTIONS 7) all Bank Presets. To exit to another function, see GENERAL INSTRUCTIONS 3 ("Exiting a Function").

PRESET DEFINITION MODULE

20 - MEMORY REMAINING

How close are you to filling up the Bank with Voices and Presets? This command lets you put a dipstick into the memory and find out.

Application: When sampling, to check whether there is sufficient memory to hold a sample of a particular length (also see SAMPLE 5). To check there is enough available memory before copying or replicating Presets. To check if there is enough memory before copying Voices.

1. With the module active, key in 20. The display says:

PresetDef (11 - 32)
MemAvail XXXXXX

...where XXXXXX is a six-digit number that indicates remaining Bank memory (in bytes). A totally clear Bank starts off with 484,559 bytes available.

2. After checking the memory, to exit to another function see GENERAL INSTRUCTIONS 3 ("Exiting a Function").

PRESET DEFINITION MODULE

21 - CREATE PRESET

You must first number and name a Preset, as provided by this function, before assigning Voices to it.

1. With the module active, key in 21. The display says:

**Create & Select
New Preset __**

Specify the Preset number with the keypad. The ENTER LED will flash. If the display confirms your choice, press ENTER.

2. If the selected Preset number already exists, the display will say "Selected Preset Exists" and asks you to try again.

Enter a number that is not already assigned to a Preset. (Or, exit this function, erase the Preset as per PRESET DEFINITION 15, and return to this function starting with step 1.) The display will now say:

**Create & Select
Just a Moment**

and a new Preset is born.

3. The display then shows:

**PXX NULLPRESET
Rename? Y/N**

...where XX is the Preset number you specified, and NULL PRESET is the default Preset name. If you don't want to rename, press NO. To rename, press YES. Slider B positions the cursor under the letter you want to change, while Slider A chooses between lower case letters, capital letters, numerals 0 - 9, IF, and space (top slider position). Position the cursor and enter letters until the name is complete. To exit to another function, see GENERAL INSTRUCTIONS 3.

PRESET DEFINITION MODULE

22 - ASSIGN VOICE

This function assigns a selected Voice to a specific keyboard range within the Current Preset.

1. With no module active, select the Preset number to which you want to assign the Voice. Caution: Always check that you have selected the proper Current Preset before assigning Voices.
2. Activate the Preset Definition module and key in 22. The display says:

Assign Voice
(01 – 99)/Slider A

...and the ENTER light will be flashing. Either use the keypad to specify the Voice number to be assigned, or move Slider A to catalog (see GENERAL INSTRUCTIONS 7) the available Bank Voices. When the display shows the Voice to be assigned, press ENTER. (If you enter a number for which there is no Voice, the lower display line will say that the Voice is “Nonexistent”.)

3. The display now says:

Orig Lo Hi Cnls
1 - 8

...and the ENTER light will be flashing. You may now assign the Voice to the desired keyboard range by playing notes on the keyboard. Generally, the Orig note will be the key representing the ORIGINAL pitch at which Voice was recorded; if the original Voice was recorded at pitch E2 (see GENERAL INSTRUCTIONS 8, “Keyboard Numbering Protocol”), play keyboard key E2. However, note that you are not limited to assigning the Voice to the key representing the original pitch at which it was recorded -- you may assign it anywhere on the keyboard if desired.

4. The display will show, under Orig, the note you just played. If this is the desired note, press ENTER.
5. Now play the LOWest desired transposition of the Voice. The Emulator II will not recognize transpositions lower than one octave below the Orig pitch, and will say “Illegal Asgnment” for LO transpositions that are higher than the HI pitch.

The display will show, under Lo, the note you just played. If this is the desired note, press ENTER. 6.

6. Now assign the Output Channel, or group of Channels, over which the Voice will appear. There are eight available Channels. If you assign the Voice to a single Channel, then the Voice will play monophonically and its single note output will appear at the specified Channel. If you specify more than one Channel, the Voice can produce as many notes as there are Channels specified; the output will appear over these multiple Channels.

PRESET DEFINITION MODULE

Specify the Channel, or group of Channels, by entering a pair of numbers where indicated by the cursor. When the display confirms your choice, press ENTER.

Examples:

- Cnls 3 - 3 The Voice plays monophonically, with the single note output appearing at Channel 3.
- Cnls 1 - 8 The Voice can play up to eight notes, which appear on Channels 1 - 8. They will share these Channels with any other Voices assigned to the same Channels.
- Cnls 2 - 3 The Voice can play up to two notes, which appear on Channels 2 and 3.
- Cnls 4 - 8 The Voice can play up to five notes, which appear on Channels 4 - 8.

Hint: Generally, you will specify Channels 1 - 8 for all Voices unless you want to restrict specific Voices to certain Channels (i.e. for stereo applications, or to send different instrument sounds through different signal processors).

7. Repeat steps 2 through 6 to assign additional Voices to the Preset. You may overlap up to two Voices (called "layering" or "doubling") on the keyboard.

Example: Suppose you assign a bass Voice to the lower two octaves, then want to create a more powerful bass effect in the very lowest octave. Assign an additional, overlapping Voice (such as a pipe organ bass pedal) to the lowest octave.

Note: If you attempt to layer more than two Voices, the lower display line will say "Illegal Asgnment".

Note: Re-assigning a Voice does not de-assign its previous assignment. If you assign a Voice incorrectly, de-assign it (PRESET DEFINITION 24) before re-assigning the Voice.

8. After assigning all Voices, de-activate the module and play the keyboard to check that all assignments ended up as planned. If not, refer to PRESET DEFINITION 23 and PRESET DEFINITION 24.

PRESET DEFINITION MODULE

23 - EDIT ASSIGNMENT

This function lets you examine and/or change the Orig, Lo, Hi, and output Channel parameters of a previously assigned Preset Voice.

1. With the module active, key in 23. The display says:

Edit Assignment
Play a Key

...and the ENTER light will be flashing. Play the keyboard until you locate the Voice you wish to edit, and then press ENTER.

2. The display now reads:

Orig Lo Hi Cnls

4. The lower line will show the previously selected parameters and the ENTER light will be flashing. To edit the ORIGINAL pitch, play the new original pitch on the keyboard and press ENTER. To retain the existing original pitch, simply press ENTER.
3. To edit the LO transposition, play the new LO transposition on the keyboard and press ENTER. To retain the existing LO transposition, simply press ENTER. The Emulator II will not recognize transpositions lower than one octave below the Orig pitch, and will say "Illegal Asgnment" for LO transpositions that are higher than the Orig pitch.
4. To edit the HI transposition, play the new HI transposition on the keyboard and press ENTER. To retain the existing HI transposition, simply press ENTER. The Emulator II will not recognize transpositions higher than one octave above the Orig pitch, and will say "Illegal Asgnment" for HI transpositions that are lower than the Orig pitch.
5. To edit the Output Channel(s) over which the Voice will appear, enter a pair of numbers where indicated by the cursor. When the display confirms your choice, press ENTER. To retain the existing Output Channel assignment, simply press ENTER. For more information about Output Channels, see PRESET DEFINITION 22.
6. Repeat steps (1) through (5) to edit additional Voices if desired. You may layer up to two Voices; if you attempt to layer more than two Voices, the lower display line will say "Illegal Asgnment".
7. After editing all desired Voices, de-activate the module and play the keyboard to check that all assignments have been edited as planned. If you need to delete a Voice rather than simply edit it, or need to delete a Voice in order to prevent an illegal assignment, refer to PRESET DEFINITION 24.

PRESET DEFINITION MODULE

Fig. PDEF-1

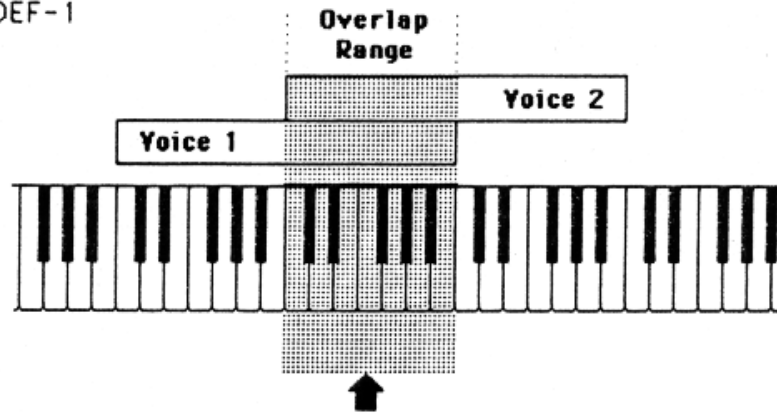

When playing in this range, with Voice 2 "On Hard",
hitting a key softly plays Voice 1;
hitting a key hard plays Voice 2.

Fig. PDEF-2

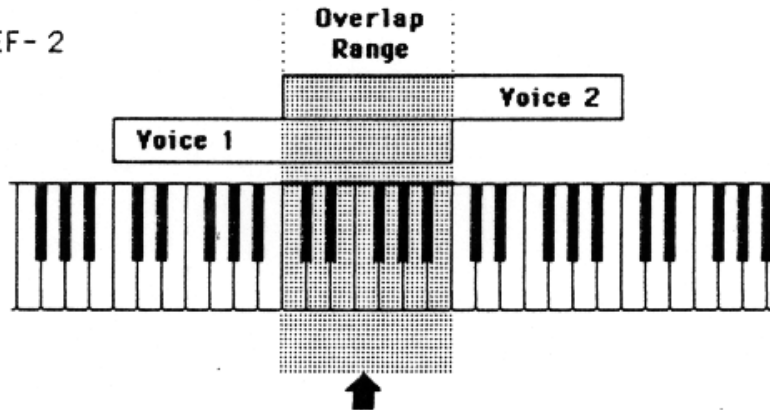

When playing in this range, with Voice 2 "On Hard",
Voice 1 becomes progressively softer and
Voice 2 becomes progressively louder as you strike a key hard.

Fig. PDEF-3

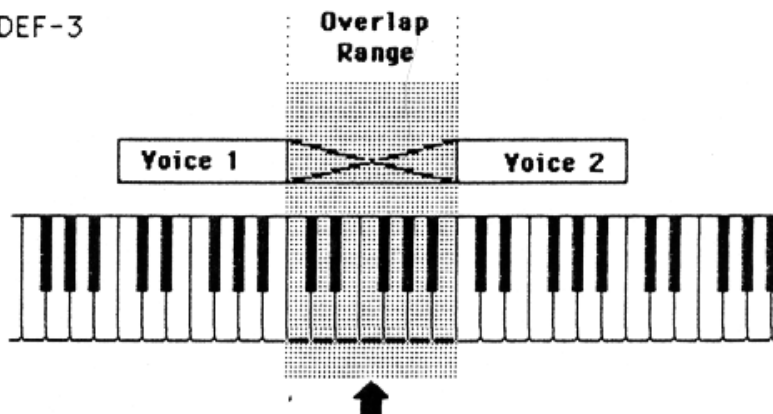

When playing from left to right across this range,
Voice 1 fades out as Voice 2 fades in.

PRESET DEFINITION MODULE

24 - DE-ASSIGN VOICE

This function de-assigns (deletes) a specific Voice from a Preset.

1. With the module active, key in 24.
2. The display says:

De-Assign Voice
Play a Key

...and the ENTER light will be lit. Play the keyboard until you locate the Voice to be de-assigned; the ENTER light will be flashing. After locating the Voice, press ENTER.

3. The Voice will be removed from the Preset (but not from the Bank). The display will say:

De-Assign Voice
Play a Key

...and the ENTER light will be lit. To de-assign another Voice, repeat step 2. After de-assigning all desired Voices, to exit to another function see GENERAL INSTRUCTIONS 3.

Note that de-assigning a Voice does not erase it; the Voice remains in the Bank and may be assigned to other Presets.

PRESET DEFINITION MODULE

25 - VELOCITY SWITCH

Where two Voices overlap, Velocity Switch lets you select one or the other Voice by how hard you strike keys in the overlap range. Hitting the key(s) softly selects one Voice; hitting hard selects the other Voice (see Fig. PDEF-1).

Application: Change a note's timbre by hitting it harder; for example, overlap a normal bass and slap bass Voice. Use Velocity Switch so that the slap bass is selected when you play the keyboard forcefully.

Application: When programming sound effects for film work, you can double the number of sound effects available in a certain keyboard range, and select the desired effect by how hard you hit a key.

1. With the module active, key in 25. The display says:

VelSW:Play a Key
"No" Erases All

...and the ENTER light' will be lit. To erase all previous Velocity Switch assignments for the Current Preset, press NO. If you do not want to assign new Velocity Switch parameters, exit to another function as described in GENERAL INSTRUCTIONS 3 ("Exiting a Function").

2. To create a Velocity Switch, play a key that the two Voices have in common. (If the key does not have overlapping Voices, the display will say "Key Must Have 2 Voices Assigned".) The display's top line will show the name of the first Voice assigned to the key, and the lower line will ask "On Hard? Yes/No".
3. If you want this Voice on when you play the keyboard hard, press YES. If you want this Voice on when you play the keyboard soft, press NO. After selecting, you will return to the Module Identifier. Play the keyboard to confirm Velocity Switch works as planned.

Hint: Keyboard dynamics are retained for the two Voices. For the most obvious Velocity Switch effect, use Voices with minimum dynamics (VOICE DEFINITION 21A = 00). Assigning a Voice with maximum dynamics to the "play soft" switch function means that you may never hear the sound, since playing softly produces little or no sound and playing hard switches to the other Voice.

PRESET DEFINITION MODULE

26 - VELOCITY CROSSFADE

Where two Voices overlap, Velocity Crossfade lets you control a crossfade between them by how hard you strike keys in the overlap range. One Voice will become louder as you play harder and softer as you play softer, while the other Voice will become louder as you play softer and softer as you play harder (see Fig. PDEF-2).

Application: Fade between cellos and violins, depending on how hard you play a key. Have a fuzz guitar sound assigned so that playing softly plays the fundamental, and playing harder brings in a feedback note an octave above the fundamental.

Application: Overlap the same Voice over a range of the keyboard, but assign one Voice to Channels 1 - 4 and the other Voice to Channels 5 - 8. Pan Channels 1 - 4 left and 5 - 8 right; the stereo placement (panning) will depend on how hard you play the keyboard.

1. With the module active, key in 26. The display says:

VelXF:Play a Key
"No" Erases All

...and the ENTER light will be lit. To erase all previous Velocity Crossfade assignments for this Preset, press NO. If you do not want to assign new Velocity Crossfade parameters, exit to another function as described in GENERAL INSTRUCTIONS 3.

2. To create a Velocity Crossfade, play a key that the two Voices have in common. (If the key does not have overlapping Voices, display will say "Key Must Have 2 Voices Assigned".) The display's top line will show the name of the first Voice assigned to the key, and the lower line will ask "On Hard? Yes/No".
3. If you want this Voice to play louder as you hit the keyboard harder, press YES. If you want this Voice to play more softly as you hit the keyboard harder, press NO. After selecting, you will return to the Module Identifier. Play the keyboard to confirm Velocity Crossfade works as planned.

Hint: Keyboard dynamics are retained for the two Voices. For optimum Velocity Crossfade effects, use Voices with minimum dynamics (VOICE DEFINITION 21A = 00). Assigning a Voice with maximum dynamics to the "play soft" crossfade function means that you may never hear the sound, since playing softly produces little or no sound and playing hard crossfades over to the other Voice.

PRESET DEFINITION MODULE

27 - POSITIONAL CROSSFADE

Where two Voices overlap, Positional Crossfade alters the level balance (mix) between the two Voices depending on where you play within the overlap range. Rather than spend a lot of time explaining this in words, please refer to Fig. PDEF-3.

Application: Transposing a sampled sound lower usually produces a more muffled sound than the original sample, and transposing upwards usually produces a thinner, brighter sound. Overlapping Voices and using Positional Crossfade can balance out the Voice timbres; as one Voice becomes progressively brighter, it can be fading out as the overly muffled part of the next Voice fades in. Combining the overly thin and overly muffled Voices in the correct proportion can produce an overall timbre that ends up sounding just right.

1. With the module active, key in 27. The display says:

PosXF:Play a Key
"No" Erases All

...and the ENTER light will be lit. To erase all previous Positional Crossfade assignments, press NO. If you do not want to assign new Positional Crossfade parameters, exit to another function as described in GENERAL INSTRUCTIONS 3.

To create a Positional Crossfade, play one of the keys that's overlapped by the two Voices. (If the key does not have overlapping Voices, display will say "Key Must Have 2 Voices Assigned".) The display's top line will show the name of the first Voice assigned to the key, and the lower line will ask "At Top? Yes/No".

2. If you want this Voice to fade in as you play higher on the keyboard, press YES. If you want this Voice to fade out as you play higher on the keyboard, press NO. After selecting, you will return to the Module Identifier. Play the keyboard to confirm Velocity Crossfade works as planned.

PRESET DEFINITION MODULE

28 - NONTRANSDPOSE

Nontranspose lets a Voice play throughout its assigned keyboard range but at its original pitch only -- there will be no transposition.

Application: To determine the original note at which a Voice was recorded. Or, if you're playing drum parts on the keyboard, you might want to assign the bass drum to the entire left-most octave of the keyboard so that it makes an easy target compared to hitting one key. In this case, put the bass drum into Nontranspose mode so that no matter where you hit, the sound is consistent. Or, if you have an environmental ocean sound layered beyond a melodic line, but don't want the ocean to transpose as you play the melody, Nontranspose the ocean sound.

One more application...assign a non-transposed sound and play several keys at almost the same time; you'll hear some pretty neat phasing/flanging effects.

1. With the module active, key in 28. The display says:

NonTransp. Mode
Play a Key

...and the ENTER light will be lit. Play a key from the Voice you want nontransposed. When the display shows the desired Voice, press ENTER.

2. The display now says:

(Selected Voice)
Nontransp: NO

...which shows that the default mode is NO. To put the Voice in Nontranspose mode, press YES. To cancel an existing Nontranspose assignment, press NO. After choosing, exit to another function as described in GENERAL INSTRUCTIONS 3.

PRESET DEFINITION MODULE

29 - ARPEGGIATOR

You're going to love this arpeggiator: It does a lot and it's easy to set up. Best of all, arpeggiation settings are stored with the Preset so that different Presets can have totally different arpeggiation characteristics. Also, arpeggiation can be assigned to any range of the keyboard or the entire keyboard.

1. With all modules de-activated, select the Current Preset. This Preset will contain the arpeggiation information.
2. With the Preset Definition module active, key in 29. The display says:

Arpeg Setup Menu
Use Slider A

...and the ENTER light will be lit. Move Slider A to identify the various Arpeggiator options. At the bottom of the slider travel, the display says:

Arpeg Mode: off
Use Slider D

Use Slider D to select between the various arpeggiator modes:

off	= default setting; no arpeggiation
up	= held notes arpeggiate continuously from lowest to highest pitch
down	= held notes arpeggiate continuously from highest to lowest pitch
u/d	= held notes first arpeggiate from lowest to highest pitch, then from highest to lowest, then repeat this cycle
rand	= held notes arpeggiate continuously in a RANDom fashion
prog	= held notes arpeggiate continuously in the order in which the keys were pressed.

3. After selecting the mode, move Slider A upwards until the display says:

Extension: norm
Use Slider D

Use Slider D to select between three possible extensions:

norm	= default setting arpeggiation occurs only to the notes being held
1oct	= arpeggiation responds as if you are holding down another set of notes one octave above the notes being held
2oct	= arpeggiation responds as if you are holding down two more sets of notes one octave above, and two octaves above, the notes being held.

4. After selecting the extension, move Slider A upwards until the display says:

PRESET DEFINITION MODULE

Range: C1 to C1
Play a Key

This is the default setting and indicates that arpeggiation will only play in the range C1 to C1 (one note). Press the key corresponding to the lowest note in the range you want arpeggiated (after which the cursor will move to the second note in the display), then play the key corresponding to the highest note in the range you want arpeggiated. The display will confirm your choice. If you make a mistake, the cursor will jump back underneath the lowest note, and you can start the assignment process over again.

Note: The Emulator II will not let you choose a lower note higher than the currently selected upper note.

5. After selecting the range, move Slider A upwards until the display says:

Note Value: 1/16
Use Slider D

Use Slider D to select between the following arpeggiation note values: 1/4, 1/4 triplet, 1/8, 1/8 triplet, 1/16 (default setting), 1/16 triplet, 1/32, and 1/32 triplet.

6. After selecting the note value, move Slider A upwards until the display says:

Tempo: 120
Use Slider D

Use Slider D to select a tempo in the range of 40 to 240 beats per minute. Note that tempo moves in 1 BPM increments from 40 to 120 BPM, 2 BPM increments from 120 to 162 BPM, and 3 BPM increments from 162 to 240 BPM. If you have selected an External Clock (see SEQUENCER EXT CLK), the arpeggiator will follow this clock rather than the internal clock.

7. You have now completed arpeggiator set-up. To exit to another function, see GENERAL INSTRUCTIONS 3.

PRESET DEFINITION MODULE

30 - MIDI SETUP

MIDI is a way of exchanging musical information between various electronic music instruments. If you are not familiar with MIDI, read the “MIDI Supplement” section before continuing.

Please remember that MIDI was devised with analog synthesizers in mind, and that the Emulator II voice is not like a standard analog synthesizer voice. A Preset is actually much closer to what the MIDI specification had in mind for an individually addressable channel, so the Emulator II stores MIDI parameters with each Preset. Different Presets can be set to send or receive on different MIDI channels.

1. With all modules de-activated, select the Current Preset. This Preset will contain the default MIDI parameters (see Appendix B), which you may now proceed to change for your particular application. Note that different Presets can have different MIDI parameters.
2. With the Preset Definition module active, key in 30. The display says:

MIDI Setup Menu
Use Slider A

...and the ENTER light will be lit. Move Slider A to identify the various MIDI options. At the bottom of the slider travel, the display says:

Basic Channel: 01
Press (01 – 16)

This is the default channel over which this particular Emulator II Preset will send and receive MIDI information. To change channels, press the appropriate keypad buttons.

3. Moving Slider A upwards gives this display next:

MIDI Mode: Omni
Use Slider D

Slider D selects how the Emulator II responds to MIDI information:

off	= Ignores all MIDI information
Omni	= Accepts MIDI information coming in on any channel
Poly	= Accepts MIDI information only on the basic channel (specified above).

PRESET DEFINITION MODULE

4. Moving Slider A upwards gives this display:

Preset ch OK: yes
Press Y/N

MIDI also carries patch change information from one synthesizer to another. Press YES if you want the Emulator II to respond to this information (or to change presets in other synthesizers from the Emulator II), and NO if you want to select Presets on the Emulator independently of other MIDI instruments.

Note: There is no consistency between manufacturers regarding what patch will occur on “slave” synthesizers when a particular patch is selected on the “master” synthesizer.

5. Moving Slider A upwards gives the following display:

Local Cntl: yes
Press Y/N

With Local Control at the default setting of YES, the Emulator II keyboard controls the Emulator II and MIDI carries information on which keys are being played. Press NO to “disconnect” the Emulator II from its keyboard, but still have MIDI carry information on which keys are being played.

6. Moving Slider A upwards gives the next option:

Transmit Reset
Press Yes

MIDI has a command that resets all MIDI instruments to their power-on (default) setting. Pressing YES sends this reset command out to other MIDI instruments.

Note: The Emulator II cannot receive reset commands since in its power-on condition, the bank is empty and a disk needs to be booted. Therefore, if reset it would not be able to make any sound until a disk was booted.

PRESET DEFINITION MODULE

7. Moving Slider A upwards gives the following display:

Lt Wheel > #XX
Use Slider D

You may now assign a controller number to the Left Wheel. Moving Slider D presents the following options:

off	= no controller number assigned
00 through 31	= assigns the controller number shown in the display
pwh	= assigns the Left Wheel to the standardized controller number for pitch bend
chp	= assigns the Left Wheel to the standardized modulation controller

When the display shows the desired controller assignment, press ENTER.

8. Moving Slider A upwards presents the following display:

Rt Wheel > #XX
Use Slider D

You may now assign a controller number to the Right Wheel in exactly the same manner as you assigned a controller number to the Left Wheel in step 6. When the display shows the desired controller assignment, press ENTER.

9. Moving Slider A upwards brings us to the next display:

Pedal > #XX
Use Slider D

You may now assign a controller number to the Pedal in exactly the same manner as you assigned a controller number to the Left Wheel in step 6. When the display shows the desired controller assignment, press ENTER.

10. Continuing to move Slider A upwards gives the following display:

MIDI A > #XX
Use Slider D

Three real time parameters (pitch, filter cutoff, LFO pitch modulation, etc.) can be assigned to MIDI control source A, B, and C (see GENERAL INSTRUCTIONS 6, "Selecting Real Time Control Functions). You may then assign each MIDI control source to be controlled via a specific MIDI controller on another synthesizer.

Example: Suppose a second MIDI unit's vibrato controller is assigned MIDI control number 01, and that MIDI control source A on the Emulator II is assigned to control the filter cutoff frequency. Selecting 01 for MIDI control source A would control the Emulator II's filter cutoff frequency via the second MIDI unit's vibrato information.

PRESET DEFINITION MODULE

This step of the set-up procedure lets you assign a number to the MIDI control source that matches up with the number of the controller “transmitting” data from a MIDI unit into the Emulator II. (For more information on controller numbers, see the MIDI supplement.) Moving Slider D presents the following options:

off	= no controller number assigned
00 through 31	= assigns the controller number shown in the display
pwh	= assigns MIDI control source A the standardized controller number for pitch bend
chp	= assigns MIDI control source A the standardized controller number for overall volume (channel pressure)

When the display shows the desired controller assignment, press ENTER.

11. Continuing to move Slider A upwards gives the following display:

MIDI B > #XX
Use Slider D

Assign a controller number to control source B in exactly the same manner as you assigned a controller number to control source A in step 9. When the display shows the desired controller assignment, press ENTER.

12. Continuing to move Slider A upwards gives the following display:

MIDI C > #XX
Use Slider D

Assign a controller number to control source C in exactly the same manner as you assigned a controller number to control source A in step 9. When the display shows the desired controller assignment, press ENTER.

PRESET DEFINITION MODULE

31 - COPY/RENAME PRESET

This function copies a Preset to another Preset number. Since the second Preset is an exact duplicate of the original Preset, changing a Voice parameter in the copied Preset will change that Voice in the original, and vice-versa. To copy a Preset and renumber the Voices at the same time, thus allowing for independent Voice modification, see PRESET DEFINITION 32.

Application: To create a modified version of an existing Preset (assuming that these modifications do not require changing the Voice parameters); for example, to store different arpeggiator settings with the same Preset. To rename an existing Preset by copying it to itself. To create a Preset which requires a similar, but not identical, Voice assignment to an existing Preset.

1. With the module active, key in 31. The display says:

Copy Preset
(01 – 99)/Slider A

...and the ENTER light will be flashing. Either use the keypad to specify the Preset number to be copied, or move Slider A to catalog (see GENERAL INSTRUCTIONS 7) the Bank Presets. When the display shows the desired Preset, press ENTER.

2. The display now says:

Copy Preset XX
Into Preset YY

...where XX is the Preset number you chose in step 1. Use the keypad to enter the copy's Preset number - YY. After entering, the display will confirm your choice and the ENTER LED will flash. Press ENTER to copy the Preset.

3. The display now asks:

PYY
Rename? Y/N

...where YY is the Preset number you are copying into. If you don't want to rename, press NO. To rename, press YES.

Slider B positions the cursor under the letter you want to change, while Slider A chooses between lower case letters, capital letters, numerals 0 - 9, #, and space (top slider position). Continue positioning the cursor and entering letters until the name is complete. To exit to another function, see GENERAL INSTRUCTIONS 3.

PRESET DEFINITION MODULE

32 - REPLICATE PRESET

This function copies a Preset to another Preset number and copies and renumbers all the Preset's Voices as well. Therefore, the copied Presets Voices may be altered without affecting the Voices in the original Preset. To copy a Preset without copying and renumbering the Voices, see PRESET DEFINITION 31.

Note: When cataloguing Bank Voices (see PRESET DEFINITION 17), Voices marked with an * and a number indicate Voices which were copied and renumbered via replication.

Application: To "back-up" a Bank Preset before permanently altering the original's Voices. To create a modified version of an existing Preset with different Voice parameters.

1. With no module active, select the Current Preset that you want to replicate.
2. With the Preset Definition module active, key in 32. The display says:

Replicate and
Select Preset

Use the keypad to specify the new Preset number; the ENTER LED will flash. If you select an existing Preset, the display will notify you that "Selected Preset Exists", and will ask you to try again. When the display confirms the new Preset number, press ENTER to replicate the Preset.

3. The display now says:

This Will Take
A While

.but it doesn't really take all that long.

4. The display then asks:

PYY
Rename? Y/N

Where YY is the Preset number being replicated into. If you don't want to rename, press NO. To rename, press YES. Slider B positions the cursor under the letter you want to change, while Slider A chooses between lower case letters, capital letters, numerals 0 - 9, #, and space (top slider position). Continue positioning the cursor and entering letters until the name is complete. To exit to another function, see GENERAL INSTRUCTIONS 3.

SAMPLE MODULE

SAMPLE MODULE

1 - VU MODE

2 - DEFINE VOICE

3 - GAIN SET

4 - THRESHOLD SET

5 - SAMPLE LENGTH

7 - ARM SAMPLING

9 - FORCE SAMPLING

0 - STOP SAMPLING

SAMPLE MODULE

1 - VU MODE

This function sets the proper level for sounds being recorded into the Emulator II.

1. Activating the SAMPLE module automatically puts the Emulator II in VU mode (SAMPLE 1). (If you select another SAMPLE function at some point, entering the data for that function usually returns you automatically to VU mode.) The display shows:

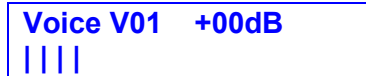

Voice V01 +00dB
||||

There may or may not be some moving vertical bars in the display's lower line.

2. Play the sound to be sampled, which can be monitored from the Emulator II MIX OUT jack. Note the moving bar display in the lower line; louder signals will kick the bars further over to the right. If the meter hardly moves at all, you need more preamp gain (see SAMPLE 3). The Emulator II's VU meter is a "peak hold" type that briefly "holds" the highest level attained.
3. If the meter bar hits the extreme right hand side, the Emulator II is being overloaded. Adjust the SAMPLE GAIN control so that peaks are below this overload point. Generally, you will want to sample at the highest possible level short of overload.

2 - DEFINE VOICE

The Emulator II default assignment places the sampled sound on C2 (the sample's original pitch), transposes the sound one octave down (to C1, the lower ~ and transposes the sound one octave up (to C3, the high ~ This is assigned to the Current Preset (as shown when no module is activated). DEFINE VOICE can assign the sampled sound to a different range of the Emulator II keyboard, and also numbers the Voice from 00 to 99.

1. With the SAMPLE module active, key in 2. The display says:



Place Orig Pitch
Onto Keyboard

2. Play the key where you want to place the original sampled sound. The display now says:



Place Lower Key
Onto Keyboard

3. Play the lowest desired note of the range (cannot exceed one octave below the original pitch). The display now says:

SAMPLE MODULE

**Place High key
Onto Keyboard**

4. Play the highest desired note of the range (cannot exceed one octave above the original pitch). The display says:

**NEW VOICE VXX
PRES (01 - 99)**

...where XX represents the Voice number. The Emulator II will automatically assign the lowest available Voice number (as shown in the display) for the new Voice you are about to sample. If this number suits you, press ENTER. If you have a particular numbering system (say, percussive Voices from 20 - 29, industrial noises from 30 - 39, sampled animals from 40 - 49, etc.), enter a two-digit number using the keypad and then press ENTER. In either case, after pressing ENTER you will return to VU mode.

SAMPLE MODULE

3 - GAIN SET

The Emulator II has a built-in mic preamp with three gain ranges (00 dR, +20 dB, and +40 dB). This function chooses the desired amount of gain.

1. With the module active, key in 3. The display says:

INPUT GAIN+00dB
USE SLIDER A

2. Vary Slider A to choose between 00, +20, and +40 dB gain as shown in the display. After making your selection, press ENTER to return to VU mode.

4 - THRESHOLD SET

There are two ways to initiate sampling: Threshold-sensitive sampling and forced sampling (SAMPLE 9). With threshold-sensitive sampling, once sampling is “armed” sampling begins whenever the signal to be sampled exceeds the programmable threshold level. This function sets the threshold level.

1. With the module active, key in 4. The display shows the standard bar graph display on the bottom line, and a single bar on the top line indicates the threshold level. Upon selecting SAMPLE 4, the threshold is at its lowest possible value.
2. To set the threshold level, vary Slider A. Generally, you will set threshold just above the residual noise of the sound to be sampled (the display’s lower line will show this noise, if any, as erratically moving bars towards the left of the line). Therefore, any noise will not initiate sampling, but a signal that exceeds the threshold will.

Hint: Set the lowest possible threshold. If the beginning of a sound is cut off, the threshold is too high. If there’s a delay before the beginning of a sound, the threshold is too low and was probably triggered by some noise prior to the actual signal.

Note: Once sampling has begun, the Emulator II will continue sampling even if the signal falls below the threshold level. To stop sampling, refer to SAMPLE 0.

SAMPLE MODULE

5 - SAMPLE LENGTH

Once sampling is initiated, the Emulator II will normally sample until it runs out of memory or is stopped (see SAMPLE 0, the “stop sampling” function). However, this function let’s you program a particular sample time; after this time has elapsed, the Emulator II will stop sampling.

1. With the module active, key in 5. The display says:

Length XX.X secs
Use Slider A

...where XX.X is the time in seconds. If the Bank is empty, this will be 17.6 seconds; if you have already done some sampling, this will be 17.6 seconds minus the existing sample lengths.

2. Vary Slider A to change the sample length in 200 millisecond increments. When the display shows the desired time, simply initiate the next function (it is not necessary to press ENTER). The sample length will remain as set until changed, or until you pick a different Voice number.

7 - ARM SAMPLING

Upon initiating this function, the Emulator II will begin sampling as soon as the sound to be sampled exceeds the threshold set with SAMPLE 4, or when sampling is forced (see SAMPLE 9).

1. With the module active, key in 7. The display’s top line says “Sample Armed”, while the bottom line shows the moving-bar VU meter (see SAMPLE 1).
2. As soon as the sound to be sampled exceeds the threshold, the Sample module LED will begin blinking. After reaching the end of the sample length (if set with SAMPLE 5), being stopped manually (see SAMPLE 0), or when the Emulator II runs out of memory, the Sample LED will stop blinking and one of two messages will, appear in the display’s top line. “Sample Overload” indicates that the sound being sampled exceeded the Emulator II’s headroom (however, this sound is nonetheless available for use if desired). “Sample is good” indicates that no overload occurred.
3. If you are not satisfied with the sample, try again by repeating steps 1-3 before de-activating the module. If you are satisfied with the sample, de-activate the module. The Emulator II will store the sample as a New Voice, and number it as assigned during “Define Voice” (SAMPLE 2). To keep the sample as a “safety” and record another take, activate the SAMPLE module and pick a new Voice number.

SAMPLE MODULE

9 - FORCE SAMPLING

Force sampling lets you initiate sampling manually as an alternative to threshold-sensitive sampling. This is useful for situations where the signal to be sampled is more or less continuous (continuous signals greatly complicate the threshold-setting process described in SAMPLE 4).

1. With the module active and levels properly set, as soon as you are ready to sample key in 9. Sampling will begin immediately, and the Sample module LED will blink.
2. After reaching the end of the sample length (if set with SAMPLE 5), being stopped manually (see SAMPLE 0), or when the Emulator II runs out of memory, the Sample LED will stop blinking and one of two messages will appear in the display's top line. "Sample Overload" indicates that the sound being sampled exceeded the Emulator II's headroom (however, this sound is nonetheless available for use if desired). "Sample is good" indicates that no overload occurred.
3. If you are satisfied with the sample, de-activate the module. The Emulator II will store the sample as a New Voice, with the number assigned previously in SAMPLE 2. If you are not satisfied with the sample, try again by repeating steps 1 - 3.

0 - STOP SAMPLING

You may terminate the sampling process at any time by keying in 0. After termination, the Sample module LED will stop blinking and one of two messages will appear in the display's top line. "Sample Overload" indicates that the sound being sampled exceeded the Emulator II's headroom (however, this sound is nonetheless available for use if desired). "Sample is good" indicates that no overload occurred.

DISK MODULE

DISK MODULE

1 - GET BANK DISK 1

2 - GET BANK DISK 2

3 - SPACE REMAINING

3 - DISK IDENTITY

4 - COPY DISK

5 - CATALOG VOICE

6 - ERASE VOICE

7 - SAVE BANK

8 - FORMATTING A DISK

DISK MODULE

1 - GET BANK DISK 1

A Performance disk stores one Bank of Presets (plus the Voices that make up the Presets). Loading the Bank into the machine lets you play with the Presets and Voices that make up the Bank.

When the machine is first turned on, simply inserting and latching a Performance disk into Drive 1 will initiate loading a Bank. At all other times use this function to load a new Bank into memory from a Performance disk inserted in Drive 1.

1. Remove any existing disk from Drive 1, then insert and latch the Performance disk containing the Bank to be loaded in Drive 1.
2. With the disk module active, key in 1 to GET BANK DISK 1. The drive clicks, its LED lights, and the display tells you that...

This Will Take
A While

After loading, the display then shows the Current Preset. (1st Preset to appear upon loading)

P03*

* or 1st Preset to appear upon loading

Note: If you try to get a Bank from a Library disk, which of course doesn't store data in a Bank, the display will read:

Insert Perf Disk
And Press Enter

Insert a Performance disk, press **ENTER**, and continue.

3. To choose a different Preset, enter its number with the keypad (see GENERAL INSTRUCTIONS 1, "Selecting the Current Preset").
4. To choose which Current Preset will be active when you load a Bank, select the desired Preset just before saving the Bank to disk (see DISK 7, "Save Bank"). The Emulator II will default to that Preset whenever you load the Bank.

DISK MODULE

2 - GET BANK DISK 2

A Performance disk stores one Bank of Presets (plus the Voices that make up the Presets). Loading the Bank into the machine lets you play with the Presets and Voices that make up the Bank.

When the machine is first turned on, simply inserting and latching a Performance disk into Drive 2 will initiate loading a Bank. At all other times use this function to load a new Bank into memory from a Performance disk inserted in Drive 2.

1. Remove any existing disk from Drive 2, then insert and latch the Performance disk containing the Bank to be loaded in Drive 2.
2. With the disk module active, key in 2 to GET BANK DISK 2. The drive clicks, its LED lights, and the display tells you that...

This Will Take
A While

After loading (about 20 seconds), the display then shows the Current Preset.

P03*

* or 1st Preset to appear upon loading

Note: If you try to get a Bank from a Library disk, which of. course doesn't store data in a Bank, the display will read:

Insert Perf Disk
And Press Enter

Insert a Performance disk, press ENTER, and continue.

3. To choose a different Preset, enter its number with the keypad (see GENERAL INSTRUCTIONS 1, "Selecting the Current Preset").
4. To choose which Current Preset will be active when you load a Bank, select the desired Preset just before saving the Bank to disk (see DISK 7, "Save Bank"). The Emulator II will default to that Preset whenever you load the Bank.

DISK MODULE

3 - SPACE REMAINING

The Emulator II can store about 500,000 “bytes” (a byte is a unit of computer memory) on each double-sided, double-density floppy disk. The “Space Remaining” function helps you avoid situations where you try to record more into the disk’s memory than it can hold (this won’t cause any damage, but it can be frustrating to run out of space in the middle of a hot sampling session).

The amount of available space is determined by how many Voices, Presets, and Sequences are on the disk. The more Voices, Presets, or Sequences, the less memory will be available.

1. Insert and latch the disk to be checked into either drive, or check two disks by inserting and latching a disk into each drive.
2. With the Disk module active, key in 3 to check SPACE REMAINING. For example, with a formatted but blank Performance disk inserted in Drive 1, the display will read:

Dsk1: 1 Bank

If there is already a Bank on the Performance disk, it will read:

Dsk1: 0 Banks

3. With Library disks, “SPACE REMAINING” tells how many bytes of memory remain; therefore, you can determine whether there is enough space to store a particular sound on disk.

Example: If a Voice is 123,000 Bytes long (see VOICE DEFINITION 15), and a Library disk has 150,000 bytes remaining, you will be able to store the Voice on the Library disk. Had the Library disk only 120,000 bytes remaining, you would not be able to store the Voice.

Selecting 3 (SPACE REMAINING) with the Disk module activated and a Library disk in Drive 1 produces the following display:

Dsk1: XXXXXXBytes

...where XXXXXX stands for an up to six-digit number. With a formatted disk that contains no voices this will be 494592 bytes. As you record voices on the disk, this number will decrease.

Note: Inserting a disk into Drive 2 will produce a similar message except it will begin with Dsk2:

DISK MODULE

3 - DISK IDENTITY

If you forgot to label a disk, you might not know whether it is a Performance or Library disk. The **SPACE REMAINING** function can also identify the type of disk.

1. Insert and latch the disk to be checked into either drive, or check two disks by inserting and latching a disk into each drive.
2. With the disk module active, key in 3 to check identity. The display's top line checks the disk in Drive 1, the display's bottom line the disk in Drive 2.
 - If the last word in a display line is "Bank" or "Banks", the associated disk is a Performance disk.
 - If the last word in a display line is "Bytes", the associated disk is a Library disk.
 - If the disk has not been formatted, the display will ignore the disk and continue asking you to key in a Disk function number.

4 - COPY DISK

As you build up a collection of disks, remember that they are not indestructible. Therefore, E-mu recommends copying ("backing up") any disk, Performance or Library that contains material you don't want to lose. Preferably, keep copies at a separate location for maximum safety.

The following applies only to dual-drive Emulator II's. To backup a disk with a single-drive Emulator II, insert the disk to be copied, activate the Disk module, key in 4, and follow instructions given in the display.

1. Insert and latch the disk to be copied ("source" disk) in Drive 1.
2. Insert and latch the formatted disk being copied to ("destination" disk) in Drive 2.
3. With the Disk module active, key in 4 to COPY DISK. From now on, simply follow the display, which first asks:

**This WILL Erase
Memory OK? Y/N**

Copying will erase whatever is in the Emulator II's in memory. If that's not okay, press NO, save what's in memory on to another disk (DISK 7), then try copying again. Otherwise, press YES and the display will read:

**Src Disk in Drv1
Dst Disk in Drv2**

DISK MODULE

4. Confirm that the source disk (the one to be copied) is in Drive 1 and the destination disk (the one being copied to) in Drive 2, then press the flashing ENTER button. The display tells you that:

**This Will Take
A While**

After completing the copy, the display returns to the Module Identifier. Move on to the next disk operation, or de-activate the module.

DISK MODULE

5 - CATALOG VOICE

This function lists the Voices and associated file numbers (see GENERAL INSTRUCTIONS 4, "Library Disk Voice Numbering Protocol") on a Library disk.

1. Insert and latch a Library disk in either drive. If you accidentally insert a Performance disk, the display will say:

**Insert Libr Disk
And Press Enter**

If this happens, insert and latch a Library disk then press ENTER.

2. With the Disk module active, key in **5** to CATALOG VOICE. The display says:

**To Catalog
use Slider A**

3. Move Slider A to the bottom of its travel (closest to the keyboard); the display will show two voice file numbers (such as F01, F02, F03, etc. up to F099; see GENERAL INSTRUCTIONS 4) and their names. For example, a typical display might initially look like this:

**F01 Bass F#1
F02 Bass F#2**

Moving the slider will catalog (see GENERAL INSTRUCTIONS 7) the other voice numbers/names present on the Library disk.

6 - ERASE VOICE

This function erases a voice from a Library disk.

1. Insert and latch a Library disk in either drive.
2. With the Disk module active, key in **6** to ERASE VOICE. If both drives contain a Library disk, the display asks:

**Which Drive?
Press 1 or 2**

Press 1 or 2 to select the drive containing the voice to be erased. After doing this, or if there is only one Library disk inserted and latched, the display says:

**Erase Voice
(01 – 99)/Slider A**

DISK MODULE

3. Either use the keypad to specify the Voice number to be erased, or move Slider A to catalog (see GENERAL INSTRUCTIONS 7) the Library disk Voices. When the display shows the Voice number to be erased, press ENTER.
4. The display gives you a last chance to re-consider:

Erase Voice XX
Erase? (Yes/No)

If you change your mind about erasing the voice, press **NO** and deactivate the disk module. If you really and truly want to erase the voice, press **YES**.

DISK MODULE

7 - SAVE BANK

After you've developed a great Bank, this function saves it to a Performance disk. Remember -- Save whenever you have something you don't want to accidentally lose.

1. Insert and latch a previously formatted Performance disk in either drive. If the disk already contains a Bank, saving a new Bank will erase the old Bank.
2. With the Disk module active, key in 7 to SAVE BANK. The display asks:

**Which Drive?
Press 1 or 2**

3. Tell it which drive to save to by pressing 1 or 2 then proceed to step 4. With single-drive Emulator us, press YES to continue the saving process.
4. Regardless of whether you have a single- or dual-drive Emulator II, the display will now tell you that:

**This Will Take
A While**

5. After saving the Bank, the display returns to the Module Identifier. Either enter a new number to do more disk tricks, or de-activate the Disk module.

DISK MODULE

8 - FORMATTING A PERFORMANCE OR LIBRARY DISKETTE

Before a new disk can record (store) any data, it first must be told how to record this data (called formatting the disk). Run the following formatting procedure on any new disk, or on “recycled” disks previously used with other systems (such as home computers) since these will not be formatted correctly for the Emulator II. Formatting not only formats the disk, but also writes the Emulator II’s operating software (the software that tells the system how to operate).

Note: Formatting a disk that already contains data will “bulk erase” any data on the disk being formatted. Always check that disks are either blank, or contain nothing you want to save, before formatting. A disk need only be formatted once unless you want to use the “bulk erase” aspect of formatting.

We recommend using 5.25” double-sided, double-density floppy disks. Avoid bargain disks; stick to name brands such as Maxell and Dysan. Buying in quantity can save you lots of money, so get together with other Emulator II owners and do group disk purchases for substantial discounts.

1. Insert and latch a previously formatted Library or Performance disk in Drive 1.
2. Insert and latch the disk to be formatted in Drive 2.
3. With the Disk module active, key in 8 to FORMAT DISK. The display asks:

Which Disk Type?
1=Perf 2=library

Key in 1 and the disk in Drive 2 will be formatted as a Performance Disk; key in 2 for a Library Disk.

OK to Erase Mem?
(it’s faster) Y/N

If you press YES, anything you had in the Emulator II’s memory will be erased. This leaves more memory for formatting, which speeds up the process. However, if you have a great Bank but forgot to format a disk, all is not lost; you can save what’s in memory by pressing NO (however, formatting will take quite a bit longer). After formatting the disk save the Bank to memory (DISK 7).

Whichever you press, eventually the display asks:

Format Perf Disk
In Drive 2 (Y/N)

Or

Format Libr Disk
In Drive 2 (Y/N)

DISK MODULE

...depending on whether you are formatting a Performance (Pert) or Library (Libr) disk. This is your last chance to stop the formatting process; remember, formatting erases EVERYTHING on a disk, so think twice before pressing YES. (If you press NO, the display returns to the Module Identifier.) After pressing YES, the display says:

**Formatting in
Progress . . .**

Formatting takes just enough time that you can get a drink of water or do a couple of sit-ups. After formatting is complete, the display asks:

**Format Another
Disk? Yes/No**

To format another disk, remove the newly formatted disk from Drive 2, insert and latch the next disk to be formatted in Drive 2, and then press YES. Otherwise, press NO, at which point the display returns to the Module Identifier.

HARD DISK SUPPLEMENT

HARD DISK SUPPLEMENT

BACKGROUND: WHY HARD DISK

THE HARD DISK PERSONALITY

POWER-ON WITH HARD DISK MODEL

HARD DISK SECTION NOTES

HARD DISK SUPPLEMENT

BACKGROUND : WHY HARD DISKS

The standard Emulator II comes with two floppy disk drives for saving and loading Bank information. Replacing the second floppy drive with a Hard Disk drive offers two big advantages:

- Greater storage. The Hard Disk holds 46 Banks, the floppy 1 Bank.
- Faster access time. A Bank can be saved from the Emulator II to the Hard Disk in 4 seconds (as opposed to 1 minute for saving to a floppy), or loaded from the Hard Disk to the Emulator II in 2 seconds (as opposed to approximately 30 seconds for loading from a floppy).

What this means is that you can have a large library of banks stored in the Hard Disk, and that any of these Banks can be loaded into the Emulator II almost instantaneously.

That's the good news, but there is a catch: **Hard disks are fragile**. Dropping an Emulator II with the power on will probably destroy the Hard Disk. Furthermore, in tests conducted at the factory, hard disk failures would occur if the Emulator II was dropped from heights of as little as 8 inches even with power off.

CAUTION: Hard Disk owners are boldly going where few have gone before. Hard disks in general inhabit safe, predictable computer installations where they lead a climate-controlled life free of the perils of a rock and roll band on the road. Although some portable computers do include hard disks, these are usually treated with kid gloves compared to music gear.

E-mu's durability tests for Hard Disk equipped Emulator II's have been positive, and so we are making the Hard Disk available as an option. Studio musicians will appreciate having 46 Banks "on-call" at all times, and touring performers will enjoy not having to deal with the 30 second Bank load time for floppies.

Please note, however, that we are offering the hard disk for experimental usage only and cannot be responsible for any losses or damages, including consequential losses or damages, due to Hard Disk failures.

THE HARD DISK PERSONALITY

In most cases, you can treat the Hard Disk just like a super-floppy; transferring data to and from the Emulator II is straightforward.

However, over time the Hard Disk can develop errors (particularly if system abuse occurs). This is analogous to what happens if you play a record over and over and over again, and eventually, a pop or scratch develops. In fact, just like records that come with a scratch or two, many brand new Hard Disks already have errors when they're shipped. This usually makes people cringe - what, buy a product with known defects?!? But consider that a typical Hard Disk holds 20,000,000 bytes of data. If a few bytes are missing here and there, no big deal you still have plenty of bytes left over. All you need to do is instruct the computer not to write data over the bad bytes, and all is well.

Any new hard disk will come with an error log that contains a list of all known errors; this information, along with operating system software necessary to format the Hard Disk, is stored

HARD DISK SUPPLEMENT

in the Emulator II's Hard Disk software diskette (supplied with the Hard Disk upgrade). Should additional errors occur over time, the disk's error log can be updated to include these new errors, and the computer instructed not to write over the bad bytes.

Like a floppy disk, the Hard Disk must be formatted initially to accept data. However, a hard disk must also be formatted if the hard disk "crashes" (which can occur if, say, power is interrupted in the middle of a write-to-hard-disk operation).

This supplement will cover hard disk basics, and then discuss the Hard Disk functions that are accessed via the Disk module. These functions cover almost all of your day-to-day use of the Hard Disk. The final part will describe Hard Disk functions accessed via the Special module, which are much less commonly used. These will be discussed in reverse numerical order (SPECIAL 22, SPECIAL 21, etc.) since for some reason, this seems to present everything in the most logical order.

POWER-ON WITH HARD DISK MODEL

The floppy disk is Drive 1, the Hard Disk Drive 2. When you first turn on power, the Emulator II will test the floppy drive. If there is no floppy disk in Drive 1, the Emulator II will boot (load its operating system software) from the Hard Disk. This is the preferred mode of operation, as referring to the Hard Disk for the operating system software greatly speeds up overall Emulator II operation (i.e. there is virtually no delay when switching from module to module within the Emulator II).

The Hard Disk takes a while to "warm up" whenever it is turned on. Upon turn - on, the Hard Disk's green "activity" LED will light, indicating that the Hard Disk is testing itself. After about 30 seconds, the red "ready" light will come on, indicating that all systems are go.

If there is a floppy disk in Drive 1, the Emulator II will boot from the floppy. This allows you to easily boot the machine if the Hard Disk is malfunctioning for any reason.

Example:

Suppose power is interrupted to the Emulator II Hard Disk, and the system "crashes." You could re-boot from the Hard Disk software floppy, thus loading software with which you can re format the Hard Disk.

HARD DISK SECTION NOTES

All disk module functions (except GET BANK DISK 2 and SAVE BANK (TO DISK) relate exclusively to the floppy disk. The Hard Disk may be ignored if desired, in which case the Emulator II operates just like an Emulator II with a single floppy disk drive.

Note: The Hard Disk can neither read nor write Library disk data, so all Library functions must be handled through floppies.

HARD DISK SUPPLEMENT

DISK 2 - GETTING A BANK FROM HARD DISK

This function loads Banks from the Hard Disk into the Emulator II.

1. GET BANK DISK 1 reads a Bank from the floppy drive. To get a Bank from the Hard Disk, enter the Disk module and key in 2 (GET BANK DISK 2).
The display says:

**Get HD Bank #
(02 - 47)/Slider A**

Move Slider A to catalog the Hard Disk Banks. When the display shows the Bank to be loaded, press ENTER. Alternately, enter a two-digit Bank number from 02 to 47 (leading zeroes must be entered) from the keypad. There is no need to press ENTER if you enter the Bank number directly.

2. After completing step 1, the display will say:

**Loading Bank
Get nn (name of preset)**

...where nn is the Bank number. Loading is complete in about 2 seconds.

HARD DISK SUPPLEMENT

DISK 7 - SAVING A BANK TO HARD DISK

This function saves a Bank from the Emulator II onto the Hard Disk.

1. While in the Disk module, key in 7 with the keypad. The display then asks whether you want to save to floppy or Hard Disk:

Save Bank
(01) or (02 - 47)

Pressing 01 saves the Bank to floppy disk, as described under Disk 7 in the Reference Section of the Emulator II Owner's Manual. Pressing 02 to 47 saves the Bank to the Hard Disk under the designated Bank number. In this case, the display will say:

Fnn Name Of Preset
Overwrite? Y/N

...where nn is the selected Bank number. "NameOfPreset" will be the Bank's default Preset if a Bank has already been written to the Hard Disk in this location, or a Null Preset if the Bank is empty.

Note: Error conditions can occur if you attempt to load a Bank from a location where no bank is saved. See "Important Note" under SPECIAL 22 for more information.

2. If you do not want to overwrite the existing Bank, press **NO** to stop the writing process and return to the Disk module menu. Press **YES** to overwrite the old Bank with the new Bank; the display says:

Writing Bank

The Hard Disk verifies the write operation, and then returns to the Disk module menu when all is complete. This entire operation takes about 4 seconds. If there is an error, an error message will appear in the display. We will describe how to deal with errors later on.

HARD DISK SUPPLEMENT

DISK 8 - FORMATTING FLOPPIES IN A HARD DISK SYSTEM

As with a dual floppy Emulator II, selecting DISK 8 (the formatting function) formats the floppy disk. However, you may load formatting software from either the Hard Disk or the floppy.

1. After selecting Disk 8 and specifying whether you want to format a Library or Performance disk, the display asks:

**Use Floppy Software
& Erase Mem? Y/N**

The usual answer is NO, since you want to use the Hard Disk -- not the floppy software when formatting the floppy. This makes the floppy compatible with the Hard Disk.

Note: If you originally booted from the floppy disk instead of the Hard Disk, a NO response will copy the original floppy operating software to the new floppy.

2. To format a disk that is compatible with non-Hard Disk machines, answer YES.

Note: The floppy in Drive 1 should contain the desired operating system software for the disk that you are about to format.

Example: If you are formatting a disk that will be played back on a non-Hard Disk drive Emulator II with Revision 2.3 software, make sure the operating system on the floppy in Drive 1 is standard (non-Hard Disk) Rev. 2.3 software.

HARD DISK SUPPLEMENT

HARD DISK SPECIAL FUNCTIONS

If the operating system currently in memory is Hard Disk compatible (which it will be if you booted from the Hard Disk, or from a floppy with Hard Disk operating system software), the Special module will contain a number of functions that relate specifically to the Hard Disk. This section describes the various functions.

SPECIAL 22 - FORMATTING

Just as a floppy disk must be formatted in order to receive Emulator II data, so must the Hard Disk. Formatting, which erases any existing Hard Disk data, occurs for one of two reasons:

- The Hard Disk has not been used previously and must be prepared for operation. However, NEVER format a Hard Disk before first checking whether or not there are any existing Banks on the Hard Disk that should be saved.
 - The Hard Disk has crashed for whatever reason, and is inoperable. Formatting will re-initialise the Hard Disk and erase any existing Banks. Hard Disk crashes are not frequent occurrences, which may lull you into a false sense of security. However, Murphy's Law dictates that a crash will occur at the worst possible moment and when you least expect it, so ALWAYS maintain floppy disk backups of any Banks stored on the Hard Disk.
1. Assuming that the machine has been booted from the Hard Disk (or if the Hard Disk is inoperable, from a floppy containing the proper Hard Disk operating system software). Enter the Special module and move Slider A until you hit the last listing. At the time of this writing, the last line says "HD Lap 10 Rev 2.2," which translates as follows:

HD	=	Hard Disk
Lap	=	Manufacturer code
10	=	Hard Disk capacity in Megabytes
Rev 2.2	=	Software revision.

In the future, other manufacturer codes, disk capacities, and software revisions may be used instead of the examples given above. The point of checking this line is to make sure that the Hard Disk software floppy has the same identifier written on its label.

HARD DISK SUPPLEMENT

2. Enter 22 via the keypad. The display says:

**Format Hard Disk
DESTROYS ALL!Y/N**

DESTROYS ALL! Does not mean that Godzilla will appear outside your window, but rather, that any data on the Hard Disk will be erased during the formatting process. Press NO if you want to exit this function; to continue formatting, press YES. The display asks you to:

**Insert Error Log
&HD Sftwe Floppy**

Insert the special Hard Disk software floppy (supplied with the Hard Disk upgrade) into Drive 1, as this floppy contains the Hard Disk formatting software and also contains the error log (which as you recall, contains information about which parts of the Hard Disk should not be used for storing data). Note that this error log is also typed on a piece of paper affixed to the disk.

3. After inserting and latching the floppy in Drive 1, press ENTER. The error log saved on the floppy will load into memory, and the formatting process will begin. After formatting is complete, the display asks:

**Reload Backup
Floppies Y/N?**

This routine makes it easy to transfer a bunch of Banks stored on floppy disk over to the newly formatted Hard Disk. To load up the Hard Disk, press YES. The display says:

**Insert Floppy Disk
02 and Press Enter**

Insert the floppy containing the Bank that you want to appear on the Hard Disk as Bank 02, and then press ENTER. Since the display likes to keep you posted on what it's up to, the following message will appear:

**Reading the Backup
Floppy**

After the floppy data is loaded, the display then says:

**Writing Backup
Data to HardDisk**

When the operation is complete, you will be asked to insert floppy disk 03 (i.e. the floppy containing the Bank which you want to appear on the Hard Disk as Bank 03). Repeat the same ritual described above for loading floppy 02. The Emulator II will keep asking you for disks until the Hard Disk is all filled up with Banks.

HARD DISK SUPPLEMENT

4. If you answered NO at the beginning of step 3, the display tells you that the Emulator II is...

**Saving All Banks
As Null Presets**

...which fills up the Hard Disk with null Presets. This operation takes about two minutes, so you have enough time to dust off the Emulator II keyboard, tidy up the studio a bit, or make a quick phone call.

Important Note: Errors

If you choose to load the Hard Disk from floppies, but exit the Disk module before all Presets have been loaded, look out!!

Calling up non-existent Banks will cause crashes until data is loaded into those Banks. A simple way to insure that this doesn't happen is to first load the Hard Disk with null Presets, then load Banks into the Hard Disk by 1) loading Banks into the Emulator II (from floppy disks) and 2) saving Banks to the Hard Disk. Note that this is more time-consuming than the "Reload Backup Floppies" routine described earlier.

If an error occurs during formatting, the display will slowly scroll out the message "D-I-S-K R-E-A-D E-R-R-O-R." This looks like one of those Time Square message boards and is rather entertaining. The message will continue to be sent until the end of the formatting process even after formatting has moved along to sections of the Hard Disk that do not contain errors.

HARD DISK SUPPLEMENT

SPECIAL 21 - SHOW HARD DISK ERROR LOCATION

This function pinpoints where an error has occurred on the Hard Disk.

1. To locate where an error has occurred, after formatting is complete load each Bank from the Hard Disk into the Emulator II memory. As soon as a problem occurs when loading a Bank, select SPECIAL 21 (Show HDErrLoc) to pinpoint the source of the error. SPECIAL 21 must be initiated immediately after the problem occurs, or you will get an "Invalid ErrData" message instead.
2. After keying in 22, the display will show three sets of numbers: A three-digit "cylinder" number, followed by a one-digit "head" number, followed by a five-digit "byte" number. These identify where the error is located on the Hard Disk. The ENTER light will be flashing, and the display says:

Save to Hard Disk
Error List Y/N

We haven't figured out why you would ever want to press NO, so press YES. This saves the error data to the Hard Disk. You are then asked...

Log Error on
FloppyDisk? Y/N

At this point, your Hard Disk software floppy should still be in Drive 1. If the floppy has been formatted with the Hard Disk software, it will contain an error log and pressing YES will update this log with the new error. If the floppy is not formatted for this function, a log will be created on the disk with just this one error.

3. After an error has been detected, the Hard Disk can still be used although you will not be able to access the Bank containing the error. To access all Banks, you will need to re-format the disk and re-load the Banks. After re-formatting, the bad section will be marked as "off limits" and the Hard Disk will operate normally.

Note: People sometimes wonder if having an error in a Bank reduces the quality or usefulness of the Bank. This is not a concern. Hard disks are engineered with a certain amount of redundancy so that should an error occur, there will be additional memory available to take its place.

After formatting the disk, you might want to send the Emulator II on an Error Scan hunt to make sure all error logs are accurate; see next section.

HARD DISK SUPPLEMENT

SPECIAL 20 - ERROR SCAN

This function causes the Hard Disk to go out and seek errors, and this information is used for updating data logs.

1. Enter the Special module and key in 20. The display asks:

Use Floppy Disk
Error Log? Y/N

If you enter YES, the Emulator II assumes that all errors already listed on the floppy log are indeed errors and checks the remaining areas of the Hard Disk. If you answer NO, the Emulator II assumes that all errors already listed on the Hard Disk error log are indeed errors and checks the remaining areas of the Hard Disk. YES is generally the preferred response.

Whichever way you answer, the display then asks:

Error Scan Takes
8 mins OK? Y/N

If you decide you really don't have eight minutes, press NO and exit the function. Otherwise, press YES. The Hard Disk's green light will indicate that the Hard Disk is active and scanning for errors. Eight minutes is a goodly amount of time, so don't spend it staring at the Emulator II you're better off writing a post card or two to some friends, or catching up on phone answering machine messages.

After the scan is over, the Emulator II will not tell you whether it found any errors. Sorry about that -- it seems that hard disks embarrass easily, and they hate to admit they're not perfect. However, they do keep track internally of any errors they have found, and you can save this new error log on the Hard Disk when the display asks:

Write Err Log to
Hard Disk? (Y/N)

No one has ever answered NO to these questions, since it seems kind of silly to send the disk on an error scan and then not have it make a note of any errors it finds. So, press YES. This error information will be taken into account next time you format the disk, and the Hard Disk will ignore those sections of the disk containing errors.

Whether you answer YES or NO, the display then asks:

Write Error Log
To Floppy? (Y/N)

If you select NO, the error scan operation is complete. If YES, the error log is written on to the Hard Disk software floppy, which at this point should still be in Drive 1.

HARD DISK SUPPLEMENT

SPECIAL 19 - ENTER ERROR LIST

This is not a common operation, except at the factory where an error log is created for the first time. However, if a catastrophic disk crash occurs where the error log list has been lost, this procedure is necessary for re-creating the error log.

Note: Hard disks come with an error log as provided by the manufacturer. This information is supplied by E-mu with the hard disk (also see Hard Disk software label). This, plus any additional errors that are discovered, consult the error log.

1. Enter the Disk module and enter 19. The display asks:

Use Floppy Disk
Error Log? (Y/N)

Normally the answer is NO, since you will probably be using the factory-supplied list of Hard Disk errors. If you already have a floppy disk with operating software that contains the error log, you would enter YES.

2. After entering NO, the display prompts you to enter the supplied data in the following format:

of Defects in
List? (00-99)

(00 - 99) - Enter the total number of defects listed. The display now says:

Dfct nn Head#?
(0-3)

...where nn is a defect number; enter the head # data (0-3) from the defect list.

The display now asks...

Dfct nn Cyl#?
(0- three digit number)

Enter the cylinder number listed for that defect. The display now asks:

Dfct nn Byte-IX?
(00000-20K)bbbb

Enter the byte number listed for that defect. Continue cycling through these messages until the entire error list has been entered.

HARD DISK SUPPLEMENT

3. After all errors have been noted, press ENTER. The display now says:

Write Error Log to
Hard Disk? (Y/N)

If your next operation is to format the Hard Disk, which happens 90% of the time, press NO. If the Hard Disk is already formatted, press YES to update the existing error log. In either case, you next have the option to write the error log to floppy disk when the display says...

Write Err Log to
Floppy? (Y/N)

Make sure that your Hard Disk software floppy is in Drive 1, and then press YES. After formatting the Hard Disk, this software can then be loaded into the Hard Disk to create an up-to-date error log.

SPECIAL 18 - AUTO HARD DISK BACKUP

Enter the Special module and key in 18 to save everything on the Hard Disk to floppies. All you have to do is get your floppies ready, read the display, and follow instructions.

(Someday, robots will do this type of thing...).

SPECIAL 17 - COPY HARD DISK SOFTWARE

This function is available primarily for updating the Hard Disk operating system as updates become available.

1. Enter the Special module and key in 17 with the keypad. The display says:

Copy will Erase
Memory OK? Y/N

If you press YES and carry on with the software writing process.

BE VERY CAREFUL

Triple check that the software being loaded on to the Hard Disk is the proper Hard Disk software. If you accidentally write non-Hard Disk software on to the Hard Disk, it will get amnesia and not even remember that it's a Hard Disk.

REALTIME CONTROL MODULE

Wheels

0 - OFF

1 - PITCH

2 - FILTER FC

3 - LEVEL

4 - LFO to PITCH

5 - LFO to FILTER Fc

6 - LFO to LEVEL

7 - ATTACK RATE

Footswitches

0 - OFF

1 - SEQUENCER CONTROL

2 - SUSTAIN

3 - RELEASE

4 - SUSTENTUTO

5 - ADVANCE PRESET

REALTIME CONTROL MODULE

CONTROL 0 - Destination: OFF

1. To turn off (disable) the control source (selected as per GENERAL INSTRUCTIONS 6), key in 0.

CONTROL 1 - Destination: PITCH

1. To assign pitch bend to the control source (selected as per GENERAL INSTRUCTIONS 6), key in 1.

Application: Generally, this destination is assigned to the left-hand wheel, which has a center detent. When so assigned, the center position gives no pitch bend. Rotating the wheel away from you bends pitch up, while rotating the wheel towards you bends pitch down. Maximum pitch bend is ± 3 semitones.

CONTROL 2 - Destination: FILTER Fc

1. To assign filter cutoff frequency control to the control source (selected as per GENERAL INSTRUCTIONS 6), key in 2.

Application: This destination is normally assigned to the right wheel or pedal to add expressiveness to your playing.

Example: Brass sounds often increase in brightness towards the end of notes; simulate this by using the wheel to increase the filter cutoff frequency towards the end of a note. FILTER Fc can also be assigned to the footpedal for wa-wa effects; turn up the Q to simulate the most commonly used wa-wa sound.

Note: This function interacts with the filter module frequency and envelope settings. If the wheel does not seem to be working correctly, check these settings. Example: If the filter cutoff is already at maximum, you will not be able to use the wheel to increase the cutoff frequency.

For the Right wheel to cover the greatest possible filter sweep, select FILTER 1C and set the envelope to +00. Next, assuming that the Right wheel is assigned to Filter Fc, rotate it fully towards you and adjust filter Freq for the lowest desired filter cutoff frequency. Rotating the Right wheel away from you will increase the filter cutoff.

With varying amounts of filter envelope selected (FILTER 1C), the FILTER Fc function will still work but its effects will not be as obvious.

REALTIME CONTROL MODULE

CONTROL 3 - Function: LEVEL

1. To assign overall level to the control source (selected as per GENERAL INSTRUCTIONS 6), key in 3.

Application: Probably the most common use is to assign LEVEL to the footpedal, thus giving footpedal-controlled volume. Or, assign this destination to the Right wheel when you need a manual volume control (such as during fadeouts).

Assigning LEVEL to the Left wheel can also be useful. At center position, the volume level is audible but can be increased by rotating the wheel away from you. Rotate the wheel towards you to fade out the sound completely.

CONTROL 4 - Function: LFO to PITCH

1. This function controls the extent to which the LFO modulates pitch (VIBRATO DEPTH). To assign this destination to the control source (selected as per GENERAL INSTRUCTIONS 6), key in 4. (To change the LFO rate and LFO variation, refer to sections VCA/LFO 2A and 2C.)

Application hint: This destination is most often assigned to the Right wheel; rotating the wheel away from you increases the amount of vibrato. Assigning this destination to the footpedal provides foot-controlled vibrato.

Note: This function is operative only if Voice Definition function 23A is set at 00. Otherwise, Vibrato Depth in the Voice Definition module has priority over the wheel-assigned LFO to PITCH.

REALTIME CONTROL MODULE

CONTROL 5 - Function: LFO to FILTER Fc

1. This function controls the extent to which the LFO modulates the filter cutoff frequency. To assign this destination to the control source (selected as per GENERAL INSTRUCTIONS 6), key in 5. (To change the LFO rate and LFO variation, refer to sections VCA/LFO 2A and 2C.)

Application: This destination is most often assigned to the Right wheel; rotating the wheel away from you increases the amount of filter modulation (“filtrato”). Assigning this destination to the footpedal provides foot-controlled filtrato. Slow filtrato is useful for varying the timbre on long, sustaining sounds; fast filtrato gives a “bubbly” sound, which can resemble that of mechanical rotating speaker systems.

Note: This function works only with Filter function 2A (LFO Amount) set at 00. Otherwise, LFO Amount in the Filter module has priority over the wheel-assigned LFO to FILTER Fc.

Also, LFO to FILTER Fc interacts with the filter module frequency and envelope settings. If this function does not seem to work, check these settings.

Example: If the filter cutoff is already at maximum, you will not be able to modulate it to any great degree.

CONTROL 6 - Function: LFO to LEVEL

1. This function controls the extent to which the LFO modulates the overall level (tremolo). To assign this destination to the control source (selected as per GENERAL INSTRUCTIONS 6), key in 6. (To change the LFO rate and LFO variation, refer to sections VCA/LFO 2A and 2C.)

Application hint: When assigned to the Right wheel, rotating the wheel away from you increases the amount of tremolo. Assigning this destination to the footpedal provides foot-controlled tremolo. Tremolo is useful for “Bo Diddley” and surf music guitar sounds, as well as for simulating some electric piano sounds.

Note: This function is operative only if VCA/LFO function 2D (LFO to VCA) is set at 00. Otherwise, LFO to VCA in the VCA/LFO module has priority over the wheel-assigned LFO to LEVEL.

REALTIME CONTROL MODULE

CONTROL 7 - Function: ATTACK RATE

1. ATK RATE controls the VCA attack rate. To assign this destination to the control source (selected as per GENERAL INSTRUCTIONS 6), key in 7.

Application hint: When assigned to the Right wheel, rotating the wheel away from you increases the attack time. This effect is useful when changing from legato to percussive effects, especially with sustained sounds such as strings.

Note: With ATK RATE assigned to a wheel, VCA/LFO module function 1A (VCA attack) and Filter module function 3A (filter attack) are disabled. Therefore, Filter and VCA attack rates are determined solely by the wheel setting.

FOOTSWITCH 0 - Function: OFF

1. To turn off the footswitch (selected as per GENERAL INSTRUCTIONS 6), key in 0.

FOOTSWITCH 1 - Function: SEQ CTRL

1. To start and stop the Sequencer via footswitch, after selecting the desired footswitch key in 1.

FOOTSWITCH 2 - Function: SUSTAIN

1. For footswitch controlled sustain, after selecting the desired footswitch (as per GENERAL INSTRUCTIONS 6) key in 2.

Note: If you play a looped sound while the footswitch is pressed, as soon as the looped portion begins it will sustain (even after lifting your fingers off the keys) until the footswitch is released. Holding down the footswitch continuously provides a hold function for looped notes, where the last eight notes played will sustain for as long as the footswitch is pressed.

If you play an unlooped sound while the footswitch is pressed, it will play through its entire length (whether or not you are holding down a key), then stop.

REALTIME CONTROL MODULE

FOOTSWITCH 3 - Function: RELEASE

1. For footswitch-controlled release, select the desired footswitch (as per GENERAL INSTRUCTIONS 6) then key in 3. Any note played while the footswitch is pressed will play through its entire length, whether or not you continue to hold down a key. Looped sections are not repeated unless you hold down the key. Releasing the footswitch cancels release.

Application: If you have a Voice with a short release but where there are sounds after the end of the loop, playing the sound normally will play through to the end of the loop and you will not hear the sounds that occur after the loop. However, if you press down on the release footswitch during the loop and remove your finger from the key, the Voice will play through to the end -- including the "after-loop" sounds.

FOOTSWITCH 4 - Function: SUSTENUTO

1. For footswitch-controlled sustenuto, select the desired footswitch (as per GENERAL INSTRUCTIONS 6) then key in 4. Pressing the footswitch will sustain any keys being held down at the moment the switch is pressed. Notes played after pressing the footswitch will play normally. To cancel the sustaining notes, release the footswitch.

Application: Sustenuto can sustain a few notes while the rest of the keyboard plays normally. For example, press the footswitch while holding a bass note for a pedal point bass effect, then play notes normally on top of the sustaining bass sound.

FOOTSWITCH 5 - Function: ADVANCE PRESET

1. To advance via footswitch from one Preset to the next higher numbered Preset (i.e. from Preset 01 to Preset 02), select the desired footswitch (as per GENERAL INSTRUCTIONS 6) then key in 5.

Press the footswitch momentarily to advance to the next Preset. Advancing past the highest-numbered Preset resets the Emulator II to the lowest numbered Preset.

Note: If you advance to a Preset that does not have this destination assigned to one of the footswitches, you will not be able to advance out of that Preset.

ENTER MODULE

ENTER MODULE

ENTER MODULE

ENTER DATA

ENTER is a module that the Emulator II, rather than you, activates. Just as you can activate a module to tell the Emulator II something you want to do, The Emulator II can activate this module to tell you something it wants you to do.

Sometimes the display will ask you for data (i.e. such as keying in a number to indicate a parameter you want to change). If the ENTER LED is flashing, the Emulator II is in a "holding pattern" where you must enter the desired data, or de-activate the module, before the Emulator II can move on to other functions (however, you can still play the keyboard). After keying in the data, press ENTER to send the data into the Emulator II's computer.

If the ENTER LED is lit steadily, you have the option of hitting ENTER or de-activating the module, as described above; or, you can go directly to another function within the module.

SEQUENCER MODULE

SEQUENCER MODULE

BACKGROUND

EXT CLOCK

SETUP

EDIT

SEQUENCER MODULE

BACKGROUND

The Emulator II eight-track Sequencer not only records up to eight tracks of Presets from the Emulator II, but can sequence up to eight MIDI instruments via the MIDI OUT port. Sequences are saved on a Performance disk as part of the Bank.

Each Sequencer track can polyphonically record the notes you play from any one Preset in the Emulator II's Bank. Although you cannot record two different Preset sounds on one track, you can record different Presets on different tracks. Also, you can play as many simultaneous notes as desired on a track, but will only hear as many notes as the instrument is capable of playing (eight notes for the Emulator II).

Hint: If all the Presets in a Bank are variations on one instrument, you won't be able to sequence multi-instrumental compositions. There are two ways around this. One, make up a Performance disk with some drum sounds, bass, a chordal instrument, etc. By choosing sounds wisely and using loops, you can fit several different instrument sounds on a single Performance disk. The other option is to drive other instruments via the MIDI port. For example, if you drive a MIDI-based drum machine then it no longer becomes necessary to have a drum Preset in the Bank. For more information on creating Presets specifically for Sequencer applications, see Part 4 of the Advanced Applications section.

To sequence MIDI instruments, simply create a Preset, enter the desired MIDI parameters (see PRESET DEFINITION 30, "MIDI Setup"), but don't assign any sounds to the Preset. Thus, as the Sequencer plays notes from this Preset, the note data will come out the MIDI port but not trigger any sound from the Emulator II. Note that each Preset can be assigned to its own MIDI channel; for more information on creating "MIDI Presets", refer to the MIDI/SMPTE supplement.

The Sequencer capacity depends on how many seconds of sampling time are left in the Bank. Each available second (27,500 samples) stores approximately 4,500 notes -- so if you have 10 seconds left, you've got a 45,000 note polyphonic sequencer!

WORKING WITH A SEQUENCE

Creating a completed Sequence involves five main steps. These are:

1. DEFINE the Sequence by creating, numbering and naming it, then specifying the time signature and sequence length.

Note: When driving MIDI instruments, if you do not want the Emulator II to double the MIDI instrument DEFINE a Sequence and assign MIDI Presets (as mentioned above) that have no Voices assigned to them.

2. Determine the tempo (clock) reference for the Emulator II -- either the Emulator II's internal clock, an external click track, MIDI, or SMPTE time code.
3. SETUP a Sequence track by selecting the track on which you want to record, specifying the tempo, choosing an auto correct setting to optionally round off any

SEQUENCER MODULE

human timing errors, programming an optional countdown and metronome (available at the MET OUT jack), and monitoring (cuing) the previously recorded tracks you want to hear.

4. RECORD the Sequence, then PLAY it back and STOP it at any time (the “tape recorder” controls). Or, SELECT a different Sequence for playback.
5. EDIT the recorded track in any of several ways: Erase the track, overdub a section by punch-in and punch-out, bounce up to eight tracks down to one track, store the real time control settings (you may assign as many control sources as desired for each track, however, a control source cannot be assigned to more than one track per Sequence), reassign a different Preset than the one with which the track was originally recorded, or increase the sequence length by appending any other Bank Sequence to the original Sequence (you may also append a Sequence to itself). At the end of this background section, we will cover the various Sequencer functions in the above order.

ACTIVATING AND DE-ACTIVATING THE MODULE

The Sequencer module does not have a single master switch for activation and de-activation. Instead, the Sequencer comprises several sub-modules (EDIT, DEFINE, CREATE, EXT CLK, etc.), each of which is activated by pressing its button. (Note: STOP can be activated only if a Sequence is playing.)

To de-activate any sub-module (except for PLAY) either press its switch again, select another sub-module within the Sequencer, or select another module elsewhere in the Emulator.

There are two ways to de-activate PLAY. Press STOP once and the Sequence will play through to the end and stop, or press STOP twice to immediately stop the Sequence.

THE “CURRENT SEQUENCE”

Just like the “Current Voice” and “Current Preset”, there is a “Current Sequence” which remains the same throughout the recording process unless you create a new Sequence or select a different Sequence by using the SELECT switch.

NOTES, PRESETS, TRACKS, and CHANNELS

The Emulator II can play up to eight notes at a time. You can distribute these notes in any way you like among the various tracks -- one track playing eight notes simultaneously, eight tracks each playing one note, and so on. If you try to sequence more than eight notes at a time, the sequencer will function normally but the Emulator II will not be able to play more than notes.

Output Channels assume far greater importance once you start using the Sequencer, since you might want to have different instrument sounds available at individual outputs.

Example: Suppose you have a bass Preset assigned to one track, a piano Preset assigned to another track, a string section Preset assigned to yet another track, and that you want to feed these sounds into a mixer so that all sounds can be processed independently. Here’s one way to do it.

SEQUENCER MODULE

Since you expect to play only one bass note at a time, assign all the bass Preset Voices to Output Channel 1 (see PRESET DEFINITION 23, "Edit Voice" or PRESET DEFINITION 22, "Assign Voice"). Let's also suppose that you don't expect to play more than three notes at a time with the strings; assign the string Preset Voices to Output Channels 2, 3, and 4. This leaves four channels left over for the piano, which you assign to Output Channels 5 through 8. As you play back the Sequence, the instrument sounds will appear at their respective outputs as programmed when you assigned the Voices to the Presets. These outputs can then be sent to a mixer and processed independently.

SETUP PROTOCOL

Several of the Emulator II Sequencer functions (EXT CLK, Auto Correct, Metronome) involve a "setup" routine where you choose from numerous options. One slider selects the various steps of the setup routine, while another slider chooses options for each step of the setup. For example, one setup might be to select the Emulator II timing reference with Slider A, then choose between the various timing (synchronization) options with Slider D.

Once the display shows the desired option, it is no longer necessary to move Slider D. Move Slider A to enter the existing value and proceed to the next step in the setup routine.

Note that your choices for setup remain as chosen unless you change them or turn off the instrument. (Upon turning the instrument back on, all setup routines assume their default values.) Also, note that the Emulator II will change some setups automatically -- for example, when you go into record mode on the Sequencer, the Emulator II will select the lowest-numbered available track for a selected Sequence under either of two conditions:

- 1) The instrument has just been turned on
- or
- 2) You are activating the Sequencer module after having previously deactivated it.

However, as long as you stay in the Sequencer module, the instrument will select or erase the track just selected or erased.

SEQUENCER MODULE

SEQUENCER EXT CLOCK

The Emulator II can synchronize to one of several different tempo references: Internal clock, external click track, MIDI timing messages, or SMPTE time code. It can also generate (write) a click track or SMPTE time code signal on tape. Once recorded, these signals can feed the Emulator II during overdubs to maintain synchronization with the original tempo.

Note: You cannot activate EXT CLOCK unless there is a defined Sequence in the Bank. For more information on defining a Sequence, see SEQUENCER DEFINE 1-3.

1. With the EXT CLOCK sub-module active, the display says:

**External Clock
Move Slider A**

Moving Slider A upwards from the bottom of its travel goes through the steps of the external clock setup. Slider D chooses options for each step. Once the display shows the desired option, move Slider A upwards to the next step in the setup.

2. With Slider A at the bottom of its travel, the display shows the default clock source (the Emulator II internal clock), and invites you to use Slider D:

**Clk Source: Int
Use Slider D**

To choose a click track plugged into the SMPTE IN Jack as a tempo reference, move Slider D upward from the bottom of its travel until the display says:

**Clk Source: Click
Use Slider D**

To select MIDI System Real Time Messages (as sent to the MIDI IN jack) as the tempo reference, move Slider D upward until the display says:

**Clk Source: MIDI
Use Slider D**

To select SMPTE (as sent to the SMPTE IN jack) as the tempo reference, move Slider D upward until the display says:

**Clk Source: SMPTE
Use Slider D**

When the display shows the desired timing reference, proceed to the next setup step.

SEQUENCER MODULE

3. Move Slider A upwards to the next step in the Ext Clock setup routine, which determines the click rate when reading a click track. Slider D chooses the options. The display initially gives the default value:

Click Rate: 24pqn
Use Slider D

With this setting (24 pulses-per-quarter note), a quarter note occurs for every 24 clock pulses received at the SMPTE IN jack. The E-mu Drumulator, most Roland equipment, PAIA Master Synchronizer, and most drum machines use this standard. Move Slider D upwards from the bottom of its travel and the display says:

Click Rate: 48pqn
Use Slider D

With this setting, a quarter note occurs for every 48 clock pulses received at the SMPTE IN jack. The LinnDrum and some Korg equipment use this standard. Move Slider D upwards and the display says:

Click Rate: 96pqn
Use Slider D

This is the standard used by Oberheim Electronics. When the display shows the desired click rate, proceed to the next step in the setup.

4. Move Slider A upwards to the next step in the Ext Clock setup routine; the display says:

Write Click Trk?
Press Yes

To generate a 24 pulses-per-quarter note click track signal at the MET OUT jack suitable for recording on tape, press YES. Note that the tempo should be set as desired before writing (see SEQUENCER SETUP 2, "Tempo"). After pressing YES, the display says:

Writing...Press
Enter to Stop

Use this signal to set record levels before rolling tape. Set about a -3 VU record level. After setting levels, press ENTER to stop writing. Roll the tape in record mode, leave a few seconds of blank tape, then press YES to start recording the click track on tape.

Always record more click track than you think you'll need. You can erase it later if you don't use it, and if you ever need it you'll be glad it's there.

SEQUENCER MODULE

When finished, press ENTER to stop writing. Note: Writing activity “locks up” the Emulator II. In order to proceed with other functions, de-activate the module. To continue the Slider A setup procedure, re-activate EXT CLK.

Hint: After recording a click track, play it back into the Emulator II via the SMPTE IN jack and play a Sequence (see SEQUENCER PLAY) to make sure that the click track was recorded at the right level and that there are no drop-outs or other problems. With most -10 dBV standard gear, the click signal will need to be pre-amplified in order to drive the Emulator II. Most +4 dBm standard gear delivers sufficient output to drive the Emulator II. If the click track bleeds over into other channels of the tape, try lowering the record level a bit and amplifying the signal coming from the tape output.

Note: Remember that the MET OUT outputs a trigger that occurs at the metronome rate; this trigger can be used for triggering synthesizer arpeggiators, electronic drum pads, event generators, and so on. For more information, see SEQUENCER SETUP 3 (“Auto Correct”).

5. Moving Slider A upwards gives the following display:

SMPTE Rate: 24fps
Use Slider D

This chooses the SMPTE frames-per-second rate. Slider D chooses between the following options:

24 fps (frames per second) = The standard frame rate for film

25 fps = The standard frame rate for European television and video

30 fps = The standard frame rate for American television and video.

When the display shows the desired SMPTE frame rate, proceed to the next setup step.

6. Move Slider A upwards to the next step in the Ext Clock setup routine. The display says:

SMPTE dropfr: no
Press Y/N

You may read or write SMPTE code in either dropframe or non-dropframe modes. Dropframe mode compensates for the time error in color television. To set up for outputting dropframe code press YES. Then write SMPTE to tape as usual. When you read a SMPTE track into the Emulator II the mode it was originally recorded in is detected. The dropframe or non-dropframe mode is automatically set.

SEQUENCER MODULE

7. Move Slider A upwards to the next step in the Ext Clock setup routine. The display says:

Write SMPTE Trk?
Press Yes

To generate a SMPTE time code signal at the SMPTE OUT jack suitable for recording on tape, press YES; the Emulator II will output SMPTE time code from the SMPTE output jack, starting at SMPTE start point 00:00:00:00 with a 30 frames-per-second rate (unless you specified a different frames-per-second rate in step You may specify a different SMPTE start point (this must be done prior to writing the track) as described in SEQUENCER SETUP 5, but no matter what the SMPTE start point, it should start before the start point of your Sequence. For example, if the SMPTE start point is 00:00:00:00, for best results the Sequence should start at 00:00:01:00 or later.

Note that tempo is derived from the SMPTE track during playback, so it is not necessary to set a specific tempo when generating or recording SMPTE. The display now says:

Writing ... Press
Enter to Stop

Use this signal to set record levels before rolling tape. Set about a -3 VU record level. After setting levels, press ENTER to stop writing. Roll the tape in record mode, leave a few seconds of blank tape, and then press YES to start recording the time code on tape.

Always record more time code than you think you'll need. You can erase it later if you don't use it, and if you ever need it you'll be glad it's there.

When finished, press ENTER to stop writing. Note: Writing activity "locks up" the Emulator II. In order to proceed with other functions, de-activate the module. To continue the Slider A setup procedure, re-activate EXT CLK.

Hint: After recording SMPTE time code, play it back into the Emulator II via the SMPTE IN jack and play a Sequence (see SEQUENCER PLAY) to make sure that the time code was recorded at the right level and that there are no drop-outs or other problems. With most -10 dBV standard gear, the signal will need to be pre-amplified in order to drive the Emulator II. Most +4 dBm standard gear delivers sufficient output to drive the Emulator II. If the SMPTE time code track bleeds over into other channels of the tape, try lowering the record level a bit and amplifying the signal coming from the tape output.

8. This completes the External Clock setup procedure. To review all settings, move Slider A. Settings will stay as programmed unless changed or the instrument is turned off.

SEQUENCER MODULE

DEFINE 1 - Function: CREATE SEQUENCE

This function lets you create, number, and name a Sequence. It is conceptually similar to creating a Preset.

1. Activate the DEFINE sub-module. The display shows the Module Identifier:

Seq Define (1 – 3)

2. Press 1 on the keypad. The display says:

Create Seq#
Press (01 - 99)

Enter a two-digit Sequence number (include leading zeroes) and press ENTER
The display will ask:

Copy from Another
Sequence Y/N

Unless you entered the number of an existing Sequence. If so, proceed to step 3.

To start a Sequence from scratch, press NO. To build upon an existing Sequence, press YES. If you press NO, proceed to step 3. If you press YES, the display will ask:

From Seq#
(01 – 99)/Slider A

...and the ENTER light will be flashing. Either use the keypad to specify the Sequence number, or move Slider A to catalog (see GENERAL INSTRUCTIONS 7, "Cataloguing") the available Bank Sequences. When the display shows the desired Sequence, press ENTER.

3. The display now asks:

SXX (name)
Rename? Y/N

...where XX is the two-digit Sequence number followed by the Sequence name. If you don't want to rename, press NO. To rename, press YES. Slider B positions the cursor under the letter you want to change, while Slider A chooses between lower case letters, capital letters, numerals 0 - 9, #, and space (top slider position). Continue positioning the cursor and entering letters until the name is complete, then press the flashing ENTER light.

Note: Specifying an existing Sequence number in step 2 gives you a chance to rename the Sequence using this procedure.

SEQUENCER MODULE

DEFINE 2 - Function: TIME SIGNATURE

This function sets the time signature for the Sequence.

1. With the DEFINE module active, key in 2. The display shows the default 4/4 time signature:

Time Sign 04/04
Use Sliders A&B

...unless the Sequence has already been recorded, in which case the lower line will say "Seq Is Not Empty". The time signature is recorded as part of the Sequence, and cannot be changed once a Sequence has been recorded.

2. Slider A varies the numerator of the time signature (the numbers of beats in a measure) from 01 to 16. An additional * option is available at the bottom of Slider A's travel. This mode neither specifies a fixed time signature nor accents the metronome on a specific beat, and is generally used in conjunction with * mode in SEQUENCE DEFINE 3 ("Sequence Length"), which defines the Sequence length in real-time. * mode is also useful if you are composing a piece of music with multiple time signature changes.

Whatever time signature mode you choose, be sure to plug the MET OUT jack into an amplifier so that you can monitor the metronome as you set the measure length.

Slider B provides three beat values for the denominator of the time signature: 04 (quarter note), 08 (eighth note), and 16 (sixteenth note).

3. When the display shows the desired time signature, press ENTER.

SEQUENCER MODULE

DEFINE 3 - Function: SEQUENCE LENGTH

Not too surprisingly, this function sets the Sequence length.

1. With the DEFINE module active, key in 3. The display shows the default Sequence length:

Length: 002 Meas
SlidrA(001-999)

...unless the Sequence has already been recorded, in which case the lower line will say "Seq Is Not Empty". The Sequence length is recorded as part of the Sequence and cannot be changed once, a Sequence has been recorded.

2. With Slider A at the top of its travel, you may enter the Sequence length via the keypad. Key in the desired three-digit number (leading zeroes must be included), then press ENTER.

With Slider A at the bottom of its travel, you may enter the Sequence length in real-time (* mode). Be sure to plug the MET OUT jack into an amplifier so that you can monitor the metronome as you set the Sequence length. Press RECORD to indicate the beginning of the Sequence, and STOP to set the end of the Sequence.

SEQUENCER MODULE

DEFINE 4 - SUPERMODE

This function allows the EII to receive MIDI Information over 8 different channels, and sound them through 8 different presets simultaneously! To use Supermode, you must first create a Supermode map which routes the MIDI channels to specific presets.

To create the Supermode map:

1. Define a new sequence and record a short, blank sequence of any length (don't play any notes). Each track you record listens to it's corresponding MIDI channel. Track 1 listens to MIDI channel 1, track 2 listens to channel 2, track 3 to channel 3, and so on. Repeat the blank recording process on any track whose MIDI channels you wish to use.
2. Activate the EDIT module and select 5 (REASSIGN PRESET). Assign each track to the desired preset. You now have a Supermode map that you can copy to other sequencer locations. By simply changing sequences, you can call up a new map!

To use the Supermode map:

1. Check that the EII's MIDI IN connects to the external sequencers MIDI OUT.
2. Make sure that the current preset is in OMNI mode (PRESET DEFINITION 30) and turn it's sequencer START/STOP setting to off.
3. Activate the DEFINE module and select 4. The display says:

Supermode: no
Press Y/N

Press ON to enable Supermode. The EII will now respond to multiple MIDI channels and route them to the preset specified in the Supermode map. Supermode is only active while the EII sequencer module is active.

SEQUENCER MODULE

Notes on EII Supermode

- Supermode is off when the EII Sequencer is running.
- Realtime controller data is not received over Supermode.
- Sending real-time controller data to the EII while in Supermode will slow the MIDI response by clogging the MIDI input.
- While in Supermode; Sustain information on any MIDI channel will affect the Current Preset.
- While in Supermode on Hard Disk units; MIDI Preset Change commands 53 - 99 on any MIDI channel will cause a Hard Disk bank to be loaded unless Preset Change (in the Current Preset MIDI menu) is set to OFF.

SUPERMODE MAP EXAMPLE								
EII PRESETS	05	01	02	10	06	21	15	04
EII TRACKS	1	2	3	4	5	6	7	8
MIDI CHANNELS	1	2	3	4	5	6	7	8

SEQUENCER MODULE

SETUP 1 - Function: SELECT TRACK

Before recording or punching-in, use this function to specify the track on which you want to record or punch.

1. With the SETUP sub-module active, key in 1. If you are calling up this function for the first time, the display gives the default track record assignment:

```
Tracks: 1
Record ^
```

The caret in the bottom line indicates the track on which you will record.

If you have already recorded some tracks, their track numbers will appear in the display. An asterisk will appear under the recorded tracks, which have been cued (see SEQUENCER SETUP 4), and the caret will appear under the lowest-numbered empty track. For example, suppose you had already recorded tracks 2, 3, 4, and 7, and that these were set up to be cued. The display would read:

```
Tracks: 1 2 3 4 7
Record ^ * * * *
```

2. To select a record track, simply key in its number with the keypad. If you choose an already recorded track, you will overwrite what's on that track. To continue with the setup process, press ENTER to return to the Module Identifier, then select the next function (SEQUENCER SETUP 2).

SEQUENCER MODULE

SETUP 2 - Function: TEMPO

This function sets the Sequence tempo. Tempo may be changed at any time; therefore, you can record a complex part at a slower tempo, and then bring the speed up to normal during playback.

1. With the SETUP sub-module active, key in 2. If you are calling up this function for the first time, the display shows the default tempo setting:

Tempo: 120BPM
Use Slider A

2. Choose a tempo in the range of 40 to 240 Beats Per Minute with Slider A. Note that the tempo moves in 1 BPM increments from 40 to 120 BPM, 2 BPM increments from 120 to 162 BPM, and 3 BPM increments from 162 to 240 BPM. Tempo is recorded as part of the Sequence.
3. To continue with the setup process, select the next function (SEQUENCER SETUP 3). To return to the Module Identifier, press ENTER.

SETUP 3 - Function: AUTO CORRECT

This command does not, as some people think, tune up your car. Instead, it does something much more important: It optionally “rounds off” the notes you play to a specified rhythmic value, thus eliminating timing errors. It also lets you set the metronome to one of six different rhythmic values.

1. With the SETUP sub-module active, key in 3. If you are calling up this function for the first time, the display shows the default auto correct and metronome settings:

Auto Corr = HiRes
Metronome 1/4

2. Slider A selects one of the following auto correct values:

1/4	every note you play will be rounded off to the nearest quarter note
1/4 t	every note you play will be rounded off to the nearest quarter note triplet
1/8	eighth note
1/8 t	eighth note triplet
1/16	sixteenth note
1/16 t	sixteenth note triplet
1/32	thirty-second note
1/32 t	thirty-second note triplet
HiRes	notes you play are all rounded off

SEQUENCER MODULE

3. Slider B selects one of the following metronome values:
 - 1/4 quarter note
 - 1/4 t quarter note triplet
 - 1/8 eighth note
 - 1/8 t eighth note triplet
 - 1/16 sixteenth note
 - 1/16 t sixteenth note triplet
 - click A 24 pulses-per-quarter note click track is send from the MET OUT jack.
4. To continue with the setup process, select the next function (SEQUENCER SETUP 4). To return to the Module Identifier, press ENTER.

SETUP 4 - Function: CUE

This function lets you cue (monitor) any or all of the tracks recorded in the Sequencer.

1. With the SETUP sub-module active, key in 4. If you have not yet recorded any tracks, the display says:

```
Tracks:
Cue On:
```

As you record tracks, the track number appears on the top line and an asterisk appears below each recorded track on the bottom line. For example, if you have recorded on tracks 3, 4, 5, and 8, the display shows:

```
Tracks: 3 4 5 8
Cue On: * * * *
```

2. To turn off a track, press the track number on the keypad; the asterisk will disappear. To turn the track back on again, press the track number on the keypad; the asterisk will reappear.
3. To continue with the setup process, press ENTER to return to the Module Identifier, then select the next function (SEQUENCER SETUP 5).

Hint: When using the Sequencer for live performance, cue can be used to turn “alternate” tracks on and off. For example, you could record two or three different solos on different tracks, and cue up a different solo for each set so that fans who see the band a lot won’t hear the same solo night after night.

SEQUENCER MODULE

SETUP 5 - Function: SMPTE START

You can start a Sequence by pushing PLAY (see SEQUENCER PLAY), or have the Sequence start automatically at a specific frame of the SMPTE time code. In this case, you would select SMPTE time code as the External Clock, and press PLAY (the PLAY LED will flash). As soon as the Emulator II receives the SMPTE time code frame number specified in this step, the Sequence will start playing and the PLAY LED will be lit continuously. You may also set a SMPTE start point when recording SMPTE time code on tape.

The SMPTE START feature is invaluable for film work, as you can sequence different sound effects and have them “drop in” at particular points in accordance with the time code.

1. With the SETUP sub-module active, key in 5. The display says:

SMPTE Start
00:00:00:00

The four pairs of digits represent (in order) hours, minutes, seconds, and frames. Use the keypad to enter the desired SMPTE start point; remember that the number of frames cannot exceed the number specified for the SMPTE frames-per-second rate specified during the EXT CLK setup routine. The SMPTE start point is remembered as part of the Sequence.

2. To continue with the setup process, press ENTER to return to the Module Identifier, and then select the next function (SEQUENCER SETUP 6).

SETUP 6 - COUNTDOWN

If you'd like a countdown before recording or playing back a Sequence, you've come to the right place.

1. With the SETUP sub-module active, key in 6. The display says:

Countdown=0beats
Press (0 – 9)

The default setting is 0 beats; in other words, the Sequence starts recording or playing back the instant you press PLAY. Use the keypad to program the number of beats in the countdown. The countdown will remain until changed, and occur every time you record or play back a Sequence. Note that “beat” refers to the beat as defined in SEQUENCER DEFINE 2 (Time Signature), not necessarily the metronome click.

2. To exit, press ENTER (returns to Module Identifier), deactivate the sub-module, or activate another sub-module.

SEQUENCER MODULE

RECORD, PLAY and STOP

You can think of these three switches as the “tape recorder controls” since they act very similarly to the equivalent controls on a multi-track tape recorder.

Record

To record a Sequence, first press RECORD to put the Sequencer in “record ready” mode. Then, press PLAY to begin recording. If you programmed a countdown (SEQUENCER SETUP 6), the number of beats you programmed will elapse before recording begins. Note that unlike a tape recorder, you do not need to hold down RECORD as you press PLAY.

Two cautions: A Sequence must play through to the end for a track to be recorded; if you stop a Sequence while it’s recording by pressing STOP, what you just played will not be recorded. Also, note that upon pressing RECORD and PLAY any existing note data on the track will be erased.

Playback

To play back a Sequence, press PLAY. If you programmed a countdown (SEQUENCER SETUP 6), the number of beats you programmed will elapse before playback begins. If you programmed an External Clock input (SEQUENCER EXT CLK), the Play LED will flash until the External Clock signal appears.

There are two ways to stop a Sequence from playing. To stop playback at the end of the Sequence, press STOP once. To stop playback immediately, press STOP twice.

Stop

In addition to performing the functions described above, pressing STOP also determines the end of the Sequence under the circumstances described in SEQUENCER DEFINE 3 (Sequencer Length).

SEQUENCER MODULE

SELECT SEQUENCE

This function lets you select any of the Bank Sequences for playback and/or additional recording.

1. To select a Sequence, first press SELECT. The display shows the Current Sequence number:

Select Seq# XX
SXX (name)

...where XX is the Current Sequence number. Either use the keypad to specify a Sequence number, or move Slider A to catalog (see GENERAL INSTRUCTIONS 7, "Cataloguing") the available Bank Sequences. When the display shows the desired Sequence, press ENTER. This now becomes the Current Sequence.

2. Exit the function by pressing SELECT again, pressing ENTER, or calling up another module.

SEQUENCER MODULE

EDIT 1 - ERASE TRACK

This function erases any track from a Sequence.

1. With the EDIT sub-module active, key in 1. The display says:

**Erase An Entire
Track Y/N**

To erase an entire track, including any stored controls assigned to that track, press YES and proceed to step 2. To erase just the stored controls but leave the note information intact, press NO; the display says:

**ErasControl
Use Slider A**

Varying Slider A lists the various Real Time Control destinations, and shows to which track each destination is assigned. To erase a stored control, press ENTER when the display shows the stored control to be erased.

2. If you specified YES in step 1, the upper display line shows the tracks which have been recorded, and the lower line asks which track you want to erase. Example: If you've recorded on tracks 1 through 5, the display would look like this:

**Tracks:12345
Erase Track #**

Specify the track to be erased with the keypad. When the display confirms your choice and the ENTER LED flashes, press ENTER.

3. The display now says:

**Erase Track #X
You Sure? Y/N**

...where X is the track you just specified. Press YES to erase the track and return to the Module Identifier; press NO to return to the Module Identifier without erasing the track.

SEQUENCER MODULE

EDIT 2 – PUNCH-IN

You can fix mistakes, or do spot overdubs, with the punch-in function.

1. First select the track (as described in SEQUENCER SETUP 1) on which you want to record the punch-in. Note that when you record a track, the Sequencer remembers the Current Preset assigned to that track; therefore, when punching the Current Preset must match the Preset on the track being punched.
2. With the EDIT sub-module active, key in 2. The display, being its usual helpful self, says:

Press Play: Rcrd
Punches In/Out

3. The RECORD LED will be flashing; start the Sequence by pressing PLAY. When you want to punch-in, press RECORD and the Sequencer will go into record mode. Note: You may punch-in before the clock source 'starts if you want to be able to overdub right at the beginning of a Sequence. You may also punch-in during the countdown if desired.

Also note that while recording, if you punch in prior to a note's release the note will start and not turn off.

4. Press RECORD again to punch-out, however, you must let the Sequence play through to the end for the changes to become part of the track. While the track is playing, if you need to do another punch-in press RECORD and press RECORD once more to punch-out.
5. If you're not happy with the punch and want to start over, press STOP to punch-out and immediately stop the Sequence. The punched part, as well as any old data during the punched part, will be erased as soon as you press STOP.

Note: The Sequence makes only one pass during punch-in mode, so if you need to punch something close to the beginning of the Sequence it helps to program a countdown (see SEQUENCER SETUP 6).

SEQUENCER MODULE

EDIT 3 – BOUNCE TRACKS

With this function, you may bounce tracks assigned to one Preset to any other track assigned with the same Preset (including one of the tracks being bounced -- i.e., bounce tracks 1, 2, and 3 into 1). To bounce a track that has a different Preset from the other tracks being bounced, reassign the track Preset so that it is the same as the other tracks being bounced (see SEQUENCER EDIT 5, "Reassigning Presets").

1. We will use an example to demonstrate bouncing. Suppose you have recorded tracks 1, 2, and 5 with Preset 01, tracks 3, 6, and 7 with Preset 02, and want to bounce tracks 1 and 2 down to a single track. With the EDIT sub-module active, key in 3. The display's upper line shows which tracks have been recorded, the lower line asks which tracks you want to put where:

```
Trk: 123 567
Put D___
```

2. Key in the number of the first track you want to bounce. The right-hand side of the upper line will indicate its Preset number, and display aU other tracks assigned to the same Preset. Using the above example, if you key in 1, the display will show:

```
Trk: 12 5 =P01
Put D___
```

3. Key in the tracks you want to bounce, in this case, 1 and 2. The display says:

```
Trk:12 5 =P01
Put 12 D___
```

...and the ENTER light will be flashing. If the Put line shows the tracks you want to bounce, press ENTER. If you try to enter a track that's assigned to a different Preset, the Emulator II will ignore the command.

4. Now enter the track to which you want to bounce. In this case, you could bounce to track 1, track 2, or to open track 4. Key in the track to which you want to bounce, and the ENTER light will flash. Press ENTER, and the Emulator II will bounce the tracks for you.
5. You can bounce tracks as often as you like, but remember -- the Emulator II will not play more than 8 notes at a time.

SEQUENCER MODULE

EDIT 4 - STORE CONTROLS

This function lets you store control source changes along with a track. You may store as many control source changes as desired with a track, however, the same control source cannot be assigned to more than one track. For example, if you store control source 1 (pitch bend) on one track you cannot store pitch bend information on any other track. Please note that storing control settings uses up a lot more memory than simply storing note information.

1. First select the Preset you want to record, and then use SETUP 1 ("Select Track") to select the track on which you want to record. The controller must be enabled in the Current Preset or nothing will happen.
2. Before recording, activate the EDIT sub-module and key in 4. The display says:

RecTrk#X
Real Time (1 – 7)

...where X is the track to be recorded. Enter the number(s) corresponding to the control source(s) you want to store, as listed in the Real Time Control module (1=Pitch, 2 = Filt Fc, 3=Level, and so on). After the display confirms your choice, press ENTER Note: If you select a control source which has already been assigned to a different track, the display will say "AssignedToTrk#X" where X is the track number to which the control source was previously assigned.

3. Press RECORD and then PLAY. As you record, the control source changes will be stored along with the track.

SEQUENCER MODULE

EDIT 5 – REASSIGN PRESET

You may re-assign a different Preset to a previously recorded track at any time with this command.

1. With the EDIT module active, key in 5. The display says:

Track Presets
Use Sliders A&D

2. **Slider A** catalogs the tracks you have recorded. The top line of the display shows the track number; the bottom line shows the Preset assigned to that track.

Slider D catalogs the available Bank Presets. When the display confirms your choice of track and Preset, hit ENTER and the Preset will be re-assigned.

EDIT 6 – APPEND SEQUENCE

This function appends the Bank Sequence of your choice on to the end of the Current Sequence. You may also append a Sequence to it self.

1. With the EDIT sub-module active, key in 6. The display says:

Append Seq#
(01 – 99)/Slider A

2. Either use the keypad to specify the Sequence number, or move Slider A to catalog (see GENERAL INSTRUCTIONS 7, “Cataloguing”) the available Bank Sequences. When the display shows the Sequence you want to append, press ENTER. The display now says:

Append Seq# XX
You Sure? Y/N

...where XX is the Sequence number you just specified. Press YES to append the Sequence then return to the Module Identifier, or press NO to return to the Module Identifier without appending the Sequence.

Note: Once a Sequence has been appended, it cannot be “unappended”. Therefore, before appending we recommend making a copy of the Current Sequence as a “back-up”.

Caution: When appending a Sequence, make sure that the controllers assigned to the two Sequences match up.

ADVANCED APPLICATIONS

ADVANCED APPLICATIONS

THE ART OF SAMPLING

TAKING THE BEST POSSIBLE SAMPLE

MANIPULATING THE SAMPLE

COMBING SAMPLES INTO PRESETS

CREATING MULTI-INSTRUMENT PRESETS

ADVANCED APPLICATIONS

THE ART OF SAMPLING

Recording good samples is not always easy; creating a really super set of Presets requires patience, practice, and skill. Sure, you can get musically useful results within a few days after working with the Emulator II, but as you learn your craft the quality of your samples will improve dramatically.

Sampling is a multi-stage process, so we will describe tips for each stage separately. These stages are:

1. Taking the best possible sample.
2. Manipulating the sample within the Emulator II for maximum musicality (looping, splicing, etc.).
3. Efficiently combining samples into Presets.

ADVANCED APPLICATIONS

PART 1: TAKING THE BEST POSSIBLE SAMPLE

What comes out of the Emulator can only be as good as what you put in: Strive for maximum fidelity when sampling. Here are some ways to increase sample quality.

GENERAL TIPS

Live sampling: Sample “live” whenever possible, rather than recording a sound on tape then sampling from the tape.

Beware of overloads: The Emulator II is a digital recording device. Unlike analog recording devices, distortion does not increase slowly past a certain level; rather, it increases rapidly above the overload point, and produces a “non-musical”, splattering type of distortion. Monitor your levels carefully.

Sampling direct vs. sampling via microphone: Whenever possible, sample electronic instruments directly into the Emulator II. Avoid using a recording console, direct box, or other device in between the instrument and Emulator II.

Maintain the instrument to be sampled: Tune your instrument and carefully check the intonation; change strings (if applicable); and check that the instrument doesn’t have any loose parts that rattle, squeak, or make other noises.

Sampling acoustic instruments: Choose the microphone and mic placement as carefully as you would for any recording project. Musicians sometimes note how hard it is to get a good “sound” in the studio, but that’s what sampling is all about...getting a good sound, and once you’ve got that sound, keeping it.

Play naturally: Sometimes it’s a lot harder to play one note than several hundred. Unless you’re trying for a special effect, play the sample as you would normally play the instrument. It’s often a good idea to play several notes, and use truncation to zero in on the best of the bunch.

Avoid ground loops: Ground loops occur when electricity can take two different paths to ground. If there is a resistance difference between the two paths, this can generate a signal (consisting mostly of digital “hash”) that can work its way into the recording chain. With all the instruments patched in place and connected to each other, turn off the Emulator II and insert a ground lift adapter between the Emulator II plug and the wall.

CAUTION: Removing the ground connection defeats the safety advantage of using a three-wire plug. Make sure the Emulator II chassis has some other path to ground (usually via the audio input and output cables). Having two paths to ground can cause ground loops, but having no paths to ground can cause a potential shock hazard if there’s an equipment malfunction in the studio.

Using signal processing while recording: Just as with regular recording, there are no absolutes about recording signals with or without signal processing. Some engineers feel that tracks should always be recorded flat to allow for the maximum number of options during mix down; others prefer to record with a bit of processing, especially if the processor might be needed on another track when mixing.

ADVANCED APPLICATIONS

Here are some thoughts about the use of various types of signal processors when recording samples.

External Preamp: If you need to pre-amplify the signal being sampled, set the Sample section GAIN SET to 00 dB and use an external, high-quality mic preamp to increase the signal level going into the Emulator II. The Emulator II preamp noise level, while acceptable, is sometimes not as quiet as an external mic preamp.

Limiting Dynamic Range: Limiting the signal being sampled can put a higher average signal level into the Emulator II, thus improving the already excellent signal-to-noise ratio. Also, the limit point can be set just under the Emulator II overload point, which makes level setting less critical.

Equalization: If using EQ gives a better instrument sound, then use it. You want the best possible sound going into the Emulator II, and if a little EQ is indicated, it's best to add it while recording rather than having to think about it during playback.

Flanging & chorusing: There will be no problem using time delay effects with unlooped sounds, but looped sounds are another story. The worst case is that the time-delay processing creates such a complex, non-repetitive signal that it becomes virtually impossible to find a good splice point for the loop. The best case occurs if the effect is used to give cyclical sweeps, since you can often loop one sweep of the LFO with good results. Remember too that the Emulator II can add chorusing effects all by itself; simply replicate a Preset, de-tune the Voices in the replicated Preset slightly, then overlap the original and replicated Presets on the keyboard.

Compression: Compression can be helpful when looping sounds since it evens out level changes, thus making it easier to find an equal-level splice point. If appropriate, use the Emulator II's VCA and ADSR to restore the original signal dynamics.

Audio "exciters": To brighten up a sampled signal, use a device such as an Aphex Aural Exciter or EXR Projector. Both of these devices add a high-end "sheen" without adding the stridency encountered with excessive high-frequency equalization.

Using noise reduction: A number of single-ended noise reduction units (such as the MicMix Dynafex or Rocktron Hush) are now available; these do not require that the noisy signal have been previously encoded, as is the case with Dolby and dbx. If your source signal is noisy, one of these devices can help to greatly clean up the overall sound quality as you sample.

SAMPLING FROM TAPES

Maintaining sample quality via VCR recording: One excellent way to sample involves using a VCR and digital audio adapter (such as the Sony PCM-F1) for recording different sounds. Compared to using conventional reel-to-reel tape recorders, this approach offers several advantages:

- Digital-quality fidelity. A VCR/audio adapter combination adds virtually no degradation to the signal being sampled. Signal-to-noise ratio, wow, flutter, and dynamic range exceed that of all but the very finest analog recorders. These tapes of source sounds can serve as "master" library disks.

ADVANCED APPLICATIONS

- Lower tape costs. VCR cartridge tape is very inexpensive; you can record hours and hours of samples for only a few dollars.
- Portability. Using a portable VCR and battery powered audio adapter makes for a very compact and portable package.

Although splicing is not easy with VCR-based audio systems, you can generally do the required signal splicing and manipulation within the Emulator II. A good alternative to the VCR/adaptor approach is to use a Sony Beta Hi-Fi recorder; the audio tracks are of excellent quality.

Maintaining sample quality with reel-to-reel recording: Follow common-sense recording practice, be extremely careful about mic placement, use noise reduction when recording samples on to tape, limit the signal going on to tape rather than limiting the signal coming off the tape into the Emulator II, and add aural enhancement if desired.

Using variable speed tape recording: Variable speed can help “time-compress” samples. For example, suppose you have 1 second of Bank memory left and want to sample a 2 second sound. Record the sound on tape, and play back the tape at twice-normal speed into the Emulator II. This gives you a 1 second sample. Assign the original pitch one octave above the sample’s pitch, the low note to the sample’s pitch, and the high note to one octave above the sample’s pitch. The octave-lower version of the sample will produce a 2 second sound at the desired pitch.

Variable speed can also help increase high frequency response. Record a sample on tape then set the recorder to half speed and record the sound into the Emulator II. Assign the original pitch to one octave below the sample’s pitch, the low note also one octave below the sample’s pitch, and the high note at the sample’s pitch. This high note will give the original sample sound with an extremely clean high end.

Creative use of multi-tracking: Try multi-tracking sounds on a conventional recorder, then sampling the combination sound into the Emulator II. Recording a half-speed piano note along with an electric bass and a little bit of analog synth in the background gives a pretty outrageous bass sound...

PART 2: MANIPULATING THE SAMPLE

Transposition beyond two octaves: If you have a single sample, it is limited to covering a maximum of two octaves. However, if you have a two-speed tape recorder one sample can cover at least four octaves.

Record the original sample at C3 (low note C2, high note C4). Now record that sample on to tape running at 15 IPS. Play back the tape at 7.5 IPS, and record that sample at C2 (low note C1, high note B2). Next, record the original sample on to tape running at 7.5 IPS. Play back the tape at 15 IPS, and record that sample at C4 (low note C3, high note C5).

You have now covered four octaves with the one original sample. Note that some of the Voices overlap; this is an excellent application for Positional Crossfade. If you want a full

ADVANCED APPLICATIONS

five octaves, record the “re-synthesized” sample from C5 on tape running at 7.5 IPS. Play back the tape at 15 IPS, and record that sample at C6 (low note C5, high note C6).

Minimizing timbre differences between adjacent samples: There are several ways to minimize timbre differences as you play across the keyboard.

- Record lots of samples (“multi-sampling”). This only becomes practical with relatively short samples.
- Overlap samples and use positional crossfade. This can help even out the sound to a great extent; refer to PRESET DEFINITION 27 (“Positional Crossfade”) for further information.
- Carefully adjust filter tracking. When recording the sample, add some extra brightness via equalization. When adjusting the Voice filter parameters on playback, set the filter tracking for about 0.50 and adjust the filter cutoff for the desired overall timbre. This helps keep an even timbre across the entire Voice. After assigning the Voices to a Preset, “tweak” the settings (if necessary) to insure consistent timbre from sample to sample.

TIPS ON MANIPULATING SYNTHESIZER SAMPLES

Looping synthesizer oscillators: When sampling synthesizer sounds, it is not always necessary to sample the entire sound. You may simply sample the synthesizer’s oscillators, and use the Emulator II’s VCF, VCA, and LFO to alter the raw waveform. To sample an oscillator, use as short a loop as possible (sometimes this can even be less than 100 samples long), and a starting point as close to the beginning of the sound as possible. Use AUTOLOOP often, since it can choose short sample splice points much more easily than a human can.

Non-standard tunings: There is a renewed interest in non-standard tunings, such as just intonation. It is possible to record a separate, short, just-intoned sample for each key; if you keep the samples short enough, it is possible to cover at least two or three octaves of notes. Or, record sounds in quarter-tone even-tempered intervals if that’s your thing, or...

“SIGNAL PROCESSING” WITH THE EMULATOR II

Chorusing: The Emulator can give chorusing effects for a specific Preset. First, replicate the Preset to be chorused. This creates a new set of Voices. Now, make these replicated Voices the Current Voice, and detune all of them about -07 cents. Finally, overlap the Voices from the original Preset with the Voices of the replicated Presets. The slight detuning will give a chorusing effect without any of the noise or other signal degradation sometimes associated with outboard signal processors.

Flanging: Follow the same procedure as above, but after making the replicated Voices the Current Voice, do not detune the replicated Voices but instead add some slow-speed vibrato with a fair amount of vibrato depth. The vibrato rate determines the rate of the “flange”, while the vibrato depth sets the depth of the flange.

ADVANCED APPLICATIONS

Pitch transposer with regeneration: To make a Voice sound as if it is being pitch-shifted downward and regenerated, hit three or four adjacent keys from the same sample at the exact same time (try this with a sampled sentence for an obvious example of how the effect works).

Time delay special effects: Set a Voice for non-transpose, then press several keys at almost the same time -- you will hear all sorts of flanging, chorusing, and other delay effects.

Echo: Loop a complete Voice so that it begins repeating as soon as it ends. Then, set the VCA decay so that the repeated Voices get softer as you hold down the key. The effect is very similar to echo, with the exception that different notes will have different echo rates. Or, set a Voice for non-transpose, and hit a new key every time you want~ to hear an echo.

ADVANCED APPLICATIONS

PART 3: EFFICIENTLY COMBINING SAMPLES INTO PRESETS

Part of creating a good Preset is to get into a “rhythm” where you’re punching up parameters as if the whole process was second nature. The following example shows the flow of a typical sampling session from start to finish.

I. The Situation

You have a portable, toy synthesizer that has about seven really great patches and no keyboard dynamics. You’d like to take it on the road, but it’s real fragile; so, you decide to sample the seven patches into the Emulator II, and add keyboard dynamics while you’re at it. We’ll suppose that these neat sounds are called “Electric Piano”, “Trumpet”, “Gong”, “Noise”, and “Synth 1 - 3”.

II. Getting ready

First, let’s do a little bit of planning. We’re trying to fit a fair amount of sounds into memory, so we’ll minimize the number of Voices per sound. Here are some suggested ways to divide up the keyboard for different numbers of Voices:

3 Voices			
Low	Orig	Hi	
C1	C2	A2	Lower Voice (Voice 1)
Bb2	F#3	D4	Middle Voice (Voice 2)
D#4	C5	C6	Higher Voice (Voice 3)

Because transposing changes the timbre of the sound, sometimes three Voices will not realistically cover the keyboard. Often you can stretch the lowest Voice to cover two octaves, and use three Voices for the upper three octaves.

4 Voices			
Low	Orig	Hi	
C1	C2	Bb2	Voice 1
B2	F#3	B3	Voice 2
C4	F#4	B4	Voice 3
C5	F#5	C6	Voice 4

For greater bass range fidelity, use octave by octave sampling.

5 Voices			
Low	Orig	Hi	
C1	F#1	B1	Voice 1
C2	F#2	B2	Voice 2
C3	F#3	B3	Voice 3
C4	F#4	B4	Voice 4
C5	F#5	C6	Voice 5

ADVANCED APPLICATIONS

For an example of how to use more than 5 Voices, load the piano disk, pick one of the Presets, and call up Preset Definition 23 (Edit Voice) to see how the Voices are assigned.

Hint: It is good practice to, if possible, sample an additional Voice or Voices an octave above and/or below the intended sampling range. Then, it will be possible to do octave layering, bass sounds, and other tricks later on if desired.

Now let's assign potential Preset numbers, and assume that we will want about 10 Presets per sound.

Electric Piano:	Presets 01 – 09
Trumpet:	Presets 10 - 19
Gong:	Presets 20 - 29
Noise:	Presets 30 - 39
Synth 1:	Presets 40 - 49
Synth 2:	Presets 50 - 59
Synth 3:	Presets 60 - 69

We will make the first Preset of each group as pure and unmodified a sound as possible. We will then replicate some of the Presets, thereby creating Presets with different Voice numbers. These can then be modified to produce variations on the first Preset. Note that if we take five samples per Voice, we will still have 65 Voices left after taking our original samples -- enough to replicate many five-Voice Presets.

III. Sampling the Voices

Hint: When sampling synthesized sounds, keep the synth filter wide open and use the Emulator II filter instead for filter control. Open up the synth's VCA's since dynamics can also be set with the Emulator II.

1. Start sampling by clearing the Bank. Upon clearing the Bank, the Emulator II creates a Preset for you (P01) and names it NULL PRESET. During sampling, if you assign Voices to the keyboard as they are being sampled (SAMPLE 2), they will fill up this Null Preset. If you don't want to bother with assigning Voices just yet, you could also just sample Voices, one right after another, into the default assignment (i.e. lowest two octaves). The newest sample will over-write the previous sample, but the previous sample will still be stored in memory. After all the sampling is done, the Voices can then be assigned to a Preset.

Assigning the Voices as you go along saves a step, but sampling Voices in quick succession often gives a better "rhythm". For now, we'll go with the latter method.

2. Activate the sample module. After adjusting the gain, thresholds, and so on, carefully consider your signal source. Suppose we're sampling the electric piano sound, and that this particular synth piano note has a complex percussive attack, which becomes a sustained tone. A good plan might be to sample the complex attack, then loop the sample as soon as the sustained tone begins. Looping the sustained part of the tone shortens the sample, saves memory, and gives infinite sustain if desired. Dynamics can be adjusted later with the Emulator II's VCA's.

ADVANCED APPLICATIONS

3. Now you get into the actual rhythm of sampling, which goes something like...
 - Arm sampling and play the first (lowest) note to be sampled. Shortly after the note reaches the sustained section, stop sampling. Play the keyboard to see if the Voice sounds okay. If the sample is good, de-activate sampling; Voice V01 now contains the first sample.
 - Similarly sample the next Voice. This becomes V02 and replaces V01 on the keyboard. After sampling, check that the Voice sounds okay then proceed.
 - Record a total of six Voices as described above. These will cover an octave more than the keyboard, but the extra Voice will come in handy if we decide to double octave related Voices for a thicker sound. The lowest Voice is 01, the highest 06.
4. Create a Preset to see what the Voices sound like together, and assign the Voices to that Preset.
5. Loop the newly recorded Voices (specifying one Voice at a time as the Current Voice) by setting the Loop Length to 000000 and adjusting Sliders A & B until the sound goes just a little bit past where the complex attack cuts off. Now adjust sliders C & D for a short sample length -- say, 100 samples. Sounds terrible when it loops, eh? Press YES for Autoloop and it should sound better. If not, set C & D for a somewhat longer length, and keep pressing YES to invoke Autoloop. When the sample is looping properly, change the Current Voice and loop the next Voice.
6. If all Voices to be looped are not assigned to a Preset, temporarily assign any additional Voices to a temporary Preset and loop them. After all the Voices have been looped, name them by copying them to themselves (PRESET DEFINITION 12), then save the raw, looped versions of each Voice to the Library disk so that these sounds will be readily available when making up future Presets.
7. Modification time...since we want a percussive Voice rather than a sustained one, we'll activate VCA/LFO and add decay to all Voices in the Preset. Or how about a Chorus sound? De-tune a replicated set of Voices (as described earlier in this section), overlay them with the existing Voices, and voila -- instant chorusing.

Part of the fun of the Emulator II is that you can really expand the boundaries of your creativity. For instance, there's no law that says you have to assign notes like a normal keyboard; you could sample major chords into one octave, minor chords into another octave, seventh chords into yet another octave, and so on.

ADVANCED APPLICATIONS

PART 4: CREATING MULTI-INSTRUMENT PRESETS

In many cases, you will want the Sequencer to sequence several instrument sounds simultaneously. There are three ways to do this:

- Create “MIDI Presets” (described in the MIDI/SMPTE supplement) that allow you to sequence MIDI instruments from the Sequencer;
- Create “Individual Instrument Presets”, each with an individual sound (i.e. bass, keyboard, percussion, horns, etc.), then program each Preset as one track of the Sequencer; or
- Create “Multi-instrument” Presets, which contain several, instrument sounds, assigned to different ranges of the keyboard, in one Preset.
- You can also combine any or all of the above approaches.

Note: Even if you don’t use the Sequencer the latter two techniques are important if you want to create Performance disks that include a collection of sounds from other Performance, or Library, disks. Generally, factory Performance disks group instruments by category - keyboard sounds, wind instruments, etc.; but you might want a Performance disk that contains one particular keyboard sound, one or two horn Voices, and other sounds from other disks. This section describes the procedure necessary to create multi-instrument Performance disks.

Using the Sequencer to sequence multiple sounds involves several memory tradeoffs, especially if you are working with Individual Instrument Presets or Multi-instrument Presets. Voices, Presets, and Sequences all use up Bank memory, with Voices generally having the most voracious appetite for space and Sequences coming in second. If you use up all your memory while storing Voices, you won’t have any space left over for creating Presets or Sequences.

Each of the three methods mentioned above has advantages and disadvantages. MIDI Presets are very useful, but of course you need to have some MIDI gear available. Individual Instrument Presets let you work out Sequences in a very straight-forward manner where each Preset, representing one particular instrument, takes up one track of the Sequencer. Multi-instrument Presets let you sequence multiple Emulator II sounds in a single track, thus freeing up other tracks for MIDI instruments. For example, suppose you want to sequence seven MIDI instruments and also sequence three different instrument sounds in the Emulator II. This would normally not be possible if each instrument sound had its own Preset, since you would need 10 tracks. However, by assigning the three instruments to a multi-instrument Preset, one Sequencer track can sequence all three instruments, thus leaving seven tracks free for MIDI Presets. Another advantage is that tracks that contain the same Preset can be bounced together; therefore, before assigning the MIDI Presets to the Sequencer tracks, you could work out a very complicated part on several tracks using the multi-instrumental Preset. These tracks could then be bounced to a single track, freeing up the remaining tracks for MIDI Presets.

ADVANCED APPLICATIONS

The first step towards creating either a bunch of Individual Instrument Presets or a Multi-instrument Preset is to store the desired Voices in the Bank. If you have a good collection of Library disks, clear the Bank then load the desired Voices from the various disks into the Bank. You can also just sample the Voices you need directly into the Bank. In many cases, however, you will want to use Voices from different Performance or Library disks. Suppose you want a bass Voice from one disk, an electric piano Voice from another disk, and the trumpet Voices from a third disk; here's how you would proceed.

1. Clear the Bank memory.
2. Load the Performance or Library disk containing the bass Voice. Select the desired bass Voice as the Current Voice, and save it to a Library disk.
3. Clear the Bank memory again. Load the Performance or Library disk containing the electric piano Voice, select this Voice as the Current Voice, and save it to the same Library disk to which you saved the bass Voice.
4. Clear the Bank memory again. Load the Performance or Library disk containing the trumpet Voices; assign one of the Voices you want to use as the Current Voice, then save it to the same Library disk to which you saved the bass and electric piano Voice. Similarly load any other Voices you want to use to the Library disk.
5. You now have a Library disk containing all the Voices you want to use. Clear the Bank, and then load each Voice into the Bank from the Library disk.
6. When creating Individual Instrument Presets, assign the desired Voices to the desired Presets. When creating Multi-instrument Presets, you might typically assign the bass Voice to the lower keyboard range, the electric piano to the middle, and the horns to the upper keyboard range.
7. Check how much memory is left in the Bank. Remember that for every 27,500 remaining samples you can sequence approximately 4,500 notes. If your goal is to program lots of Sequences using a relatively small number of Voices, then you will want to make sure you allow sufficient memory space for the Sequences. If on the other hand you want to program just a couple of Sequences but these require several Presets containing lots of different Voices, you will use up most of your memory in the process of storing Voices.

For example, at one point I wanted to create a disk of "practice sequences" over which I could practice guitar and keyboard solos. Therefore, I needed enough memory space for lots of Sequences, and just enough Voices to make up the "band". I made up one Preset with bass, synth, and horns assigned to different areas of the keyboard, and another Preset with synth bass, synthesizer and horns, again assigned to different parts of the keyboard. I would record each instrument on its own track, and then bounce these into one track to create a composite of the three different instruments. Another track was dedicated to being a MIDI Preset for driving a Drumulator via its MIDI input, and another track was dedicated to driving a small outboard MIDI keyboard for special effects. Occasionally, I would record variations on one track in a separate Sequencer

ADVANCED APPLICATIONS

track, and use the Sequencer's cue function to select the particular version to which I wanted to listen. Also, sometimes I would record a lead synth or horn part in another track for practicing "dual lead" parts; again, recording different solos in different tracks, and selecting the tracks to be auditioned with the cue function, saves you from having to listen to the same solo over and over again.

The Emulator II Sequencer is amazingly versatile; so make sure you experiment with it in order to uncover its many talents.

We at E-mu are always interested in any tips, ideas, or suggestions you might have about the Sequencer or any other aspect of the Emulator II. We invite your comments, and hope that you have as much fun playing the Emulator II as we did developing it.

MIDI SUPPLEMENT

BASICS

TYPICAL MIDI APPLICATIONS

CREATING A MIDI PRESET

ABOUT MIDI CONTROLLERS

ABOUT OTHER MIDI SYNTHESIZERS

DEALING WITH MIDI

MIDI SUPPLEMENT

BASICS: QUESTIONS AND ANSWERS ABOUT MIDI

MIDI is causing a certain amount of confusion among musicians. Fear not -- it's not all that difficult to understand, and the Emulator II makes it particularly easy to deal with MIDI.

For those of you who aren't that familiar with MIDI, we'll first answer some common questions.

What does the MIDI cable do?

An instrument already has an AC cord that carries electrical current, and an audio cord that carries audio signals to an amplifier. Now you have a third connection: the MIDI cable. This carries neither audio nor power, but transmits information about the status of the instrument to, and receives "status reports" from, other MIDI instruments. This information is coded in a computer language...a somewhat primitive language with few words and several dialects, but a language nonetheless.

What does MIDI stand for?

MIDI stands for Musical Instrument Digital Interface. You already know what "musical instrument" means, so that takes care of the first half of this phrase. Digital means that the instrument's information is conveyed in digital, or computer, language. Interface is the term for the actual link between instruments, where data passes from one instrument to another. So MIDI is a link between musical instruments that speaks data in computer language.

How can information control a synthesizer?

First we need to know a bit about computers, since MIDI instruments have microcomputer souls...in fact, MIDI could not exist without microcomputers.

Computers are decision makers, and they base those decisions on the data they receive. However, to be useable by a computer any data has to first be translated into a number-based language that the computer can understand. Actually, when you press a keyboard key with a computer-based instrument, you are not directly controlling the sound source. Instead, each time you close a keyboard switch you're sending a number to the computer, and this number tells the computer what note you want it to play for you.

The computer's "window on the world", where it receives and transmits numerical data, is called its data bus. The computer looks to see whether any information is on the data bus, and if so, acts on this data. For example, if it sees a digital "word" that says "play F#" on the data bus, it will do as the data commands and control a sound source so that it plays an F~. However, note that the computer doesn't care whether this word is placed on the data bus due to closing a keyboard switch or striking a guitar string -- once MIDI translates a note into computer language, the note becomes compatible with any device that speaks the same language. MIDI provides access to the computer's data bus and selects which device will be "on the bus" at any particular moment, thus letting you determine the flow of information from one MIDI device to another. This is why having a specification which manufacturers can follow is so important; it insures that a variety of otherwise incompatible devices will be able to communicate with each other over a common data bus.

MIDI SUPPLEMENT

How does MIDI differentiate between different MIDI instruments?

MIDI provides 16 independent channels of information suitable for driving up to 16 polyphonic synthesizers or other MIDI devices.

There are three modes that determine how each MIDI instrument responds to these channels.

In Omni mode, the Emulator II (or any other MIDI keyboard) listens to all channels at once. No matter how many notes from how many sources make it through the MIDI bus into the instrument, when in Omni mode it will attempt to play all of them.

In Poly mode, the instrument can “tune in” to one MIDI channel --just like you can tune in one channel of your television. Having a bunch of instruments set to Poly mode lets you send specific information to different instruments from the Emulator II’s Sequencer over different MIDI channels.

Mono mode is considered a “multi-timbral” mode. In mono mode, each individual analog synthesizer voice can be driven by one specific MIDI channel of information to play a certain melodic line. Each voice can also have its own “patch” (program), so an analog synthesizer capable of MIDI Mono mode can therefore produce multiple timbres simultaneously. Since the Emulator II does not have an equivalent to the analog synthesizer voice, the Emulator II does technically not support Mono mode. However, each Preset can be assigned to receive information through a separate MIDI channel, which provides Mono-like operation but unlike traditional MIDI Mono operation, each Preset can respond polyphonically. Of course, you still cannot play more than eight notes on the Emulator II regardless of what MIDI mode you select.

16 channels, huh? Sounds like a lot of patch cords to me!

MIDI information is transmitted serially, meaning that all data is sent in sequence. As a result, a single line can carry the MIDI information for all 16 channels, with each instrument monitoring all the words that pass over the MIDI interface but responding only to the data on its particular channel. Typically, MIDI instruments include a MIDI IN, MIDI OUT, and MIDI THRU jack. The instrument receives data over the MIDI IN jack and transmits data over the MIDI OUT jack; the MIDI THRU jack provides a replica of the signal at the MIDI IN jack. Therefore, if you want to slave three keyboards to a master keyboard, you would patch the MIDI OUT from the master keyboard to the MIDI IN of the first slave, patch MIDI THRU from the first slave to the MIDI IN of the second slave, and connect MIDI THRU from the second slave to MIDI IN of the third slave.

What kind of words does the MIDI language include?

Spoken language is a collection of words that convey a particular set of meanings, hopefully understood by all those who speak the language. As soon as we start talking about a musical language, the first question is: What concepts do we want this language to define? Since musical instruments will be doing the talking, the language should consist of musical terms -- pitch, tempo, and so

on. In fact, let’s set up a practical example and see what words our language would need.

Suppose we have two synthesizers, Synth A and Synth B, and want Synth B to precisely follow along with what is being played on Synth A to create a “doubling” effect. To do this, our “language” would have to convey several things.

MIDI SUPPLEMENT

First, Synth A would have to tell Synth B whenever a key was hit (“hey Synth B, play F#!”). We’ll call this the NOTE ON word.

This turns on the keys just fine, but now we need a way for Synth A to tell Synth B when a note is over so it can turn the key back off again. We can call this the NOTE OFF word.

Now we have the notes under control, but what happens if we do some pitch bending on Synth A? As it is, Synth B wouldn’t follow because it can only tell if a note has been turned on or off -- not if its pitch has been changed. So, we need a new word that indicates a pitch bend CONTROL CHANCE.

Everything’s fine until we switch patches, at which point Synth A changes but Synth B doesn’t. We clearly need another word to signal PROGRAM CHANGE so that if you call up a different patch on Synth A, Synth B will call up a different patch as well (which you have hopefully programmed to sound compatible with Synth A).

And the list of words goes on...what happens if both synthesizers can respond to dynamics? You’ll also want to transmit that data from one synth to another. We also need some information about the system tempo, as set by a drum machine or sequencer...

MIDI’s vocabulary encompasses all these considerations, as well as many others. For a more detailed description of the complete MIDI vocabulary, refer to two articles in the August 1983 issue of Polyphony, “What MIDI Means to Musicians” by Jim Wright and “MIDI Hardware Fundamentals” by Stanley Junglieb.

TYPICAL MIDI APPLICATIONS

1. Slave two keyboards together so that one doubles the other for lush-sounding string effects, choirs, and so on. To do this with the Emulator II and another MIDI instrument, connect the MIDI IN from each machine to the MIDI OUT of the other instrument. Select Omni mode and the same basic channel for both instruments -- either keyboard should be able to control the other instrument. If you program the other instrument to receive “program change information”, changing Presets on the Emulator II should change programs on the other MIDI synthesizer, and vice- versa.
2. Slave two keyboards together to create a composite sound. For example, you might like the sound of the Emulator II violins fading in as the attack of a digital synth violin patch fades out.
3. When composing, you can sequence parts via MIDI and experiment with changing timbres. How would that harmony line sound as a piano instead of a guitar? Re-assign Presets on an Emulator II Sequence and find out.
4. The dynamic control of drum machines. If you have a Drumulator with MIDI retrofit, you can program it dynamically from the Emulator II keyboard via MIDI. Run a MIDI cable from the Emulator II’s MIDI out to the Drumulators MIDI connector, then consult your Drumulator addendum sheet for information on which Emulator II keys control which drums.

MIDI SUPPLEMENT

CREATING A “MIDI PRESET” WITH THE EMULATOR II

The Emulator II Sequencer is designed to drive MIDI instruments via the MIDI OUT connector. In many cases, you will want to create a Preset that doesn't play any notes on the Emulator II, but only sends note data from the Sequencer out to other MIDI equipment.

To do this, make up a “MIDI Preset” by creating a Preset (PRESET DEFINITION 21) then going through the MIDI set-up (PRESET DEFINITION 30). Do not assign any Voices to the Preset, and make sure that the Local Control set-up option is set to “yes” (or you will not be able to write notes into the Sequencer using the Emulator II keyboard).

Hint: If you create a number of MIDI Presets to drive different instruments over different channels, we suggest including the channel number in the Preset name.

MIDI controllers cause a lot of confusion all by themselves, so hooking them up to other instruments doesn't make things any easier. Fortunately, though, the Emulator II is quite 'helpful in setting up the MIDI controllers functions.

A MIDI controller could be pitch bend, velocity, modulation, portamento, overall level, or whatever. Each controller sends out data about its status (i.e. the position of a pot or switch) over a particular controller “channel”, which has its own unique number. This channel is not to be confused with the basic channel assigned to the instrument; the controller channel data is transmitted as part of the basic channel information.

With MIDI, the only defined controllers are pitch bend and channel pressure (dynamics); it is up to the manufacturers to decide which controllers will be accessible via MIDI, and what each controller's number will be.

While this lack of standardization often causes problems with MIDI set-ups, the Emulator II takes care of those problems by letting you transmit the left wheel, right wheel, and pedal data over a MIDI controller number from 00 to 31, or as the pitch wheel (pwh) or channel pressure (chp) controller. These can be set up individually for each Preset. Note: The Emulator II does not transmit or receive on MIDI controller channels 32-63; however, sustain pedal information is transmitted over controller 64, the de facto industry standard number for sustain pedal data.

For example, suppose you're driving Synth A, which expects to find vibrato data coming in over the channel labelled “controller 01”. Let's also suppose that the Emulator II's right wheel has vibrato as its destination in a particular Preset. By assigning the right wheel to controller 01 during the MIDI set-up (PRESET DEFINITION 30), turning up the Emulator II's right wheel will add vibrato to Synth A.

If Synth B expects to find vibrato data labelled as “controller 07”, no problem. During MIDI set-up, program the Emulator II's right wheel to controller 07. When Synth B looks for vibrato information at controller 07, the Emulator II will be supplying it.

So much for transmitting data from the Emulator II. When it comes to receiving data from other MIDI 'instruments, up to three of the Emulator II's Real Time Control destinations (Pitch, Filter Fc, Level, LFO to Pitch, LFO to Filt Fc, LFO to Level, and Attack Rate) can be controlled simultaneously via another MIDI instrument's controllers. Here's how the process works.

MIDI SUPPLEMENT

1. The other MIDI synthesizer will typically include several controllers, each transmitting data over its own controller “channel”. For example, Synth X might send out vibrato data over controller 01 and overall level data over controller 07. Hopefully this kind of information will be given in the manual.
2. Activate the Emulator II’s Real Time Control module. Decide the first Real Time Control destination you want to control via MIDI, and assign it to MIDI Channel A by keying in 4 then specifying the destination to be controlled. To place a second Real Time Control destination under MIDI, assign it to MIDI Channel B by keying in 5 then specifying the destination. Similarly assign a third Real Time Control destination to MIDI Channel C.

For example, to have the Emulator II respond to MIDI Synth X mentioned above, we might assign the Real Time vibrato destination (4) to MIDI Control Channel A, and the Real Time level destination (3) to MIDI Control Channel B. Now all we need to do is assign controller numbers to MIDI Control Channels A and B, so de-activate the Real Time Control module and activate the Preset Definition module.

3. During MIDI set up (PRESET DEFINITION 30), you may assign a MIDI controller number from 00 to 31 to MIDI Control Channels A, B, and C; these can also be controlled via the pitch wheel (pwh) or channel pressure (chp) data coming from the other synth. Again using Synth X as an example, we would assign controller 01 to MIDI Control Channel A and controller 07 to MIDI Control Channel B. As Synth X sends out vibrato information over controller 01, this will be received by the Emulator II and assigned to MIDI Control Channel A, which was assigned to control the “LFO to Pitch” Real Time Control destination. Meanwhile, as Synth X sends out level information over controller 07, this will be received by the Emulator II and assigned to MIDI Control Channel B, which was assigned to control the “Level” Real Time Control destination.

Of course, you don’t have to assign matching controller numbers if you don’t want to; bending pitch on Synth X, for example, could instead add vibrato or change the Filter Fc on the Emulator II. It is all a matter of assigning the Emulator II parameter you want controlled to a MIDI Control Channel, then assigning the MIDI Control Channel to the appropriate controller number for the other synthesizer.

FINDING OUT ABOUT OTHER SYNTHESIZER’S MIDI CAPABILITIES

It’s easy to find out the controller numbers for parameters on another synthesizer by patching the Emulator II MIDI OUT connector to the other synth’s MIDI IN. During MIDI Set-up select the “Rt Wheel” set-up step, use Slider D to select a controller number, vary the right wheel, and note any changes. Select another controller number, vary the right wheel, and see what that affects. Most synthesizers will only have a few controllers assigned; note which control numbers affect which parameters, and write them down for future reference.

For a practical example of how to use this feature, suppose you want to use the Emulator II footpedal to simultaneously fade out the Emulator II and a MIDI’ed synthesizer. During MIDI set-up, select the “Pedal” set-up step, and use Slider D to change controller numbers until you find the number that corresponds to overall level. Suppose the controller number is 05. If you assign the Emulator II “Level” Real Time destination to the footpedal and also send the footpedal information out over the MIDI controller 05, both instruments should fade in and out together.

MIDI SUPPLEMENT

DEALING WITH “MIDIOSYNCRACIES”

There are certain compatibility problems between MIDI gear from different manufacturers; however, many problems are created by operator error and/or a lack of understanding how MIDI works. If you transmit information on one channel and have the “receiver” set up for a different channel, forget it. MIDI is quite unforgiving that way...you can hit a bum note and not too many people will notice, but send a computer a wrong number and it will most definitely notice.

MIDI is a lot of fun provided that you don't get discouraged when things go wrong. Many times there is a solution; sometimes there isn't. In any event, MIDI as it is today is far better than no MIDI at all. At the very least you can almost always slave two keyboards together, and drive MIDI keyboards from a MIDI Sequencer. Truthfully, though, MIDI is still a new concept and people are just getting it all sorted out. If you don't understand it at first, don't worry -- keep experimenting and eventually everything will fall into place.

SMPTE SUPPLEMENT

SMPTE SUPPLEMENT

OVERVIEW

PROTOCOL

SMPTE SUPPLEMENT

SMPTE OVERVIEW

The Society of Motion Picture and Television Engineers adopted SMPTE time code in order to synchronize audio to video. Basically, SMPTE is a digital code that is recorded on audiotape or videotape, or “burned into” film. This code outputs time information as hours, minutes, seconds, and “frames” (1/30th of a second intervals). For synchronization, sophisticated machines “look” at the SMPTE time code tracks on the audio and video machines to be synchronized, and correct the speed of one unit vis-à-vis the other to maintain synchronization. These error corrections are very subtle and are not noticeable.

The Emulator II uses SMPTE in conjunction with the Sequencer so that it may be started at a specific frame of time code. Therefore, sound effects can be recorded into the Emulator II's Sequencer, and “dropped in” to a video or film production within one frame of time code.

SMPTE PROTOCOL

The Sequencer section mentions SMPTE basics; here is a more detailed overview.

Writing to tape: Recording SMPTE on tape is called “striping” the tape. First, choose the SMPTE start point (which should be prior to the start of the Sequence) as described in SEQUENCER SETUP 5, then select the frame rate in the EXT CLK sub-module.

Set the tape recorder in record ready mode, then prepare to write SMPTE by selecting the “Write SMPTE Trk?” option while in the EXT CLK sub-module. Press YES to generate SMPTE, and then check levels on the recorder. Press ENTER to stop writing SMPTE. Start the tape rolling in record mode, and press YES again. After striping the desired length of tape, press ENTER. Hint: Always record more SMPTE time code than you think you'll need. You can always erase the excess, but it's difficult to extend a SMPTE track if you decide to lengthen a piece.

Reading from tape: Select “Clock Src=SMPTE” in the EXT CLK sub-module, and select the frame rate of the SMPTE track recorded on tape. If you are working with a Sequence for the first time, choose the SMPTE start point as described in SEQUENCER SETUP 5 (this start point will be remembered when you come back to the Sequence in the future). When ready, make sure the recorder is in playback mode, then roll tape.

Tape Chasing: If the SMPTE time being read from tape is earlier than the Sequence's start point; the PLAY light will blink until the tape catches up. Playback will then begin at the current tempo. To change the tempo, use Slider A.

If the SMPTE time being read from tape is later than the Sequence's start point, the Emulator II will silently “fast-forward” through the Sequence to catch up with the tape. The point at which the Sequence playback begins depends on the start point and tempo.

If the SMPTE time being read from tape is much later than the Sequence's start point, the Emulator II may need to silently “fast-forward” through the Sequence several times before it catches up with the tape.

SMPTTE SUPPLEMENT

Although fast-forwarding is not instantaneous, if it seems inordinately long you probably have the start point or the tape in the wrong place. Press STOP to stop the fast-forwarding process, and then check the SMPTE start time.

Playing back and recording using SMPTE: During Sequence playback, you may stop, fast forward, rewind, and restart the tape and the Sequence will start playing again, chasing if necessary. Recording and punch-in work similarly; if you are in record mode on the Emulator II and start the tape in the middle of the Sequence, recording will begin at that point. However, when "chasing" the Sequencer will not fast forward beyond one loop of the Sequence.

Finding and keeping sync: Synchronization is more easily achieved if the tape is rolling before you press PLAY. This doesn't matter in the case of playback, but the first loss of synchronization will stop the recording process. If there is a dropout on tape of less than two frames, the Emulator II will maintain sync although it will fall behind in time by one frame for each frame dropped. Longer dropouts end the recording or playback process; if the display says "Lost Synch", press STOP to reset the system before trying to regain sync.

APPENDICES

APPENDICES

A: GLOSSARY

B: FUNCTIONS

C: ERROR MESSAGES

EMULATOR II CREDITS

APPENDICES

APPENDIX A: GLOSSARY OF TERMS

ADSR: Acronym for Attack/Decay/Sustain/Release, a particular type of envelope generator.

Analog synthesizer: A type of musical instrument that synthesizes sounds from component parts rather than via sampling.

Arpeggiator: A circuit that plays notes sequentially for as long as they are held down.

Bounce: When recording or sequencing, to “bounce” tracks means to combine several tracks together on a single track.

Cent: Unit of pitch equal to 1/100th of a semitone.

Channel, Output: The circuitry through which the Emulator II outputs individual notes.

Channel, MIDI: An “information pipeline” through which MIDI information is sent. MIDI provides for 16 available channels, each of which can address one MIDI instrument.

Channel, MIDI Control: A MIDI Channel also contains information about which controllers are being varied. Assigning an Emulator II real time control destination to MIDI Control Channel A, B, or C lets another MIDI device’s controllers control the Emulator II real time control destinations via the Control Channels.

Cutoff Frequency: The frequency above which a low pass filter will start attenuating signals present at its input. Abbreviated Fc.

Data: Information a computer needs in order to make decisions or carry out a particular action.

dB/octave: The unit typically used to indicate the slope of a filter, or how fast the frequency response rolls off past the cutoff frequency. Example: A 24 dB/octave filter would attenuate an input signal by 24 dB one octave above the cutoff frequency, by 48 dB two octaves above the cutoff frequency, and so on.

Envelope Generator: A circuit, usually triggered by pressing a keyboard key that generates a changing voltage with respect to time. This voltage typically controls a VCF or VCA. An ADSR envelope has four adjustable parameters: attack (the time required to go from minimum to maximum voltage), decay (the time required to go from maximum voltage to a specified sustain level voltage); sustain (the level at which the voltage holds during a keyboard key depression), and release (once a key has been released, the time required to go from the sustain voltage to minimum voltage).

Fc: See Cutoff Frequency.

Filter: A circuit that restricts frequency response, thus altering a signal’s harmonic structure.

LFO: Low Frequency Oscillator. A circuit that is usually used to vary sound parameters at a specific, low frequency rate. Example: Varying pitch cyclically creates vibrato.

APPENDICES

Loading: To transfer data from one data storage medium to another (i.e. from disk to semiconductor memory or vice-versa).

Low pass filter: A filter whose frequency response remains flat up to a certain frequency, then rolls off (i.e. attenuates signals appearing at its input) above this point.

Memory: The part of a computer responsible for storing data.

MIDI: Acronym for Musical Instrument Digital Interface, a means of transmitting data to, and receiving data from, a variety of musical instruments.

Modulation: The process of one control voltage source influencing a sound processor or other control voltage source. Example: Modulating pitch cyclically produces vibrato. Modulating a filter cyclically produces wa-wa effects.

Punch-in: When recording, punching in over-writes a previously recorded track starting at the punch in point.

Punch-out: When recording, punching out stops the recording process initiated by a punch-in, thus preserving the previously recorded track starting at the punch out point.

Q: The figure expressing a filter's resonance; varying Q varies the "sharpness" of the filter sound.

Sampling: The process of recording a sound into memory.

Signal Processing: The art of modifying an existing sound through the use of electronic circuitry.

SMPTE: Acronym for Society of Motion Picture and Television Engineers who adopted a standard time code in order to synchronize video and audio.

Tremolo: A cyclic change in amplitude, usually in the range of 7 to 14 Hz.

VCA: Voltage Controlled Amplifier. A circuit whose gain is determined by a control voltage.

VCF: Voltage Controlled Filter. A filter whose cut-off frequency or resonant frequency is determined by a control voltage.

Velocity-sensitive keyboard: A keyboard that sends out a control signal representing the speed with which keys are pressed; this corresponds to the dynamics with which the player plays the keyboard.

Vibrato: A cyclic change in pitch, usually in the range of 7 to 14 Hz.

APPENDICES

APPENDIX B: EMULATOR II FUNCTIONS, DEFAULT SETTINGS, and CONTROL RANGES

When you first turn on the machine or clear the Bank, the Emulator II functions will assume the following default settings shown under the Default column. Controls cover the range given in the Range column.

An asterisk indicates that the concept of a default or range of values is not pertinent; for example, there is no default setting for Erase a Preset, since you must first specify the Preset to be erased. Also note that for some functions (i.e. truncate, splice, etc.) a Voice must be present in the Bank.

Master Control	Default	Range
Dynamic Allocation	OFF	off-on
Tune+00 Cents	-50 to +48 Cents	
Transpose	OFF	Plus-or-minus 1 octave
Sequencer		
External Clock		
Clock Source	Internal	Int, Click, MIDI, SMPTE
Click Rate	24 pqn	24, 48, 96 pqn
Write Click Track	24 pqn	24 pqn
SMPTE Rate	30 fps	24, 25, 30 fps
Write SMPTE Track	30 fps	24, 25, 30 fps
Setup		
1 Select Track	1st empty trk	1 to 8
2 Tempo 120 BPM	40 to 240 BPM	
3 Auto Corr	Hi-Res	9 different options
3 Metronome	1/4 note	7 different options
4 Cue	Recorded tracks "on"	1 to 8
5 SMPTE start	00:00:00:00	00:00:00:00 to 23:59:59:29
6 Countdown	0 beats	0 to 9 beats
Define		
Create Sequence	*	*
2 Time Signature	04/04	Multiple options
3 Sequence Length	002	00 1-999 measures
Edit		
Erase Track	*	*
2 Punch In	*	*
3 Bounce Tracks	*	*
4 Store Controls	No controls stored	
5 Reassign Preset	*	*
6 Append Sequence	*	*
Record	OFF	off-on
Play	OFF	off-on
Select	*	*
Stop	OFF	off-on

APPENDICES

Filter	Default	Range
1A Frequency	120	000 to 120
1B Q00	00 to 99	
1C Envelope Amount	+00	-50 to +50
2A LFO Amount	00	00 to 15
2B Keyboard Tracking	1.00	.00 to 1.87
3A Attack	01	01 to 32
3B Decay	32	01 to 32
3C Sustain	01	01 to 32
3D Release	32	01 to 32
0 Change Curr Voice	*	*

VCA/LFO	Default	Range
1A Attack	01	01 to 32
1B Decay	32	01 to 32
1C Sustain	01	01 to 32
1D Release	16	01 to 32
2A LFO Rate	82	01 to 99
2B LFO Delay	00	00 to 99
2C LFO Variation	00	00 to IS
2D LFO → VCA	00	00 to IS
0 Change Curr. Voice	*	*

Voice Definition	Default	Range
11A, B Truncate Start	000000	Dependent on sample
11C, D Truncate End	000000	Dependent on sample
12A, B Loop Start	000004	Dependent on sample
12C, D Loop Length	Sample length	Dependent on sample
13 Loop	NO	yes-no
14A, B Splice Point 1	End of 1st	Dependent on sample
14C, D Splice Point 2	000000	Dependent on sample
21A Vel VCA Level	00	00 to 15
21B Vel → VCA Attack	00	00 to 15
22A Vel → VCF Freq	00	00 to 15
22B Vel → VCF Attack	00	00 to 15
22C Vel → VCFQ	+00	-15 to +15
23A Vibrato Depth	00	00 to 15
24A Voice Attenuation	-00 dB	-00 to -48 dB
24B Voice Tuning	+00 Cents	-50 to +48 Cents
25 Solo Mode	NO	yes-no
26 Loop in Release	YES	yes-no
27 Backwards Mode	NO	yes-no
28 Combine Voices	*	*
29 Control Enable		
Pitch	YES	yes-no
LFO to Pitch	YES	yes-no
LFO to Filter	YES	yes-no
LFO to VCA	YES	yes-no
Filter	YES	yes-no

APPENDICES

Level	YES	yes-no
Attack	YES	yes-no
30 Save Voice to Disk	*	*
00 Change Current Voice	*	*
Preset Definition	Default	Range
11 Get Voice	*	*
12 Copy/Name Voice	*	*
13 Erase Voice	*	*
14 Erase Sequence	*	*
15 Erase Preset	*	*
16 Erase Bank	*	*
17 Catalog Voices	*	*
18 Catalog Sequences	*	*
19 Catalog Presets	*	*
20 Memory Remaining	484599	000000 to 484599
21 Create Preset	*	*
22 Assign Voice	*	*
23 Edit Assignment	*	*
24 De-Assign Voice	*	*
25 Velocity Switch	None assigned	
26 Velocity Crossfade	None assigned	
27 Positional Xfade	None assigned	
28 Non-Transpose	NO	yes-no
29 Arpeggiator		
Mode	OFF	5 different options
Extension	NORM	3 different options
Range	C1 to C1	C1 to C6
Note Value	1/16th note	8 different options
Tempo	120 BPM	40 to 240 BPM
30 MIDI		
Basic Channel	01	01 to 16
MIDI Mode	Omni	off, omni, poly
Preset Change Okay		
YES	yes-no	
Local Control	YES	yes-no
Transmit Reset	*	*
Left Wheel	OFF	off, 00 - 31, chp, pwh
Right Wheel	OFF	off, 00 - 31, chp, pwh
Pedal	OFF	off, 00 - 31, chp, pwh
MIDI A	OFF	off, 00 - 31, chp, pwh
MIDI B	OFF	off, 00 - 31, chp, pwh
MIDI C	OFF	off, 00 - 31, chp, pwh
31 Copy/Name Preset	*	*
32 Replicate Preset	*	*
Sample	Default	Range
1 VU Mode	*	*
2 Define Voice	Orig C2, Lo C1, Hi C3	Any two octave range
3 Gain Set	+00 dB	
4 Threshold Set	Minimum	+00, +20, +40 dB

APPENDICES

5 Sample Length	Available Bank Memory	Up to overload point
7 Arm Sampling	*	*
9 Force Sampling	*	*
0 Stop Sampling	*	*

Disk	Default	Range
1 Get Bank Disk 1	*	*
2 Get Bank Disk 2	*	*
3 Space Remaining	*	*
4 Copy Disk	*	*
5 Catalog Voice	*	*
6 Erase Voice	*	*
7 Save Bank	*	*
8 Format Disk	*	*

Special		
11 Catalog Special Functions		*

Real Time Control	Default	Range
1 Left Wheel	1	0 to 7
2 Right Wheel	4	0 to 7
3 Pedal A/D	0	0 to 7
4 MIDI Control A	0	0 to 7
5 MIDI Control B	0	0 to 7
6 MIDI Control C	0	0 to 7
7 Foot Switch 1	2	0 to 5
8 Foot Switch 2	3	0 to 5

Enter	Default	Range
	OFF	Off, on, flashing

APPENDICES

APPENDIX C: EMULATOR II ERROR MESSAGES

If you ask the Emulator II to do something it doesn't want to do, it will give an error message in the display. If you encounter one of the following, it will be for the reason given.

All Tracks Empty: This occurs if you refer to a Sequencer track but none has been recorded.

Assigned to Trk#: Occurs with the Sequencer if you try to store a control destination that has already been assigned to a track (track # indicated in message).

Awaiting SMPTE: SMPTE time code has not yet been received by the Emulator II, or cannot be read.

Exists Again: With Get Voice (PRESET DEFINITION II), you cannot over-write an existing Voice.

Illegal Assgnment: When assigning Voices to a Preset, this message indicates the high key is below the low key, or the low key is above the high key.

Insert Library Disk and Press Enter: You have asked for a Library disk function but have not inserted a Library disk or have some other drive problem.

Insert Performance Disk and Press Enter: You have asked for a Performance disk function but have not inserted a Performance disk or have some other drive problem.

Key Must Have 2 Voices Assigned: Occurs with Velocity Crossfade, Velocity Switch, and Positional Crossfade if the key does not have two Voices assigned.

Need More Room: You have run out of sampling space.

No Current Voice: Occurs when entering the Voice Definition, Filter~ or VCA/LFO modules; assign a Current Voice to the keyboard.

No Voices Available: All 99 Voices have been used up or you are looking for Voices where none exist.

No Voice in Preset: If no voice has been assigned to the Preset, this message occurs when you enter module requiring a Current Voice.

Not Enough Voices: Occurs if you try to replicate a Preset, but there are more Voices in the Preset than there are available in the Bank.

Not Found: You have specified a non-existent Preset.

Presets Different: When punching with the Sequencer, the Current Preset must be the same as the Preset assigned to the Current record track.

Preset Not Saved: Usually occurs when trying to save a Preset with insufficient Bank memory.

APPENDICES

Sample Overload: The sample exceeded the Emulator II's dynamic range.

Seq Is Not Empty: If you try to set the time signature or measure length of a previously recorded Sequence, this will be the reply.

Snd For (Greater Than) 1 Voice: A sample cannot be spliced to another sample used in the same Voice. Select two different Voices for splicing.

This Will Take a While: Don't worry, you didn't break the machine; it's just taking its time to do an operation.

VXX Is Not Empty: This happens if you try to define a Voice that already exists.

APPENDICES

Emulator II Credits

Hardware Design

Dave Rossum
Tom Moxon
Dana Massie

Mechanical Design

Ken Provost

Technical Support

Terry Shultz
Wes Swift
Steve Davies
Brian Monahan
Jim Charleton

Software Design

Dave Rossum
Donna Murray
Tom Moxon
Alan Goldwater
Dana Massie

Sound Processing

Dana Massie
Kevin Monahan
Janis Chaffin

Manual

Craig Anderton

Functional Design

Marco Alpert
Dave Rossum
Scott Wedge
Tom Moxon
Kevin Monahan
Kevin Kent
Donna Murray

Project Management

Joe Scarantino
Jim Rose