

ATPM

8.06 / June 2002
Volume 8, Number 6

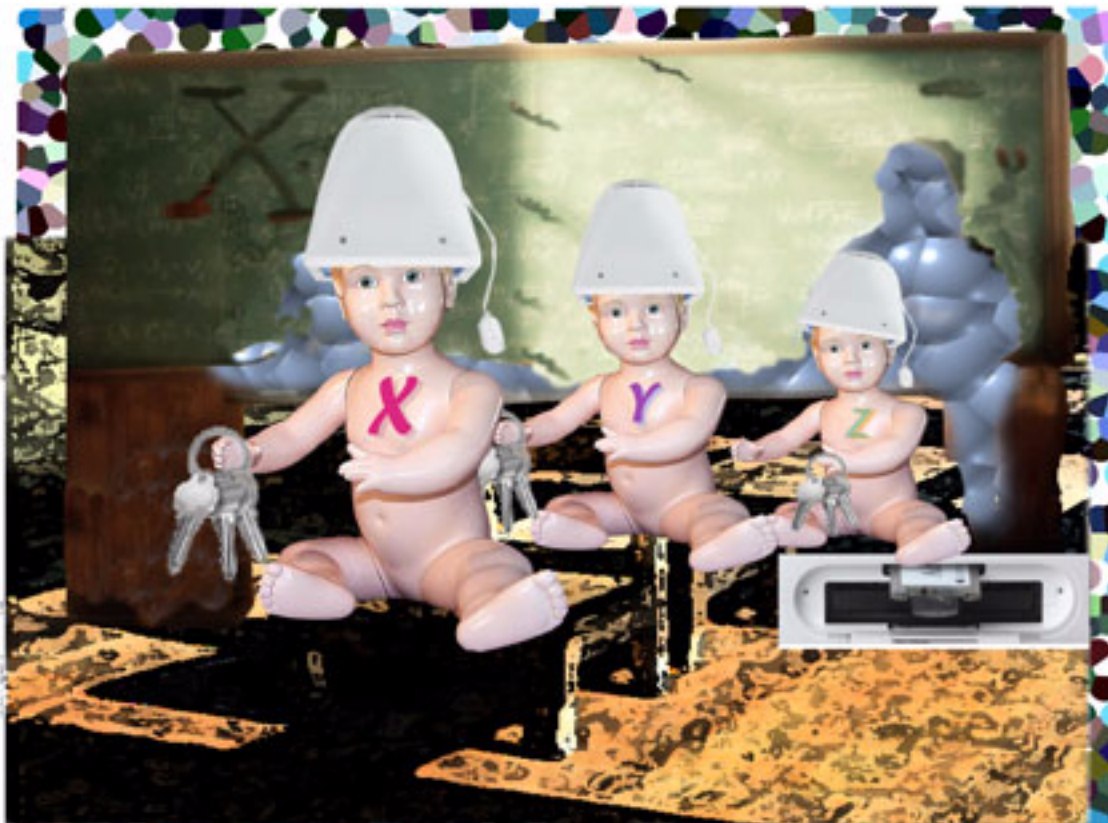

About This Particular Macintosh: About the [personal](#) computing experience™

Cover Art

“Early Wirings” Copyright © 2002 by [Catherine von Dennefeld](#)¹

We need new cover art each month. [Write to us!](#)²

Editorial Staff

Publisher/Editor-in-Chief [Michael Tsai](#)
Managing Editor [Kim Peacock](#)
Associate Editor/Reviews [Paul Fatula](#)
Copy Editors [Raena Armitage](#)
[Johann Campbell](#)
[Ginny O’Roak](#)
[Ellyn Ritterskamp](#)
[Brooke Smith](#)
Vacant
Web Editor [Lee Bennett](#)
Publicity Manager *Vacant*
Webmaster [Michael Tsai](#)
Beta Testers [The Staff](#)

Contributing Editors

At Large/Welcome [Robert Paul Leitao](#)
Graphics *Vacant*
How To [Ken Gruberman](#)
[Charles Ross](#)
Vacant
Interviews *Vacant*
Legacy Corner [Chris Lawson](#)
Music [David Ozab](#)
Networking [Matthew Glidden](#)
Opinion [Ellyn Ritterskamp](#)
[Mike Shields](#)
Vacant
Reviews [Eric Blair](#)
[Jamie McCornack](#)
[Gregory Tetrault](#)
[Christopher Turner](#)
Vacant
Shareware [Brooke Smith](#)
Technical [Evan Trent](#)

Artwork & Design

Graphics Director [Grant Osborne](#)
Graphic Design Consultant [Jamal Ghandour](#)
Layout and Design [Michael Tsai](#)
Cartoonist [Mike Flanagan](#)
Blue Apple Icon Designs Mark Robinson
Other Art RD Novo

Emeritus

RD Novo
Robert Madill
Belinda Wagner
Edward Goss
Tom Iovino
Daniel Chvatik

Contributors

Eric Blair
Paul Fatula
Mike Flanagan
Matthew Glidden
Ken Gruberman
Matt Johnson
Chris Lawson
Robert Paul Leitao
Trixie McGuire
James McNally
John McWilliams
Ellyn Ritterskamp
Charles Ross
Mike Shields
Brooke Smith
Gregory Tetrault
Macintosh users like you

Subscriptions

Sign up for [free](#) subscriptions using the [Web form](#)³ or [by e-mail](#)⁴.

Where to Find ATPM

Online and downloadable issues are available at <http://www.atpm.com>.

Chinese translations are available at <http://www.maczin.com>.

AT[®]M is a product of AT[®]M, Inc.
© 1995–2002, All Rights Reserved
ISSN: 1093-2909

Production Tools

Acrobat
AppleScript
BBEdit
CVL
CVS
Disk Copy
FileMaker Pro
FrameMaker+SGML

1. <mailto:catherine@eternalrings.com>
2. cover-art@atpm.com

3. <http://www.atpm.com/subscribe/>
4. subscriptions@atpm.com

iCab
ImageReady
MacSQL
Mailman
Mailsmith
Mesh
Mojo Mail
Perl
Snapz Pro X
StuffIt
Transmit

The Fonts

Cheltenham
Frutiger
Isla Bella
Marydale
Minion

Reprints

Articles and original art cannot be reproduced without the express permission of ATPM, unless otherwise noted. You may, however, print copies of ATPM provided that it is not modified in any way. Authors may be contacted through ATPM's editorial staff, or at their e-mail addresses, when provided.

Legal Stuff

About This Particular Macintosh may be uploaded to any online area or included on a CD-ROM compilation, so long as the file remains intact and unaltered, but all other rights are reserved. All information contained in this issue is correct to the best of our knowledge. The opinions expressed in ATPM are not necessarily those of this particular Macintosh. Product and company names and logos may be registered trademarks of their respective companies. Thank you for reading this far, and we hope that the rest of the magazine is more interesting than this.

Thanks for reading ATPM.



Sponsors

About This Particular Macintosh is free, and we intend to keep it that way. Our editors and staff are volunteers with “real” jobs who believe in the Macintosh way of computing. We don’t make a profit, nor do we plan to. As such, we rely on advertisers to help us pay for our Web site and other expenses.

We are now accepting inquiries from interested sponsors and advertisers. We have a variety of programs available to tailor to your needs. Please contact us at advertise@atpm.com for more information.

You can help support AT^{PM} by buying from online retailers using the following links: Amazon.com¹, MacMall², MacZone³, and Outpost.com⁴.



-
1. <http://www.amazon.com/exec/obidos/redirect-home/aboutthisparticu>
 2. <http://www.commission-junction.com/track/track.dll?AID=53427&PID=297078&URL=http%3A%2F%2Fwww%2Emacmall%2Ecom%2Fmacaffiliate>
 3. http://service.bfast.com/bfast/click?bfmid=1942029&siteid=26240435&bfpage=mac_zone
 4. <http://www.linksynergy.com/fs-bin/stat?id=N00D3BtDeo0&offerid=2161&type=3>

Welcome

Welcome to the June issue of *About This Particular Macintosh!* School is almost over so this is when schools buy computers. That's right. Schools buy most of their computers when no students are around to use them. Because so much happens with Apples and schools over the summer, we've dubbed this our *first official summer school issue*.

The eMac

Apple Computer is number one in education. The Mac maker continues to outsell all of its rivals in K-12 schools across the country. Apple claims it has real staying power in schools, and the new Apple eMac is a case in point. It comes without a handle and weighs about 50 pounds. In other words, it's not going anywhere. Once an eMac, the education-only successor to the original Apple CRT iMac, is placed on a table or desk, it's there for the next few years. It's sized and weighted kind of like a huge bowling ball without any holes and shaped like a 3/4 moon. Like a bright summer moon, the eMac comes in white.

The Xserve

In other education-related news, Apple has released the Xserve rackmount server. Well, the Xserve is not just for education, but it's something that will get researchers in higher education stopping by the campus all summer. The performance/power consumption ratio of the Apple G4 makes it the ideal computer for research and cluster computing. The problem is it's been a challenge to fit multiple Apple mini-towers in a closet or a rack. The new Xserve is conveniently sized for bright minds and interesting work.

One More Great Product

There's one more thing we know about that's created for bright minds, and this one's been put together by people who do interesting work. It's the latest issue of ATPM. Inside our June issue you will find:

...

The Candy Apple: Perspective is the Key(board)

The Candy Apple visits The Continent, to discover that not only are the words different, but so is some of the hardware.

Legacy Corner

Chris Lawson digresses a bit this month to talk about his new friend, Ti Cobb. You guessed it—his PowerBook G4/800. Sounds like a heavy hitter.

On a Clear Day You Can See the Hollywood Sign

It's not polite to shout "Fire!" in a theater. But Mike Shields doesn't object to doing so in his *Hollywood* column.

About This Particular Web Site

This month's ATPW features links to classic short stories and resources for students of philosophy. We also show you an attempt to blow up Parliament, a society dedicated to human extinction, and, of course, airline food.

Segments: Electricity: What Is It Good For?

Trixie McGuire tells us about her Mac experience—"enjoying" forty hours with two Macs, two kids, and no electricity! Sounds like fun.

Segments: Building the Dream Machine

Have an older Mac and want to use OS X on it? John McWilliams decided to try it out on his dirt-cheap (\$180) 9600/200. (Hint: it cost a bit more than \$180!)

Profiles in Networking: The Compact Macs

Profiles in Networking says "hello" to the seminal Macintosh models, the compact Macs, focusing on the Mac Plus, SEs, Classics, and Color Classics. For file and print sharing, we see why "classic" doesn't have to mean "obsolete." Compact Macs support LocalTalk connections out of the box, but require an external adapter or internal expansion card to become Ethernet-friendly, so we explore the options.

Roll Your Own: Variables and Data

Chuck Ross continues his series on Mac programming. This month he delves into Apple's free Script Editor and a useful programming tool: variables.

The User Strikes Back: Attack of the Installers

Maybe your favorite computer is misbehaving recently—could be because of some idiot installer. Learn what to do and not to do when installing stuff and find out Ken's "Four Laws of Installation."

Desktop Pictures: Giverny

Staffer Ellyn Ritterskamp doesn't take pictures—she knows to travel with friends who do! On their recent trip to France, her friend Forrest Brown took some great ones at Giverny, Monet's hangout north of Paris.

Shareware Roundup: Weblog Tools

Brooke Smith continues her compilation of what's out there, this time honing in on "Tools for Blogging" (in collaboration with James McNally).

Review: AquaGrep 1.0

Eric Blair looks at AquaGrep, a fairly unsuccessful attempt at making the Unix grep utility more accessible to Mac users.

Review: Final Draft 6.0.1.1

Last month we asked you if you wanted to be the next Fellini. But first, you have to write your screenplay. Perhaps Final Draft can help...for all your creative writing endeavors. Mike Shields gives you his take.

Review: MacLocksmith 2.4.0

Greg Tetrault reviews a program for creating password-encrypted files. As Queen Victoria used to say: "We are not amused." Neither was Greg.

Review: Memory Pro 1.0

Greg Tetrault checks out a shareware program that is supposed to help you adjust memory allocations of multiple applications. See what he thinks.

Review: QuickEncrypt 3.2

Greg also had time from his busy schedule to evaluate this 2040-bit encryption technology. Was it worth it? Let him tell you.

Review: WebWatch 1.0

Brooke Smith reviews a different type of screensaver. This one is actually useful—and not just a pretty face.



[Memories of My Life Since Buying an Apple Macintosh 6500/250](http://www.atpm.com/8.05/segments.shtml)¹

I read your story with a little bit of misty-eyed reflection. I felt the same way about my old Mac SE about five years ago when we decided it was too small to support what we wanted for the family. Only in its heyday, I had to cruise the fledgling cyberspace with Kermit and Prodigy(!) through a 9600 baud modem. Anyway, we replaced it with a beige G3 desktop, later added a Power Mac 7100/80 for my daughter, gave that to my son when we got a Umax SuperMac C600/240 for my daughter, and rounded out the collection with a PowerBook G3 (Lombard) for myself (I use it for my work, since the company for which I work is controlled by the Wintel Borg collective). Now we definitely can't afford a new Mac, much as I desperately want to use Mac OS X. (Can't run it "effectively" on any of our machines.)

Anyhow, I'm writing to you to recommend that you continue to try to upgrade the OS on your machine. Its essentially the same as my daughter's SuperMac (except you don't need FWB Toolkit to use the CD drive), has the same ROM, and all our machines are currently running Mac OS 9.1. I've found it to be snappier and more stable than Mac OS 8.0, and think you will notice a difference. We've even put an ATI graphics board & Ethernet card into the SuperMac to extend its lifetime. Have you tried adding more memory to it? My daughter's machine is maxed out with 144 MB RAM, but it really purrs and can still run most of the newer games coming out. I know Apple wants you to replace it with another, newer Apple computer, but it seems to me that if its still useful, why upgrade? \$300 for more memory and Mac OS 9.1 is much cheaper than a new iMac or iBook. (On the other hand, those machines really don't cost that much, especially compared to what the 6500 cost brand new.)

That's my unsolicited \$0.02 worth.

1. <http://www.atpm.com/8.05/segments.shtml>

Thanks for the great article.

—Kevin

[Setting up a Hardware Router](http://www.atpm.com/7.06/router.shtml)²

First of all, this article (and the subsequent comments) have been extremely helpful in helping me successfully network my computers. However, I am having one nagging problem. I can either have the computers (one PC/WXP and one Mac 9.1.2) communicate with each other *or* with the Internet, but not at the same time. I have the Barricade router and am using an evaluation version of Dave to network the computers. Does you know if it is possible to have Dave work with DHCP or to have the router work with manually entered IP addresses? Any additional suggestions (and/or recommended alternatives to Dave) would be greatly appreciated.

—Jen

This ought to work:

1) Hook both computers to the router. Configure the router for DHCP first, then skip to the alternate procedure below if that fails.

2) Set up both computers to use the router's DHCP—this usually just means entering the router's IP in the TCP/IP control panel and making sure Connect Via is set to Ethernet.

3) Set up DAVE to use the Ethernet connection.

Alternate:

1) Configure router to assign a static IP to each computer.

Consult documentation for the router if you need to.

2) Configure each computer to use its assigned static IP via Ethernet.

3) Same as above.

The above will *not* work if the router is one of the very rare few that doesn't have a built-in Ethernet switch as well; I'm not familiar with SMC's products so I can't say for sure. If this is the case, I would advise you to get a different router, preferably *not* a Linksys, for which I've seen many reports of trouble. —Chris Lawson

2. <http://www.atpm.com/7.06/router.shtml>

Copyright © 2002 the ATPM Staff, editor@atpm.com. We'd love to hear your thoughts about our publication. We always welcome your comments, criticisms, suggestions, and praise. Or, if you have an opinion or announcement about the Macintosh platform in general, that's OK too. Send your e-mail to editor@atpm.com. All mail becomes the property of ATPM.



The Candy Apple

by Elyn Ritterskamp, eritterskamp@atpm.com

Perspective is the Key(board)

Last month, I went to France for a week and a half. I stayed away from computers, with two exceptions. I couldn't resist looking around an Apple retailer on the Seine in Paris, and I also couldn't resist visiting a cyber café a few times to catch up on e-mail. Each experience broadened my perspective a little bit, which is my main reason for traveling.

If you ever go to Paris, be sure to save a day for wandering around a neighborhood or two, and make sure that one of those neighborhoods is the Left Bank of the Seine, across from Notre Dame. This is the strip where you can browse old books, postcards, and other treasures in little booths on the river. Across the street are stores like Shakespeare and Co., and yes, an Apple computer store. It's not like the big

American stores, of course, but I was delighted to see it nonetheless. Felt good to see familiar images and computer models in the store window.

That experience was about staying connected to home. My other experiences were about making myself step into someone else's shoes for a few minutes. That's sometimes tough but nearly always rewarding. This time, it was just a matter of learning to use a foreign keyboard—but what a learning curve!

I was aware on some level that keyboards vary, but I'd never used anything but the old QWERTY set-up. Imagine my surprise, when I sat down at the cyber café, to see this in front of me:

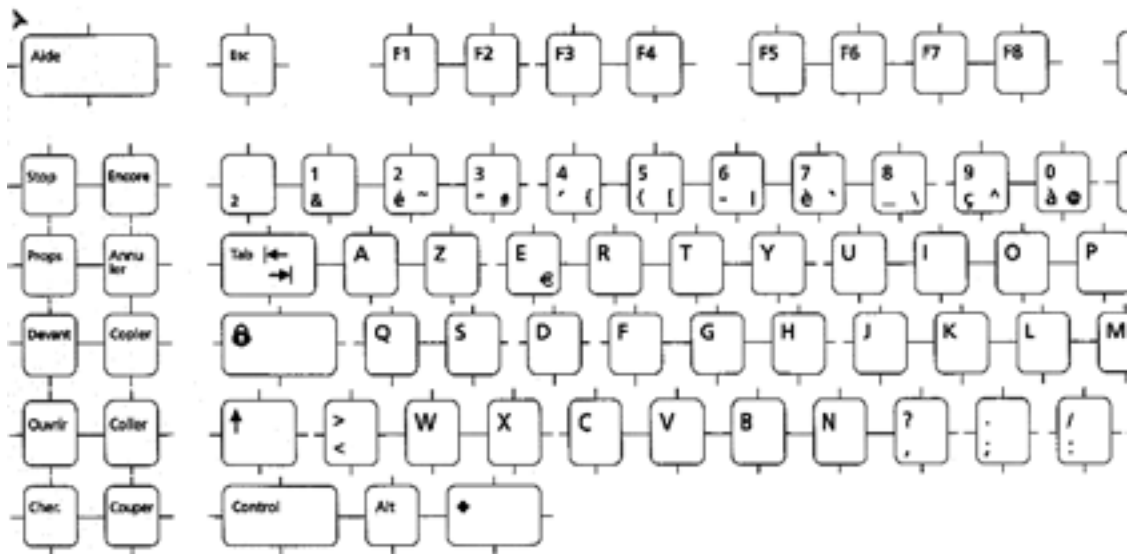

Okay, so a few of the letters are in different places. I can handle that. I fire up Internet Explorer and start typing in the URL of my traveling e-mail account at go.com. But wait, the dot in the dot.com isn't where it ought to be. Where the heck is it?

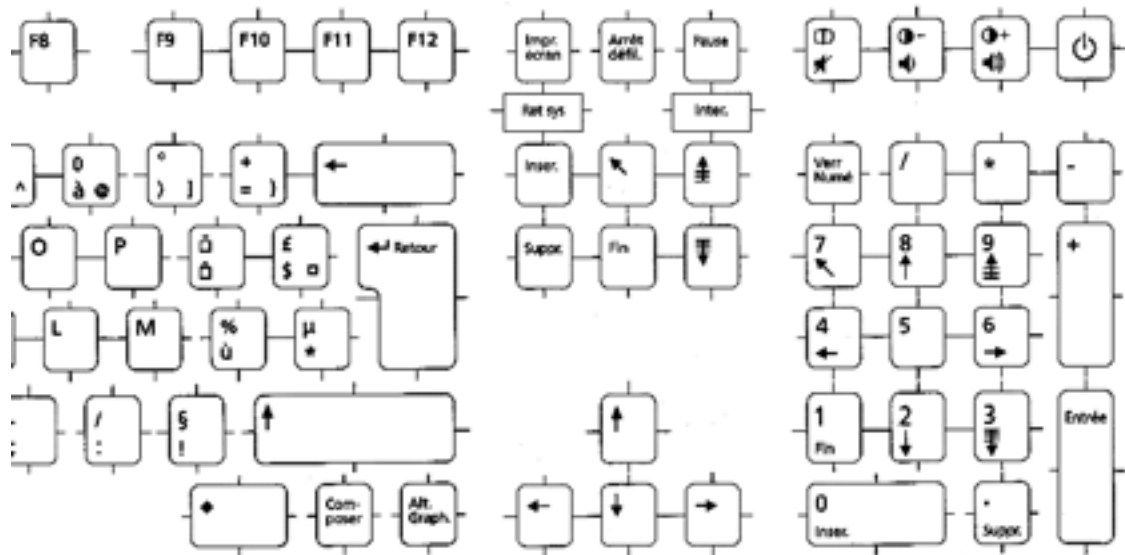

Turns out I could have turned on the number lock and used the “.” on the numeric keypad, but I didn't figure that out until much later. For the first session (maybe 20 minutes), I used Shift-semicolon to end each sentence. It felt very awkward for me, but I know that stuff like this is just a matter of what you get used to. I went to Nebraska for a week several years ago and was miserable because there weren't many trees. I grew up in a city with tons and tons of trees, so that felt weird. Folks that move here from the midwest, though, sometimes feel a little crowded by all the trees. It's just what you get used to.

So the trick for me in Paris was to relax with the new keyboard and try to figure out what advantages it might have. Since I only made two stops at the cyber café (remarkable restraint for a nine-day trip!), I didn't have to agonize over it for very long. I was able to access my real home e-mail account using a special client my cable company has made available, so that was fun. I only had to pay 2 Euros for 20 minutes of computer time (about \$1.90), so I didn't mind trashing 75 pieces of junk mail each time.

My other challenge, besides the keyboard, was figuring out the regional train schedule from the French Web site. We needed to know when the trains left Paris for Normandy, and of course the information was delivered in French. Mon français n'est pas bon. (My French is not good.) I finally hit on the notion of googling and then using the Google translation device to translate the page.

So here are my observations on travel, with a few suggestions for those of you who will be adventuring soon: Be willing to blend in, rather than trying to impose your own ideas on others. Be polite to other people and mostly they'll be polite to you. If you're not taking your own equipment with you, be prepared to deal with another language and hardware that's not what you're accustomed to.

So there's a Z in the top left corner of the keyboard instead of a Q. Big deal. You're in Paris! The French use it that way all the time; there must be some good reason! Try to figure out what that reason is, rather than griping about it.

Besides, you should have better things to do on vacation than monkey around in a cyber café, anyway!

Onward.



The Legacy Corner

by Chris Lawson, clawson@atpm.com

Being the harried college student that I am, this month's deadline once again snuck up on me and found me rather unprepared for a column. Undeterred by this slight setback, however, and with the dedicated resolve of a gifted procrastinator, I started writing the morning of the deadline. What you see here is my once-in-a-blue-moon brief digression from vintage Macintosh topics into the bleeding edge, the frontier, the untamed wilds, the future of Macdom.

It came today, just two days after leaving Chiang Kai-Shek International Airport in Taiwan. FedEx "Ground" service must be using McLaren F1s as their delivery trucks, because transit time from Anchorage to Kalamazoo, MI, was just 14 hours. Having driven that route once myself, I can attest that it's nowhere near a 14-hour drive, especially with the ruggedness of the Alaska Highway and those folks in charge of keeping other motorists safe from the escaped mental patients who would attempt such a drive, better known as provincial police or state troopers.

The box was a lot smaller than I expected, even with past experience. "It," as you may have guessed by now, is Ti Cobb, my new (bone-stock) PowerBook G4/800, purchased with my Apple [Student Developer hardware discount](#)¹ and sporting the most ridiculously large screen I have ever seen on a laptop.

Apple was kind enough to ship the 'Book with a charged battery, so I simply removed the packing materials and fired it right up, booting by default into Mac OS X 10.1.4. I had to run to class, however, so I put it right to sleep, locked it in my room, and returned two hours later to partition the hard disk for my own use. An hour later I had three partitions and a full installation of OS X and OS 9, each on its own partition. That's when I got started migrating my old files.

If I had been thinking ahead, I would have gone home, dug out the FireWire PCMCIA card that I've never used but purchased for "Steamroller" (my former production Mac, a PowerBook G3/266), and used that to transfer the 8 GB or so of data over to Ti Cobb. But I wasn't thinking ahead, and I didn't want to make the 10-minute drive home and dig around for it, so I just plugged Ti into the spare Ethernet hookup in my dorm room and logged into Steamroller.

Five hours later—yes, five—I had most of the important stuff transferred over. I will never resort to 10BaseT Ethernet to transfer more than 100 MB of data in one sitting again. I'm not the world's most patient person, and it's a good thing I

had other stuff to do while the copying was going on. Of course, that didn't stop me from checking on the progress every 15–20 minutes while I was around.

I've never been one for software like [Clean Install Assistant](#)², preferring instead to manually migrate my old items over. So I spent the next two hours copying over a few more bits and pieces and setting up the extensions set in OS 9 the way I wanted it. One of my suitemates asked me if I was up and running with the new computer yet, and I told him I was almost finished. He figured it was a good opportunity to work in an anti-Mac job, and said "I bet if you had a PC it would already be done." Yeah, because I wouldn't have been able to transfer all the information over so easily, I probably would have just left it alone.

Now that I have Ti Cobb to the point where I was yesterday at this time with Steamroller, I think a few first-glance sort of comparisons are in order. Graphics speed is at least an order of magnitude faster, as I'd expect with eight times the VRAM and a graphics chipset three generations newer. Scrolling is virtually instantaneous, and new windows pop up in iCab as fast as I can Command-Shift-click on links. (iCab tip: do *not* set it to log all server connections unless you also set it to delete said log on launch. If you don't delete this log every 2 MB or so, it will absolutely kill the launch time of iCab, turning it into a Mozilla wanna-be.) Processing speed is improved far more than I was expecting; the distributed.net [RC5 client](#)³ running on this 800 MHz G4 crunches through keys almost 10 times faster than a 266 MHz G3. A good deal of this acceleration is due to AltiVec, further proving its worth in math-intensive tasks. Show me an x86 CPU that can do 7.2MKeys/second!

Ti's speakers are comparable to those in Steamroller, and the keyboards have a similar feel as well, although Ti's might be marginally stiffer. Heat output seems roughly comparable between the two after having run Ti on my lap for most of the evening; I've only managed to get the fan to come on twice, and once was when I was benchmarking the RC5 cruncher with the CPU priority set as high as it would go. The battery easily lasted three hours with no energy saver settings whatsoever, and it charged fully while the 'Book was being used in about another three hours. Impressive, to say the least.

1. <http://developer.apple.com/students/sthardware.html>

2. <http://marcmoini.com/C-IAssistant.html>

3. <http://www.distributed.net/rc5/>

Thanks for the opportunity to digress. Next month we'll return to your regularly scheduled programming, or so I hope. (If not, wish me a happy graduation, because that'll be what could postpone my next column until the August issue.)

Copyright © 2002 Chris Lawson, clawson@atpm.com.



On a Clear Day You Can See the Hollywood Sign

by Mike Shields, mshields@atpm.com

When Is It OK to Yell “Fire” in a Crowded Theater?

When there’s a fire in a theater, and it’s crowded. Stay with me on this—some of it may even be Mac related, one never knows.

I’ve been noticing a disturbing trend lately. Advertisers lie. No big revelation here. They do it. They get paid to. Others that get paid to lie: actors, and of course lawyers. Actors do it to entertain, and lawyers to defend their clients, making it somewhat excusable, but only if the client is innocent.

However, the fine folks in advertising media are paid to blatantly lie and make up facts. I’m reminded of the fake movie reviewer of last year, complete with fake audience testimonials. One I came across today, Contains 100% Juice. Doesn’t necessarily mean that it *is* 100% Juice. I came across an interesting statistic recently. It costs \$1.50 to cut a DVD. A recent check of the local Blockbuster shows that fully half of their shelves are stocked with DVDs. Why do they cost an average of \$19.95? Who gets the rest of the money? The fine folks in marketing get a sizeable chunk, as they decide the manufacturer’s suggested retail price, or MSRP. And they aren’t even giving us the true facts. Advertise the sizzle, and sell the steak. Marketing 101. Lately, it’s been, “Advertise the sizzle, and sell them what they think is steak.” It might be fish, or chicken, but we’ll tell you it’s steak, so we make more.

Fire.

Mel Gibson stars in a movie coming out in August, entitled *Signs*. According to the trailers that are already in theaters, it’s about the mysterious crop circles that show up around the planet, and specifically, one that appears in his cornfield. Having seen it, I’d tell you more, however a signed non-disclosure agreement forbids me from saying anything more than that’s not really what it’s about.

Fire.

A movie about to come to a theater or drive-in near you (and as always, if there isn’t one or the other, move!) entitled *Undercover Brother* has a very disturbing billboard ad. Disturbing to Denise Richards anyway. Apparently, the artist took liberties with the size of her butt.

Fire.

When I was in sales, we had what are called bundles. Sure, you can go out and buy a monitor, a Mac, and a keyboard, but if you buy our bundle, you’ll get all that, and we’ll even throw in some free software. And, get this, you’ll pay less. What a deal! They still exist. Everywhere except the online Apple Store, where their idea of a bundle is charging the same price as what the two pieces of software cost separately, together. I need Final Cut Pro 3 and Cinema Tools, but why not give me

a discount? I’m not shooting *Star Wars II: Attack of the Killer Tomatoes* here, and every penny saved is literally a penny earned.

Fire.

When is a CD not a CD? When it’s a copy protected audio disc. A recent article in *The Hollywood Reporter*, among other places I would imagine, gives the low down on this. A quick stroll over to the AppleCare Knowledge Base, [article number 106882](#)¹, gives the long explanation. The article referred to herein, makes it sound like it’s Apple’s fault that they can’t play a copy protected audio disc. The reality is, and Sony/Epic Records is the biggest transgressor on this one, that some CDs are stamped with the warning, “Will not play on PC/Mac.” Meaning that they aren’t CDs anymore.

Fire.

A finely worded [article](#)² in the latest edition of *Reason* warns of a more immediate danger, if by immediate I mean eight years from now. The battle lines are being drawn, and I’m afraid that the people taking sides are, well, taking sides. It’s that both sides may be wrong. When coming to a fork in the road, sometimes, it’s best to take the third path. Granted, piracy, or should I say, Piracy, is a problem. But, could that be because the prices are too high? Having spoken to several software vendors, I know that the price of software contains the cost of piracy. Other software vendors provide their own version of copy protection, which usually boils down to how many copies you can install before you can’t do it anymore. Which costs money. And we all know how much this type of copy protection is bothersome and, in the end, not feasible.

Fire.

Yet the software vendors, and now the music labels, continue to insist on more protection for their intellectual property. OK, I do admit, that if someone stole my script tomorrow, and made *Diamond Is a Girl’s Best Friend*, I’d be pretty upset. However, at the same time, there are laws already in place that protect me, and I don’t need any additional technology to enforce them, the Digital Millennium Copyright Act notwithstanding. Which, by definition, should’ve expired on January 1st, 2001, as it was passed in 1998. Unless of course, it didn’t become law until then. To save you from having to read the entire [18-page document](#)³ which is also available as a PDF there, I’ll summarize. You can’t copy anything. There. Simple, and

1. <http://docs.info.apple.com/article.html?artnum=106882>

2. <http://www.reason.com/0205/fe.mg.hollywood.shtml>

3. <http://thomas.loc.gov/cgi-bin/query/z?c105:H.R.2281.ENR>:

straightforward. Well, not so simple. It turns out that you can, if it's only for your own use, and you don't intend to profit from it. Sound familiar? It's basically the same law that allows you to copy books at the library and use a VCR in your home. However, it extends its purview to all things digital and Internet-related. Aye, there's the rub. For those of you that are just landing on the planet, and have never heard of Napster, this is the law that's been broken. Taken literally, you can't rip your CDs, or copy protected audio discs anymore, and put your MP3s on your iPod. Even if you're able to, your iPod may not be able to play them. I personally don't have one, however, Father's Day is coming up...

Fire.

In any case, hear me now, listen to me later, and understand me after that. Your rights are being infringed. Your right to own a Mac, your right to play your music where and when you want it. What's next, your right to use a VCR? Anyone ever wonder why a recordable DVD player hasn't been made widely available? The content providers (read: movie makers) are afraid you'll start your own DVD distribution company. And if Senator Fritz Hollings (D-SC) has his way, the Security Systems Standards and Certification Act will pass.

Write your Congressman. You're in a crowded theater, and there's a fire.

As always, 72 and sunny in Redondo Beach.

e You next time.

Copyright © 2002 Mike Shields, mshields@atpm.com. Disclaimer: Mike's views this month probably don't represent anyone else's on this planet, or in this galaxy for that matter.



About This Particular Web Site

by Paul Fatula, pfatula@atpm.com

[The Gunpowder Plot Society](#)¹

OK, I probably should hold this until November, when it would be more timely. But really, why can't every day be Guy Fawkes Day? For those who don't know, Guy Fawkes was one of a group of conspirators who planned to blow up the British Parliament in 1605. The conspiracy failed, and Fawkes was hanged, drawn, and quartered. (And you thought you had a bad day!) On this page, you can read about the conspiracy, read society newsletters, and find out if you're related to one of the conspirators.

[Classic Short Stories](#)²

Looking for some good reading? This site hosts several dozen short stories by such authors as Balzac, de Maupassant, Joyce, and Poe. Unfortunately no downloadable text-only versions of the stories are offered, but as they are short, you can easily cut-and-paste into a text editor, or simply print one out to read on paper. Also, the site hasn't been updated in some time, and the links to bios of the authors no longer work.

[VHEMT](#)³

"May we live long and die out," proclaims the official Web site of the Voluntary Human Extinction Movement. (No, I don't know what the trailing T is for in the acronym.) Just in case the name of the organization doesn't say it all, there is an

extensive FAQ answering such questions as "I'm extra smart. Shouldn't I pass on my genes?" and "Won't VHEMT die out when all its members die off?" Translations of the site into numerous different language are available for non-English speakers.

[Philosophy Directories](#)⁴

If you need a good resource on philosophy, this site is it. The large collection of links offered will take you to philosophy discussion sites, places to download electronic copies of philosophy texts, and papers written on a variety of subjects. There is also help available for those who need help writing their own papers. I really wish I'd known about this site when I was in college, even though back then I wouldn't really have had time to enjoy it.

[Airline Meals](#)⁵

We all know about the security on El Al, but how's the food? Here's the Web site to answer your (heart)burning question. It offers nearly a hundred pictures of airline food served on dozens of different airlines, taken from airline Web sites or submitted by passengers. A link to "useless stuff" gives some statistics on airline food in the USA. Notably missing from the site is a picture of the small bags of peanuts handed out by [Southwest](#)⁶, but I'll remedy that situation after my next flight.

1. <http://www.gunpowder-plot.org/>
2. <http://mbhs.bergtraum.k12.ny.us/cybereng/shorts/>
3. <http://www.vhemt.org>

4. http://www.erraticimpact.com/html/directories_tools.htm
5. <http://www.airlinemeals.net>
6. <http://www.southwest.com>

Copyright © 2002 Paul Fatula, pfatula@atpm.com.



Segments: Slices from the Macintosh Life

by [Trixie McGuire](#), Trixie_McGuire@excite.com

Electricity: What Is It Good For?

We have two Macs and a year-old Compaq, routed up to a cable Internet connection through AT&T.

Last month, our power went out as a result of weather. Yes, there were downed power lines—not near us—but they were down, etc. I heard the same story from every power company customer service representative each time I called to report that our power was still out! Power was back on all around us. We just happened to be one of the many “small pockets” still without electricity.

I live in downtown Salt Lake City, Utah, and our power was out for over 40 hours. For heavens sake—the world came here for the Olympics. What would the world have thought if the power had gone out while we were playing hostess to the mostest? A few years back, Utah Power and Light was up for sale. It was merged with PacifiCorp, which is owned by foreign (Scottish) investors (if my sources are right; please correct me if I am wrong). The Utah Power and Light trucks that were a common sight during my childhood were replaced by sub-contracted electricity trucks.

I could go on and on about big corporate mergers and lack of true customer service, but the real reason I was upset is that the power went out a half hour after we had cable TV installed! Have you ever had to deal with a 17-year-old male who for years has begged for cable TV—and when he finally has the cable remote in his hot adolescent hands, the power

goes out and stays out for 40 plus hours? I am here to let you know: that is something you do not want to experience. Then he realized that he would not be able to get on battle.net and play StarCraft. Well, you don't want to go there either.

But that was not the real problem. The real problem, in our household, was that my 15-year-old daughter, who has grown up with a computer always there, had started a lengthy report for school. All her notes were on the suddenly powerless computer! When the power went out she was in her room watching a video that she needed to watch in order to finish her report. Mom was forced to call the power company outage number almost every hour on the hour for her own sanity—as if a mother with teenagers has any sanity. (Oh, but they were cute as little babies—let's have another one!)

So, the night before the report was due, we packed up her TV and VCR and drove her four blocks north to sit in the basement at her grandmother's house to finish the video, so she could rewrite her report. All the time we were hoping that the power would be back on when we got home. It wasn't, and it was 10:30 PM, so we packed all her scribbled notes and headed for Kinko's, which is only four blocks south, and spend 20 cents a minute for computer time plus printing. Total cost: \$17.82. So I am forced to ask: we have two Macs and a year old Compaq, routed up to a cable Internet connection. Without electricity, what are they good for?

Copyright © 2002 [Trixie McGuire](#), Trixie_McGuire@excite.com. The Segments section is open to anyone. If you have something interesting to say about life with your Mac, write us.



Segments: Slices from the Macintosh Life

by John McWilliams, jmcwilli@wavecom.net

Building the Dream Machine

Well, it was time to bite the bullet and start using Mac OS X, mostly because there are an ever increasing number of applications that will only run on X—especially Apple's new free iPhoto. At the same time, I wanted full compatibility with older serial and SCSI peripheral devices. I also wanted to keep the cost down.

The starting point was a Macintosh 9600/200. The 9600 was one of the last Power Macs before the G3s, and one of the most expandable. Purchased over eBay for \$180 including shipping, it came with a 4 GB hard drive and 160* MB of RAM—enough to get started. (I have found it necessary to add another 128 MB of RAM. And because I like to have a lot of applications open at the same time, I will probably add even more.)

The first step, after cleaning the dust out of the inside of the case, was to replace the processor card with a Sonnet G3/400 upgrade card (eBay, \$150). This involved simply removing the 604e/200 card from the processor slot and plugging in the Sonnet. Now it was time to install OS X. OS X will not directly install on these older machines; it has to be shoehorned onto the hard drive using a free program called [XPostFacto](#)¹.

Next, divide the hard drive into two partitions, or as I chose to do, install a second hard drive that I happened to have on hand. The process is the same either way. First, I installed Mac 9.1 on one of the drives to handle the Classic environment. (Note: this installation cannot use 9.2 as a normal installation requires. 9.1 handles Classic applications just fine.) Then put the OS X disk in the CD-ROM drive and start up XPostFacto. Installation takes just a couple of mouse clicks. Then I immediately ran the 10.1 update installer also using XPostFacto and wound up with OS X 10.1 fully working on my 9600. The last step was to install a PCI USB card (eBay, \$25) so I could use USB peripherals with the Mac. It is highly desirable, if not essential, that OS 9.1 and OS X be on separate partitions! Sometime afterward I used the Software Update panel to update the system to 10.1.3. This downloaded and installed directly from OS X.

Now I have a Mac that will run the new OS X-only software, the older so-called Classic software, and use older ADB mice and keyboards or newer USB ones (or even both at the same time), and older serial printers or newer USB ones. Full compatibility, both forward and backward. And all for a total cost of about \$350.

Note: because of a lack of drivers that run under OS X, using older serial printers such as the StyleWriters requires printing from 9.1. Drivers for many newer USB printers are built in to OS X or can be downloaded from the manufacturers' Web site. Gone is the Chooser; OS X can sense which printer is connected and choose the right driver automatically—a great improvement. However, printing in the Classic environment requires that the printer be selected in the Chooser as always.

Future expansion could include adding FireWire with a PCI card, adding more RAM, or even adding an LVD hard drive. But that's for the future, if I ever do it. Right now I have a cheap G3 that runs OS X (my original goal) and allows me to use that old Stylewriter too (but only from OS 9).

I am writing this in AppleWorks, upgraded from the original 6.0 to 6.2.2 via the free Apple download, and it runs well under OS X. It seems just as fast as 6.1 running under 9.1. And (most) older programs that won't run under X are simply handed off to 9.1 and run fine. All in all, a very successful experiment.

Caveats: OS X will not recognize the floppy drive or a disk in the drive. If it is necessary to read from, or write to a floppy, I must start up in OS 9.1. It does recognize devices on the SCSI chain and the serial ports. To start up the computer in OS 9, simply hold down the Option key during startup. (This requires having OS 9 on a separate drive or partition.) You can also choose OS 9 in the Startup Disk preference panel and then restart, although I have found that this doesn't always work. Using Command-Option-Shift-Delete at startup will also work. Also it takes quite a while for OS X to start its Classic environment (over three minutes), although after it's running, switching between the two systems is almost instantaneous.

I'm using a serial modem connected to the printer port and, although I had some problems at first getting it to operate properly, it's working fine now. The modem port seems to be bad, but so far that's the only fault I have found with the computer, and it's no big deal; I connect the external modem to the printer port and the printer to a USB port. Generally speaking, the same applications seem to run somewhat slower in X than in 9, but it's not a big difference.

1. <http://eshop.macsales.com/OSXCenter/XPostFacto>

As I get used to X, I find I like it more and more, especially as more and more of my favorite applications and utilities come out with X-compatible versions.

All in all, I have been very pleased with this low-end approach to using OS X and expect it to satisfy my needs for some time to come.

Copyright © 2002 John McWilliams, jmcwilli@wavecom.net. The Segments section is open to anyone. If you have something interesting to say about life with your Mac, write us.



Profiles in Networking

by Matthew Glidden, mglidden@atpm.com

The Compact Macs

The compact Mac series opened with the black-and-white Macintosh 128K in 1984 and closed with the Color Classic II in 1993. Most models have a small black-and-white screen and CPU speed in the single digits, which is practically primeval compared to today's style and speed demons. Primeval doesn't necessarily mean useless, however. Assuming you haven't turned your compact Mac into a [fishbowl](#)¹, you can use LocalTalk out of the box and add Ethernet support with an adapter and some tinkering.

People new to computer networks and their uses can check out the [ATPM/Threemacs Web site](#)² for additional information and setup help. This article also refers to relevant sub-pages of that site.

Compact Mac System Software

Your Mac includes basic network support through its system software, but you should confirm that it's installed and ready. On compact Macs, check the Control Panels folder (in the Apple menu or in the System Folder) and look for Network and Sharing Setup. Also check the Apple menu for the Chooser. Later on, these three programs will control your network connection and network file sharing.

If any of the three are missing, you should download the Network Software Installer from Apple and use it to install the missing pieces. You can also reinstall the system software as a whole, though that will take longer and might be overkill just to get network support. The Mac Plus, SE, SE/30, and Classic can use system versions up to 7.5.5. The Classic II, Color Classic, and Color Classic II can use up to System 7.6.1. If RAM and hard disk space are limited, go with System 7.0.1, as it's less demanding than the 7.5 and 7.6 versions.

- [Network Software Installer](#)³
- [System 7.0.1](#)⁴
- [System 7.5.3](#)⁵
- [System 7.5.5 upgrade](#)⁶ (install after 7.5.3)
- [System 7.6.1 upgrade](#)⁷ (requires purchase of 7.6)

The file downloads are free, but they are on the large side and will require patience from dial-up users. Open the downloaded file and follow the instructions to install.

LocalTalk Networks

Every Mac since the Plus includes LocalTalk support through its serial (modem and printer) ports. LocalTalk is slow but inexpensive, requiring only a single printer cable to connect two Macs.

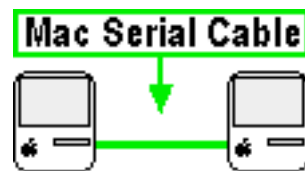

Two-Mac LocalTalk Network

Larger LocalTalk networks require a LocalTalk adapter for each Mac and printer on the network.

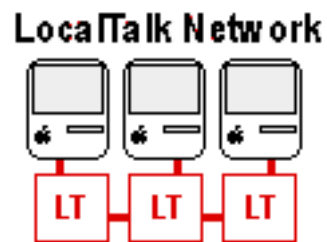

Three-or-More-Mac LocalTalk Network

This article focuses on Ethernet, which is more problematic than LocalTalk for compact Macs. See the [ATPM/Threemacs Network Setup page](#)⁸ for detailed LocalTalk setup instructions.

1. <http://www.macaquarium.com/>

2. <http://threemacs.com/>

3. http://download.info.apple.com/Apple_Support_Area/Apple_Software_Updates/English-North_American/Macintosh/Networking-Communications/Network_Software_Installer/

4. http://download.info.apple.com/Apple_Support_Area/Apple_Software_Updates/English-North_American/Macintosh/System/Older_System/System_7.0.x/

5. http://download.info.apple.com/Apple_Support_Area/Apple_Software_Updates/English-North_American/Macintosh/System/Older_System/System_7.5_Version_7.5.3/

6. http://download.info.apple.com/Apple_Support_Area/Apple_Software_Updates/English-North_American/Macintosh/System/System_7.5.5_Update/

7. http://download.info.apple.com/Apple_Support_Area/Apple_Software_Updates/English-North_American/Macintosh/System/Mac_OS_7.6.1_Update/

8. <http://atpm.com/network/setup/>

Ethernet Networks

Ethernet is the most common network type for home and business. It uses a special Ethernet cable and connects each networked Mac to a central hub or switch. Ethernet is many times faster than LocalTalk, though exact performance will vary, especially on the slower compact Mac models.

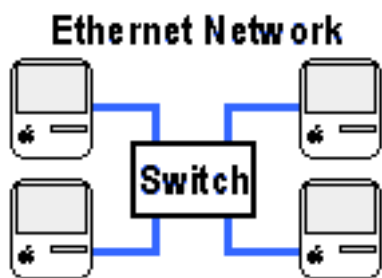

Ethernet Switch (or Hub) Network

For two (and only two) Mac Ethernet networks, you can use a special crossover Ethernet cable instead of the hub or switch.



Ethernet Crossover Network

Ethernet is a comparative latecomer to home networks and takes more work to set up than LocalTalk. All compact Macs starting with the Mac Plus support LocalTalk, but none include Ethernet support, so you need to add an internal card or external adapter to connect to an Ethernet network.

External Ethernet Adapters

External adapters typically connect to the Mac's SCSI port (a 25-pin, rectangular port on the back) and provide an Ethernet port, which is similar to, but slightly larger than, a phone jack.



Ethernet Port



SCSI Port

You connect the Ethernet port to your hub or switch with a piece of Ethernet cable, available at most computer stores. External Ethernet adapters usually have a separate power supply, so make sure you have an available plug. Setup is straightforward: connect the adapter to the Mac, connect the Mac to the network using an Ethernet cable, plug in the power supply, and you're done with the hardware setup.

This is a partial list of Mac-compatible SCSI-to-Ethernet adapters (there may be others). Like the compact Macs, these adapters are discontinued and can be hard to find. Check the shopping sites listed under Finding Ethernet Adapters to start your search.

External Adapters

- Asante Desktop EN/SC-10T (Mac Plus, SE, SE/30, Classic, Classic II)
- Asante Micro EN/SC (Mac Plus, SE, SE/30, Classic, Classic II)
- Dayna SCSI/LINK (Mac Plus, SE, SE/30, Classic, Classic II)
- Dayna EZPort (Mac Plus, SE, SE/30, Classic, Classic II)

Internal Ethernet Expansion Cards

Installing an internal expansion card requires opening the Mac's case, a procedure that requires technical skill and caution, as the monitor capacitor stores considerable voltage and can be very dangerous. If you're not ready for this, use an external adapter or contact a computer repair service that services Macs.

Internal Expansion Cards

- Asante MacCon+ SEET (SE)
- Asante MacCon3 IIsi (SE/30)
- Dayna E/SE (SE)
- Dayna E/30 (SE/30)
- Dayna E/si30 (SE/30)
- Dayna E/LC (Color Classic, Color Classic II)
- Asante MacConi LC-10T (Color Classic, Color Classic II)
- MacAlly LC-PDS Ethernet (Color Classic, Color Classic II)
- 3Com Etherlink/SE (SE)
- Cabletron SE/30 (SE/30)

Finding Ethernet Adapters and Expansion Cards

When shopping for external adapters or internal expansion cards, check the networking or communications section, or search the parts list for Ethernet. Look for SCSI or LC-PDS (not plain PDS) in the card description, as appropriate to your Mac model. Your decision is easier if the description specifically lists your Mac as a supported model, but it may only name the card type.

- [eBay Macintosh hardware auctions](#)¹ (try searching on Ethernet or the adapter manufacturer's name)
- [MacResQ](#)²
- [Small Dog Electronics](#)³
- Your favorite search engine (this can turn up online parts resellers)

-
1. <http://pages.ebay.com/catindex/catapple.html>
 2. <http://www.macresq.com/>
 3. <http://www.smalldog.com/>

Most expansion cards and external adapters include support software. Since cards will require their software to function properly, be cautious when purchasing used cards that don't have the original software. The card manufacturer's Web site can be a saving grace, as many companies post their support software online, even for discontinued products.

Conclusion: What's Next

Once the hardware side of your network setup is complete, see the ATPM/Threemac's [Mac File Sharing page](#)⁴ for help sharing files between networked Macs.

See the [Sharing a Printer page](#)⁵ for help sharing or using a network printer.

See the [Share an Internet Connection page](#)⁶ if you'd like to connect your Mac to a shared connection. Since the compact Macs are relatively slow, they probably won't work well as software routers, but can use hardware routers and software routers on other Macs.

-
4. http://atpm.com/network/files/file_sharing.htm
 5. <http://atpm.com/network/printing/index.html>
 6. <http://atpm.com/network/internet/index.html>

Copyright © 2002 Matthew Glidden, mglidden@atpm.com. Matthew Glidden is the webmaster of Threemac.com, a guide to constructing and maintaining home and small-office Macintosh networks. He can also tango and juggle, not necessarily at the same time.



Roll Your Own

by Charles Ross, cross@atpm.com

Variables and Data

Welcome back to *Roll Your Own* as we continue our journey into the magical world of Macintosh programming. Last month we covered the [basics of what programming is](#)¹ and even dove right in and wrote a small program in AppleScript. In this edition of the column, we're going to delve into one of the most useful programming tools: variables. And since variables store data, we're also going to talk about data types.

But before we get into that deep subject, let's get familiar with our programming environment a bit more. As I mentioned in our last column, we're going to use AppleScript as our programming language of choice. That being the case, there are a number of options as to how we can enter the code for our programs.

No matter which programming environment you use (and if you begin to really get into programming, you'll come into contact with many programming environments) you'll want to be as familiar as possible with its capabilities. A programming environment is different from a programming language. The programming environment is where you actually build your programs. It lets you type the code for your program, compile it into machine code, and run it. Some programming environments are phenomenally complex, such as [Metrowerks CodeWarrior](#)² and Apple's [Project Builder](#)³. Others, such as Script Editor, are so simple as to eventually be frustrating.

On every Macintosh computer, in addition to the AppleScript extension, is a small program called Script Editor. This is a very basic text editor that can compile, save, and run AppleScripts, and although it's rather limited in its features for the programmer, since it's free, we're going to assume that this is what you're using. If you're interested in editors with more features and power, other possibilities are [Scripter](#), [Script Debugger](#) and Apple's [Project Builder](#) on Mac OS X. If you're just beginning, I wouldn't yet recommend [Project Builder](#), but [Scripter](#)⁴ and [Script Debugger](#)⁵ are both

great environments, and when you have more experience with AppleScript, I would definitely recommend taking a closer look at them.



The Script Editor Icon

By the way, unless I'm addressing a topic specific to Mac OS 9, the screen shots will all be from OS X, but you should see very similar windows and dialogs in OS 9. If you haven't yet moved to Mac OS X and you have the hardware to support it, I can't recommend it highly enough. Yes, my PowerBook G3 is slower since I've been running X, but for the last six months it froze exactly twice, both times with [Virtual PC 5](#)⁶, and since Connectix released an update to that software and I installed it, I haven't seen a freeze on it at all. Apple has come through with rock-solid stability on this one, and I believe I've more than gained in productivity by avoiding reboots what I've lost in OS speed. Another feature in favor of OS X is [AppleScript Studio](#)⁷, which we'll get into once we start talking about the interface of software.

If you're running any classic version of the Mac OS, you'll find Script Editor (unless you've moved it) at "Hard Disk:Apple Extras:AppleScript:". On Mac OS X you'll find it at "/Applications/AppleScript/". When you launch it, you'll be presented with a window with some special buttons. The top left has a disclosure triangle with the word "Description" next to it. You can either show or hide the description by using this triangle. The description is for your own purposes

1. <http://www.atpm.com/8.05/roll.shtml>
2. <http://www.metrowerks.com/platforms/mactools/>
3. <http://developer.apple.com/tools/projectbuilder/>
4. <http://www.mainevent.com/scripter.html>
5. <http://www.latenightsw.com/sd3.0/index.html>

6. <http://www.atpm.com/8.02/virtual-pc.shtml>
7. http://www.apple.com/applescript/macosx/ascript_studio/

and can hold any text you like. I tend to place descriptions of the program within the code of the program by using comments, so I usually keep this hidden.

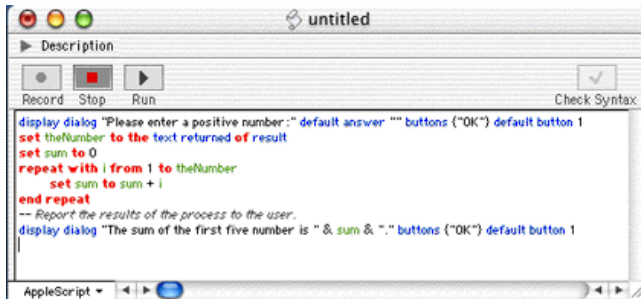

The Script Editor's Main Window

Below the description are four buttons. We're not going to worry too much about the first button, "Record," because we're studying programming here, not scriptable applications. But suffice it to say that some scriptable applications allow you to record actions and translate them into script commands, which can give you insight into how the program's commands work with AppleScript.

The second button, "Stop," allows you to halt the execution of a running program, allowing you to exit it without the program having to finish. This can be useful when there's a bug in your program and you want to stop before it goes any further. As in many programs, Command-period has the same effect.

Next is the "Run" button. When you click this button, Script Editor compiles your program, if you've made any changes since the last compile, and attempts to execute your code. Its keyboard equivalent is Command-R.

To the far right of the window is the "Check Syntax" button. Like the "Run" button, this will compile your code if there have been any changes to it since the last compile. If there haven't been changes, the button is disabled. You can also check the syntax by hitting the "Enter" key (not "Return").

Script Editor shows your code in different colors depending on what kind of word the code is. The default on Mac OS X is to display uncompiled text in orange Monaco, operators in black Geneva, AppleScript keywords in bold red Geneva, other keywords in blue Geneva, comments in grey italic Geneva, raw values in black Geneva, variables and subroutines in green Geneva, and references in purple Geneva. In Mac OS 9, almost everything appears in black Geneva by default, but AppleScript keywords are in bold and

comments are in italics, while uncompiled text is in Monaco. You can alter these defaults by selecting AppleScript Formatting from the Edit menu.

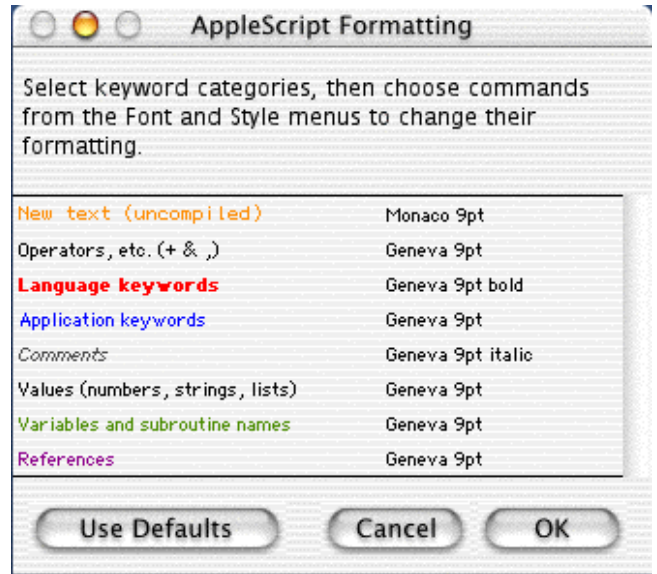

The AppleScript Formatting Dialog

Saving a script in Script Editor works just like other Macintosh programs, but you're given the option to save a script in a number of formats: text, compiled script, or application. Saving it as text will allow you to open the code in any text editor such as [BBEdit](http://www.atpm.com/6.10/bbedit.shtml)¹ or [Microsoft Word](http://www.atpm.com/7.01/office.shtml)². This can be useful when you want more powerful text editing features than are available in Script Editor, such as search and replace. If you attempt to save a script that can't compile because it has a bug, you'll be told that you can only save it in text format.

A compiled script is saved with the code that it represents, and can be run only within Script Editor (or one of the third-party script editors). An application works just like any other application on the Mac OS. When you double-click it, instead of opening in Script Editor it will run with its own menus and memory area. Each format has a different icon so you can easily recognize it while in the Finder.

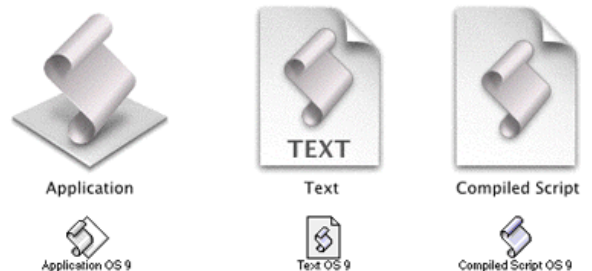

The Various Script Editor Document Icons

1. <http://www.atpm.com/6.10/bbedit.shtml>
2. <http://www.atpm.com/7.01/office.shtml>

When choosing to save your script as an application, you have some more choices to make. First of all, if you're working in Mac OS 9, you can save the application either as a Classic Applet or a Mac OS X Applet. Also, you can opt to keep the script open after execution, which can be handy in many cases that we'll go into later. Lastly, you can opt to show or hide the startup screen; if your script has a description, it will be shown with this startup screen.

There are two more windows available in Script Editor, both of which can be useful when debugging scripts. The first is the Result window, which you can show by selecting Show Result from the Controls menu or typing Command-L. The Result window shows the results of the last command executed by AppleScript. Take a look at the result window after running the following script and clicking "OK" in the appearing dialog box.

```
display dialog "Here's a simple dialog."
```

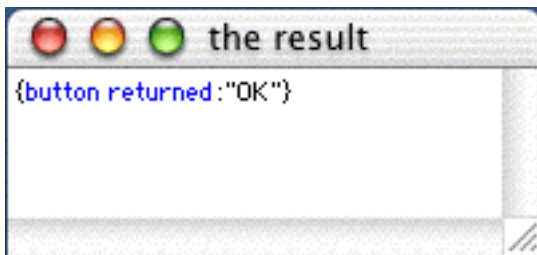

The Result Window

The last window is the Event Log window, which is also accessed from the Controls menu or by typing Command-E. This window shows a log of all the events that AppleScript processes. Events, in AppleScript lingo, are messages to an application. You can see from our screenshot of the Event Log that not only does the Event Log reveal which commands are events and where the events are being sent, but what the results of the events were. Notice that not every AppleScript command is an event (this event log was taken from the program we're going to write after we introduce variables later in this column). Although there are three "set" commands in the script, as you'll see later, none of them register in the event log.

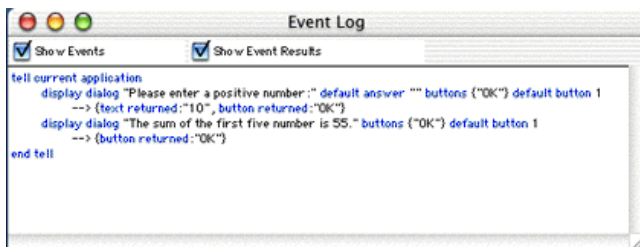

The Event Log Window

One last point about using Script Editor. Every AppleScript command must appear on one line. Writing code like the following won't work:

```
display dialog  
"Here's a simple dialog."
```

Sometimes, however, AppleScript commands can be very long, and there is a need, for the human reader's sake, to break the line into multiple lines. AppleScript provides a workaround for this. If an AppleScript line ends in a ~ character, the next line is taken to be a continuation of the first. So, the above command could be written as

```
display dialog~  
"Here's a simple dialog."
```

There are two ways to get the ~ character in Script Editor. The first is to type Option-L (easy to remember, since the character looks sort of like an L). The second, and easier way to do it is to type Option-Return. This actually inserts two characters: the ~ and a return, which is usually what you want anyway.

Now that we're more familiar with our programming environment, let's get back to our regular, well, programming.

Programs do their work by manipulating data, so programming languages provide a way to store and retrieve data. The tool for this is the variable. Variables are indispensable to programming. They allow the programmer to store a piece of information for later use. This information can then be altered or referenced elsewhere in the program.

A variable is simply a named piece of storage for your program. Variables can hold numbers, text, dates, or any other type of data. AppleScript, as in most areas of programming, makes it very easy to work with variables. To create a variable in AppleScript, we simply tell AppleScript to store a piece of data in a variable name that we provide. If you ever move to a lower level programming language, you'll find that you have to declare a variable before it can be used, but this isn't the case with AppleScript.

```
set myVariable to 9
```

The above line creates a variable called `myVariable` and stores the value of 9 in it. Any time we refer to `myVariable` in the rest of the program, it's as if we used the number 9 instead.

```
set myVariable to 9
display dialog myVariable
```



Displaying the Contents of a Variable

Given that the above display dialog line simply displayed a 9, why didn't we simply use `display dialog 9`? Well, we could have, and in this case, using a variable doesn't make much sense. So let's take a look at a more complex example that takes input from the user, stores that input into a variable, and returns some data that was calculated based on the input.

If you recall from last month, we wrote a simple program that would tell us the sum of the numbers 1 through 5. But that's not very flexible. Let's expand the usefulness of that program just a little bit by asking the user how far we should sum. We'll do that by using our familiar `display dialog` command to show a dialog box that allows the user to enter a number of his choice. We'll store that choice in a variable and use the variable in our repeat statement.

```
display dialog "Please enter a positive number:" default
answer "" buttons {"OK"} default button 1
set theNumber to the text returned of result
set sum to 0
repeat with i from 1 to theNumber
    set sum to sum + i
end repeat--Report the results of the process to the user.
display dialog "The sum of the first five number is " &
sum & "." buttons {"OK"} default button 1
```

We've added something to our display dialog command in that first line: the `default answer` portion. This tells the display dialog command that we want a field to appear in the dialog where the user can enter information. We then get this information from a built-in variable of AppleScript's called `result`. The `result` variable holds information returned by the display dialog command, specifically, the text entered by the user and the button clicked by the user. `result` in this case is of a special data type called a record, which we'll cover in just a little while. For now, we just want the text entered by the user (the button must be the OK button since that's the only one we specified). So by setting `theNumber` to the `text returned of result`, we are storing the user's data into the `theNumber` variable.

The rest of the program should be familiar from last month. We enter a repeating loop that sets a variable called `i` to 1, incrementing it each time we go through the loop. Inside the loop we add the numbers, and then when the loop is finished, we report our calculations to the user.

As I mentioned before, variables can store many different kinds of information, such as text, numbers, and dates. While we won't cover all of the data types AppleScript recognizes

(there are over a dozen), we do want to make sure you understand the most common types. First there is the integer, which we've used already in our program above. An integer is a whole number, such as 7, 932, or 0. Integers don't include numbers that have a fractional portion, like 7.2. That's known as a real number, which is another data type of AppleScript. Real numbers are things like 0.3, 3.1415, or 11.0. Note that 11.0 is a real number, not an integer. To mathematicians, it may be an integer, but because it takes note of a fractional part, even though it's zero, AppleScript defines it as a real number.

Text, also known as strings, consists of any group of characters enclosed in double quotes. The word "string" comes from the fact that text is a string of characters. Even if the characters are numerals, if they are enclosed in double quotes, AppleScript sees the numerals as a string. So, to give some examples, "Apple", "5", "About This Particular Macintosh" and "" are all examples of strings. That last one, two double quotes in a row, is an empty string, and believe it or not, it comes in quite handy in many programs.

For the most part, we're going to use just those simple types of data, but there are two more complex types that we should cover now. The first is the list. A list is a group of individual pieces of data that are held together in a defined order. A list can hold any type of other data AppleScript provides, including other lists. Here's an example of setting an AppleScript variable to a list of the first four prime numbers:

```
set thePrimes to {2, 3, 5, 7}
```

As you can see, a list is indicated by braces, and each item in the list is separated by a comma. This particular list includes only integers, but we could have a list like this:

```
set complexList to {9, "Chuck," pi, {2, 3, 5, 7}}
```

This list has an example of each of the types of data we've covered so far. The first element of the list is an integer. The second is a string. The third is a real number (`pi` is a special variable provided by AppleScript that represents the mathematical constant). The last element is another list. Each of these can be referred to with the `item` operator.

```
set complexList to {9, "Chuck," pi, {2, 3, 5, 7}}
set myItem to item 2 of complexList
display dialog myItem
```

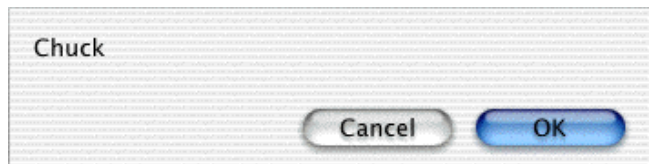

Extracting an Element of an AppleScript List

The other complex data type that we will come in contact with on a regular basis is the record. We use the record often if for no other reason that the display dialog command

returns a record after a dialog box is dismissed. A record looks a lot like a list, but each element of a record has a name. If you're familiar with databases, a record is very similar to the kind you know already. Here's an example of a record.

```
set theRecord to {firstName:"Chuck," lastName:"Ross," e-mail:"cross@atpm.com"}
```

Notice that a record looks a lot like a list, but each of the elements of the record has a name. We can get the value of each element like we did in our program using the result variable.

```
set theRecord to {firstName:"Chuck," lastName:"Ross," e-mail:"cross@atpm.com"}
set theName to firstName of theRecord
display dialog theName
```

If you remember when we received input from the user with the display dialog command, we got a record in the variable result. That record looked like this: {text returned:"10", button returned:"OK"}. Note that the text returned was actually a string, but we used it as an integer. When we placed the variable theNumber in our program inside of a repeat statement, AppleScript automatically translated the text entered by the user to a number that could be understood by the repeat statement. This assumes, of course, that the user didn't enter something besides a number, such as "ten." If it had, an error would have resulted when the program ran. Go ahead and try it if you like.

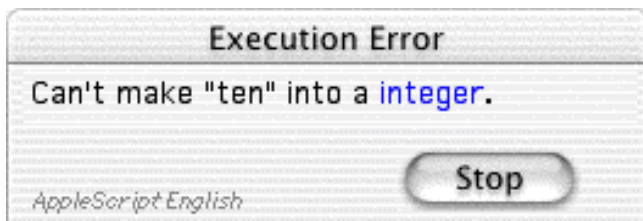

Result of AppleScript Attempting to Coerce Text to a Number

In other words, when AppleScript expects something to be an integer, it tries to coerce it into that form. The string "10" is easily coerced into the number 10, but "ten" isn't. Many programming languages don't offer this ability to automatically coerce data from one type to another. Having the ability in AppleScript, while it may sound like only a good thing, is actually a tradeoff. It's easier to write programs, but it's also easier to make mistakes that bring a program to its knees, as you can see in the above screen shot.

When you're unsure of what type of data a variable is storing, you can use the class of operator. This will return the data type of the variable.

```
set theVariable to "ATPM"
set theClass to class of theVariable
display dialog theClass
```

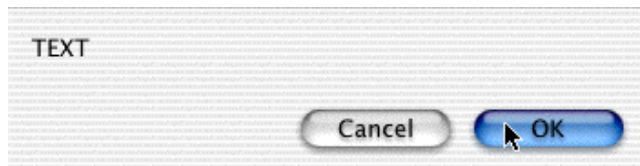

The Class of a Text Variable as Reported by AppleScript

You can also manually coerce data from one type to another. AppleScript will do its best to convert the data, but some data can't be coerced from one type to another. For instance, there's no way to convert a list to a number (unless the list contains only one element and that single element can be converted to a number).

```
set theVariable to "100"
set theNumber to theVariable as number
```

After the above code is run, theNumber holds the number 100, not the string "100", because we specifically coerced theVariable to a number.

You may have noticed that I have an odd way of naming my variables. My variable names never have spaces, and the name seems to run together. This is a limitation of programming languages. Variables have to be a single word, so different programmers use different methods to make variables more easily understood. My method is to begin my variable with a lower case letter and begin each new word with an upper case letter. Others use upper case for every word, and others separate words with an underscore, like The_Variable.

AppleScript variables must begin with a letter or an underscore character, cannot have any spaces, and can't use characters that AppleScript uses elsewhere (such as the plus sign). Variables also cannot be the same as any of AppleScript's predefined words, such as repeat or set. This makes sense, since AppleScript would have no way to tell if you meant the command or the variable.

There is an exception to this (isn't there always an exception?). If you begin and end your variable with the pipe character you can name your variable anything you like, even AppleScript reserved words.

```
set |set| to "ten"
```

Since AppleScript can use the pipe characters to know that you're referring to a variable called set rather than the command set, you can use any name you want. You can include spaces or the plus sign and AppleScript will work fine. The truth is, however, I have never seen anyone use this method for naming variables, but it's available to you if you like it.

That's about it for variables and data types this month. I hope you're enjoying our trip into programming. Thanks to everyone out there who has written in with suggestions and comments. Keep them coming! If you have specific programming questions you would like answered here next

month, let me know. Do you have an idea for a program that you think would be great to build together in this column? Continue to send me your ideas and I'll pick one or two that we can work out together. See you next month, when we'll go over the exciting topic of program flow!

Copyright © 2002 Charles Ross, cross@atpm.com. Charles Ross is an independent programmer and author. He's written articles for ISO FileMaker Magazine and is currently writing a book on creating applications with AppleScript.



The User Strikes Back

by Ken Gruberman, kgruberman@atpm.com

Episode II: Attack of the Installers

There's a famous maxim about computers that probably originated in the Tech Support community: "the best way to keep a computer stable and rock solid is to never install anything on it." Like most maxims, this one is rooted in the harsh reality of today's computing world. Macs and PCs usually work perfectly right out of the box, but over time they can become erratic and prone to crashing or freezing. Most people think the reason for this is buggy software, but more often than not the real culprit is badly-written, ineffective, excessive, or downright moronic software installers.

I can attest to this in my own day-to-day experiences with clients, and also with e-mails and phone calls I receive from various user group members. Invariably the complaint always starts like this: "I recently installed (fill in the blank) and now nothing works right." Or, "I don't know what's wrong with my computer: it is behaving strangely. All I did was install a new printer driver."

This article will take a look at the issues surrounding the concept of installing software on a Macintosh: what to do, what not to do, and things to look for. You will also learn my *Four Laws of Software Installation*. With a solid grasp of how to be a Master Installer, you can make your computer life a lot more satisfying. The bulk of the article will deal with long-standing installation issues involving Mac OS 7, 8 and 9; Mac OS X-specific topics will be covered at the end. So let's get to it!

More Is Not Always Better

Most software you buy requires installation on your Macintosh in some fashion. The typical exception to this are games for young kids or interactive titles such as the "Living Books" series. These programs can be run directly from their respective CD's with little or no degradation in performance. But for the most part, all productivity software that comes on CDs must be installed onto your hard disk.

There are several companies that make installation programs that developers license for their use—Aladdin's *InstallerMaker* and Cyclos Software's *Smaller Installer* are two good examples—but the majority of installers you'll come across are made by MindVision. Its *Installer VISE* and *Updater VISE* products are even used by Apple for most of its system software and update installers. While all installers work pretty much the same way, for the sake of brevity we'll concentrate on *Installer VISE*.

In this example, we'll be working with the AppleWorks 6 installer. After launching the program installer and clicking through a splash screen or two, we eventually get to the main installation screen. This is where the installer wants to ask us a few things, such as what kind of installation do we want, and where do we want the installer to put the software. Many people feel a bit overwhelmed by installers and, at this point, usually let them do what they want to do. It is in your best interest, however, to see *exactly* what the installer has in mind for you, so here is my First Law of Software Installation:

- *Always click on the Easy Install popup menu and switch over to Custom Install if the option exists.*

If you click and hold on the Easy Install popup (see Figure 1), you will notice that the typical installer has three options: Easy Install, Custom Install, and Uninstall. (More on that last option in a minute.) By choosing Custom Install, you will get a detailed list of everything the installer intends to put on your drive, and this can often times be a real eye-opening experience.

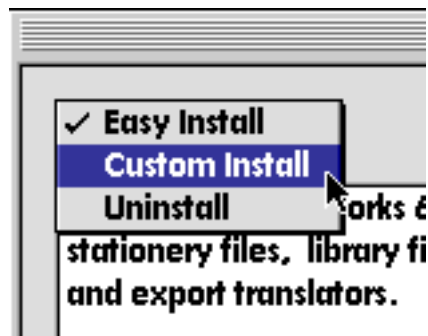

Figure 1: Most installers feature this pop-down menu. Some have different choices such as "Recommended Install," while others may not have one at all.

Often times programmers take a "kitchen sink" approach to installation. An Easy Install may result in dozens, hundreds, or even thousands of unwanted files being dumped onto your unsuspecting hard drive. Checking out the particulars using Custom Install can help you cut down the installation process to something more tailored to your needs. It can also keep disasters from happening.

Who Do You Trust?

After choosing Custom Install, a scrollable list of items to be installed appears (see Figure 2). Down at the bottom are a couple of interesting items. The “Equation Editor” for one, and “QuickTime” for another. In our case, we know we don’t need and will *never* need the Equation Editor, and we already have the latest version of QuickTime installed. By checking only the items we need or want, we are assured of a more accurate and satisfying install.

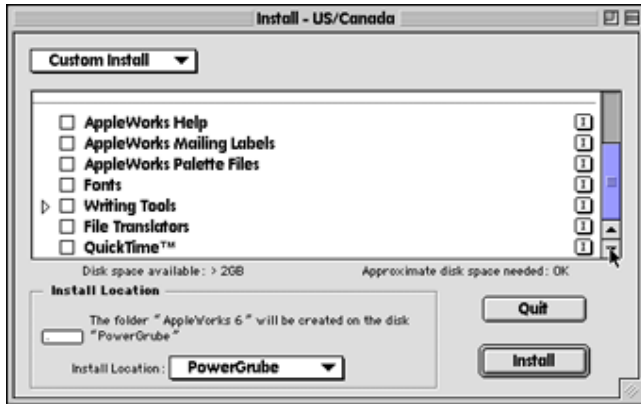

Figure 2: Choosing “Custom Install” lets you see just what the installer has in mind for your hard disk. Clicking on the “i” Information Buttons tells you what each item is for. In addition you can change the default install location—or hard drive—by clicking on the pop-down menu in the lower left corner. Some installers even let you specify a specific folder to install into, while others refuse to install onto any hard disk but the startup drive.

In addition, it is possible that an installer, left on its own, will try to put an older version of software over a newer version. While this is a relatively rare occurrence in MindVision-based installers, it can still happen. Clicking on the “i” information button found to the right of each item will tell us what each item is for (if the programmers were thoughtful enough to put in that information) and the version number (if present) of the item. They exist to help you, the user, to better make informed decisions on exactly what you want installed.

Clicking on the “i” button next to the QuickTime installation item (see Figure 3) reveals that it is version 4.0.3, a much older version than the currently installed 5.0.2. While it’s likely that the installer—if it is written properly—will sense the newer version and skip over the older one even if it is checked or if an Easy Install is being performed...wouldn’t you feel better if *you* were in charge? Why take the chance?

Taking personal responsibility for what is installed during the installation process is the first step toward complete stewardship of your computer.

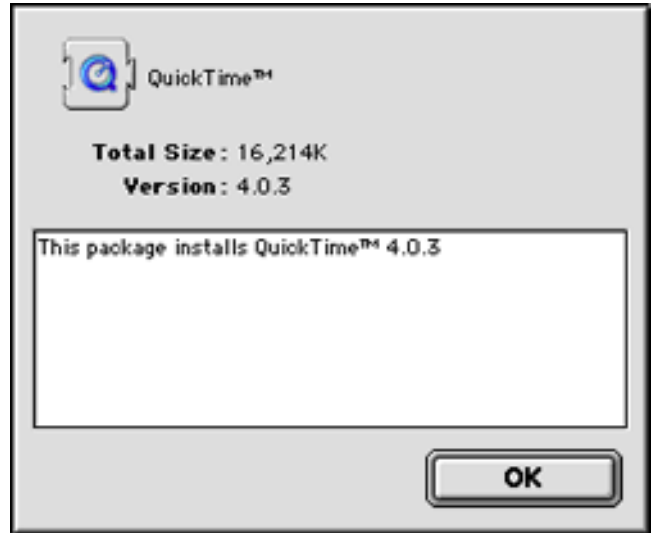

Figure 3: Clicking on the “i” button across from the QuickTime install package reveals an older version than what is currently available.

Remember that last option, the one called Uninstall? You’d be amazed how many people forget that it’s there. We all try software, from time to time, that just doesn’t work out. Now the question is, how do you get it off your hard drive? The PC world usually sticks an uninstaller program right in the folder with the original software or uses a special “Add/Remove” master program, but Macintosh software typically doesn’t go in for that sort of thing. Many times, removing software is as easy as tossing the folder it’s in into the trash...but not always. So here’s my Second Law of Software Installation:

• *If you used an installer to put software on your hard drive, use that same installer’s “Uninstall” option (if present) to remove the software from your hard drive.*

As you might suspect, uninstallers may not be as effective in removing software if you’ve moved or renamed the original folder, and they often leave useless system preference files behind, but it’s still worth trying as a first course of action. Most MindVision-based installers will ask you to locate the folder in question if you’ve moved or renamed it. In addition, well-written software installers will remove system extensions, control panels, fonts and other system folder items they may have installed originally.

Taking Control

As you also probably suspect, not all installers are well-written. Installer VISE itself is *exceedingly* well-written, but that’s only a shell that program developers then fill on their own. If they do a less than perfect job, you may suffer for it.

For those who wish to avoid installation or removal hassles at all cost, there are a couple of solutions...one more drastic than the other. Both involve software that “watches over you.”



The first solution is Aladdin's venerable [Spring Cleaning](http://www.atpm.com/5.07/springcleaning.shtml)¹ software. As Aladdin glibly puts it on the product's Web site:

Spring Cleaning gets rid of hard drive clutter and wipes away Internet tracks to reclaim disk space and increase your Mac's performance. Completely uninstall old software and space-wasting files that become scattered all over your hard drive. Quickly clean out hard-to-find Internet cookies, cache, and history files that clog disk space and risk your privacy! Easily restore items you've removed if you later change your mind. Keep your Mac running its best—give it a good Spring Cleaning!

The last version of Spring Cleaning I tried was version 2; it's now at version 4.0.2. I found it to be an effective tool, though far from perfect. Since I could do a better job “by hand,” so to speak, I decided against using it at the time, but many others seem to like it. Aladdin does not offer a demo version, but all their products come with a 30-day money-back guarantee. If you have been burned in the past trying to remove software, and you'd rather automate the uninstallation process, this may be what you're looking for.



The more drastic solution is Power On's [Rewind](http://poweronsoftware.com/products/rewind/default.asp)². This software is the Macintosh equivalent of Adaptec *GoBack*, a longtime standard on the PC. What these programs do is set aside a portion of your hard disk—a fairly large sized

portion—and use it to keep track of everything you do to your hard disk. Every file you create, every program you install, alter, or uninstall. Everything. And then, if something goes wrong, you can literally *go back in time* by reverting your hard disk to a “safe point” of your choosing. Everything you did since that safe point never existed.

Or as Power On puts it (in exceedingly choppy prose):

Even the best computer users have bad days. You throw away a file by mistake. Then empty the trash. You install new software. Only to discover it created new glitches. Or worse, your entire system crashes. And even prayers can't resurrect your Mac from the dead. Well, it's time to stop worrying, and start Rewinding.

Rewind is continuous protection for your Mac. Unlike backups which only let you recover from your last backup (yesterday, last week, last month), Rewind protects everything, all the time. Never lose a document again.

Opinions from the Mac press on how well Rewind works varies. *CNET* gave it 8 out of 10 stars, while *Macworld* magazine (a better judge in my opinion) says that it's better now than it was, but there is a lot of room for improvement. Reliability, disk slowdown issues, and the fact that Rewind can eat up to 10 percent of your hard disk space are what is mentioned in most reviews. Still, if peace of mind is what you're after, Rewind could provide you with the ultimate safety net.

As with Spring Cleaning, no demo is available but there is a 30-day money-back guarantee.

Too Much of a Not-So-Good Thing

Now we get to one of my pet peeves: installer CDs that come with scanners, printers, cameras, CD burners, and other hardware peripherals. Many times, all you need is one simple extension or a couple of driver files to make your device work, but what do you get instead? A ton of useless software!

Manufacturers typically stuff their installer CDs full of product tryouts, third-party demos, stock art, clip art, “just in case you don't have it” software such as various versions of QuickTime or Acrobat Reader, and more. Some even include software for Windows PCs without identifying it as such. If you're not careful, you could wind up installing a lot of junk, not to mention five copies of Acrobat Reader!

Epson, in particular, is famous for loading up their scanner driver CDs with old, anemic, or simply pointless software that involves image manipulation. In this example (see Figure 4), how much of the software on this CD do you think is needed to run the scanner inside of Photoshop,

1. <http://www.atpm.com/5.07/springcleaning.shtml>

2. <http://poweronsoftware.com/products/rewind/default.asp>

GraphicConverter, or other imaging programs? The answer is “not much.” All you need are the TWAIN setup files and that’s it—all the rest is window dressing.

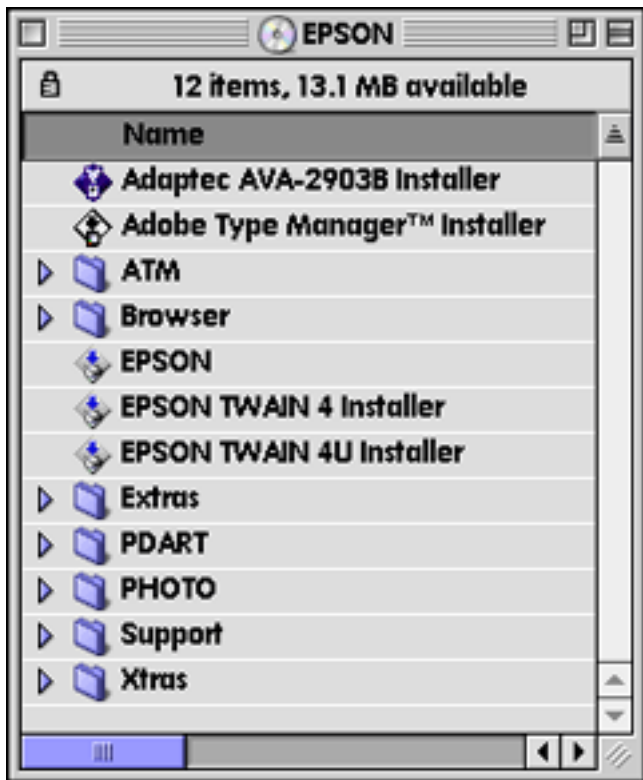

Figure 4: There is only one file needed on this list: the “Epson TWAIN 4 Installer.” Everything else can be ignored.

The assumption these companies make is that consumers want “value” for their money. That’s why some of them include a second CD that is full of (mostly bogus) software. The companies also assume these same consumers have no pre-existing software on their drives to catalog, view, or otherwise manipulate images generated from scanners, cameras, and the like. They attempt to provide these things by bundling software from no-name companies...or even worse, badly ported Mac versions of poorly written PC-based software titles.

To add insult to injury, 99 percent of the time, the software you *do* need on the CD is already out-of-date by the time you open the box! This happens because of the lag time involved between a product’s manufacture and its purchase. Hardware can be distributed to warehouses from the original manufacturer, than stocked in a back room somewhere for months before you get to it. Online vendors typically have less of an inventory backlog than brick-and-mortar stores, but they are not immune to the problem either. And then there’s a reluctance on the part of hardware manufacturers to revise the software installer CD every time a new version is released.

I’ve seen brand-new HP Deskjet printers with driver software on CD that is three revisions out of date. And Epson printer and scanner installers, at one time, were famous for installing an older version of ColorSync right along side a newer one, which resulted in immediately de-stabilizing the system software. Then there are the UMAX scanner installers that range from 40 MB to over 100 MB in size, all designed to install one simple plug-in. Not to mention current Yamaha CD Burners that eschewed the rock-solid *Toast* burning software in favor of an incredibly atrocious suite of software from a German developer who had never written Macintosh software before this year. And it shows.

In response to this sorry state of affairs, here is my Third Law of Software Installation:

- *When it comes to any hardware device that hooks up to your computer and requires driver software of some kind...never use the CD that comes in the box! Always download the latest version directly from the manufacturer’s Web site.*

This is a time-saver as well: you won’t have to wade through gobs of extraneous software on the CD just to find the one or two files you need. Almost every hardware maker I can think of maintains full-service Web sites with up-to-the-minute software installers and updaters. To quickly find what you’re looking for, try going to VersionTracker and entering the name of your device. You’ll quickly locate the appropriate driver for it and be able to download it right then and there.

Besides the convenience, and the knowledge that you’re installing the absolutely *latest* version of the driver in question, this is a good idea for other reasons. In the case of HP and Epson, for example, their OS X–native drivers have only recently appeared. Neither company has been including them on the CDs found in the box with the product; they actually assume you’ll be going to their Web sites to download the software you need. And they’re smart in that assumption, as OS X native drivers have been constantly changing as the companies figure out better ways of writing them. Since Apple itself is constantly fiddling with OS X, if you use this system it’s a good idea to check for new versions of device driver software on a monthly—or even weekly—basis.

Epson also puts printer driver “updates” on the same Web page as the printer drivers themselves. You may find that not only were you not using the latest version of printer driver software for your particular Epson Stylus or Photo Stylus printer, but that you need an additional update or “patch” as well.

Improved drivers for printers, scanners, and other peripherals often result in faster and easier operation with less chance of crashing, so check the Web often!

The Big Turn-Off

So far we've talked about what installers do, and how to best use them. Now it's time to discuss the right way to actually *install* software.

Most installers give you some kind of admonishment to "quit all running applications (programs) before continuing." Some even do it for you. The problem is that not all software that is currently running can be seen by installers. Some of it resides in code that is running inside your system software, usually in the form of various extensions you may have residing in your System Folder's "Extensions" folder. Some of these extensions are, in reality, mini-applications while others insert themselves as processes into normal system operation. Try as they might, installers simply can't quit these "background applications," as they are sometimes referred to, because they are not able to detect them. One of the worst offenders, by the way, is anti-virus software; installing something while anti-virus protectors are standing guard can often times result in an install that *appears* to be okay, but is actually as full of holes as a piece of Swiss cheese.

It's up to you to help the installer do its job correctly by following my Fourth Law of Software Installation:

- *Before you run any installer that is on your hard drive, always start up the Mac with extensions disabled.*

Fortunately for us Mac folk, this is easy to do. You simply restart your Mac (or start it up if it was already off) and immediately upon hearing the startup chime...(drum roll, please) *hold down the Shift key.*

You keep holding down the Shift key on your keyboard as the "Happy Mac" appears. You may finally let go when you see this notice: "Welcome to Macintosh (Extensions Disabled)." This message tells you right up front that you have successfully managed to keep the Mac from running any extra stuff from your System Folder, which is also why it takes very little time after that message for your desktop to appear. Using this method your Mac starts up running nothing but the barest minimum of system software. If for any reason you attempt to start up without extensions but don't see the message, you either waited too long before pressing down the Shift key, or you let go too soon.

This technique falls into the "Mac 101" category: it is *so* basic that sometimes we take for granted that everyone knows about it. If you consult the "ReadMe" file that each installer invariably has (and you always should before attempting the install), you'll often times see this mentioned. But again, some developers or tech people forget to mention it, and the installers themselves quite often forget to mention it. Nevertheless, it's one of the most important Macintosh tips you'll ever get.

The Smaller Turn-On

Starting up with extensions disabled is all well and good, but what if the software you're trying to install is on a CD? Won't starting up with extensions disabled also keep the CD from

mounting? In a word: yes. The Mac needs a particular extension in OS 9 called "Apple CD/DVD Driver" in order to recognize and mount a CD. In earlier versions of system software the file has a slightly different name, but you'll recognize it when you see it.

The best way to deal with this situation is to create a "startup set" that has only what you need to install software from CD's. You do this in either the Apple-supplied Extensions Manager control panel, or, if you own it, Casady & Greene's invaluable Conflict Catcher control panel. Both items allow you to create different "sets" of control panels, extensions, contextual menu items, control strip items, and fonts that will load at startup time. Conflict Catcher has more control over the startup process than Extensions Manager does, but that's a whole other column. For this example, either one will do the job; from now on I'll refer to Extensions Manager as "EM" and Conflict Catcher as "CC."

Creating a new startup set is as easy as going to EM's "File" menu or CC's "Sets" menu and selecting "create new set." Since we're going to have almost everything turned off, an easier way to accomplish this task is to start with everything turned off and selecting only what we want. In Conflict Catcher we can select the set that says "Disable all startup files" (see Figure 5), then hit Command-E to "Edit Sets" and select "Duplicate" from the buttons on the right. Name the new set "CD Install" and give it a shortcut key if desired. In EM, you'll have to pick "Mac OS [your OS version] Base" as EM does not have the "Disable All" function. Then go to the File menu, select "Duplicate" and name the new set "CD Install."

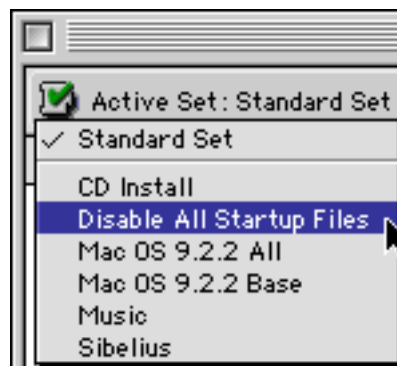

Figure 5: Conflict Catcher 9's revamped "Sets" drop-down menu shows all the sets available for startup, including user-defined ones such as "CD Install."

If you're using EM, you'll continue to uncheck items until you have what you need, while in CC you'll be doing the opposite as everything is already unchecked. This now raises the question, "Just exactly what *do* I need to successfully install from CD's?" The answer to this question should be a simple one, but it's not.

Let's put it this way—most installers can get away with just the following items running, using Mac OS 9 as our working operating system:

Control Panels

- Energy Saver—keeps your Mac from falling asleep in case your install takes too long.
- Conflict Catcher or Extensions Manager—so you can go back to your “standard set” easily after the install is over, or to make any needed changes.

Extensions

- *Conflict Extension™ or Extensions Manager extension*—as stated above.
- *Apple CD/DVD Driver*—this is the main driver that controls your built-in optical drive.
- *CarbonLib*—some installers require this, while others don't.
- *FireWire Enabler & FireWire Support*—in case you need to install items located on external FireWire hard drives or CD burners. Also include any third-party FireWire driver you may be using in conjunction with the peripheral. If your Mac doesn't have FireWire or you don't own any FireWire peripherals, you may skip these.
- *Foreign File Access*—used in conjunction with the built-in optical drive.
- *HID Library*—used by some Macs' USB keyboards.
- *ISO 9660 File Access*—again used in conjunction with the built-in optical drive.
- *Text Encoding Converter*—your Mac won't startup without it! Both EM and CC will lock this one off for you, but you may be tempted to move it out of the Extensions folder by hand. Don't.
- *USB Device Extension*—used by your Mac's USB keyboard. Disabling it yields a nasty message at the next restart.
- *USB Software Locator*—same as above.

That should be the end of it, but sometimes it isn't. Some installers, for example, use QuickTime to display certain images on the screen during installation. Other installers—mainly ones involved in graphics or imaging products—want ColorSync to be active and will complain if it isn't. Still others may require the AppleScript extension to be active. Finally, there are installers that make a connection to the Internet during the installation process, and they'll want the Open Transport Software to be active, which is comprised of the following Control Panels and Extensions:

- Modem
- Remote Access

- TCP/IP
- Open Transport
- Open Transport ASLM Modules
- Shared Library Manager
- Shared Library Manager PPC

Also, don't forget about the fonts. CC lets you turn them off or on as well. If you have hundreds of fonts in your system folder, turning most of them off can also help the installation process greatly. Stick to the Apple-supplied fonts and any ones you may be using via the Appearance control panel. The truth of the matter is, you'll use a bit of experimentation to find the right mix of just what you do need and what you don't, but once you get it right you'll be cruising.

One last bit of advice: don't forget to go back to the startup set you were using after the install has completed! For most that will be “My Settings” in EM and “Standard Set” in CC. I love getting calls from desperate people who, in obvious pain and agony, tell me “I installed software and now nothing on the Mac works anymore!” In almost every case, they left CC on “Disabled” or EM on “Base.” All it takes is re-activating the primary startup set and you're back in the game.

For CC users, there's another bonus to using this minimal startup set approach. When you return to Standard Set, you may sometimes receive a “Duplicate Items” warning from Conflict Catcher—this is one of CC's best features (see Figure 6).

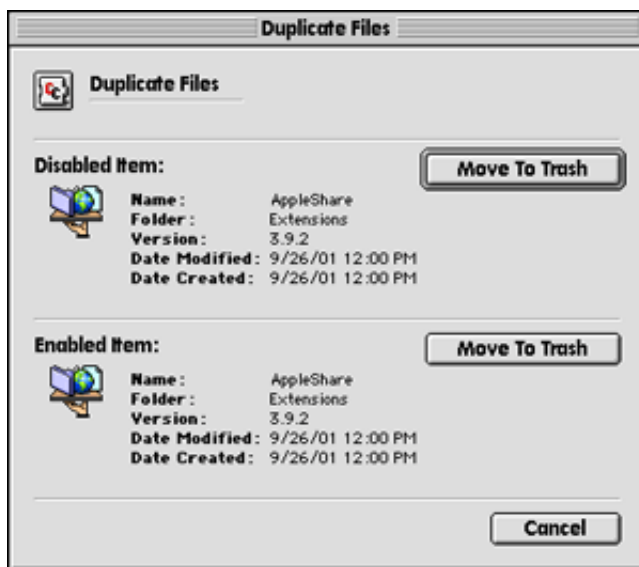

Figure 6: Conflict Catcher has detected two copies of the same extension after restarting back into the “Standard” set. In this case, both items are exactly the same and carry the same version number, but if one of them was older it could be trashed before ever making it into the startup process. Way to go, CC!

What it's trying to tell you is that it has found two items with the same name. One has typically been just installed while the other was disabled before the install. What's cool

about this is that CC displays the *version number* of each item and lets you choose which to keep and which to throw away. Again the results can be startling, as when an installer tries to put in Microsoft libraries that are four years out of date. CC makes sure *nothing* can ever install an older item over a newer one, and that's worth its price right there. (For more info on CC, visit [Casady & Greene](#)¹; they offer a demo version of almost everything they make.)

Odds and Ends

After an install, you may find a folder on your hard drive called "Installer Logs," or you may find a text file called "Installer Log" inside the folder of the newly-installed software itself. In either case, this means the programmers were thoughtful enough to tell you, the user, exactly what was installed and where. I admire this practice, because it lets the user have one more chance to make sure that what was supposed to be installed was installed, and to make sure that other undesired items didn't make it through. Keep these logs around as they can be handy to have in the future.

I never thought I'd say this, but perhaps the best installers I've seen in the last couple of years come from Microsoft. What could be easier to deal with than one folder you simply drag over or throw away? Office 98, 2001, and MS Internet products have all gone to the "drag and drop" method and I think it's great. In addition, they all use an application called "Microsoft First Run" to install needed system resources so that if the user accidentally throws something away that the program needs, it puts the item right back.

The only downside is the uninstall issue. Throwing away the Microsoft application folder in question is easy, but all those libraries stay behind in the Extensions folder. If you ever do want to get rid of every vestige of a Microsoft product, simply go into your Extensions folder and trash every file that starts with the word "Microsoft" or the letters "MS." This goes for the root level of your system folder as well. (This is also a good idea if you are re-installing software, or trying to fix the problem of a particular Microsoft application that is crashing on you.)

1. <http://www.casadyg.com>

Now That You've Learned the Rules, Throw Them Out

I promised we'd end with a (short) discussion of OS X and how it works with installers. And I do mean "short" because there's really not much to think about now. You don't have to restart with the Shift key held down anymore because OS X doesn't use extensions at all. Heck, it doesn't even have a system folder! Everything about X is locked off under glass, where the user can't get to it. This also means that installers have to be far more reliable than they have been, as there is very little now that users can do to control the installation experience other than selecting the items they want installed via "Custom Install."

The only problem you're likely to have is that sometimes you'll be informed that "only the Administrator can make changes." OS X sometimes thinks that installing software is the same thing as changing the system. As it is a "permissions based" system, OS X is simply asking you if this is okay. What you'll wind up doing is clicking the "lock" icon at the bottom left of the dialog, entering your Admin or master password, and clicking the okay button. The installation will then proceed normally.

I have a feeling that in about another year, I'll have a lot more to say about installing software under OS X. So far, the only problems most people have had with X is installing the system software itself. For those who have had problems installing OS X, or need help troubleshooting the process, here is where you can find Apple's official [OS X Troubleshooting Guide](#)².

This document provides general troubleshooting advice for installing Mac OS X and updating your software, and it has links to information on particular installation methods.

If there's an issue or topic I left out, or something you'd like explained further, send me an e-mail and we'll attempt to cover it in a future column. Until then, happy installing!

2. <http://docs.info.apple.com/article.html?artnum=106692>

Copyright © 2002 Ken Gruberman, kgruberman@atpm.com. Ken Gruberman is a member of the Apple Consultants Network and has been writing about the Macintosh since 1989. He has edited The MacValley Voice, the award-winning newsletter of the MacValley Users Group in Southern California, for 11 years and wrote for MacUser magazine for 7 years. Ken lives in Chatsworth, CA.



Cartoon: Hambone

by Mike Flanagan, sensible@sensible.screaming.net



Copyright © 2002 Mike Flanagan, sensible@sensible.screaming.net.



Cartoon: Cortland

by Matt Johnson, <http://www.cornstalker.com>

Cortland

by Matt Johnson



**"I TOLD YOU NOT TO PLAY THAT NEW
CELINE DION CD ON THAT THING."**

Copyright © 2002 Matt Johnson, <http://www.cornstalker.com>.



Extras: Desktop Pictures

[Giverny](#)¹

These photos were taken in the gardens of the Claude Monet Foundation in northern France, in May 2002. They include the Clos Normand, the Water Garden, and Japanese Bridge. The photographer is Forrest Brown of Charlotte, NC. They were scanned on an Epson 1640 XL, and toned with Photoshop 5.5 for Macintosh.

Previous Months' Desktop Pictures

Pictures from previous months are listed in the [desktop pictures archives](#)².

Downloading all the Pictures at Once

iCab and Interarchy (formerly Anarchie) can download an entire set of desktop pictures at once. In iCab, use the Download command to download "Get all files in same path." In Interarchy, use HTTP Mirror feature.

Contributing Your Own Desktop Pictures

If you have a picture, whether a small series or just one fabulous or funny shot, feel free to send it to editor@atpm.com and we'll consider publishing it in next month's issue. Have a regular print but no scanner? Don't worry. E-mail us, and we tell you where to send it so we can scan it for you. Note that we cannot return the original print, so send us a copy.

Placing Desktop Pictures

Mac OS X 10.1.x

Choose "System Preferences..." from the Apple menu and click the Desktop button. With the popup menu, select the desktop pictures folder you want to use.

You can also use the pictures with Mac OS X's built-in screen saver. Choose "System Preferences..." from the Apple menu. Click the screen saver button. Then click on Custom Slide Show in the list of screen savers. If you put the ATPM pictures in your Pictures folder, you're all set. Otherwise, click Configure to tell the screen saver which pictures to use.

Mac OS X 10.0.x

Switch to the Finder. Choose "Preferences..." from the "Finder" menu. Click on the "Select Picture..." button on the right. In the Open Panel, select the desktop picture you want

to use. The panel defaults to your "~/Library/Desktop Pictures" folder. Close the "Finder Preferences" window when you are done.

Mac OS 8.5-9.x

Go to the Appearance control panel. Click on the "Desktop" tab at the top of the window. Press the "Place Picture..." button in the bottom right corner, then select the desired image. By default, it will show you the images in the "Desktop Pictures" subfolder of your "Appearance" folder in the System Folder, however you can select images from anywhere on your hard disk.

After you select the desired image file and press "Choose," a preview will appear in the Appearance window. The "Position Automatically" selection is usually fine. You can play with the settings to see if you like the others better. You will see the result in the little preview screen.

Once you are satisfied with the selection, click on "Set Desktop" in the lower right corner of the window. That's it! Should you ever want to get rid of it, just go to the desktop settings again and press "Remove Picture."

Mac OS 8.0 and 8.1

Go to the "Desktop Patterns" control panel. Click on "Desktop Pictures" in the list on the left of the window, and follow steps similar to the ones above.

Random Desktop Pictures

If you drag a folder of pictures onto the miniature desktop in the Appearance or Desktop Pictures control panel, your Mac will choose one from the folder at random when it starts up.

DeskPicture

An alternative to Mac OS's Appearance control panel is Pierce Software's DeskPicture, [reviewed](#)³ in issue 5.10 and available for [download](#)⁴.



1. <http://www.atpm.com/8.06/giverny/>

2. <http://www.atpm.com/Back/desktop-pictures.shtml>

3. <http://www.atpm.com/5.10/roundup.shtml>

4. <http://www.peircesw.com/DeskPicture.html>

Review: Shareware Roundup

by James McNally & Brooke Smith, bsmith@atpm.com

Weblog Tools

Now that the once geeky pastime of keeping a Weblog has entered the mainstream, the number of tools available has proliferated. This is good news for the budding Web writer. From “push-button publishing” to highly customizable content management systems, the personal publishing scene has exploded and now offers a wide selection of options for starting and maintaining a Web presence. We’ll look at several publishing systems, from the popular classics to the upstart newcomers.

This may be a less than typical shareware roundup, simply because each of the programs is being used by lots of “bloggers,” so there is really no good or bad rating. But before we begin, we’d better try to explain the phenomenon of blogging.

What’s a Weblog?

Basically, a [Weblog](#)¹ (or “blog”) is a Web page that consists of journal-type entries listed chronologically, with the most recent entry at the top. Bloggers publish a wide variety of things: links, news, personal ideas, journal entries, poetry, photos, etc. Really, the list is endless. It’s that personal. We’ve listed several representative blogs in this roundup so you can click on them and see for yourself.

Tools for Blogging

[Blogger](#)²

Creator: Pyra (Evan Williams, Meg Hourihan, Matt Haughey, Paul Bausch)

Example: www.consolationchamps.com³ (James’s blog)

Blogger was the one that started it all. This is great for those who are not tech-savvy, since all the files reside on Blogger’s servers and you don’t have to write any HTML code. It’s also a great way to discover blogging since the service is free (it even offers [free hosting](#)⁴). Blogger automatically publishes your blog, without your having to install any server software or scripts. You simply post to your blog through a form on the Blogger Web site. The post then shows up immediately on your Web site. If you want a few more bells and whistles, try [Blogger Pro](#)⁵. But you have to pay for this one (currently \$35/yr, but eventually will be \$50/yr).

[Greymatter](#)⁶

Creator: Noah Grey

Example: www.luminescent.org⁷

Unlike Blogger, Greymatter is a set of files that are installed on your server (i.e., where your site is hosted). Currently at version 1.2.1C, Greymatter requires an FTP client, full support for Perl 5, and some knowledge of HTML (this is simply to help you customize the templates). This is another free program, but donations are welcome. Greymatter has lots of features, including a built-in comments system, search engine, and karma voting where visitors can rate your entries (however, you control which entries can be voted on).

[Live Journal](#)⁸

Creator: Brad Fitzpatrick

Example: lizvang.livejournal.com⁹

LiveJournal began as a free service to create and host online journals, but is included as a Weblogging tool as the line between journals and Weblogs has blurred. Unique among blogging tools, LiveJournal is an open source project, with contributions made by the members of its user community. You can update your journal using either a Web-based or downloadable client, and journal files reside on LiveJournal’s servers. LiveJournal’s users have created a very tight-knit community around this service.

[Movable Type](#)¹⁰

Creator: Ben and Mena Trott

Example: www.blogwidow.com¹¹ (Brooke’s blog)

Husband and wife team Ben and Mena Trott created Movable Type in Perl simply because they wanted more control over their Weblogs. With Movable Type, your files are stored on your Web hosting server. Among Movable Type’s cool features is the ability to assign multiple categories to blog entries, e.g. on my blog I do a Quote of the Week every Monday, so when I blog my quote I assign it the category, Quote of the Week. There’s also space for an excerpt of your blog entry, should you want to give your readers a preview of a longer piece. Additionally, you can pre-date or post-date entries, let your readers e-mail entries to their friends directly from your site, and import entries from other Weblogging

1. <http://www.atpm.com/7.01/got-blog.shtml>
2. <http://www.blogger.com>
3. <http://www.consolationchamps.com>
4. <http://www.blogspot.com>
5. <http://pro.blogger.com>

6. <http://noahgrey.com/greyssoft>
7. <http://www.luminescent.org/>
8. <http://www.livejournal.com>
9. <http://lizvang.livejournal.com>
10. <http://www.movabletype.org>
11. <http://www.blogwidow.com/>

systems. This last option could be important for people switching an existing blog to Movable Type. Requirements include an FTP client, Perl 5.004_04 on your Web host's server, and the ability to run CGI scripts on your Web account. Currently at version 2.1, Movable Type is free for non-profit use, though donations are gladly accepted.

[pMachine](#)¹

Creator: Rick Ellis

Example: www.saucyspot.com/Weblog.php²

This blog program was written in PHP and runs on any server that has PHP 4 and MySQL installed. With the recent upgrade to version 2.0, pMachine has added 40 new features. Here are just a few:

1. Statistics—visitors to your site can see your stats, for example the number of comments, the number of entries, etc.
2. Collective Weblogs—by creating a collective Weblog, visitors to your site can submit entries, then other visitors can submit entries to those entries, and so on and so on.
3. Curse word censoring—pMachine can censor words contained in a “user-definable library.”

1. <http://www.pmachine.com/>
2. <http://www.saucyspot.com/Weblog.php>

4. pBlocks—these can be used to store info that doesn't change very often, like your Favorite Links or About You sections.

pMachine comes in two flavors. pMachine Free is, as you guessed, free for personal use. pMachine Pro, priced at \$45, adds event calendars, multiple Weblogs, and XML parsing.

...

Each of these tools will attract its share of fans, and the fact that all of them were developed by such small teams of programmers is encouraging. Each of these programs developed out of a need confronted by someone who was actively engaged in publishing to the Web. The programmers all have their own Weblogs, and this personal touch accounts for some of the fierce loyalty fans have toward each particular tool, which consists only of pages of code.

If you are interested in discovering the world of blogging, by all means try out some or all of these tools. Beginners would be wise to try one of the Web-based services first, and as their comfort level increases, migrate to one of the more customizable options. Remember to reward the creators by making a donation. And by all means, whichever tool you choose, make your blog your own.

Copyright © 2002 James McNally & Brooke Smith, bsmith@atpm.com. Reviewing in ATPM is open to anyone. If you're interested, write to us at reviews@atpm.com.



Review: AquaGrep 1.0

by Eric Blair, ebclair@atpm.com

Developer: [publicspace.net](http://www.publicspace.net)¹

Price: \$9.95

Requirements: Mac OS X 10.0.1

Trial: Fully-featured (10 launches)



Thanks to the Unix underpinnings of Mac OS X, Mac users now have access to some powerful Unix utilities that can simplify many tasks. However, many of these utilities are command-line tools that are used via Terminal.app, and a large number of Mac users find the very idea of a command line disgusting. Fortunately, some enterprising developers have thought to put graphical user interfaces on top of these command-line tools.

AquaGrep is one of these graphical “wrappers.” As the name would suggest, it provides a user interface for the `grep` utility. `grep` is a program that allows users to search the content of text files for either a string or a regular expression. Although cryptic, regular expressions can be very powerful things which let you specify different search patterns. For instance, you might use something like `[a-zA-Z0-9]*@[a-zA-Z0-9]*\.[a-zA-Z0-9]*` to search for e-mail addresses.

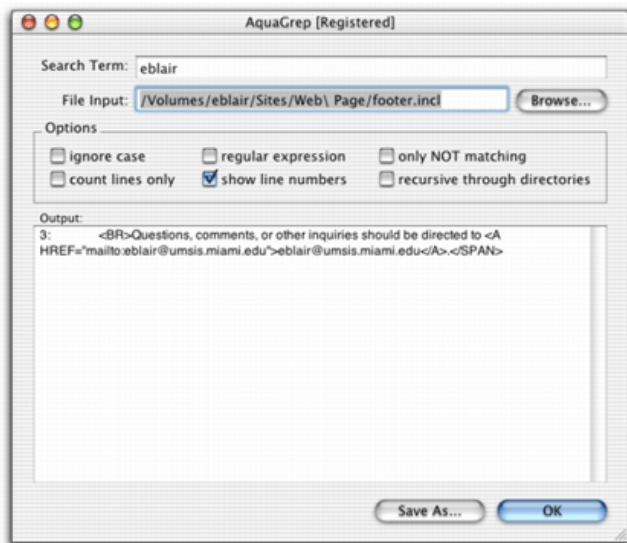

The sequence `[a-zA-Z0-9]` represents any character in the ranges of a–z, A–Z, and 0–9. Using the `*` character indicates that the search should find 0 or more of the specified characters. `\.` signifies the `.` character. There are many other, more complex patterns which can be used for specifying

regular expressions; unfortunately, AquaGrep supplies no documentation going into detail on any of these patterns. This basically eliminates AquaGrep as a utility that `grep` novices can use as a learning tool.

That said, AquaGrep is fairly easy to use. You type your search pattern into the Search Term field and you enter the pathname to a file into the File Input field. You can then specify up to six options using checkboxes: ignore case, use regular expressions, find non-matching items, count the number of matching lines, show the line numbers for the matches, and search directories. Clicking OK runs the search and displays the results in the Output area. If you want, you can save the search results to a text file.

AquaGrep’s ease of use is not a result of good design; it is due to the fact that the program does not really do that much. First, it can only search files or directories. The `grep` utility on the other hand, like other command-line tools, can accept input from another program using the pipes (`|`). For instance, the following commands would let you determine the current issue of ATPM: `curl http://www.atpm.com | grep "Issue [0-9]\.[0-9]*"`. The `curl` command downloads the ATPM homepage from the Web, and the pipe feeds it into the `grep` program. Since AquaGrep only operates on files and folders, you cannot perform operations like this within the program.

User interface glitches in AquaGrep are plentiful. If you resize the AquaGrep window, the Options box does not change size accordingly. If you enlarge the window, the box does not stretch to fill the new area. This is not a big problem. The problem occurs when you shrink the window. This cuts off the right edge of the box and hides the “recursive through directories” option.

Closing the window can cause problems as well. The Close command has been removed from the File menu and the standard Command-W shortcut does not do anything. However, you can still close the window by clicking the close box. This does not quit AquaGrep, though. Furthermore, once a window is closed, there does not appear to be a way to re-open it without quitting and re-launching AquaGrep. There are several ways the developer could get around this

1. <http://www.publicspace.net/AquaGrep/>

issue—making it so that the window does not close, or so that closing the window closes the program are two options that come to mind—but neither of these options were implemented in AquaGrep.

The user interface does not take into account mutually exclusive options. For instance, if “count lines only” is checked as an option, “show line numbers” has no effect. As a result, this checkbox should be disabled; this however does not happen.

User interface errors are not limited to the main window, as there are also a number of errors in the menus. First, the AquaGrep menu says “Hide NewApplication” instead of “Hide AquaGrep.” This error is repeated in the Help menu, where the menu item says “NewApplication Help.” Additionally, instead of displaying help for AquaGrep, choosing the latter menu item displays an error that “Help isn’t available for AquaGrep.” Since there is no documentation, there is really no reason for this menu to be shown in the application. The final menu error, and while a bit of a nit pick it is consistent with the level of AquaGrep’s quality, is a menu separator that was left underneath the final File menu item.

Another, more glaring, problem is how AquaGrep handles spaces in file names. In short, it does not. This is because the Unix shell sees spaces as the end of file names. The solution to this is to either wrap the file name in quotes or to escape the space character with a backslash (‘\ ’). The purpose of a GUI wrapper should be to simplify access to a command-line utility; for this reason, AquaGrep should perform the necessary modifications to a file name to take spaces into account.

Spaces, though, are not the only characters that can cause problems in file names. AquaGrep also does not handle the pipe (‘|’) or semicolon (‘;’) characters. Using a pipe, somebody could send the output from AquaGrep to another program. Not handling the semicolon is a larger problem. This basically allows a user to run any command from AquaGrep. For instance, `~/Readmetxt; cd ~; rm -r *.*` would search the file `Readme.txt`, then attempt to delete the contents of the user’s home directory. A GUI wrapper for a command-line application should take steps to prevent users from running other commands. AquaGrep fails in this regard. The problem is compounded because simply choosing a file with a problematic path from the open panel can cause an arbitrary command to be executed. In this respect, it’s more

dangerous than the command-line, which would either protect the special characters for you (if you use auto-completion) or force you to type the dangerous commands yourself (which it’s hard to do by accident).

Although AquaGrep can search through directories, you cannot select a directory using the Open File dialog. Your only options are to type in the path by hand or to select a file in the directory and then modify the path. One workaround would be to drag and drop a directory onto the AquaGrep window, if AquaGrep supported drag and drop, that is.

One more user interface error that I found in AquaGrep. When you select the About AquaGrep... option, it lists AquaGrep’s price as \$7.95. According to AquaGrep’s [Web site](#)¹, though, it costs \$9.95.

My final gripe about AquaGrep is that it creates a file that contains the text used to call the grep command. I have different copies of this file in both my home directory and my root directory. This is completely unnecessary. If the developer really felt that creating a file was necessary, then at least one of two things should happen. First, AquaGrep should definitely delete the file once it is no longer necessary. Second, the file could be made invisible so it does not create clutter in the Finder.

GUI wrappers are becoming more and more common as Mac users discover the power of the command-line tools included with OS X. Cocoa Dev Central has even run a pair of tutorials (found [here](#)² and [here](#)³) on creating your own wrappers. Furthermore, they are fairly simple to write. For that reason, it is disappointing to see an application like AquaGrep. The user interface is not particularly well designed. It does not take the necessary steps to protect the user from things like spaces in file names. It lets the user run any command-line application, accidentally. When you take into account all the mistakes and annoyances in AquaGrep, it starts to look like the developer threw AquaGrep together over a spare weekend and foisted it on the public. There is no way I can justify spending \$10 on this application.

If you really need a graphical interface for grep sorting, you would be better off checking out [BBEdit Lite](#)⁴. It includes almost all of AquaGrep’s options, adds the ability to replace text, includes an highly acclaimed text editor, and is *free*.

1. <http://www.publicspace.net/AquaGrep/>
2. <http://www.cocoa devcentral.com/tutorials/showpage.php?show=00000017.php>
3. <http://www.cocoa devcentral.com/tutorials/showpage.php?show=00000024.php>
4. http://www.barebones.com/products/bbedit_lite.html

Copyright © 2002 Eric Blair, ebclair@atpm.com. Reviewing in ATPM is open to anyone. If you’re interested, write to us at reviews@atpm.com.



Review: Final Draft 6.0.1.1

by Mike Shields, mshields@atpm.com

Developer: [Final Draft Inc.](http://www.finaldraft.com)¹

Price: \$199.95 (list); \$69 (upgrade)

Requirements: PowerPC-based Mac with Mac OS 8.6 or Mac OS X

Trial: Feature-limited (saving disabled)



Is there ever really a final draft? As most of you know, I write screenplays. Movies, as a rule, are a collaborative medium. Sometimes, things are changed on the set the day of the shoot. Final Draft 6.0.1.1 can't handle your ad-libs, but it does just about everything else.

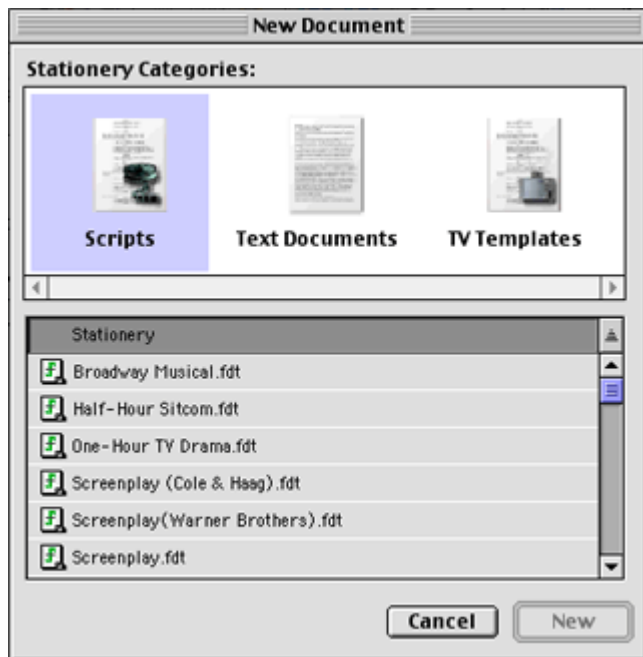

Jack goes behind his desk, and to the middle of his office, and paces.

Katana joins him, matches his stride, and keeps up.

Jack stops for a second, ponders, then turns and resumes pacing. This catches Kate off guard.

KATANA
Why are we pacing?

JACK
You don't have to, this just helps
me think.

KATANA
Oh, *ok.*

I

She resumes pacing in step with Jack.

Why Upgrade?

First, Final Draft has been given a definite 21st century look and feel. It did take a little getting use to, as I was firmly entrenched in version 5's status and Tool Bars. And some of the menu commands were in different places. Otherwise, at first glance, not much has changed.

Of course, this is a good thing, for those of you upgrading from version 5. If you've never seen any version of Final Draft before, the toolbars and menus won't be particularly off putting.

What's New?

Final Draft has been Carbonized for Mac OS X, always a good thing these days, as I believe the G4 iMacs come with Mac OS X as the default. It includes Ask the Expert, which is basically Syd Field's books computerized.



1. <http://www.finaldraft.com>

Also new is ScriptCompare, which allows you to compare two scripts for differences. The Format Assistant checks your scripts to make sure none of the elements are out of place. And for those of you who don't have Acrobat Distiller, the ability to save in Adobe PDF format is a life saver.

```
(Jack breaks the 4th
FADE IN:
EXT. LOS ANGELES NIG
September 1st, 1939.
Roland, therefore, travels to suggest that those poor people
staying home, to listen to their radios. City Hall is all lit
up, like a landing beacon.
A typical September 1939 night.
EXT. DOWNTOWN OFFICE BUILDING - THAT SAME NIGHT
A non-descript, five-story building, significant only because
it contains the office of JACK O. DIAMOND.
INT. FIFTH FLOOR HALLWAY - OUTSIDE DIAMOND'S OFFICE
```

Smart Drag and Drop allows you to drag a bit of dialogue from where you wrote it to somewhere else in the script, and the correct character element is automatically created when the dialogue is dropped. Smart Drag and Drop also recognizes other script elements and behaves correctly and predictably when you drag and drop them anywhere in your script.

The ScriptNote window's default size has been increased for convenience. Also, the ScriptNote Markers can be colored.



New, improved script templates that take advantage of the advanced features of Final Draft 6 are available. These include new television series, improved US and British stageplay templates, and improved screenplay templates.

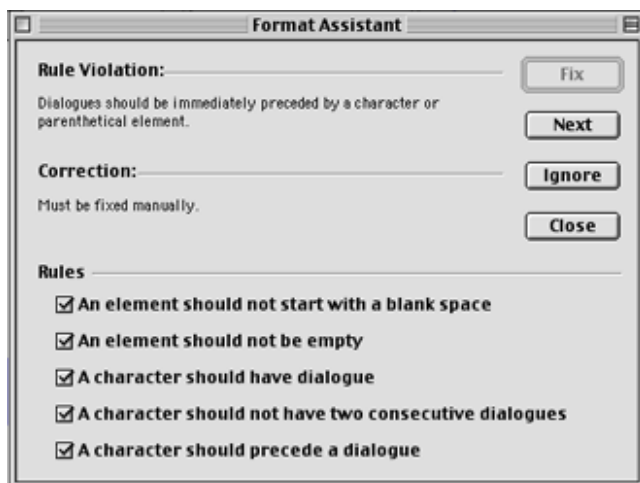

The new, improved Courier Final Draft custom font is darker when printed, and matches exactly across Windows and Macintosh computers, so a script will always look good, regardless of where you print it or read it.

Again, Why Upgrade?

Because you can. For those of you who bought Final Draft when OS X was only on the drawing board, this is a must have. The new features mentioned above are an added bonus, allowing you the time to write. OK, I had a small problem when I changed an element on my own. I was used to version 5's Shift-Tab feature, which has apparently vanished. I also had a small problem with shifting page layouts. My 59 pages would always shrink to 58 when I saved. A quick callup of the Page Layout command under the Document menu, and a click of the options tab later, I'd have my 59 pages back. I'm pretty sure this is something that may be unique to my Mac, but I report it here, as it's annoying. To me. Don't let my problems stop you from taking the plunge.

Conclusion

If you're thinking of writing a screenplay, teleplay, or stage play, you can do worse than Final Draft. Someone suggested that this type of software is useless because you can create a template in something like MS Word. Sure, you can do that, if

you want to take the time and patience it would take to do that. While you're doing that, I'll be completing my current screenplay with Final Draft 6.

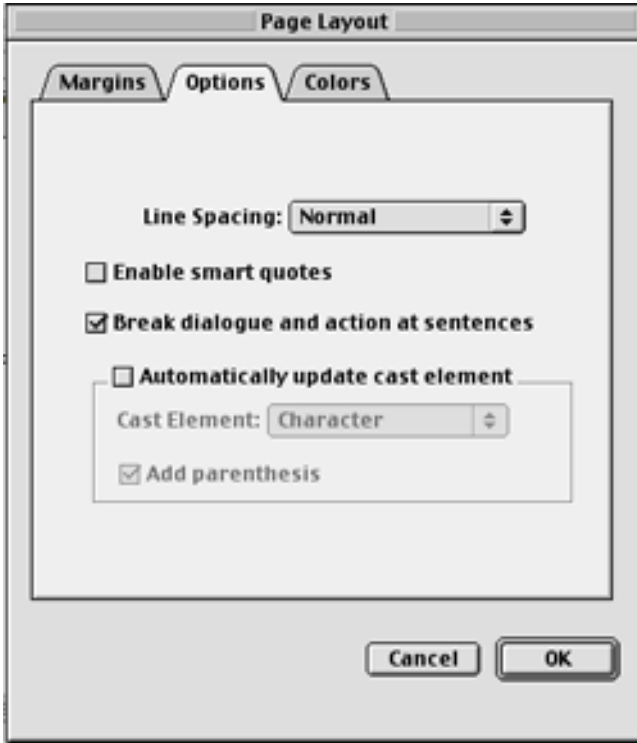

Copyright © 2002 Mike Shields, mshields@atpm.com Reviewing in ATPM is open to anyone. If you're interested, write to us at reviews@atpm.com.



Review: MacLocksmith and QuickEncrypt

by Gregory Tetrault, gtetrault@atpm.com

MacLocksmith 2.4.0

Developer: [Yellow Soft](#)¹

Price: \$10 (single user); \$200 (site license); \$100 (academic site license)

Requirements: System 7 (also works in Classic)

Recommended: PowerPC-based Mac, Internet Config 2.0

Trial: Fully-featured (registration reminders at each launch after first week)



Overview

MacLocksmith replaces files or folders you drag onto its active window with password-protected encrypted files. You can also choose to password protect files without encrypting them.

Installation

Once the downloaded file is decompressed, you are ready to run the application.

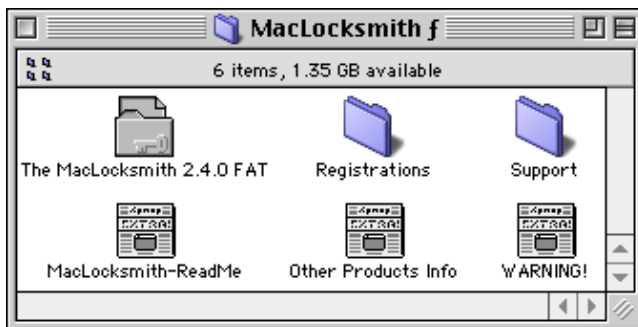

MacLocksmith's Folder Contents

Using MacLocksmith

You use MacLocksmith by launching it and then by either dragging files or folders onto the application's window or by selecting "Open" from the File menu.



MacLocksmith's Application Window



MacLocksmith's Preferences

You need to set your preferences before encrypting files with MacLocksmith. The first major preference is whether to encrypt or simply password protect files and folders. You may set MacLocksmith to ignore invisible files within a folder. The second set of preferences concerns the lock, name lock, and visibility flags of the encrypted file. For example, you can set MacLocksmith to lock the file, lock its name, and make the encrypted file invisible. This would increase your security. The "Scan disk" option should remain unchecked. You really shouldn't use MacLocksmith to encrypt an entire drive. Checking the "Only folder contents" box results in

1. <http://users.iol.it/yellowsoft/maclocksmith.html>

encryption of individual items in a folder instead of encrypting the entire folder with its contents. The last checkbox toggles “Ignore System resources” off and on. Most users will leave this off.

Once your preferences are set, you drag files to be encrypted or decrypted onto the small MacLocksmith window. A password window appears. The one for encryption requires you to type a password twice. Password characters appear in the Symbol font. There is no option to show passwords in plain text or as bullets. Anyone who knows the Greek alphabet can read your password as you type it. The password window contains a checkbox option to use the password for all remaining files (when encrypting or decrypting a folder). You cannot set a permanent password or one that will last an entire session. Your plain file or folder is replaced by the encrypted version (with lock and visibility settings based on your preferences). Your encrypted files are replaced by decrypted files with their original names. MacLocksmith will not automatically move encrypted or decrypted files to designated folders.



MacLocksmith's Password Window

Yellow Soft provides absolutely no information on the encryption method or its bit strength. My suspicion is that the encryption is weak.

Problems, Bugs, and Omissions

The Open window does not support folder aliases. You must navigate to the actual folder. MacLocksmith encodes files before encrypting them, which increases the encryption and decryption times. MacLocksmith will not work in the background, so your Macintosh is tied up until encryption or decryption is completed.

I was very worried by the MacLocksmith method of immediately replacing original files and folders with encrypted versions. The author claims that MacLocksmith preserves your files even during a crash. I did not test that claim, but I think the process is too risky.

Documentation

The application comes with a SimpleText file (about eight printed pages). It gives a brief overview of preference settings and “Cryptets,” and then describes the program in more detail.

Technical Support

No technical support is offered. An [alternate Web site](#)¹ lists some frequently asked questions.

Strengths

- Inexpensive.
- Easy to use.

Weaknesses

- Inflexible.
- No universal password option.
- Password cannot be hidden while typing.
- Immediately overwrites original files and folders or encrypted files and folders.
- Encryption method and strength unknown.
- No technical support.
- No AppleScript support.
- No updates since 1999.
- Launching the main Web site (<http://yellowsoft.tsx.org/>) generates five popup advertising windows, including one with pornographic photographs. This highly unprofessional behavior deserves our scorn.

Summary

MacLocksmith is cheap and easy to use, but I do not recommend it. QuickEncrypt (see review below) is a much better alternative: faster, more flexible, and more secure.

1. <http://www.geocities.com/SiliconValley/Network/7162/faq.html#maclocksmith>

QuickEncrypt 3.2

Developer: [Dejal Systems LLC](http://www.dejal.com)¹

Price: \$25 (60-day money-back guarantee)

Requirements: System 7 (also works in Classic)

Recommended: PowerPC-based Mac, Internet Config 2.0

Trial: Fully-featured (payment reminders at launch)



Overview

QuickEncrypt secures files and folders using a custom-designed 2040-bit encryption technology and passwords of your choosing. It can be customized and automated.

Installation

Installation is simple; once the downloaded file is decompressed, you are ready to run the application.

Using QuickEncrypt

You can use QuickEncrypt by dragging files or folders onto the application's icon. You can also launch QuickEncrypt and access files or archives via the File menu. I recommend launching QuickEncrypt initially to set your preferences and "workset" options.

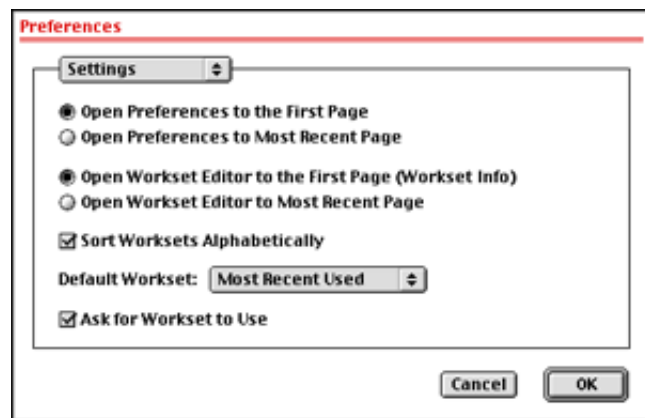

Preferences Window

Worksets let you set and automate encryption and decryption options. You can use the built-in worksets, modify them, or create your own.

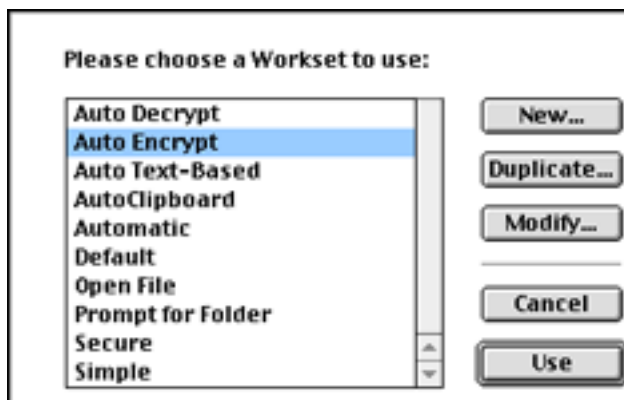

Prebuilt Worksets in QuickEncrypt

There are eleven screens for modifying worksets. In the Workset dialog, you choose a name and optionally a command key for the workset, and add a comment.

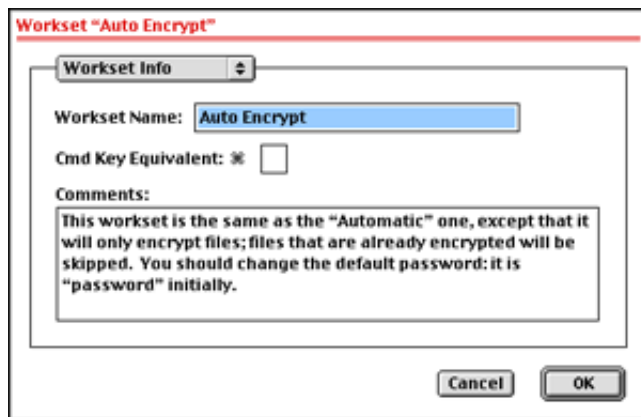

Workset Info Screen

1. <http://www.dejal.com/quick-encrypt/>

Password options deal with optional password requirements and whether or not to use a unique password for each file.

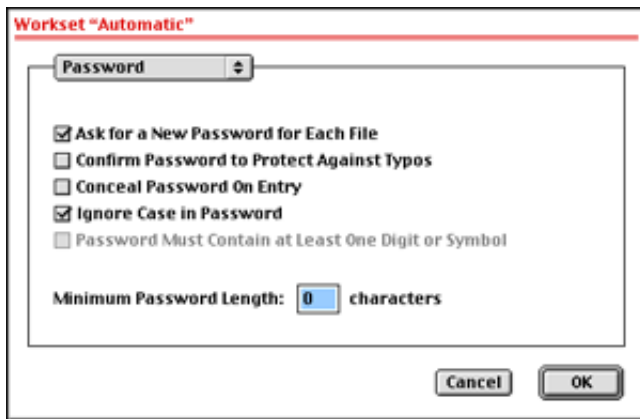

Workset Password Options

The Folders dialog lets you specify what to do if the application is launched directly, and where to place encrypted files. File options include those for handling archives, icons, and subfolder structure. Archive options handle archive naming and subfolder preservation, as well as whether to archive each file separately or archive by folder; and the Archive Window lets you choose between automatically decrypting and displaying the archive window.

Numerous encryption options can be set in the Method dialog. There are two additional Encryption dialogs, the first of which deals with verification, file suffixes, auto-encryption with a fixed password, and whether to encrypt data forks, resource forks, or both. The second Encryption dialog handles post-processing of the source files, and lets you set the creation and modification dates of encrypted files.

The two Decryption dialogs let you select how QuickEncrypt names decrypted files, handles their verification, and sets their creation and modification dates. You can also choose what will happen to the original encrypted files, whether you want to use an auto-decrypt password, and whether the decrypted document or its parent archive will open after decryption.

Although the workset options seem daunting, they are mostly self-explanatory. After you have set the options you prefer, using QuickEncrypt is easy.

Problems, Bugs, and Omissions

I encountered no problems or bugs. QuickEncrypt seems quite complete: the only additional feature I long for is AppleScript support. My main complaint concerns the modal windows for setting preferences or modifying worksets: they cannot be moved and must be closed before you can do anything else with your Macintosh. I would prefer a non-modal Workset modification window with six tabs: Info & Password, Folders & Files, Archives, Method, Encryption, and Decryption. This would be easier to use than the modal window with an eleven-item popup menu.

Documentation

The application comes with a SimpleText file (about ten printed pages), which briefly describes the preferences and Workset options.

Technical Support

No live support is offered; I did not test the e-mail or Web form support options.

Strengths

- Highly customizable to fit your needs.
- Strong encryption algorithm.
- Easy to use once options are set.
- Full support for drag and drop.
- Inexpensive.

Weaknesses

- Skimpy manual.
- Non-standard encryption algorithm may not meet security requirements in some environments.
- No AppleScript support.

Summary

I liked QuickEncrypt. It offers many features, can be configured to meet the needs of nearly any user, and has an uncluttered interface.

Copyright © 2002 Gregory Tetrault, gtetrault@atpm.com. Reviewing in ATPM is open to anyone. If you're interested, write to us at reviews@atpm.com.



Review: MemoryPro 1.0

by Gregory Tetrault, gtetrault@atpm.com

Developer: [Macz Software](http://www.maczsoftware.com)¹

Price: \$10 (shareware)

Requirements: PowerPC-based Mac with Mac OS 8

Trial: Fully-featured (five-second delay at launch)



Overview

MemoryPro is a utility that lets you adjust the memory allocations of multiple applications, even when the applications are running.

Installation

After decompressing the downloaded file, you can place the MemoryPro folder on any mounted volume. MemoryPro does not install any extensions or control panels.

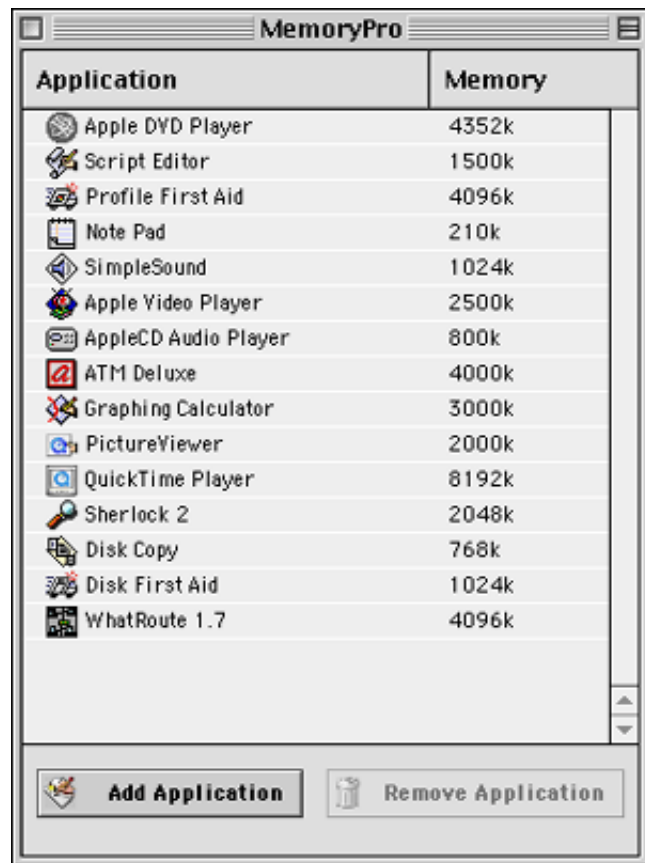

MemoryPro Window

Using MemoryPro

After launching MemoryPro, a window appears with two columns: Application and Memory. Click the Add Application button to create a listing. Use Apple's standard Open File window to locate the application of interest. Repeat this process to add more applications. Applications are listed in the order chosen. There are no options to sort alphabetically or by memory size. Note: MemoryPro launch times increase as you add applications. Launch was very quick with no applications, but required 12 seconds with 37 applications.

After an application is on the list, you can adjust its memory partition by double-clicking its name. A dialog box appears that shows the application's current Preferred Memory setting. Unfortunately, no information about the application's suggested size or minimum size is provided. Type in the desired preferred memory size and click OK to make the change. If you attempt to change the preferred memory to less than the minimum size, an alert appears.



Window for Setting Application's Memory Size

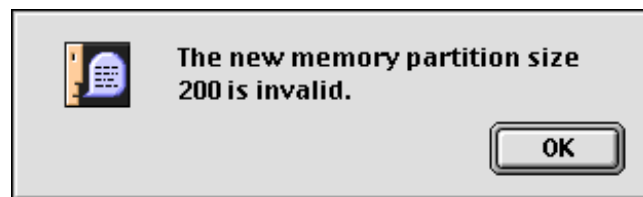

Alert Box for Situations Where Desired Memory Size Is Less Than the Application's Minimum Memory Size

1. <http://www.maczsoftware.com>

Utility of MemoryPro

MemoryPro would best serve a user whose Mac has limited RAM and who uses groups of applications. Before starting applications, a user could launch MemoryPro and adjust preferred memory sizes based on the tasks. For example, a newsletter editor might need to run a word processor, graphics program, and page layout program simultaneously. Memory could be allocated based on projected use.

Problems, Bugs, and Omissions

Macz Software claims that you can use MemoryPro to change an application's memory even while it is open. However, the preferred memory size change does not go into effect immediately. In fact, even after quitting and relaunching the application, the application's memory size was unchanged, according to the information displayed in the About This Computer window.

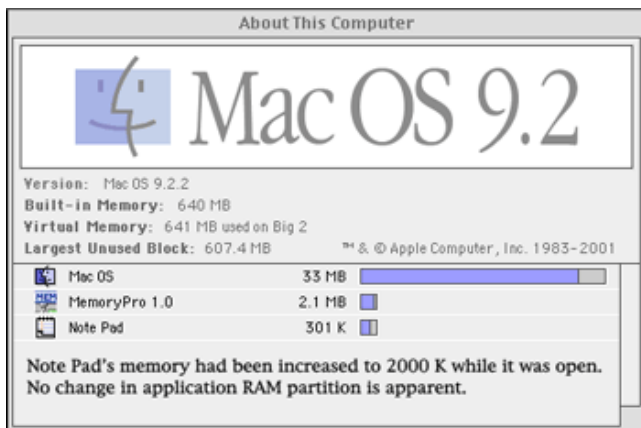

Documentation

The application comes with a brief ReadMe file. No other documentation or help is available.

Technical Support

Macz Software has e-mail and snail mail addresses for feedback. There is no live or online technical support.

Strengths

- Allows you to set preferred memory sizes without going to the Finder and choosing Get Info for each application.

Weaknesses

- No ability to sort or rearrange the application list.
- No application sets or customized preferred memory sets.
- Cannot launch applications from MemoryPro.
- In Mac OS 9.2, memory reallocation requires a restart if the application had been open prior to running MemoryPro.

Alternatives

File management utilities such as [DiskTools](#)¹ from Rainmaker Research allow you to adjust preferred application RAM sizes. DiskTools also lets you create and store sets of applications (similar to MemoryPro). AppleScript-based applets can be used to adjust preferred memory size. A sample script that sets the preferred memory (total partition) size of myApp (an alias to an application) is shown below. Anyone with a little experience with AppleScript could create custom applets that would adjust preferred memory sizes and launch applications. You could also create a droplet that would display an application's minimum and preferred sizes and let you reset them.

```
tell application "Finder"
  activate
  set total partition size of myApp to 800
end tell
```

Summary

MemoryPro may be useful to those running OS 8 or OS 9 on a Macintosh with insufficient RAM to run multiple applications simultaneously. MemoryPro's usefulness is limited because of its inability to create custom lists of applications and preferred memory settings.

1. <http://macinsearch.com/infomac2/disk/disk-tools-333.html>

Copyright © 2002 Gregory Tetrault, gtetrault@atpm.com. Reviewing in ATPM is open to anyone. If you're interested, write to us at reviews@atpm.com.



Review: Web Watch 1.0

by Brooke Smith, bsmith@atpm.com

Developer: [Travis McLeskey](#)¹

Price: \$5

Requirements: Mac OS X

Trial: Nagware (if unregistered, you may sometimes see sponsors' Web sites)



If you love Web sites, this latest screensaver is for you. Travis McLeskey has recently developed Web Watch, a new screensaver program for Mac OS X that pages through Web sites that you select.

Not only a practical screensaver (how many screensavers are truly practical?), Web Watch is very straightforward to install. The instructions are easy to follow.

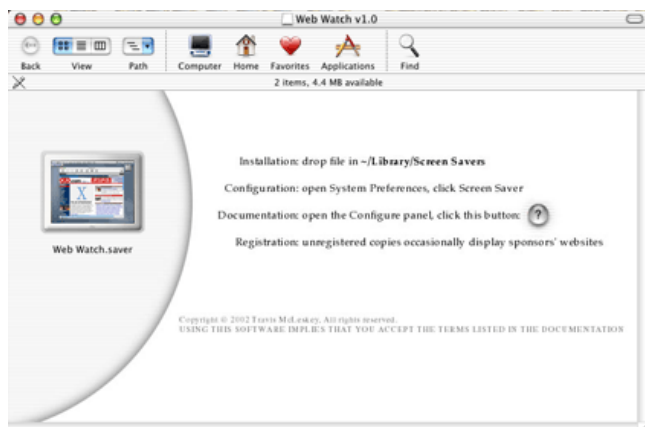

Here's a screen shot of the Web Watch window with the easy-to-follow instructions.

Open up the Web Watch disk image from the desktop and follow the directions from the instructions in the window. Drag and drop Web Watch into the Screen Savers folder inside the Library folder. Go into the System Preferences, click on Screen Savers and then choose the Configure button to start Web Watch. Note: If you need help, click on the question mark under the Configure window. This will take you to the User Guide.

Second, at present, Web Watch works in three browsers: Internet Explorer, Opera and iCab. Although I wasn't able to test the other two browsers, I did not experience any problems with Web Watch in IE.

And third, when Web Watch launches (i.e., the screensaver activates), if a browser window is already open, it won't disturb that window. And, Web Watch only pages through Web sites. You don't get any of those annoying pop-up

windows that sometimes appear when you type in a URL into your browser. You know the ones I mean...locate your old high school classmates, get an interest-free loan, and so on.

How It Works

Web Watch works in the same way as any screensaver. Once you leave your computer for a few minutes, Web Watch will activate and randomly (or in order, depending on what you choose) sift through the Web sites you've selected. (If you want your Web sites to appear randomly, click on the Random Order button. If you deselect this button, the sites will appear in the order listed in the Configure box.)

The Web pages open up in your default browser (in my case, Internet Explorer) one at a time and continue to page through the list of sites every 40 seconds to 5 minutes. Select the Configure button in the screensaver window to choose your preferred time.

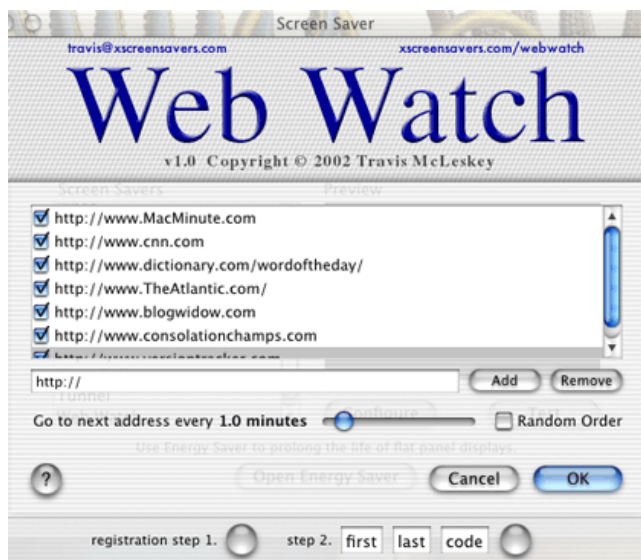

Change your options in the Configure window.

Although Web Watch comes with only five sites pre-installed: MacMinute; Apple Stock info on Yahoo; CNN; Word of the Day; and Slashdot, you can delete some or all of these and add your own, as many as you want! From what I

1. <http://www.xscreensavers.com/webwatch/>

can see, there is no limit. Just click on the Configure button in the screensaver window to make your additions and deletions.

Okay, so you're thinking, it's just another screensaver, right? Not really, because this screensaver is useful. Swimming swans and colorful fractals are nice to look at, but let's face it, they don't really do anything. The neat part about Web Watch is that you can actually get to the Web sites. Suppose CNN is one of your chosen sites and it appears when Web Watch is activated. In passing, you happen to glance at the page and catch a story that you want to read. Easy, just press the space bar so that the CNN Web page remains on your desktop and you can read the article. Note: If you're a blogger (i.e. you keep an online journal or Weblog) you may want to add some of your [favorite blogs](#)¹ to the Web site list.

1. <http://www.atpm.com/8.06/roundup.shtml>

That way, when Web Watch pages through the blogs, you can see who has recently updated, hit the space bar, and read that particular blogger's latest entry.

This option of activating the Web sites is extremely handy for sites that change frequently, like online news services, Weblogs, and stock updates.

Overall, Web Watch is a very useful screensaver. Although there are no bugs known at this time (see the Web Watch homepage), the User Guide does warn that the browser may crash or close the wrong windows. I didn't find any problems with it in my system.

With the next-to-nothing shareware price and sheer usefulness of the program, I would highly recommend you give Web Watch a try. You may never go back to those swimming swans again.

Copyright © 2002 Brooke Smith, bsmith@atpm.com. Reviewing in ATPM is open to anyone. If you're interested, write to us at reviews@atpm.com.



FAQ: Frequently Asked Questions

What Is ATPM?

About This Particular Macintosh (AT^{PM}) is, among other things, a monthly Internet magazine or “e-zine.” AT^{PM} was created to celebrate the personal computing experience. For us this means the most personal of all personal computers—the Apple Macintosh. About This Particular Macintosh is intended to be about your Macintosh, our Macintoshes, and the creative, personal ideas and experiences of everyone who uses a Mac. We hope that we will continue to be faithful to our mission.

Are You Looking for New Staff Members?

We currently need several [Contributing Editors](#) and a [Publicity Manager](#). Please [contact us](#)¹ if you’re interested.

How Can I Subscribe to ATPM?

Visit the [subscriptions page](#)².

Which Format Is Best for Me?



The [Online Webzine](#) edition is for people who want to view AT^{PM} in their Web browser, while connected to the Internet. It provides sharp text, lots of navigation options, and live links to AT^{PM} back issues and other Web pages. You can use Sherlock to [search](#)³ all of the online issues at once.



The [Offline Webzine](#) is a HTML version of AT^{PM} that is formatted for viewing offline and made available in a Stuffit archive to reduce file size. The graphics, content, and navigation elements are the same as with the Online Webzine, but you can view it without being connected to the Internet. It requires a Web browser.



The [Print PDF](#) edition is saved in Adobe Acrobat format. It has a two-column layout with smaller text and higher-resolution graphics that are optimized for printing. It may be viewed online in a browser, or downloaded and viewed in Adobe’s free Acrobat Reader on Macintosh or Windows. PDFs may be magnified to any size and searched with ease.



The [Screen PDF](#) edition is also saved in Adobe Acrobat format. It’s a one-column layout with larger text that’s optimized for reading on-screen. It may be viewed online in a browser, or downloaded and viewed in Adobe’s free Acrobat Reader on Macintosh or Windows. PDFs may be magnified to any size and searched with ease.

What Are Some Tips for Viewing PDFs?

- You can [download](#)⁴ Adobe Acrobat Reader for free. If you have a Power Macintosh, Acrobat Reader 5 has better quality and performance. AT^{PM} is also compatible with Acrobat Reader 3, for those with 680x0 Macs.
- You can zoom the PDF to full window width and scroll through articles simply by single-clicking anywhere in the article text (except underlined links).
- You can quickly navigate between articles using the bookmarks pane at the left of the main viewing window.
- For best results on small screens, be sure to hide the bookmarks pane; that way you’ll be able to see the entire page width at 100%.
- Try turning Font Smoothing on and off in Acrobat Reader’s preferences to see which setting you prefer.
- All blue-underlined links are clickable. Links to external Web sites are reproduced in footnotes at the bottoms of pages, in case you are reading from a printed copy.
- You can hold down option while hovering over a link to see where it will lead.
- For best results, turn off Acrobat’s “Fit to Page” option before printing.

Why Are Some Links Double-Underlined?

In the PDF editions of AT^{PM}, links that are double-underlined lead to other pages in the same PDF. Links that are single-underlined will open in your Web browser.

What If I Get Errors Decoding ATPM?

AT^{PM} and MacFixIt readers have reported problems decoding MacBinary files using early versions of Stuffit Expander 5.x. If you encounter problems decoding AT^{PM}, we recommend upgrading to [Stuffit Expander 5.1.4 or later](#)⁵.

How Can I Submit Cover Art?

We enjoy the opportunity to display new, original cover art every month. We’re also very proud of the people who have come forward to offer us cover art for each issue. If you’re a Macintosh artist and interested in preparing a cover for AT^{PM}, please e-mail us. The way the process works is pretty simple. As soon as we have a topic or theme for the upcoming

1. editor@atpm.com

2. <http://www.atpm.com/subscribe>

3. <http://www.atpm.com/search>

4. <http://www.adobe.com/prodindex/acrobat/readstep.html>

5. <http://www.aladdinsys.com/expander/index.html>

issue we let you know about it. Then, it's up to you. We do not pay for cover art but we are an international publication with a broad readership and we give appropriate credit alongside your work. There's space for an e-mail address and a Web page URL, too. Write to editor@atpm.com for more information.

How Can I Send a Letter to the Editor?

Got a comment about an article that you read in ATPM? Is there something you'd like us to write about in a future issue? We'd love to hear from you. Send your e-mail to editor@atpm.com. We often publish the e-mail that comes our way.

Do You Answer Technical Support Questions?

Of course. Email our Help Department at help@atpm.com.

How Can I Contribute to ATPM?

There are several sections of ATPM to which readers frequently contribute:

Segments: Slices from the Macintosh Life

This is one of our most successful spaces and one of our favorite places. We think of it as kind of the ATPM "guest room." This is where we will publish that sentimental Macintosh story that you promised yourself you would one day write. It's that special place in ATPM that's specifically designated for your stories. We'd really like to hear from you. Several Segments contributors have gone on to become ATPM columnists. Send your stuff to editor@atpm.com.

Hardware and Software Reviews

ATPM publishes hardware and software reviews. However, we do things in a rather unique way. Techno-jargon can be useful to engineers but is not always a help to most Mac users. We like reviews that inform our readers about how a particular piece of hardware or software will help their Macintosh lives. We want them to know what works, how it may help them in their work, and how enthusiastic they are about recommending it to others. If you have a new piece of hardware or software that you'd like to review, contact our reviews editor at reviews@atpm.com for more information.

Shareware Reviews

Most of us have been there; we find that special piece of shareware that significantly improves the quality our Macintosh life and we wonder why the entire world hasn't heard about it. Now here's the chance to tell them! Simply let us know by writing up a short review for our shareware section. Send your reviews to reviews@atpm.com.

Which Products Have You Reviewed?

Check our [reviews index](#)¹ for the complete list.

What is Your Rating Scale?

ATPM uses the following ratings (in order from best to worst): Excellent, Very Nice, Good, Okay, Rotten.

Will You Review My Product?

If you or your company has a product that you'd like to see reviewed, send a copy our way. We're always looking for interesting pieces of software to try out. Contact reviews@atpm.com for shipping information.

Can I Sponsor ATPM?

About This Particular Macintosh is free, and we intend to keep it this way. Our editors and staff are volunteers with "real" jobs who believe in the Macintosh way of computing. We don't make a profit, nor do we plan to. As such, we rely on advertisers to help us pay for our Web site and other expenses. Please consider supporting ATPM by advertising in our issues and on our web site. Contact advertise@atpm.com for more information.

Where Can I Find Back Issues of ATPM?

[Back issues](#)² of ATPM, dating since April 1995, are available in DOCMaker stand-alone format. In addition, all issues since ATPM 2.05 (May 1996) are available in HTML format. You can [search](#)³ all of our back issues.

What If My Question Isn't Answered Above?

We hope by now that you've found what you're looking for (We can't imagine there's something else about ATPM that you'd like to know.). But just in case you've read this far (We appreciate your tenacity.) and still haven't found that little piece of information about ATPM that you came here to find, please feel free to e-mail us at (You guessed it.) editor@atpm.com.



1. <http://www.atpm.com/reviews>
2. <http://www.atpm.com/Back/>
3. <http://www.atpm.com/search>