

***RANGE, PERSISTENCE,
STEALTH, AND
NETWORKING:
THE CASE FOR A
CARRIER-BASED
UNMANNED COMBAT
AIR SYSTEM***

***Thomas P. Ehrhard, PhD
Robert O. Work***

*Thinking
Smarter
About
Defense*



**Center for Strategic
and Budgetary
Assessments**

CSBA

CSBAonline.org

Range, Persistence, Stealth, and Networking: The Case for a Carrier-Based Unmanned Combat Air System

Thomas P. Ehrhard, PhD

Robert O. Work

2008

ABOUT THE CENTER FOR STRATEGIC AND BUDGETARY ASSESSMENTS

The Center for Strategic and Budgetary Assessments is an independent, non-partisan policy research institute established to promote innovative thinking and debate about national security strategy and investment options. CSBA's goal is to enable policymakers to make informed decisions in matters of strategy, security policy, and resource allocation.

CSBA provides timely, impartial and insightful analyses to senior decision makers in the executive and legislative branches, as well as to the media and the broader national security establishment. CSBA encourages thoughtful participation in the development of national security strategy and policy, and in the allocation of scarce human and capital resources. CSBA's analysis and outreach focuses on key questions related to existing and emerging threats to US national security. Meeting these challenges will require transforming the national security establishment, and we are devoted to helping achieve this end.

CSBA is directed by Dr. Andrew F. Krepinevich and funded by foundation, corporate and individual grants and contributions, and government contracts.

1667 K Street, NW
Suite 900
Washington, DC 20006
(202) 331-7990
<http://www.CSBAonline.org>

Contents

Foreword	1
Executive Summary	3
I. Introduction	9
Why a Carrier-Based UCAS?	11
Report Organization	12
II. The US Navy and Unmanned Aircraft: An Uneasy Match	15
Unmanned Aircraft Defined	15
What's the Big Deal?	17
Making a DASH into a New Domain	19
<i>A Respite After DASH</i>	20
<i>A Naval Pioneer</i>	23
<i>Tentative Next Steps</i>	24
<i>Fire Scout and BAMS</i>	25
UCAS-D: A Significant Next Step.....	27
III. Aircraft Carriers Ascendant	29
The Carrier Revolution	29
A Flash in the Pan?	32
Forming the Core of the US Strike Fleet	34
A Decided US Advantage in Sea-Based Airpower	37
Why Change While Still on Top?	42
IV. Carrier Air Wings: Learning to Live with a Lack of Reach	45
A Focus on (Short-range) Power-Projection.....	45
Dealing with an Inherent Range Disadvantage	47
An Increasing Demand for Range.....	48
A New Demand for Longer Range.....	51
A Disappearing Demand for Carrier Heavy Attack	54
A Changing Relationship Between Size and Range	56
Locking In.....	59
Déjà Vu	61

V.	Confronting the Soviets: Taking a Knife to a Gunfight.....	63
	The Early Soviet Anti-Access Strategy	64
	Improvements to the Soviet Submarine Fleet	67
	Improvements to Soviet Long-Range Aviation Forces.....	70
	The Rise of the Soviet Maritime Reconnaissance-Strike Complex.....	73
	A Technical Knockout for US Carrier Forces?	77
	Surviving the Count.....	79
	A Changing US Fight Strategy	79
	<i>Going on the Offensive.....</i>	80
	<i>Getting Inside the Enemy's Reach</i>	81
	<i>Developing Increased Reach</i>	82
	<i>Keeping the Guard Up.....</i>	83
	Winning the Outer Air Battle.....	86
	Would the <i>Maritime Strategy</i> and the Outer Air Battle Have Worked?.....	89
VI.	The 1990s: Shortening the Reach	91
	A Perfect Storm	91
	Plans to Regain Reach (and Stealth)	92
	<i>Temporary Measures</i>	93
	A New Planning Focus: Regional Adversaries	96
	A Shift Toward Guided Weapon Battle Networks.....	97
	Increasing Sortie Generation	99
	A Powerful Close-In Fighter	100
	Past as Prologue?.....	101
VII.	Rumblings of Change	103
	Early Campaigns in the "Global War on Terror"	103
	<i>Operation Enduring Freedom (OEF)</i>	103
	<i>Operation Iraqi Freedom (OIF)</i>	107
	<i>Implications for Carrier Aviation</i>	109
	A New Global Military Posture	114
	The 2005 <i>National Defense Strategy</i>	116
	A Disruptive Innovation Makes its Mark.....	117
	<i>UCASs: Stirring Both Air Force and Navy Interest.....</i>	118
	<i>Enter the J-UCAS Program.....</i>	122
	<i>Changing the Size-Range Relationship.....</i>	123
	<i>A Step Increase in Persistence</i>	125
	<i>A Step Increase in Stealth</i>	126
	<i>A Knack for Networking.....</i>	127
	A New Direction?.....	128

VIII. Charting a New Way Forward	129
Defending the Homeland in Depth	130
Fighting the Long War against Radical Extremists and Defeating Their Terrorist Networks.....	132
Operating in a Proliferated World	134
Shaping the Choices of Countries at Strategic Crossroads (AKA, Hedging Against a Rising China)	136
The Common Denominators: Range, Persistence, Stealth, and Networking.....	139
On or Off Track?	142
Toward a Global Surveillance-Strike Network	145
IX. N-UCAS: A Potential Game-Changing Advance in Carrier Air Wing Range, Persistence, Stealth, and Networking	147
N-UCAS and Homeland Defense in Depth.....	149
N-UCAS in the Long War	152
N-UCAS in a Proliferated World.....	157
Shaping the Choices of China—A Country at a Strategic Crossroads	159
X. The Rise of a Chinese Maritime Reconnaissance-Strike Complex	161
An Economic Powerhouse.....	161
The “Prosperous Nation, Strong Military” Model	162
Evolving Chinese Military Thought.....	163
<i>Impact of Operation Desert Storm on Chinese Military Thinking</i>	<i>164</i>
<i>“Defeating a Superior with an Inferior”.....</i>	<i>165</i>
<i>“Key-Point Strikes”</i>	<i>166</i>
Buying “Assassin’s Mace” Capabilities	166
US Aircraft Carriers as “Key-Point Targets”.....	169
Learning from the Soviets	170
A New Anti-Carrier Attack System: Anti-ship Ballistic Missiles	173
<i>The Business End of a TBM Maritime Strike System ..</i>	<i>176</i>
Building the ISR Backbone for a Maritime Reconnaissance-strike Complex	179
Sharpening the Claws of the PRC Submarine Fleet.....	182
Sharpening the Claws of the PRC Maritime Aviation Strike Forces	189
The Inner Zone Defenders: Short-range ASBMs, SAGs, and Coastal ASCMs	193
A Time to Prepare	195

XI. Winning the“Outer Network Battle”.....	197
A Formidable Opponent	197
A Return to the <i>Maritime Strategy</i> ?	201
<i>Too Close for Comfort</i>	201
<i>Improving Naval Battle Network Defenses: CEC</i>	202
<i>The Next Step: NIFC-CA</i>	204
<i>Taking on the ASBMs</i>	208
A New Fight Strategy: Fighting from Range	211
Fighting the Outer Network Battle	217
Toward a Global Surveillance-Strike Network	222
XII. Preventing a Missed Opportunity.....	227
The Navy Moves Out.....	227
A Conservative Approach	229
A Step Forward or a Step Back?.....	232
What’s the Problem?.....	233
At a Competitive Disadvantage?.....	235
The Role of Congress and OSD	237
N-UCAS: A New Revolution in Carrier Aviation?	242
Glossary	245

Foreword

Ever since Thucydides recorded the dramatic fall of Athens' vaunted navy at Syracuse in 413 BC, naval warfare has been marked by abrupt competitive shifts. Intense geopolitical and maritime rivalries between well-financed seafaring nations, the emergence of new operational challenges for established naval powers, and the novel incorporation of advanced technologies in naval weapons and ship designs have all repeatedly spurred transformations that have redefined naval warfare. These transformations have inevitably caused sharp changes to the ships and weapons thought to be most decisive in naval combat. In the process, established hierarchies of naval powers have been re-ordered, with clear winners and losers. The most successful naval competitors have generally been those best able to recognize, anticipate, or hedge against impending changes in naval warfare, or those that actively seek change to better their competitive position.

One need look no further than the US Navy to understand how abrupt these competitive transitions can be. In the relatively short period between the Japanese attack on "battleship row" at Pearl Harbor in December 1941 and the decisive American naval victory at the Battle of Midway six months later, the aircraft carrier and its air wing quickly replaced the battleship as the capital ship of the US battle fleet. During the subsequent advance across the Pacific toward Japan, and informed by nearly two decades of intense experimentation and development, aircraft carriers sparked changes to both the organization of the Navy and the way it fought. Indeed, the Navy's enthusiastic wartime embrace of carrier-based airpower and its rapid rise to the top of the global naval competitive hierarchy were inextricably linked, assuring that carriers would stay atop the US naval pecking order after the war.

Today, nearly seven decades later, US aircraft carriers with their large, multi-mission air wings remain the most powerful surface combatants afloat, and are among the United States' premier power-projection

systems. As the nucleus of powerful Carrier Strike Groups (CSGs)—which also include several missile-armed surface escorts and logistics ships, as well as nuclear-powered attack and cruise missile submarines, land-based maritime patrol aircraft, and additional surface combatants and logistic ships operating in direct support—aircraft carriers epitomize America’s global reach and raw military power. It is therefore in the Navy’s best interest to maintain and enhance the combat capabilities of these important fleet assets.

Achieving this objective may be quite difficult. The premise of this paper is that the US Navy is faced with an impending competitive shift that will demand that it rethink and reconsider some of the lessons learned during the past six-and-a-half decades when “carrier warfare” so defined US naval operations and thinking. Failing to do so, and failing to adapt the carrier and its air wing to cope with the emerging strategic environment and its associated operational challenges, will likely put the Navy, its carrier force, and the nation at a competitive disadvantage in the coming decades.

Executive Summary

The 2006 Quadrennial Defense Review (QDR) identified four key national security challenges of the early 21st century. These four challenges are: defending the homeland in depth; fighting the Long War against radical extremists and defeating terrorist networks; preventing state and non-state actors from acquiring or using weapons of mass destruction; and hedging against the rise of a power or powers capable of competing with the United States militarily.

After a thorough assessment of the current program of record, the Secretary of Defense concluded that these emerging challenges would demand future joint air platforms with **greater range** (independent reach), **greater persistence** (ability to loiter over the target area), **improved stealth** (ability to survive in contested airspace), and **improved networking** (ability to operate as part of a joint multidimensional network). Consistent with this thinking, the final *Report of the 2006 QDR* directed the Department of the Navy (DoN) to “develop an unmanned longer-range carrier-based aircraft capable of being air-refueled to provide greater standoff capability, to expand payload and launch options, and to increase naval reach and persistence.” In other words, the Secretary of Defense directed the Navy to field a low-observable **unmanned combat air system (UCAS)** that is capable of operating safely off of a carrier deck, and over longer combat ranges than contemporary manned carrier-based aircraft.

The logic supporting accelerated development of a longer-range, carrier-based UCAS is straight-forward. Using manned aircraft, current carrier air wings are best suited for striking targets at ranges between 200 and 450 nautical miles (nm) from their carriers. At the same time, due primarily to the limits of aircrew endurance, these aircraft lack persistence. That is to say, they are generally limited to missions no more than ten hours long, and they more typically fly missions that last only a few hours. Therefore, US carrier air wings can maintain a

persistent 24-hour-a-day presence over the battlefield only by massing several carriers. However, emerging national security challenges—including defending the homeland in depth, defeating global terrorist networks, operating in a world with more nuclear-armed regional powers, and hedging against the appearance of new anti-access/area-denial networks—will likely require future carrier task forces to stand off and fight from far greater distances than in the past, and to maintain a far more persistent presence over future battlefields. Moreover, when under constant threat of guided weapons attack, carriers will need to operate dispersed and mass their aircraft over targets from widely distributed operating areas. Under these circumstances, a carrier-based UCAS with an unrefueled combat radius of 1,500 nm or more and unconstrained by pilot physiology offers a significant boost in carrier combat capability. Indeed, with aerial refueling, a UCAS would be able to stay airborne for 50 to 100 hours—five to ten times longer than a manned aircraft. With multiple aerial refuelings, a UCAS could establish persistent surveillance-strike combat air patrols at ranges well beyond 3,000 nm, and could strike fixed targets at even longer ranges. Such extended reach and persistence would allow a dispersed aircraft carrier force to exert combat power over an enormous area.

For example, a carrier at Pearl Harbor ordered to respond to a developing crisis in the Taiwan Strait could immediately set sail and launch a flight of UCASs (see figure next page). Given a 450-knot cruising speed and two aerial refuelings, these aircraft would arrive over the Strait (a distance of approximately 4,440 nm) in just over ten hours. Furthermore, the aircraft could persist over the Strait, even in the face of advanced Chinese air defense systems, for over six hours before requiring another aerial refueling. By launching and recovering successive flights of UCASs, a UCAS-equipped carrier could maintain a persistent presence over the Strait days prior to current carriers, and increase the density of its coverage as it closed the range—all without risking any aircrew. The strategic value of this sort of responsiveness and reach is incalculable.

A key first step toward a carrier-based unmanned combat air system was taken on August 2, 2007, when the US Navy awarded Northrop Grumman Corporation a \$636 million contract to plan and execute an ***Unmanned Combat Air System Carrier Demonstration (UCAS-D)*** program to prove that an unmanned aircraft can be seamlessly integrated into aircraft carrier flight deck and airspace

Distances in the Pacific

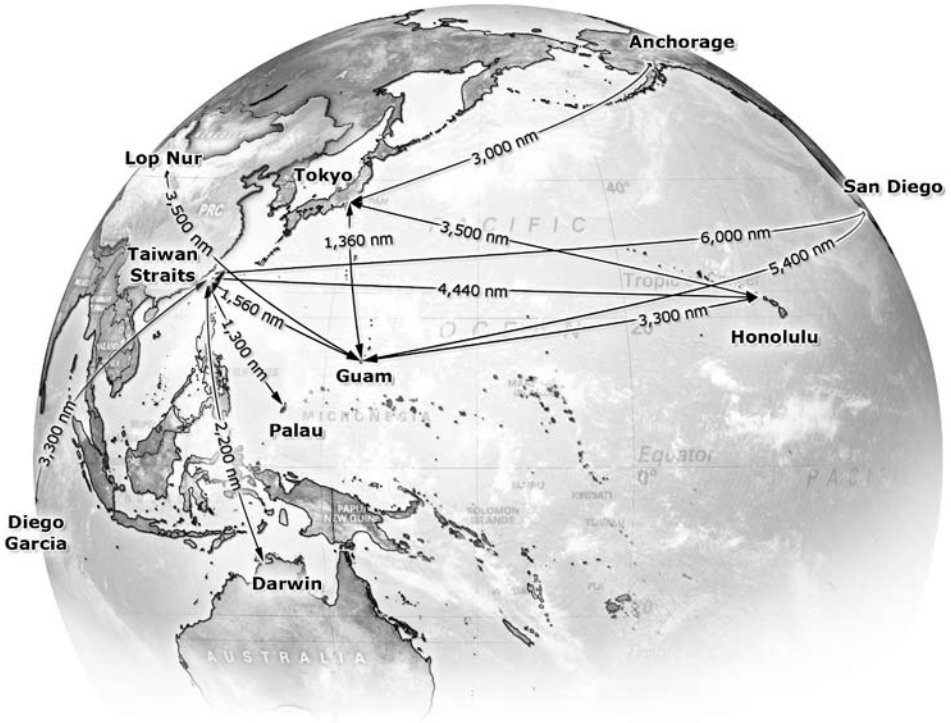

operations. Put another way, the Navy asked Northrop Grumman to demonstrate that a UCAS can be safely and effectively incorporated into the complex and dangerous ballet associated with operating 70 or more high-performance aircraft and rotorcraft from a cramped, 4.5-acre airfield moving across the open ocean. The Navy also allocated money to fund a supporting technology maturation program to more fully develop the technology and operating techniques necessary to field a follow-on operational naval UCAS (N-UCAS).

Despite these welcome steps, the current demonstration and technology maturation programs for carrier-based unmanned aircraft are far less ambitious than earlier Navy plans. Indeed, the Navy's conservative approach toward N-UCAS suggests that the carrier community is reticent to fully embrace the new system. This reticence

is perhaps understandable. The carrier flight deck is arguably one of the most dangerous workplaces in the world, and the job of spotting, fueling, arming, launching, and recovering aircraft is a complex process requiring close teamwork and timing. As a result, many carrier aviators remain highly skeptical that unmanned air systems can be safely integrated into carrier operations, and insist that they “earn their way” aboard the ship. To many Navy carrier aviators, a simple naval UCAS demonstration focused on carrier flight deck and flight operations, followed by a slower, more deliberate development of unmanned air combat systems, is the prudent, safe way to go.

This rather timid, less-than-certain development approach stands in stark contrast to the period between the two World Wars, when the Navy aggressively worked to integrate aircraft into naval operations. At that time, the prevailing attitude seemed to be to prove why aircraft should *not* be taken to sea and incorporated into fleet operations. There was never any doubt in the minds of naval officers that aircraft would improve fleet operations in important ways. The only debate was over the best way to leverage the airplane’s new capabilities. Figuring out how to operate airplanes safely off of a heaving deck at sea was an important consideration, but one pursued with dogged determination and a willingness to take risks, since the payoff was deemed to be worth it. As a result, there was no talk about aircraft having to “earn their way” into fleet operations. Indeed, the Navy’s relentless determination to integrate airplanes into battle fleet tactics was never discouraged by the lack of proper ships, tactics, techniques, procedures, or even capable airplanes. The end result was no less than a revolution in naval warfare. One has to wonder why the mere hint of a system with great improvements in range, persistence, stealth, and networking like the N-UCAS is not enough to spur calls for a far more aggressive program designed to spark a new revolution in naval warfare.

One likely answer to this question is that the N-UCAS represents a disruptive technology that threatens the current order of things in the Navy’s tight-knit carrier aviation community. When combined with the Navy’s historical ambivalence toward unmanned aircraft systems, this means there are few DoN champions for such a system. As a result, the UCAS-D program is in constant danger of becoming a victim of what Jim Thomas, a former Deputy Assistant Secretary of Defense for Strategy, refers to as “defense infanticide”—where established programs continually draw off the funds necessary to sustain new systems and eventually kill them. For example, the UCAS-D program fared quite

poorly in the Fiscal Year (FY) 2007 budget deliberations: the Senate Appropriations Committee (Defense) (SAC-D) zeroed the Navy's \$239 million budget request, while the House Appropriations Committee (Defense) (HAC-D) cut the program by \$50 million. Although the conference subsequently funded the program at \$100 million, the resulting \$139 million cut in program funds caused a reorientation of the entire demonstration program. As a result of the cuts, the target date for carrier demonstrations was pushed back from 2011 to 2013, and the start of a follow-on systems development and demonstration program was delayed until 2014. This inevitably set back the planned initial operational capability (IOC) for an operational N-UCAS to sometime well after the original target date of FY 2015.

The program fared much better in the FY 2008 budget cycle, with both the Senate and House endorsing full funding of the Navy's UCAS-D request. However, given the other competing requirements facing Navy planners, how hard will carrier aviators fight for the UCAS-D program in the future if DoN aviation budgets are less than expected, or if they are faced with a choice of funding either the UCAS-D or another competing priority? If history is any guide, given the inattention to and lack of interest in unmanned systems within the carrier aviation community, the answer to this question is not likely to be encouraging. This seems especially true given that the newly published *Naval Aviation Plan 2030* folds the N-UCAS program into a sixth-generation strike-fighter (F/A-XX) program, and slips this new program even further into the future (around 2025). Moreover, with "manned/unmanned decision points" built into the new F/A-XX program, it is not even certain that an unmanned air combat system will survive. This may make it easier to shift funds from the UCAS-D program in the face of sharp budget pressures over the next several years.

This should not be allowed to happen. UCAS-D is the only program that will provide the Navy's future carrier air wings with the *organic*, extended-range, survivable, and persistent surveillance-strike capability needed to meet a number of emerging 21st century security challenges. Successful UCAS demonstration and technology maturation programs that lead to an operational carrier-based UCAS will thus help solidify the carrier's important role in US foreign policy and military operations, and extend its operational effectiveness well into the future. Additional delays or cancellation of the UCAS-D program, or reductions to technology maturation funding, might well put at risk the long-term operational and tactical effectiveness of the US carrier fleet.

Accordingly, Office of the Secretary of Defense (OSD) and Congress should take a direct interest in fostering the UCAS-D program and monitoring its progress. At a minimum, they should provide the funding necessary to keep the demonstration and technology maturation programs on track. They might also consider increasing funding for the technology maturation effort to expand the range of missions for an operational N-UCAS, and “buying back” the two-year slip in the demonstration program caused by the FY 2007 budget cuts and accelerating its systems development/acquisition phase. If they do, the chances will increase that the Navy will be able to transform the aircraft carrier and its air wing from a power-projection system with outstanding global mobility but relatively limited tactical reach, into a key component of a persistent, global, surveillance-strike network. In conjunction with the development of other joint military capabilities, such as Air Force long-range strike systems and a global intelligence, surveillance, and reconnaissance network, such a flexible surveillance-strike network will help the United States maintain a strong military advantage over future adversaries.

I. Introduction

As required by Congress, the Department of Defense (DoD) conducts a thorough review of US defense strategy, plans, and programs every four years. Among other things, these so-called Quadrennial Defense Reviews (QDRs) are intended to survey the emerging strategic environment, assess whether or not the DoD program of record is capable of meeting likely threats, make judgments about required new force capabilities and capacities, and order adjustments to the program of record, as necessary.¹

The final report of the most recent QDR was published in February 2006. It identified four key national security challenges of the early 21st century. These challenges are: defending the homeland in depth; fighting the Long War against radical extremists and defeating terrorist networks; preventing state and non-state actors from acquiring or using weapons of mass destruction (WMD); and shaping the choices of countries at strategic crossroads, particularly the People's Republic of China (PRC).²

¹ The Fiscal Year (FY) 1994 Defense Authorization Act established a Commission on Roles and Missions to evaluate the assignment of military roles and responsibilities in the post-Cold War world. In its final report, the Commission suggested a need to conduct a review of Department of Defense strategy every four years, coinciding with the transition between administrations. Congress concurred with this suggestion, mandating in the National Defense Authorization Act of 1997 that each new administration conduct a thorough strategic and defense program review. The first so-called "Quadrennial Defense Review" was completed by the second Clinton Administration in May 1997. The second QDR, completed in September 2001, represented the pre-9/11 thinking of the first George W. Bush Administration. See "Military Force Structure Review Act of 1996," accessed online at <http://www.comw.org/qdr/backgrd.html> on June 21, 2006.

² *Quadrennial Defense Review Report* (Washington, DC: Office of the Secretary of Defense, February 6, 2006), pp. 19–40. The entire report, which will be referred to hereafter as the *2006 QDR Report*, can be accessed online at <http://www.defenselink.mil/qdr/report/Report20060203.pdf>.

After carefully comparing the new capabilities demanded by these four strategic challenges with the capabilities found in DoD's program of record, then-Secretary of Defense Donald Rumsfeld ordered that several changes be made to existing plans. For example, after analyzing Service aviation plans and programs, the Secretary concluded that future joint air capabilities needed to be reoriented to favor "systems that have far greater range and persistence; larger and more flexible payloads for surveillance or strike; and the ability to penetrate and sustain operations in denied areas."³

Consistent with this key judgment, the Secretary directed the Department of the Navy (DoN) to "develop an unmanned longer-range carrier-based aircraft capable of being air-refueled to provide greater standoff capability, to expand payload and launch options, and to increase naval reach and persistence."⁴ In current vernacular, the Secretary of Defense ordered the Navy to field a stealthy, **unmanned combat air system (UCAS)** that could operate from an aircraft carrier and over longer combat ranges than contemporary manned carrier-based aircraft.⁵

The Navy moved promptly to comply with the Secretary's direction. On August 2, 2007, after evaluating two different proposals from Northrop Grumman Corporation (NGC) and Boeing Integrated Defense Systems, the Navy awarded Northrop Grumman Corporation a \$636 million contract to plan and execute an **Unmanned Combat Air System Carrier Demonstration (UCAS-D)** program. The purpose of the program is to demonstrate that an unmanned aircraft can be seamlessly integrated into aircraft carrier flight deck and airspace operations.⁶ Put another way, the Navy asked Northrop Grumman to demonstrate that a UCAS can be safely and effectively incorporated into the complex and dangerous ballet associated with operating 70 or more

³ Ibid., p. 45.

⁴ Ibid., p. 46.

⁵ For the purposes of this report, *long-range* strikes occur over ranges of 3,000 nautical miles (nm) or more. *Short-range* strikes, by comparison, are attacks against targets out to 1,000 nm. The *medium-range* strike envelope is between 1,500 and 2,500 nm. This is a modification of the convention developed by Barry D. Watts in *Long Range Strike: Imperatives, Urgency, and Options* (Washington, DC: Center for Strategic and Budgetary Assessments, 2005).

⁶ Michael Bruno, "Northrop Wins UCAS-D Effort Worth \$635m," *Aviation WeekOnline*, AerospaceDaily&DefenseReport, August 2, 2007, accessed online at http://www.aviationweek.com/aw/generic/story_channel.jsp?channel=defense&id=news/UCASo8027.xml on August 4, 2007.

high-performance aircraft and rotorcraft from a cramped, 4.5-acre airfield moving across the open ocean. The Navy also allocated funds for a supporting technology maturation program to more fully develop the technologies and operating techniques necessary to field a follow-on operational naval UCAS, or N-UCAS.⁷

WHY A CARRIER-BASED UCAS?

Beyond the general principle that future joint air platforms must have far greater range and persistence, larger and more flexible surveillance and strike payloads, and the ability to penetrate and sustain operations in denied areas, neither the 2006 QDR Report nor the Navy's subsequent UCAS-D contract award offer any particular insight on why the Navy's carrier force would benefit from future air platforms with greater range, persistence, and stealth. They also do not fully explain why unmanned aircraft have the best chance of providing future carrier air wings (CVWs) with these improved capabilities.

This report aims to provide such insight. As argued in the following pages, a longer-range, air-refuelable, stealthy, unmanned carrier-based aircraft will likely help to transform the aircraft carrier and its air wing from a power-projection system with outstanding global mobility but relatively limited tactical reach and persistence into a key component of a global surveillance-strike network. This transformation is demanded by the full range of emerging 21st century security challenges outlined above. In addition, this report will explain how such a system will help the Navy to close several of the key joint capability gaps identified in the 2006 QDR—among them a general lack of penetrating and persistent intelligence, surveillance, and reconnaissance (ISR) platforms and stealthy, long-range strike systems. It will also suggest how the development of an unmanned, long-range, stealthy, air-refuelable carrier aircraft will help to deter and dissuade future adversaries.

Implicit in all of these arguments is the proposition that the Navy needs to seriously reconsider the lessons of the past six decades of carrier warfare. Specifically, a carrier air wing best suited for short-range,

⁷ Originally referred to as UCAS-N, the Navy now refers to the operational system as N-UCAS. See Rear Admiral Mark Fitzgerald, quoted in Lorenzo Cortes, "Tomcat Transition to Super Hornet Complete by Fall '06, Admiral Says," *Defense Daily*, June 16, 2004, p. 9.

pulsed strikes—a design preference based on the Navy’s post-World War II operational experience—will not likely be well suited for the evolving security environment. Said another way, emerging operational challenges seem surely to demand, among other things, future carrier air wings with dramatically improved levels of **range**, **persistence**, **stealth**, and **networking**. An unmanned combat air system is one way to pursue these needed improvements.

While a longer-range, air-refuelable, unmanned carrier-based aircraft is wholly consistent with the Department of the Navy’s *Sea Power 21* vision, which calls for “tremendous increases in naval reach, precision, and connectivity,”⁸ it will have to overcome a particularly high bar before making its way onto a carrier deck. The Navy is rather ambivalent toward unmanned aircraft in general, and carrier-based unmanned aircraft in particular. As a result, there is widespread sentiment that the UCAS “earn its way” aboard a carrier.⁹ Given the many competing demands in its aviation program, the Navy’s traditionally skeptical view of naval unmanned aerial systems may put the UCAS demonstration and technology maturation programs at risk of being cut, delayed, or even cancelled. If that happens, the chances of getting an operational carrier-based UCAS in the near future will fall precipitously—and the future operational effectiveness and relevance of the US carrier force, and its ability to serve the nation’s interests, may be placed at risk.

REPORT ORGANIZATION

The fundamental goal of this report is to explain how a carrier-based unmanned air combat system may help to transform carrier aviation in the decades ahead. To do so, this paper is organized into ten additional chapters:

- Chapter II, *The US Navy and Unmanned Aircraft: An Uneasy Match*, reviews the Navy’s history with unmanned aircraft, which helps to explain the Service’s general ambivalence toward them.

⁸ Admiral Vern Clark, “Sea Power 21: Projecting Decisive Joint Capabilities,” *Proceedings*, U.S. Naval Institute, October 2002, accessed online at <http://www.usni.org/PROCEEDINGS/ARTICLES02/PROCNO10.HTM> on March 15, 2007.

⁹ Cortes, “Tomcat Transition to Super Hornet Complete by Fall ’06, Admiral Says,” p. 9.

- Chapter III, *Aircraft Carriers Ascendant*, discusses the great US lead in sea-based tactical aviation, as well as its implications for a disruptive technology like an unmanned combat air system.
- Chapters IV through VI describe why and how US carrier air wings came to emphasize relatively short-range strike aircraft. Chapter IV, *Carrier Air Wings: Learning to Live with a Lack of Reach*, reviews the development of carrier aviation through the end of the Vietnam War, and highlights the lack of a consistent operational demand signal for longer-range carrier aircraft. Chapter V, *Confronting the Soviets: Taking a Knife to a Gunfight*, describes the difficulty the US carrier force had in the 1980s when dealing with a Soviet anti-carrier arm that substantially outranged it. Finally, Chapter VI, *The 1990s: Shortening the Reach*, explains the circumstances behind the dramatic reduction in CVW reach that occurred during the 1990s.
- Chapters VII and VIII describe how events since September 11, 2001 suggest that the future carrier air wing requires increased range, persistence, and stealth. Chapter VII, *Rumblings of Change*, discusses the implications of Operations Enduring Freedom and Iraqi Freedom for carrier aviation, as well as those associated with changes to the US global defense posture and defense strategy. Chapter VIII, *Charting a New Way Forward*, describes the aerospace capabilities necessary to tackle the four major security challenges of the first decades of the 21st century, and what this might mean for the US carrier force.
- Chapters IX through XI explain the great revolutionary potential of a carrier-based UCAS. Chapter IX, *N-UCAS: A Potential Game-Changing Advance in Carrier Air Wing Range, Persistence, Stealth, and Networking*, explains how a naval UCAS would help to solve the challenges associated with defending the homeland in depth, fighting the Long War against radical extremists, and dealing with the problem of weapons of mass destruction. Chapter X explains *The Rise of a Chinese Maritime Reconnaissance-Strike Complex*, and its implications for the future US carrier fleet. Chapter XI, *Winning the “Outer Network Battle,”* explains how an extended-range, air-refuelable, unmanned, carrier-based aircraft will help to defeat an ocean reconnaissance-strike network like the one being built by the Chinese.

- Finally, Chapter XII, *Preventing a Missed Opportunity*, explains the steps that the Office of the Secretary of Defense (OSD) and Congress might take to keep the UCAS-D program from being cut, thereby ensuring that this potentially revolutionary system fulfills its great promise.

II. The US Navy and Unmanned Aircraft: An Uneasy Match

The first order of business is to review the history of the Navy and unmanned aircraft. This history shows that launching and operating unmanned aircraft from ships at sea is a particularly difficult challenge, and not something that the Navy has aggressively pursued. As a result, the general notion that the future of carrier aviation will likely be found in longer-range, air-refuelable, unmanned aircraft is, at first glance, both counter-intuitive and surprising.

UNMANNED AIRCRAFT DEFINED

As their name implies, unmanned aircraft, which have at times been referred to as drones, remotely piloted vehicles (RPVs), or unmanned aerial vehicles (UAVs), are robotic, fixed- or rotary-winged aircraft capable of controlled, sustained flight using onboard propulsion and aerodynamic lift, and are designed for return and re-use. An unmanned aircraft's flight can be directed remotely by a human operator located at a distant airborne, shipboard, or ground-based control station, by an autonomous flight control system, or by a hybrid of the two.¹⁰ To reflect the fact that these unmanned aircraft are part of a *system of systems* that includes the unmanned aircraft itself, its control station, and its dedicated communications systems and links, OSD recently announced

¹⁰ This definition excludes lighter-than-air craft such as balloons, blimps, zeppelins, and airships. It also excludes ballistic missiles, which do not employ aerodynamic lift, and one-way non-reusable aerodynamic craft such as cruise missiles. See Thomas P. Ehrhard, *Unmanned Aerial Vehicles in the United States Armed Services: A Comparative Study of Weapon System Innovation*, a dissertation submitted to the John Hopkins University in conformity with the requirements for the degree of Doctor of Philosophy (Washington, DC: The Johns Hopkins University, June 2000), p. viii.

that they would be referred to as either unmanned aircraft systems (UASs) or unmanned combat air systems.¹¹

Historically, the demand signal for UASs and UCASs came from missions considered to be “dull” (e.g., extremely long-duration), “dirty” (e.g., flying through contaminated airspace), or “dangerous” (e.g., suppressing enemy air defenses) for manned aircraft.¹² Originally, a key difference between these two types of unmanned aircraft systems was whether or not they were armed. As originally defined, UASs generally referred to unmanned aircraft that did not dispense weapons (e.g., surveillance and reconnaissance UASs), while UCASs referred to those that did.¹³ However, with the recent development of *armed* surveillance UASs like the Hellfire missile-armed Predator unveiled during Operation Enduring Freedom (the operation to overthrow the Taliban government in Afghanistan), the line between the two is already beginning to blur.¹⁴ Indeed, the new MQ-9 Reaper, an improved version of the highly successful Predator UAS, has six underwing pylons capable of carrying 1.7 tons of missiles or air-dropped guided weapons, giving it the ability to carry up to 16 Hellfire missiles and making it a deadly “hunter-killer UAS.”¹⁵ It is therefore becoming harder to distinguish the difference between a hunter-killer UAS and a “genuine” UCAS.¹⁶

¹¹ See *Unmanned Aircraft Systems Roadmap 2005–2030* (Washington, DC: Office of the Secretary of Defense, August 4, 2005), accessed online at <http://www.acq.osd.mil/usd/Roadmap%20Final2.pdf> on April 17, 2007. When only discussing the unmanned aircraft itself, it is still common to use the terms unmanned aerial vehicle (UAV) and unmanned combat air vehicle (UCAV).

¹² *Ibid.*, pp. 1–2.

¹³ The term unmanned combat air system (UCAS) derives from the UCAV Advanced Technology Demonstration (ATD) program, initiated by the Defense Advanced Projects Research Agency (DARPA) in the late 1990s, which is the antecedent of the current UCAS-D program. See “Unmanned Combat Air Vehicle (UCAV),” accessed online at <http://www.globalsecurity.org/military/systems/aircraft/ucav.htm> on March 15, 2007.

¹⁴ A comprehensive account of the development of the Hellfire-shooting Predator UAS is found in Sean M. Frisbee, “Weaponizing the Predator UAV: Toward a New Theory of Weapon System Innovation,” Master’s thesis (Maxwell AFB, AL: School of Advanced Air and Space Studies, 2004).

¹⁵ Carrying this heavy a weapons load would reduce the maximum range of the Predator considerably. It would therefore typically operate with fewer Hellfires. See “\$41.4M for 5 New Predator B UAVs,” *Defense Industry Daily*, January 26, 2006, accessed online at <http://www.defenseindustrydaily.com/414m-for-5-new-predator-b-uavs-01801> on July 7, 2007. For more information on the MQ-9 Reaper, also known as the Predator B, see *Unmanned Aircraft Systems Roadmap 2005–2030*, p. 10.

¹⁶ At this point in time, “RQ” is used to designate an unmanned (Q) reconnaissance (R) platform (e.g., the RQ-1 Predator, RQ-2 Pioneer, RQ-4

Accordingly, this report further differentiates between UASs and UCASs by focusing on their ability to survive in contested airspace—that is, over territory or seas protected by a modern integrated air defense system (IADS). *Non-stealthy* unmanned aircraft like the MQ-9 Reaper would not likely survive for long inside the engagement envelope of a capable IADS. If the Reaper was considered “expendable,” its inability to survive against a credible air defense might not pose a problem; as long as it could fulfill its mission, it could simply be flown against an IADS and be lost without regret. However, while the MQ-9 is much cheaper than a tactical fighter jet, at more than \$17.3 million a copy, it can hardly be considered expendable.¹⁷ Moreover, it is incapable of employing the full range of weapons necessary to wage a major IADS suppression operation. Consequently, the next logical step beyond non-stealthy hunter-killer UASs is a purpose-built unmanned aircraft specifically designed to fight inside the engagement envelope of even the most lethal air defense systems. Accordingly, this report considers a true UCAS to be a *stealthy* unmanned aircraft able to operate even in contested airspace. This distinction is consistent with the US Navy’s Request for Proposal (RFP) for the Unmanned Combat Air System Carrier Demonstration program, which specifically calls for an unmanned flight demonstrator with a tailless, low-observable (i.e., stealthy) planform.¹⁸

WHAT’S THE BIG DEAL?

At first glance, even if stealthy, the naval UCAS demonstrator may seem to promise just the next step in unmanned aircraft rather than what it truly augurs: *a radical improvement in the combat effectiveness of carrier-based aircraft, and, by extension, the aircraft carrier*. After all, unmanned aircraft of various kinds have flown since before World War II, and the United States has been a world leader in UAS and UCAS

Global Hawk, and RQ-8 Fire Scout). Arming a reconnaissance system changes its designation to “MQ,” for unmanned *multi-mission* platform. At this point, only the Predator and Fire Scout have this designation.

¹⁷ According to the “MQ-9 Reaper Unmanned Aerial Vehicle” Air Force Factsheet, the unit cost of a Predator B is \$69.1 million for four aircraft, or \$17.3 million per aircraft. See <http://www.af.mil/factsheets/factsheet.asp?id=6405>, accessed online on July 7, 2007.

¹⁸ Amy Butler, “Let the Race Begin,” *Aviation Week & Space Technology*, April 2, 2007, p. 34.

development for over 50 years.¹⁹ More recently, the combination of the global positioning system (GPS), advances in communications and flight control software, and the increasing demand for continual surveillance data from US commanders engaged in combat operations in Afghanistan and Iraq has led to a dramatic rise in the number of operational American UASs. For example, in 2002, the US armed forces operated 127 UASs of five major types, which together amassed a combined total of approximately 26,000 vehicle flight hours.²⁰ Just four years later, in 2006, 520 American UASs of 16 different types amassed over 160,000 flight hours—and these numbers do not include additional small battlefield UASs also in service.²¹

UASs operated by US forces come in a wide variety of sizes and capabilities. The largest system is the 47.6 foot-long Northrop Grumman RQ-4B Global Hawk, which has a wingspan of 131 feet and can fly more than 35 hours at altitudes up to 60,000 feet and use a variety of onboard sensors to survey up to 40,000 square miles of terrain per day.²² More numerous are the smaller UAVs, such as the Neptune mini-UAV operated by Navy Sea-Air-Land commandos (SEALs). The Neptune can be shipped in a small 72"x30"x20" container and assembled in the field.²³ In between these are battlefield UASs and hunter-killer UASs like the Predator and Reaper. These American systems join hundreds of other operational unmanned aircraft now in service with armies, navies, and air forces around the world. Market analysts expect no fewer than 25,566 UASs and UCASs to be purchased worldwide between now and 2018, with nearly \$55 million being spent on UAS procurement and R&D during that decade.²⁴

¹⁹ For a far more comprehensive overview of the history and development of US UASs and UCASs, see Ehrhard, *Unmanned Aerial Vehicles in the United States Armed Services: A Comparative Study of Weapon System Innovation*.
²⁰ From Tamar A. Mehuron, "That Giant Droning Sound," *Air Force Magazine*, March 2007, p. 10. The five systems include the Global Hawk, Predator, Pioneer, Shadow, and Hunter UASs. Descriptions of all of these UASs can be found in the *Unmanned Aircraft Systems Roadmap 2005–2030*.

²¹ These systems include the five systems operating in 2002, augmented by newer UASs such as the Buster, Neptune, Tern, Mako, Sentry, Tigershark, SnowGoose, and Gnat systems. Mehuron, "That Giant Droning Sound," p. 10.

²² See "Northrop Grumman RQ-4A Global Hawk," National Museum of the Air Force Factsheet, accessed online at <http://www.nationalmuseum.af.mil/factsheets/factsheet.asp?id=347> on March 17, 2008.

²³ See "DRS Neptune," accessed online at <http://www.designation-systems.net/dusrm/app4/neptune.html> on March 20, 2007.

²⁴ Steven J. Zaloga, "World Unmanned Aerial Vehicle Systems Market Profile and Forecast, 2008," Teal Group, 2008, p.2.

MAKING A DASH INTO A NEW DOMAIN

The UCAS-D program is quite significant because the Navy has never been an enthusiastic proponent of unmanned aircraft, especially for its carrier force. This is ironic, given the fact that it developed the very first US hunter-killer UAS: the QH-50 Drone Anti-Submarine Helicopter (DASH). In the late 1950s and early 1960s, the Navy developed and fielded DASH—a diminutive (2,100-pound) unmanned rotorcraft—for operations from a small flight deck on a frigate or destroyer. DASH was designed to take off vertically, deliver a homing torpedo against an enemy submarine up to 30 miles from the ship, and recover back aboard. However, it proved to be an idea well ahead of its technological time. While more than 100 ships were eventually modified to operate the system, the Navy did not fully develop the DASH's flight control system and failed to adequately train a force of competent pilots. The proof of these failures was that, of the 746 systems built, *over half* were lost due to accidents of some kind.²⁵ It did not help that ship skippers who crashed or lost the system often received letters of caution or reprimand, leading to self-imposed flight training restrictions which exacerbated the loss rate.²⁶

The Navy's unhappy experience with DASH helped to dampen demand for naval unmanned aerial systems in the surface warfare community for some time. Perhaps more importantly, it also helped to sour the carrier aviation community on unmanned aircraft for two related reasons. First, when conducting flight operations in company with their surface escorts, carrier aviators "did not want to be in the air with that crazy thing"²⁷—meaning they did not trust unmanned aircraft being operated outside the control of carrier air wing personnel. Second, the aviators themselves had no interest in flying an unmanned system from a crowded carrier deck due to the potential disruption of closely coordinated flight deck operations.²⁸ In the end, both the surface warfare and carrier communities sought more culturally acceptable aviation systems—small manned helicopters that could operate from slightly

²⁵ Norman Friedman, *U.S. Destroyers: An Illustrated Design History*, revised edition (Annapolis, MD: Naval Institute Press, 2004), pp. 280–283.

²⁶ Interview with Captain George Walker, USN (Ret.), conducted by Thomas P. Ehrhard on March 23, 1999.

²⁷ Walker interview.

²⁸ For example, see Rich Worth, letter to the editor, *Proceedings*, U.S. Naval Institute, December 1984, p. 108.

enlarged DASH flight decks.²⁹ These helicopters were ultimately called Light Airborne Multipurpose Systems, or LAMPS, and they proved to be exceptionally reliable and effective in subsequent fleet operations.³⁰ They remain in fleet service today, in the form of the much larger and more capable MH-60R Sea Hawk.³¹

A Respite After DASH

After making the decision to replace DASH with manned helicopters, it would be some time before the Navy once again began to pursue any type of unmanned aircraft for shipboard or carrier use. Most strikingly, the Navy showed little more than cursory interest in naval reconnaissance UASs, which have obvious applications in support of carrier operations, particularly for pre- and post-strike reconnaissance of heavily defended targets. For example, between 1964 and 1973, the US Navy was fighting “the most protracted, bitter, and costly war” in the history of naval aviation over the skies of Vietnam.³² Operating from as many as six aircraft carriers steaming at one time in the South China Sea, US Navy and Marine aircraft supported ground combat operations in South Vietnam and, along with the Air Force, conducted periodic, sustained attacks against targets throughout North Vietnam. Faced with the dangerous chore of conducting strike reconnaissance over Hanoi and Haiphong, two of the most heavily defended targets in history, the

²⁹ “Manned Helicopters May Replace DASH,” *Aviation Week & Space Technology*, February 3, 1964. For a more detailed story of the incorporation of helicopters onboard naval warships, see Norman Friedman, *US Naval Weapons* (London: Conway Maritime Press, 1983), p. 110.

³⁰ The LAMPS I helicopter, called the Seasprite, was a relatively small two-engine helicopter with a maximum take-off weight of approximately 13,000 pounds. See Norman Polmar, *The Naval Institute Guide to the Ships and Aircraft of the U.S. Fleet*, 14th edition (Annapolis, MD: Naval Institute Press, 1987), p. 440.

³¹ The MH-60R Seahawk has a maximum take-off weight of 22,500 pounds. It carries a crew of four, versus the crew of three in the Seasprite, and has far more capable systems. See Norman Polmar, *The Naval Institute Guide to the Ships and Aircraft of the U.S. Fleet*, 18th edition (Annapolis, MD: Naval Institute Press, 2005), p. 451.

³² For a detailed discussion of the carrier air war over Vietnam, see Rene J. Francillon, *Tonkin Gulf Yacht Club: U.S. Carrier Operations off Vietnam* (Annapolis, MD: Naval Institute Press, 1988).

Navy relied on manned reconnaissance aircraft such as the RF-8 Crusader or the RA-5C Vigilante despite the high risks to their aircrews.³³

Faced with the same operational challenge and high risks to aircrew, the Air Force moved to augment its own manned reconnaissance fleet with unmanned reconnaissance aircraft. In concert with the intelligence community, it modified the jet-powered Firebee target drone to perform penetrating reconnaissance missions over the most heavily defended targets. The resulting Firefly UAS proved the viability of the concept, which then prompted the Air Force to develop an improved reconnaissance drone named the Lightning Bug. The Lightning Bug UAS proved its worth as a penetrating reconnaissance system in more than 3,500 combat sorties in the dangerous skies over North Vietnam (not to mention China and North Korea) between 1964 and 1973.³⁴

Taking note of the Air Force's success, the Navy conducted an experiment to see if the Lightning Bug could be modified for shipboard use. The UASs were modified for launch from carriers using a rocket-assisted take-off (RATO) booster. After RATO launch, a Lightning Bug would be guided to an initial checkpoint under radio control from a carrier-based E-2 Hawkeye airborne early warning (AEW) aircraft. From that point on, the UAS would complete its reconnaissance mission using an autonomous onboard navigation system; return to a designated location; be recovered by a helicopter, either while it descended under a parachute or after having landed in the water; and then be returned to the carrier for mission processing and follow-on mission preparations.³⁵ However, after conducting over 30 operational Lightning Bug flights between November 1969 and May 1970, the Navy terminated the program, preferring to continue operating carrier-based, manned reconnaissance aircraft despite the risks to their aircrews. One reason for this decision was that carrier aviators thought the UAS disrupted flight deck operations. As William Wagner, the historian for

³³ Of the 134 RA-5Cs built, 27 were lost in Vietnam—18 in combat and nine more in operational accidents—for a force-wide attrition rate of approximately 20 percent. See “A-5 Vigilante,” accessed online at http://en.wikipedia.org/wiki/A-5_Vigilante on June 21, 2007.

³⁴ For the history of the Lightning Bug drone, see William Wagner, *Lightning Bugs and Other Reconnaissance Drones* (Fallbrook, CA: Aero Publishers, 1982), and Ehrhard, *Unmanned Aerial Vehicles in the United States Armed Services: A Comparative Study of Weapon System Innovation*, Chapter 8. For an online source, see “The Lightning Bug Reconnaissance Drones,” accessed online at http://www.vectorsite.net/twuav_04.html on March 18, 2007.

³⁵ Wagner, *Lightning Bugs and Other Reconnaissance Drones*, pp. 157–165.

the Lightning Bug program, stated, “It was clear it would take additional time to fully integrate the drone reconnaissance capability with the fast-paced combat operations of an attack carrier strike force.”³⁶

The carrier community’s apparent lack of enthusiasm for the Lightning Bug worked to squelch any Navy interest in developing a naval reconnaissance UAS of its own. This was ironic, because the short-lived experiment with the Lightning Bug—a system originally designed to launch from a large, specially-modified C-130 transport aircraft—was really an evaluation program designed to help the Navy write its own unique reconnaissance UAS requirements. Even if the Navy’s experiment demonstrated that UASs were not technologically ready or ideally suited for carrier flight deck operations, given the obvious benefit of having an unmanned, penetrating reconnaissance capability in support of its carrier air wings the Navy might have employed the Lightning Bug or another UAS from land bases by using its own considerable land-based maritime patrol aircraft fleet as mother aircraft.

In any event, the Navy’s only other attempt to develop a sea-based reconnaissance UAS during the Vietnam War was prompted by the recommissioning of the World War II battleship *USS New Jersey* as a naval gunfire platform. During her single deployment in 1968, the battleship operated several modified DASH UASs equipped with video links to give its gunners a remote gunfire spotting capability. Once the battleship was again decommissioned, however, these few systems were discarded without replacement.³⁷ After giving up on the Lightning Bug and the DASH UASs, the Navy never seriously pursued naval reconnaissance UASs (or any other type of naval UAS or UCAS except for target drones) through the remainder of the 1970s and early 1980s.³⁸

³⁶ Ibid., p. 165.

³⁷ Norman Polmar, *The Naval Institute Guide to the Ships and Aircraft of the U.S. Fleet*, 17th edition (Annapolis, MD: US Naval Institute Press, 2001), p. 465.

³⁸ In the early 1970s, the Navy subsumed UAS development under the program for target drones. Paul R. Benner and Theodore C. Herring, *History of Unmanned Vehicles at NAVAIRDEVCEN/NAVAIRWARCEN Warminster* (Patuxent River, MD: Naval Air Warfare Center, Aircraft Division, ca. 1992), p. 27. The surface Navy did pursue a program called the “over-the-horizon” (OTH) UAV in the late 1970s, which would have provided targeting data to surface ships employing the Harpoon anti-ship cruise missile, but abandoned the \$1 billion program when it was in the early developmental stage. The Navy was not alone in abandoning UASs. The Air Force retired its Lightning Bug units after the Vietnam War without replacement. See Ehrhard, *Unmanned*

A Naval Pioneer

The decision to forego an unmanned reconnaissance capability came back to haunt the Navy in December 1983, when a poorly executed carrier air strike against a Syrian surface-to-air missile (SAM) battery in Lebanon resulted in the loss of two aircraft, the death of one aircrew, and the capture of another. After the episode, Secretary of the Navy John Lehman concluded that the strike could have been conducted using the 16-inch naval guns of the *USS New Jersey*. If the “Big J,” which had been recommissioned yet again as part of the Reagan Administration’s “600-ship Navy,” had been able to remotely spot its cannons’ fire, it could have destroyed the Syrian SAM site without hazarding any personnel. This prompted Secretary Lehman to launch a crash program to find a naval reconnaissance UAS capable of being used from ships by the Navy and from land by the Marines.³⁹

This effort produced the RQ-2 Pioneer, a modified Israeli UAS that had proven itself in combat operations against Syria over the Bekaa Valley. After a hurried development program, the Pioneer was subsequently used during Operation Desert Storm. The Marines launched and recovered their UASs from air bases on land and from the decks of amphibious assault ships (LHAs). The Navy launched them from battleships using either a pneumatic catapult or a RATO, and recovered them by flying the aircraft into a net erected on the ship’s fantail.⁴⁰ While the official Department of Defense report to Congress on Operation Desert Storm declared that the “Pioneer proved to be valuable and appears to have validated the operational employment of UAVs in combat,” the Navy deactivated its own Pioneer units when it once again decommissioned its battleships. Meanwhile, the Marines continued to employ the Pioneer both from land bases and amphibious landing ships throughout

Aerial Vehicles in the United States Armed Services: A Comparative Study of Weapon System Innovation, pp. 342–347.

³⁹ For a thorough treatment of this episode, see Ehrhard, *Unmanned Aerial Vehicles in the United States Armed Services: A Comparative Study of Weapon System Innovation*, pp. 347–359. See also “US Battlefield UAVs in the Gulf War: Pioneer / Exdrone / Pointer,” accessed online at http://www.vectorsite.net/twuav_07.html#m3 on March 18, 2007.

⁴⁰ Ehrhard, *Unmanned Aerial Vehicles in the United States Armed Services: A Comparative Study of Weapon System Innovation*, pp. 359–381.

the 1990s, using 16 during the invasion of Iraq in 2003.⁴¹ Despite having been acquired in 1986 and having a design service life of only three years, 33 of the aircraft remain in operational service today.⁴²

Tentative Next Steps

The only other Navy reconnaissance UAS programs in the 1980s or 1990s of any note were for the air- and ship-launched Medium-Range UAV (MR-UAV), a joint program with the Air Force designed to replace dwindling manned tactical reconnaissance platforms; the Hunter UAV, a joint program with the Army; and the Outrider UAV, another joint program. Only the Hunter made it to active service, and then only with the Army. The other two systems were cancelled after their costs ballooned and performance failed to meet expectations. Designing a joint system that met the Navy's unique demands for shipboard operations proved to be a contributing factor to high costs and sub-par performance.⁴³

In fairness to the Navy—and the other Services—the supporting technologies for early unmanned systems lagged behind the desired operational requirements. Nevertheless, it is still surprising that the Navy's interest in unmanned aircraft did not develop in a serious way until the late 1990s—nearly three decades after its failed DASH program. In late 1998, Lockheed Martin Tactical Aircraft Systems completed a study for the Navy which offered three conceptual designs for unmanned naval aircraft. The first was a short take-off and landing (STOL) version for use on amphibious ships; the second, a vertical take-off and landing (VTOL) version for use on surface combatants; and the third, a version for use by submarines. None of the systems were designed to operate from an aircraft carrier. The Navy also began to follow closely an advanced technology demonstration program, sponsored jointly by the Defense Advanced Projects Research Agency (DARPA) and the Air Force, for a sophisticated, jet-powered UCAS intended to augment manned aviation platforms. As will be discussed later in this

⁴¹ The Marines employed five Pioneers on the USS *Ponce*, LPD-15, during Operation Allied Force, the NATO campaign against Serbia in the spring of 1999. "US Battlefield UAVs in the Gulf War: Pioneer / Exdrone / Pointer;" and Polmar, *The Naval Institute Guide to the Ships and Aircraft of the U.S. Fleet*, 17th edition, p. 465.

⁴² Mehuron, "That Giant Droning Sound," p. 10.

⁴³ Ehrhard, *Unmanned Aerial Vehicles in the United States Armed Services: A Comparative Study of Weapon System Innovation*, pp. 391–398.

report, this spurred the Navy to start its own UCAS program, which was later combined with the DARPA/Air Force effort to form the Joint UCAS Project Office.⁴⁴

Fire Scout and BAMS

With the exception of small air vehicles designed to support its special forces, the Navy's renewed interest in unmanned aircraft has yet to yield an operational system for shipboard use. The story of the RQ-8A Fire Scout is instructive in this regard. In 1999, the Navy held a competition to find a replacement for the Pioneer UAS, which was nearing the end of its practical service life. Consistent with the conceptual studies conducted by Lockheed Martin, the Navy called for a VTOL UAS able to carry a 200-pound sensor payload out to a range of 125 miles, and to stay on station for three hours at altitudes up to 20,000 feet. It also had to be able to land on a surface combatant or amphibious ship in winds up to 30 miles per hour and fly 190 hours between major scheduled maintenance periods. Harkening back to the DASH, the winner of the competition was the Fire Scout UAS—a small robotic helicopter.⁴⁵

Despite the crash of a prototype in 2000, the Fire Scout UAS was a success. The flight program demonstrated that the system could achieve the stated mission requirements. Nevertheless, in December 2001, the Navy—citing funding concerns—abruptly decided to halt production of Fire Scout after just five air vehicles were built. Not willing to give up on the system so easily, Congress provided supplemental funds to sustain the program and continue flight testing. Meanwhile, the US Army showed interest in an improved version of the Fire Scout, which had four rotor blades and carried both sensors *and* weapons. The Army was happy enough with this version, designated the MQ-8B, to select it as the brigade-level UAS for its projected Future Combat System.⁴⁶

The intervention of Congress and the Army on behalf of the Fire Scout ultimately proved fortuitous for the Navy. Soon after canceling funding for the RQ-8A, the Navy began searching for a small UAS capable of operating from its new 3,000-ton Littoral Combat Ship (LCS).

⁴⁴ Polmar, *The Naval Institute Guide to the Ships and Aircraft of the U.S. Fleet*, 17th edition, pp. 474–475.

⁴⁵ “Northrop Grumman MQ-8 Fire Scout,” *Jane's Unmanned Aerial Vehicles and Targets*, March 7, 2007.

⁴⁶ *Ibid.*

The Fire Scout was a logical choice, prompting the Navy to start testing the improved MQ-8B for shipboard use. In January 2006, Fire Scout made successful autonomous landings aboard the amphibious warship USS *Nashville* operating in Chesapeake Bay. Seven months later, in July 2006, the Navy awarded Northrop Grumman a \$135 million contract for eight MQ-8Bs (later increased to nine), with work to be completed by August 2008. In December 2006, the contract was expanded to include developing Fire Scout concepts of operations.⁴⁷ In May 2007, the MQ-8B entered low-rate initial production, and will achieve IOC in 2008.

At the other end of the UAS spectrum, the Navy is pursuing a large, land-based UAS as part of its Broad Area Maritime Surveillance (BAMS) program. The BAMS UAS is a broad ocean area surveillance system, designed to augment and complement the Navy's future force of (manned) P-8 Poseidon Multi-Mission Maritime Aircraft (MMA), the successor to the Navy's venerable propeller-driven P-3 Orion maritime patrol and anti-submarine aircraft.⁴⁸ BAMS UASs would fly the "dull" long-duration ocean surveillance missions, allowing a smaller force of jet-powered P-8s to investigate or prosecute targets of interest. Accordingly, the BAMS requirement centers on providing a large unmanned aircraft capable of autonomously taking off, flying 2,000 nautical miles (nm) to a patrol area, remaining on station for at least 24 hours, and returning to its base and landing. While in flight, a BAMS UAS will use radar and other sensors to survey large areas of ocean or coastal areas, relaying the data collected in real time via satellite or line-of-sight links to land-based intelligence centers and command posts, and to deployed US naval task forces.⁴⁹ The system's requirements for an extremely long range, long endurance, and large payloads necessarily demand a large, land-based UAS.⁵⁰

⁴⁷ "The Fire Scout VTUAV Program: By Land and By Sea," updated October 17, 2005, accessed online at <http://www.defenseindustrydaily.com/2005/10/the-fire-scout-vtuav-program-by-land-and-by-sea-updated/index.php> on March 19, 2007.

⁴⁸ Derived from the Boeing 737-800 commercial jet airliner, the P-8 Poseidon MMA is the planned successor to the famous P-3 Orion anti-submarine warfare patrol aircraft. It will be a multi-mission platform, able to search for and destroy submarines to perform ocean surveillance and maritime interdiction. See "P-8 Poseidon," accessed online at http://en.wikipedia.org/wiki/P-8_Poseidon on June 21, 2001.

⁴⁹ "Navy Details Huge Unmanned Aerial Vehicle Program," *CongressDaily*, May 18, 2006, accessed online at <http://www.govexec.com/dailyfed/0506/051806cdam1.htm> on March 30, 2007.

⁵⁰ "Hand in Hand," *Aviation Week & Space Technology*, March 5, 2007, p. 28.

Three different companies competed for the BAMS program. Northrup Grumman Corporation offered a navalized version of its large Global Hawk UAS. Lockheed Martin and General Atomics jointly proposed the Mariner, a modified version of the Predator UAS. Boeing and General Dynamics offered a modified, optionally-manned G550 business jet. On April 22, 2008, the Navy selected NGC's Global Hawk as the winner of the competition, and awarded the company an 89-month, \$1.16 billion contract for System Development and Demonstration (SDD) of the new UAS.⁵¹

UCAS-D: A SIGNIFICANT NEXT STEP

As the foregoing history reveals, the Navy has pursued unmanned aerial systems with little enthusiasm. Five decades after developing the first ever tactical hunter-killer UAS, it has yet to develop an effective operational system of its own. The Navy's interest in unmanned systems is perhaps best summed up in this way: its modern version of the DASH, the MQ-8B Fire Scout, would not have survived without the Army's help, and the BAMS will likely be a variant of an existing land-based UAS pioneered by the Air Force. Moreover, and perhaps counter-intuitively, as the Fire Scout and BAMS suggest, *what little interest the Navy has shown in unmanned aircraft to date has been for operations on ships other than aircraft carriers and for uses other than supporting carrier strike operations.*

Indeed, of all the naval warfighting communities, support for unmanned aircraft has been weakest in the carrier aviation force. This has been primarily due to widespread—and, until now, perhaps justified (if largely untested)—skepticism that unmanned systems could be safely integrated into carrier flight deck operations. However, this skepticism has undoubtedly had a cost. As one naval expert noted, after being one of the pioneers in UASs, “...delays, inattention, and lack of interest of the powerful aviation community have caused the Navy to lose its lead” in the development of unmanned aircraft systems.”⁵²

⁵¹ “U.S. Navy Awards \$1.16 Billion BAMS UAS Contract to Northrop Grumman,” accessed online at http://www.irconnect.com/noc/press/pages/news_releases.html?d=140693 on April 28, 2008.

⁵² Polmar, *The Naval Institute Guide to the Ships and Aircraft of the U.S. Fleet*, 18th edition, p. 471.

This is what makes the new UCAS Carrier Demonstration program of such great interest. It aims to develop an entirely new type of system—an unmanned aircraft designed specifically to operate as part of the Navy’s premier strike platform, the aircraft carrier. Regardless of the reasons for the aviation community’s past lack of support for unmanned systems, if the UCAS-D program succeeds, it will likely trigger a major advance in carrier airpower that will improve the Navy’s ability to address a range of critical existing and emerging challenges to US security. If so, the implications of this for American national security may be profound. Ironically, however, as the next chapter explains, it is the system’s very revolutionary potential that may work against it.

III. Aircraft Carriers Ascendant

One of the central questions this report addresses is: Why might an unmanned, long-range, air-refuelable aircraft hold the key to the future effectiveness of naval carrier aviation? Said another way, what pressing *operational deficiency* in US carrier strike operations will such a system help to correct? Before directly answering this question, however, it is important to understand the fundamental role that carrier aviation has played in US naval thinking since World War II, and the huge lead the US Navy now enjoys in sea-based tactical aviation.

THE CARRIER REVOLUTION

Although the Navy experimented with aircraft carriers extensively during the interwar period, on December 7, 1941, the administrative and tactical structure of the US battle fleet was still built around heavily armored battleships.⁵³ After the Japanese attack on Pearl Harbor, with the fleet's battleship force in smoking ruins, the previous two decades of technological exploration, carrier prototyping, and tactical experimentation allowed the Navy to quickly reorganize the Pacific Fleet around its small number of operational aircraft carriers. Six months later, this hastily cobbled together force inflicted a stinging defeat on the Imperial Japanese Navy at the Battle of Midway. This victory helped to accelerate the wholesale rethinking of American naval tactics and spurred the development of fast carrier task forces, which

⁵³ After over 20 years of carrier development in the Navy, the president of the Naval War College prepared a confidential study in September 1941 that included scathing criticisms about carrier aviation, and an argument against building a "carrier" navy. There were many reasons why the institutional Navy was not yet ready to fully embrace the aircraft carrier. For a detailed account of these reasons, see Thomas Hone, Norman Friedman, and Mark D. Mandeles, *American & British Aircraft Carrier Development 1919–1941* (Annapolis, MD: Naval Institute Press, 1999).

spearheaded the subsequent advance across the Pacific. In today's vernacular, carrier airpower sparked a revolution in naval warfare and transformed the US Navy.⁵⁴

At its core, the carrier revolution greatly increased the range over which naval forces could deliver combat power. Early in the war, this radical change was reflected in the earliest fleet-on-fleet engagements with the Imperial Japanese Navy. Prior to the carrier battles of 1942 and 1943, battles between opposing surface gun lines were measured in tens of miles. With carriers, clashes between opposing fleets occurred at ranges of hundreds of miles, well beyond visual range of one another.⁵⁵ Later in the war, with the Japanese naval threat largely negated, US carriers excelled at supporting ground troops and mounting quick raids against dispersed land targets. Fleet land attack tactics were very much driven and/or informed by the great mobility of carrier forces, the more limited, discrete striking capability of their aircraft, and the vulnerability of any carrier formation to attacks from land-based air forces.⁵⁶

In contemporary terms, the rapid advancement of the aircraft carrier during the Second World War and its enduring success thereafter can be attributed both to its ability to project combat power at range as well as its modularity, reconfigurability, and operational flexibility. Aircraft carriers were among the first truly modular warships in the Navy's battle fleet, integrating large volume and payload capacities with interchangeable off-board systems—that is, offensive and defensive aircraft. Their large size enabled carriers to operate increasingly larger, heavier, and more capable carrier aircraft without major redesign. More importantly, the reconfigurability of the carrier's combat payload—its embarked air wing—allowed naval commanders to easily adapt the ships to changing operational conditions.⁵⁷ For example, during the great carrier battles at the start of the war, 75 percent of CVW

⁵⁴ For a great history about the Navy's transformation from a battleship to a carrier force, see Clark G. Reynolds, *The Fast Carriers: The Forging of an Air Navy* (Annapolis, MD: Naval Institute Press, 1968).

⁵⁵ For a good description of the change that carriers had on naval warfare, see Captain Wayne P. Hughes, Jr., USN (Ret.), *Fleet Tactics and Coastal Combat*, 2nd edition (Annapolis, MD: US Naval Institute Press, 2000), especially Chapter 4, "World War II: A Weaponry Revolution."

⁵⁶ See Norman Friedman, *U.S. Aircraft Carriers: An Illustrated Design History* (Annapolis, MD: US Naval Institute Press, 1983), p. 18. This volume is the definitive story of the development of US aircraft carriers.

⁵⁷ This point is well captured in Friedman, *U.S. Aircraft Carriers: An Illustrated Design History*, especially p. 22.

aircraft were dive and torpedo bombers. By 1945, when faced by attacks from Japanese *kamikazes*—in essence, long-range anti-ship cruise missiles—70 percent of a carrier’s air wing were fighters or fighter-bombers.⁵⁸ After the war, as land-based threats to the carrier diminished, the carrier air wings gradually emphasized attack aircraft capable of delivering ordnance against both naval and land targets.

Because of their own modular design and the reconfigurability of their air wings, aircraft carriers proved to be useful across the full range of naval combat tasks—including fleet defense, anti-surface warfare, land strikes, close support of ground troops, and anti-submarine warfare. As a result, World War II Navy leaders moved aggressively to expand naval aviation capabilities and to distribute aircraft carriers more widely throughout the fleet.⁵⁹ Even on a wartime budget, however, planners had to take into account the cost of doing so. The result was a cost-effective mix of three different types of aviation power-projection platforms. The most powerful of the platforms were the large fast fleet carriers (CVs), with air groups of approximately 100 fighters, dive bombers, and torpedo bombers. These formed the heart of the Navy’s striking fleet. However, these ships were expensive, and took a long time to build.⁶⁰ The CVs were therefore augmented by smaller light carriers (CVLs)—converted light cruisers that were as fast as the CVs, but capable of carrying only one-third the numbers of planes. These were used first as a stop-gap measure until more CVs could be built, and then to augment them in concentrated carrier task forces.⁶¹ Most numerous were the escort carriers, or CVEs, which their crews took to

⁵⁸ Bob Kress and Rear Adm. Paul Gillerist, USN (Ret.), “Battle of the Superfighters: F-14D Tomcat vs. F-18 E/F Super Hornet,” *Flight Journal*, January/February 2002, p. 31. A major reason for the increased proportion of fighters in late-war carrier air wings was that late-war fighters like the F4U and F6F could carry significant bomb loads and were thus “multi-role aircraft” that were more flexible and useful than a mix of pure fighters and pure bombers.

⁵⁹ This paragraph was drawn from Robert O. Work, *To Take and Keep the Lead: A Naval Platform Architecture for Enduring Maritime Supremacy* (Washington, DC: Center for Strategic and Budgetary Assessments, December 2005), p. 236.

⁶⁰ The standard World War II carrier was the Essex class. The first of this type was ordered in 1940 and completed on the last day of 1942, 15 months ahead of schedule. Ultimately, 24 of the class were built. See Chapter 7, “The Essex Class,” in Friedman, *U.S. Aircraft Carriers: An Illustrated Design History*.

⁶¹ A total of nine Independence-class light aircraft carriers (CVLs) were built; one, the USS *Princeton*, was sunk in the 1944 Battle of Leyte Gulf. Two Saipan-class CVLs were laid down late in the war; neither was completed prior to war’s end. See Friedman, *U.S. Aircraft Carriers: An Illustrated Design History*, pp. 182–192; also Reynolds, *The Fast Carriers: The Forging of an Air Navy*, p. 38.

stand for “combustible, vulnerable, and expendable.” Early CVEs generally were small converted merchantmen; later CVEs were purpose-built from the keel up. However, they all had one thing in common: with top speeds of 17-19 knots, they were capable of keeping up only with slower transoceanic convoys and amphibious task groups. When accompanying the former, they concentrated on anti-submarine warfare (ASW) work; when accompanying the latter, they concentrated on task force air defense and close air support.⁶²

A FLASH IN THE PAN?

Aircraft carriers proved so central to American wartime operations that by the end of the war the Navy operated 99 carriers of all types—including 28 fleet carriers (CVs and CVLs) and 71 CVEs. Less than five years later, however, the active fleet had shrunk to only 11 fleet carriers and four escort carriers.⁶³ Aside from their cost, one reason for the rapid post-war decline in the US carrier force was that the smaller escort carriers could not cope with new Soviet submarines designed for high underwater speeds, and neither the CVEs nor the CVLs could easily handle the new generation of larger, heavier jet aircraft then being designed for the carrier force.⁶⁴ However, an equally important reason was that many outside the Navy believed that the carrier revolution was a spent one. No organization espoused this view more than the newly formed US Air Force. Air Force officers argued that the aircraft carrier would be far less useful in the future, given that the USSR was a land power with a negligible surface fleet. They pointed out that carriers had made little impact in the European theater of war, where land-based airpower proved far more important, and that new long-range strategic bombers would have as much global freedom of action as carriers. Given

⁶² CE1 Robert A. Germinsky, USNR, “A Brief History of U.S. Navy Aircraft Carriers: The Escort Carriers,” accessed online at <http://www.chinfo.navy.mil/navpalib/ships/carriers/cv-esert.html> on June 21, 2007.

⁶³ See “U.S. Navy Active Ship Force Levels, 1945–1950,” accessed online at <http://www.history.navy.mil/branches/org9-4.htm#1945>, on June 21, 2007.

⁶⁴ Of the eight Independence-class CVLs that survived the war, one was used as a target in the Bikini atomic test, and later sunk. All the rest were decommissioned in 1947. Two were recommissioned briefly as prototype anti-submarine warfare carriers, but both were decommissioned for good by 1955. See “Independence Class Aircraft Carrier,” accessed online at http://en.wikipedia.org/wiki/Independence_class_aircraft_carrier on July 9, 2007.

that Europe was the Cold War's "central front," and that future war with the Soviet Union would likely be decided by atomic strikes against the Soviet heartland, the aircraft carrier was, the Air Force said, an expensive dinosaur that should be replaced by strategic bombers.⁶⁵

Air Force arguments proved especially alluring to successive post-war administrations intent on reducing defense expenditures, as well as many military professionals. Indeed, in January 1950, the Joint Chiefs of Staff (JCS) tentatively approved the eventual reduction of the active carrier force to only six fleet carriers (down from the 11 active in June 1949). It took every argument the Chief of Naval Operations (CNO) could muster to convince them to keep the planned future force level at seven carriers, on the grounds that the deteriorating political situation in the Western Pacific warranted keeping one carrier continuously active in the region.⁶⁶ Less than a decade after its inspiring start, the carrier revolution looked to be a flash in the pan.

However, less than six months after the Joint Chiefs had grudgingly accepted the need for a seventh active carrier, the great utility of sea-based tactical aviation was once again vividly demonstrated. In June 1950, the North Koreans invaded South Korea, quickly defeating the South Korean armed forces and pushing US and allied forces back into a tight perimeter around the southern port of Pusan. In the process, the North Koreans overran the majority of US and South Korean air bases on the peninsula. The two US carriers on station in the Western Pacific at the time of the attack provided the embattled Pusan Perimeter with vital air cover during these early months of the Korean War. After the Inchon landing and subsequent breakout from Pusan, and for the remainder of the war, a greatly reinforced US Navy carrier battle force provided a large fraction of the tactical sorties flown in support of US and United Nations forces.⁶⁷

Having validated the continued worth of sea-based aviation, the Korean War led to a sharp reversal in fortunes for the US carrier force. One year after the start of the war, the force numbered no less than 19 fleet carriers and nine escort carriers. By 1957, the force included 22 fleet carriers (and no escort carriers), and, by 1962, the number of active

⁶⁵ This line of reasoning is perfectly captured in Samuel Huntington, "National Policy and the Transoceanic Navy," *Proceedings*, U.S. Naval Institute, May 1954, pp. 483-493.

⁶⁶ Friedman, *U.S. Aircraft Carriers: An Illustrated Design History*, p. 20.

⁶⁷ *Ibid.*, p. 21.

fleet carriers had climbed to 26 ships—the post-World War II high.⁶⁸ Activating the large reserve fleet of World War II carriers made these rapid increases possible.

FORMING THE CORE OF THE US STRIKE FLEET

The high post-Korean War carrier force levels are somewhat misleading, as they obscure the rock-steady size of the core US striking fleet. Up until the appearance of nuclear attack submarines, fast carrier task forces were largely immune from submarine attack due to their high sustained operating speeds. With the appearance of Soviet nuclear-powered attack submarines (SSNs) capable of keeping pace with even nuclear-powered carriers, the Navy concluded that every fast carrier task force required a carrier dedicated solely to ASW. Reflecting the difference between strike and anti-submarine warfare, the active fleet carriers were therefore split between conventional and nuclear-powered carriers optimized for nuclear and conventional attack operations (CVANs and CVAs, respectively), and conventional-powered carriers optimized for ASW tasks (CVSs).⁶⁹

After the Vietnam War, all World War II carriers still in active service started to reach the end of their productive service lives. Between 1969 and 1975, no fewer than 12 modernized Essex-class carriers were decommissioned for good.⁷⁰ As a result, the active carrier force rapidly contracted, falling to 13 carriers in 1976. The number of active carriers never rose above 14 ships for the remainder of the Cold War.⁷¹ Due to both cost considerations and the declining usefulness of CVSs, in

⁶⁸ See “U.S. Navy Active Ship Force Levels,” accessed online at <http://www.history.navy.mil/branches/org9-4c.htm> on March 20, 2007.

⁶⁹ This helps to explain why 19 of the 24 Essex-class aircraft carriers (CVs) built during and immediately after World War II served as CVSs in the latter parts of their careers; two of these 19 were subsequently used as helicopter carriers. Friedman, *U.S. Aircraft Carriers: An Illustrated Design History*, p. 25, and Appendix F, “Vital Statistics of Carrier Types,” pp. 412–413.

⁷⁰ A comparison of decommissioning dates in Appendix F, “Vital Statistics of Carrier Types,” in Friedman, *U.S. Aircraft Carriers: An Illustrated Design History*, pp. 412–413.

⁷¹ “U.S. Navy Active Ship Force Levels.” The ultimate Cold War carrier force objective was for 15 *deployable* carriers. See Admiral James D. Watkins, USN, “The Maritime Strategy,” *Proceedings*, U.S. Naval Institute, January 1986, pp.

1975 the Navy revived the traditional aircraft carrier designation of CV (and CVN in the case of nuclear-powered ships) for all of its carriers, equipping each of them with blended air wings consisting of squadrons of fighter and attack aircraft *and* anti-submarine patrol planes and helicopters. When comparing the number of CVAs or CVANs the Navy operated between the Korean War and the end of the Vietnam War with the number of CVs and CVNs it operated until the end of the Cold War—that is, the number of aircraft carriers that made up the Navy’s primary striking forces—the total number of carriers dedicated to offensive warfare fluctuated in a relatively narrow band between 12 and 16 carriers, with an average of just over 13.5 ships.⁷² Considering this number, the post-Cold War average of 12 active carriers looks far less alarming than many make it out to be.⁷³

Maintaining a core striking fleet of 12 to 13.5 “attack” carriers is all the more impressive given the wide swings in the size of the Navy’s Total Ship Battle Force (TSBF) since the Korean War. For example, between 1951 and the end of the Cold War, the TSBF fluctuated from a low of 521 ships to a high of 1,122 ships of all types. In late 1989 (just months before the Berlin Wall came down), the TSBF stood at 592 ships of all types, including 14 carriers.⁷⁴ Today, although the TSBF stands at only 280 total ships, it still retains 11 carriers.⁷⁵ In other words, despite a hefty 53 percent reduction in overall fleet size, the Navy cut its carrier force by only 21 percent. The relative stability of the US carrier force even as the larger battle force dramatically expanded and contracted provides stark evidence of the central role of aircraft carriers in the US Navy since the end of World War II. It is often said—only slightly tongue-in-cheek—that if the Navy is ever cut to ten ships, they would surely all be aircraft carriers.

Indeed, DoN touched off a firestorm of sorts when, in early 2005, it announced its intention to retire the USS *John F. Kennedy* (CV-67)

2–17. For a more thorough discussion of the strategy, see Norman Friedman, *The U.S. Maritime Strategy* (Annapolis, MD: Naval Institute Press, 1988).

⁷² For a thorough discussion of Cold War carrier force levels, see Michael M. McCrae, et al., *The Offensive Navy Since World War II: How Big and Why?* (Alexandria, VA: Center for Naval Analyses, CRM 89-201, 1989), pp. 8–16.

⁷³ The US carrier force dropped to 12 carriers in 1994, and remained there until 2007, when it fell to 11 ships. See “U.S. Navy Active Ship Force Levels.”

⁷⁴ *Ibid.*.

⁷⁵ As indicated in the Naval Vessel Register, accessed online at <http://www.nvr.navy.mil> on December 6, 2007.

in 2006, 12 years before its previously announced retirement date.⁷⁶ This move was triggered by a program budget decision that allocated hefty spending cuts across all the Services. DoN officials defended the retirement by pointing out that the move would save an immediate \$350 million in scheduled overhaul costs and an additional \$1.2 billion in operating costs over the coming future years defense plan (FYDP).⁷⁷ However, in April 2005, the Senate blocked the move by a bipartisan vote of 58-38, complaining that there had “been no analysis to support reducing the Navy’s carrier fleet to 11 [ships].”⁷⁸ The Senate directed that the final decision on the size of the carrier force be deferred until after the completion of the ongoing 2006 QDR.⁷⁹

During the QDR, the Navy developed a new fleet target of 313 ships, including a requirement for 11 aircraft carriers—all nuclear-powered—and ten active carrier air wings.⁸⁰ With this analysis complete, the Senate finally approved the early retirement of the conventionally-powered *Kennedy*, which made its final port call in Boston on March 1, 2007.⁸¹ Soon thereafter, it was decommissioned, bringing the carrier fleet down to its target of 11 ships. In 2008, the USS *Kitty Hawk* (CV-63), homeported in Yokosuka, Japan, will retire after a distinguished service career of 47 years. Her retirement coincides with two events: the commissioning of the USS *George H.W. Bush* (CVN-77), which will make the US aircraft carrier fleet all-nuclear-powered, and the designation of the USS *George Washington* (CVN-73) as the new US carrier to be home-

⁷⁶ Dale Decamp, “Lawmakers Didn’t See Carrier at Risk,” *Florida Times-Union* (Jacksonville), January 10, 2005.

⁷⁷ See Allison Connolly, “Navy Delays Overhaul Bids on JFK,” *The Virginia-Pilot*, January 7, 2005; and Dale Eisman, “Navy Leaders Back Plans to Retire the Kennedy,” *The Virginian Pilot*, April 20, 2005.

⁷⁸ Dale Eisman, “Senate Nixes Navy Plan to Mothball *Kennedy*,” *The Virginian-Pilot*, April 21, 2005.

⁷⁹ Ronald O’Rourke, “Navy Aircraft Carriers: Proposed Retirement of the USS John F. Kennedy—Issues and Options for Congress,” Congressional Research Service, April 7, 2005. For a synopsis of the report, see Dave Ahearn, “Retiring Carrier *Kennedy* Early Entails Risks, CRS Report Says,” *Defense Today*, January 19, 2005, p. 4.

⁸⁰ Because one carrier is always in long-term overhaul and nuclear refueling, the Navy plans to maintain one fewer active air wing than carriers. A single reserve air wing is maintained for that one carrier.

⁸¹ Mark Pratt, “Kennedy Warship Makes Last Port of Call in Boston,” *Associated Press* accessed online at <http://www.foxnews.com/story/0,2933,255655,00.html> on March 21, 2007.

ported in Japan, marking the first time a US nuclear-powered aircraft carrier (CVN) has ever been permanently based in a foreign country.⁸²

Although the Navy recently revalidated a carrier force requirement for 11 ships, if current plans hold steady, the carrier force will fall to ten CVNs for a two-year period between 2013 and 2015, but will rebound and hold at 12 CVNs after 2019. Because one active fleet carrier is normally in long-term overhaul, a twelfth carrier would provide the fleet with 11 *deployable* carriers, a distinction the Navy made in the late 1980s when building up for the “600-ship Navy.” However, there are no plans to increase the number of active carrier air wings above the ten now in the fleet, meaning the eleventh carrier would be without any permanently assigned aircraft.⁸³ This point will be expanded upon later in this report.

A DECIDED US ADVANTAGE IN SEA-BASED AIRPOWER

Many naval proponents bemoan the fact that the current US carrier fleet contains “only” 11 ships. However, even though this force of 11 ships marks the smallest US large-deck carrier force since the Korean War, it is not that far off the post-Korean War average of 13.5 ships. More importantly, a force consisting of “only” 11 large-deck carriers still provides the US Navy with a great relative advantage in sea-based tactical aviation when compared to the rest of the world’s navies.⁸⁴

Maintaining even one carrier capable of catapult-launching heavy, fixed-wing tactical aircraft and recovering them back aboard with

⁸² See “USS George Washington to Replace USS Kitty Hawk as U.S. Navys Forward Deployed Carrier,” U.S. Department of Defense News Release, No. 1250-05, December 2, 2005, accessed online at <http://www.defenselink.mil/releases/release.aspx?releaseid=9128> on March 21, 2007.

⁸³ This is consistent with long Navy practice. Even before the *Kennedy* was retired and the carrier force stood at 12 ships, the Navy maintained ten active and two reserve air wings. Since the reserve wings were considered to be emergency mobilization assets, the ten active air wings rotated among the 11 deployable carriers in peacetime. Standing up an eleventh active duty CVW was a long sought-after goal of Navy aviation planners, but the high associated costs consistently thwarted their plans. For example, see David Brown, “Leaner and Meaner: The New Aviation Plan,” *Navy Times*, March 6, 2000, p. 18.

⁸⁴ “U.S. Navy Active Ship Force Levels.”

arrested landings, or even operating large, short take-off and arrested landing (STOAL) tactical aircraft, is an expensive proposition in terms of procurement, personnel, training, and operations.⁸⁵ As a result, only three foreign navies operate large-deck aircraft carriers, and even then only in small numbers—the French, Brazilian, and Russian Navies currently maintain one carrier each.⁸⁶ After the retirement of the *Kennedy*, the United States will operate 11 of the 14 large-deck carriers now in service in world navies (79 percent). Moreover, US carriers are substantially larger than the carriers found in foreign navies. The average US carrier displaces 97,605 tons at full-load displacement (FLD). The comparative figure for a foreign carrier is 44,724 tons FLD.⁸⁷ Additionally, by next year all US carriers will have nuclear power plants, giving them essentially unlimited endurance and more magazine and aviation fuel capacity than conventionally-powered carriers. The only other nation besides the United States that operates nuclear carriers is France (with one).

The disparity in carrier size, in turn, is reflected in the gap between the size and capability of US and foreign carrier air wings. A typical US CVW includes between 60 and 70 aircraft, including 44 multi-role fighters, all equipped to drop guided weapons; four E-2C Hawkeye airborne early warning aircraft; four electronic attack aircraft like the EA-6B Prowler; approximately ten anti-submarine and multi-purpose utility helicopters; and a few special supply aircraft.⁸⁸ A typical foreign carrier air wing generally has no more than 35 aircraft of all types, made up

⁸⁵ The United States spends more than \$1 billion annually to deploy, operate and maintain a single carrier strike group. From “China: the Deceptive Logic for a Carrier Fleet,” Strategic Forecasting, Inc. (STRATFOR), August 7, 2007, accessed online at http://www.stratfor.com/products/premium/read_article.php?id=293635 on August 9, 2007.

⁸⁶ Commodore Stephen Saunders, RN, ed., *Jane's Fighting Ships 2004–2005*, 107th edition (Surry, England: Jane's Information Group, Ltd., 2004); and Eric Wertheim, ed., *Naval Institute Guide to Combat Fleets of the World 2005–2006: Their Ships, Aircraft, and Systems* (Annapolis, MD: US Naval Institute Press, 2005), CD-ROM version produced by ATLIS Systems, Inc., Silver Spring, MD.

⁸⁷ Foreign FLD figures are drawn from Saunders, ed., *Jane's Fighting Ships 2004–2005*, and Wertheim, ed., *Naval Institute Guide to Combat Fleets of the World 2005–2006: Their Ships, Aircraft, and Systems*. US FLD figures come from the Naval Vessel Register. Other sources suggest that the average US carrier FLD exceeds 100,000 tons. For example, see Polmar, *The Naval Institute Guide to the Ships and Aircraft of the U.S. Fleet*, 18th edition, pp. 106–125.

⁸⁸ Descriptions of US CVWs can be found in Polmar, *The Naval Institute Guide to the Ships and Aircraft of the U.S. Fleet*, 18th edition, pp. 370–387.

of a mix of fixed- and rotary-wing aircraft. Moreover, foreign air wings contain far fewer and less capable specialized support aircraft like the aforementioned E-2C or EA-6B. To give a better picture of the great American lead in carrier aviation, the ten active US carrier air wings include over 700 aircraft of all types, while the entire rest-of-world carrier force carries less than 100 aircraft.⁸⁹

Some might complain that a focus on large-deck carriers tells only part of the story, since it fails to consider smaller carriers (CVVs) or large-deck amphibious assault ships (LHAs/LHDs) capable of operating vertical take-off and landing aircraft like the AV-8B Harrier “jump-jet,” or short take-off and vertical landing (STOVL) aircraft like the new F-35 Lightning II (Joint Strike-fighter). But even if one includes these ships in the equation, the US lead in sea-based airpower is only slightly diminished. Of the 18 such ships currently found in world navies, the British Royal Navy has three (with only two operational at any given time), while the navies of Spain, Italy, India, and Thailand operate one apiece. The remaining 11 ships are found in the US Navy. In other words, the US operates 61 percent of these types of aviation platforms—and all the remainder are operated by countries that are either US allies or friends. Additionally, as is the case for large-deck aircraft carriers, US large-deck LHAs are much larger than their foreign counterparts, and carry more aircraft. Indeed, in “carrier mode,” these ships can carry VTOL or STOVL air wings that rival or exceed the numbers of jets carried on the Brazilian and French large-deck carriers.⁹⁰ For example, at the beginning of Operation Iraqi Freedom, the USS *Bonhomme Richard* and the USS *Bataan* each carried 24 AV-8B aircraft, while at the beginning of

⁸⁹ While the Russian carrier is designed to carry a maximum of 52 aircraft (18 Su-27K and 18 MiG-29K strike-fighters, and 16 Ka-27 helicopters), it rarely carries that many. It more often operates just 22–24 Su-33 strike-fighters and six helicopters. The Brazilian carrier, the former French carrier *Foch*, carries 15–18 A-4 Skyhawks and 9–11 helicopters, for a total of 24–29 aircraft. The French CVW normally includes eight Rafale F-1 air superiority fighters, 12 Super Etendard strike-fighters, two E-2C radar aircraft, and five helicopters, for a total of 27 aircraft. See Saunders, ed., *Jane's Fighting Ships 2004–2005*, 107th edition; Wertheim, ed., *Naval Institute Guide to Combat Fleets of the World 2005–2006: Their Ships, Aircraft, and Systems*; and “Charles de Gaulle and the French Carrier Air Group,” *International Airpower Review*, Vol. 15, 2005, pp. 26–33.

⁹⁰ Saunders, ed., *Jane's Fighting Ships 2004–2005*; and Wertheim, ed., *Naval Institute Guide to Combat Fleets of the World 2005–2006: Their Ships, Aircraft, and Systems*.

Operation Enduring Freedom, the French carrier *Charles de Gaulle* embarked sixteen Super Étendard fighters, two Rafale M fighters, and two E-2C early warning aircraft.⁹¹

In summary, of the 32 aviation platforms in the world capable of operating jet aircraft at sea, the US Navy operates 22 of them (69 percent). This commanding US lead in sea-based tactical aviation will diminish only slightly over time. Three nations plan to join the large-deck carrier “club”—Great Britain, India, and China. Together, they plan to operate no more than eight carriers.⁹² Of the three current foreign operators of large-deck carriers, the French Navy plans to increase its carrier force by one, to a total of two ships.⁹³ For its part, the Russian Navy recently announced plans to expand its carrier force to six ships, although it is not clear that it will get the funds to build them.⁹⁴ The prospect for the Brazilian Navy is equally uncertain. It does not build its own carriers. It instead buys and operates foreign aircraft carriers that have been retired from service, and the number available on the market is dwindling. Perhaps Brazil might purchase one of the older small British CVVs that are to be replaced by two new large-deck British carriers anticipated by the Royal Navy. Therefore, even if all planned ships are built (an unlikely possibility) and the Brazilians can find a replacement for its current carrier, the 2020 large-deck carrier force would number no more than 29 ships: 12 American; six Russian; three

⁹¹ Journalist 1st Class (SW) Sonya Ansarov, “Bataan Breaks Harrier Embarkation Record,” *Navy News*, May 9, 2003; and J. A. C. Lewis, “French Fighters Join Action in Afghanistan,” *Jane’s Defense Weekly*, March 13, 2002.

⁹² The British are planning to replace their three small CVVs with two 60,000-ton CVFs designed to operate the STOVL variant of the Joint Strike-fighter. The Indian Navy is in the process of modifying a former Russian aircraft carrier to operate STOAL aircraft, and has plans to have a three-carrier force (composed ultimately of three indigenously-produced Air Defense Ships). See AMI International, “Indian Navy Orders Three Vikrant Carriers,” *Seapower*, July 2003, p. 43. For a good overview of Chinese thinking on aircraft carriers, see You Ji, “The Debate Over China’s Aircraft Carrier Program,” *China Brief*, The Jamestown Foundation, February 15, 2005. At this point, it appears the debate has been settled; the Chinese Navy (PLAN) appears to be preparing a former Russian aircraft carrier for use, and has stated a long-term requirement for three aircraft carriers. See Keith Jacobs, “PLA-Navy Update: The People’s Liberation Army-Navy Military-Technical Developments,” *Naval Forces*, No. 1/2007, Vol. XXVIII, especially pp. 21–24.

⁹³ The French are planning to build a second conventionally-powered carrier to complement the nuclear-powered *Charles de Gaulle*.

⁹⁴ Michael Richardson, “Challenges Ahead in Russia’s Bid to Become a Naval Power,” *The Canberra Times* (Australia), August 22, 2007.

Chinese; three Indian; two British; two French; and one Brazilian. In other words, under the worst case scenario, the United States will still operate no less than twice as many carriers as any other world navy, and as many as the next three largest carrier fleets, combined. Moreover, eight of the 17 foreign carriers would be operated by US allies or strategic partners.

Similar figures for smaller carriers are more uncertain, especially when it comes to ships that can and will operate STOVL aircraft. For example, the British and French operate three large-deck amphibious ships that can support only helicopters. The Japanese Maritime Self Defense Force plans to build four “helicopter-carrying destroyers” that look like small aircraft carriers, with a flight deck, hangar deck, and small island offset to the starboard side. While Japan has no current plans to buy any STOVL aircraft, opting instead for all-rotary-wing air groups, some analysts speculate that its ship will ultimately carry a small squadron of STOVL F-35 Lightning II Joint Strike-fighters.⁹⁵ Similarly, the South Korean Navy plans to operate three task forces built around large-deck LHDs, and the Australian Navy plans to build two LHDs, but neither navy has announced plans to operate STOVL aircraft from their ships. The only two countries that definitely intend to operate STOVL naval aircraft from small carriers are Spain and Italy. Both of their navies plan to replace their current AV-8Bs with STOVL versions of the Joint Strike-fighter. The long-range plans for the Thai Navy, which operates a small “Harrier carrier,” are at best uncertain. In contrast, the US plans to maintain 11 large-deck LHAs for the foreseeable future, all capable of supporting 20 or more STOVL aircraft.⁹⁶

Therefore, through at least 2020, and likely well beyond, the US Navy will continue to enjoy an unchallenged advantage in sea-based aviation relative to other navies—and with it a concomitant advantage in fleet defensive and offensive firepower. No other navy or group of navies comes close to matching the size, flexibility, or lethality of the US naval air arm. Currently, within just 30 days, the Navy can dispatch six CVNs and their embarked air wings to an emerging crisis overseas—a carrier force larger than any other world navy—along with numerous missile-armed surface combatants and logistics ships, all supported

⁹⁵ Wendell Minnick, “Japan’s New Ship: Destroyer or Carrier?” *Defense News*, September 3, 2007.

⁹⁶ The Navy plans to operate nine LHDs and one LHA-6 (formerly the LHAR) in its active amphibious fleet, and two modified LHA-6s in its planned Maritime Prepositioning Force Future squadron.

by attack and conventional guided-missile submarines, land-based maritime patrol aircraft, and additional surface combatants and logistics vessels.⁹⁷ Once assembled off a distant coast, this combined Carrier Strike Force⁹⁸ can remain for long periods in its operating area, performing independent strike missions or supporting joint forces operating ashore, with nearly 300 high-performance strike-fighters and electronic attack aircraft, 24 E-2 AEW aircraft, and nearly 100 multi-mission helicopters (counting those found on carrier escorts).⁹⁹ As vividly demonstrated during the Korean War over five decades ago, being able to quickly assemble—in any region of the world—an air force larger than those found in most countries—and one that can operate on the high seas without the political or operational constraints that often come with operating from land bases on foreign soil—affords the United States enormous operational flexibility and global freedom of action.

WHY CHANGE WHILE STILL ON TOP?

Given the Navy's great relative advantage in sea-based tactical aviation, even the most vocal advocate of change might question why the 2006 QDR directed the Navy to develop an unmanned, stealthy, longer-range carrier-based aircraft capable of being air-refueled. Said another way, why did the Office of Secretary of Defense feel compelled to direct the Navy to pursue a major change to its sea-based tactical aircraft fleet while still clearly on top of the hierarchy of the sea-based aviation competitors?

There seem to be two ready answers to this question. First, leaders inside OSD apparently believed that the current US naval air wings were operationally and tactically deficient in some way, and although

⁹⁷ As will be described later in this report, the Navy's Flexible Response Plan (FRP) synchronizes the carrier force maintenance and training cycle so that the planned 11 carrier force will be able to generate six deployable Carrier Strike Groups within 30 days, and another deployable Carrier Strike Group within 90 days. The FRP is thus often referred to as the "6+1" plan.

⁹⁸ A naval task force built around a single aircraft carrier is known as a Carrier Strike Group, or CSG. A naval task force with multiple carriers is known as a Carrier Strike Force, or CSF.

⁹⁹ Owen R. Cote, Jr., *The Future of Naval Aviation* (Boston, MA: Massachusetts Institute of Technology (MIT) Security Studies Program, Conference Series Report No. 6, February 2006), p. 11. This report can be accessed online at http://web.mit.edu/SSP/people/cote/MIT_SSP_FutureofNavalAviation.pdf.

these deficiencies were not particularly relevant at this time, they would work to diminish the US carrier fleet's great operational and tactical advantages over time. They also apparently believed that an unmanned, longer-range, air-refuelable naval UCAS was the most promising way to correct these perceived deficiencies.

Second, leaders inside OSD apparently concluded that the Navy would not likely pursue a carrier-based UCAS on its own without outside direction and pressure. The naval UCAS is a perfect example of what Clayton M. Christenson, an expert in institutional change, calls a disruptive technology. Christenson believes that a new "disruptive technology comes to dominate an existing market by either filling a role in a new market that the older technology cannot fill...or by successively moving up-market through performance improvements until finally displacing the market incumbents."¹⁰⁰ However, his research suggests that it is all too easy for highly successful companies or competitors to ignore potential disruptive innovations, since at first they often compare badly with existing technologies or "products," and the "market" for a disruptive innovation appears very small compared to that of the established technology. Moreover, even if the potential for a disruptive innovation is recognized by an organization's leaders, they are often reluctant to pursue it precisely because it would directly compete with their existing, more profitable, and more comfortable technological approach.¹⁰¹ As a result, dominant competitors often fail to recognize or embrace a disruptive innovation, and have a much harder time accepting that their tried-and-true technologies and associated competitive strategies may no longer be up to emerging market challenges.

In other words, leaders inside the Office of the Secretary of Defense evidently concluded that an unmanned, longer-range, air-refuelable naval UCAS is the answer to perceived carrier air wing deficiencies that will work to reduce future effectiveness of the US aircraft carrier fleet. However, because a naval UCAS represented a classic disruptive technology, the Navy would not likely pursue it on its own if left to its own devices. OSD therefore felt compelled to direct the Navy to initiate the UCAS-D program.

¹⁰⁰ "Disruptive Technology," accessed online at http://en.wikipedia.org/wiki/Disruptive_technology on August 1, 2007. Christenson's work initially referred to "disruptive technologies," but he later modified the definition of radical change to "disruptive innovation."

¹⁰¹ Ibid.

If this supposition is true, what deficiencies in CVW capabilities might a naval UCAS aim to improve? The answer to this question is found in a historical review of US carrier air wings.

IV. Carrier Air Wings: Learning to Live with a Lack of Reach

A FOCUS ON (SHORT-RANGE) POWER-PROJECTION

The offensive and defensive power of an aircraft carrier derives from its aircraft. Without its embarked air wing, a carrier is bereft of combat power and is little more than a large, defenseless target. As a result, the Navy has long sought to develop and field the most capable carrier aircraft possible, with the best combination of range, endurance, payload, and flying characteristics.

The intense carrier air battles that took place between the US and Imperial Japanese Navies in 1942 and 1943 were fought between roughly symmetrical air wings. Although Japanese carrier aircraft slightly outranged their US adversaries, the difference was small enough that carrier battles turned on which force could first find and effectively attack the opposing carrier force.¹⁰² However, after the Battle of the Philippine Sea in June 1944, when the US Navy destroyed the Japanese carrier aviation force, American carrier forces have never again had to fight against an enemy with equally strong carrier forces. Indeed, as suggested by the previous chapter, no navy since World War II has tried to challenge the US carrier force symmetrically by creating a similar-sized fleet of aircraft carriers. Instead, and as will be discussed at length later in this report, the Navy's adversaries more often opted to take on carriers asymmetrically, primarily with submarines or long-range, land-based maritime strike aircraft—or both—using heavyweight

¹⁰² For a good discussion of these carrier air battles, see Hughes, *Fleet Tactics and Coastal Combat*, 2nd edition, pp. 99–107.

torpedoes and anti-ship cruise missiles. As a result, US carriers have served primarily as power-projection platforms that conduct strikes against land targets.

While attacking land targets is a job in which American carriers have always excelled, CVW strike capacity has especially improved since the end of the Cold War. During the 1990s, CVW air strikes gradually shifted from a reliance on “dumb bombs” to guided air-to-ground weapons. These weapons greatly increased the effectiveness of carrier air wing strikes, which were generally delivered in permissive (i.e., largely uncontested) operational environments.¹⁰³ As carrier aviators like to point out, with every single “striker” in the CVW capable of delivering guided weapons, day or night, and in any weather, by 2001 a single aircraft carrier could launch attacks against 693 different “aimpoints” a day. In comparison, the typical CVW that helped to win Operation Desert Storm just ten years earlier could strike only 162 aimpoints a day.¹⁰⁴

As impressive as these figures sound, however, they come with an important caveat: *they assume all the targets are located no more than 200 nm from the carrier.*¹⁰⁵ At ranges beyond 200 nm, the number of aimpoints that can be attacked on any given day drops rapidly as transit time to and from the target increases and other factors, such as the delays required for aerial refueling, come into play. The aforementioned metrics emphasize that the carrier’s short-range striking ability is both reflected and reinforced by the relatively short unrefueled ranges characteristic of US aircraft since World War II. Indeed, since that time, the typical unrefueled combat reach of US carrier aircraft has seldom exceeded 600 nm.

What accounts for the relatively short reach of US carrier aircraft? There are myriad reasons, but three stand out above all others: the inherent limitations that carrier operations impose on aircraft size

¹⁰³ Cote, *The Future of Naval Aviation*, p. 11.

¹⁰⁴ An aimpoint is the location or object which a single guided weapon is directed against. Depending on its size and nature, and the effectiveness of the guided weapon, striking multiple aimpoints might be required to bring about the desired effect on a target, be it destruction, neutralization, suppression, or harassment. Destroying a point target such as a bunker might require a single aimpoint per attack; destroying a large building might require multiple aimpoints per attack. Lieutenant Commander Ed Langford, *CVW Strike Sortie/Aimpoint Improvement*, unclassified point paper (Washington, DC: Department of the Navy (N8QDR), January 18, 2001).

¹⁰⁵ See Langford, *CVW Strike Sortie/Aimpoint Improvement*.

and performance; the lack of a consistent post-war demand signal for increased carrier aircraft range; and the development of reliable and safe air-to-air refueling techniques.

DEALING WITH AN INHERENT RANGE DISADVANTAGE

Carrier aircraft have long suffered a range disadvantage relative to comparably-sized land-based planes. Longer-range aircraft traditionally come with a size penalty: the longer the range, the larger the plane. Because of the cramped nature and limited size of a carrier deck, as well as the weight limitations of catapult systems, the maximum size of carrier aircraft is inherently constrained, which also naturally constrains its maximum unrefueled range. In addition, whatever their size, as implied above, piston- and jet-engined tactical aircraft operating from a relatively small carrier deck are necessarily designed for either catapult launch or extremely short take-off runs, and are strongly built (and thus relatively heavy) to survive the stresses and strains of repeated catapult “shots” and arrested landings. Land-based aircraft do not need the heavy landing gear and structure required for naval aircraft, and can make longer take-off and landing runs, especially when carrying heavy combat loads. Because of all of these factors, carrier aircraft generally have a shorter unrefueled combat radius, or can carry less weight over similar ranges, than comparably-sized land-based planes.

The tactical ramifications of operating carrier aircraft with an inherent range disadvantage vis-à-vis land-based planes were not immediately apparent. In 1929, when the fleet first practiced using aircraft carriers to attack land targets, the disparity in range between aircraft that operated from ship and from land was not that great. Under these circumstances, the carrier’s great advantage in mobility appeared to give it a leg up against land-based air forces. Because the carrier fleet knew approximately where its fixed land targets were, it did not have to scout to find them and could maneuver freely to strike them at a time and from a direction of its choosing. The land-based air forces, on the other hand, had to actively search for the carrier before they could strike it. In fleet problems, carriers were therefore able to routinely strike first. By the late 1930s, however, land-based bomber aircraft began to out-range—by a substantial margin—carrier aircraft. This greatly increased

the likelihood that a carrier would be found and attacked before its planes could come close enough to reach their targets. As a result, naval planners concluded that unless carrier aircraft range could be substantially increased, the carrier should not be used to attack well-defended land bases, ports, or targets.¹⁰⁶

The nature of the subsequent Pacific campaign denied carrier aviators the option of avoiding attacks against enemy land targets. However, up through 1944, naval aviators were surprised to find that the disparity between carrier- and land-based aircraft ranges did not present a major tactical problem, primarily because of an unexpected relative advantage in numbers. The air strikes mounted by the Japanese from the small air bases located on the outer edge of their island-based defensive perimeter proved to be too small to overwhelm a carrier task forces' air defenses, especially after the Navy effectively combined ship-board radar, combat information centers (CICs), radio-directed combat air patrols (CAPs), and proximity fuses to forge ever-more capable anti-air defenses. Correspondingly, the concentrated strikes of three or four carriers could easily overwhelm local Japanese air defenses.¹⁰⁷

AN INCREASING DEMAND FOR RANGE

It was not until the American westward Pacific advance reached the Philippines and the islands close to mainland Japan that pre-war worries over launching carrier strikes against land targets proved to be well-founded. US fast carrier forces were forced to steam in relatively confined operating areas close to US lodgments ashore, within easy range of large numbers of both short- and long-range land-based aircraft. As a result, they were subjected to repeated, intense attacks. Worse, the Japanese began employing *kamikaze* suicide bombers, which had double the range of most carrier aircraft (because they only had to fly a one-way mission), and which came in relatively small numbers and on multiple headings. Some approached at very low altitude, making them more difficult to detect on radar. These attacks, more akin to cruise missile than aircraft strikes, proved much more difficult to defend against than traditional enemy aerial bombing and torpedo attacks.¹⁰⁸

¹⁰⁶ Friedman, *U.S. Aircraft Carriers: An Illustrated Design History*, p. 13.

¹⁰⁷ *Ibid.*, pp. 13–16.

¹⁰⁸ *Ibid.*, p. 14.

Under these circumstances, the Navy had three different options. The best option would be to get longer-range aircraft on the carrier decks to give the carriers greater standoff range, and therefore greater freedom of action. Indeed, by late 1944, Vice Admiral Marc Mitscher had concluded that the future of carrier aviation would lie in larger, heavier aircraft capable of carrying larger bomb loads over longer ranges than the current generation of carrier planes. About this time, the Essex-class carrier *Shangri-La* successfully catapulted and recovered a medium PBJ-1H bomber (a naval variant of the famous B-25 Mitchell that flew the Doolittle raid from US carriers in early 1942).¹⁰⁹ However, the PBJ experiment was just a test, not a viable tactical option. Therefore, in July 1944, the Navy ordered a new longer-range carrier bomber which would eventually become the famous A-1 Skyraider. Unfortunately, this new bomber aircraft would not reach the fleet until after the war.¹¹⁰ As a result, US carrier forces remained outranged by land-based attackers until the Japanese surrender.

Denied the option of standing off and attacking targets from beyond the effective range of Japanese air forces, the second option was to go *deeper* inside the enemy's strike envelope in order to destroy enemy airfields and aircraft on the ground—a form of offensive counter-air operation. Of course, this meant the carrier would be under threat of attack long before its own aircraft were in range of their targets. Therefore, the CVW needed to be as adept at fighting off *kamikaze* attacks as it was at dropping bombs. By the summer of 1945, the air wings on the CVs included two fighter squadrons (36 aircraft), two fighter-bomber squadrons (36 aircraft), and one composite bomber squadron of 30 torpedo and dive bombers. This make-up provided both great defensive and offensive flexibility: 72 of the CVW's 102 planes could fight off *kamikazes* and air attacks, while 66 of the planes in the wing could be used to attack enemy airfields and planes on the ground.¹¹¹

¹⁰⁹ *Ibid.*, pp. 14, 230–231.

¹¹⁰ The A-1 Skyraider reached the fleet in December 1946. Although it missed the Second World War, it served with distinction in both Korea and Vietnam. See “A-1 Skyraider,” accessed online at http://en.wikipedia.org/wiki/A-1_Skyraider on July 17, 2007.

¹¹¹ In practice, the aircraft in the “fighter” squadrons were also capable of carrying and delivering bombs. Therefore, all 102 aircraft could theoretically be used to strike enemy airfields. However, fighter squadrons normally carried only drop tanks and air-to-air armament, and concentrated on protecting bombing aircraft from enemy fighter attack. Friedman, *U.S. Aircraft Carriers: An Illustrated Design History*, p. 16.

The next option was to improve the task force's inner defenses. The near-term solution was to increase the density and effectiveness of carrier task force CAPs. Toward that end, the CVs all received extra fighter squadrons. In addition, the CVLs that accompanied every fast carrier task force converted to all-fighter air wings dedicated to fleet air defense. In addition, the Navy began experimenting with airborne early warning radars to help detect single *kamikazes* attacking at low level. The long-term solution was to replace the task force's radar-directed guns with guided missiles, to destroy attackers long before they entered their terminal attack runs. But once again, the expected arrival date of these new weapons was far in the future.¹¹²

By 1945, these steps, coupled with America's overwhelming naval superiority, meant that even concerted Japanese *kamikaze* attacks could not stop the inexorable advance of US carrier and amphibious task forces.¹¹³ However, the experience of fighting against an opponent that outranged its own carrier aircraft spurred the US carrier community to seek larger, heavier, and much longer-range aircraft. The largest and longest-legged aircraft in the typical end-of-war CVW, the TBF/TBM Avenger, had a loaded weight of only 17,900 pounds, and a maximum combat radius of just over 400 nm while carrying 2,000 pounds of bombs.¹¹⁴ In December 1945, Navy aviators sketched out their plans for a new generation of strike aircraft, including three different planes with unrefueled combat ranges of 300, 1,000, and 2,000 nm while carrying 8,000 pounds of bombs. Their respective planned gross take-off weights were 30,000, 45,000, and 100,000 pounds—between 1.7 and 5.6 times that of the World War II Avenger.¹¹⁵

On a crowded carrier deck, the pursuit of much larger aircraft size carried with it several disadvantages. The two largest of the planned planes would likely be too big to move down to the carrier's hangar deck, which meant they would have to remain permanently parked on the flight deck. This would complicate landing and take-off operations, especially on axial decks.¹¹⁶ Larger planes would also take up more deck space, which meant that fewer could be carried. Navy planners thus naturally concluded that future aircraft carriers would have to be

¹¹² Ibid., pp. 15–16.

¹¹³ Ibid., p. 16.

¹¹⁴ See “TBF Avenger,” accessed online at http://en.wikipedia.org/wiki/TBF_Avenger on July 17, 2007.

¹¹⁵ Friedman, *U.S. Aircraft Carriers: An Illustrated Design History*, p. 231.

¹¹⁶ This was especially a problem before the angled flight deck was invented. See Friedman, *U.S. Aircraft Carriers: An Illustrated Design History*, p. 233.

substantially bigger than even the three larger fleet carriers (CVBs) laid down late in the war. Even these impressive ships would find operating 45,000- and 100,000-pound aircraft difficult.¹¹⁷

A NEW DEMAND FOR LONGER RANGE

After the war ended, the Navy soon concluded that it would have to learn to live with the problems of operating larger, heavier, and longer-range aircraft on its carrier decks. As mentioned earlier, in the immediate post-war period, the Navy found itself with no fleet to fight. The most likely US adversary, the Soviet Union, was a continental land power with great strategic depth. Because of the relatively short ranges of their embarked aircraft, the potential contributions of US aircraft carriers in the event of a major war seemed minor, at best, limited to attacks on Soviet naval ports and shipyards and harrying strikes along the periphery of Soviet territory. This seemed especially true given the widespread assumption that any future war with the Soviet Union would require using atomic bombs to destroy its industries. This perception was one of the primary reasons that the Navy carrier force lost out to Air Force strategic bombers in the immediate post-war budget deliberations, and why the carrier fleet was gutted between 1945 and 1950.¹¹⁸

In the first years after the war, Navy leaders vigorously tried to counter Air Force arguments favoring the effectiveness of strategic bombing. However, it soon became clear to them that the fiscal savings promised by a focus on long-range, atomic airpower were simply too alluring for the nation's political leadership to pass up. Intent on preventing an Air Force monopoly in strategic (i.e., atomic) attack, the Navy moved to offer an alternative to Air Force long-range bombers. In 1948, a Navy study concluded that four carrier battle forces (each composed of one CVB and two modernized Essex-class carriers), dispersed in the Barents, North, Mediterranean, and Arabian Seas, and armed with longer-range aircraft, could reach most targets of interest inside the Soviet

¹¹⁷ The *USS Midway*, the first of a new class of three CVBs, was laid down in 1943 and commissioned just as the war ended. It had a designed full-load displacement of 60,100 tons, compared to the 36,380 tons of the Essex-class CV. The original impetus for larger carriers was to allow for larger air wings and to provide more protection. Chapter 9, "Midway Class," in Friedman, *U.S. Aircraft Carriers: An Illustrated Design History*.

¹¹⁸ *Ibid.*, pp. 18–23.

Union.¹¹⁹ The Navy also noted that Moscow was only 1,200 nm from the Barents Sea, north of Murmansk, and 1,500 nm from the eastern Mediterranean in the upper reaches of the Aegean Sea.¹²⁰ These facts were used by the Navy to justify both larger “super carriers” focused on strategic attack (i.e., CVAs) and “heavy” carrier nuclear-strike bombers with greater range. In other words, in response to a bureaucratic challenge that threatened the existence of US carriers, the need to launch nuclear strikes deep inland replaced the need to level the range disparity between CVW aircraft and land-based aircraft as the primary rationale for longer-range carrier aircraft.¹²¹

Intent on demonstrating a carrier-based nuclear-strike capability as soon as possible, the Navy converted 12 large P2V-3C Neptune land-based ASW patrol aircraft into interim carrier heavy attack aircraft. However, even though they were given arresting gear, the aircraft were simply too big to attempt a carrier landing. Moreover, they were far too big for the catapults of the time. Harkening back to the desperate days of the Doolittle Raid, the plan therefore was for these aircraft to take off from US carriers using a jet-assisted take-off (JATO), and to ditch after the delivery of their nuclear bombs.¹²²

The Navy’s first purpose-built heavy (nuclear) attack aircraft, the A-2 Savage, entered service in 1949—although the original design impetus for the aircraft was likely to simply carry a heavy conventional payload over longer ranges than possible with single-engined aircraft.¹²³ The 1946 contract to build the bomber was based on the 45,000-pound aircraft with a combat radius of 1,000 nm first envisioned in 1945.¹²⁴ However, the operational A-2B version of the plane was powered by

¹¹⁹ Ibid., pp. 18–20.

¹²⁰ See “AJ (A-2) Savage,” accessed online at <http://globalsecurity.org/military/systems/aircraft/aj.htm> on July 17, 2007.

¹²¹ In the immediate post-war period, the Soviets lacked long-range maritime strike aircraft, which gave the Navy great confidence that they could operate from waters relatively close to the Soviet Union without great risk.

¹²² Friedman, *U.S. Aircraft Carriers: An Illustrated Design History*, p. 247.

¹²³ As discussed earlier, the Navy began developing a long-range, heavy-payload, carrier-based bomber well before there was a requirement for a carrier aircraft able to carry atomic bombs. However, ability of the AJ Savage to accommodate the large, heavy early atomic weapons proved vital to the Navy’s post-war argument for the retention of aircraft carriers as nuclear-strike assets. See Jerry Miller, *Nuclear Weapons and Aircraft Carriers* (Washington: Smithsonian Institution Press, 2001), pp. 90–99.

¹²⁴ Friedman, *U.S. Aircraft Carriers: An Illustrated Design History*, p. 244.

three engines, two turboprop and one jet, and it was heavier than planned (51,000 pounds). As a result, it never came close to achieving its planned 1,000-nm mission radius. In service, the plane proved capable of conducted unrefueled strikes out to about 700 nm from the carrier.¹²⁵ As a result, the Navy's first assigned nuclear targets, designated in 1950, were against Soviet naval assets located within a 600-nm radius of the Mediterranean and Norwegian Seas in the Atlantic theater of operations, and of the Bering Sea in the Pacific.¹²⁶

By February 1954, the JCS approved US Navy participation in the strategic integrated operations plan (SIOP).¹²⁷ Soon thereafter, in 1956, CVW heavy attack squadrons began trading in their A-2Bs for the new A-3B Skywarrior, an all-turbojet aircraft weighing in at nearly 78,000 pounds, about midway between the 40,000-pound and 100,000-pound carrier aircraft envisioned in 1945. However, while much bigger and heavier than the Savage, its unrefueled combat radius was only about 200 nm longer (900 nm). Moreover, the plane's large size—which quickly earned it the nickname “Whale”—cut down on the potential number of aircraft even the larger post-war CVAs could carry.¹²⁸

Like most US jet bombers, the Skywarrior traveled to its targets at subsonic speeds, making it vulnerable to the newer generation of Soviet jet interceptors.¹²⁹ The Navy therefore next designed a more powerful, twin-engined, supersonic strike aircraft, which entered service in June 1961 as the A-5 Vigilante. While the Vigilante was about the same length as the Skywarrior, its wingspan was shorter and it weighed less. Nevertheless, it could fly missions up to 1,135 nm miles from a carrier—the

¹²⁵ “AJ (A-2) Savage.”

¹²⁶ Friedman, *U.S. Aircraft Carriers: An Illustrated Design History*, p. 22.

¹²⁷ *Ibid.*

¹²⁸ See “A-3 (A3D) Skywarrior,” accessed online at <http://globalsecurity.org/military/systems/aircraft/a-3d.htm> on July 17, 2007.

¹²⁹ The preponderance of subsonic bombers was no accident. It emerged from analyses in which the US Air Force found that sustained supersonic flight required an unacceptable reduction in payload and range. Moreover, while high-altitude supersonic speed enabled a bomber to escape Soviet interceptors, such bombers remained vulnerable to surface-to-air missiles (SAMs). The SAM threat forced bombers to penetrate at low altitudes, which as a practical matter precluded sustained supersonic flight. Accordingly, of the 4,400 Strategic Air Command bombers ultimately purchased, only 116 B-58s, 76 FB-111s, and 100 B-1s had supersonic capabilities.

longest reach of any post-war heavy carrier bomber. That said, it achieved little more than half the 2,000-nm carrier strike radius long desired by fleet planners.¹³⁰

A DISAPPEARING DEMAND FOR CARRIER HEAVY ATTACK

The Vigilante was the Navy's last heavy attack aircraft, and it operated in that role for only a very short period of time. In 1960, the Navy's nuclear strike mission was being taken over by submarine-launched ballistic missiles (SLBMs), carried aboard newly developed nuclear-powered strategic ballistic missile submarines (SSBNs). The SSBNs could operate close to the Soviet Union without much fear of being discovered or attacked. SLBMs not only had longer strike ranges than carrier-based aircraft, but they had a far higher probability of penetrating the increasingly dense and capable Soviet air defenses. In addition, they placed no aircrew at risk when doing so. Moreover, by the early 1960s, a one-megaton nuclear bomb weighed no more than 2,000 pounds.¹³¹ Consequently, even the smallest light attack aircraft like the A-4 Skyhawk could deliver tactical nuclear strikes over ranges beyond 600 nm when using aerial refueling.¹³² All this prompted the Navy to halt further procurement of the Vigilante in 1963, and to shift its existing aircraft to a supersonic reconnaissance and conventional strike role. In the process, the Vigilante was redesignated the RA-5C.¹³³

With the shift of the Navy nuclear strike mission from carriers to submarines and the ability of smaller carrier-based aircraft to deliver nuclear weapons, the operational demand for carrier aircraft with longer unrefueled ranges disappeared completely. It had long ago disappeared

¹³⁰ See "A-5 Vigilante," accessed online on June 25, 2007; and Dr. William J. Armstrong, "Appendix 1, Aircraft Data—Technical Information and Drawings," accessed online at <http://www.history.navy.mil/download/app1-1.pdf> on June 25, 2007.

¹³¹ Miller, *Nuclear Weapons and Aircraft Carriers*, p. 126.

¹³² Indeed, the diminutive A-4 was designed as a tactical nuclear bomber with little conventional attack capability. However, it later evolved to a terrific light attack aircraft. Friedman, *U.S. Aircraft Carriers: An Illustrated Design History*, p. 21; and "A-4 Skyhawk," accessed online at http://en.wikipedia.org/wiki/A-4_Skyhawk on June 24, 2007.

¹³³ See "A-5 Vigilante."

for conventional strike operations. As fate would have it, the great air battles that raged first between US and Japanese carrier fleets, and then between US carrier forces and Japanese land-based air and missile (i.e., *kamikaze*) forces, were not repeated during the Cold War. During the Korean and Vietnam Wars, Navy carriers seldom needed to exploit their operational mobility. Instead, they remained in restricted launch areas close off the coast, from which they launched attacks against land targets or provided close air support to troops operating ashore. Under these circumstances, carriers would fly two or three days of continuous strikes, and then spend a day replenishing aviation gas, air ordnance, and ship fuel and supplies.¹³⁴

The Navy's operational patterns in the Korean and Vietnam Wars shared several things in common. The opponents were geographically small, were accessible to naval tactical aviation, and were unable to pose any serious naval or land-based counter-carrier threat. US carriers could therefore freely operate short-ranged aircraft from operating areas located close to the enemy's coast with little fear of attack. Indeed, between 1945 and 1989, while sailors died onboard carriers due to accidents, fires, or inadvertent explosions, none died due to enemy action. Moreover, throughout the Cold War, "limited wars" were properly considered more likely than nuclear war with the USSR, and the SSBN force provided plenty of nuclear strike capacity. The Navy thus logically sought aircraft that maximized utility in the most likely operational scenarios instead of ones that were specialized for the least likely scenario. This is not to say that naval aviators were unaware of the need to prepare for nuclear war. Indeed, every carrier-based attack aircraft could deliver nuclear weapons, and naval aviators prepared and trained for nuclear missions from the 1950s until 1991. However, the demand for long-range aircraft suitable for this extremely unlikely contingency was clearly much lower than the demand for shorter-range aircraft suitable for limited war. In other words, *the operational demand for US carrier aircraft with greater independent range largely disappeared after World War II, and especially after the early 1960s.*

¹³⁴ Friedman, *U.S. Aircraft Carriers: An Illustrated Design History*, p. 21.

A CHANGING RELATIONSHIP BETWEEN SIZE AND RANGE

Another key factor that helped to dampen the demand signal for carrier aircraft with greater unrefueled combat ranges was the early post-war development of air-to-air refueling. Although aerial refueling was first demonstrated in the 1920s, US military aviators did not seriously pursue the technique until after World War II, when the newly formed Strategic Air Command (SAC) wrestled with the problem of delivering nuclear strikes against targets located deep inside the Soviet Union. The first post-war nuclear bomber, the B-50, was a modified Second World War B-29 with an unrefueled combat radius of just under 2,100 nm, a reach far shorter than that necessary to cover all the targets inside the Soviet Union, even when flying from forward bases. A logical solution was to refuel the bombers in the air just outside defended Soviet airspace, thereby enabling them to exploit their full unrefueled combat radius over Soviet territory.¹³⁵

The first aerial refueler, the KB-29, was also a converted B-29 bomber, equipped with fuel tanks in its bomb bay and a workable, but complicated, fuel dispensing system.¹³⁶ In 1949, the Air Force demonstrated the globe-spanning potential of this system. Aided by four in-flight refuelings from KB-29s, a B-50 flew around the world in 94 hours without ever touching down at an air base. However, this refueling technique was only a stop-gap measure until better techniques could be developed.¹³⁷

These improvements were not long in coming. The first was a new probe and drogue refueling system, mounted on modified versions of the KB-29. This system consisted of several hose dispensing systems,

¹³⁵ Note that the 1945 Navy goal was a 100,000-pound carrier bomber that matched the unrefueled reach of the B-29. See “B-50 Superfortress,” at <http://www.globalsecurity.org/wmd/systems/b-50.htm>; and “Aerial refueling,” at http://en.wikipedia.org/wiki/Aerial_refueling. Both websites were accessed online on July 21, 2007.

¹³⁶ A KB-29 would trail a “contact line” with a 50-pound weight in its slipstream. A B-50 would trail a similar cable with a grappling hook, called the “hauling line.” Once the hauling line snagged the contact line, the KB-29 would reel in both lines, and a tanker operator would attach the KB-29’s refueling hose to them. The B-50 crew would then reel in the hose, and attach it to the plane’s fuel system. Finally, a contact signal started pumping fuel from the KB-29 to the B-50. See “Tankers,” accessed online at <http://www.fas.org/man/dod-101/sys/ac/tanker.htm> on July 21, 2007.

¹³⁷ See “B-50 Superfortress;” and “Aerial refueling.”

known as powered hose drum units, or “Hoodooos.” Each Hoodoo could reel out a hose in the slip stream behind the KB-29, stabilized by a para-drogue with a refueling receptacle inside. Pilots in trailing planes equipped with an extendable refueling probe would then “fly” their probes into one of the tanker’s para-drogues, seeking to establish a firm transfer connection. Once the probe and drogue were securely coupled, fuel would flow from the tanker to aircraft via the hose. Obviously, this technique was far superior to—and safer than—the earlier “dangle and grapple” system.¹³⁸

Despite the success of the probe and drogue system, General Curtis LeMay, the first commander of the Strategic Air Command, demanded a system capable of transferring fuel at faster rates than flexible hose systems. The Air Force hired Boeing to build an aerodynamically controlled, swiveling, telescopic refueling system which became known as the “flying boom.” The boom was controlled by an operator in the KB-29’s tail turret, who “flew” the boom into an exterior fueling receptacle on the trailing aircraft. The flying boom had a much higher transfer rate than the probe and drogue system, and therefore made aerial refueling much faster—an important consideration on long-range nuclear strike missions. This method proved so successful that it informed the design of all subsequent generations of Air Force tankers, and was adopted as the standard aerial refueling technique for all Air Force strategic and tactical aircraft.¹³⁹

Although the Navy followed these early Air Force refueling developments with interest, it was not until 1953 that naval aviators began to modify their aircraft for aerial refueling.¹⁴⁰ Perhaps the final impetus came from a vivid demonstration of the potential for “tactical” aerial refueling. On May 29, 1952, an Air Force KB-29M equipped with a probe and drogue system supported a flight of 12 Air Force F-84 fighter-bombers on a strike from their home base in Itazuke, Japan against targets located near Sariwon, North Korea. For carrier aviators, the implications were profound: with aerial refueling, smaller, shorter-range “medium” and “light” strike aircraft could now attack targets at ranges that previously would have required a much larger “heavy” bomber. This was especially attractive to naval aviators, as they could substitute a greater number of smaller airplanes for a fewer bigger ones in the

¹³⁸ “Tankers.”

¹³⁹ See “Aerial refueling;” and “KC-97 Stratotanker,” accessed online at http://en.wikipedia.org/wiki/KC-97_Stratotanker on July 21, 2007.

¹⁴⁰ See “AJ (A-2) Savage.”

CVW, increasing the carrier's overall aircraft capacity without losing much potential strike reach. Moreover, carrier aviators soon learned an additional benefit from aerial refueling: the maximum take-off weight for a catapult shot was generally less than the maximum weight with which a carrier aircraft could stay airborne. This meant that a light or medium attack aircraft could take off with a partial fuel load, trading less fuel weight for more ordnance. Once at cruising altitude, a plane could take on a full load of fuel from a carrier-based "mission tanker" to maximize its strike reach, and proceed with a far heavier combat load than would otherwise be possible.¹⁴¹

The shift of the Navy's strategic nuclear strike mission to submarines also contributed to the ultimate doom for heavy carrier bombers with long unrefueled combat ranges. Submarine-launched ballistic missiles allowed the Navy to deliver nuclear attacks far beyond the 2,000-nm unrefueled strike radius that had spurred the development of heavy attack aircraft in the first place. At the same time, light and medium attack aircraft could deliver tactical nuclear strikes over shorter ranges—and these aircraft were much better suited for the sustained air campaigns mounted from carriers operating close off the coasts of Korea and Vietnam.

Ironically, then, the few large, longer-range aircraft that remained on the carrier decks often ended their careers operating as carrier-based tanker aircraft to extend the range of their shorter-ranged brethren. The first carrier-based aerial tanker was a modified version of the A-2 Savage bomber. Because of their arresting gear and steeper angles of departure when taking off and landing onboard carriers, the new KA-2A tankers could not be fitted with a flying boom system like those found on Air Force tankers. The KA-2A was thus fitted with a probe and drogue system, which became the standard Navy refueling system for all subsequent carrier-based tanker aircraft. Accordingly, starting in 1953, most naval aircraft were gradually fitted with extendable refueling probes.¹⁴²

The KA-2A carrier tanker was replaced, in turn, by the KA-3B, a modification of the A-3 Skywarrior. This tanker could lift up to 5,026 gallons (34,178 pounds) of fuel, and ably supported Navy carrier strike operations over Vietnam and through the end of the Cold War. The A-3B bomber was also converted into an electronic attack aircraft, known as

¹⁴¹ See "Aerial refueling."

¹⁴² "AJ (A-2) Savage;" and "Aerial refueling."

the EA-3B. These aircraft accompanied strike missions over Vietnam, jamming enemy SAM radars and communications. Both of these A-3B conversions survived their more expensive and harder-to-maintain intended successor, the A-5 Vigilante, which as previously mentioned ended its relatively short career in 1979 not as a nuclear bomber, but as a reconnaissance platform used to support strike planning for the CVW's light and medium attack aircraft.¹⁴³

In the end, these large carrier aircraft conceded even their specialized niche roles to their smaller brethren. KA-6D tankers replaced the A-3B tankers. These aircraft were modified versions of the A-6 medium bomber, equipped with a centerline probe and drogue installation and up to five 500-gallon underwing fuel tanks.¹⁴⁴ Similarly, a heavily modified version of the A-6 bomber, the EA-6B, replaced the EA-3D in the electronic attack role. Finally, specially-modified Marine Corps RF-4B Phantoms and F-14 Tomcats carrying a Tactical Air Reconnaissance Pod System (TARPS) replaced the RA-5C in the reconnaissance role.¹⁴⁵ On crowded carrier decks, these large, heavy aircraft could simply not longer be justified, and they disappeared entirely.

LOCKING IN

Summing up, the lack of any serious naval or land-based threat to US carriers in any of America's "hot" wars, the shift of the Navy's strategic strike mission from the carrier to the submarine force, and the development of aerial refueling all gradually worked to focus the CVW on power-projection operations and attacking land targets. When supporting sustained air campaigns from operating areas close to an enemy's coast, against an enemy with no serious anti-carrier capability, there

¹⁴³ Polmar, *The Naval Institute Guide to the Ships and Aircraft of the U.S. Fleet*, 14th edition, p. 415; and "A-5 Vigilante."

¹⁴⁴ The KA-6D could offload over 21,000 pounds of fuel immediately after take-off. However, the plane was specifically designed for the "mission tanking" role pioneered by the A-4 Skyhawk. In this role, it could offload 15,000 pounds of fuel up to 288 nm from the carrier and still have enough to recover back aboard. Polmar, *The Naval Institute Guide to the Ships and Aircraft of the U.S. Fleet*, 14th edition, p. 405. Also see "A-6 Intruder," accessed online at http://en.wikipedia.org/wiki/A-6_Intruder on July 26, 2007.

¹⁴⁵ Polmar, *The Naval Institute Guide to the Ships and Aircraft of the U.S. Fleet*, 14th edition, p. 415; and Polmar, *The Naval Institute Guide to the Ships and Aircraft of the U.S. Fleet*, 18th edition, p. 410.

simply was no operational demand for carrier aircraft with unrefueled ranges much greater than 600 nm. Said another way, the lack of any carrier aircraft capable of independently attacking targets over 600 nm from the carrier posed no insurmountable problems during wartime operations over Korea and Vietnam. As a result, the independent reach of US CVWs improved only modestly after World War II:

Figure 1: US Navy Carrier Aircraft Combat Radii, 1944–1980

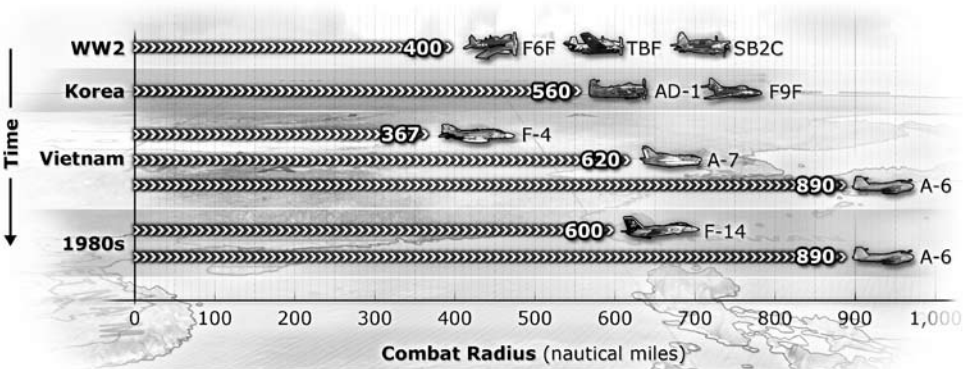

- The typical late-Second World War CVW, consisting of the F6F Hellcat and F4U Corsair fighter-bomber, SB2C Helldiver dive bomber, and TBM/TBF Avenger torpedo bomber, could strike targets located up to 400 nm from the carrier.¹⁴⁶
- In Korea, the propeller-driven AD-1 Skyraider medium bomber and the jet-powered F9F Panther fighter-bomber (when equipped with wingtip fuel tanks) could conduct combined strikes against targets approximately 560 nm away from the carrier. The propeller-driven F4U Corsair fighter-bomber could fly close air support missions out to about 430 nm.¹⁴⁷
- In Vietnam, F-4 Phantom II fighter-bombers, A-7 Corsair II light attack aircraft, and A-6 Intruder medium bombers could

¹⁴⁶ Friedman, *U.S. Aircraft Carriers: An Illustrated Design History*, p. 231.
¹⁴⁷ From data found in “List of US Naval Aircraft,” accessed online at http://en.wikipedia.org/wiki/List_of_US_Naval_aircraft on July 17, 2007.

fly *combined* unrefueled alpha strikes up to 367 nm from the carrier, the maximum range of the F-4 Phantom II.¹⁴⁸ However, the unrefueled combat ranges of the Corsair II and Intruder light and medium bombers were much greater: the A-7 had a maximum combat radius of about 620 nm, while the A-6 Intruder medium bomber could carry a conventional combat load of five tons over an unrefueled strike radius of 450 nm, and a smaller one-ton payload over 890 nm.¹⁴⁹

- In the early 1980s, after the F-14 Tomcat replaced the F-4 Phantom II, the A-7, A-6, and F-14 could conduct combined unrefueled strikes out to about 600 nm from the carrier—the post-World War II high point of independent carrier reach.

Of course, consistent with the Navy's strategy to build the best carrier aircraft possible, each of these successive generations of carrier aircraft was much more capable in terms of sensors, weapons, and particularly strike payload than its predecessors. For example, over comparable ranges, an A-6 Intruder carried five times more payload than the World War II Avenger bomber (five tons versus one ton), and, when carrying a comparable payload (one ton), it had nearly twice the range. However, as the above figures indicate, in their own times, carrying representative weapons loads, US CVWs seldom had an independent ability to strike targets more than 600 nm from their carriers.

DÉJÀ VU

Building and operating light and medium attack aircraft with limited independent reach was perfectly sensible given the lack of strong Soviet anti-carrier forces and the operational lessons of the Korean and Vietnam wars. After Vietnam, however, the Navy turned its full attention on confronting a rapidly improving Soviet Navy, which was maturing into a much more formidable adversary than any the Navy had faced since the end of World War II. Indeed, for the veterans of the Pacific campaign

¹⁴⁸ See "F-4 Phantom II," accessed online at http://en.wikipedia.org/wiki/F-4_Phantom_II on July 17, 2007. However, another reference gives the F-4 an unrefueled combat range of only 335 nm. See "Naval Aircraft" in Polmar, *The Naval Institute Guide to the Ships and Aircraft of the U.S. Fleet*, 14th edition, p. 401.

¹⁴⁹ See "A-6 Intruder," accessed online at <http://www.globalsecurity.org/military/systems/aircraft/a-6.htm> on March 30, 2007.

still on active duty, the resulting intense back-and-forth technical and tactical competition between the US carrier force and Soviet anti-carrier forces that occurred over the last decade-and-a-half of the Cold War must have triggered a strong sense of déjà vu. Once again, the carrier force had to contend with an adversary that boasted a strong land-based aviation force with a substantial advantage in tactical reach. Moreover, this much more lethal aviation strike force was backed by a submarine force that was more capable and deadly than any the Navy had ever had to face. A review of the resulting hard-fought technical and tactical competition between the US and Soviet Navies gives an inkling of why a lack of carrier reach in the future may be far more problematic than it was in the past.

V. Confronting the Soviets: Taking a Knife to a Gunfight

Well aware of the great short-range striking power of US aircraft carriers, by the early 1950s the Soviets began developing the platforms, weapons, and tactics necessary to hunt down and sink US carriers long before their aircraft could come within range of the Soviet homeland. However, such was the difficulty of the task that it was not until the mid-1970s that the Soviet armed forces had all the components needed to assemble a powerful long-range, ocean “reconnaissance-strike complex” able to crack a carrier task force’s defenses at range. The business end of these strike complexes consisted of extremely deadly, robotic *kamikazes* known as anti-ship cruise missiles (ASCMs), fired from submerged nuclear-attack and guided-missile submarines as well as long-range, land-based maritime strike aircraft.

Throughout most of the Cold War, the US Navy believed that it held a decisive advantage in anti-submarine warfare, which would allow it to destroy Soviet submarines before they could get their ASCMs into firing range. As a result, in the mid-1970s, long-range, land-based maritime strike aircraft were thought to be the most deadly threat to the battle group. As previously mentioned, one of the most challenging aspects of that threat was the range advantage enjoyed by large, heavy, land-based aircraft. When factoring in the maximum range of their ASCMs, these aircraft ultimately could, in principle, launch attacks against carriers at ranges out to about 2,900 nm miles from their land bases, giving the Soviets greater than a four-to-one range advantage over the contemporary US CVW. However, by the early 1980s, Soviet advances in submarine quieting made the job of finding and tracking Soviet submarines much more difficult. When coupled with new ocean surveillance platforms, the Soviets could threaten US carrier task forces long before they could bring their aircraft to bear.

The difficulty the fleet had in confronting this problem is instructive, because it appears that a similar circumstance may define the future. As will be discussed later in this report, at least one rising power—the People’s Republic of China—appears intent on following in the Soviets’ footsteps. Indeed, benefiting from Russian advice and advances in sensors and guided weapons, it has the potential to field long-range anti-carrier systems that are more effective and deadly than anything seen during the Cold War. As the following historical analysis reveals, such a system would pose tremendous challenges for a carrier force hampered by limited tactical reach and persistence.

THE EARLY SOVIET ANTI-ACCESS STRATEGY

After World War II, when considering how best to prepare for a long-term military competition with the United States, the Soviets’ first priority was to protect Soviet territory from air attack—especially from bombers carrying atomic weapons. With the memory of the damage caused by the German Luftwaffe still fresh in their minds, and well aware of the damage the Anglo-American bomber fleets had inflicted on Germany and Japan, the Soviets began allocating enormous resources to develop a dense, integrated, continental air defense network with overlapping radar coverage, long-, medium-, and short-range surface-to-air missiles, radar-directed anti-aircraft guns, and modern interceptor aircraft. Indeed, territorial air defenses commanded a large percentage of Soviet defense spending throughout the Cold War.

As their continental air defense shield grew stronger, Soviet planners sought to extend the air defense umbrella beyond their borders and destroy attacking American and other North Atlantic Treaty Organization (NATO) aircraft before they could come into range. Another logical step was to develop a means to attack distant enemy air bases to prevent the launching of strikes against Soviet territory. To attack NATO bases in Europe, the Soviets developed a large tactical ballistic missile force, armed with both nuclear and chemical warheads, along with medium- and short-range strike aircraft and special operations forces. However, these forces were incapable of attacking American aircraft carriers at

sea. To find and sink these highly mobile targets before their aircraft could come into range would require a special effort and the development of new platforms and weapons.

Very early on, a key part of the Soviet anti-carrier strategy was to employ long-range, land-based aircraft with air-launched, anti-ship missiles. The first air-launched, anti-ship guided weapons, the Fritz-X and German HS-293 radio-controlled glide bombs, made their operational debut in 1943. Both were line-of-sight weapons; after weapons release, an operator would fly the weapon into the target via radio remote control by following a flare on the tail of the bomb. For the unpowered Fritz-X, the launching aircraft had to overfly its target at an altitude of 20,000 feet, allowing the operator to track and steer the weapon through a standard bomb sight. In contrast, the HS-293 had a rocket booster, giving it a maximum engagement range of 11 kilometers.¹⁵⁰ Both weapons therefore required the launching plane to be deep inside the engagement envelope of a carrier's combat air patrol and well with range of a task force's terminal defenses. To complicate the American defensive problem, the Soviets wanted a guided anti-ship cruise missile with an advantage in relative engagement range—that is, a weapon that could be launched *beyond* the range of an American carrier CAP and task force defenses.

The first Soviet guided anti-ship weapon, the KS (*Kometa Snaryad*, or Comet Projectile) anti-ship missile, was tested in the Black Sea in 1954 and declared operational in 1955.¹⁵¹ This missile had an effective combat engagement range of about 25-30 nm. While a great improvement over the HS-293 and Fritz-X, employing the new weapon presented a major challenge for the crew of the weapon's launch platform, the Tupolev Tu-4 bomber, a copy of the American propeller-driven B-29 Superfortress. To set up an attack, the crew had to conduct a visual search for the carrier and acquire the target on the Tu-4's onboard targeting radar. After launch, operators on the Tu-4 then had to guide the missile to within five to ten miles of the target, at which point the KS locked onto the radar return from the Tu-4's targeting radar, a technique known

¹⁵⁰ Dr. Carlo Kopp, "The Dawn of the Smart Bomb," *Air Power Australia*, July 2006, accessed online at <http://www.ousairpower.net/WW2-PGMs.html> on June 13, 2007.

¹⁵¹ The Tu-4 bomber, a copy of the American B-29 Superfortress, carried the KS missile. Fourteen of 18 missiles hit their targets, with one missile sinking a cruiser that had been configured to provide a radar return similar to a US aircraft carrier. Norman Friedman, *Seapower and Space: From the Dawn of the Missile Age to Net-Centric Warfare* (Annapolis, MD: Naval Institute Press, 2000), pp. 136-137.

as semi-active radar homing.¹⁵² Of course, because the aircraft itself provided off-board terminal guidance to the missile, the entire engagement had to take place well inside the 150-nm carrier CAP radius then routinely established by American carrier forces—which amounted to a suicide mission for the crews of the Tu-4s. Soviet designers therefore continued to work feverishly to develop missiles that could be launched from ranges outside the US carrier’s defensive shield.

As the above discussion indicates, anti-ship missiles require accurate cueing, effective terminal guidance, and reliable relay communications between launch platform and weapon even when the launch platform is within sight of the target. To design a system to allow aircraft to launch missiles at targets that are over the horizon is even more difficult. Despite the additional technical challenges and significant added costs, however, the Soviet Navy relentlessly pursued the capability to destroy aircraft carriers with missiles launched from outside the range of the carrier’s combat air patrol.

In these efforts, the Soviet Navy benefited greatly from the arrival in 1956 of a new, energetic commander-in-chief, Admiral Sergei Gorshkov. For the next 30 years, Admiral Gorshkov, a tireless proponent of Soviet sea power, secured ever-increasing resources from a military apparatus long dominated by the army. His guiding vision, perhaps best captured in his 1976 book, *Sea Power and the State*, was to develop true “blue-water capabilities” that would allow the Soviet Navy to compete directly with the US Navy on the high seas. Importantly, however, although Gorshkov eventually succeeded in convincing the Soviet leadership to develop aircraft carriers and large surface ships, his strategy for taking on the American carrier fleet for most of the Cold War was to build a “sea denial” force that could find, localize, track, and attack US carrier battle groups at sea. This force was built around four essential components: a high-speed submarine fleet armed with wake-homing torpedoes and anti-ship cruise missiles; a long-range, land-based naval aviation corps armed with increasingly capable and lethal anti-ship cruise missiles; an ocean surveillance system; and an automated command and control system. This resulting “system of systems” eventually formed what the Soviets called a long-range *reconnaissance-strike complex*. Between 1956 and 1970, Gorshkov patiently built the components for this future strike complex, which

¹⁵² Friedman, *Seapower and Space: From the Dawn of the Missile Age to Net-Centric Warfare*, p. 136.

ultimately triggered an intense technological and tactical competition with the American carrier-centric navy in the last decade-and-a-half of the Cold War.

IMPROVEMENTS TO THE SOVIET SUBMARINE FLEET

Gorshkov's initial priority was to develop a submarine force capable of reliably hunting down and killing a carrier task force. The initial steps toward this goal were the nuclear-powered November-class SSNs and Echo-class cruise missile submarines (SSGNs), which began to appear in the late 1950s and early 1960s. Aside from its nuclear reactor, the November was a traditional attack submarine which used torpedoes to attack its targets, requiring it to get within a few miles of a carrier. In contrast, the Echo-class SSGN (and its conventional sister, the Juliet SSG) was the first of a series of purpose-built missile carriers armed with the 190-nm range SS-N-3C Shaddock anti-ship cruise missile, a modification of a land-attack cruise missile (LACM) with both conventional and nuclear warheads.¹⁵³ However, as the first of its kind, the Echo's attack profile left something to be desired. Once cued to a carrier's location by a radar-equipped maritime patrol aircraft, the Echo needed to surface, deploy, and activate its own tracking/guidance radar, and remain on the surface for the duration of the missile's flight, providing command guidance to the missile via a data link until it was close enough to the carrier to activate its own terminal guidance system. Obviously, this method of attack forfeited the submarine's main advantage—underwater stealth—which made it easier to find and attack. Moreover, the Shaddock was slow and vulnerable to jamming and other deception measures, and therefore not much of a threat to rapidly improving American missile defenses.¹⁵⁴

¹⁵³ See "Soviet-Russian Naval Cruise Missiles / Chinese Cruise Missiles," accessed online at http://vectorsite.net/twcruz_7.html on June 26, 2007.

¹⁵⁴ See "Barrier Strategy Embraced" in Dr. Owen R. Cote, Jr., *The Third Battle: Innovation in the U.S. Navy's Silent Cold War Struggle with Soviet Submarines*, MIT Security Studies Program, March 2000. The entire report was accessed online at <http://www.navy.mil/navydata/cno/n87/history/cold-war-asw.html> on July 3, 2007. The online report does not include page numbers; therefore, cites are attributed to the report's associated section.

Later, the Soviets refitted some of their Echoes with the new P-500 Bazalt, known in NATO navies as the SS-N-12 Sandbox. The Sandbox was a much more formidable missile than the earlier Shaddock. It was a much longer-range weapon (295 nm) designed specifically to be launched in salvos of up to eight missiles. One of the missiles would climb to 23,000 feet using an active seeker to find the carrier, while the others remained at low- or medium-altitude. The high-flier would designate targets for the other missiles in the salvo via a data link, with at least half directed at the carrier and the other half at nearby surface escorts. If the high-flier was shot down, another missile would climb and take its place. These cooperative, mass attack tactics were designed to overwhelm a carrier task group's defenses.¹⁵⁵

Even assuming that these deadly missiles worked as advertised, however, it was not at all certain that the Echo would ever be able to get within firing range of a carrier, since the SSGN's real vulnerability, which it shared with the November SSN, was its loud acoustic signature. This allowed US and NATO forces to detect and track both submarines at very long ranges using underwater acoustic arrays, and to vector airborne and surface ASW forces toward submarine contacts to prosecute attacks. Exploiting this vulnerability, NATO developed an ASW "barrier strategy" based around the Greenland-Iceland-United Kingdom (GIUK) gap, the geographical chokepoint that separated the North and Bering Seas and the Arctic Ocean from the Atlantic. Much quieter US and British SSNs would hunt Soviet submarines north and east of the gap, while maritime patrol aircraft, cued by a rapidly expanding and improving underwater Sound Surveillance System (SOSUS) laid across the GIUK gap and around the Atlantic basin, would pounce on Soviet submarines seeking to cross into the mid-Atlantic. Anti-submarine carriers and surface ships would take care of any "leakers" that made it past the gap.¹⁵⁶

The second generation of Soviet nuclear submarines included the Victor-class SSNs and Charlie-class SSGNs, which were much more effective than the earlier Novembers and Echoes. The Victor was the first Soviet submarine with an underwater speed high enough to keep pace with an American aircraft carrier operating at high speed, and the

¹⁵⁵ "Soviet-Russian Naval Cruise Missiles / Chinese Cruise Missiles."

¹⁵⁶ In July 1962, a US undersea array in Barbados detected a Soviet nuclear submarine as it passed through the Greenland-Iceland-United Kingdom (GIUK). See "American ASW and the First Soviet Nuclear Submarines," in Cote, *The Third Battle: Innovation in the U.S. Navy's Silent Cold War Struggle with Soviet Submarines*.

Charlie introduced the first underwater-launched ASCMs. The technology that supported over-the-horizon, submerged ASCM attacks was a new generation of Soviet space-based ocean reconnaissance satellites, including both electronic surveillance and radar surveillance versions known as the EORSATs and RORSATs, respectively (to be discussed in more detail shortly). In addition, the Charlie's missiles were faster and flew at lower altitudes than the SS-N-3C, which made them far more difficult to shoot down. However, the Charlie had a top underwater speed of only 24 knots, which meant it could not race down a fast-moving US carrier battle group. More importantly, both the Victor and the Charlie were generally quite noisy, which meant US SSNs and ASW forces could track them as easily as the first generation of Soviet nuclear-powered submarines.¹⁵⁷

Unfortunately, the US acoustical advantage in undersea warfare was eroding. In 1978, after a short, unsuccessful experiment with extremely fast, deep-diving submarines (Alfa SSNs and Papa SSGNs), the Soviets introduced an improved version of the Victor SSN, dubbed the Victor III, and laid down the first of an entirely new class of large submarines that was to become Gorshkov's ultimate undersea carrier-killer, the Oscar-class SSGN.¹⁵⁸ Both were bad news for the US Navy. A grievous breach of US security warned the Soviets about their submarines' vulnerability to US underwater tracking systems, and the acquisition of Japanese milling machines enabled the construction of much quieter "skewed" propellers. Thus, the Victor III was as fast as its predecessors but much quieter. It was the first of a new generation of SSNs quiet enough to evade SOSUS detection capabilities, which threatened to disrupt the American barrier strategy that had underpinned the Navy's wartime ASW plans since the early 1960s.¹⁵⁹ It was joined by a large, new, purpose-built "carrier killer," the Oscar SSGN, which boasted a submerged speed of 31 knots, fast enough to intercept and keep pace with a US carrier task force. If provided with accurate off-board targeting data, it could launch a salvo of up to 24 supersonic P-700 Granit anti-ship cruise missiles at ranges up to 300 nm from the target—beyond the normal loiter radius of the carrier's S-3 Viking ASW

¹⁵⁷ See "The Charlie Threat" in Cote, *The Third Battle: Innovation in the U.S. Navy's Silent Cold War Struggle with Soviet Submarines*.

¹⁵⁸ The Oscar was over 500 feet long and had a submerged displacement of somewhere between 15,000 and 22,000 tons—as big as a US strategic ballistic missile submarine.

¹⁵⁹ See "The Delta Threat" and "Phase IV of the Third Battle: ASW and Acoustic Parity, 1980–1990" in Cote, *The Third Battle: Innovation in the U.S. Navy's Silent Cold War Struggle with Soviet Submarines*.

aircraft. Moreover, like the earlier Bazalt, the Granit could communicate with other missiles in a salvo, allowing them to cooperatively attack a carrier battle group. The missile's guidance system also included several different pre-programmed courses, making its attack route far less predictable. Finally, the missile also carried a powerful deception jammer. Indeed, the Granit's deadly characteristics earned it the NATO designation SS-N-19 "Shipwreck."¹⁶⁰

The steady improvements to the Soviet submarine force were mirrored by improvements in Soviet maritime strike aircraft and weapons. What made the advances in Soviet submarines even more troubling was that they came at the precise time that the threat from long-range, land-based maritime strike was also rapidly rising.

IMPROVEMENTS TO SOVIET LONG-RANGE AVIATION FORCES

In the early stages of the Cold War, Soviet maritime strike aircraft could neither easily locate US carrier task forces nor launch their weapons from outside the range of the carrier's defensive combat air patrols. As a result, throughout the 1950s and 1960s, US carrier aircraft, despite being outranged by Soviet land-based strike platforms, had a clear tactical advantage. In short, naval task force missile-armed combat air patrols could reliably intercept attacking Soviet aircraft before they could launch their onboard weapons.¹⁶¹ This advantage gave carrier aviators great confidence that they could reach effective strike range of Soviet land targets.

By 1970, however, things began to change. Around that time, the Soviets introduced the improved supersonic, 1,700-nm range Tu-22K Blinder, armed with the supersonic Kh-22 anti-ship cruise missile, known by NATO as the AS-4 Kitchen. Naval expert Norman Friedman called the Tu-22/Kh-22 system "considerably more threatening than earlier systems" because of the bomber's speed of approach and the fact that the Kh-22 had its own active radar seeker that allowed the

¹⁶⁰ "Soviet-Russian Naval Cruise Missiles / Chinese Cruise Missiles."

¹⁶¹ For a summary of the range competition that occurred during the 1950s and 1960s, see Friedman, *Seapower and Space: From the Dawn of the Missile Age to Net-Centric Warfare*, pp. 132–152.

bomber to turn away after launch.¹⁶² Moreover, given the proper target cueing, the Kh-22's 200-nm range allowed the Blinder to launch a missile attack just outside the tactical reach of a carrier battle group's CAP, which remained at just over 150 nm from the carrier (including the missile range of the then-standard F-4 Phantom II armed with radar-guided Sparrow air-to-air missiles). It appeared that the Soviets were on the verge of achieving an advantage in both operational reach (unrefueled range of the Blinder) and tactical reach (maximum effective range of the Kh-22), which would put US carrier forces at a severe defensive disadvantage.

Luckily for the US Navy, in the 1970s Soviet naval planners had great difficulty providing the Blinders with accurate targeting data for their missiles, primarily due to deficiencies in Soviet over-the-horizon surveillance, reconnaissance, and command and control. Three improvements were needed before the Soviets could launch a successful end-to-end engagement: an effective and reliable ocean tracking system; a central processing headquarters for converting tracking data into targeting data; and secure, long-range communications between both Soviet command and control hubs and attacking aircraft (and submarines), and between the attacking aircraft and their missiles. Technically, the most challenging of the three was the ocean tracking system. Early Soviet tracking systems homed in on a carrier's electronic emissions using a relatively inaccurate high-frequency, land-based direction-finding (HF/DF) system called Krug—a system adapted from a German World War II design. Of course, if an American carrier restricted its electronic emissions, the system provided no data. Soviet engineers therefore fielded an over-the-horizon radar system in the late 1960s called Molniya (Lightning) that could detect ship targets. However, the Molniya lacked sufficient accuracy to direct bomber formations. Worse, because of its short range (up to 180 nm), the system did not provide the stand-off range necessary to attack the carrier before its aircraft came within range of Soviet territory.¹⁶³ As a result, the Soviets remained dependent on a radar-equipped version of the Blinder—the Tu-22R—to search for American carrier battle forces. However, these aircraft were as vulnerable to interdiction by the carrier's protective fighter screen as were the bombers they directed.¹⁶⁴

¹⁶² Ibid., p. 150.

¹⁶³ Ibid., p. 153.

¹⁶⁴ For example, the Soviets developed a reconnaissance version of the Tu-22 with passive electronic intelligence (ELINT) sensors, but these sensors worked only in line-of-sight. Friedman, *Seapower and Space: From the Dawn of the*

Figure 2: The Blinder/Kitchen Threat

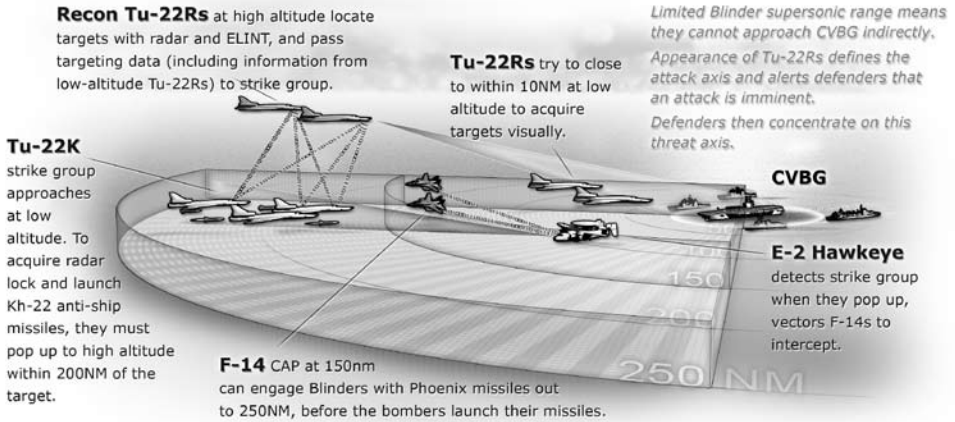

Despite Soviet problems in tracking and cueing, the appearance of the Blinder and its Kh-22 missile prompted US Navy leaders to conclude that the growing Soviet long-range naval aviation force would soon pose the greatest threat to US naval operations. For example, in 1976, then-CNO Admiral James Holloway III, remarked that American carrier task forces now had to “defend themselves against attacks of land-based air [sic], because we are seeing more and more the development of long-range aircraft with anti-ship missiles as a threat which can develop rapidly and can extend to almost any spot on the globe.”¹⁶⁵

Missile Age to Net-Centric Warfare, p. 147. The primary Soviet maritime patrol aircraft was the Tu-95RT Bear, a turboprop aircraft with extremely long range and endurance. The RT designation stood for “reconnaissance-targeting.” The plane’s primary mission sensor was the extremely powerful “Big Bulge” X-band radar. From an email from Dr. Carlo Kopp to Tom Ehrhard dated July 13, 2007. Also see “Tu-95 Bear (TUPOLEV),” accessed online at <http://www.globalsecurity.org/wmd/world/russia/tu-95.htm> on June 24, 2007.

¹⁶⁵ William D. O’Neil, “Backfire: Long Shadow on the Sea-Lanes,” *Proceedings*, U.S. Naval Institute, March 1977, pp. 26–35. Soviet Long-Range Aviation Forces received a much higher priority in Soviet defense plans than other Soviet naval aviation elements. See Jeffrey T. Richelson, *America’s Space Sentinels* (Lawrence, KS: University Press of Kansas, 1999), p. 103.

The Navy responded quickly to this growing threat, fielding new systems and countermeasures designed to negate the Soviets' huge investment in the Tu-22/Kh-22 strike system. These included the upgraded E-2C Hawkeye airborne early warning aircraft with its long-range airborne surveillance radar, and the new F-14 Tomcat interceptor equipped with the powerful AWG-9 engagement radar and 100-nm range Phoenix air-to-air missiles. Both the E-2C and F-14 entered the fleet in the early 1970s, soon after the Blinder and Kitchen arrived on the scene. Loitering over a carrier, a Hawkeye's long-range radar extended the battle group's radar horizon out to 250 nm. With an unrefueled patrol range of approximately 250 nm with several hours on station, a Hawkeye could easily extend the battle group's radar horizon out to 500 nm. The F-14 did not extend the physical distance under which CAPs operated from the carrier any appreciable degree (still about 150 nm), but its sophisticated radar and long-range Phoenix missile extended the effective CAP engagement range out to about 250 nm, just beyond the acquisition range of the Kh-22's onboard radar.¹⁶⁶ Moreover, once acquired by the Hawkeye at extended range, fleet air defenders knew that the limited supersonic reach of the Tu-22 restricted its attack options. As a result, the F-14 CAP could be positioned on the right azimuth and in the numbers necessary to counter an incoming bomber formation.

THE RISE OF THE SOVIET MARITIME RECONNAISSANCE-STRIKE COMPLEX

The Soviets were able to respond just as quickly to the Navy's defensive improvements, first and foremost because their patient, long-term investment and development efforts in over-the-horizon targeting systems were finally coming to fruition. In 1960, Soviet Design Bureau chief Vladimir Chelomey proposed a "space-based reconnaissance and detection system" that was later fielded as the aforementioned ROR-SAT (Radar Ocean Reconnaissance Satellite) and EORSAT (Electronic Intelligence (ELINT) Ocean Reconnaissance Satellite) systems. As their names indicate, the former used active, cloud-penetrating synthetic-aperture radar (SAR) to locate US carrier battle groups, while the latter used ELINT to localize and track carriers. Fielded in the early 1970s, just as the competition between the US carrier forces and the Soviet

¹⁶⁶ Friedman, *Seapower and Space: From the Dawn of the Missile Age to Net-Centric Warfare*, p. 152.

carrier interdiction forces was heating up, the combination of the ROR-SAT/EORSAT provided the first truly effective ocean targeting system for Soviet anti-carrier forces. Although these satellites had several operational limitations, their appearance alarmed the Navy. As naval analyst Norman Friedman observed, “Well into the 1990s, the development of a countermeasure against space-based synthetic-aperture radar was a major goal of US Navy electronic warfare research.”¹⁶⁷

Navy leaders were not the only ones alarmed at the appearance of these new ocean surveillance satellites. In the mid-1970s, President Gerald Ford announced in the Top Secret National Security Decision Memorandum (NSDM) 345 the revitalization of the US anti-satellite (ASAT) program. The memorandum, made public after the recent Chinese ASAT test in January 2007, stated,

The President is concerned about the increasing use by the USSR of space-based assets for direct support of their military forces. This trend, which can be expected to continue, and *which is typified by the Soviet use of ocean surveillance satellites to provide real-time targeting data for long-range anti-ship missiles*, is substantially increasing the effectiveness of Soviet forces (emphasis added).¹⁶⁸

The memorandum went on to order that an anti-satellite interceptor capable of destroying all Soviet low-altitude satellites (like those used by both the EORSAT and RORSAT) within a period of one week “be acquired on an expedited basis.” The memorandum also directed that DoD develop the capability to “electronically nullify critical Soviet military satellites at all altitudes up to synchronous.”¹⁶⁹

In 1974, just as the Soviets’ new ocean surveillance satellites were making their appearance—and long before the US developed a working ASAT system—the Soviets introduced the new Tu-22M Backfire bomber

¹⁶⁷ Ibid., p. 158.

¹⁶⁸ Brent Scowcroft, National Security Decision Memorandum 345, “U.S. Anti-Satellite Capabilities,” (Washington, DC: National Security Council, January 18, 1977).

¹⁶⁹ As it turned out, the US ASAT program experienced various fits and starts until Congress banned further tests in 1985 and cancelled the program in 1988, using the logic that anti-satellite presence jeopardized arms control negotiations. Friedman, *Seapower and Space: From the Dawn of the Missile Age to Net-Centric Warfare*, pp. 196–197.

and the upgraded Kh-22M Kitchen anti-ship cruise missile. The final Tu-22M3 version of the Backfire was a much longer-range system than the Blinder, with a combat radius of 2,160–2,650 nm, depending on flight profile and missile load.¹⁷⁰ With the 250-nm maximum range of its mach-3 Kh-22M missile tacked on, the Backfire could potentially reach out and touch a carrier between 2,410 and 2,900 nm from its base. Assuming an average strike radius of approximately 2,700 nm, this meant the Backfire outranged the contemporary US CVW by a factor of at least four to one.¹⁷¹ Furthermore, continuing improvements in the EORSAT/RORSAT systems were thought to eliminate the Backfire's reliance on pathfinder reconnaissance aircraft, which often alerted the battle group to an impending attack. Making matters worse, the Kh-22M had a very accurate autopilot and flew passively until about 80 nm from its predicted target, when it turned on its active radar to scan for the largest surface target in its field of view. Once it acquired a target, the supersonic, steep-diving Kh-22M could not be intercepted by Navy fighters or air defense missiles. If this were not enough, the Backfires could also fire a variant of the Kitchen (the Kh-22P) with a passive anti-radar homing system that was designed to attack both the SPY-1 radar carried onboard the carrier's surface escorts and the E-2C Hawkeye's airborne radar—both vital to a carrier task force's defense.¹⁷²

¹⁷⁰ Carrying three Kh-22Ms, one on a conformal centerline station and one under each wing, the Backfire had a high-altitude combat radius of 2,160 nm. See Dr. Carlo Kopp, "Backfires for China?" *Australian Aviation*, September 2004, p. 41. When carrying just one missile on the conformal centerline station, the combat radius of the Backfire was 2,650 nm. See John G. Behuncik, "The Soviet Backfire Bomber: Capabilities and SALT Complications," Issue Paper, The Heritage Foundation, April 4, 1978, accessed online at http://www.heritage.org/Research/RussiaandEurasia/upload/86857_1.pdf on August 13, 2007.

¹⁷¹ Most analysts estimate that the Kh-22M had a maximum range of *at least* 250 nm. This was well matched to the final attack sensor used on the Backfire, the Downbeat radar. At an altitude of 40,000 feet, the horizon-limited range of the Downbeat was 240 nm, resulting in a maximum Backfire/Kh-22 unrefueled strike range of nearly 2,900 nm (assuming a payload of one missile). Email from Dr. Carlo Kopp to Tom Ehrhard, July 13, 2007.

¹⁷² Friedman, *Seapower and Space: From the Dawn of the Missile Age to Net-Centric Warfare*, p. 170.

Figure 3: The Soviet Maritime Reconnaissance-Strike Complex

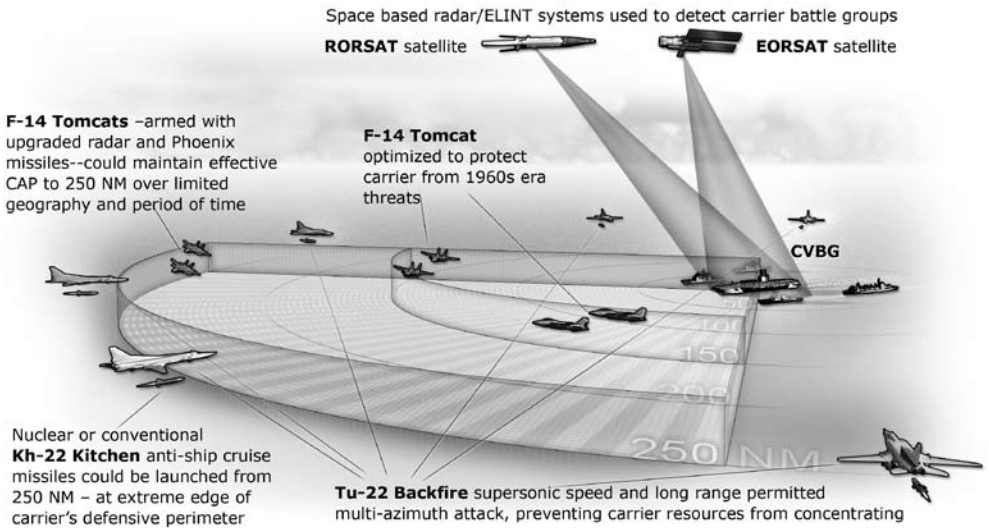

Having to fight off attacks nearly 3,000 nm from the Soviet Union was daunting enough for the US carrier force. The problem simply got worse as the carrier closed the range. Previously, a battle group commander could anticipate the azimuth of a range-limited Blinder/Kitchen attack, and concentrate his aerial defenses accordingly. With its far greater unrefueled reach, the Backfire could execute attacks on carrier battle groups from any azimuth—or, more likely, a number of azimuths simultaneously—requiring the battle group to protect a 360-degree arc around the carrier with F-14s loitering at their maximum CAP ranges.¹⁷³ In addition, as the carrier closed the range, the Backfires could fly and launch their Kh-22Ms from a low level. Such an attack profile presented a more difficult target for the F-14's long-range engagement radar.¹⁷⁴

¹⁷³ Ibid., p. 172.

¹⁷⁴ When the Backfire flew at low level, it expended more fuel. Therefore, its maximum strike range when flying at low level was much less than when flying at high altitude. In practice, this generally meant Backfires would fly low-level attacks against carriers only when operating at relatively close range to the Soviet landmass.

The competition between advancing US carrier task forces and the steadily improving Soviet maritime reconnaissance-strike complex was much more diverse than described here, as it included an array of tactics, weapon characteristics, and electronic jamming and various decoy/countermeasure systems that made the outcome of an actual confrontation highly unpredictable.¹⁷⁵ Without question, however, the Soviet strike complex was getting more capable. In congressional testimony in 1980, senior Navy officials concluded that the Tu-22M/Kh-22M represented an “order of magnitude upgrading of Soviet Naval Aviation,” with another intelligence official calling the new systems “a vital part of [Soviet] strategic defense forces to keep Western carrier battle groups from striking important targets within the Soviet land-mass.”¹⁷⁶

A TECHNICAL KNOCKOUT FOR US CARRIER FORCES?

By the late 1970s, quiet Soviet high-speed submarines, long-range, supersonic strike aircraft, and ocean surveillance systems were making life much more difficult for US naval task forces, especially in waters close to the Eurasian landmass. As Norman Friedman wrote, “It seemed entirely possible that any carriers on station in the eastern Mediterranean at the outset of war would soon be sunk in the Soviets’ ‘battle for the first salvo.’”¹⁷⁷ Such sober assessments caused even US Navy leaders to begin to question the Navy’s warfighting prowess. By the mid-1970s, CNO Admiral Elmo Zumwalt believed that the odds the Navy could win a naval war with the Soviet Union had dropped to about 35 percent.¹⁷⁸

¹⁷⁵ For a good analysis of Soviet anti-ship operations during the Cold War, see Carlo Kopp, “Maritime Strike: The Soviet Perspective,” *Australian Aviation*, July 1988, accessed online at <http://www.ausairpower.net/TE-Sov-ASuW.html> on November 9, 2007.

¹⁷⁶ Quoted from congressional testimony by Vice Admiral James H. Doyle, Jr. and Sumner Shapiro, Director of Naval Intelligence (DNI), as cited in Richelson, *America’s Space Sentinels*, p. 103.

¹⁷⁷ Friedman, *Seapower and Space: From the Dawn of the Missile Age to Net-Centric Warfare*, p. 231.

¹⁷⁸ See Elmo R. Zumwalt, Jr., “The Most Dangerous World is One Where the Soviets Have It and We Do Not,” an interview with John M. Whitley, accessed online at <http://www.ucf.ics.uci.edu/~zencin/peace2/interviews/zumwalt.html> on November 9, 2007.

The apparently worsening correlation of forces also began to influence US political leaders. Upon taking office in 1977, the Carter Administration openly challenged the need for a carrier force that was so expensive and vulnerable.¹⁷⁹ Congress at first seemed to agree. In March 1977, it decided not to fund a fourth Nimitz-class CVN, and President Carter did not object. Naturally, the Navy strenuously opposed this decision, forcefully arguing that the combination of E-2C AEW aircraft, F-14 interceptors, and the new Aegis anti-air warfare combat system could counter Soviet air attacks, and that the new S-3 Viking carrier-based anti-submarine aircraft, LAMPS III ASW helicopters, and towed sonar arrays and other acoustic sensors could counter the growing Soviet submarine threat. As a Navy analysis of the correlation of forces concluded, “While the perception that the Soviets could deny the US control of the sea is particularly damaging, such perception is not warranted by the projected trends in technology.”¹⁸⁰

The Carter Administration, however, was unmoved by the Navy’s arguments. It concluded that Navy carrier forces were on the losing end of the competition with Soviet anti-carrier forces, and directed the Navy to concentrate on sea control and convoy protection operations in the mid-Atlantic rather than on striking Soviet targets in Europe and Asia. Indeed, Carter’s Secretary of Defense, Harold Brown, believed that land-based interceptors operating out of Iceland, Greenland, and Scotland would be a better way to tackle the Backfire threat to ocean convoys, perhaps allowing the large-deck carrier force to be reduced.¹⁸¹ This conclusion was reflected in the Administration’s FY 1979 budget submission. Instead of the 156 ships included in the previous year’s six-year shipbuilding plan, Carter proposed to build just 70 ships, which would result in a battle fleet of just 420 ships by the turn of the century. More importantly, the plan rejected further large-deck CVNs in favor of smaller, less capable “sea control” carriers. Although desirous of saving money, Congress was shocked by the depth of the proposed cuts. It decided to restore the money for a fourth CVN—a move that Carter promptly vetoed.¹⁸²

¹⁷⁹ Friedman, *Seapower and Space: From the Dawn of the Missile Age to Net-Centric Warfare*, p. 233.

¹⁸⁰ John B. Hattendorf, D. Phil., *The Evolution of the U.S. Navy’s Maritime Strategy, 1977–1986* (Newport, RI: Naval War College, Center for Naval Warfare Studies, Newport Paper No. 19, 2004), p. 16.

¹⁸¹ Deborah Shapley, “New Study of Land-Based Aircraft,” *Science*, June 2, 1978, pp. 1024–1025.

¹⁸² Stephen Howarth, *To Shining Sea: A History of the United States Navy 1775–1991* (New York, NY: Random House, Inc., 1991), pp. 531–534.

SURVIVING THE COUNT

Fate then intervened in the Navy's favor. In 1979, radical Islamists with an implacable hatred toward the United States overthrew the Shah of Iran, a long-time US ally in the Persian Gulf. In response, President Carter ordered a carrier task force to the Arabian Sea. In November, the US Embassy was stormed and 66 US citizens taken hostage. Only four days later, Congress revived the fourth Nimitz CVN once again, and this time President Carter did not object to the move. In fact, within two weeks, he dispatched two more carriers to the Persian Gulf, raising the number on station there to three. When the Soviets invaded Afghanistan on December 27, these three carriers carried the only tactical air forces that could have been used to try to stop the Soviet move, had the President decided to do so.¹⁸³

The Iranian hostage crisis and the Soviet invasion of Afghanistan helped to do what the Korean War had done three decades before: remind American military and political leaders of the tremendous advantages that a powerful navy—and a powerful aircraft carrier force—provided the nation. Indeed, regaining maritime superiority became an important goal for the Reagan Administration, which swept Carter from power in 1980. On the day he was sworn in, on February 5, 1981, Reagan's new Secretary of the Navy, John Lehman, specified the exact number of ships necessary to accomplish this goal: 600 ships, including 15 deployable carrier battle groups, 100 nuclear-powered attack submarines, and four surface action groups (SAGs) built around decommissioned World War II battleships.¹⁸⁴

A CHANGING US FIGHT STRATEGY

Secretary Lehman had equally muscular ideas about how the “600-ship Navy” should be used in a war with the Soviet Union. He rejected the Carter Administration's plans to limit the Navy's wartime role to a supporting sea-control force and argued that the Navy should assume a far more aggressive, offensive stance. In this, he was supported by the Navy's uniformed leadership. Given the choice between staying in the

¹⁸³ *Ibid.*, p. 534. As demonstrated nearly 25 years later, without the support of land-based tankers, however, these carrier aircraft would have had difficulty ranging targets deep inside Afghanistan.

¹⁸⁴ *Ibid.*, p. 537.

mid-Atlantic and defending trans-Atlantic convoys outside the range of the Backfires and away from the densest concentrations of Soviet submarines, or fighting past the GIUK gap to take on the Soviet Navy in its own back yard and threatening the Soviet Union with direct attacks, most officers opted for the latter. They had great faith in the battle fleet's ability to defeat Soviet anti-carrier efforts and yearned to take the fight to the enemy. All they needed was a champion to make their case.

Going on the Offensive

One of the most vocal of US Navy champions for a more offensive maritime stance was Admiral Thomas B. Hayward. As early as 1976, after assuming command of the Seventh Fleet in the Western Pacific, Admiral Hayward was surprised to find that operations against the Soviet Navy appeared to be an afterthought in US war plans. Later, after taking over as Commander-in-Chief of the Pacific Fleet, he was once again surprised by the degree of defensive thinking in US naval war plans. He directed his staff to develop more aggressive plans using carrier strikes to hit Soviet targets in Petropavlovsk, Vladivostok, and the Kuriles. The goal of these strikes, and others that would follow, included three specific objectives: to tie down Soviet forces in the Far East, preventing them from being transferred to the European front; to convince Japanese decision-makers to continue to permit US access to Japanese air bases, which would allow for deeper aerospace strikes into the Soviet Union; and to protect Alaska and the US West Coast. Once tapped to be the Chief of Naval Operations in 1978, Hayward briefed these plans all the way up to the President, and they were eventually endorsed, helping to trigger an offensive renaissance in US naval planning.¹⁸⁵

Hayward's emphasis on forward offensive action was given a major boost by an important new interpretation of Soviet naval strategy. By 1980, after a decade of intense debate, the Navy and the broader intelligence community had concluded that the primary missions of Soviet naval forces were to protect the Soviet homeland from US and NATO nuclear-armed naval strike forces and to protect the Soviet SSBN force as a general strategic reserve. The interdiction of Atlantic sea lines of communication (SLOCs) was a secondary concern. A naval strategy that emphasized forward area power-projection might thus upset the

¹⁸⁵ Hattendorf, *The Evolution of the U.S. Navy's Maritime Strategy, 1977–1986*, pp. 17–21.

Soviets' warfighting calculations and war termination strategies, distract their attention from the Central Front, and ensure that Soviet naval forces could not threaten the United States or its NATO allies.¹⁸⁶ Moreover, such an offensive stance would in no way increase the threat to the Atlantic SLOCs. On the contrary, US naval forces operating far beyond the GIUK gap would force the Soviets to divert their quietest (and therefore most dangerous) SSNs to SSBN defense, which would keep them well north of the Atlantic convoy routes.¹⁸⁷

Getting Inside the Enemy's Reach

The logical geographic focus of the Navy's new offensive strategy was the Norwegian Sea, which provided direct access to the Soviet SSBN "bastions" in the Arctic Ocean, as well as access to the Soviet heartland from the north.¹⁸⁸ Of course, to control the Norwegian Sea, US SSNs and carrier battle forces would need to push directly into the teeth of Soviet maritime defenses. Although the strategic situation was very different, this thinking was consistent with the Navy's late World War II decision to venture carriers closer to *kamikaze* bases in order to preempt their attacks on the fleet, and it was supported by Secretary Lehman as well as the powerful carrier and submarine communities.¹⁸⁹ With their support, the new *Maritime Strategy* was ultimately endorsed and incorporated into US war plans.

The similarities behind the *Maritime Strategy* and the late World War II attacks on *kamikaze* bases did not stop with their strong endorsements of offensive naval action. The *Maritime Strategy* also forced the Navy to come to grips with fighting an opponent with a substantial advantage in reach. For example, during his time as Commander-in-Chief of the Pacific Fleet, Admiral Hayward's first offensive plans called for two two-carrier battle forces to rendezvous 500 nm from Petropavlovsk and to launch 100 strike aircraft against the Soviet bases there in

¹⁸⁶ Ibid., pp. 23–57.

¹⁸⁷ See "The Diversion Strategy" in Cote, *The Third Battle: Innovation in the U.S. Navy's Silent Cold War Struggle with Soviet Submarines*.

¹⁸⁸ Hattendorf, *The Evolution of the U.S. Navy's Maritime Strategy, 1977–1986*, pp. 23–57.

¹⁸⁹ For a lively narrative of John Lehman's versions of these events, see John Lehman, *Command of the Seas*, 2nd revised edition (Annapolis, MD: US Naval Institute Press, 2001).

two waves.¹⁹⁰ Closing to within 500 nm of a Soviet base meant that the carriers would be under threat of attack from Soviet Backfires for more than 2,000 nm. When deciding how to deal with this problem, fleet planners took many of the very same steps taken by the World War II planners when confronted by a similar disparity in reach.

Developing Increased Reach

The first priority was to shrink the range disparity vis-à-vis Soviet offensive systems. In pursuing this objective, the Navy adopted two different approaches. The first was to develop a sea-launched cruise missile, in both nuclear and conventional versions. By the time it became operational in 1983, this missile was referred to as the Tomahawk land-attack missile (TLAM) to distinguish it from an anti-ship variant of the same missile (TASM). The nuclear version of the missile had a (one-way) operational strike range of over 1,300 nm—comparable to the unrefueled strike radius of the retired A-5 Vigilante. The conventional land attack version had a 900-nm range, about the same unrefueled reach as the A-3D Skywarrior.¹⁹¹ Launching the missile from the A-6 medium bomber would have easily given the carrier a capability to strike targets from nearly 2,000 nm away—substantially reducing the range disparity between the CVW and Soviet land-based, long-range maritime strike aircraft. However, for various reasons, among them nuclear arms control considerations, the A-6/TLAM combination was never pursued. Instead, the missiles would be fired only from carrier task force submarines and surface combatants.

The second approach involved seeking a high-payload medium bomber to replace the aging A-6 Intruder. The development of this new carrier strike plane, at first known as the Advanced Tactical Aircraft (ATA), began in 1983. Soon thereafter, the ATA was given a more appropriate title—the A-12 Avenger II—named after the longest-legged bomber in the 1945 carrier air wing. However, with a maximum carrier take-off weight of 80,000 pounds and a planned combat radius of 800 nm, its characteristics more closely resembled the retired A-3D Skywarrior. The A-12 also resembled the A-3D in one more way: no other carrier aircraft would have the legs to accompany it over its maximum

¹⁹⁰ Hattendorf, *The Evolution of the U.S. Navy's Maritime Strategy, 1977–1986*, pp. 17–21.

¹⁹¹ “BGM-109 Tomahawk,” accessed online at <http://www.globalsecurity.org/military/systems/munitions/bgm-109-specs.htm> on September 1, 2007.

strike range, meaning it would have to penetrate Soviet airspace on its own. Unlike any other previous Navy aircraft, however, the Avenger II would have a big advantage when doing so. With a large weapons bay to allow it to carry its weapons internally, no vertical control appendages, and other radar evading technologies, the plane was to have a very low radar cross section (RCS). Engineers believed that the aircraft would be invisible on most radars beyond ten miles, which would substantially increase its survivability when operating against the Soviet continental air defense network.¹⁹² In addition, this first stealthy carrier aircraft could carry up to two of the new Advanced Medium-Range Air-to-Air Missiles (AMRAAMs) to fend off Soviet fighters.¹⁹³ However, this advanced new aircraft would not be available until the mid-1990s.

Keeping the Guard Up

Armed with TLAM, a carrier task force could strike targets 900–1,300 nm away. However, until the A-12 arrived, a carrier would still have to get within about 500-600 nm of the Soviet mainland before it could bring its “Sunday punch”—its CVW—to bear. As such, under the best of circumstances, a carrier task force would be under threat of air and missile attack for at least 1,700 nm before it launched an attack. With this problem in mind, the Navy developed the new Aegis anti-air warfare combat system. The Aegis combat system was built around the powerful new SPY-1 phased array multi-function radar.¹⁹⁴ In earlier missile

¹⁹² See “A-12 Avenger II Advanced Tactical Aircraft (ATA)—1983–1991,” accessed online at <http://www.globalsecurity.org/military/systems/aircraft/a-12.htm> on July 22, 2007.

¹⁹³ The advanced medium-range air-to-air missile (AMRAAM) was the first true US “fire and forget” air-to-air missile. It replaced the AIM-7 Sparrow semi-active radar, homing beyond visual-range missile, which required the launching aircraft’s radar to illuminate the target until impact. This made the launching aircraft a target itself, and also limited its ability to engage several targets simultaneously. See “AIM-120,” accessed online at <http://www.designation-systems.net/dusrm/m-120.html> on September 7, 2007.

¹⁹⁴ Unlike older rotating radars, the SPY-1 has four, fixed, flat-panel arrays that send out numerous “pencil-like” search beams 360 degrees around the ship. When a beam encounters an object, the system’s computers immediately divert additional beams to establish a “target track.” Additionally, the SPY-1 combines azimuth and height search, target acquisition, classification, and tracking functions, and provides command guidance to missiles. As a result, the Aegis combat system replaces several single-purpose radars, reducing the number of required system interfaces with the ship’s combat systems. Polmar, *The Naval Institute Guide to the Ships and Aircraft of the U.S. Fleet*, 18th

ships, SAMs had to be guided from the time of their launch to the time of target intercept. The number of missiles a ship could fire and control was therefore limited by the total number of separate fire control directors carried by the ship (two to four in early generation missile ships). In contrast, the Aegis/SPY-1 multi-function radar was specifically designed to work with new SAMs like the SM-2 Standard with “commandable autopilots.” Once an SM-2’s autopilot was set at launch, the Aegis system just needed to update it periodically during flight, and to provide it with specific radar guidance only during the last seconds before target intercept. Consequently, an Aegis-equipped ship could control many more outbound SAMs at once—at least four times more than previous missile defense ships. Together with the Mk-41 vertical launch system (VLS), which had a much higher rate of fire than legacy above-deck missile launchers, the Aegis system promised a tremendous increase in fleet defensive firepower.¹⁹⁵ In addition to these improvements, the Navy

edition, pp. 134–135, 552–553. For more information about Aegis, see “AEGIS Weapon System MK-7,” accessed online at <http://www.fas.org/man/dod-101/sys/ship/weaps/aegis.htm>.

¹⁹⁵ The Mk-41 vertical launch system (VLS) provides several important advantages over legacy missile launch systems. First, the VLS makes very efficient use of space in a ship’s hull, allowing a ship so equipped to carry over 40 percent more missiles than a legacy missile ship of equal size. Second, every VLS cell can be adapted to carry either one Tomahawk land-attack cruise missile (LACM); one anti-ballistic missile interceptor; one long-range Standard SAM; one anti-submarine rocket (ASROC); four “quad-packed” short-range Evolved Sea Sparrow Missiles (ESSMs); or almost any missile that is less than 21.4 feet long and 21 inches in diameter. Finally, older combatants had to remove a missile from their below-deck rotary magazines and then slide them onto the missile “rails” on the above deck launchers via a complicated hydraulic transfer system. As VLS cells serve as both missile magazine and launcher, the shift to VLS resulted in a far less maintenance-intensive and more reliable main missile battery than surface combatants equipped with launch rails and below-deck magazines. One consequence is that VLS-equipped ships require fewer technicians to maintain and operate than legacy “rail”-equipped combatants. Another is that every missile carried aboard a VLS-equipped ship is essentially in a “ready-to-fire” condition, needing only targeting data and a firing command to be sent on its way. By foregoing the need to move missiles from below-deck magazines to above-deck launchers, VLS-equipped ships can achieve higher rates of fire than legacy missile ships. See Polmar, *The Naval Institute Guide to the Ships and Aircraft of the U.S. Fleet*, 18th edition, pp. 506, 509; and “MK 41 Vertical Launching System (VLS),” accessed online at <http://www.globalsecurity.org/military/systems/ship/systems/mk-41-vls.htm> on September 2, 2007.

introduced the Phalanx close-in weapon system (CIWS) to provide ships with a last-ditch defense against incoming anti-ship cruise missiles.¹⁹⁶

The Navy also sought to increase the carrier's own defensive capacity. In addition to mounting CWISs and terminal missile systems onboard every carrier, it increased the number of F-14s in the fleet as well as the number of long-range Phoenix missiles in carrier magazines.¹⁹⁷ However, there was a practical limit to the total number of single-role F-14s in any CVW; more than two full squadrons would begin to reduce the total number of "strikers" onboard. The Navy thus decided to borrow from its World War II playbook. Recall that, in the later stages of the war, fleet commanders replaced single-role dive and torpedo bombers with dual-purpose fighter-bombers in the CVW. This move made great sense because fighter-bombers were effective for both offensive attacks against enemy land targets *and* defensive actions against inbound *kamikazes*. In the early 1980s, the Navy opted for a similar approach, replacing both the aging F-4 Phantom II fighter-bomber and the A-7 Corsair II light attack plane with a single airplane, which became known as the F/A-18 Hornet. As suggested by its unique "F/A" designation, the Hornet was designed to be a new type of hybrid "strike-fighter"—a plane equally adept at air superiority and strike missions. Moreover, it was designed to require far fewer maintenance hours per flight, which promised to increase its mission-readiness rate and availability.¹⁹⁸

¹⁹⁶ Introduced in fleet service in 1980, the Phalanx is a totally integrated weapon system including a K_u-band search and track radar, a multi-barrel gatling gun with a rate of fire exceeding 3,000 rounds per minute, a 1,550-round magazine, and supporting electronics in an above-deck mounting. The system was originally intended to provide the ship with a last-ditch defense against incoming anti-ship cruise missiles. Today, in addition to protecting the ship from ASCMs, the newest 1B version of the system has been updated to give it an engagement capability against both helicopters and slow-moving aircraft as well as small, fast-moving ("swarming") surface craft. See "Phalanx CIWS," assessed online at http://en.wikipedia.org/wiki/Phalanx_CIWS on September 2, 2007.

¹⁹⁷ Hattendorf, *The Evolution of the U.S. Navy's Maritime Strategy, 1977–1986*, p. 19.

¹⁹⁸ "F/A-18 Hornet," accessed online at <http://www.fas.org/man/dod-101/sys/ac/f-18.htm> on July 14, 2007.

However, the F/A-18's two upsides came with a potentially big downside: with a fuel fraction of only .23,¹⁹⁹ the aircraft had a maximum unrefueled combat radius of about 325 nm.²⁰⁰ This radius of action was only marginally better than the F-4's, and was substantially inferior to the A-7's. Nevertheless, with the planned complement of two squadrons of F-14 fighters, two squadrons of F/A-18s, and one squadron of A-12s, planners apparently felt the gain in future CVW defensive and offensive flexibility was worth the loss in CVW reach.²⁰¹

WINNING THE OUTER AIR BATTLE

As the foregoing sections suggest, the 1980s saw two powerful but extremely different adversaries square off against each other in the Atlantic, the Norwegian Sea, and the Northwest Pacific. In one corner stood the Soviet ocean reconnaissance-strike complex, which under Admiral Gorshkov's patient leadership "had evolved from a force primarily oriented to close-in defense of maritime frontiers to one designed to undertake a wide variety of naval tasks, which included sea control/denial efforts against Western surface forces...."²⁰² The striking power of the Soviet reconnaissance-strike complex was provided by long-range maritime strike aircraft, particularly the Backfire armed

¹⁹⁹ Fuel fraction indicates the percentage of an aircraft's gross take-off weight devoted to onboard fuel. Most tactical aircraft designs strive for fuel fractions in the range of .30-.35. From Tom Clancy, *Carrier: A Guided Tour of an Aircraft Carrier* (New York, NY: Berkley Books, 1999), p. 162.

²⁰⁰ References give varying figures for the F/A-18's range. Polmar, in *The Naval Institute Guide to the Ships and Aircraft of the U.S. Fleet*, 18th edition, gives the unrefueled radius of the F/A-18C as 278 nm (320 statute miles) (p. 408). "F/A-18 Hornet" states the unrefueled combat radius is 290 nm. A Navy slide, accessed online in "F/A-18E/F 'Super Hornet'" at <http://www.globalsecurity.org/military/systems/aircraft/f-18ef.htm> on July 14, 2007, gives the Lot XIX version of the F/A-18C an unrefueled radius of 369 nm. All three references assume the aircraft is carrying two air-to-air missiles and four 1,000-pound bombs. This paper will use 320 nm, the midpoint between the lowest and highest ranges found, as the F/A-18C's nominal fuel range.

²⁰¹ The flexibility of the F/A-18 was proven in 1991, on the first night of the First Gulf War, when two F/A-18Cs, each carrying four 2,000-pound bombs, shot down two Iraq MiGs with air-to-air missiles before proceeding to bomb their targets. See "F/A-18 Hornet."

²⁰² Director of Central Intelligence, NIE 11-15-82/D, *Soviet Naval Strategy and Programs through the 1990s*, March 1983, as quoted in Richelson, *America's Space Sentinels*, p. 102.

with the Kh-22M, and the Oscar-class SSGN armed with the SS-N-19 Shipwreck. In the other corner were the US Navy striking forces, built around dispersed carrier battle groups consisting of aircraft carriers and their increasingly powerful surface escorts. These carrier battle groups intended to get inside the Soviets' punches and launch strikes against the Soviet mainland. Their primary striking power was found in their air wings.

Actual combat between these two adversaries would likely have been extremely intense. Soviet tactics called for mass attacks against any carrier battle group detected and within range. Up to five Oscar-class submarines would receive initial command instructions and race to a designated engagement area, each ready to fire up to 24 Shipwrecks in a single mass salvo. The timing of their attack would be synchronized to arrive with another salvo of 20 to 60 Kh-22M missiles fired from a regiment of 20 Backfires. In other words, if the Soviets were able to coordinate their attacks as planned, a carrier battle group would face a modern-day *kamikaze* raid consisting of up to 180 supersonic cruise missiles. Faced with the prospect of fighting off several such raids before it could launch its own strikes, and need to give its inner defenses a chance at success, the US Navy sought to cut down the density of each missile raid. The way to do this was to kill as many of the "archers" (launch platforms) as possible before they could launch their "arrows" (missiles).²⁰³

With the SSN force and maritime patrol aircraft fleet focused on killing the Oscars, and with the Aegis cruisers, SM-2s, VLSs, and CIWSs guarding its "chin," the carrier community thus began to consider how to kill the Backfires before they could get their Kh-22Ms into range. This proved to be a difficult task. As mentioned earlier, the F-14 was originally designed in the 1960s to maintain a CAP about 150 nm from the carrier. With its 100-nm Phoenix air-to-air missile, the F-14 had a maximum theoretical engagement range of 250 nm, right at the maximum launch range of the Kh-22M missile. However, even after being vectored along a Backfire's attack azimuth by an E-2C, the Tomcat's radar had a maximum detection range of only 115 nm. Given the time to "lock up" a Backfire on the radar and accounting for the Phoenix's flight time, making a successful intercept of a supersonic Backfire bomber before it launched its missiles was by no means a sure thing. This meant that the CVW had to push its F-14s farther out from

²⁰³ Friedman, *Seapower and Space: From the Dawn of the Missile Age to Net-Centric Warfare*, p. 234.

the carrier to increase the chances of a successful missile engagement. This thinking led to the development of what was soon referred to as the Outer Air Battle concept.

The Outer Air Battle concept envisioned a “chainsaw” CAP in which F-14s were constantly cycled along a suspected Backfire attack bearing. The goal was to push the F-14 CAP out to 400 nm from the carrier, allowing missile engagements out to 500 nm. Since an F-14 could not remain on station this far from the carrier for very long, a minimum of two carriers (four Tomcat squadrons) was required to generate the number of F-14s necessary to implement the concept. Moreover, according to Norman Friedman, the concept was so complex in practice that it took 12 hours to configure the carriers for the operation, which involved moving strike aircraft to the hangar deck, configuring refueling aircraft, and stacking Tomcats on the flight deck. Worse, the extended-range F-14 “chainsaw” CAP (so-called due to long-distance aerial refueling stations the Tomcats had to meet coming and going to their stations) could only be maintained on a particular 90-degree arc (“pie slice”) for a very short period of time.²⁰⁴

The Outer Air Battle concept thus depended as much on space cueing as did Soviet concepts for open-ocean tracking of US carrier task forces. Space sensors of various kinds would alert a carrier battle group to the timing and direction of a Backfire assault. For example, by 1982, the US had demonstrated the ability to track aircraft like the Backfire while in afterburner using Defense Support Program (DSP) satellites originally designed to detect Soviet rocket launches.²⁰⁵ However, if the initial bearing provided by the DSP turned out to be a Soviet feint, the chainsaw CAP could not rapidly reposition to cover a different axis of attack. Under these circumstances, while the Backfires would likely be detected by a “back-door” E-2C Hawkeye, they would most certainly be able to launch their missiles, leaving the survival of the carrier

²⁰⁴ Ibid., p. 238.

²⁰⁵ Dubbed “Project SLOW WALKER,” Navy personnel at DSP ground stations entered Backfire data into a channel on the Fleet Satellite for near real-time transmission to the carrier. Kenneth Horn of Aerospace Corporation discovered the ability of DSP to track Backfire bombers in 1974. By 1983, engineers showed that they could distinguish Backfire returns from those of its supersonic Kitchen cruise missiles, and, in 1987, Navy detachments dedicated to SLOW WALKER had been deployed at Woomera, Australia and Buckley Field, Colorado. The system was updated continuously through 1990 and was deployed on other satellite constellations as well. See Richelson, *America’s Space Sentinels*, pp. 104–106; and Friedman, *Seapower and Space: From the Dawn of the Missile Age to Net-Centric Warfare*, pp. 242–244.

dependent solely on the ability of the Aegis cruisers to catch the arrows—the Kh-22Ms—streaking toward the task force. This seemed to be a losing proposition for dealing with hordes of anti-ship cruise missiles, some of them potentially nuclear-armed.

WOULD THE *MARITIME STRATEGY* AND THE OUTER AIR BATTLE HAVE WORKED?

In the end, US carrier forces “won” the Outer Air Battle and its larger competition against the Soviet ocean reconnaissance-strike complex because the Soviet Union collapsed, and its powerful navy disintegrated. Although many Navy officers remain confident to this day that the “carriers would always get through,” the fact remains that no one can really know which side would have come out on top in a shooting war. However, two things are known for certain. First, the entire plan to push carriers into the teeth of Soviet maritime defenses was a controversial one. For example, in 1983, Robert Komer, an Assistant Secretary of Defense in the Carter Administration, asserted the strategy “would lead to a strategic disaster in the event of a major conflict with the Soviet Union.” At least two retired admirals, Stansfield Turner and Elmo Zumwalt, agreed. Turner declared, “I have yet to find an admiral who would even attempt it,” while Zumwalt believed that the strategy would force the Soviets to employ tactical nuclear weapons at sea.²⁰⁶ Later, in a scathing 1986 article in the journal *International Security*, defense scholar John Mearsheimer systematically challenged the entire logic underpinning the *Maritime Strategy*. He concluded that the *Strategy* would do little to deter a Soviet attack against the Central Front, which he considered to be the decisive potential battle of a war against the Soviet Union.²⁰⁷ He advocated a return to the defensive sea-control strategies of the Carter Administration by reducing the Navy’s 15-carrier force to only ten carriers but maintaining a strong SSN force to bottle up Soviet SSNs so they could not interdict American shipping in support of NATO air/ground operations in Europe.²⁰⁸

²⁰⁶ Howarth, *To Shining Sea: A History of the United States Navy 1775–1991*, p. 541.

²⁰⁷ John J. Mearsheimer, “A Strategic Misstep: The Maritime Strategy and Deterrence in Europe,” *International Security*, Fall 1986 (Vol. II, No. 2), pp. 3–57.

²⁰⁸ Mearsheimer observed that “The Navy would still need large-deck carriers for its other missions—peacetime presence and Third World conflicts....”

Figure 4: Fighting with a Range Disadvantage

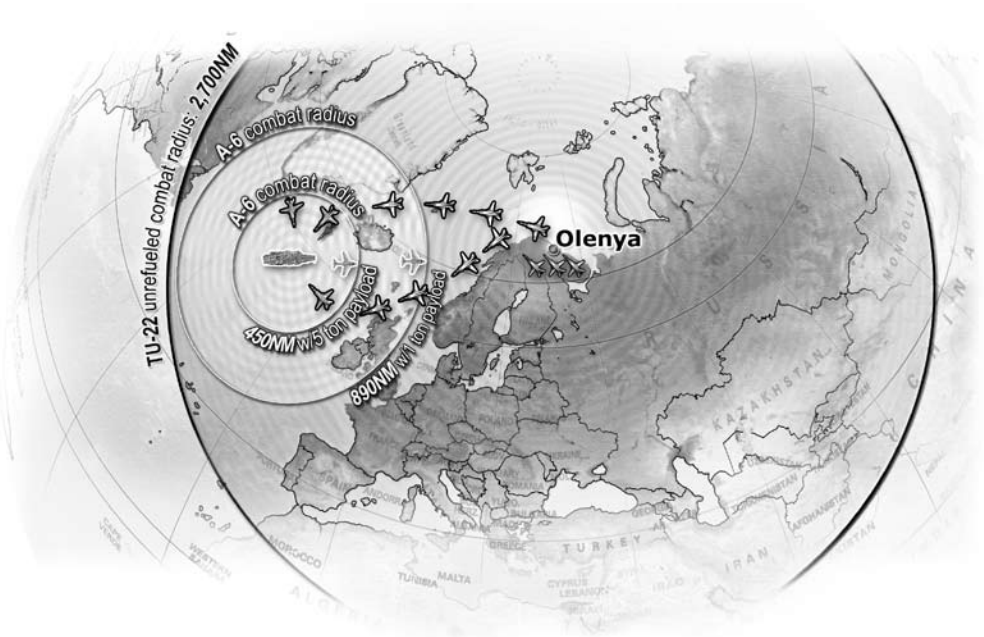

Second, whether or not the *Maritime Strategy* would actually have been executed in a shooting war, the intense competition with Soviet anti-carrier forces that came to a head in the 1980s showed that fighting against an adversary with an outright range advantage was an expensive and challenging proposition for the US carrier force in an age of supersonic bombers, cruise missiles, and fast, heavily armed SSGNs. The only thing that remained to be seen would be whether or not the carrier community would take heed of this lesson and seek aircraft and missiles with far greater range and persistence. However, as fate would have it, its efforts to do so would achieve only limited success.

Mearsheimer, "A Strategic Misstep: The Maritime Strategy and Deterrence in Europe," p. 55.

VI. The 1990s: Shortening the Reach

A PERFECT STORM

When the Cold War ended, the most serious post-World War II threat to the carrier force abruptly disappeared. However, even as the US Navy was savoring its “victory,” events were building into a perfect storm of troubles for naval carrier aviation. Just as happened after the Second World War, the first buffeting of the carrier force was due to a major post-war demobilization. Within five years of the Berlin Wall coming down, 188 ships of all types had been decommissioned, dropping the Total Ship Battle Force from 592 to 404 ships, a 32 percent reduction. At the same time, the Navy’s late-Cold War goal for 16 total carriers—needed to maintain an operational force of 15 *deployable* carrier task forces—was reduced to 12 carriers, a target reached in 1994.²⁰⁹

The second buffeting of the carrier force was caused by the cancellation of the A-12 Avenger II. The aircraft had encountered numerous problems during its development. The plane’s advanced avionics and new inverse synthetic-aperture radar suffered from technical difficulties and delays. Moreover, the planned liberal use of composite materials in the airframe did not result in the expected weight savings. Indeed, the A-12’s empty weight ballooned to over 30 tons—30 percent higher than expected. As a result of these problems, the program costs skyrocketed. By one 1990 estimate, if the Navy continued the Avenger II, it would alone consume 70 percent of the Navy’s entire aviation budget within three years. As a result, in January 1991, the Secretary of Defense cancelled the program.²¹⁰

²⁰⁹ “U.S. Navy Active Ship Force Levels,” accessed online on July 25, 2007.

²¹⁰ “A-12 Avenger II Advanced Tactical Aircraft (ATA)—1983–1991.”

The demise of the A-12 left the Navy with no medium bomber replacement for the aging A-6 Intruder or any stealthy carrier aircraft capable of penetrating modern integrated air defense systems. Worse, once the A-6 was retired, the only two tactical aircraft on the carrier decks would be the F-14 Tomcat, an air superiority fighter, and the new F/A-18 Hornet light attack aircraft.²¹¹ With the Hornet carrying the bulk of the strike load, this meant the CVW's independent reach would extend only out to about 325 nm from the carrier—a strike radius shorter than even a World War II air wing. Moreover, the imminent retirement of the KA-6D carrier tanker made the Hornet's lack of reach even more of a problem for carrier strike planners, and further limited the carrier's independent freedom of action.

PLANS TO REGAIN REACH (AND STEALTH)

Unsurprisingly, then, soon after the cancellation of the A-12, the Navy renewed its search for a suitable replacement for the A-6 Intruder. The new program, dubbed the A-X, aimed to develop an “advanced, ‘high-end,’ carrier-based multi-mission aircraft with day/night/all-weather capability, low observables, long range, two engines, two-crew, and advanced, integrated avionics and countermeasures.”²¹² The Navy defined “long range” as an unrefueled combat radius of about 800 nm.²¹³ However, soon after the A-X program was started, Navy studies concluded that upgrades to the F-14 would not meet the Navy's fleet air superiority needs through 2015. As a result, air-to-air requirements were added to the A-X, prompting the program's redesignation to Advanced Attack/Fighter (A/F-X). The A/F-X, and a similar Air Force development effort for a future Multi-Role Fighter (MRF), were both later combined into a single Joint Advanced Strike-fighter Technology program, the first step toward what is now known as the F-35 Lightning II Joint Strike-fighter (JSF).²¹⁴

²¹¹ These two tactical aircraft continued to be supported by E-2C Hawkeyes and EA-6B Prowlers. The S-3 anti-submarine warfare (ASW) aircraft also remained in the CVW.

²¹² See “Pre-JAST History,” F-35 Joint Strike Fighter Program website, accessed online at http://www.jsf.mil/history/his_prejast.htm#AX on August 1, 2007.

²¹³ Recall that the A-6 could deliver a one-ton payload out to 890 miles, but its normal combat loads greatly reduced its unrefueled reach. The A-12 was to have an unrefueled combat radius of 820 nm.

²¹⁴ “Pre-JAST History.”

As these plans began to take shape, it became clear that any replacement for the A-6 and F-14 would take a long time in coming, especially after Congress insisted on a competitive fly-off of JSF prototypes. DoD thus approved a Navy plan to improve the F/A-18 Hornet, an effort that ultimately resulted in the single-seat F/A-18E and dual-seat F/A-18F Super Hornets. Because this program essentially enlarged and improved an existing design, the early development program moved along relatively briskly, and the first flights of the F/A-18E and F took place in 1995 and 1996, respectively. However, unexpected problems in the flight test program took two years to correct. As a result, the initial operating capability for the F/A-18E slipped to 2001.²¹⁵ Nevertheless, carrier aviators believed the plane was worth the wait. Although the Super Hornets were not stealthy, they had a 40 percent greater combat radius, 50 percent greater endurance, and a 25 percent greater weapons payload than the then-standard F/A-18C, and were much more survivable.²¹⁶

Temporary Measures

With the Super Hornet delivery date slipping and with the last A-6 scheduled to retire in 1997, the Navy faced about a decade-long period in which the preponderance of the CVW strike load would fall on the short-legged F/A-18C. Consequently, the Navy took two temporary steps to improve CVW reach. The first was only moderately successful. From 1993 on, the imminent retirement of the KA-6D prompted the Navy to modify its S-3 Viking carrier-based ASW plane to allow it to operate as an aerial tanker. This modification was part of the plane's transformation into a "sea control" aircraft dedicated to ocean surveillance, anti-surface warfare, and air-to-air refueling. This was possible, at low risk to the carrier, due to the declining submarine threat.²¹⁷ To perform its ocean surveillance and anti-surface roles, the modified S-3B traded its original ASW equipment and operator stations for an inverse synthetic-aperture radar, a forward-looking infrared system, and provisions to fire the Harpoon anti-ship cruise missile and Maverick air-to-surface missiles. For the tanking role, the plane received underwing fuel tanks and an external probe and drogue pod. However, the Viking carried less fuel than the KA-6D, which normally limited the S-3 to "recovery

²¹⁵ Polmar, *The Naval Institute Guide to the Ships and Aircraft of the U.S. Fleet*, 18th edition, pp. 405–406.

²¹⁶ See "F/A-18E/F 'Super Hornet,'" accessed online on March 20, 2007.

²¹⁷ Polmar, *The Naval Institute Guide to the Ships and Aircraft of the U.S. Fleet*, 18th edition, p. 418.

tanking”—that is, providing fuel to aircraft *returning* from a mission and waiting to land back aboard the carrier.²¹⁸

The second step—converting the F-14 Tomcat into a fighter-bomber—proved to be a much more effective one. Although the F-14 was originally designed to have a strike capability, it never carried bombs during the Cold War. With the A-6, A-7, and F/A-18 available for strike duties, and given the demands of defending the carrier against air and missile attacks, the F-14 spent its first two decades of operational service as a single-purpose fleet air defender. However, the greatly diminished post-Cold War air threat caused the carrier community to reconsider its earlier objections to making the plane into a fighter-bomber. The first operational use of the so-called “Bombcats” was in 1995, when an F-14 dropped two 2,000-pound bombs on Serb positions in Bosnia. The next year, the Navy began to fit its Tomcats with Low Altitude Navigation and Targeting Infrared for Night (LANTIRN) pods, enabling them to drop laser-guided munitions.²¹⁹ Subsequently, the planes were again modified to drop GPS-guided bombs, turning them into formidable all-weather, day/night strike-fighters with respectable reach.²²⁰ With two external 280-gallon fuel tanks, and armed with four 2000-pound bombs, two Phoenix and two Sidewinder air-to-air missiles, and 675 20-millimeter cannon rounds, the Tomcat could strike targets out to 435 nm from the carrier without refueling. Substituting 1,000 bombs for the one-ton bombs, the unrefueled strike range increased to 500 nm—not quite as

²¹⁸ *Ibid.*, p. 418; and “A-6 Intruder.” accessed online at http://en.wikipedia.org/wiki/A-6_Intruder.

²¹⁹ Polmar, *The Naval Institute Guide to the Ships and Aircraft of the U.S. Fleet*, 18th edition, pp. 411–412.

²²⁰ The Global Positioning System (GPS) is a satellite navigation system consisting of at least 24 satellites (there are 30 on orbit today). Each satellite, with a miniature atomic clock onboard, transmits precise timing signals and its own location. A receiver can measure the time delay between transmission and reception of a satellite’s signal, giving a precise distance to the satellite. By determining the position of, and distance to, at least three different GPS satellites, the receiver can compute its exact location using trilateration. The first GPS satellite was placed into orbit in 1978. An incomplete constellation provided up to 20 hours per day of three-dimensional positioning data and 24 hours of two-dimensional positioning data during the First Gulf War. The constellation became fully operational in April 1995. The system’s accuracy spurred a new generation of relatively cheap, all-weather guided weapons. See “Global Positioning System,” accessed online at http://en.wikipedia.org/wiki/Global_Positioning_System on July 21, 2007. See also “Desert Storm ‘Hot Wash’ 12–13 Jul 1991,” prepared by the Air Force Space Command (AFSPACECOM), accessed online at <http://www.gwu.edu/~nsarchiv/NSAEBB/NSAEBB39/document7.pdf> on the same date.

good as the A-6, but considerably better than the F/A-18.²²¹ However, the F-14's conversion occurred late in its operational life, when most operational aircraft were well over 20 years old and increasingly difficult to maintain. Indeed, rising maintenance costs spurred its retirement much earlier than originally planned.

Figure 5: Shortening the Reach

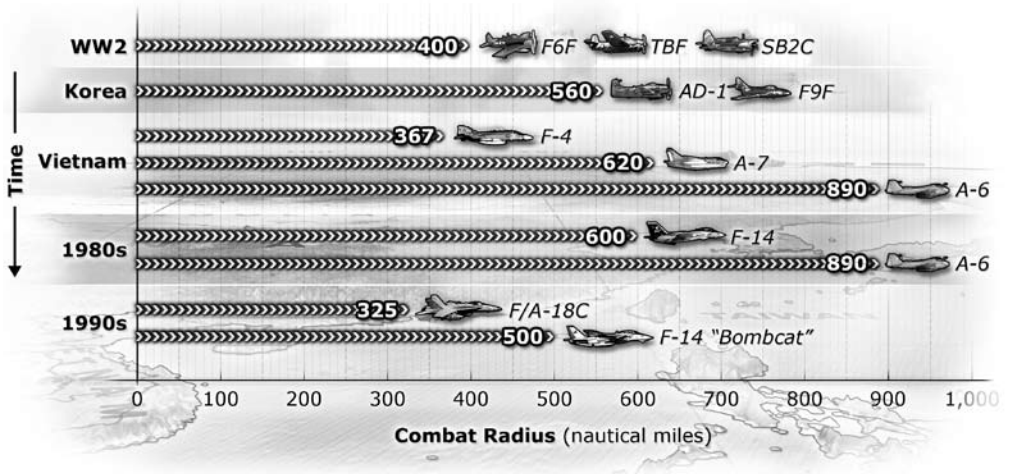

Despite these two temporary moves to increase CVW range, however, the fact remained that the strike reach of the US aircraft carrier fleet decreased dramatically during the 1990s. Although Air Force tankers could continue to greatly extend the range over which carrier strikes could occur, the CVW's reliance on land-based tankers reduced the carriers' operational freedom of action and undercut to some degree the Navy's long argument that aircraft carriers needed no "permission slips" to operate in distant theaters.

²²¹ Bob Kress and Rear Adm. Paul Gillcrist, USN (Ret.), "Battle of the Superfighters: F-14D Tomcat vs. F-18 E/F Super Hornet;" and "F-14 Tomcat," accessed online at <http://www.fas.org/man/dod-101/sys/ac/f-14.htm> on July 21, 2007.

A NEW PLANNING FOCUS: REGIONAL ADVERSARIES

The decrease in CVW strike reach during the 1990s was not perceived as much of a problem, for two inter-related reasons. The first was the dramatic change in the strategic environment. During the Cold War, US defense planners worried that war would most likely break out in one of two ways—with a Soviet invasion of Central Europe or, beginning in the 1970s, the Persian Gulf. Wherever the war started, planners anticipated that combat operations would quickly spread to the other theater, as well as the Pacific. As a result, the US military fully expected to conduct major combat operations in at least two—and most likely three—widely separated theaters. In the early post-Cold War era, as outlined first in the 1993 Bottom-Up Review conducted by the first Clinton Administration, instead of preparing to fight a multi-theater war against the Soviet Union, the US military would prepare to fight two nearly-simultaneous “major regional contingencies” (MRCs) in different theaters against regional adversaries that were likely to be far less capable than the Soviet Union.²²²

The key new wrinkle for military planners was that the two near-simultaneous MRCs would be “‘short notice’ scenario[s] *in which only a modest number of U.S. forces are in a region at the outset of hostilities*” (emphasis added). Under these conditions, the focus of US defense efforts would be to develop the ability to “rapidly halt” initial enemy advances and “...minimize the territory and critical facilities that an invader can capture.” Once the enemy’s “attack had been stopped and the front stabilized,” US and allied efforts would focus on building up combat forces and logistics support in the theater while reducing the enemy’s capacity to fight. After the theater build up, the US would conduct a counter-offensive to restore the *status quo ante*.²²³

However, the second and most important reason that a lack of range did not appear to pose any insurmountable problem was that US defense planners assumed they would have easy access to theater bases and nearby waters early in any conflict. Air Force planners counted on ready access to in-theater bases, and naval planners assumed that future regional adversaries would lack both the long-range systems

²²² Secretary of Defense Les Aspin, *Report on the Bottom-Up Review* (Washington, DC: Office of the Secretary of Defense, October 1993), accessed online at <http://www.fas.org/man/docs/bur/index.html> on June 20, 2007.

²²³ *Ibid.*

necessary to threaten US naval forces on the open ocean and shorter-range systems to contest US ships operating close to shore. With no serious surface, sub-surface, or land-based threats to worry about, US carriers would likely be able to move into near-shore littoral waters without fear of attack, thereby maximizing the overland reach of their air wings—just as they had during the Korean and Vietnam Wars. Moreover, the danger to US aircraft and aircrew over enemy territory proved to be far less than it had been over either Korea or Vietnam. Due to greatly superior American training, equipment, and tactics, US tactical aviation forces were quickly able to gain air superiority, if not outright air supremacy, during operations over Iraq, Bosnia, and Serbia, enabling them to operate with relative impunity and at historically low loss rates. In other words, US defense planners assumed that both short-range land-based and sea-based tactical aviation could participate in the rapid halt phase provided they could get to theater fast enough.

A SHIFT TOWARD GUIDED WEAPON BATTLE NETWORKS

Once US short-range aircraft arrived in theater, the key to rapidly halting an enemy invasion would be their widespread use of guided air-to-ground weapons—that is, weapons capable of actively correcting their own trajectory or flight path to home on a target or geospatial coordinates.²²⁴ US interest in guided air-to-ground weapons spiked considerably during Operation Desert Storm and accelerated rapidly thereafter, especially with the introduction of relatively cheap, all-weather bombs such as the GPS-guided Joint Direct Attack Munition (JDAM), which could be dropped from medium and high altitudes above the effective range of most anti-aircraft guns and man-portable SAMs.²²⁵ Because individual aircraft employing “smart” weapons could attack targets more effectively and with far fewer bombs than larger numbers of legacy

²²⁴ Of course, the same was true for other Service aviation forces. See Watts, *Six Decades of Guided Munitions and Battle Networks: Progress and Prospects* (Washington, DC: Center for Strategic and Budgetary Assessments, 2007).

²²⁵ The JDAM was a bolt-on upgrade for unguided gravity bombs consisting of a tail section with aerodynamic control surfaces, a stabilizing strake kit for the bomb body, and a combined inertial guidance system (INS) and GPS guidance system. It proved to be cheap (\$18,000 apiece), reliable (96 percent), and extremely accurate (within nine meters of the designated aimpoint). See “Joint Direct Attack Munition,” accessed online at http://en.wikipedia.org/wiki/Joint_Direct_Attack_Munition on July 20, 2007.

aircraft employing “dumb bombs,” a wholesale shift to guided weapons meant fewer US aircraft sorties could attack more targets, making the idea of a “rapid halt” a real possibility. Accordingly, guided weapons warfare became one of the key hallmarks of US conventional campaigns during the 1990s. During four of five military operations conducted between 1995 and 1999, the percentage of conventional guided weapons employed ranged between 69 and 100 percent of all weapons fired or dropped; in the fifth, the percentage was “only” 30 percent—but still four times greater than that of Operation Desert Storm.²²⁶

Over the course of the 1990s, then, the CVWs shifted their focus toward “precision strike” operations, first by increasing the number of aircraft capable of employing laser-guided weapons, and then by modifying all aircraft to employ JDAMs. In the process, US carrier air strikes became much more hard-hitting and lethal.²²⁷ Moreover, with far fewer US forces based in forward theaters, and with a strategy that emphasized the rapid halt of enemy invasions through guided weapons bombardment, the Navy could make a strong case against any additional cuts to the size of its carrier force. Indeed, a key outcome of defense debates in the early 1990s was an agreement that forward presence requirements justified the overall number of active carriers. Forward-deployed carriers with CVWs configured for guided weapons warfare, along with Air Force long-range bombers, would likely carry the principal load during the early stages of any “rapid halt” operation, and then continue to support the joint air campaign. As a result, OSD approved a carrier force of 12 carriers, only 1.5 carriers below the Cold War average.

The shift to guided weapons was accompanied by a US “reinvention” of what the Soviets called a reconnaissance-strike complex. Whereas the Soviet conception of a strike complex envisioned *automated* command and control, the Americans envisioned an interconnected, interoperable, web-based network of sensing, planning, and targeting networks, all linked in real time to allow for collaborative and cooperative action throughout the joint force. The intent of these *joint multidimensional battle networks* was to achieve a high degree

²²⁶ Michael G. Vickers and Robert C. Martinage, *The Revolution in War* (Washington, DC: Center for Strategic and Budgetary Assessments, December 2004), p. 16.

²²⁷ The Navy lagged somewhat behind the Air Force in embracing the guided weapons revolution, but, by 2000, it had caught up. For a comprehensive theoretical and historical treatment of the precision revolution, including the adoption rates of various services, see Watts, *Six Decades of Guided Munitions and Battle Networks: Progress and Prospects*.

of shared awareness; rapid “speed of command;” dynamic targeting of guided weapons in and from the air, ground, and sea; and the precise application of battlefield effects.²²⁸

INCREASING SORTIE GENERATION

The new operational paradigm of erecting guided weapon battle networks to rapidly halt invasions with the swift application of precision firepower caused the Navy to concentrate on improving carrier sortie generation capacity. This was a logical, even clever, move. Due to the limited size of the carrier flight deck and the demands of carrier launch and recovery operations, CVWs had long had lower sortie generation rates than land-based tactical fighter wings. Increasing carrier sortie rate narrowed the gap between carrier- and land-based sortie rates and blunted any critical sortie rate comparisons made by Air Force officers. More importantly, increasing the number of sorties increased the total number of “aimpoints” that a carrier air wing could hit in a single day with precision weapons. The Navy’s focus on carrier sortie generation rates quickly led to an emphasis on “surge” sorties flown during the rapid halt phase of an MRC. Accordingly, the Navy began touting its ability to launch flurries of attacks from close offshore. For example, in 1997, during “Surge 97,” a widely publicized carrier firepower demonstration involving the USS *Nimitz* (CVN-68), the carrier generated 771 strike sorties in four continuous days of 24-hour flight operations—an average of 192 strike sorties per day.²²⁹ By 2001, the Navy claimed that each of its carriers could generate 207 surge sorties a day, including those dedicated to fleet air defense and aerial and surface surveillance.²³⁰ Three years later, in 2004, the Navy claimed that a single *Nimitz*-class CVN could launch 230 total surge sorties per 24-hour flying day for four days.²³¹

²²⁸ For a comprehensive treatment of guided weapons and battle networks, see Watts, *Six Decades of Guided Munitions and Battle Networks: Progress and Prospects*.

²²⁹ Angelyn Jewell and Maureen Wigge, *USS Nimitz and Carrier Air Wing Nine Surge Demonstration* (Alexandria, VA: Center for Naval Analyses, April 1998), pp. 1–3, 5.

²³⁰ Langford, *CVW Strike Sortie/Aimpoint Improvement*.

²³¹ Lorenzo Cortes, “Navy Aims For Higher CVN-21 Sortie Rate Over Current *Nimitz*-class Aircraft Carriers,” *Defense News*, January 23, 2004.

For operations over extended periods, the number of carrier sorties that could be generated each day dropped dramatically. In 2004, the Navy claimed that a single CVW could sustain 120 sorties in a single 12-hour flying day—just over half of the surge sortie rate.²³² However, for any sustained operation, the Navy had long planned to combine two or more Carrier Strike Groups (CSGs) to form a multi-carrier Carrier Strike Force. With one CVW on a daylight 12-hour flying day, and the other on a 12-hour nighttime flying day, a two-carrier Carrier Strike Force (CSF) could sustain up to 240 sorties per day for extended periods of time. The 15-carrier force in the late-Cold War “600-ship Navy” was based on wartime plans for seven two-carrier CSFs and a single one-carrier CSG.²³³

A POWERFUL CLOSE-IN FIGHTER

The carrier’s ever-improving ability to launch flurries of attacks was an important part of the Navy’s rationale for its large-deck carrier force. As mentioned earlier, during the 2001 Quadrennial Defense Review, the Navy developed briefing papers that showed that a 2001 carrier air wing could strike more than four times as many aimpoints a day as a 1989 CVW (692 versus 162). This dramatic improvement was due to a combination of factors. The 2001 CVW had ten more strike aircraft than the 1989 wing (46 versus 36), and every tactical jet in the 2001 CVW could employ guided air-to-ground weapons. By 2001, with more reliable aircraft and after a decade-long focus on increased sortie generation rates, the air wing could also generate more tactical air sorties per day than its 1989 counterpart (207 versus 162). Finally, the standard attack aircraft in the 2001 wing, the F/A-18C, had a standard load of four guided weapons, enabling it to strike up to four different aimpoints per sortie. In combination, these improvements translated directly into a much higher number of potential aimpoint strikes per day.²³⁴

As highlighted at the beginning of this chapter, these impressive figures are based on the most advantageous conditions. They assume that the CVW is operating at (unsustainable) maximum surge rates, the

²³² Ibid.

²³³ Polmar, *The Naval Institute Guide to the Ships and Aircraft of the U.S. Fleet*, 14th edition, p. 110.

²³⁴ These figures should be used for analytical comparison only. See Langford, *CVW Strike Sortie/Aimpoint Improvement*. See also Dave Ahearn, “Clark Says Each Carrier Can Take Out More Targets,” *Defense Today*, March 31, 2005.

weather and visibility are good, all targets are located within 200 nm of the carrier, and no aerial refueling is required, even for F/A-18Cs.²³⁵ Under more likely conditions, the maximum number of daily aimpoints that can be attacked is not nearly as great.²³⁶ This decrease is especially dramatic for targets located beyond 400 nm, when the time required to fly to and from the target is at least doubled, and the F/A-18Cs would all need a minimum of one aerial refueling to complete the mission.

Nevertheless, these daily maximum aimpoint comparisons are useful for two reasons. First, they help to illuminate the great relative improvement in CVW striking power that resulted from the culmination of the guided weapon/battle network revolution. Second, and more importantly, they reflect the carrier's post-World War II experiences. More than five decades of operational and combat experience had shaped US aircraft carriers and their embarked CVWs into superbly agile, close-in fighters. Had the competition with the Soviet Navy continued, this outcome might have been different. But with no lasting operational demand for increased range, it seems a perfectly understandable outcome.

PAST AS PROLOGUE?

Summing up the last three chapters, the lack of a consistent post-war demand signal for increased carrier aircraft range and the post-World War II development of reliable and safe air-to-air refueling techniques convinced the naval aviation community that manned carrier planes with a maximum unrefueled combat reach of 600 nm were the right tools for most of its assigned operational tasks. As a result, by the turn of the 21st century, the US aircraft carrier and its embarked CVW comprised a power-projection system with outstanding global mobility but relatively limited tactical reach.

Because of the shift to guided weapons, the contemporary US carrier force has tremendous strike capacity out to about 200 nm from the carrier. Beyond that range, however, its strike capacity drops off precipitously. In addition, the impressive strike numbers out to 200

²³⁵ Langford, *CVW Strike Sortie/Aimpoint Improvement*.

²³⁶ For a more sober view on the number of aimpoints that can be hit per day, see Lieutenant B. W. Stone, USN, "A Bridge Too Far," *Proceedings*, U.S. Naval Institute, February 2005, pp. 31–35.

nm mask a hidden potential problem. The relatively short unrefueled ranges of the CVW's strike aircraft compel the carrier to operate as close to shore as possible to extend its independent reach over the landward side of the world's littorals. If an adversary with capabilities similar to those of the Soviet Union should appear, the US aircraft carrier force would once again find itself at a severe range disadvantage. Moreover, with its relatively limited reach, persistence, and stealth, the CVW might have a far more difficult time waging an "Outer Network Battle" against an advanced maritime interdiction network, penetrating a modern integrated air defense system, or sustaining surveillance-strike orbits over denied territory. Indeed, the Tomahawk cruise missile remains the only denied-area, deep-penetration capability in the carrier strike group's arsenal. However, it is non-stealthy, unsuitable for use against mobile targets, and increasingly vulnerable to the most capable surface-to-air threats.

Nevertheless, as noted above, the current state of naval aviation can be strongly defended when *looking backward*. But the question for OSD and Navy planners is: does it make as much sense when *looking forward*? Said another way, is the aircraft carrier's storied past a likely harbinger of the future? Will aircraft carriers and CVWs lacking independent reach be well suited to the evolving future security environment? The next several chapters suggest that they will not.

VII. Rumbblings of Change

The 2001 Quadrennial Defense Review, like the 1997 QDR before it, essentially affirmed the two-MRC/rapid halt strategy developed during the 1990s. The terms “major combat operations” and “swift defeats” had replaced “major regional contingencies” and “rapid halts” in the defense lexicon, but the basic thinking remained the same. However, with the ink not yet dry on the *2001 QDR Report*, the September 11 attacks on the World Trade Center (WTC) and the Pentagon shook the nation. These attacks spurred a major US strategic reappraisal of the future security environment, as well as the military forces and capabilities needed to deal with it. This reappraisal led to changes to defense plans and strategies that have important implications for US sea-based aviation. Moreover, a potential new competitor for manned carrier aircraft emerged that promised to change the aircraft size and range relationship in a radical way.

EARLY CAMPAIGNS IN THE “GLOBAL WAR ON TERROR”

The first big harbingers of change came with the initial campaigns of the so-called “Global War on Terror” (GWOT), declared by President George W. Bush immediately after the 9/11 attacks. Both Operation Enduring Freedom and Operation Iraqi Freedom suggested that future carrier operations might look quite different than those in the past.

Operation Enduring Freedom (OEF)

After the radical Islamist Taliban regime of Afghanistan refused to surrender the al Qaeda terrorists who had planned the 9/11 attacks, President Bush ordered the US military to topple the Taliban regime

and to bring the al Qaeda leaders to justice. On October 7, 2001, little more than three weeks after the strikes on the WTC and Pentagon, US joint forces launched a counterattack. For the initial air strikes into Afghanistan, the joint force commander relied on long-range bombers—Air Force B-2s flying from the continental US and non-stealthy Air Force B-1s and B-52s flying from British-owned Diego Garcia—and the shorter-range tactical aircraft of Navy and Marine Corps squadrons flying from the USS *Carl Vinson* and USS *Enterprise* operating in the Arabian Sea. Just as aircraft carriers did during the Korean War more than five decades before, these two ships provided the US joint force with responsive tactical aviation support from the first days of the war. However, carrier operations from the northern Arabian Sea were much different than those off the coasts of Korea in 1950. In short, although the scale of the operations was much smaller, the demands for precision, networking, range, persistence, and endurance were much higher than ever before.

OEF validated the shift to guided weapons made by carrier aviation (and all US tactical aviation) following Operation Desert Storm. Afghanistan's rugged, compartmented terrain, the enemy's extensive use of caves and other fortifications, and the enemy's willingness to operate among non-combatants all demanded precise targeting and great efforts to limit collateral damage. Because of carrier aviation's careful preparations during the 1990s, the Navy was well prepared for this "precision campaign." During OEF, 93 percent of all bombs and missiles delivered by Navy CVWs were either laser- or GPS-guided, allowing for day/night, all-weather, precision weapons delivery against Taliban and al Qaeda targets.²³⁷

However, as suggested above, dropping guided bombs and missiles is only one part of a "precision campaign." Another difficult and important task is to develop the targeting coordinates and pass them to the right platform, with the right weapon, at the right time. This requires an unprecedented degree of joint battlefield networking. The first week of combat during OEF saw the CVWs bombing fixed targets in response to a tasking from the Combined Air Operations Center (CAOC) located in Prince Sultan Air Base, Saudi Arabia.²³⁸ The CAOC

²³⁷ Benjamin Lambeth, *American Carrier Air Power at the Dawn of a New Century* (Santa Monica, CA: RAND Corporation, 2005), p. 23.

²³⁸ One of the authors of this report, Tom Ehrhard, served as the chief of the Combined Air Operations Center (CAOC) strategy division for the opening months of OEF.

soon sprouted over ten T-1 line equivalents of space bandwidth in order to process imagery and disseminate the air tasking order to its far-flung air units—a networking feat in its own right. However, when the war advanced to its second stage, almost all US tactical aircraft—carrier planes included—began flying “adaptive” targeting sorties against “emergent” or “time-sensitive” targets. Carrier aircraft and aircrew were catapulted off their carriers in the northern Arabian Sea with munitions but no pre-planned targets.²³⁹ During their flights to the operating areas, Forward Air Controllers or troops on the ground passed targets to them in real time, with either GPS coordinates for JDAMs or locations suitable for finding laser bomb targets that had to be acquired visually through onboard targeting pods. F-14s also incorporated their fast tactical imagery (FTI) capability for communicating with ground forces. This capability became increasingly important with the deployment of ground-based special operations forces several weeks into the campaign.²⁴⁰ This dynamic and flexible targeting scheme meant that every aircraft and aircrew had to be wired into the broader joint fires network as never before.

Complicating everything was the distance to the OEF target areas. Even with no threats to the carriers, which allowed them to operate close to the coast of Pakistan, the range to the northernmost target areas near Mazar-i-Sharif in north-central Afghanistan was some 900 miles from the carriers—strike ranges originally envisioned only for the A-3 Skywarrior and the A-5 Vigilante heavy attack aircraft. However, with these longer-range aircraft long since retired, the CVW had to fly to these distant target areas with the aging F-14 Tomcat and the newer, but short-legged, F/A-18C Hornet. In the event, the planes and their crews were up to the challenge. Using multiple aerial refuelings, these aircraft repeatedly flew the “longest-range combat sorties ever flown by carrier-based aircraft.”²⁴¹

²³⁹ Lambeth, *American Carrier Air Power at the Dawn of a New Century*, p. 14.

²⁴⁰ *Ibid.*, pp. 32–33.

²⁴¹ *Ibid.*, p. 13.

Figure 6: Operation Enduring Freedom

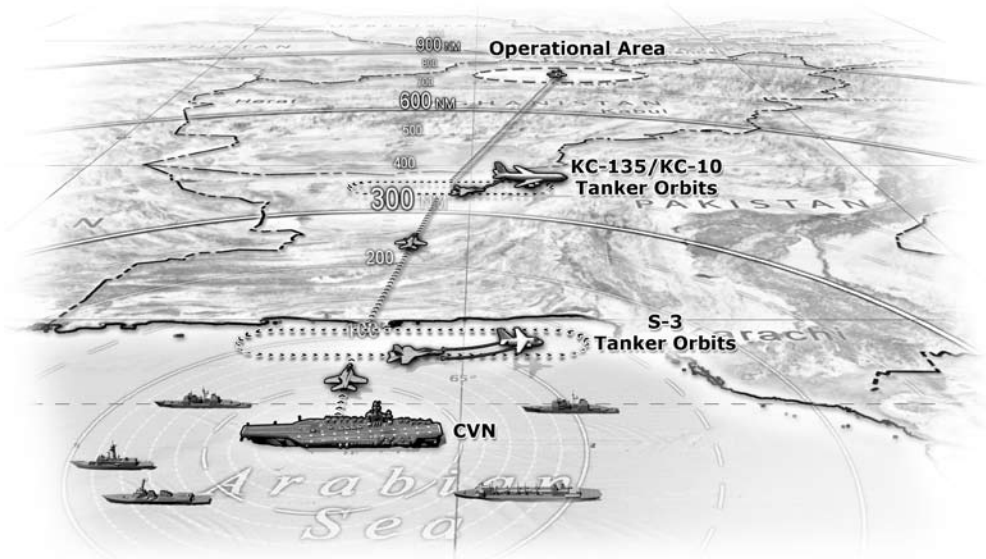

Just striking fixed targets and returning to the carrier over such ranges would have required sorties lasting five or six hours. However, after US special operations forces infiltrated into northern Afghanistan in mid-October, the campaign switched from striking fixed targets to attacking emerging targets. Joint and carrier aircraft were then required to loiter over the target area for as long as possible to provide responsive close-in fires. The high demand for overhead persistence led to sortie durations of up to ten hours—which, as will be discussed in a moment, is at the very limit of aircrew endurance, especially in single-seat aircraft. The strain on the aircraft and their crews was reflected in the dramatic decrease in the CVW's sortie generation rates, which fell to just 30-40 total sorties per day per carrier—14–19 percent of the 2001 CVW's maximum surge sortie generation capacity.²⁴²

It should be noted that these extended-range, long-duration sorties would not have been possible without the constant support from US Air Force and British Royal Air Force aerial refueling jets operating from land bases in and around the theater of operations. As the commander of one Carrier Strike Group observed, without this offboard

²⁴² Ibid., p. 22.

tanker support, naval aviation could not have participated in any operations beyond southernmost Afghanistan, where little to no decisive targeting or ground operations occurred.²⁴³

Operation Iraqi Freedom (OIF)

As the United States began planning follow-on campaigns to OEF, then-CNO Admiral Vern Clark began to modify the Navy's long practice of organizing the carrier fleet for routine, rotational deployments which kept between two and three carriers continuously forward-deployed.²⁴⁴ By better synchronizing carrier and CVW maintenance schedules, Admiral Clark aimed to organize the force to support unexpected operational surges. This resulted in the Fleet Response Plan (FRP), which allows a 12-carrier force (11 deployable) to generate up to six Carrier Strike Groups within 30 days, and two more within 90 days.²⁴⁵ In other words, rotational forward presence was augmented by a more muscular response plan that allowed for the surging of many carriers to one hotspot.²⁴⁶

The FRP was tested during the major combat operations phase of Operation Iraqi Freedom, which kicked off on March 21, 2003. No less than five aircraft carriers participated in the campaign's massive air operation, which followed the same pattern of operations seen during OEF. The focus during the first several days of attacks was on striking fixed and preplanned targets. After that, air operations shifted to flying longer, loitering missions and responding to calls for emerging "time-sensitive" targets, requiring the same high degree of precision

²⁴³ Ibid., p. 29.

²⁴⁴ Fifteen deployable carriers allow for continuous ("1.0") presence in three regions—generally, the Mediterranean, Persian Gulf, and Indian Ocean. A deployable force of 12 carriers allows for continuous presence in one region, and a maximum of ten months coverage in two others. The gaps in two theaters are longer for a force with 11 deployable carriers. All of these calculations assume one carrier is based in Japan, providing a 1.0 presence in the Pacific. Polmar, *The Naval Institute Guide to the Ships and Aircraft of the U.S. Fleet*, 18th edition, p. 107.

²⁴⁵ Once the total carrier force was reduced to 11 carriers, the numbers were six CSGs in 30 days, and one more within 90.

²⁴⁶ For a comprehensive description of the Fleet Response Concept (FRC), see Lambeth, *American Carrier Air Power at the Dawn of a New Century*, pp. 59–68.

and networking as during OEF. By the end of the major combat operations phase of OIF, carrier-based aircraft had flown nearly 14,000 of the 41,404 total sorties.²⁴⁷

Similar to OEF, the United States enjoyed uncontested sea and air supremacy, which meant that the carriers could operate with little threat of attack. However, the “battlefield geometry” of the US carrier forces, with carriers operating from the Persian Gulf, Red Sea, and eastern Mediterranean, meant that CVW aircraft still had to fly some distance to reach their target areas inside Iraq. This, combined with the need to loiter over target areas, resulted in mission lengths that rivaled those of OEF. As long-time aviation analyst Ben Lambeth noted, “With the support of non-organic US Air Force and British Royal Air Force (RAF) long-range tankers to provide multiple in-flight refuelings, combat aircraft from the two carriers operating in the eastern Mediterranean flew repeated deep-strike missions that entailed durations of as long as ten hours.”²⁴⁸

Carrier pilots were not the only aviators faced with extended-range, long-duration missions. Both Turkey and Saudi Arabia denied US requests for basing access, so even some US land-based tactical aircraft were faced with similarly long flights. As a result, the pressure on aerial tanking support was quite intense. In the end, over 200 land-based aerial refueling aircraft operating from 15 different bases supported the air operation. However, even this impressive number was less than planned; Turkey’s denial of basing rights cut around 25 percent of the planned tanker basing capacity for OIF air operations. Because of the sheer numbers of joint and coalition aircraft involved in the operation, OIF was even more dependent on aerial refueling capacity than OEF.

With both land- and sea-based fighter aircraft heavily reliant on tanking to reach their targets, and with the overall tanker force limited in size, OIF air operations were characterized by “long lines at the pump.” Indeed, many strike missions were aborted due to an aircrew’s inability to get refueled before going “bingo” on fuel (the level required to return safely to base).²⁴⁹ Worse, at least from the Navy’s perspective, was that its CVWs sometimes had to make do without land-based tanking support. For example, the *Kitty Hawk* Carrier Strike Group was told it needed to

²⁴⁷ Ibid., p. 52.

²⁴⁸ Ibid., p. 7.

²⁴⁹ Those long trains of fighters waiting for refueling represented a tempting target and would not have been possible with any sort of ground or air-based challenge to air superiority. Ibid., p. 46.

fly its close-air support missions without outside tanking help. Using the soon-to-be-retired S-3 Vikings of Carrier Air Wing 5, as well as new F/A-18E Super Hornets in the “mission tanking” role, the carrier was able to accomplish the task.²⁵⁰ Two F/A-18E mission tankers were also deployed to the *USS Abraham Lincoln* (CVN-72) to provide additional organic tanker support. Indeed, the Navy’s premier new strike-fighter flew more than 400 tanking missions during OIF—sorties that had been previously flown by the KA-6D tanker before its retirement.²⁵¹

Implications for Carrier Aviation

This quick review of Operations Enduring Freedom and Iraqi Freedom suggests that future CVWs will need to have four key capabilities. The first is ***improved precision engagement***. Guided air-to-ground weapons are now standard in contemporary US air campaigns. This is especially true in operations where the enemy tries to hide among a non-combatant population and has no aversion to using hospitals, schools, or religious sites as staging areas for attacks. Under these circumstances, the more aircraft in the CVW configured for guided weapons warfare, the better.

The CVW had transitioned to all-guided weapons strike aircraft as early as 2001. However, the ongoing fleet transition to the F/A-18E/F Super Hornet will provide substantial improvements to the CVW’s ability to deliver guided weapons. By 2010, the standard CVW will consist of 12 Navy two-seat F/A-18Fs, 12 Navy single-seat F/A-18Es, ten Navy single-seat F/A-18Cs, and ten Marine Corps single-seat F/A-18Cs, for a total of 44 F/A-18 strike-fighters of all types.²⁵² Every one of these aircraft will be able to drop a full array of guided bombs and missiles. Although this air wing will have two fewer strike-fighters than the 2001 CVW, each Super Hornet will have six wing stations capable of handling air-dropped guided weapons, compared to the four found on an F/A-18C.

²⁵⁰ Ibid., p. 48.

²⁵¹ In the mission tanking mode, the F/A-18 carries a serial refueling system (ARS) probe and drogue pod on the centerline, capable of carrying 330 gallons of aviation gas, and four 480-gallon wing tanks. Including the fuel in its internal tanks, the F/A-18E can carry a total of 29,000 pounds of fuel.

²⁵² These aircraft will be supported by four or five electronic attack aircraft (either legacy E/A-6Bs or new E/A-18 G “Growlers,” heavily modified versions of the F/A-18F Super Hornet) and four or five E-2C Hawkeye AEW air battle management aircraft. A multipurpose helicopter squadron and one or two specialized carrier delivery aircraft will round out the CVW.

Moreover, the Super Hornet's availability rate will be far superior to that of the retired F-14 Tomcat. As a result, the 2010 CVW will be able to attack a maximum of 1,080 aimpoints per day out to 200 nm—nearly a seven-fold improvement over the 1989 air wing's precision strike power, and more than 1.5 times better than the 2001 CVW's.²⁵³ This impressive gain in precision firepower may even be conservative. The introduction of smaller guided weapons, such as the 500-pound JDAM and the 250-pound Small Diameter Bomb (SDB), will mean that each aircraft wing station may be able to carry more guided weapons. This could lead to another step increase in the maximum potential number of daily aimpoint strikes. Just as important, with guided bombs ranging in size from 250 pounds to one ton, pilots will be able to better match weapon effects to targets, thereby limiting potential collateral damage.²⁵⁴

Second, both operations suggest a growing demand for **improved unrefueled range**. Although the OEF and OIF air operations proved that even short-legged, single- and dual-seat light strike-fighters can operate at extended ranges, these operations also suggested that a CVW limited to unrefueled strikes at ranges from 200 to 250 nm from the carrier will likely be increasingly stressed over time. Aircraft with greater unrefueled combat radii will help to do two things: lengthen the CVW's *independent* reach, and arrest its growing dependence on land-based tankers. As one analyst put it:

Adding range to today's relatively short-legged naval strike-fighters...can expand the maneuver of the sea base without compromising the reach or persistence of its main striking arm; increase the overland persistence and coverage of that striking arm from the same maneuver space; or a combination of the two. The greater the range extension, the more flexibility and capability result....²⁵⁵

²⁵³ Langford, *CVW Strike Sortie/Aimpoint Improvement*.

²⁵⁴ The SDB Increment I is a 250-pound bomb with a wing kit and a GPS-navigation package, allowing the bomb to achieve great accuracy and hit fixed targets. The planned Increment II weapon will add a multi-mode seeker capable of characterizing and hitting moving targets—the “Holy Grail” for the next generation of weapons. See Amy Butler, “Searching for a Seeker,” *Aviation Week & Space Technology*, August 15, 2005, p. 49. For a good discussion about the potential consequences of the SDB, see Joris Janssen Lok, “Small Size, Massive Consequence,” *Jane's International Defense Review*, December 2004, pp. 56–59.

²⁵⁵ Cote, *The Future of Naval Aviation*, p. 8.

With regard to improved range, it is true that the new F/A-18E/F Super Hornet has a 40 percent greater mission radius than the F/A-18C. However, it offers no range improvement over the now-retired Tomcat. When armed with two air-to-air missiles and four 1,000-pound bombs, the aircraft can strike targets out to about 500 nm without refueling.²⁵⁶ The transition to the new aircraft will therefore result in no substantial improvement in CVW reach. Moreover the CVW's collective unrefueled reach will still be far below that seen during the 1980s, when F-14s, A-6s, and A-7s still formed the majority of the carrier's strike arm.

Both OEF and OIF displayed the carrier's increasing reliance on land-based tanker support. Navy leadership had long planned to retire the S-3B Viking, and neither operation caused them to change its plans.²⁵⁷ On the plus side, every F/A-18E/F Super Hornet can theoretically serve as a mission tanker, which will provide considerable flexibility. Of course, every aircraft configured as a mission tanker is not available for strike missions. On balance, then, it seems likely that the CVW's effectiveness at longer ranges will be no less dependent on land-based tankers than it is today. This poses potential problems for future carrier operations. OIF, in particular, gave a glimpse of how restricted land-based tanker availability can constrain carrier operations. These problems would be even more severe should the future availability of land-based aerial refueling be more seriously diminished through political or military base denial.²⁵⁸ Just as problematic would be cases where an adversary could contest the United States for air superiority, and push the "tanker safe lines" (i.e., the closest tanker orbits can safely operate without threat of attack) farther away from carrier target areas. Aircraft with greatly improved unrefueled range would offer a good hedge against such circumstances.

Third, OEF and OIF highlighted the emerging need to loiter over a battlefield for long periods in order to strike emerging or time-sensitive

²⁵⁶ Again, different sources attribute different ranges for the F/A-18E/F. Polmar, in *The Naval Institute Guide to the Ships and Aircraft of the U.S. Fleet*, 18th edition, gives the plane an unrefueled combat radius of 475 nm (p. 406).

²⁵⁷ In 2004, the Navy implemented an S-3 "Sundown Plan," a phased retirement to be completed in 2009. Each wing loses its Vikings when two Super Hornet squadrons are assigned. US Navy Fact File, "S-3B *Viking* detection and attack of submarines aircraft," updated January 29, 2007, accessed online at http://www.navy.mil/navydata/fact_display.asp?cid=1100&tid=1500&ct=1 on April 30, 2007.

²⁵⁸ In fact, the Navy continues to make the case that land bases will be less likely in the future, even as their dependence on land-based refueling rises.

targets. This suggests a need for **improved persistence**. Indeed, as one airpower analyst put it, operations in Afghanistan and Iraq saw “*persistence eclipse sortie generation*” as the key metric for aviation effectiveness (emphasis added).²⁵⁹

Overhead persistence, at least in uncontested aerial environments like Afghanistan and Iraq, comes from a combination of aircraft *range and endurance*. However, as OEF and OIF demonstrated, manned aircraft endurance is limited less by the machine and more by the man. Even though modern jet aircraft can be refueled in the air multiple times to extend their maximum strike *range*, their maximum *endurance* is largely set by the physical limits of the men and women in their cockpits. Wearing a heavy helmet and oxygen mask while wrapped in a g-suit and strapped to an ejection seat for any length of time is tiring enough. When additionally considering the physical and mental demands required for aerial refueling, combat air maneuvering, preparing for weapons delivery, evading ground fire, and recovering back aboard the carrier, flying a combat mission of even a few hours in length can be physically draining. In practice, then, a very real upper bound for aircrew endurance sets a hard ceiling for the duration of manned tactical aircraft operations—whether they are launched from ship or shore.

The propeller-driven, non-air refuelable A-1 Skyraider, which entered fleet service in 1946, could stay airborne for up to ten hours. Then, like now, this impressive mission endurance was especially valued during close air support missions, when the ability to loiter over a target area increased the responsiveness of support. While every aircraft fitted with a refueling probe after 1953 could theoretically exceed the A-1’s mission endurance, subsequent experience showed that a ten-hour mission was about the most a typical aircrew could effectively endure in a single-seat or dual-seat cockpit. It is true that tactical aircraft have demonstrated an ability to fly missions up to 14–15 hours long with multiple aerial refuelings.²⁶⁰ However, these long-duration missions have been flown only rarely and under unusual circumstances.²⁶¹ As

²⁵⁹ Rebecca Grant, “Expeditionary Fighter,” *Air Force Magazine*, March 2005, p. 42.

²⁶⁰ F-15E crews flew a 15-hour mission during OEF, and, during the “El Dorado Canyon” strike against Libya in 1986, F-111 crews spent 14 hours in the cockpit. See Christopher J. Bowie, *Meeting the Anti-Access and Area-Denial Challenge* (Washington, DC: Center for Strategic and Budgetary Assessments, 2002), p. 11.

²⁶¹ During El Dorado Canyon, the United States was denied overflight rights by France and Spain as well as the use of European continental bases. As a result, the Air Force was forced to launch its F-111 bombers from England, and to fly

the Navy pilots who flew extended-range missions over Afghanistan and Iraq found out, and as their low sortie rates suggest, even ten-hour missions can be flown only in very low numbers. Based on experience, then, ten hours is a good yardstick for a maximum, if barely sustainable, mission duration for manned tactical aircraft.²⁶²

Finally, the first two campaigns of the GWOT suggested a requirement for **improved joint battle networking** in order to integrate seamlessly the joint tasks of surveillance, reconnaissance, intelligence, target identification, planning, communications, and dynamic attack. This is a requirement that the Navy had embraced long before OEF and OIF. In Operation Desert Storm, aircraft carriers configured for independent attacks along the Soviets' flanks found it exceedingly difficult to receive or share information with the Air Force. This triggered a decade-long effort to provide the carrier force with better communications pathways and "pipes" (i.e., bandwidth) as well as joint planning and collaboration systems. These efforts paid off in spades during OEF and OIF. As the entire Navy continues its transition toward a "Total Force Battle Network" (TFBN), composed of platforms, organizations, and people that can easily communicate and share information among each other and with joint platforms and organizations, its ability to operate as part of a joint multidimensional battle network will only improve.

When considering the required future CVW capabilities suggested by Operations Enduring Freedom and Iraqi Freedom, then, the Navy is on track to have greatly improved precision engagement and joint-capable battle networking capabilities in the near term. However, CVW range is improving only in comparison with the 1990s CVW, which likely had the worst unrefueled reach of any post-Second World War CVW. Moreover, air wing endurance and persistence will remain inherently limited, as they always have been, so long as carrier aircraft have men and women in their cockpits.

around France and Spain through the Straits of Gibraltar, adding 1,300 miles onto both the inbound and outbound legs of the flight. See "Bombing of Libya (April 1986)," accessed online at http://en.wikipedia.org/wiki/Operation_El_Dorado_Canyon on June 25, 2007.

²⁶² For a thorough discussion about why ten-hour sorties are unsustainable for manned tactical aircraft, see Bowie, *Meeting the Anti-Access and Area-Denial Challenge*, pp. 11–13.

A NEW GLOBAL MILITARY POSTURE

The need for improved CVW precision, range, endurance and persistence, and joint-battle networking was supported, in an indirect way, by changes to the way the United States positioned its forces around the world. In the 2001 Quadrennial Defense Review, then-Secretary Donald Rumsfeld announced a major reorientation of America's "global military posture." He explained the need for the reorientation in this way:

During the latter half of the 20th century, the United States developed a global system of overseas military bases primarily to contain aggression by the Soviet Union. US overseas presence aligned closely with US interests and likely threats to those interests. However, this overseas presence posture, concentrated in Western Europe and Northeast Asia, is inadequate for the new strategic environment, in which US interests are global and potential threats in other areas of the world are emerging.²⁶³

Throughout his first several years as Secretary, Rumsfeld directed a continued shift away from the Cold War's "garrison" posture, marked by nearly half-a-million personnel living with their dependents on large main operating bases in Europe and Korea, toward a new global "expeditionary" posture with far fewer forces based permanently overseas. As explained in a 2004 report to Congress entitled *Strengthening US Global Defense Posture*, once the transition is complete, there will be only two to four ground combat brigades based in Europe, two in the Pacific (one in Korea, the other on Okinawa), and a still-to-be-determined number in Southwest and Central Asia. All remaining US land combat powers will be based on US sovereign soil. However, the reduction in forward-based forces will not result in a major diminishment of US overseas *presence*. In essence, the Cold War basing network of main operating bases is being transformed into a unique expeditionary "coaling station" network of numerous, smaller cooperative security locations (CSLs) and forward operating sites (FOSS). This network is designed to support the rotational forward-deployment

²⁶³ *Quadrennial Defense Review Report* (Washington, DC: Office of the Secretary of Defense, September 30, 2001), p. 25. This is hereafter referred to as the *2001 QDR*.

of joint expeditionary forces and to facilitate the rapid concentration of US forces in time and space across intercontinental ranges.²⁶⁴

The value of naval and aerospace forces naturally goes up in any expeditionary posture, because they possess inherent global range and mobility. They also underwrite America's command of the global commons, which provides US forces with a relative long-range power-projection advantage over any potential adversary. However, in this new posture, the value of *aerospace forces at sea* rises disproportionately. With more and more US combat power based inside US territory, and fewer and fewer established overseas bases, forward access is probably less certain than at any time since the Korean War. Turkey's and Saudi Arabia's denial of US basing requests during OIF simply confirmed an ongoing trend. The thinking behind America's new global posture is that, by diversifying the locations of many FOSs and CSLs, the United States will always be able to negotiate some type of forward access during an emerging crisis, wherever it might be. However, the timelines for access negotiations might extend longer than desired. Possessing at least some "access insensitive forces" able to operate without the need for many forward bases will ensure that the US retains some operational freedom of action as base access is negotiated.

As demonstrated during the early days of the Korean War, when the North Koreans overran most of the airfields on the Korean peninsula, having a fleet of aircraft carriers is one way to introduce tactical aircraft into a theater where land-air bases are few and far between. This fact was well captured by Fleet Admiral Chester Nimitz, when he remarked that carriers:

...are able, without resorting to diplomatic channels, to establish off-shore, anywhere in the world, airfields completely equipped with machine shops, ammunition dumps, tank farms, warehouses, together with quarters and all types of accommodations for personnel. Such task forces are virtually as complete as any air base ever established. They constitute the only air bases that can be made available near enemy territory without assault or conquest, and furthermore, they are

²⁶⁴ *Strengthening U.S. Global Defense Posture* (Washington, DC: Department of Defense, September 2004). See also Robert D. Critchlow, "U.S. Military Overseas Basing: New Developments and Oversight Issues for Congress," Congressional Research Service, Report RL33148, October 31, 2005.

mobile offensive bases that can be employed with the unique attribute of secrecy and surprise, which contributes equally to their defensive as well as offensive effectiveness.²⁶⁵

As the US shifts to its new expeditionary global defense posture, the relative value of aircraft carriers will likely increase even further by improving the CVW's range, endurance, persistence, and joint networking. With these improvements, these mobile airfields will be able to respond to crises more quickly and extend their reach far deeper inland, denying potential adversaries operational sanctuary while wider basing access is negotiated. More importantly, these improvements would allow future carriers to excel at something they have never before done: assembling persistent surveillance-strike networks over the battlefield.

THE 2005 NATIONAL DEFENSE STRATEGY

The US global military posture was only one change driven by the events of 9/11. In 2005, based on the lessons learned during the ongoing Global War on Terror—especially those derived from Operations Enduring Freedom and Iraqi Freedom—the Department of Defense published a new *National Defense Strategy*. This strategy was based on the key judgment that the US military found itself without an equal in *traditional* forms of warfare—that is, conventional force-on-force operations between states employing armies, navies, and air forces. The strategy concluded that US superiority in this type of warfare, when coupled with the high costs necessary to compete in the arena, would most likely cause future adversaries to pursue an “array of...irregular, catastrophic, and disruptive capabilities and methods to threaten US interests.”²⁶⁶

As explained in the *National Defense Strategy*,

- *Irregular challengers* were those adversaries who employed unconventional methods such as terrorism, subversion, and insurgency to “impose prohibitive human, material, financial, and political costs on the United States” to compel its strategic

²⁶⁵ Admiral Chester Nimitz, as cited in Huntington, “National Policy and the Transoceanic Navy.”

²⁶⁶ *The National Defense Strategy of the United States* (Washington, DC: Office of the Secretary of Defense, March 2005), p. 2.

retreat from a key region or abandonment of a strategic course of action.²⁶⁷

- *Catastrophic challengers* were hostile states or non-state actors seeking to acquire weapons of mass destruction to threaten the US homeland, to deter US action overseas, to coerce US allies and friends, or to use them against US forces and allies. A key aim of the strategy was to “dissuade others from acquiring catastrophic capabilities, to deter their use and, when necessary, to defeat them before they can be employed.”²⁶⁸
- A few more sophisticated *disruptive challengers* would likely seek asymmetric technical capabilities, strategies, operational concepts, or tactical innovations to exploit US military vulnerabilities and to offset US military strengths, while others might “use breakthrough technologies to negate current US advantages in key operational domains.”²⁶⁹

While the *Strategy* acknowledged that the United States needed to retain an overmatching capability in traditional forms of warfare, it clearly signaled a desire to shift away from capabilities optimized to rapidly halt two nearly-simultaneous, cross-border, armored invasions and toward more flexible and adaptive capabilities designed to confront this new array of challenging non-traditional threats. When viewed in conjunction with the new expeditionary defense posture, one implication that could be drawn is that a CVW designed to blunt a conventional attack through short-range, pulsed strikes might no longer be good enough to deal adequately with future threats.

A DISRUPTIVE INNOVATION MAKES ITS MARK

During this period of strategic change and reappraisal, just as the demand for increased CVW precision range, endurance and persistence, and joint networking began to manifest itself, a new, disruptive innovation emerged that had the potential to solve the most pressing CVW

²⁶⁷ Ibid., p. 3.

²⁶⁸ Ibid.

²⁶⁹ Ibid., p. 2.

deficiencies in range, endurance, and persistence: the unmanned combat air system. By the late 1990s, advances in unmanned aircraft and their flight control software and systems had reached a relatively high level of maturity. These advances allowed the Air Force to begin serial production of the Predator UAS, and advanced systems development on the even larger, more capable Global Hawk. Both were originally conceived as long-dwell (24+ hours) surveillance platforms, with the Predator operating at medium altitudes (25,000 feet) and the Global Hawk at high altitudes (65,000 feet). Soon after the 1999 Kosovo campaign, however, Air Force planners were already hatching plans to arm the Predator, turning it into a hunter-killer UAS.²⁷⁰ The move to a purpose-built UCAS designed for more complex and difficult combat tasks did not seem to be all that great of a jump.

UCASs: Stirring Both Air Force and Navy Interest

The Air Force was particularly interested in using UCASs for the highly dangerous suppression of enemy air defenses (SEAD) role. SEAD first became a major concern in the early years of the Vietnam War, when Soviet-built SA-2 surface-to-air missiles caused the loss rate of US combat aircraft to climb abruptly. In response, the Air Force modified several F-100F Super Sabres with equipment designed to identify and locate SA-2 guidance radars, which could then be attacked by other aircraft. Operational testing proved successful, and the Air Force hurriedly fielded and dispatched new “Wild Weasel” squadrons to Vietnam to take on the new threat.²⁷¹ The inherent danger associated with aircraft dueling with SAM systems was reflected in the appalling loss rates of these first Wild Weasel efforts: almost 50 percent of the early aircraft and their crews were lost in action. However, constant tinkering with aircraft, aircrew training, weapons, and tactics steadily improved both the effectiveness

²⁷⁰ See “MQ-1 Predator,” at http://en.wikipedia.org/wiki/RQ-1_Predator; and “RQ-4 Global Hawk,” at http://en.wikipedia.org/wiki/RQ-4_Global_Hawk. Both websites were accessed online on July 1, 2007.

²⁷¹ The name Wild Weasel came from the two types of specialized aircraft and crews that originally flew these dangerous missions—those that flew into a target area at low altitude to “weasel” their way into enemy territory, locate the SA-2 radars, and mark them for attack, and the “wild” aircraft that would conduct one-on-one duels with the SAM batteries themselves. Later, the missions of Wild Weasel aircrews evolved into either Iron Hand suppression missions or Wild Weasel hunter-killer missions.

of the mission as well as the odds of crew and aircraft survival. Indeed, since Vietnam, the loss rates for planes flying SAM suppression missions have been no higher than those of other tactical aircraft.

However, in the 1990s, the appearance of advanced Russian “double-digit” SAMs²⁷² spurred Air Force planners to seek new ways to ensure that aircrews in future wars would not face a repeat of the high early losses incurred during their first encounter with new missiles. One obvious solution was to design a new Wild Weasel aircraft with a high degree of stealth. However, another solution was to take the aircrew out of the equation completely, and turn the mission over to unmanned aircraft. Even if it took some time to develop more effective SEAD tactics, no humans would be at risk. Stealthy, unmanned aircraft would also be ideally suited for long-duration “air occupations” over contested airspace, like those flown continuously over northern and southern Iraq after the end of Operation Desert Storm.

In March 1999, encouraged by the advances in unmanned aircraft technologies, the Air Force teamed with DARPA to develop a proof-of-concept unmanned combat air *vehicle* (UCAV). Boeing’s Phantom Works was contracted to build two UCAV technology demonstrators to help develop the technologies and techniques necessary to “conduct suppression of enemy air defense missions with unmanned combat air vehicles.”²⁷³ In this work, Boeing was able to draw from lessons learned during the successful Bird of Prey unmanned stealth technology flight demonstration program, executed by McDonnell Douglas from 1996 through 1999 (Boeing and McDonnell Douglas merged in 1997 to form Boeing Integrated Defense Systems). The first demonstrator, designated the X-45A, was completed in 2000, with a planned first flight sometime around 2002.²⁷⁴

²⁷² The Russian S-300 and S-400 series are known in NATO parlance as the SA-10, SA-12, and SA-20, hence “double-digit” SAMs.

²⁷³ See “Boeing X-45,” at http://en.wikipedia.org/wiki/Boeing_X-45, accessed online on August 5, 2007.

²⁷⁴ See “Boeing X-45,” at http://en.wikipedia.org/wiki/Boeing_X-45; and “Boeing Bird of Prey,” at http://en.wikipedia.org/wiki/Boeing_Bird_of_Prey. Both websites were accessed online on August 5, 2007.

Figure 7: The X-45A

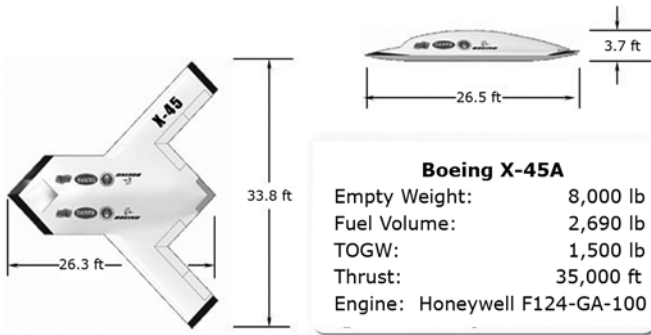

The Navy, aware of the joint Air Force and DARPA effort, decided to pursue a UCAV project of its own. It too was interested in pursuing a stealthy design, if for different reasons. The Navy would continue using manned aircraft for the SEAD mission. It planned to modify the dual-seat F/A-18F Super Hornet into an electronic attack aircraft, the E/A-18G Growler. This plan followed the same path as its predecessor, the E/A-6B, which was a modified version of the A-6 Intruder. So, instead of flying SEAD missions, the naval UCAV (referred to as both N-UCAV and UCAV-N) would be designed “for reconnaissance missions, penetrating protected airspace to identify targets for the attack waves” consisting of manned tactical aircraft.²⁷⁵ As one admiral stated:

The primary focus for developing naval [unmanned aircraft] capabilities is centered around providing intelligence, surveillance and reconnaissance (ISR) capabilities. Our whole strategy is focused on ISR. The Navy has been very consistent with the capabilities desired [in UASs and UCAs].²⁷⁶

In other words, the Navy was initially looking for a stealthy, updated unmanned aircraft to fly missions similar to those that had been envisioned for the long-discarded Lightning Bug reconnaissance drone.

²⁷⁵ See “X-47 Pegasus,” accessed online at http://en.wikipedia.org/wiki/X-47_Pegasus on August 5, 2007.

²⁷⁶ Richard R. Burgess, “Mother Ship,” *Sea Power*, July 2005, accessed online at http://findarticles.com/p/articles/mi_qa3738/is_200507/ai_n14687817 on March 28, 2007.

In the summer of 2000, the Navy awarded both Boeing and Northrop Grumman Corporation a 15-month concept exploration contract. However, NGC went beyond simple concept exploration and began developing a naval UCAV demonstrator using its own funds. In early 2001, the Navy decided to leverage this work by awarding NGC a contract to both develop an operational system concept for a carrier-based system unmanned aircraft and design a UCAV-N demonstration system. The resulting aircraft, designated the X-47A Pegasus, was rolled out on July 30, 2001, with a scheduled first flight in early 2003.²⁷⁷

Figure 8: X-47A Pegasus

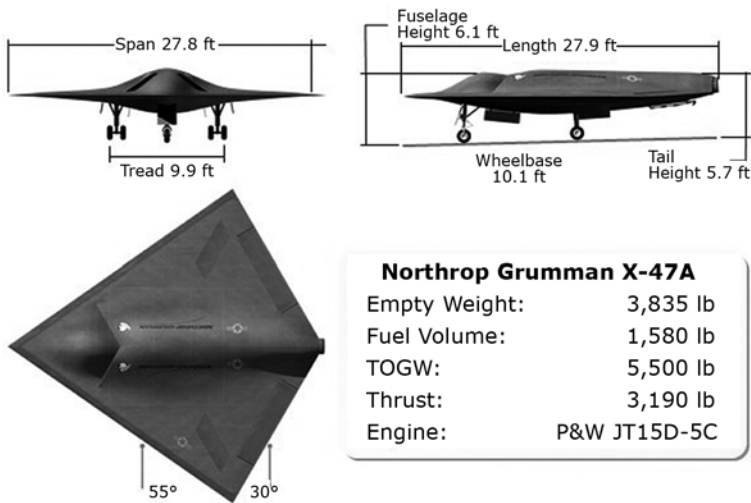

²⁷⁷ One of the reasons why the Navy chose NGC to build its UCAV-N technology demonstrator was that the X-45 was designed for land operations and was not suitable for carrier launch and recovery. In order to make the X-45 “carrier compatible,” Boeing would have to make significant modifications, or even completely redesign the aircraft. It therefore seemed to make sense to go with a new design, designed from the start as a carrier aircraft. See “X-47 Pegasus;” and “Naval Unmanned Combat Air Vehicle (UCAV-N),” accessed online at <http://www.globalsecurity.org/military/systems/aircraft/ucav-n.htm> on March 30, 2007.

Enter the J-UCAS Program

As is often the case for individual Service efforts with great technological and mission overlap, the pressure to combine the Air Force and NavyUCAV programs began to build. This pressure culminated in a December 2002 OSD program decision memorandum. The memorandum combined the two Service efforts, directing that the Air Force and the Navy set up a new Joint Unmanned Combat Air Systems (J-UCAS) program under the direction of DARPA. After some delay, DARPA's J-UCAS Project Office, along with a separate Joint Systems Management Office for Joint Unmanned Combat Air Systems, opened for business in October 2003.²⁷⁸ This move shielded the nascent UCAS programs from any Service moves to prematurely terminate them. As one former Deputy Assistant Secretary of Defense said, new programs, especially those that represent potentially disruptive technologies, are at maximum danger early in their development cycles, and before they have proven themselves.²⁷⁹ Given the constant pressures on Service budgets, it would have been relatively easy for the Air Force to terminate the X-45, or the Navy the X-47.

By the time these two offices opened, Boeing's X-45A demonstrators and NGC's X-47A demonstrator had flown and been proven airworthy. Inspired by the progress to date, the Services and DARPA quickly decided to build improved versions of both unmanned aircraft in order to demonstrate advanced technical capabilities and conduct an operational assessment. The offices crafted an ambitious seven-year plan to develop improved versions of these first "Spiral Zero" proof-of-concept vehicles, dubbed the X-45C and X-47B, respectively. This plan called for 14 Air Force and Navy UCAS prototypes to be available in time to start a two-year operational assessment in 2007. In 2010, informed by a DARPA technology assessment, OSD would then decide whether or not to pursue joint or separate operational UCAS systems. Either way, both Air Force and Navy operational unmanned aircraft were to be controlled by a common operating system—hence the shift from the termUCAV to UCAS.²⁸⁰

²⁷⁸ See "J-UCAS Overview," DARPA Joint Unmanned Combat Air Systems website, accessed online at <http://www.darpa.mil/j-ucas/index.htm> on March 28, 2007.

²⁷⁹ Jim Thomas, former Deputy Assistant Secretary of Defense for Strategy, at a CSBA-sponsored event on the Navy's Unmanned Air Combat System Demonstration Program, Washington, DC, July 11, 2007.

²⁸⁰ "J-UCAS Overview."

Northrop Grumman's X-47A made several taxi tests, but only one test flight. However, the two Boeing X-45As flew a total of 60 test sorties for a total of just more than 45 hours of flight time. Even this modest flight program provided big hints about the potential utility of operational UCASs. For example, on April 18, 2004, one of the X-45s hit a ground target with an inert, 250-pound, guided weapon.²⁸¹ Perhaps as a result, the Navy began to think of the J-UCAS as more than just a penetrating intelligence, surveillance, and reconnaissance platform. Indeed, Navy officials began speaking in terms of J-UCAS variants. As J-UCAS project officers explained:

The initial operational role for the Navy's J-UCAS is to provide carrier based, survivable, and persistent surveillance, reconnaissance, and targeting to complement manned assets and long range precision strike weapons. But to fully exploit its potential and "buy its way" onto the carrier, SEAD and strike capabilities will be designed in from the outset and fully developed in future spirals.²⁸²

Following this line of thinking, *Naval Aviation Vision 2020*, published in 2005, envisioned an ISR version of the J-UCAS entering the fleet by 2015, followed by a strike/SEAD variant in 2020.²⁸³

Changing the Size-Range Relationship

The desire for UCAS multi-mission flexibility informed the notional specifications for the follow-on version of the X-47A Pegasus—the X-47B. At just over 38 feet long, and with a wing span of about 62 feet, engineers estimated the unmanned aircraft would have a maximum gross take-off weight of approximately 45,000 pounds, a maximum operating altitude above 30,000 feet, and a high subsonic cruising speed. With an internal payload capacity of 4,500 pounds, the X-47B's unrefueled combat radius was expected to be about 1,500 nm, and perhaps more. With its penetrating ISR mission in mind, the aircraft was

²⁸¹ "Boeing X-45."

²⁸² "J-UCAS Overview."

²⁸³ *Naval Aviation Vision 2020* (Washington, DC: Department of the Navy, undated), p. 42.

also required to loiter over a target area some 1,000 nm from the carrier for two hours with its full payload. Moreover, when on a carrier deck, with its wings folded, the aircraft would have a footprint only about .87 that of an F/A-18C.²⁸⁴

Figure 9: X-47B

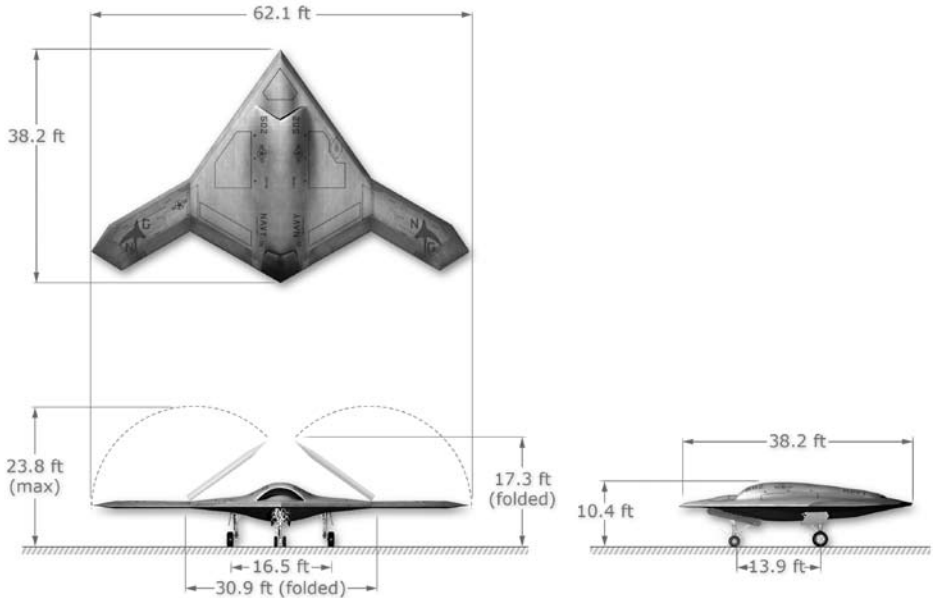

In other words, the X-47B promised to upend the size-range relationship that had so bedeviled carrier aircraft designers since 1945. Although weighing 4.5 tons less than the A-2 Savage—the smallest of the post-World War II carrier heavy attack aircraft—the X-47B would have an unrefueled combat reach over twice as long. Indeed, this unmanned aircraft, no larger than a modern-day strike-fighter, would outrange even the A-3D Whale and the A-5 Vigilante.²⁸⁵ This remarkable feat

²⁸⁴ See also “J-UCAS Overview,” p. 2; “UCAS (X-47A and X-47B) Unmanned Combat Air System,” at <http://www.northropgrumman.com/unmanned>; and “X-47 UCAV,” at <http://www.globalsecurity.org/military/systems/aircraft/x-47-specs.htm>. The latter two sources were accessed online on March 20, 2007.

²⁸⁵ These comparisons are not entirely fair since the X-47B would carry far less payload than any of these aircraft, and these aircraft were not optimized

would be made possible by two things. First, the X-47B's flying wing design has a huge advantage in lift-to-drag ratio relative to a traditional aircraft planform, and also permits a much larger fuel fraction than a comparably-sized manned aircraft. Second, the X-47B's more modern turbofan engine is markedly more fuel-efficient than the jets that powered the earlier aircraft. Together, these factors combined to give the aircraft a much greater range.

A Step Increase in Persistence

Moreover, any unmanned system automatically eliminates the biggest obstacle to CVW endurance. As Owen Cote has observed, "The one unambiguous advantage of separating air crews from their platforms is the increase in the latter's...endurance that becomes possible."²⁸⁶ The combination of increased range and longer endurance translates directly into overhead persistence. As the Pentagon's roadmap for unmanned air systems noted:

Aircraft with inhuman endurance bring ***persistent [orbits] at reduced sortie levels***. Fewer flight hours are "lost" due to reduced time otherwise needed for transit time in shorter range/endurance aircraft. Fewer take offs and landings mean reduced wear and tear, and exposure to historical risks of mishaps.... Crew duty periods are now irrelevant to aircraft endurance since crew changes can be made on cycles based on optimum periods of sustained human performance and attention (emphasis added).²⁸⁷

An X-47B equipped for automated in-flight refueling was expected to have an unrefueled mission endurance of seven hours, and an inspection-limited airborne endurance on the order of 50 hours—five times that of a manned aircraft. It would also have the space, weight, power, beyond-line-of-sight communications, and cooling necessary to carry an onboard multi-sensor surveillance package and a variety of different weapons, such as two 2,000-pound JDAMs, 12 SDBs, or four Advanced

for long endurance. However, the fact remains that the UCAS will provide far greater reach in a much smaller package.

²⁸⁶ Cote, *The Future of Naval Aviation*, p. 29.

²⁸⁷ *Unmanned Aircraft Systems Roadmap 2005–2030*, pp. 72–73.

Medium Range Air-to-Air Missiles.²⁸⁸ In other words, with aerial refueling, an X-47B-like system with “inhuman endurance” could be used to establish persistent “surveillance-strike combat air patrols” at ranges well beyond 3,000 nm from the carrier, and strike-point targets at even longer ranges—a combat reach heretofore matched only by manned, land-based, heavy bombers.

A Step Increase in Stealth

But that is not all. Recall that persistence in uncontested airspace is merely a function of range and airborne endurance. However, *in contested airspace*, persistence demands one additional important characteristic: all-aspect, “broad-band” stealth. Lacking any stealth at all, reconnaissance UASs like the Predator and Global Hawk would be easy targets for a modern integrated air defense system. Low-observable platforms with good single aspect (e.g., head-on) stealth characteristics can penetrate air defense systems, but must be constantly aware of the location of enemy radars and must fly constrained flight paths. Broad-band stealth, which allows an aircraft to defeat both low-frequency sensors like long-range search radars and high-frequency emitters like anti-aircraft radars and ground-to-air or air-to-air missiles, allows a platform to operate with less regard for enemy radars, and to fly persistent surveillance-strike CAPs deep inside an enemy’s air defense network.²⁸⁹

Unmanned aircraft have an inherent advantage in broad-band stealth. As the authors of the Office of the Secretary of Defense *Unmanned Aircraft Systems Roadmap* asserted, unmanned systems possess greater “potential for survivability by reducing signatures through optimal shaping not possible with traditional aircraft design.”²⁹⁰ Why is this so? From an air-vehicle design standpoint, the only proven way to achieve true broad-band/all-aspect low observability

²⁸⁸ Butler, “Let the Race Begin,” p. 51.

²⁸⁹ David A. Fulghum, Bettina Chavanne, and Amy Butler, “Stealth at Sea,” *Aviation Week & Space Technology*, August 13, 2007, p. 34.

²⁹⁰ *Unmanned Aircraft Systems Roadmap 2005–2030*, p. A-4. Flying wing designs such as the B-2, which minimize vertical tail surfaces and decrease drag, have been pursued as far back as World War II when the German Horten brothers and American John Northrop built flying prototypes. See John K. Northrop, “The Development of All-Wing Aircraft,” 35th Wilbur Wright Memorial Lecture to the Royal Aeronautical Society of England, May 29, 1947, accessed online at http://nurflugel.com/Nurflugel/Northrop/Northrop_address/body_northrop_address.html on April 2, 2007.

is to remove all vertically-oriented elements, especially vertical stabilizers (tails). Thus, tailless unmanned aircraft are inherently stealthier than manned aircraft like the F/A-18E/F. Removing the cockpit itself also confers stealth advantages (in addition to improving fuel and payload fractions). However, tailless, flying wing-type aircraft generally require a high angle of attack while approaching the carrier for landing. At high angles of attack, human pilots would have difficulty seeing over the nose during carrier landing operations, but this is not a concern for unmanned aircraft. Thus, tailless *unmanned* aircraft like the X-47 are stealthier than a typical manned aircraft while retaining carrier-suitable characteristics.

A Knack for Networking

Importantly, by the time the X-45 and X-47 were flying, advances in flight control and mission hardware and software allowed these unmanned aircraft to fly largely autonomously without the need for continuous pilot input. Indeed, on August 1, 2004, both of Boeing's X-45As were controlled in flight by one ground controller, suggesting that future flights of N-UCASs would require less and less human intervention. More impressive, however, were hints that these flights would be able to fight cooperatively, on their own. For example, in February 2005, the two X-45s demonstrated an autonomous ability to attack emergent, unexpected targets, after determining which vehicle was optimally armed, in the right position, and with the best fuel state to the target.²⁹¹

Even though the two X-45s were relatively unsophisticated test aircraft, they nevertheless took the very first step toward demonstrating the concept of autonomous, real-time, UCAS mission collaboration—which is much more difficult than attacking pre-planned targets over pre-programmed routes. This suggested that future UCASs could operate autonomously and cooperatively as part of future naval and joint multidimensional battle networks. Such an ability was central to the future warfighting visions of both Navy and joint planners. Indeed, as stated in *Sea Power 21*, “Future naval operations will use revolutionary information superiority and *dispersed, networked force capabilities* to deliver unprecedented offensive power, defensive assurance, and operational independence to Joint Force Commanders” (emphasis added).²⁹²

²⁹¹ “Boeing X-45.”

²⁹² Clark, “Sea Power 21: Projecting Decisive Joint Capabilities.”

Unmanned air systems and air combat systems capable of operating autonomously as part of a broader battle network promised that future naval and joint forces will be able to extend their offensive and defensive power over broader and broader areas.

In other words, a carrier-based UCAS would improve future joint forces in four areas: longer operating ranges; far more airborne endurance; greatly improved persistence, even inside contested airspace; and an ability to extend greatly the reach and depth of future joint multidimensional battle networks. With the Air Force, Navy, and DARPA all determined to exploit these improved characteristics, the J-UCAS program thus continued apace. Construction of the X-47B began in June 2005. By August 2005, the Boeing X-45A had completed its 60th and final flight, and two months later DARPA awarded a \$56 million contract modification to Northrop Grumman to build two improved X-47B demonstrators (vice the three originally planned), with a new first flight date of November 2008. The revised program plan included provisions for carrier suitability testing and mission functionality demonstrations in 2011, including electronic support measures (ESM) and multi-ship operations. Then, on November 1, 2005, management of the J-UCAS program was transferred from DARPA to a joint program office run by the Services.²⁹³

A NEW DIRECTION?

By late 2005, then, a new wind was blowing. Informed by nearly five years of war, ongoing changes to America's global defense posture, a new *National Defense Strategy* that outlined very different future defense challenges, and disruptive aircraft innovations that offered the prospect of new ways of doing business, the second Bush Quadrennial Defense Review promised to be much different than the first. The only question that remained to be answered was the scope of the impending change. As it turned out, at least from a defense-planning perspective, the answer was: quite a lot.

²⁹³ See "J-UCAS News Room (2005)," DARPA Joint Unmanned Combat Air Systems website, accessed online at <http://www.darpa.mil/j-ucas/index.htm> on March 31, 2007.

VIII. Charting a New Way Forward

The 2006 Quadrennial Defense Review was the third such review (fourth if one counts the 1993 Bottom-Up Review²⁹⁴) since the Berlin Wall was torn down by joyous Germans. The consistent defense-planning problem outlined in all previous post-Cold War strategic reviews was dealing with two nearly-simultaneous cross-border invasions in widely separated geographic theaters. However, since a key aim of the 2006 QDR was to “operationalize” the new *National Defense Strategy*, the 2006 QDR was guided by an entirely different strategy framework. Accordingly, it identified four new strategic challenges that were to guide the Services and joint commands as they worked to adapt their force postures over the next two decades:

- Defending the homeland in depth;
- Fighting the Long War against radical extremists and defeating terrorist networks;
- Preventing hostile states and non-state actors from acquiring or using weapons of mass destruction; and
- Shaping the choices of countries at strategic crossroads.²⁹⁵

Dr. Andrew Krepinevich, President of the Center for Strategic and Budgetary Assessments, applauded the new direction of the 2006 QDR, calling it “the most important and far-reaching review of our military

²⁹⁴ The Bottom-Up Review conducted by the first Clinton Administration in 1992–1993, was ostensibly the first “clean-sheet” post-Cold War strategic/posture review. See *Report on the Bottom-Up Review*.

²⁹⁵ See *2006 QDR Report*, especially pp. 19–34.

posture since the early days of the Cold War” and gave the report “high marks” for its articulated emerging challenges.²⁹⁶

Once these four emerging challenges were identified, QDR, OSD, Joint Staff, and Service planners began to analyze the joint force capabilities needed to confront them. As will be discussed in this chapter, it soon became clear that the existing joint aerospace capabilities portfolio would need to be revised and strengthened, especially in the areas of **range**, **persistence**, **stealth**, and **battle networking**.

DEFENDING THE HOMELAND IN DEPTH

The implacable hostility and global reach of international terrorist networks, the proliferation of ballistic missiles, and rapid advances in Chinese military capabilities, including unconventional means of attack, demand that the Pentagon place increased emphasis on homeland defense. As the *2006 QDR Report* put it:

The advent of long-range bombers and missiles, nuclear weapons, and more recently of terrorist groups with global reach, fundamentally changed the relationship between US geography and security. Geographic insularity no longer confers security for the country.²⁹⁷

Defending the homeland in depth implies a need for sustained global surveillance, both to identify potential threats before they fully form and to provide forewarning of imminent attacks. It also demands that the US develop capabilities to mount rapid preemptive strikes, if necessary. This helps to explain the 2006 QDR’s emphasis on improving:

- Air and maritime domain awareness capabilities to provide increased situational awareness and shared information on potential threats through rapid collection, fusion, and analysis; and

²⁹⁶ Andrew F. Krepinevich, “The Quadrennial Defense Review,” testimony before the House Armed Services Committee, March 14, 2006, accessed online at <http://www.csbaonline.org/4Publications/PubLibrary/T.20060314.QDRTestimony/T.20060314.QDRTestimony.pdf> on March 20, 2006.

²⁹⁷ *2006 QDR Report*, p. 24.

- Tailored deterrence, including prompt global-strike capabilities to defend and respond in an overwhelming manner against WMD attacks, and air and missile defenses, as well as other defensive measures, to deter attacks by demonstrating the ability to deny an adversary's objectives.²⁹⁸

Achieving air and maritime domain awareness is a critical requirement for securing the air and maritime approaches to the United States. However, given that both aerospace and maritime attacks on the country can be made over intercontinental ranges, air and maritime domain awareness is a global endeavor, demanding the assembly of a 24/7 (24 hours a day, seven days a week) surveillance network over large areas of the globe. Aerial ISR systems with long range and endurance, and with an ability to dwell over an area of interest for extended periods of time, will be critical nodes in this network and could give US decision-makers the ability to quickly focus in on any particular region or ocean of the world where intelligence suggests there is a rising threat.

As they have since the very beginning of the Cold War, prompt global-strike capabilities—the foundation for both deterrence and preemptive action—rely on aerospace platforms with great range, which enable the US to mount rapid global strikes from bases located in the United States or outside a targeted theater. Increasingly, these global-strike capabilities will rely as much, or more, on endurance, stealth, and persistence as sheer speed. In combination, range and stealth greatly increase the chances for successful unwarned preemptive strikes. And endurance and stealth, two closely related characteristics when operating inside denied airspace, allow a platform to loiter and search for targets that are either hiding or fleeting. In other words, what is most important for future global-strike capabilities is “not raw speed but ‘loiter time,’ the ability to stay in enemy airspace long enough to hunt down elusive targets and then hit them within minutes before they fade away.”²⁹⁹ When combined with an ability to coordinate their actions with other platforms, platforms with range, endurance and persistence, and stealth will be able to swarm and disperse as part of a persistent surveillance-strike network capable of rapid global strikes.

Air platforms with a combination of greater range, endurance and persistence, stealth, and networking will also be especially valuable for

²⁹⁸ Ibid., p. 27.

²⁹⁹ Sydney J. Freedberg Jr., “The Air Force’s Next Bomber,” *National Journal*, August 2007.

forward missile defense. A ballistic missile is most vulnerable immediately after launch, during its boost phase, when the missile is struggling against gravity to reach its maximum velocity, when its rocket engines are emitting a massive infrared signature, and before it has had time to deploy its individual reentry vehicles (RVs) and decoys. For this reason, boost phase attack weapons are among the most sought-after defensive weapons in any layered ballistic missile defense system (BMDS). Long-range, high-endurance, persistent, and stealthy aerial systems that are able to loiter for long times even inside contested airspace, and are armed with both air-to-ground and air-to-air weapons, would be in the very best position to make either boost-phase attacks on missiles climbing up and out of the atmosphere or even preemptive strikes while the missile is being prepared for launch.

FIGHTING THE LONG WAR AGAINST RADICAL EXTREMISTS AND DEFEATING THEIR TERRORIST NETWORKS

By 2006, the Global War on Terror had been renamed the Long War, signifying that the struggle against radical Islamist extremists and terrorists with global reach would likely be an enduring one. Dr. Andrew Krepinevich explained the nature of the primary enemy in this way: “Radical Islamists constitute a transnational, theologically based insurgent movement seeking to overthrow regimes in the Islamic world that are friendly toward the United States, and to evict US presence from parts of the world viewed as vital to America’s interests.”³⁰⁰ These extremists thrive on chaos and are instinctively drawn to regions with weak or no functioning governments—areas in which they can freely train and plan and prepare attacks against the US and its interests. Finding them is difficult because these radical terrorists seek to blend into the surrounding civil or tribal societies in both friendly and unfriendly countries. Defeating them will require, among other things, improvements to US capabilities along a broad spectrum of irregular warfare tasks, from extensive counterinsurgency to individual man-hunting operations.

Four of the joint force capabilities cited in the 2006 QDR as being necessary to defeat extremists and their terrorist networks are:

³⁰⁰ Krepinevich, “The Quadrennial Defense Review.”

- Prompt global strike to attack fleeting enemy targets rapidly;
- Persistent surveillance to find and precisely target enemy capabilities in denied areas;
- Capabilities to locate, tag, and track terrorists in all domains, including cyberspace; and
- Capabilities and organizations to help fuse intelligence and operations to speed action based on time-sensitive intelligence.³⁰¹

Once again, these capabilities suggest that joint forces need to be able to create distributed and persistent (24/7) surveillance-strike networks over known enemy operating areas. These networks must be capable of searching for terrorist targets, and attacking them as soon as they reveal themselves, and before they can disappear. Aerial platforms with the ability to both hunt *and* kill, like the Reaper hunter-killer UASs, will be especially valuable because they are able to precisely identify potential targets. Additionally, when operating as part of a surveillance-strike network based on rapid decision protocols, they can minimize the inherent time delay between identifying a fleeting threat and attacking it.

These persistent irregular warfare surveillance-strike networks will often need to be maintained over long ranges, in many cases due to the sheer geographical distances. For example, Africa and Central Asia are home to broad stretches of ungoverned areas attractive to the enemy. Moreover, an ability to assemble and operate persistent networks from long range will have the additional benefit of greatly reducing the number of foreign bases needed to conduct broad area surveillance, independent search and strike missions, and persistent surveillance-strike support of special operations forces operating against a located enemy. In some cases, such as operations against state sponsors of terror that harbor extremists planning attacks out of area, these networks will need to be stealthy. Another benefit of stealthy ISR-strike platforms is that they can help provide friendly governments with plausible deniability of US forces or counter-terrorism forces operating inside their national borders from exterior or interior bases.

³⁰¹ 2006 QDR Report, pp. 23–24.

OPERATING IN A PROLIFERATED WORLD

The third major 21st century strategic challenge facing the United States—operating in a world that sees increasing proliferation of weapons of mass destruction, especially nuclear weapons—is a problem that concerns an increasing number of strategic thinkers.³⁰² The *2006 QDR Report* mentions a number of different proliferation threats in the coming decades, such as hostile nations developing WMD capabilities and the loss of a state’s control over its nuclear inventory. These threats, as well as others that stem from the general spread of chemical, biological, and nuclear weapons technology, open the door to a future where the use of weapons of mass destruction is an increasing likelihood.

For example, the end of the Cold War saw a number of nations pursue nuclear weapons programs as a way of bolstering their international status and as a deterrent against either local enemies or the United States, or both. In 1998, India and Pakistan both unambiguously joined the “club” of nuclear-armed states. In 2006, North Korea exploded a nuclear weapon, and Iran is widely suspected of seeking the capacity to manufacture them. These events may trigger even wider proliferation. Indeed, the potential exists for a nuclear “domino effect” to spread throughout the Middle East as predominantly Sunni nations like Saudi Arabia or Egypt move to develop their own nuclear weapons if Iran successfully explodes a “Shia bomb.” Even Japan may be forced to consider a national nuclear deterrent force in light of the North Korean nuclear test and PRC military expansion. Should such a nuclear breakout occur, the probability that nuclear arms may be used either to coerce neighbors or to gain a wartime advantage seems certain to increase.

Setting aside the problem of more nuclear-armed states, the US military must also be prepared to prevent the acquisition and use of nuclear weapons by non-state actors. Leaders of al Qaeda have made their desire to get their hands on nuclear weapons quite clear, as well as their willingness to use them to further their aims. Preventing this is one of the “greatest dangers” facing the US armed forces.³⁰³

³⁰² For excellent examples of people thinking about the problem of nuclear weapons proliferation, see Fred Charles Iklé, “The Second Coming of the Nuclear Age,” *Foreign Affairs*, January/February 1996: 119–128; Paul Bracken, “The Second Nuclear Age,” *Foreign Affairs*, January/February 2000: 146–157; and Steven Peter Rosen, “After Proliferation: What To Do If More States Go Nuclear,” *Foreign Affairs*, September/October 2006: 9–14.

³⁰³ *2006 QDR Report*, p. 32.

This explains why the 2006 QDR directs all of the Services to organize, train, and equip their forces for WMD elimination operations.³⁰⁴ These operations will be made possible by improvements in the following:

- Capabilities to locate, tag, and track WMD, their delivery systems, and related materials, including the means to move such items.
- Capabilities to detect fissile materials such as nuclear devices at stand-off ranges.
- Interdiction capabilities to stop air, maritime, and ground shipments of WMD, their delivery systems, and related materials.
- Persistent surveillance over wide areas to locate WMD capabilities or hostile forces.
- Non-lethal weapons to secure WMD sites so that materials cannot be removed.
- The capability to shield critical and vulnerable systems and technologies from the catastrophic effects of electromagnetic pulse (EMP).³⁰⁵

This list of capabilities needed to support future WMD elimination operations suggests the need for joint aerial platforms with greater range, endurance and persistence, stealth, and hardened networking (e.g., ability for communication links and electronics to withstand EMP). These platforms would allow for the assembly of special counter-WMD surveillance-strike networks capable of persistent observation of a nation's WMD infrastructure; assured tracking of WMD strike systems or weapons as they are moved, shipped, or deployed to operational launch sites; or pre-emptive or preventive raids to seize WMD sites or weapons systems. Such a persistent network would need to have multi-phenomenology sensors to overcome an enemy's extensive use of decoys, as well as new WMD detection capabilities and both lethal and non-lethal weapons. Both would likely be facilitated by long-dwell, persistent surveillance. As suggested in the list above, platforms in such a counter-WMD network might need to be EMP-hardened to continue

³⁰⁴ Ibid., p. 34.

³⁰⁵ Ibid.

operating even after the use of nuclear weapons. Moreover, given the stakes associated with a future WMD elimination operation, the network would also need assured, rapid man-in-the-loop decision protocols. Finally, since any country with the resources and technical skills to pursue weapons of mass destruction will likely protect them from aerospace attack with integrated air defense systems, many of these operations will most likely demand all-aspect stealth.

Of course, the surveillance-strike networks erected to counter state-sponsored WMD programs would be equally valuable when working to deny radical extremists and terrorists access to and the use of nuclear weapons. Similarly, the persistent surveillance-strike networks needed to hunt for “loose nukes” would be similar to those needed to prosecute the Long War, except that their sought-after “high-value targets” might be a single nuclear warhead rather than a single terrorist.

In all cases, the ability to assemble persistent and stealthy counter-WMD surveillance-strike networks over long ranges may prove to be vitally important. Any operation against a WMD-armed adversary might find forward basing access denied. Countries within striking range of an enemy’s WMD forces may be unwilling to risk an attack on their territory by granting US forces operational access. If this happens, the United States must be ready to assemble and operate its WMD surveillance-strike networks from bases located at sea or outside the theater of operations.

SHAPING THE CHOICES OF COUNTRIES AT STRATEGIC CROSSROADS (AKA, HEDGING AGAINST A RISING CHINA)

The fourth strategic challenge identified in the 2006 QDR was “shaping the choices of countries at strategic crossroads,” a euphemism for the problem of dealing with the rise or decline of great powers. In this regard, the report mentioned three potential great powers that would likely attract the most US attention—China, Russia, and India. However, of these, the report singled out China as having “the greatest potential to compete militarily with the United States and field disruptive

military technologies that could over time offset traditional US military advantages absent US counter strategies.”³⁰⁶

The report did not suggest that a hostile military competition between the United States and the People’s Republic of China was pre-ordained. Moreover, even if a wider global military competition with China should occur, it would most likely develop over a long period of time due to the current state of the PRC armed forces. However, a clash with China over Taiwan could take place much sooner, primarily because of the clearly stated positions of both the Chinese and US governments. For its part, the Chinese government has explicitly declared that it would tolerate no overt Taiwanese move toward independence, and that it would use force, if necessary, to block such a move. The United States has made it equally clear that it would likely come to the defense of Taiwan in the event of a Chinese attack. Given these circumstances, Chinese political and military leaders are clearly hedging against the possibility that they may have to fight a war against the United States. Such a conflict would be characterized by highly accurate and deadly firepower and “near total battlefield awareness, nonlinear battlefields, and multidimensional combat.”³⁰⁷

As will be discussed at length later in this report, PRC military strategies and plans for such a future high-tech fight are based on anti-access/area-denial operations and tactics designed to disrupt or prevent US forces from mounting effective operations in support of Taiwan long enough to permit the Chinese to achieve their military and political aims. For the purposes of this discussion, PRC “anti-access operations” are defined as actions taken to deny US forces from deploying to a position in theater from which they can conduct effective operations against Chinese forces. They include PRC political action to coerce regional countries into denying US forces access to operational bases, and operational attacks against existing US regional bases or forward-deployed naval forces. PRC “area-denial operations” are actions taken

³⁰⁶ India was called “a key strategic partner” and Russia was listed as “unlikely to pose a military threat to the United States or its allies.” *2006 QDR Report*, pp. 28–29.

³⁰⁷ Ka Po Ng, *Interpreting China’s Military Power, Doctrine Makes Readiness* (Routledge, 2004), p. 21, accessed online at <http://books.google.com/book?id=peitJb2e9JIC&printsec=frontcover&dq=%22local+war+under+high+technology+conditions%22#PPP1,M1> on March 28, 2007; and Roger Cliff, Mark Burles, Michael S. Chase, Derek Eaton, and Kevin L. Pollpeter, *Entering the Dragon’s Lair: Chinese Anti-access Strategies and Their Implications for the United States* (Santa Monica, CA: RAND Corporation, 2007), p. 21.

within the Pacific theater of operations to deny successfully deployed US forces an ability to conduct effective operations in the vicinity of Taiwan and the Chinese mainland. These operations and tactics include, but are not limited to: attacks against US information systems, particularly the space-based components of the US global command, control, communications, and intelligence (C3I) network; integrated air defense operations; maritime interdiction operations; and air and sea attacks against US supply depots and air and sea logistics forces.³⁰⁸

To frustrate PRC anti-access and area-denial strategies, both to deter a Chinese military attack on Taiwan in the near term and to help dissuade PRC aggressive behavior over the longer term, the 2006 QDR directs the Services to develop the following capabilities:

- Persistent surveillance, including systems that can penetrate and loiter in denied or contested areas.
- The capability to deploy rapidly, assemble, command, project, reconstitute, and re-employ joint combat power from all domains to facilitate assured access.
- Prompt and high-volume global strike to deter aggression or coercion, and, if deterrence fails, to provide a broader range of conventional response options to the President.
- Secure broadband communications into denied or contested areas to support penetrating surveillance and strike systems.
- Integrated defenses against short-, intermediate-, and intercontinental-range ballistic and cruise missile systems.
- Air dominance capabilities to defeat advanced threats.
- Joint command and control capabilities that are survivable in the face of WMD-, electronic-, or cyber-attacks.

Together, these capabilities suggest yet again the high value of aerospace systems with greater range, endurance, persistence, stealth, and networking. A demonstrated ability to establish—quickly and from long range—numerous persistent surveillance-strike CAPs over Taiwan

³⁰⁸ Cliff, et al., *Entering the Dragon's Lair: Chinese Anti-access Strategies and Their Implications for the United States*, pp. xiii–xvii.

and the Taiwan Strait, even in the face of an extended PRC integrated air defense network, would negate to a large degree Chinese anti-access/area-denial strategies and plans. This capability, when combined with an ability to penetrate PRC airspace and hold specific targets at risk, even those located deep inside PRC territory, would likely introduce a high degree of uncertainty in Chinese calculations concerning the perceived correlation of forces in the Pacific, or the likelihood of a successful attack on Taiwan. The higher the level of uncertainty, the more likely the Chinese might be deterred. Thus, aerospace platforms capable of performing both these roles would be especially valuable.

THE COMMON DENOMINATORS: RANGE, PERSISTENCE, STEALTH, AND NETWORKING

Summing up, then, an analysis of the four most pressing 21st century security challenges presented in the 2006 QDR reveals four desired attributes for future joint aerospace systems: **greater range** (independent reach), **better persistence** (a combination of range and endurance, which allows for long loiter times over target areas), **all-aspect stealth** (for persistent operations inside contested airspace), and **improved battle networking** (to enable collaborative and collective action among many joint platforms). These four characteristics enable the assembly of tailored, persistent, surveillance-strike networks at any range, under any conditions, and against any threat. When these networks employ advanced munitions tailored to the task at hand, they will provide joint force commanders with a range of deployment/employment options. This helps explain why, in the 2006 QDR's final report, Secretary of Defense Donald Rumsfeld directed that all future joint air capabilities be reoriented to favor "systems that have far greater range and persistence; larger and more flexible payloads for surveillance or strike; and the ability to penetrate and sustain operations in denied areas."³⁰⁹

A key aim for any QDR is to resolve how well and how soon the existing Service programs of record develop desired joint capabilities. As a result, the Navy had to defend the plans for its future carrier force—the primary naval component of the joint aerospace capabilities

³⁰⁹ 2006 QDR Report, p. 45.

portfolio. The Navy made the case that its carrier aviation program of record was on the right track. It would soon start building the first CVN-21, the successor to the highly successful Nimitz-class CVN, which ultimately numbered ten ships. The CVN-21 will benefit from nearly four decades of technological advances since the Nimitz-class carrier was first designed. Its nuclear plant will generate three times the electrical power of a Nimitz reactor, enabling, among other things, the Navy to replace the carrier's venerable steam-powered catapult systems with a new electro-magnetic launch system. It will be equipped with a more efficient electrical distribution system, improved survivability features, and reconfigurable command and decision centers for the embarked staffs. The new carrier will also have a complement that is approximately 1,000 personnel smaller than found on a Nimitz-class carrier, which will result in significant savings over the life of the ship.³¹⁰

The CVN-21's design parameters were developed during the 1990s, when improving sortie generation rates was a top Navy priority. As a result, the CVN-21 will boast a smaller island, a redesigned flight deck, innovative aircraft "pit stops," advanced weapons elevators, and an entirely new electromagnetic aircraft launch and recovery system.³¹¹ With these improvements, the first-of-class is expected to sustain at least 160 sorties per 12-hour flying day, and be able to launch 270 sorties per day for four days under surge conditions. Compared to the current Nimitz-class figures of 120 sustained and 230 surge sorties, this represents an improvement of 33 and 18 percent, respectively. The final CVN-21 surge objective is for 310 sorties per day over four days—a 35 percent improvement over today's CVNs.³¹²

With respect to its CVWs, the Navy planned to replace the two older F/A-18C Hornet squadrons in each CVW with the new, stealthy F-35 Lightning II Joint Strike fighter, the successor to the cancelled

³¹⁰ David Brown, "Ready to Hone Ship's Details," *Defense News*, April 12, 2004; and Lorenzo Cortes, "CVN-21 Will Be the 'Big Hammer' of ESF, Admiral Says," *Defense Daily*, April 9, 2004, p. 4.

³¹¹ Sandra I. Erwin, "Carrier Flight Decks Will have 'Pit Stops' for Navy Fighter Jets," *National Defense*, November 2004; "Photo Release—Northrop Grumman Selects Preliminary Designers For CVN 21 Aircraft Weapons Elevators," Northrop Grumman News Release, February 16, 2004, accessed online at http://www.nn.northropgrumman.com/news/2004/040216_cv21.stm on April 23, 2007; and Hunter Keeter, "New Carrier Island Is at Heart of Higher Sortie Rates for CVN-21," *Seapower*, June 2003, pp. 23–24.

³¹² Cortes, "Navy Aims For Higher CVN-21 Sortie Rate Over Current *Nimitz*-class Aircraft Carriers;" and Geoff Fein, "Navy Wants Reduced Crew Size, Lower Costs for CVN-21," *Defense Daily*, June 3, 2005.

A-12 Avenger II.³¹³ The Navy wants to replace both F/A-18C squadrons with the F-35C carrier variant of the Lightning II, which is expected to have a combat radius of 650 nm or more. However, the Marines want to replace their F/A-18C squadrons with the F-35B, the short take-off and vertical landing version of the JSF. While just as stealthy as the F-35C, the STOVL aircraft has an unrefueled combat radius of less than 500 nm—essentially the same as the F/A-18E/F.³¹⁴ If the Navy prevails, the 2020 carrier air wing will consist of one 12-aircraft Navy F/A-18F squadron, one 12-aircraft Navy F/A-18E squadron, and two 10-aircraft F-35C squadrons (one Navy, one Marine). If the Marines prevail, the 2020 carrier air wing will consist of one 12-aircraft Navy F/A-18F squadron, one 12-aircraft Navy F/A-18E squadron, one 10-aircraft Navy F-35C squadron, and one 10-aircraft Marine Corps F-35B squadron.

During the 2005–2006 QDR, the Navy’s plan for the 2020 CVW also included 14–22 specialized aircraft: four to 12 J-UCASs; five EA-18G Growler electronic attack aircraft; and five E-2D Advanced Hawkeye AEW/battle management aircraft.³¹⁵

- As mentioned earlier, the stealthy J-UCASs would come in two versions: a surveillance variant, with an expected IOC of FY 2015, and a strike/SEAD version, with an IOC of 2020.³¹⁶
- The EA-18Gs, modified versions of the F/A-18F Super Hornet, would accompany the carrier strike package. Equipped with active electronically scanned arrays (AESAs), wingtip emitter

³¹³ See Lambeth, *American Carrier Air Power at the Dawn of a New Century*, p. 91.

³¹⁴ Both the Navy and Marine Corps agree that the 2020 CVW will have four strike-fighter squadrons. As part of the Department of the Navy’s “Tac-Air Integration Plan,” the Marines agreed to provide one strike-fighter squadron for each of the Navy’s ten active CVWs. The debate over whether or not the Marines should purchase the F-35B or C version still rages on. The Navy believes that it would be most cost-effective if it operated one version of the JSF, that the F-35C is the more capable aircraft, and that integrating a STOVL aircraft into the carrier deck cycle would be difficult. The Marines want to operate an all-STOVL fleet for maximum basing flexibility from carriers, large amphibious assault ships (LHAs), and austere land bases. For a good discussion of the Tac-Air Integration Plan, see *Force Structure: Department of the Navy’s Tactical Aviation Integration Plan is Reasonable, but Some Factors Could Affect Implementation* (Washington, DC: U.S. Government Accountability Office, August 2004).

³¹⁵ *Naval Aviation Vision 2020*, pp. 38–43.

³¹⁶ *Ibid.*, p. 42.

detection pods, up to five high- and low-band jamming pods, and two High-Speed Anti-Radiation Missiles (HARMs), the aircraft will protect strike groups by performing SEAD and by jamming enemy radars and communication links. With a new interference cancellation system, it will be able to communicate with other aircraft in a strike even while jamming. Growlers will normally carry two AMRAAMs for self-protection.³¹⁷

- The E-2Ds, like the E-2Cs they replace, use their powerful airborne radars to provide long-range surveillance coverage around the carrier. These aircraft direct the defensive combat air patrols that surround the carrier, and can manage the air battle from stand-off ranges.³¹⁸

ON OR OFF TRACK?

OSD leaders had to acknowledge that the program of record carrier force would be far more capable than today's. It would boast a greater sortie generation capacity, as well as superior joint battle networking capabilities. In addition to multiple high-capacity communications systems on its carriers, all of its aircraft would be equipped with advanced, jam-resistant communications systems and high-bandwidth digital data links such as Link 16, permitting high-reliability network communications with all joint air platforms. The Growler would be able to communicate with friendly aircrews even while it is jamming, and the E-2D Advanced Hawkeye would have far superior sensors, links, and cooperative networking capabilities than the E-2C it is replacing.

The 2020 CVW would also substantially improve its ability to operate against modern integrated air defense systems. With 20 versions of the F-35 Lightning II and four to 12 J-UCAS, 24 to 32 CVW aircraft would have excellent low-observable designs. The Lightning IIs are expected to have particularly good frontal-aspect stealth, enabling them to perform "first day of the war" penetrations of enemy integrated air defense networks. However, because of their twin tails and cockpits, the planes will not have the same degree of broad-band stealth as the

³¹⁷ "EA-18 Growler," accessed online at http://en.wikipedia.org/wiki/EA-18_Growler on July 31, 2007.

³¹⁸ See "E-2D Advanced Hawkeye," accessed online at <http://www.globalsecurity.org/military/systems/aircraft/e-2d.htm> on July 31, 2007.

J-UCASs, which means they will be unable to loiter deep inside an enemy IADS—at least until the IADS is degraded. Only J-UCASs could likely perform this mission.

When it came to the critical metrics of range and endurance/persistence, the Navy's program of record also looked much better. No matter which F-35 version was on the carriers' decks, the 2020 CVW would be able to deliver more strike payload out to 450 nm from the carrier, without refueling, than the current F/A-18C-equipped air wing could deliver at 250 nm.³¹⁹ It would also be able to sustain combat air patrols farther, and for longer periods.³²⁰ These are impressive relative gains over the current CVW. However, in absolute terms, the improvements in range expected in the carrier's manned strike-fighters would only gain back the range lost since the mid-1980s when the Navy began its shift to the short-legged F/A-18 strike-fighter. For example, if the Marine F-35 squadron flies the STOVL version of the plane, the CVW will have 34 manned aircraft capable of conducting unrefueled strikes out to about 475 nm from the carrier, and ten capable of conducting unrefueled strikes beyond 600 nm. If both JSF squadrons are carrier versions, the numbers are 24 and 20, respectively. In the early 1980s, before the transition to the Hornet, while there were ten fewer total strikers on the deck (24 A-7s and 10 A-6s), every one could hit targets out to 600 nm or more without the need to refuel. Indeed, the only major improvement to CVW strike range would be found in the CVW's few strike-configured J-UCASs, which would likely be capable of delivering strikes out to about 1,500 nm from the carrier.

³¹⁹ David A. Perin, "Are Big Decks Still the Answer?" *Proceedings*, U.S. Naval Institute, June 2001, p. 32.

³²⁰ The F/A-18F, armed with four AMRAAMs and two Sidewinders, can maintain a combat air patrol for 2 hours when operating 380 nm from the carrier. From "The F/A-18E/F Super Hornet: Tomorrow's Air Power Today," US Navy PowerPoint presentation, undated, slide 13.

Figure 10: Buying Back Reach With the F-35C

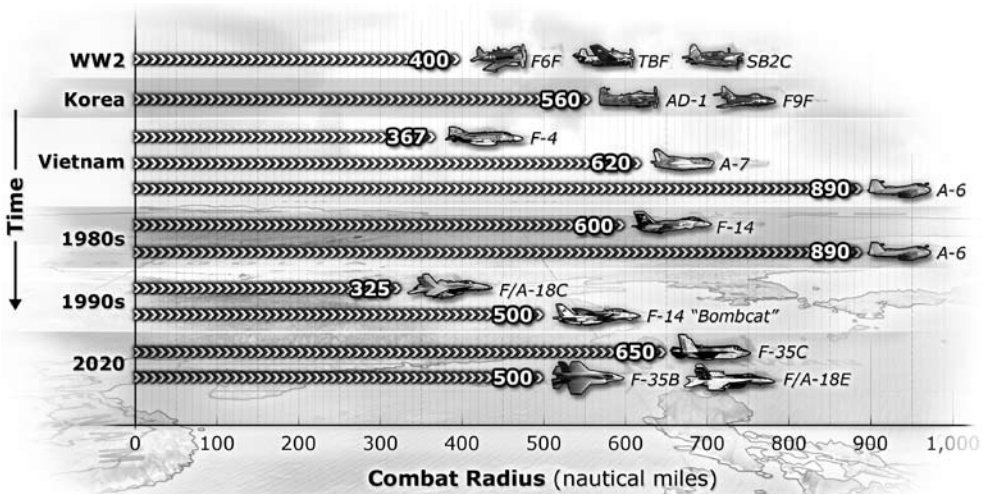

Perhaps more significantly, given the lessons of OEF and OIF and the demands of emerging security challenges, the future CVW will offer only marginal improvements in airborne endurance. Because the 2020 CVW will still consist mainly of manned aircraft, its overall endurance will be about the same as a 1950 CVW, which operated the propeller-driven, non-air refuelable A-1 Skyraider with an airborne endurance of up to ten hours. As a result, the CVW's ability to establish and sustain persistent aircraft orbits over an area of interest—even over relatively short ranges—will remain inherently limited. Generating persistent 24/7 orbits will normally require two carriers, with one operating on a “day cycle” and one operating on a “night cycle.” Moreover, as indicated above, even with the stealthy F-35, the CVW will have difficulty sustaining orbits in the face of the most advanced integrated air systems since persistent air operations against these systems require all-aspect, broad-band stealth.

The program of record's focus on greatly improved carrier sortie generation over that of more substantial improvements to CVW range, endurance, and persistence are generally consistent with the history of naval air combat between the end of the Second World War and the turn of the century. Nevertheless, it is somewhat ironic. The Navy has long pursued nuclear-powered aircraft carriers for three primary

reasons: they have virtually unlimited range at maximum speed; they have an ability to remain on-station indefinitely without refueling; and they have greater storage capacity for combat consumables. In other words, the Navy values a CVN's *long unrefueled range* and *persistence on station*.³²¹ In contrast, the carrier aviators have put far less stock in improving the range and endurance of their carrier aircraft. As a result, unless there is a change in plans, in 2020—nearly a century after the first US aircraft carrier, the USS *Langley*, was commissioned—US aircraft carriers and their embarked air wings will continue to form power-projection systems of unequalled global mobility but relatively limited tactical reach and persistence.

TOWARD A GLOBAL SURVEILLANCE-STRIKE NETWORK

As part of the 2006 QDR, OSD leaders asked two key questions about the Navy's carrier aviation program of record. First, did the Navy's planned future air wing adequately reflect the aviation lessons learned and the changes in air combat observed after the 9/11 attacks? Second, did it provide the optimum capabilities needed to perform defense in depth of the homeland; to fight the Long War against radical extremists and their terrorist networks; to confront nuclear-armed states or prevent terrorists from acquiring and using WMD; or to shape the choices of country like China in ways beneficial to the United States? The answers to these questions apparently gave OSD leaders great confidence in the Navy's general plans, as they made few changes to them. However, one change was especially significant. In the final *2006 QDR Report*, Secretary Rumsfeld ordered that the J-UCAS program be cancelled and split it into two new and separate development efforts. He directed the Air Force to upgrade its legacy long-range bomber force and to begin development of a new "next-generation long-range strike" (NGLRS) system, with an initial operational capability in 2018.³²² He next directed the Navy to continue developing a stealthy, air-refuelable, unmanned, carrier-based aircraft, capable of performing both surveillance and strike missions.

³²¹ Polmar, *The Naval Institute Guide to the Ships and Aircraft of the U.S. Fleet*, 18th edition, p. 109.

³²² *2006 QDR Report*, p. 41.

Clearly, these moves represented two sides of the same coin. They were evidently made to increase the joint force's ability to fight over longer ranges, expand its payload and launch options, and improve its ability to establish persistent, long-range airborne surveillance and strike orbits, even in contested airspace. Just as clearly, these moves created complementary programs that could be monitored and overseen by OSD, to ensure that they survived in future budget battles. Said another way, Secretary Rumsfeld judged the combination of *land-based* long-range strike systems and *carrier-based* N-UCASs to be the best match for America's new expeditionary global defense posture, which will likely see fewer and fewer combat forces based on foreign soil. Together with the US global command, control, communications, and intelligence (C3I) network, they would combine to form a *global* surveillance-strike network, providing the United States with unprecedented freedom of action and a flexible, one-two global punch for use against the full range of emerging national security challenges.

It is important to note that Secretary Rumsfeld's actions and decisions in no way suggested the end of the line for manned carrier aircraft. The 2006 QDR left untouched plans for the F/A-18E/F Super Hornet and E/A-18G Growler, and endorsed the continued development of both the STOVL and carrier versions of the F-35 Joint Strike Fighter. However, Rumsfeld clearly agreed with the authors of a recent RAND study on aircraft carrier operations who concluded that the future carrier air wing "will need to perform more extensive surveillance and reconnaissance, conduct air operations at greater distances, and be equipped to operate in nuclear environments."³²³ The wording of the QDR's final report strongly implied that Secretary Rumsfeld was unconvinced that the Navy's program of record fully exploited the potential contributions that N-UCASs could make toward these ends.

The next three chapters explain why.

³²³ John Gordon IV, Peter A. Wilson, John Birkler, Steven Boraz, and Gordon T. Lee, *Leveraging America's Aircraft Carrier Capabilities: Exploring New Combat and Noncombat Roles and Missions for the U.S. Carrier Fleet* (Washington, DC: RAND Corporation, 2006), p. xiii.

IX. N-UCAS: A Potential Game-Changing Advance in Carrier Air Wing Range, Persistence, Stealth, and Networking

The four strategic challenges outlined in the 2006 Quadrennial Defense Review represent a comprehensive and complex set of requirements for the US military. The US military can ill-afford to ignore any of them, and it is hard to imagine other challenges with equivalent import or impact. Moreover, it is entirely possible that these problems might intermix to form even more dangerous hybrid threats that involve aspects of each.³²⁴ For example, a radical extremist might gain access to nuclear weapons and seek to employ one inside the United States. This challenge would involve homeland defense, defeating terrorist networks, and defeating weapons of mass destruction. The resulting range of different possibilities is so broad that the US military cannot possibly be optimized to confront every possible threat. This circumstance therefore places extremely high value on systems that are useful across the widest range of national security problems and scenarios.

Owing to the inherent advantages of its unmanned design, as well as the global mobility of its seagoing support base, the aircraft carrier, an operational N-UCAS would likely be among the most fungible assets in the US defense portfolio. Because of its great range, persistence, and stealth, it would be able to perform missions beyond the capabilities of manned aircraft, and enable US aircraft carriers to perform both their traditional missions better and to undertake completely new missions. As mentioned in the previous chapter, this does not mean the N-UCAS will supplant manned aircraft anytime soon. For example, manned

³²⁴ See, for example, Frank G. Hoffman, *Conflict in the 21st Century: The Rise of Hybrid Wars* (Arlington, VA: Potomac Institute for Policy Studies, December 2007), accessed online at http://www.potomac institute.org/publications/Potomac_HybridWar_0108.pdf on February 15, 2007.

aircraft will certainly be required for air-to-air combat for quite some time. And, in any case, where an enemy does not have modern air defenses, or after an IADS has been suppressed in cases when it does, manned aircraft will have an important role in delivering high-payload strikes over shorter ranges. Regardless of the great potential of unmanned air systems, the Department of Defense will therefore need to maintain manned aircraft well into the future as a hedge against the uncertainty over just how quickly that potential is realized. Unquestionably, however, it seems apparent that N-UCASs clearly have the potential to perform a far more expanded and important role in future CVWs.

The following chapters assume that an operational N-UCAS, configured for aerial refueling, would have an unrefueled strike radius of *at least* 1,500 nm, and a maximum aerial endurance of 50 to 100 hours. Its standard onboard sensor package would include a digital electro-optical and infrared camera, synthetic-aperture radar with a moving target indicator, and a signals intelligence (SIGINT) package. It would have a modular, flexible mission bay capable of carrying a wide variety of additional sensor pallets or weapons, including either two 2,000-pound JDAMs, 12 SDBs, or four AMRAAMs. Moreover, by virtue of its tailless planform, the N-UCAS would be stealthier than the JSF, and able to operate persistently inside an advanced IADS.³²⁵

The maximum persistent surveillance-strike orbits portrayed in the following sections presume that all future CVWs would have one surveillance-strike squadron with 12 multi-role N-UCASs.³²⁶ This N-UCAS squadron would be in addition to the two squadrons of Super Hornets and two squadrons of F-35 Lighting IIs already in the Navy's program of record. The calculations assume the N-UCAS has a full-mission capability rate of 90 percent and a recovery-to-launch "turnaround" time of two hours—figures similar to those called for in the original J-UCAS program. Finally, the discussion assumes a communications constellation that is capable of supporting all the described operations.

³²⁵ Fulghum, Chavanne, and Butler, "Stealth at Sea," p. 34.

³²⁶ This is the upper limit of the number of J-UCASs assumed in the aforementioned *Naval Aviation Vision 2020*. The 12 J-UCASs were to come in two versions—an ISR variant and a strike/SEAD variant. This report assumes all 12 N-UCASs are multi-role aircraft capable of performing both of these missions, as well as others.

If anything, the above assumptions are conservative. They are based on the planned performance of the J-UCAS and the expected performance of the UCAS-D system. Five years from now, advances in engines and other technologies might easily result in even more impressive aircraft.

N-UCAS AND HOMELAND DEFENSE IN DEPTH

At least two potential homeland defense missions would benefit from the extended range and persistence offered by N-UCAS. These are defending the continental United States from long-range cruise missile attacks, and providing global defense in depth against ballistic missile attacks.

The N-UCAS's ability to fly persistent surveillance-strike orbits at extended ranges could be quite valuable if the United States confronted a state or non-state actor armed with land-attack cruise missiles. Due to the difficulty in tracking and intercepting high-speed or stealthy cruise missiles, a future homeland defense scenario involving cruise missiles would focus on killing the "archers" not the "arrows"—just as the Navy planned to do during the Cold War Outer Air Battle. In cases where the missiles might be employed from ships, long-loitering N-UCASs armed with air-to-surface guided munitions would provide a more effective outer-ring defense than manned aircraft, which would be limited to mission lengths no more than ten hours long. Against airborne threats, or against cruise missiles, N-UCASs carrying air-to-air missiles, and operating under the control of manned airborne warning and control platforms like the E-2D Hawkeye or Air Force Airborne Warning and Control System (AWACS), could form the outer edge of an extended continental integrated air defense network at ranges beyond the effective range of any air-launched land-attack missile. Of course, the N-UCASs could also operate from land bases. In either case, because of their long endurance, N-UCASs would be a far better choice for this mission than manned fighter-interceptors. As for submarine-launched cruise missiles, the N-UCAS could also be configured for wide-area anti-submarine warfare operations, serving as a remote monitor of sonobuoy sensor networks, as a long-range ASW aircraft able to prosecute attacks

against a distant submarine target, or as an air defender against cruise missiles launched from submarines.³²⁷

As suggested in the previous chapter, forward boost-phase ballistic missile defense (BMD) is another homeland defense mission that is uniquely suited to the N-UCAS's capabilities. The only US boost-phase defensive system of record is the Airborne Laser (ABL)—a specially-modified Boeing 747 jetliner equipped with special optics and a chemical oxygen iodine laser (COIL). The employment concept for the ABL is for the plane to fly figure-eight patterns over friendly territory or in uncontested airspace, scanning the horizon for missile “plumes.” Once a ballistic missile launch is detected, the aircraft would first illuminate the missile with a tracking laser, which would allow the ABL's adaptive optics to account for atmospheric turbulence, and then fire the COIL in a three- to five-second burst, weakening the missile's skin and causing a catastrophic failure. Of the several potential problems with this concept, two stand out. The first is the effective range of the COIL. The American Physical Society calculated that, under the best of conditions, the maximum effective range of the laser against liquid-fueled rockets would be approximately 320 nm, while the maximum effective range against solid-fueled rockets would be only half that. Against any capable enemy with a modern integrated air defense system, operating a large, ungainly B-747 within 160 nm of a ballistic missile launch area would be very risky. And, second, because the ABL's primary weapon is a chemical laser, the ABL fleet would need to operate from a large, fixed, forward theater base, with storage facilities for large amounts of toxic, volatile chemicals. This base would be a natural target for enemy attacks.³²⁸

A better, more survivable boost-phase BMD system might be an N-UCAS specially modified to carry and employ the new Network-Centric Airborne Defense Element, or NCADE. NCADE is an AIM-120 AMRAAM equipped with a new second-stage liquid-fueled rocket motor and the advanced infrared seeker of the AIM-9X Sidewinder. The former gives the NCADE the added speed necessary to catch a ballistic missile in its boost or early ascent phase; the latter allows it to home in on the ballistic missile's high-infrared signature. Although the NCADE

³²⁷ The Navy is working on a suitcase-size control console that could be operated from either E-2Ds or P-8 patrol craft. See Fulghum, Chavanne, and Butler, “Stealth at Sea,” p. 34.

³²⁸ See “Airborne Laser,” at <http://www.fas.org/spp/starwars/program/abl.htm>; and “Boeing YAL-1,” at http://en.wikipedia.org/wiki/Boeing_YAL-1. Both websites were accessed online on September 10, 2007.

is heavier than a standard AMRAAM, it has roughly the same dimensions, likely allowing for its internal carriage inside an N-UCAS. As the missile is specifically designed to operate as part of a broader ballistic missile defense network, it would be cued by external sensors.³²⁹ The first actual test of the NCADE concept occurred in December 2007, when an F-16 multi-role fighter engaged and destroyed a sounding rocket in its boost phase. Expectations are that an operational NCADE would have an operational engagement range of approximately 100 nm.³³⁰

The N-UCAS/NCADE combination could help make the US aircraft carrier force both a formidable theater ballistic missile defender as well as the leading edge of a national BMD system. Even when more than 3,000 nm away, a carrier equipped with a single 12-aircraft N-UCAS squadron could establish up to five 24-hour-a-day, persistent BMD CAPs inside a hostile power's air defense network and above its missile launch sites within ten hours. It could establish more CAPS as the carrier closed the range.³³¹ Two aircraft carriers would double the number of orbits. Armed with guided air-to-ground weapons, orbiting N-UCASs could launch preemptive precision attacks on missile launch sites should final launch preparations be observed. Alternatively, when equipped with NCADEs, the N-UCAS would conduct boost-phase intercepts of any missiles that were launched.

Indeed, a Carrier Strike Force equipped with N-UCAS could potentially establish and maintain a stifling BMD network over almost any rogue regional nuclear power, providing an important additional capability to the land-based missile defenses stationed in Alaska.³³²

³²⁹ See "NCADE — An ABM AMRAAM?" Defense Industry Daily, December 6, 2007, accessed online at <http://www.defenseindustrydaily.com/ncade-an-abm-amraam-03305> on September 10, 2007.

³³⁰ "US Jet Intercepts Ballistic Missile for the First Time," accessed online at http://www.breitbart.com/article.php?id=071204233530.iix59uhf&show_artic on December 6, 2007.

³³¹ It is worth noting that the number of persistent missile defense CAPs that the US military can currently generate is *zero*.

³³² For example, Raytheon executive Mike Booen states that the entire North Korean missile launch complex in eastern North Korea could be covered by NCADE-equipped aircraft operating in international airspace. N-UCASs could perform such ballistic missile defense (BMD) picket orbits much more effectively than manned platforms. Moreover, due to their stealthy configuration, they could be operated much closer to the launch complexes. David A. Fulghum, "Space-RAAM: Veteran AIM-120 dogfight missile is recast as a ballistic missile interceptor," *Aviation Week & Space Technology*, May 21, 2007, p. 31.

When operating in conjunction with surface combatants armed with anti-ballistic missiles capable of mid-course intercepts, the N-UCAS's prospective ability to provide reliable boost-phase intercepts could give the nation a compelling defense in depth against all types of ballistic missiles, and a visible capability that the President could deploy for effect in order to diffuse a crisis or to deter a potential nuclear adversary.

N-UCAS IN THE LONG WAR

Recall the 2006 QDR listed four capabilities necessary to win the Long War: persistent surveillance to find and precisely target enemy capabilities in denied areas; an ability to locate, tag, and track terrorists in all domains, including cyberspace; systems and organizations to help fuse intelligence and operations to speed action based on time-sensitive intelligence; and prompt global strikes to attack fleeting enemy targets rapidly. The range, persistence, stealth, and flexibility inherent in the N-UCAS design could offer a means to achieve each of these capabilities at the same time in the same platform, and could enable aircraft carriers to assemble very effective, specially-tailored airborne counter-terror networks.

Today, a propeller-driven system like the MQ-1 Predator UAV, which has approximately 20-hour endurance, can loiter over an area longer than most platforms, but its persistence is hampered by its relatively slow transit speed and its inability to be refueled in-flight.³³³ Depending on the distance from the Predator's operating base to its operating area, and prevailing winds, actual mission-loiter can be quite limited. Moreover, because it lacks low-observable design characteristics, the Predator is vulnerable to ground-launched air defenses. In contrast, with a refueled endurance of 50 hours (limited by jet-engine lubricant), and assuming a one-hour transit time to and from tanker orbit located nearby or over a target area, an N-UCAS could spend almost two *days* per mission loitering over an area of interest. Furthermore, due to the N-UCAS's low-observable design and much higher operating speeds, it could operate effectively inside even the defended airspace of a state sponsor of terrorism for operationally meaningful periods of time by dashing in and out to a tanker operating at the tanker safe line.

³³³ The MQ-1 Predator's slow transit speed becomes a strength when conducting real-time surveillance, as it can stay locked on a target with very slow changes in target aspect.

Disrupting terrorist networks with global reach demands improved man-hunting capabilities. These demands spurred the development of tagging, tracking, and locating (TTL) technologies, many of which can be monitored from long distances.³³⁴ Long-loiter unmanned aviation systems of all kinds, including the Predator, Global Hawk, and next-generation stealthy, unmanned aircraft like N-UCAS will likely be the platforms of choice for monitoring and tracking moving targets that have been tagged. The same logic pertains to the coming proliferation of very small, unattended ground sensors, which will require stealthy monitoring or relay of signals to distant monitoring stations. With its low-observable design and flexible mission bays, the N-UCAS would be the ideal system to covertly emplace and monitor a ground sensor grid, or to act as a remote relay of collected information.

Of course, Air Force experience with the Predator amply proves that, after uncovering a high-value target during man-hunting missions, having a surveillance-strike system overhead is far preferable to just a surveillance system. Being able to minimize the time between detecting the target, receiving authorization to attack, and delivering a weapon is vitally important for these types of fleeting targets. In this regard, an operational N-UCAS would be able to carry both a very capable onboard sensor system and up to 12 GPS-guided small diameter bombs. Clandestine ground operatives, off-board sources, or the N-UCAS's own onboard sensor systems could target these bombs, which can be used to attack both fixed and moving targets.³³⁵

Global man-hunting will also put a premium on multiple, networked systems loitering in the area of interest. The redundancy afforded by these collaborative networks becomes very important when human targets of interest take evasive action by dividing into various

³³⁴ Michael Vickers noted that, if implemented, initiatives proposed in the 2006 QDR could result in a substantial increase in TTL related to the Long War. Michael Vickers, "Implementing GWOT Strategy: Overcoming Interagency Problems," testimony before the House Armed Services Subcommittee on Terrorism, Unconventional Threats and Capabilities, March 15, 2006. This testimony can be accessed online at <http://www.csbaonline.org/4Publications/PubLibrary/T.20060315.ImplementingGWOT/T.20060315.ImplementingGWOT.pdf>.

³³⁵ According to the military capability clearinghouse Global Security.org, "The GBU-39 variant of the 250-pound class bomb is equipped with an INS/GPS guidance system suitable for fixed and stationary targets. The GBU-40 second variant adds a terminal seeker with automatic target recognition capabilities more suitable for mobile and re-locatable targets." See "Small Diameter Bomb / Small Smart Bomb," accessed online at <http://www.globalsecurity.org/military/systems/munitions/sdb.htm> on March 30, 2007.

groups—the so-called “squirter” problem. This requires the trailing surveillance-strike platforms to split up and follow multiple bearings (or to launch a sufficient number of loitering-guided submunitions). With tanker support, a single carrier with a 12-aircraft UCAS squadron could assemble and maintain a five-ship counter-terrorist surveillance-strike network up to 3,000 nm away from a carrier. When given the artificial intelligence to act cooperatively, as the Boeing X-45A recently demonstrated, this network could conduct collaborative hunts of terrorist targets, splitting up as needed to follow as many as five individual groups. In this endeavor, they would be aided by the same high-capacity data links and satellite communications currently planned for the F-35C.

Long range and persistence also pays off in other anti-terrorist activities such as counter-sanctuary operations, especially in remote areas. For example, Central Asia is likely to be an attractive future operational theater for radical extremists and their terrorist allies. Nearly all of the nations in Central Asia suffer from weak governments and/or a lack of internal stability, conditions perfect for movements or organizations seeking to establish an operational sanctuary. From the enemy’s perspective, another benefit derived from operating in this region is the lack of any major permanent, or even rotational, US presence.

Very few defense planners anticipated a major US conflict in Afghanistan prior to 9/11, and its geographical remoteness posed special problems for operations there. However, as challenging as that campaign was from the perspective of geographical access, other Central Asian nations present even more daunting access challenges, especially for naval aviation. For example, from operating areas in the northern Arabian Sea, the distance to Kabul, the capital of Afghanistan, is 900 nm. In comparison, from the same location, the capitals of Turkmenistan, Uzbekistan, Kyrgyzstan, and Kazakhstan are all 1,100 to 1,500 nm away. Should the United States someday find itself conducting another counter-sanctuary campaign in Central Asia, having an N-UCAS capable of delivering guided weapons strikes out to 1,500 nm without refueling would allow carrier air wings to participate in the earliest stages of any counter-sanctuary operation—without having to wait for supporting tankers or combat search and rescue aircraft to get into theater. Moreover, once air operations shifted from striking fixed targets to loitering over target areas in order to provide responsive strike support to US special operations or ground troops, and with land-based tanker support (operating out of Bagram, Afghanistan, for example), each N-UCAS squadron could indefinitely sustain five to

seven surveillance-strike CAPs over an Central Asia area of operations with very little stress on carrier launch and recovery operations. Alternatively, the CVW could transfer its N-UCAS squadron ashore, and operate from a forward operating site like Bagram, Afghanistan, extending the system's unrefueled reach deep in Central Asia.

Another region of weak governance and instability is Africa. Unsurprisingly, then, radical Islamist groups are active in the Horn of Africa, and al Qaeda "franchises" are now sprouting up across the Sahel, the semiarid zone stretching across northern-central Africa that separates the Sahara Desert in the north from the tropical savannahs to the south. The nine Sahelian countries that comprise the region (Burkina Faso, Cape Verde, Chad, Gambia, Guinea-Bissau, Mali, Mauritania, Niger, and Senegal) are among the poorest in the world, and have loosely defined borders—perfect operating conditions for terrorists. As a result, Africa is considered an increasingly important theater in the Long War, as indicated by the State Department-funded Pan-Sahel Initiative and the recent Department of Defense decision to create a new African Command (AFRICOM).³³⁶

The enemy knows that the remoteness and vast distances that characterize the Sahel make any sort of US surveillance or special operations presence very difficult. However, the endurance of unmanned aircraft would allow AFRICOM, if need be, to establish a surveillance-strike presence over the entire Sahel in support of both man-hunting and counter-sanctuary operations. For example, three carriers, one operating in the Mediterranean and one off both the east and west coasts of Africa, could sustain up to 15–21 N-UCAS surveillance-strike CAPs across the entire northern width of Africa. Once again, the combination of the N-UCAS's longer range and endurance would allow the US carrier force to perform missions once assigned only to land-based aviation.

Another benefit of the N-UCAS's range and endurance would be a sharp increase in carrier response times, which are now generally limited by the Carrier Strike Group's maximum rate of advance of 30

³³⁶ See "Pan Sahel Initiative (PSI)," accessed online at <http://www.globalsecurity.org/military/ops/pan-sahel.htm>. AFRICOM will not include Egypt, which will stay under Central Command, and is due to stand up on September 30, 2008. Vince Crawley, "U.S. Creating New Africa Command To Coordinate Military Efforts," *USINFO*, February 6, 2007, accessed online at <http://usinfo.state.gov/xarchives/display.html?p=washfile-english&y=2007&m=February&x=20070206170933MVyelwarCo.2182581&chanlid=af>. Both websites were accessed on April 23, 2007.

knots. N-UCAS, with a cruising airspeed of 450 knots and a refueled endurance of 50 hours or more, could serve as a new type of airborne “flying squadron.” If, for instance, a brewing crisis in Nigeria prompted the Secretary of Defense to order a US carrier to the Gulf of Guinea from its home port in Norfolk, with en-route tanker support (potentially from the Azores), the CVW could theoretically launch a long-range N-UCAS surveillance sortie on the very day it left port. As the carrier closed to within 3,250 nm, it could assemble and maintain five surveillance-strike CAPS over Nigeria or the Gulf of Guinea; at 1,700 nm, the number would climb to six, and at 500 nm, it would climb to seven. At that point, the full power of the CVW would come into play. This type of responsiveness would qualify aircraft carriers and their CVWs as true global surveillance-strike systems, capable of augmenting the operations of Air Force long-range bombers. Of course, both would be highly dependent on forward tanker support.

An N-UCAS could also pioneer new ways to conduct old naval missions. Imagine, for a moment, that a state or non-state terrorist group began waging *guerre-de-course* against commercial shipping in Southeast Asia or inside the Malaccan Strait. The numerous islands and corresponding chokepoints in the area would provide operational bases for the terrorists while also channeling shipping traffic, facilitating terrorist surveillance and target selection. Moreover, the group could attack at times and places of its own choosing. The traditional means to tackle this problem would be to surge large numbers of Coast Guard and/or Navy vessels into the area and to escort ships through the danger zone. However, with their combination of range and endurance, Navy BAMSs and N-UCASs could be used to establish a persistent counter-terrorist network, enabling quick responses to attacks against commercial vessels. Cargo ships, container ships, and tankers transiting the area would “check in” with the network coordinator during their passage through the area, under the watchful surveillance of an orbiting BAMS. Ships with extremely high-value cargos might then take aboard a military support officer. If the ships are approached by a suspicious vessel, these officers could call in an N-UCAS for a detailed, real-time visual observation of the threat. And, if the ship is fired upon or threatened by boarding, the armed N-UCAS could potentially destroy the attacking vessel. Obviously, this scheme would require carefully developed rules of engagement agreed upon by neighboring countries. However, under favorable circumstances, such a counter-terrorist network could serve as a powerful deterrent against attacks and favorably influence shipping companies’ willingness to transit dangerous waters.

As this short discussion suggests, then, the N-UCAS could add a new, flexible, and potentially highly effective capability to the US counter-terrorist portfolio.

N-UCAS IN A PROLIFERATED WORLD

A world in which weapons of mass destruction are more highly proliferated and their use is more likely is an unnerving one. In such a world, the N-UCAS's unique combination of range, persistence, and stealth could be very valuable for both defense and deterrence. As suggested by the earlier discussion on forward BMD, in an emerging crisis, N-UCASs could be used to assemble multiple counter-WMD CAPs over a hostile state that has an active WMD program with development facilities (e.g., a biological weapons laboratory or nuclear warhead production plant) and/or fielded weapons and attack forces. The aircraft on CAP could both monitor the adversary's forces and conduct preemptive strikes against weapons storage or production facilities, or intercepts on weapons or warheads carried on aircraft or missiles, if necessary. Because of the N-UCAS's high degree of stealth, unless their forces were equipped with advanced air search radars, the state's leaders could not know for certain when or where counter-WMD CAPs were assembled above them. However, if any UCAS-equipped aircraft carrier was operating within 3,000 nm, they would have to acknowledge the possibility that N-UCASs were already operating inside their airspace. This could inject a measure of doubt and uncertainty in their minds, and potentially deter them from threatening or launching nuclear strikes.

Imagine, for example, that in 2020 the Iranians test a nuclear weapon and announce they have a small number of nuclear-armed missiles. In response, the President orders an unwarned preemptive attack to attempt to destroy Iran's ballistic missile arsenal. Obviously, this would be a high-risk endeavor, requiring precise target intelligence and the ability to both attack the missiles on the ground and in the boost phase. Moving short-range tactical aircraft into theater at either land bases or on aircraft carriers inside the Persian Gulf could tip off the Iranians to US intentions. In any event, the threat of Iranian anti-ship cruise missiles, aviation-strike and mine-warfare forces, and swarming boats might argue against operating carriers inside the Persian Gulf. Under such conditions, conventionally-armed ballistic missiles, long-range stealthy bomber forces, N-UCAS-armed aircraft carriers, and

small special operations teams operating inside of Iran could be vital to the success of the operation.

The N-UCAS could be an especially valuable asset in such preemptive attacks as it could perform a variety of important missions, among them: covert reconnaissance of Iranian nuclear attack forces, augmenting US space surveillance and on-the-ground special operations; covert tracking of located Iranian missile systems; unwarned pre-emptive attacks on missile launch systems, either under the control of special operations forces or distant mission planners; stealthy post-attack assessment; and area boost-phase ballistic missile defense. All of these missions could be conducted from carriers operating at range in the Mediterranean and Arabian Seas. Indeed, with minimal tanker support, these carriers could provide persistent, covert surveillance-strike and BMD coverage over all of Iran. In short, they could be key players in any US WMD elimination operation.

Beyond preemptive strikes against an adversary's nuclear forces, N-UCASs would also be very useful in two other types of WMD elimination operations: strategic raids designed to secure the nuclear stockpile of a failing or failed nuclear-armed state, and strategic raids designed to seize and/or destroy a nation's WMD infrastructure. Such raids would necessarily include some type of ground component, most likely special operations forces. In the case of the former, the ground forces would secure the weapons, render them safe, and transport them to a safe location. In the case of the latter, they would occupy critical infrastructure sites to search and destroy, dismantle, or secure high-value equipment and weapons. In both cases, these raids would likely take place deep inside a state's borders, far beyond the range of traditional logistical support lines and organic fire support assets. Under these circumstances, an extended-range, long-endurance surveillance-strike platform like the N-UCAS would be a valuable addition to the joint force arsenal. It could be used to provide persistent high-fidelity, real-time surveillance and rapid fire support to dispersed forces located at multiple sites deep inside an enemy's territory.

SHAPING THE CHOICES OF CHINA—A COUNTRY AT A STRATEGIC CROSSROADS

Since Operation Desert Storm, the United States has enjoyed a monopoly in the guided weapons warfare/battle network regime, giving it an enormous conventional overmatch against regional adversaries. However, this tremendous advantage in “traditional” warfare has caused US adversaries to seek ways in which to overcome or offset US military strengths. As outlined in the 2005 *National Defense Strategy* and 2006 QDR, irregular challengers pursue terrorism, guerilla warfare, and operations in complex physical and human terrain to deny American battle networks a target and to weaken US will over time. Catastrophic challengers pursue weapons of mass destruction to deter the assembly of US conventional battle networks.³³⁷

The N-UCAS’s combination of range, endurance/persistence, and stealth could make it uniquely suited for operations against both irregular and catastrophic challengers, and hybrids of the two (e.g., terrorists seeking weapons of mass destruction). But what about disruptive challengers—more powerful challengers who seek to compete directly with the United States in the guided weapons/battle network regime, but who pursue asymmetric technical capabilities, strategies, operational concepts, or tactical innovations to exploit US military vulnerabilities and to offset US military strengths? As mentioned in the previous chapter, even if it seeks to avoid a direct military confrontation with America, the People’s Republic of China is the one state now most able to pursue this alternative. Moreover, its current military development and procurement program provides stark evidence that it has embarked upon just such a path.

The focus of the ongoing, thorough PRC military build-up is on developing anti-access and area-denial capabilities—those military capabilities needed to deter, delay, or defeat any American move to thwart PRC political-military objectives in the Western Pacific, especially those that relate to Taiwan. Because the strategic geography of the Western Pacific makes US naval forces in general, and aircraft carriers in particular, key components of any effective US military intervention in the East Asian littoral, those capabilities able to keep US carrier strike forces at bay are at the very top of the current PRC strategic “shopping

³³⁷ The great US monopoly in guided weapons/battle network warfare, and adversary reactions to it, are well covered in Watts, *Six Decades of Guided Munitions and Battle Networks: Progress and Prospects*.

list.” Reflecting this fact, the Chinese are developing a maritime reconnaissance-strike complex that will likely be every bit as deadly as the one built by the Soviets in the latter stages of the Cold War—and one much more difficult to defeat.³³⁸

In other words, the US carrier force is once again faced with the prospect of an intense and long-term operational-tactical competition with a potential major adversary intent on denying it access to a region critical to US security, or on destroying it once it arrives. Understanding this developing competition is important for US strategic and naval planners. Accordingly, the next two chapters examine the rise of the new Chinese maritime reconnaissance-strike complex, and explain in detail why and how a future N-UCAS may provide the key to defeating it.

³³⁸ See, for example, Cliff, et al., *Entering the Dragon’s Lair: Chinese Anti-access Strategies and Their Implications for the United States*.

X. The Rise of a Chinese Maritime Reconnaissance-Strike Complex

AN ECONOMIC POWERHOUSE

One cannot understand the PRC's impressive expansion in military capabilities without acknowledging the engine behind it—China's burgeoning economy. In 1978, the Chinese Communist Party (CCP) made economic expansion its top priority. Key to this goal was a gradual shift from a Soviet-style centrally-planned economy to a more market-oriented model modified to account for the Chinese communist political framework. The Party's leaders refer to this system as "Socialism with Chinese Characteristics."³³⁹

By whatever name, the results of the CCP's efforts have been impressive. Agricultural and industrial growth rates averaged ten percent during the early 1980s. After a short downturn caused by accelerated price reforms in the late 1980s, China's economic expansion regained its momentum after President Deng Xiaoping pushed new market reforms during the 1990s. By December 2005, China overtook Italy to become the sixth largest economy in the world. Chinese leaders predict that their country's economy will overtake Germany's in 2008, moving it to number three among world powers, and Japan's by 2020, moving it to number two. Provided that there are no economic shocks, they expect to overtake the US economy, and claim the title as world's largest economy, no later than 2040.³⁴⁰

³³⁹ See "Economy of the People's Republic of China," accessed online at http://en.wikipedia.org/wiki/Economy_of_the_People's_Republic_of_China on August 5, 2007.

³⁴⁰ "Economy of the People's Republic of China."

THE “PROSPEROUS NATION, STRONG MILITARY” MODEL

For Chinese strategists, the country’s impressive and sustained economic growth and its military strength are now inextricably linked—they no longer believe they can have one without the other.³⁴¹ This close relationship between China’s economic and military aims, referred to by the Chinese as the “prosperous nation, strong military” model,³⁴² is clearly evident in Chinese grand strategy, which aims to:

- Maintain balance among competing priorities for sustaining momentum in national economic development; and to
- Maintain favorable trends in the security environment within which such economic development can occur.³⁴³

It is also clearly evident that the Chinese believe that the security threats to their economic interests are growing. These thoughts are made plain in a CCP white paper published in December 2006, which stated that, “Security issues related to energy resources, finance, information and international shipping routes are mounting.”³⁴⁴ As one Chinese professor wrote, “*Economic globalization entails globalization of the military means for self-defense.... With these complex and expanding interests, risks to China’s well-being have not lessened, but have actually increased*” (emphasis added).³⁴⁵

³⁴¹ Gordon Fairclough, “Surface Tensions: As China Grows, So Does Its Long-Neglected Navy,” *The Wall Street Journal*, July 16, 2007. For an in-depth discussion of the connection between Chinese economic growth and military expansion, see *Military Power of the People’s Republic of China 2006* (Washington, DC: Office of the Secretary of Defense, Annual Report to Congress, 2006), Chapter Four, “Resources for Force Modernization,” pp. 18–23.

³⁴² John J. Tkacik, Jr., “China’s Quest for a Superpower Military,” The Heritage Foundation, Backgrounder No. 2036, May 17, 2007, p. 2.

³⁴³ See *Military Power of the People’s Republic of China 2006*, p. 9.

³⁴⁴ Fairclough, “Surface Tensions: As China Grows, So Does Its Long-Neglected Navy.”

³⁴⁵ *Ibid.*

EVOLVING CHINESE MILITARY THOUGHT

Although the PRC military cannot yet compete with the US military on a global scale, its expanding strategic focus and rapid capability gains are quite impressive. China's national military strategy has evolved from a focus on continental territorial defense to defending areas along the country's periphery as well as the extended aerospace and maritime approaches to the motherland. At the same time, Chinese operational doctrine has shifted from defensive operations designed to exploit the country's great territorial depth and huge population in order to wear down an invading enemy, to high-intensity, relatively short-duration offensive operations designed to seize the initiative and to set the conditions for the rapid achievement of limited diplomatic and political aims.³⁴⁶

After its rapprochement with the United States in 1973, the main Chinese military concern was defending against a limited Soviet invasion of the industrialized northern regions of the country. Under these circumstances, the traditional Chinese strategy of luring an invading army deep into its territory and fighting a battle of annihilation no longer applied. The Chinese would instead need to craft strategies that thwarted the Soviets' more limited aims, an effort that led to the new doctrine of a "People's War Under Modern Conditions." This doctrine relied on the People's Liberation Army (PLA) to block Soviet advances while Chinese guerilla forces attacked their rear areas and lines of communication. Once these guerrilla attacks had worn down a Soviet advance, the PLA would counterattack and eject the Soviet forces. As the Cold War went on, Chinese strategists concluded that most future military contingencies would resemble this model. That is, China no longer had to worry about fighting wars against enemies who were intent on conquering China or dismantling the CCP and state. Instead, it would more likely fight wars limited in geographical scope and political objectives, fought to "assert one's own standpoint and will through limited military action."³⁴⁷

To fight limited wars around the entirety of China's long continental borders, PRC strategists began to extol the benefits of an active defense based on early offensive action. Consistent with this new view, the Chinese Central Military Commission (CMC) directed the development

³⁴⁶ Cliff, et al., *Entering the Dragon's Lair: Chinese Anti-access Strategies and Their Implications for the United States*, p. 18.

³⁴⁷ *Ibid.*, p. 19.

of new “first units”—rapid reaction forces capable of moving quickly along interior lines of communication and acting decisively upon arrival in an area of operations. The need for these first units to operate in all military dimensions naturally demanded that they be “joint,” a requirement that began to undermine the long dominance of the ground forces in the PLA hierarchy.³⁴⁸

Impact of Operation Desert Storm on Chinese Military Thinking

With the end of the Cold War and the collapse of the Soviet Union, the United States became the nation which most preoccupied and concerned Chinese strategists. For this reason, the 1991 Gulf War spurred a major reevaluation of PRC strategic thinking. The ease with which US and Coalition forces overwhelmed and defeated the Iraqi military, well-equipped with Soviet and Chinese weapons, had a tremendous and sobering impact on Chinese political and military leaders. The Chinese carefully noted the great American skill in coordinating joint operations, as well as its great advantages in surveillance and reconnaissance, information systems, and weapon systems. In particular, the Chinese were surprised by the effectiveness of US tactical air forces, and the way US airmen skillfully combined command and control planes, tankers, long-range bombers, stealth aircraft and multi-role fighters, guided air-to-ground munitions, and conventional LACMs to overwhelm the Iraqi air defense and ground combat forces. The Chinese were equally impressed with US space forces, which supported the US joint force with reliable space-based navigation and communications, as well as near real-time weather and missile warning data.³⁴⁹

In June 1991, when considering how the American “revolution in military affairs” (RMA) should affect the “development of defense-related scientific research and army building,” the Chinese Academy of Military Science identified three different potential developmental pathways: the existing People’s War School; the “Limited, High-Technology War School;” and the “RMA School.”³⁵⁰ After two years of

³⁴⁸ Ibid., p. 20.

³⁴⁹ Ibid., pp. 20–22.

³⁵⁰ Jason E. Bruzdziński, Chapter 10, “Demystifying *Shashoujian*: China’s ‘Assassin’s Mace’ Concept,” p. 318, accessed online at http://www.mitre.org/work/best_papers/best_papers_04/bruzdzinski_demystify/bruzdzinski_demystify.pdf on August 20, 2007.

debate, President Jiang Zemin ordered the PRC high command to begin organizing, training, and equipping the military to fight “local wars under high-technology conditions”—limited wars, fought over limited political objectives but characterized by high-intensity, short-duration, multidimensional campaigns. As mentioned earlier, these campaigns would be waged with guided weapons of unprecedented accuracy and lethality together with “information equipment of all kinds...linked into wide-ranging networks, forming huge information systems with [command, control, communications, computers] ISR systems at their core.”³⁵¹ In other words, President Zemin apparently wanted a PRC military able to form and employ multidimensional battle networks as powerful as those employed by the United States.

“Defeating a Superior with an Inferior”

When comparing US and Chinese capabilities, Chinese military leaders were well aware of the inferiority of their combat systems and tactics, techniques, and procedures. Indeed, this condition helped to inform the development of PRC strategic principles for “defeating a superior with an inferior.” These principles were all based on the common assumption that even the most powerful of potential opponents like the United States cannot be superior in every military capability or skill, much less in politics, diplomacy, and geography. This would be especially true of a major power with global responsibilities, which must spread its attention (and forces) in order to confront many different problems. Therefore, should the Chinese find themselves in a limited confrontation with the United States, they would avoid a traditional symmetrical force-on-force fight with the US military and instead seek to seize the initiative early by exploiting initial surprise, achieving information superiority, launching preemptive attacks, and concentrating their efforts on the achievement of limited strategic aims. At all times, their strategy and tactics would seek to raise the potential costs of any US intervention.³⁵²

³⁵¹ Cliff, et al., *Entering the Dragon's Lair: Chinese Anti-access Strategies and Their Implications for the United States*, pp. 22–23.

³⁵² *Ibid.*, pp. 27–44.

“Key-Point Strikes”

As these strategic principles make plain, PRC strategists wanted to prevent the United States from winning the *initial engagement* in any limited war, controlling the pace and scope of escalation thereafter, or gaining the strongest position during war termination negotiations. One way to achieve this aim would be to mount “key-point strikes” aimed at crippling or degrading US operational superiority in a particular military dimension—that is, strikes that could have a direct influence on the ultimate outcome of a particular campaign or operation. Key-point targets might include command systems, information systems, specific weapon systems, logistics systems, or the links that connect all of them together.³⁵³

BUYING “ASSASSIN’S MACE” CAPABILITIES

By 1996, the heavy PRC emphasis on surprise, preemptive strikes on key-point targets, seizing the initiative, and raising the potential cost of any future conflict was increasingly reflected in calls from Chinese military and political strategists for new *shashoujian*, or “assassin’s mace,” capabilities.³⁵⁴ *Shashoujian* were ancient hand maces that could be concealed in a wide sleeve, and immediately employed with little or no warning to break swords and crush human skulls, even those protected by helmets. Today, *shashoujian* weapons and combat methods are those powerful enough to deter a superior adversary like the United States, or to defeat US forces in modern, high-tech warfare. The search for special weapons and methods that could be used to surprise and cripple US forces was an attractive one to all of the Chinese strategic schools. Indeed, between 1996 and 2000, Chinese expert Michael Pillsbury counted no less than 20 articles that espoused *shashoujian* as the best way to confront the superior US military.³⁵⁵

³⁵³ Ibid., pp. 34–37.

³⁵⁴ The three Chinese characters that make up the term *shashoujian* are literally translated to kill (*sha*), hand (*shou*), and sword, club, or mace (*jian*). The most common translation is “assassin’s mace.” Bruzdinski, Chapter 10, “Demystifying *Shashoujian*: China’s ‘Assassin’s Mace’ Concept,” p. 312.

³⁵⁵ Ibid., pp. 314, 322. See also Victor N. Corpus, “America’s Acupuncture Points: Part 2: The Assassin’s Mace,” *Asia Times Online*, October 20, 2006, accessed online at <http://www.atimes.com/atimes/China/HJ20Ad01.html>, on August 15, 2007.

As further explained in 2002 by Senior Colonel Yang Zhibo, then-deputy researcher in the Office for Planning and Management Research at the PLA Air Force (PLAAF) Command College, *shashoujian* is:

...whatever the PLA needs to win future local wars under high-tech conditions. It includes two aspects: (1) weapon systems and equipment (e.g., hardware); and every type of combat method (e.g., software). Weapons and equipment are the systems needed to deal with the enemy's electronic warfare and information warfare, and to counter every type of weapon and equipment the enemy can use for firepower attack. [*Shashoujian*][c]ombat methods include attacking different types of weapons...as well as the combat principles to deal with different situations.

To build a *shashoujian*, China must first complete a development program. It is a difficult, systematic process and not just one or two advanced weapons. It is something all the Services will use. It is an all-army, all location, composite land, sea, and air system.... The development of weapons, equipment, combat methods, and training must go hand-in-hand for them to be effective.³⁵⁶

From the Chinese perspective, the power of *shashoujian* would help make up for China's "one low and five insufficiencies"—its poor (i.e., low) integration of information technology with armaments and equipment, and its lack of high-power armaments; weapons for launching attacks; guided munitions; ISR, early warning, and command and control capabilities; and electronic armaments.³⁵⁷

The Chinese refuse to reveal what they consider to be *shashoujian* weapon systems. However, US analysts believe that they include anti-satellite weapons to deny US forces the use of space; computer network and information attack capabilities, like EMP weapons, to disrupt US command and control and information systems; and weapons able to

³⁵⁶ Bruzdinski, Chapter 10, "Demystifying *Shashoujian*: China's 'Assassin's Mace' Concept," p. 315.

³⁵⁷ Ibid., p. 330.

penetrate an enemy's defended space reliably, like ballistic missiles.³⁵⁸ *Shashoujian* combat methods likely include what US strategists refer to as anti-access/area-denial strategies— strategies designed to delay the assembly of US multidimensional battle networks, to keep them beyond effective range of Chinese territory, or to defeat them once they come within range. These methods might include attacks on logistics, transportation, and support forces, attacks on sea, land, and ports, and attacks on enemy air bases. They might also include coercive measures designed to dissuade US allies from granting US forces operational access to their bases.³⁵⁹

The PRC's determined pursuit of *shashoujian* capabilities is perhaps best illustrated by its quest for an effective ASAT weapon. In 2001, the Director of the Defense Intelligence Agency, Vice Admiral Thomas Wilson, testified to Congress that US military forces might confront Chinese anti-satellite capabilities by 2015.³⁶⁰ One year later, he advanced that timeline to 2010.³⁶¹ Yet on January 11, 2007, after three failed attempts made in 2005 and 2006, PLA rocket forces destroyed an inoperative Chinese weather satellite at an altitude of 865 kilometers (466 nm)—three years sooner than predicted by US intelligence agencies.³⁶² The rapidity with which the Chinese were able to overcome the technological challenges of an ASAT weapon helps to explain why US military planners can ill-afford to underestimate either the sophistication or the pace of Chinese military modernization, especially when it comes to *shashoujian* capabilities designed to defeat US power-projection and joint multidimensional battle networks.³⁶³

³⁵⁸ Wang Wei, "The Effect of Tactical Ballistic Missiles on the Maritime Strategy System of China," *Shipborne Weapons*, August 2006, translated by SN Danling Cacioppo, pp. 12–15.

³⁵⁹ See Cliff, et al., *Entering the Dragon's Lair: Chinese Anti-access Strategies and Their Implications for the United States*, pp. 60–80.

³⁶⁰ Vice Admiral Thomas R. Wilson, "Global Threats and Challenges Through 2015," Statement for the Record, Senate Armed Services Committee, March 8, 2001, p. 14.

³⁶¹ Vice Admiral Thomas R. Wilson, "Global Threats and Challenges," Statement for the Record, Senate Armed Services Committee, March 19, 2002, p. 17.

³⁶² See "2007 Chinese Anti-Satellite Missile Test," assessed online at http://en.wikipedia.org/wiki/2007_Chinese_anti-satellite_missile_test on August 1, 2007.

³⁶³ For an elaboration on this logic, see Thomas P. Ehrhard, testimony before the US-China Economic and Security Review Commission, February 2, 2007. This testimony can be accessed online at http://www.uscc.gov/hearings/2007hearings/written_testimonies/07_02_01_02wrts/07_02_1_2_2_ehrhard_tom_statement.pdf.

US AIRCRAFT CARRIERS AS "KEY-POINT TARGETS"

From the US Navy's perspective, perhaps the most worrisome *shashou-jian* weapons and methods are those aimed at sinking its carrier fleet. The standing of the People's Liberation Army Navy (PLAN) has increased steadily since 1978, when economic growth became the lodestar that guided Chinese strategic thinking. Prior to that time, the PLAN was structured to conduct "maritime guerrilla warfare" in accordance with the People's War doctrine, and was clearly subordinate to the PLA.³⁶⁴ However, as one Chinese strategist wrote, "The oceans are our lifelines. If commerce were cut off, the economy would plummet. We need a strong navy."³⁶⁵ Accordingly, during the 1980s, and informed by a study of post-World War II conflicts, the CMC ordered a qualitative improvement to PLAN forces. Then, after reviewing Operation Desert Storm, the Commission concluded that the Navy should once again get an infusion of funds, and that its shipbuilding account should be substantially increased.³⁶⁶

As part of the general post-Gulf War focus on preparing for "local war under high-technology conditions," Chinese naval planners naturally took note of the importance that US aircraft carriers play in American power-projection operations. One Chinese researcher estimated that US carriers provide up to 80 percent of American airpower in expeditionary operations.³⁶⁷ However, these analytical findings were brought home in a more compelling way to CMC leaders in 1996, during their tense stand-off with the Taiwanese government over its moves to assert Taiwanese independence. During the crisis, the Chinese government signaled its displeasure and seriousness by test-firing ten unarmed ballistic missiles into waters near Taiwan. In response, the United States ordered two Carrier Strike Groups into the area.³⁶⁸ China's inability to keep US aircraft carriers out of strike range of the Taiwan Strait shook PRC political and military leaders, and galvanized

³⁶⁴ See "[People's Liberation Army] Navy," *Jane's Sentinel Security Assessment—China and Northeast Asia*, June 21, 2007.

³⁶⁵ Fairclough, "Surface Tensions: As China Grows, So Does Its Long-Neglected Navy."

³⁶⁶ "[People's Liberation Army] Navy."

³⁶⁷ Chen Huan, "The Third Military Revolution," as cited in Cliff, et al., *Entering the Dragon's Lair: Chinese Anti-access Strategies and Their Implications for the United States*, p. 72.

³⁶⁸ Fairclough, "Surface Tensions: As China Grows, So Does Its Long-Neglected Navy."

their search for *shashoujian* weapons and combat methods of all types, designed to prevent a similar occurrence in the future. As stated in a recent Department of Defense report to Congress on expanding PRC military power, “The 1995-1996 Taiwan Strait crisis served as a catalyst to focus China’s efforts and mobilize resources for military modernization and expansion.”³⁶⁹

Unquestionably, the crisis also resulted in the designation of US carrier strike forces as “key-point targets.” As one Chinese strategist wrote, US aircraft carriers pose “a great threat to anti-air operations in littoral areas and should be resolutely countered.”³⁷⁰ This triggered a serious examination of carrier vulnerabilities and the development of weapons systems and tactics to attack and sink them.³⁷¹ As the Department of Defense’s report on PRC military power stated, “Following the experience of U.S. intervention with carrier battle groups during the 1995 and 1996 Taiwan Strait crises, evidence suggests the Chinese military has invested in research, development, and technology acquisition oriented on anti-carrier operations.”³⁷²

LEARNING FROM THE SOVIETS

Chinese anti-carrier efforts benefited greatly from the Soviet Cold War experience, and access to updated Russian anti-carrier weapons. As a major recent study on PRC anti-access and area-denial strategies noted, “Chinese strategists appear to base most of their anti-carrier tactics on the experiences of other countries (Russia in particular) in contending

³⁶⁹ *Military Power of the People’s Republic of China 2006*, p. 17. Chinese writers put a slightly different spin on this incident, claiming that their Han-class nuclear-powered attack submarines (SSNs) kept the carriers from approaching within 200 nm of Taiwan. See Andrew S. Erickson and Lyle J. Goldstein, “China’s Future Nuclear Submarine Force,” *Naval War College Review*, Winter 2007, p. 58.

³⁷⁰ Cui Changqi, “21st Century Air Attacks and Counter Air Attacks,” as cited in Cliff, et al., *Entering the Dragon’s Lair: Chinese Anti-access Strategies and Their Implications for the United States*, p. 72.

³⁷¹ Michael Pillsbury was among the first China experts to note the heightened interest of PLAN officers and Chinese researchers in attacking US carrier vulnerabilities. See Michael Pillsbury, ed., *China Debates the Future Security Environment* (Washington, DC: National Defense University Press, 2000), pp. 83–85.

³⁷² *Military Power of the People’s Republic of China 2006*, p. 24.

with [US] carrier forces.³⁷³ It should come as no surprise, then, that the desired PRC tactical aim is to attack and sink US carriers before they can get their aircraft into effective strike range of the Taiwan Strait. Barring that, PLAN anti-carrier operations seek to force the carriers to operate from ranges that will seriously degrade the effectiveness of US carrier air wings.³⁷⁴

With regard to the latter, PRC naval strategists appear to have set their sights on establishing a carrier “keep out zone” that extends hundreds of miles away from the Chinese coast. In 2004, in a broad, historically sweeping analysis reminiscent of Alfred Thayer Mahan’s seminal work *The Influence of Sea Power on History*, PLAN captain and naval strategist Xu Qi suggested that although China’s maritime influence at the time only spread to the “first island chain” (including the Aleutians, Kurils, Japan, the Ryukyus (including Okinawa), Taiwan, the Philippines archipelago, and the Greater Sunda Islands),³⁷⁵ China should strive for a true “blue water navy” and a progressive expansion in the scope of China’s “maritime strategic defense.” As an intermediate step, Xu Qi wrote that China should aspire to “carry out *multi-dimensional precision attacks* in the sea area beyond the first island chain [and] threaten important political, economic, and military targets within strategic depth,” out to some 1,600 nm from the Chinese mainland (emphasis added).³⁷⁶

Xu Qi did not explicitly list aircraft carriers as being among the important military targets in this extended offshore engagement zone. However, given the high priority PRC strategists put on destroying US aircraft carriers, it is easy to infer that they are among them. For this reason, DoD’s recent PRC Military Power Report stated that:

PLA planners are focused on targeting surface ships and submarines at long ranges. Analyses of current and projected force structure improvements suggest that in the near term, China is seeking the capacity to hold

³⁷³ Cliff, et al., *Entering the Dragon’s Lair: Chinese Anti-access Strategies and Their Implications for the United States*, p. 74.

³⁷⁴ *Ibid.*, p. 71.

³⁷⁵ “[People’s Liberation Army] Navy.”

³⁷⁶ Xu Qi, “Maritime Geostategy and the Development of the Chinese Navy in the Early Twenty-first Century,” first published in 2004 in *China Military Science* and translated by Lyle J. Goldstein and Andrew S. Erickson, *Naval War College Review*, Autumn 2006, p. 60.

surface ships at risk through a layered defense that reaches out to the “second island chain.”³⁷⁷

The second island chain includes the Japanese Bonin Islands, the Marianas (which includes the US territory of Guam, which sits roughly 1,510 nm from Taiwan and about 1,590 nm from the Chinese mainland, consistent with Xu Qi’s 1,600 nm defensive perimeter), and the Palau Group.³⁷⁸ Other strategists suggest that the PRC carrier-aviation exclusion zone may extend “only” out to 1,000 nm.³⁷⁹

In other words, among the *shashoujian* capabilities that most likely attract PRC and PLAN strategists is a maritime reconnaissance-strike complex/battle network capable of attacking US aircraft carriers between 1,000 and 1,600 nm miles from the Chinese mainland.³⁸⁰ This new PRC maritime reconnaissance-strike network will borrow from the Soviet model, and blend old and new weapons and methods to take advantage of nearly two additional decades of technological advancements and operational research. Although, in its initial rendering, this network’s optimal engagement range will be somewhat less than that of the earlier Soviet network, which relied on the Backfire bomber as its primary extended-range attack system, it will still out-reach the strike range of the Navy’s 2020 CVW. Moreover, the Chinese reconnaissance-strike complex will apparently be based around an entirely new *shashoujian* attack system—the anti-ship *ballistic* missile (ASBM)—that may result in a maritime battle network that is deadlier than anything the Soviets ever assembled.

³⁷⁷ *Military Power of the People’s Republic of China 2006*, p. 25.

³⁷⁸ “[People’s Liberation Army] Navy.”

³⁷⁹ Owen Cote cited a 1,000 mile exclusion zone for aviation. However, for reasons that are unclear, he applied it only to *land-based* aviation. See Cote, *The Future of Naval Aviation*, p. 22.

³⁸⁰ At this time, it is unclear whether or not the PRC intends to build anti-access/area-denial systems and capabilities more akin to Soviet automated reconnaissance-strike complexes or more dynamic US battle networks. Therefore, when referring to new PRC systems, this report uses the Soviet term “complex” interchangeably with the US term “battle network” or “network.”

A NEW ANTI-CARRIER ATTACK SYSTEM: ANTI-SHIP BALLISTIC MISSILES

The idea of anti-ship ballistic missiles is not new. The Soviets experimented with them as far back as the 1960s. However, the contemporary lack of *maneuverable* reentry vehicles (MaRVs) equipped with reliable terminal seekers forced the Soviets to arm the missiles with 550-kiloton to one-megaton nuclear warheads, which limited their tactical use. As a result, they elected to forego building the system, opting instead for new long-range anti-ship cruise missiles.³⁸¹ Today, after more than four decades of technological advancements—and with a burgeoning economy—the Chinese have the benefit of pursuing both weapons. Indeed, they clearly intend to make the tactical anti-ship ballistic missile the centerpiece of their own 21st century maritime reconnaissance-strike network.

The emphasis that the PRC military places on tactical ballistic missiles in general, and on anti-ship ballistic missiles in particular, is captured in a remarkable article written by a Chinese analyst named Wang Wei, entitled “The Effect of Tactical Ballistic Missiles on the Maritime Strategy System of China.” The theme of the article is made clear in its summary, that “[T]he statement of the value of tactical missiles should be: it causes China’s military and political area of operational space with respect to the eastern maritime flank to become even more extensive at the present phase.”³⁸²

According to Wang Wei, all battlefield activities can be summed up as the “enemy’s and our capabilities—particularly with respect to firepower—and the use of information and counteraction.” From this perspective, the evolution of warfare can be seen in terms of a confrontation between “offensive and defensive weapons and systems in the process of firepower delivery,” and in terms of relative changes in the “cost-benefit ratio of firepower delivery.” In cases where the firepower of defensive weapons dominate, the cost-benefit ratio for firepower delivery is quite low, which spurs the development of new offensive weapons better able to penetrate an adversary’s defenses. When offensive

³⁸¹ Norman Polmar, “U.S. Navy: Antiship Ballistic Missiles ... Again,” *Proceedings*, U.S. Naval Institute, July 2005, pp. 86–87.

³⁸² Wang Wei, “The Effect of Tactical Ballistic Missiles on the Maritime Strategy System of China.”

weapons dominate, the cost-benefit ratio for firepower delivery is quite high, which spurs the development of defensive weapons better able to oppose and defeat an enemy's strike systems.³⁸³

Within this conceptual framework, and consistent with post-Desert Storm Chinese writings, Wang Wei believes the American RMA is based primarily on the exploitation of the "revolutionary" effects of airpower. Airpower provides US commanders with "a relatively easier method for penetrating the physical domain of the enemy's defensive system," thus creating a decisive relative American advantage in the cost-benefit ratio of firepower delivery. However, he was careful to note "that since after the Korean War, the majority of wars that great powers such as the United States [have been] involved in have been medium or low-intensity in nature and so the use of [US aviation systems] *has occurred in, generally speaking, a hospitable environment*" (emphasis added).³⁸⁴ The bases from which the US air systems operated were generally immune from attack, and American air forces were generally able to operate at will over the battlefield. Thus, the cost-benefit ratio for firepower delivery was weighted heavily in favor of US offensive air systems in America's limited wars.³⁸⁵

When considering how best to take on an adversary with aerospace capabilities like the United States, Wang Wei extolled the value of cruise and ballistic missiles, which, by virtue of their superior ability to penetrate an enemy's defensive space, have a far higher cost-benefit ratio for firepower delivery than aircraft. However, of the two types of missiles, Wang Wei believes tactical ballistic missiles (TBMs) are the far better bet. As he wrote:

By means of ballistic missiles, the party in the inferior position with respect to combat aircraft can still deliver firepower against the party in the dominant position. From the economic point of view, when compared to the complex and long periods required for the development of air force combat systems, the consumption of resources should be much smaller to use ballistic

³⁸³ Ibid.

³⁸⁴ Ibid.

³⁸⁵ This formulation is only partially true. US freedom of action in the skies over Vietnam was challenged throughout the Vietnam War. It is true, however, that the US has generally been able to achieve air superiority, especially since the end of the Cold War.

missiles to form realizable deterrent effects; and it is also a “short-term investment” that can produce instant results.³⁸⁶

Wang Wei’s article goes a long way toward explaining why TBMs are now “one of the principal means of China’s long-range firepower delivery.” With their strong ability to penetrate an enemy’s aerospace defenses, they are ideal *offensive* weapons that offer the PRC leadership the option of “fighting without entering”—that is, exerting military pressure on Taiwanese or regional leaders without resorting to the all-out use of force.³⁸⁷ This explains why, by 2006, the PLA had already deployed approximately 900 mobile short-range ballistic missiles within range of Taiwan, and was increasing this already-impressive inventory at a rate of 100 missiles per year. At the same time, the PLA was building up its intermediate-range ballistic missiles forces capable of threatening Japan, South Korea, the Philippines, and all the other nations in the East Asia Littoral.³⁸⁸

Similarly, Wang Wei also noted that TBMs are equally powerful *defensive* weapons which “serve as an ‘existential threat’ to counter [an] adversary’s deployments at sea,” especially with regard to carrier forces. Indeed, according to Wang Wei:

With regard to naval combat systems, if the TBM maritime strike system is created, then the Chinese military in any future potential conflict at sea will have a relatively asymmetrical means of firepower delivery. Developments in anti-missile technology have reached a point so that ballistic missiles are no longer absolutely impossible to resist, but the asymmetry of actual effectiveness of the two kinds of systems at the same time determines that the ballistic missile in the confrontation of offense and defensive systems retains the dominant position.³⁸⁹

³⁸⁶ Wang Wei, “The Effect of Tactical Ballistic Missiles on the Maritime Strategy System of China.”

³⁸⁷ Ibid.

³⁸⁸ *Military Power of the People’s Republic of China 2006*, p. 3.

³⁸⁹ Wang Wei, “The Effect of Tactical Ballistic Missiles on the Maritime Strategy System of China.”

Reflecting the intense focus of PRC military attention on Taiwan, Wang Wei wrote that because anti-carrier ballistic missiles cannot *deliver forces*, they cannot be used to “achieve absolute sea control.” However, he emphasized their potentially powerful deterrent effect on the United States, explaining that the existence of such an asymmetrical means of attack on US naval forces might set up, from a psychological point of view, an “‘upper limit’ for the scale of the potential conflict” and enable both the Chinese and Americans to “return to rationality,” which will give China “increased space for maneuver in coping with maritime disputes.” In a wry historical analogy, he wrote, “This [phenomenon] is similar to the effect of crossbows for knights of the aristocracy in medieval Europe. In a similar pattern as the ‘law Forbidding Crossbows,’ modern Western developed countries impose tight restrictions on tactical missiles and related technologies.” He implied that these restrictions should in no way deter the PRC military from pursuing these weapons, saying they represent an “ingenious military move...to annihilate [enemy forces] at sea.”³⁹⁰

The Business End of a TBM Maritime Strike System

Wang Wei’s writings help put into context the central role that a “TBM maritime strike system” promises to play in future Chinese anti-access/area-denial strategies. As reported in a 2004 Office of Naval Intelligence report, the business end of such a system (at least initially) appears to be the DF-21C medium-range ballistic missile, a modified version of one of the new generation of road-mobile, solid-fuel Chinese missiles designed for rapid launches.³⁹¹ These characteristics allow for “shoot-and-scoot” operations which improve the system’s survivability in the face of US aerospace attack forces. With a nominal combat range that exceeds 1,100 nm, and very high-speed MaRVs equipped with both active and passive radar seekers, an operational DF-21C would be a formidable anti-carrier system.³⁹²

³⁹⁰ Ibid.

³⁹¹ See Robert Hewson, “Dragon’s Teeth—Chinese Missiles Raise Their Game,” *Jane’s Navy International*, February 2007, p. 21. See also Ted Parsons, “China Develops Anti-Ship Missile,” *Jane’s Defense Weekly*, January 18, 2006.

³⁹² Richard Fisher, Jr., “Growing Asymmetries in the China-Japan Naval Balance,” International Assessment and Strategy Center, November 22, 2005, accessed online at http://www.strategycenter.net/research/pubID.83/pub_detail.asp on August 15, 2007.

It is important to note that US intelligence analysts and fleet operators no longer debate *if* a workable anti-ship ballistic missile can be developed; they debate only the question of *when* an operational missile will be fielded. In this regard, just as was the case during China's quest for a workable ASAT, many believe that an ASBM will be some time in coming. However, it would not be surprising if the Chinese demonstrated a working system much sooner than expected. After all, the idea and technology for a maneuverable, terminally-guided reentry vehicle is well over two decades old. In 1983, reacting to a precipitous buildup of Soviet SS-20 intermediate-range ballistic missiles (IRBMs) in Eastern Europe, the US Army deployed the Pershing II IRBM as well as a ground-launched version of the Navy's TLAM to bases in the United Kingdom and Germany.³⁹³ Like the DF-21C, the Pershing II was a solid-fueled, mobile missile. Although the Pershing II had a range of only 970 nm, it could reach Moscow from bases in Germany. The missile was equipped with a maneuvering, guided reentry vehicle with a "radar area correlator" (RAC). As the Pershing II's RV maneuvered in the atmosphere, the RAC gathered radar images of the target area, compared and correlated the images to internally-stored digital radar images, and then guided the warhead onto the resolved target.³⁹⁴ In other words, the Pershing II demonstrated maneuverable, guided reentry vehicles using 1970s technologies—technologies that have long been available to PLA missile designers. Indeed, Chinese engineers claimed that they equipped the DF-21 with a terminal radar seeker as early as 2002.³⁹⁵

Radar seekers like those on the Pershing II allow a missile to hit only fixed, immobile targets. To hit a target like a moving ship, the Chinese will need to develop MaRVs equipped with more advanced seekers.³⁹⁶ However, while hitting a moving target is a more difficult task than hitting a stationary one, it is a far easier one today than it was in the 1970s and 1980s. For example, during recent anti-ballistic missile tests, the US Missile Defense Agency (MDA) successfully demonstrated "hit-to-kill" intercepts of ballistic missiles moving rapidly through the exoatmosphere. It is now possible for US anti-missile weapons to "hit a bullet with a bullet"—to intercept a relatively small warhead moving through space at extremely high speeds. It follows, then, that hitting

³⁹³ The Tomahawk land-attack missile (TLAM) cruise missile variant was called the Ground-Launched Cruise Missile, or GLCM.

³⁹⁴ William R. Mentzer, Jr., "Test and Evaluation of Land-Mobile Missile Systems," *Johns Hopkins APL Technical Digest*, Vol. 19, No. 4 (1998), p. 428.

³⁹⁵ Hewson, "Dragon's Teeth—Chinese Missiles Raise Their Game," p. 21.

³⁹⁶ *Ibid.*

a 4.5-square acre target moving at only 30 knots would not seem to be a great technical challenge.³⁹⁷ An updated synthetic-aperture radar seeker should be easily able to detect wake signatures and returns from ships traversing the ocean, even through clouds. The Doppler shift in the radar returns from the ships should allow for reliable discrimination of decoys, and the radar clutter associated with ocean wave action that diminished the accuracy of older-generation radars can now be filtered out by using upgraded, more powerful digital processing. Moreover, although the current version of the DF-21C cannot quite range out to the second island chain, it seems certain that future versions of the missiles will be able to range the entire 1,600 nm objective engagement envelope. The Pershing II is instructive in this regard. While approximately the same size as the older Pershing I missile, the Pershing II had greater than two times the effective range due to improvements in fuel and other range-enhancing technologies.³⁹⁸ One could predict that future versions of the DF-21C might see similar range improvements. Of course, missile engagement ranges could also be increased with newer and larger missiles.

All in all, then, the problem of hitting a maneuvering ship at sea with a MaRV is likely to be much easier than hitting a radically maneuvering RV with a defensive interceptor. For this reason, the deployment of an operational Chinese ASBM may come sooner than many think. Indeed, some experts believe that the Chinese have already completed operational tests of the DF-21C ASBM. Other reports suggest the Chinese are now developing a special submunition warhead for the missile with clusters of non-explosive flechette penetrators designed to damage a carrier by kinetic impact, and a high-power microwave warhead designed to disable naval radars with electromagnetic pulses. By disabling a carrier without killing too many of its personnel, the Chinese may hope to convince the United States that the costs for an intervention in support of Taiwan are not worth it, thereby avoiding an all-out military confrontation with the United States.³⁹⁹

Of course, even if the Chinese have already developed an ASBM with maneuverable reentry vehicles capable of homing on a carrier, the missile and its payload would only comprise part of a more comprehensive TBM maritime strike system. As many experts have

³⁹⁷ For a description of US missile defense tests, see the Missile Defense Agency's MDALink, accessed online at <http://www.mda.mil/mdalink/html/mdalink.html>.

³⁹⁸ Mentzer, "Test and Evaluation of Land-Mobile Missile Systems," p. 428.

³⁹⁹ Hewson, "Dragon's Teeth—Chinese Missiles Raise Their Game," p. 22.

noted, a working TBM anti-carrier system will require a sophisticated targeting system to put the RV in a position to acquire and home in on its target.⁴⁰⁰ Just as it was for the Soviets, building the ISR component for their extended-range ocean reconnaissance-strike complex will be the most difficult and challenging task facing Chinese planners.

BUILDING THE ISR BACKBONE FOR A MARITIME RECONNAISSANCE- STRIKE COMPLEX

The Chinese are well aware that the ISR backbone is the “long pole in the tent” for a workable TBM maritime strike network. As Wang Wei noted,

...the key to ballistic missile strikes against targets at sea lies in the preparation of the maritime battle space. [This will require] the timely precision reconnaissance of the target’s orientation, as well as the problem of transferring the data. This is the prerequisite condition for attack against a moving target.

Preparation of the sea battlefield will require: maritime surveillance satellites, electronic reconnaissance satellites, imaging reconnaissance satellites, communications satellites and other space-based systems; airborne early warning aircraft, unmanned reconnaissance aircraft and such, airbase systems, shore-based-over-the-horizon radars, underwater sonar arrays and the like. It is worth noting that these systems must be viewed as a “public investment”—part of a comprehensive naval combat operations system.⁴⁰¹

As this passage makes plain, the Chinese intend to reproduce to a great degree the Soviet Cold War space-based ISR/targeting network. PRC engineers are reportedly working on as many as 15 different types

⁴⁰⁰ See, for example, comments in Cote, *The Future of Naval Aviation*, pp. 10–11.

⁴⁰¹ Wang Wei, “The Effect of Tactical Ballistic Missiles on the Maritime Strategy System of China.”

of satellites for imagery reconnaissance, electronic and signal intelligence collection, navigation, communications, and weather forecasting.⁴⁰² However, these space systems promise to be far more effective than earlier Soviet designs. For example, the planned US Space-Based Radar (SBR) will use a SAR with a surface moving target indication mode that can track a moving target with a ten-square meter RCS at just over 1,500 nm.⁴⁰³ The underlying technology is well known and within reach of Chinese designers. Indeed, their KJ-1 radar satellite is expected to have a one-meter resolution, more than enough to identify carriers, and Chinese space operators have drawn up plans to fly paired radar satellites to provide even better targeting data.⁴⁰⁴ In addition, Soviet photoreconnaissance satellites relied on film return methods that delayed the delivery of their take, making them unsuitable as a ship targeting sensor. In contrast, the Chinese are sure to use high-resolution digital-imaging satellites, like those readily available on the commercial space-imaging market, to transfer their collected images over data links in near real-time to multi-source ocean surveillance centers.⁴⁰⁵ These new systems might allow PRC photosatellites to track ships by their telltale wakes.

While developing a military-grade space-based targeting system is difficult and expensive, it is by no means impossible. Indeed, the unclassified version of the 2006 report on PRC military power to Congress stated, “*In the next decade, Beijing most likely will field radar, ocean surveillance, and high resolution photoreconnaissance satellites*” (emphasis added).⁴⁰⁶ Ted Parsons of *Jane’s Defense Weekly* puts the “in-service” date of PRC space-based ISR systems much closer. He reported that Asian military sources estimate that PLA space forces may be able to deploy the space targeting systems needed to make a maritime reconnaissance-strike system operational by 2009.⁴⁰⁷

⁴⁰² Timothy Hu, “China — Marching Forward,” *Jane’s Defense Weekly*, April 25, 2007.

⁴⁰³ See “Space Based Radar (SBR) Configuration,” accessed online at <http://www.globalsecurity.org/space/systems/sbr-config.htm> on August 20, 2007.

⁴⁰⁴ Hewson, “Dragon’s Teeth—Chinese Missiles Raise Their Game,” p. 22.

⁴⁰⁵ See “IMINT,” accessed online at <http://en.wikipedia.org/wiki/IMINT> on August 20, 2007.

⁴⁰⁶ *Military Power of the People’s Republic of China 2006*, pp. 4, 33.

⁴⁰⁷ Parsons, “China Develops Anti-Ship Missile,” p. A1. Other sources expect the first Chinese radar and electro-optical reconnaissance satellites to be orbited by the end of 2008, with an ultimate constellation consisting of four radar and four Earth Observation (EO) satellites. See Hewson, “Dragon’s Teeth—Chinese Missiles Raise Their Game,” p. 22.

In addition to satellite-based carrier detection systems, the PRC is also developing new terrestrial long-wave radar systems with much greater ranges than the land-based surveillance radars available to the Soviets. Indeed, the Chinese seem to be stealing a page from the US Cold War playbook. In the 1980s, the US Navy and US Air Force both built and operated several land-based, over-the-horizon backscatter (OTH-B) high-frequency (HF) radars. The Navy used them to warn carrier strike groups about incoming Soviet Backfire attacks, and the Air Force used them to detect Soviet bombers coming over the North Pole. OTH-B HF radars use a frequency in the low HF-band to bounce radar signals off the ionosphere. The “backscatter” returns can be analyzed by computers to detect aircraft and ship movements thousands of nautical miles away from the radar. Using ancient vacuum tube technology and signal processing not nearly as good as today’s, the US Air Force OTH-B system demonstrated bomber-size aircraft detection ranges of over 1,700 nm.⁴⁰⁸

China began developing an indigenous OTH-B radar system in the late 1960s.⁴⁰⁹ Modern technology and data processing capabilities may allow its contemporary system to provide targeting-quality information to Chinese ASBM units and other carrier strike systems. As a technical benchmark, Australia’s Jindalee Skywave OTH-B radar system uses very large antenna arrays and powerful digital signal processors to analyze returning backscatter signals. Under ideal conditions, the radar can discriminate carrier-like targets moving at moderate speeds out to 1,600 nm or more. Moreover, the Jindalee is much less vulnerable to radar jamming than earlier OTH-B radars.⁴¹⁰ In other words, the combination of space-based sensors and OTH-B HF radars will likely give PLAN targeteers a reliable means to track and target aircraft carriers out to at least the second island chain.

⁴⁰⁸ D. H. Sinnot, *The Development of Over-the-Horizon Radar in Australia* (Australia: Defense Science and Technology Organization, 1988), p. 3, accessed online at http://www.dsto.defence.gov.au/attachments/The_development_of_over-the-horizon_radar.pdf. For general OTH-B radar technical information, see “Over-the-Horizon Radar,” accessed online at http://en.wikipedia.org/wiki/Over-the-horizon_radar. Both websites were accessed on March 27, 2007.

⁴⁰⁹ Mark A. Stokes, *China’s Strategic Modernization: Implications for the United States* (Carlisle, PA: US Army Strategic Studies Institute, September 1999), p. 41.

⁴¹⁰ Jindalee’s antenna extends to almost three kilometers in length. See Sinnot, *The Development of Over-the-Horizon Radar in Australia*, p. 32; and Stokes, *China’s Strategic Modernization: Implications for the United States*, p. 41.

Given the obvious way that it follows the Soviet approach to anti-carrier operations, the PLAN also seems sure to use both maritime patrol aircraft and submarines to “shadow” US carrier strike groups and task forces in international waters. The PLAN Air Force (PLANAF) already operates a number of Shaanxi Y-8100 transports equipped with radar and other ocean surveillance systems. Moreover, in August 2006, the Russians reported that the Chinese would soon buy up to 15 Be-200 turboprop-powered amphibian aircraft with a patrol radius of 650 nm.⁴¹¹ Submarines will augment the airborne shadowing of US naval forces, as demonstrated in November 2006 by the highly publicized surfacing of a PLAN Song-class submarine within five miles of the USS *Kitty Hawk* (CV-63). Tellingly, the incident occurred at the very time the US Pacific Fleet commander was due to meet with Chinese defense leaders on an official visit.⁴¹² Given the Song’s relatively short underwater endurance when operating at sea, it seems likely that the *Kitty Hawk* stumbled across the Song’s patrol area. However, as PRC submarine numbers go up, so too will the number of submarines that can be assigned to barrier patrol areas. Aircraft and submarines in likely US carrier operating areas may allow the PRC to gain an advantage in any future “battle of the first salvo,” especially against strike groups already forward-deployed in the Western Pacific.

SHARPENING THE CLAWS OF THE PRC SUBMARINE FLEET

PLAN submarines promise to be one of the primary components of the inner defensive layers of the PRC ocean battle network. Indeed, some analysts think that submarines are the PLAN’s *primary* anti-carrier system. Bernard Cole, a retired US Navy captain who now teaches at the National War College in Washington, DC, believes that the Chinese have “decided that submarines *are the best way* to delay a US entry into any conflict over Taiwan by threatening US aircraft carriers” (emphasis added), because “There’s nothing harder than finding submarines. It’s a very tough business.”⁴¹³ Chinese strategy documents support this

⁴¹¹ The Be-200s would also be used to supply Chinese island garrisons. See Fairclough, “Surface Tensions: As China Grows, So Does Its Long-Neglected Navy.”

⁴¹² Bill Gertz, “China Sub Stalked US Fleet,” *The Washington Times*, November 13, 2006, p. A1.

⁴¹³ Fairclough, “Surface Tensions: As China Grows, So Does Its Long-Neglected Navy.”

view, stating that “Stealth warships and new-style submarines represent the modern sea battle platforms.”⁴¹⁴ However, the preponderance of PLAN submarines are diesel-electric boats that have relatively poor underwater endurance when operating at high speeds, and maximum speeds that are far less than that of a carrier task force. As it stands now, then, the PLAN submarine fleet thus appears to be best suited for barrier operations that aim to ambush US Carrier Strike Groups advancing on the Chinese mainland. As PRC submarines improve in quality and their crews grow better trained, these types of operations will be trouble enough for any carrier task force commander.

As recently as the 1990s, the Chinese submarine fleet consisted of large numbers of obsolete Soviet Romeo-class diesel-electric attack submarines (SSs), as well as an indigenous copy known as the Ming-class. Both of these submarines were slow (15-18 knots, submerged), noisy, and armed with torpedoes that required the submarine to maneuver within five to ten miles of its target. However, in the early 1990s, the PLAN began an ambitious submarine modernization effort that included both indigenous and foreign designs. In 1994, the PLAN launched the first Song-class submarine, a much-improved, indigenously-designed and built submarine that was far superior to the Ming and Romeo classes. At the same time, the PLAN bought two Russian Kilo-class submarines, which were among the quietest, most effective diesel-electric boats in the world. The Chinese were evidently pleased with the Kilo, and quickly ordered two more improved versions in 1996. Moreover, apparently informed by the Kilo’s design features, PLAN engineers improved the second and subsequent Songs, which began arriving in the fleet in 2001.⁴¹⁵ The next year, the Chinese bought eight more improved Kilo-class submarines, packed with the most modern electronics and weapons the Russians offered.⁴¹⁶

The Kilos brought with them advanced wake-homing and wire-guided torpedoes of Russian design.⁴¹⁷ These guided weapons, optimized for use against surface ships, were vastly superior to and more deadly than the short-range, straight-running torpedoes that had been used

⁴¹⁴ Erickson and Goldstein, “China’s Future Nuclear Submarine Force,” p. 59.

⁴¹⁵ Commodore Stephen Saunders, RN, ed., *Jane’s Fighting Ships 2007–2008*, 110th edition (Surrey, England: Jane’s Information Group, Ltd., 2007), p. 118.

⁴¹⁶ See “Submarines,” accessed online at <http://www.sinodefence.com/navy/sub/default.asp> on August 15, 2007.

⁴¹⁷ Bill Gertz, “The Chinese Buildup Rolls On,” *Air Force Magazine Online*, September 1997, accessed online at <http://www.afa.org/magazine/Sept1997/0997china.asp> on January 22, 2008.

on the earlier Romeo and Ming classes. The Kilo's 53-65KE wake-homer is especially lethal. Developed by the Soviets during the Cold War as an anti-carrier weapon, the torpedo travels 20 meters beneath the ocean's surface, its upward-looking sensors searching for the tell-tale, v-shaped wakes created by every surface ship. Once detecting the turbulence, it turns into the wake and then begins to sweep from side to side, looking for its edges. The torpedo snakes from side to side within the diminishingly wide cone of the wake until it passes below the ship's stern and detonates.⁴¹⁸ The version the PLAN acquired had a range of approximately 25 miles. However, larger Russian versions of the wake-homer have maximum engagement ranges of up to 60 miles.

The beauty of this type of torpedo is that it is very easy to operate and employ. Its arrival therefore gave the PLAN submarine fleet a highly effective surface ship attack capability even without an extensive torpedo attack or exercise training program. Moreover, a wake-homer is extremely difficult to counter, particularly when fired in salvos. In 2004, the US Office of Naval Intelligence concluded that wake-homing torpedoes would represent the most deadly torpedo threat to US forces for at least two decades. It also projected that adversaries like the PLAN would likely integrate both acoustic- and wake-homing guidance systems to make the torpedoes even more capable and deadly.⁴¹⁹ It therefore seems likely that the PLAN has adopted wake-homing torpedoes for all of its submarines.

In addition to new wake-homing and wire-guided torpedoes, the Kilos and improved Songs are SSGs—diesel-electric boats capable of firing ASCMs while submerged. The Songs are armed with both the Chinese YJ-81Q, a copy of the French encapsulated Exocet missile with a range of 20 nm, and the YJ-82Q, an indigenously-designed ASCM with a maximum effective range of 65 nm. Both are subsonic missiles armed with 165-kilogram warheads.⁴²⁰ The eight newer Kilo SSGs carry

⁴¹⁸ Richard R. Burgess, "The Navy Searches for a Way to Detect Antiship Torpedoes Well Before Impact," *Advance Acoustic Concepts*, September 6, 2006, accessed online at <http://www.aactech.com/article.jsp?id=36> on January 22, 2008.

⁴¹⁹ Burgess, "The Navy Searches for a Way to Detect Antiship Torpedoes Well Before Impact;" and *Worldwide Maritime Challenges 2004* (Washington, DC: Office of Naval Intelligence, 2004), p. 16. Torpedo ranges were taken from Eric Wertheim, *Naval Institute Guide to Combat Fleets of the World 2005–2006: Their Ships, Aircraft, and Systems*.

⁴²⁰ Fisher, "Growing Asymmetries in the China-Japan Naval Balance."

the much more capable Russian Klub ASCM, also known as the SS-N-27B Sizzler.⁴²¹ The Sizzler is a two-stage missile with a range of approximately 120 nm. It flies at subsonic speeds at “sea skimming” altitudes (between five and ten meters above the ocean’s surface) along complex routes delineated by up to 15 navigational waypoints. Once the missile gets to within about ten nm of its designated attack position, the missile pops up, acquires its target using onboard radars, drops its cruise missile body, and fires a terminal supersonic (Mach 2+) “combat stage” powered by a solid-fuel rocket. This attack profile is designed specifically to defeat the US Aegis anti-air warfare system and to penetrate a task force’s defenses to strike American aircraft carriers.⁴²²

In 2004, the Chinese surprised the US intelligence community with the unexpected introduction of the new Yuan-class SSG, which had been built in a covered building hall hidden from the prying eyes of US intelligence satellites. This new submarine blends the Kilo’s distinctive teardrop-shaped hull and prominent raised hump with the Song’s diving and tail surfaces. It can fire both the YJ-81Q and YJ-82Q ASCMs, and possibly the SS-N-27B Sizzler. It also may be the first Chinese diesel-electric submarine equipped with an auxiliary air-independent propulsion (AIP) plant that would enable the submarine to operate quietly in a patrol area for weeks at slow speeds without the need to “snorkel” to recharge its batteries—a noisy operation that leaves the submarine highly vulnerable to location identification and attack.⁴²³ ASCM-armed AIP boats are ideally suited for anti-carrier barrier patrols.

While PLAN planners clearly recognize that nuclear-powered boats are the superior warfighting platforms, the majority of PRC submarines are quiet, diesel-electric boats like the Kilo, Song, and Yuan

⁴²¹ *Military Power of the People’s Republic of China 2006*, pp. 4–5. The first four Kilos will likely be retrofitted to fire the Sizzler. See Saunders, ed., *Jane’s Fighting Ships 2007–2008*, 110th edition, p. 120.

⁴²² Stephan Nitschke, “Air-, Surface-, and Subsurface-Launched Naval Cruise Missiles,” *Naval Forces*, No. VI/2006, Vol. XXVII, pp. 32–41. See also “Russia to Deliver SS-N-27 to China,” *Chinese Defense Today*, April 29, 2005, accessed online at <http://www.sinodefence.com/news/2005/news29-04-05.asp> on May 25, 2005; Robert Hewson, “Novator Wields its Klub,” *Jane’s Defense Weekly*, September 5, 2007, p. 18; and Tony Capaccio, “Navy Lacks Plan to Defend Against ‘Sizzler’ Missile,” *Bloomberg.com*, March 23, 2007, accessed online at http://www.bloomberg.com/apps/news?pid=20601087&sid=akO7Y_ORw538&refer=home on March 29, 2007.

⁴²³ See “Type 041 submarine,” accessed online at http://en.wikipedia.org/wiki/Yuan_class_submarine on August 22, 2007. See also Fisher, “Growing Asymmetries in the China-Japan Naval Balance.”

that are best suited for lie-in-wait ambushes. As one PLAN officer said, “The price of one nuclear submarine can buy several, even more than ten conventional submarines.... As a developing country, our nation’s military budget is still quite low, and thus the size of the navy’s nuclear submarine fleet can only be maintained at a basic scale.”⁴²⁴ Accordingly, the PLAN’s nuclear submarine fleet is relatively small. It is in the process of replacing its five original first-generation Han-class submarines (four of which remain operational⁴²⁵) with perhaps as many as six to eight new Type 093 Shang-class nuclear-powered attack submarines (SSNs), developed with technical assistance from Russia’s Rubin Central Design Bureau for Maritime Engineering. The Shang is reportedly as quiet as the Victor III SSN, which caused much consternation in the US submarine community when it first appeared in the late 1970s. Other reports suggest that it is as quiet as US first-generation Los Angeles-class SSNs.⁴²⁶

With an estimated submerged displacement of around 8,000 tons, the Shang is a large SSN that more resembles the American Los Angeles- or British Astute-class SSNs than the Russian Victor. Its estimated underwater speed of 30-35 knots would allow it to keep pace with a US Carrier Strike Group.⁴²⁷ Armed with long-range wake-homing torpedoes and encapsulated ASCMs that can be fired while submerged, this new submarine could be used inside the second island chain for more proactive carrier hunter-killer operations, or for running down and sinking the underway replenishment groups vital to keeping US carriers in action.⁴²⁸ This latter mission would exploit what PLAN strategists believe to be one of the carrier’s greatest vulnerabilities—its daily consumption of “an immense amount” of supplies.⁴²⁹ These submarines also have the range and endurance to conduct patrols well beyond the second island chain.

⁴²⁴ Anonymous PLAN officer, cited in Erickson and Goldstein, “China’s Future Nuclear Submarine Force,” p. 63.

⁴²⁵ Saunders, ed., *Jane’s Fighting Ships 2007–2008*, 110th edition, pp. 116–117.

⁴²⁶ Erickson and Goldstein, “China’s Future Nuclear Submarine Force,” p. 67.

⁴²⁷ See “Type 093 submarine,” accessed online at http://en.wikipedia.org/wiki/Type_093_submarine on August 22, 2007.

⁴²⁸ Erickson and Goldstein, “China’s Future Nuclear Submarine Force,” pp. 64–65.

⁴²⁹ Cliff, et al., *Entering the Dragon’s Lair: Chinese Anti-access Strategies and Their Implications for the United States*, p. 73.

The overall importance that PRC and PLAN strategists put on the PLAN submarine fleet is reflected in their enormous submarine modernization effort. Between 1995 and 2005, the PLAN commissioned no less than 31 new submarines. Between 2002 and 2004 alone, it launched 13 submarines while taking delivery of the eight additional Russian Kilos.⁴³⁰ However, future submarine deliveries will likely be less brisk, divided between Yuan SSGs and Shang SSNs, as well as a new strategic ballistic missile submarine.⁴³¹ The PLAN may also buy additional Kilo SSGs, or perhaps even the newer Russian Lada-class SSG, which the Russians claim to be among the quietest submarines in the world.⁴³² Regardless, one thing is certain: by 2020, if not far sooner, all of the old Romeos and Mings will be retired from the PLAN attack submarine fleet, replaced by a qualitatively superior fleet of 45–50 Song, Yuan, and Kilo SSGs and six to ten Shang SSNs, all capable of firing ASCMs and long-range, wake-homing torpedoes while submerged.⁴³³ Over the longer term, if the Shang SSN proves to be a successful design—and if the Taiwan situation is successfully resolved—the submarine fleet may shift its relative emphasis from diesel-electric to nuclear-powered boats, and begin to emphasize “out of area” operations beyond the second island chain.⁴³⁴

Some might counter that such a 2020 force, while certainly superior to the 1990s PRC submarine fleet, will be no match for the qualitatively superior US submarine fleet, which in 2020 will be composed entirely of Seawolf-, Virginia-, and late-generation Los Angeles-class SSNs. However, other knowledgeable analysts aren’t so sure. For example, Rear Admiral Eric McVadon, a former top-ranking Navy intelligence officer, wrote:

⁴³⁰ Erickson and Goldstein, “China’s Future Nuclear Submarine Force,” p. 55.

⁴³¹ The Chinese have evidently halted production of the Song SSG to give priority to the newer and presumably more capable Yuans. Some reports indicate the class will number 12 boats, others 13. See Jacobs, “PLA-Navy Update: The People’s Liberation Army-Navy Military-Technical Developments;” and Saunders, ed., *Jane’s Fighting Ships 2007–2008*, 110th edition, p. 118.

⁴³² Fisher, “Growing Asymmetries in the China-Japan Naval Balance.”

⁴³³ The overall force level of Chinese submarines is highly speculative at this point. Keith Jacobs believes that the final fleet tally will be 12 Kilos, 12 Songs, 20 Yuans, and 6–8 Shang. This corresponds roughly to the projection found in *Jane’s Fighting Ships*, which expects an overall force level of 40–50 boats of all types. See Jacobs, “PLA-Navy Update: The People’s Liberation Army-Navy Military-Technical Developments;” and Saunders, ed., *Jane’s Fighting Ships 2007–2008*, 110th edition, p. 31.

⁴³⁴ Erickson and Goldstein, “China’s Future Nuclear Submarine Force,” p. 55.

With more than 50 operational submarines, and with a substantial number of them new and quiet, China can put to sea more submarines than the U.S. Navy can locate and counter. Its older Ming and Romeo submarines are lethal if ignored, and could also disperse and dilute the efforts of U.S. anti-submarine warfare forces. Some of the large, diverse and rapidly growing fleet of capable Shang SSNs, and Kilo, Song, and Yuan SSs can remain undetected as they seek to interdict U.S. carrier strike groups. If the shooting has started, U.S. anti-submarine warfare forces could eventually take a toll against the Chinese submarine force, but the delay in sanitizing the area before entry of carrier strike groups is what the Chinese are counting on as an adequate delay to present the world with the aforementioned Taiwan fait accompli.⁴³⁵

In other words, US carrier task forces that successfully survive ASBM attacks in the outer layer of the PRC's maritime reconnaissance-strike network and penetrate into the northern Philippines Sea and waters to the east of Taiwan will most likely be hit with coordinated, massed strikes of anti-ship cruise missiles launched from PLAN submarines, as well as salvos of wake-homing torpedoes. Evidence of this was seen during "Peace Mission 2005," a major joint defense exercise with the Russians, when the PLAN demonstrated a coordinated strike using two Song-class submarines.⁴³⁶ Admiral McVadon believes future missile strikes from the Songs would be preceded by barrages of shorter-range ASBMs and Sizzler ASCMs fired by PLAN Kilo, or perhaps Yuan, submarines:

An attack by the Kilo submarines, whether preceded by ballistic missiles or not, using the lethal SS-N-27Bs, would degrade air defenses, including carrier flight decks. This would open the way to the many subsonic, but potent and sea-skimming ASCMs carried by the large and growing fleet of modern nuclear and diesel-electric submarines.⁴³⁷

⁴³⁵ Rear Adm. Eric A. McVadon, USN (Ret.), "The Taiwan Problem," *Armed Forces Journal*, November 2005.

⁴³⁶ "[People's Liberation Army] Navy."

⁴³⁷ McVadon, "The Taiwan Problem."

Of course, to launch these attacks, the PLAN submarines would have to maneuver undetected to within firing range, which would be a difficult task against an alerted US naval task force. Nevertheless, if even a few submarines survived, the stress of salvos of wake-homing torpedoes and coordinated ripple attacks consisting of ASBMs, Sizzlers, and other sea-skimming ASCMs on US task force defenses would be severe. The Navy continues to look for a reliable defense against wake-homing torpedoes. With regard to the missile threat, the Navy has no effective terminal defenses against ballistic missiles, and the Sizzler is considered so dangerous that Deputy Secretary of Defense Gordon England sent a recent memorandum to the Navy tasking it to formulate a response plan to address the threat posed by the missile. At the same time, the civilian in charge of DoD test and evaluation programs threatened to put on hold the test plans necessary for production to begin on the Navy's next carrier (CVN-21) and several other high-priority programs unless the Sizzler threat was better addressed by the Navy.⁴³⁸ Moreover, the threat will likely over get worse over time. As reported by the General Accounting Office in 2000:

The next generation of anti-ship cruise missiles—most of which are now expected to be fielded by 2007—will be equipped with advanced target seekers and stealthy designs. These features will make them even more difficult to detect and defeat.⁴³⁹

SHARPENING THE CLAWS OF THE PRC MARITIME AVIATION STRIKE FORCES

Of course, following the former Soviet script, land-based ASBM and submarine-launched ASCM barrages will also be coordinated with barrages of cruise missiles launched from PLAN Air Force and PLA Air Force (PLAAF) aircraft. However, consistent with the idea of a reconnaissance-strike complex that extends only to the second island chain, in the mid-1990s the Chinese evidently decided against buying updated versions of the Tu-22M Backfire—at least in the short

⁴³⁸ Capaccio, "Navy Lacks Plan to Defend Against 'Sizzler' Missile."

⁴³⁹ *Defense Acquisitions: Comprehensive Strategy Needed to Improve Ship Cruise Missile Defense* (Washington, DC: United States General Accounting Office, GAO/NSIAD-00-149, July 2000), p. 6.

term—and instead opted for shorter-range air combat systems suitable for combat operations in the middle zone of their evolving reconnaissance-strike network.⁴⁴⁰

As a result, the longest-legged maritime strike aircraft in the PRC's inventory over the near term will be new-production variants of the old Soviet Tu-16 Badger bomber, designated in Chinese service as the Hongzhaji-6 (Bomber-6), or just H-6. Although the H-6 has been the primary strategic-strike aircraft in the PLAAF (H-6E/I variants) and PLANAF (H-6D) since 1959 and 1985, respectively, it has a relatively short combat radius of 970-1,070 nm. Moreover, the plane was designed to deliver gravity bombs from an internal bomb bay.⁴⁴¹ However, in the mid-1990s, the Chinese began to convert the H-6 into a dedicated cruise missile carrier. The PLAAF version, the H-6H, carries one LACM under each wing. The initial PLANAF version, designated the H-6M, is capable of carrying four missiles, two under each wing, either the YJ-81K (30-nm range) or the YJ-82K (100-nm range) ASCMs.⁴⁴² Future versions might carry an air-launched version of the SS-N-27 Sizzler, a mockup of which was displayed for the first time at the 2007 Moscow Air Show. This missile would provide the PLANAF with additional stand-off range, and—assuming the launcher moved within range of the carrier—this missile would pose a far more difficult defensive problem to US carrier forces than the YJ-81s and 82s.⁴⁴³

The definitive PLANAF version of the H-6 is the “new” H-6K naval strike aircraft. In production since 2004, the H-6K is reportedly powered by modern, high-bypass turbofans with a much lower specific fuel consumption than earlier H-6 engines. When combined with additional fuel tanks in its bomb bays, the H-6K is projected to have a combat radius of 1,600 nm. The plane also has an additional missile pylon under

⁴⁴⁰ See Richard Fisher, Jr., “China’s ‘New’ Bomber,” International Assessment and Strategy Center, February 7, 2007, accessed online at http://www.strategycenter.net/research/pubID.146/pub_detail.asp on March 20, 2007. Another analyst believes that the only reason the Chinese did not buy the Backfire in the 1990s was because of Russian resistance to the sale. See Kopp, “Backfires for China?” pp. 40–44.

⁴⁴¹ Dr. Carlo Kopp, “XAC (Xian) H-6 Badger,” *Air Power Australia*, accessed online at <http://www.ausairpower.net/APA-Badger.html> on March 20, 2007.

⁴⁴² The designation “K” is for air-launched missiles, which delineates them from the submarine-launched versions, which are designated by the letter “Q.” Fisher, “China’s ‘New’ Bomber.”

⁴⁴³ Douglas Barrie and Alexey Komarov, “Family Affair,” *Aviation Week & Space Technology*, September 10, 2007, p. 69.

each wing, allowing the aircraft to carry up to six ASCMs.⁴⁴⁴ In addition to YJ-81K and 82Ks, the aircraft reportedly can carry the Russian Kh-31A Mod 2 anti-ship cruise missile, a fast (Mach 2+), ramjet-powered, sea-skimming active radar missile with an attack range just over 50 nm, modeled after the SS-N-22 Sunburn ASCM. The two newest versions of the missile have much longer engagement ranges. The Kh-31AD ASCM has an effective range of nearly 110 nm. The Kh-31PM/PMK missile is a 100-nm range anti-radiation missile with a multi-band passive seeker designed specifically to attack US radar systems like the US Navy's SPY-1 radar, the E-2 Hawkeye carrier AEW radar, the Air Force's AWACS, and the Army's Patriot fire control radar. The aircraft may also carry the new radar-guided Kh-59MK Kingbolt ASCM, which has a turbojet engine and data-linked radar seeker that allow for attacks over ranges from 135 to 160 nm.⁴⁴⁵ With its range and varied ASCM payloads, the H-6K thus fits perfectly into the Chinese second island chain anti-access/area-denial strategy.

Augmenting the H-6Ms and Ks in the maritime strike role will be a growing family of PLANAF land-based strike-fighters. The least capable of these aircraft will be the upgraded JH-7A, a dual-seat, twin-engine aircraft that resembles the old Russian Su-24 Fencer. In addition to a new radar and better electronics, the JH-7A is equipped with very efficient Rolls Royce Spey turbofan engines (built under license), which give it an unrefueled combat radius of just under 900 nm. It can be armed with the YJ-81K, YJ-82K, or the newer Kh-31AD ASCMs. The JH-7As will be augmented in PLANAF service by much more capable, Russian-built Su-30MKK2 strike-fighters, the most modern and deadly tactical aircraft in the PRC inventory. This dual-seat, multi-role version of the highly maneuverable Russian Su-27 Flanker air superiority fighter is a true all-weather, day/night strike platform roughly equivalent to the US F-15E Strike Eagle. For both defensive and offensive counter-air missions, the aircraft carries advanced air-to-air weapons along with a sophisticated electronic countermeasures (ECM) and sensor suite for target acquisition and weapon guidance. When flying anti-ship missions, the Su-30MKK2 can carry three different types of ASCMs: the Kh-31AD; the Kh-31PM/MPK; and the Kh-59MK. With a normal combat load, the aircraft has an impressive unrefueled combat radius of about 860 nm, which means that it outranges all of the manned aircraft in the Navy's program of record CVW. Moreover, its strike range can

⁴⁴⁴ Kopp, "XAC (Xian) H-6 Badger;" and Fisher, "China's 'New' Bomber."

⁴⁴⁵ Hewson, "Dragon's Teeth—Chinese Missiles Raise Their Game," pp. 22–23.

be extended out to 1,400 nm with one refueling, meaning the aircraft could escort H-6Ks over nearly their entire unrefueled strike range. This raises the specter of combined fighter and bomber attacks against US aircraft carriers—a threat not encountered since World War II.⁴⁴⁶

Over the near term, the PLANAF is expected to operate three or four JH-7A regiments (24 aircraft apiece) and three or four Su-30MKK2 regiments, for a total of 144–192 ASCM-capable strike-fighters. These aircraft will be supported and augmented by the growing fourth-generation component of the PLA Air Force, which now includes six or seven regiments of Russian Su-27 Flanker fighters or Chinese license-built versions of the same plane, known as the J-11; two regiments of Russian Su-30MKK fighter-bombers; and another three to four regiments of improved J-11s (known in Russia as the Su-27SKM). These improved J-11s are the Chinese equivalent of the F-14 Tomcat—a fighter-interceptor that has been modified to become a multi-role strike-fighter.⁴⁴⁷ Altogether, then, the Chinese air and naval air forces will soon operate about 500 modern, fourth-generation fighters and strike-fighters, or about ten CVW-equivalents of aircraft. With support from China's A-50 AWACS and H-6U and II-78MKK tankers, these aircraft will be able to contest US control of the air and to strike targets at ranges beyond 850 nm.⁴⁴⁸

The PLA and PLAN air forces are clearly suitable for operations in the middle bands of a 1,600-nm range maritime reconnaissance-strike network, at ranges that would allow them to conduct coordinated cruise missile strikes with PLAN submarines. However, PRC leaders may once again be considering new aviation strike systems able to reach beyond the second island chain. In June 2004, the Hong Kong media reported that the PLAAF would acquire the most modern M3 version of the Tu-22 Backfire.⁴⁴⁹ This report was confirmed by a US-China analyst in mid-2005, and given credence by the aircraft's participation in the "Peace Mission 2005," the major joint Russian-Chinese military exercise.⁴⁵⁰ While there is no substantive evidence that the Chinese are actively pursuing the Backfire at this time, the appearance of the Backfire would add another long-range defensive problem for US carrier forces. As Carlo Kopp wrote, should the Chinese move forward and buy the

⁴⁴⁶ Ibid., pp. 22–23; Fisher, "Growing Asymmetries in the China-Japan Naval Balance;" and "Su-30MKK Multirole Fighter Aircraft," accessed online at <http://www.sinodefence.com/airforce/fighter/su30.asp> on August 15, 2007.

⁴⁴⁷ Ibid.

⁴⁴⁸ Kopp, "Backfires for China?" p. 43.

⁴⁴⁹ Ibid., p. 40.

⁴⁵⁰ Fisher, "China's 'New' Bomber."

system, “The Backfire will become the most capable delivery platform in the region, combining 2,500 nautical mile class combat radius with excellent supersonic dash capability to evade interception.”⁴⁵¹

THE INNER ZONE DEFENDERS: SHORT-RANGE ASBMs, SAGs, AND COASTAL ASCMs

Short-range ASBMs, ASCM-equipped SAGs, and coastal ASCMs will defend the innermost zones of the Chinese maritime strike network. The shorter-range DF-15 and DF-15 Mod 1 missiles, with combat ranges of 325 nm and 530 nm, respectively, are the most likely candidates for a shorter-range ASBM strike system.⁴⁵² These missiles can engage carriers at the outer independent operating ranges of an F-18E/F- and F-35B-equipped air wing—that is, at ranges where CVW operations are not overly constrained by offboard aerial tanking support. While it seems safe to assume these missiles will be equipped with the same seeker technologies as found on the DF-21C, they may carry different warheads due to their lower terminal engagement velocities.

At ranges less than 325 nm, carriers would be subject to attack from the PLAN’s small but increasingly capable surface fleet, which emphasizes anti-surface cruise missile strikes. The revitalization of the fleet began soon after the 1996 Taiwan Strait incident, when the PLAN took delivery of two Russian-built Sovremenny-class guided-missile destroyers (DDGs). In addition to SAMs, each Sovremenny is armed with eight SS-N-22 Sunburn anti-ship cruise missiles. These huge (four-ton), ship-launched, ramjet-powered missiles are the fastest ASCMs in the world, traveling above Mach 3 at high altitudes and above Mach 2 at low altitudes. Sunburns reach their targets in only 25 to 30 seconds, making defensive countermeasures extremely difficult. Moreover, their relatively modest 300-kilogram warhead is more than offset by the kinetic effects of a four-ton missile hitting its target at speeds above Mach 2. While earlier versions of the Sunburn had a relatively short range (65 nm), the PLAN ordered a second pair of Sovremennys with an improved, 135 nm-range version of the missile. These four Russian-

⁴⁵¹ Dr. Carlo Kopp, “Defeating Cruise Missiles,” *Australian Aviation*, October 2004.

⁴⁵² Fisher, “Growing Asymmetries in the China-Japan Naval Balance.”

built anti-carrier warships are augmented by two additional Chinese-produced Luyang-class destroyers, each armed with 16 YJ-83 supersonic cruise missiles with effective combat ranges of 80 nm. Like the SS-N-27B Sizzler, these missiles fly to acquisition range at subsonic speeds but then attack their targets at supersonic speeds.⁴⁵³

These six surface warfare ships are all equipped with Russian-made, medium-range SAMs with effective ranges no greater than 25 nm. To provide them with better air defense protection, the PLAN recently commissioned four new destroyers. While these ships carry eight ASCMs, either the 150-nm range YJ-62 subsonic cruise missile or the shorter-range supersonic YJ-83, their primary role is fleet air defense. Two of the ships are armed with the Russian SA-N-6 Grumble, a naval version of the SA-10, while the remaining two are armed with a Chinese copy of the same missile, known as the HQ-9. These missiles are the Russian and Chinese equivalents to the US Patriot surface-to-air missile, with engagement ranges on the order of 80–125 nm. As such, they will provide future Chinese SAGs with capable area air defenses against both aircraft and missile attacks.⁴⁵⁴

Together, these ten modern surface combatants carry 96 ASCMs of various types, and could operate in two five-ship SAGs, each composed of two air defense destroyers and three anti-ship destroyers. While these groups could conceivably venture beyond the first island chain to attack US carrier task groups, they have only modest ASW defenses and would be very vulnerable to submarine attack. Moreover, the distribution of the ships among China's three fleets (North Sea, East Sea (across from Taiwan), and South Sea) suggests that the PLAN has no intention of operating the ships in concentrated SAGs. Indeed, the dispersal of these ships suggest that it might well restrict its operations inside the first island chain, where it would benefit from operating under the PRC's land-based SAM umbrella as well as land-based air cover. In these waters, the PLAN would also be operating inside the engagement envelope of the PRC's integrated coastal defense system—the innermost layer of the maritime reconnaissance-strike network—which is capable of engaging sea targets between five and 150 nm from the coast with a variety of shore-launched

⁴⁵³ Hewson, "Dragon's Teeth—Chinese Missiles Raise Their Game," pp. 22–23.

⁴⁵⁴ See "S-300PMU / SA-N-6 SA-10 GRUMBLE," assessed online at <http://www.globalsecurity.org/military/world/russia/s-300pmu.htm> on September 7, 2007.

ASCMs.⁴⁵⁵ These surface ships would likely launch “clean up” attacks against enemy ships that had been crippled by previous ballistic missile and air- and submarine-launched ASCM attacks.

A TIME TO PREPARE

In conclusion, *for the first time since the late 1980s, and for only the second time since the end of World War II, US carrier strike forces will soon face a major land-based threat that outranges them.* Regardless of whether or not the United States and China ever come to blows over Taiwan—or for any other reason—prudence demands that the US Navy once again develop the weapon systems and tactics, techniques, and procedures necessary to operate against an evolving maritime anti-access/area-denial network focused on keeping its carriers out of effective operating range. By doing so, the Navy will ensure it will be ready to confront the PRC anti-access/area-denial battle network, when and if necessary.

Any fight against the kind of battle network the Chinese are assembling would be a tough one. Unquestionably, however, the improved range, persistence, and stealth that N-UCASs offer would likely make the fight easier than it otherwise might be. The next chapter explains why.

⁴⁵⁵ Hewson, “Dragon’s Teeth—Chinese Missiles Raise Their Game,” p. 19.

XI. Winning the “Outer Network Battle”

A FORMIDABLE OPPONENT

Although the evolving PRC maritime reconnaissance-strike complex will not have the reach of the earlier Soviet battle network, it will in many ways be much more deadly:

- The PRC network’s primary outer-zone strike weapon, the ASBM, poses particular problems for US naval task forces because the fleet currently lacks reliable defenses against them. At least one expert concluded that the PRC will develop anti-ship ballistic missiles sooner than the US Navy will develop adequate defenses to counter them.⁴⁵⁶ This circumstance will likely give the Chinese the superior cost-benefit ratio for fire-power delivery that they so desperately seek.
- The PRC’s primary middle- and inner-zone strike weapons, anti-ship cruise missiles, are getting faster, stealthier, and deadlier. Steven Zaloga, a very astute analyst of Russian military technology, projected that subsonic cruise missiles with stealth technology will emerge in the next generation of Russian military technology available for export.⁴⁵⁷ For this reason, some experts believe that advances in cruise missiles will outstrip fleet defenses. David Tanks, a cruise missile

⁴⁵⁶ McVadon, “The Taiwan Problem.” However, McVadon added, “If we react quickly, maybe we will come up with other less direct ways to make [PRC] missile attacks ineffective.” Although he did not elaborate what these might be, decoys and electronic attack capabilities would be logical candidates.

⁴⁵⁷ David Tanks, *Assessing the Cruise Missile Puzzle* (Washington, DC: Institute for Foreign Policy Analysis, 2001), p. 11.

Figure 11: PRC Maritime Reconnaissance-Strike Complex

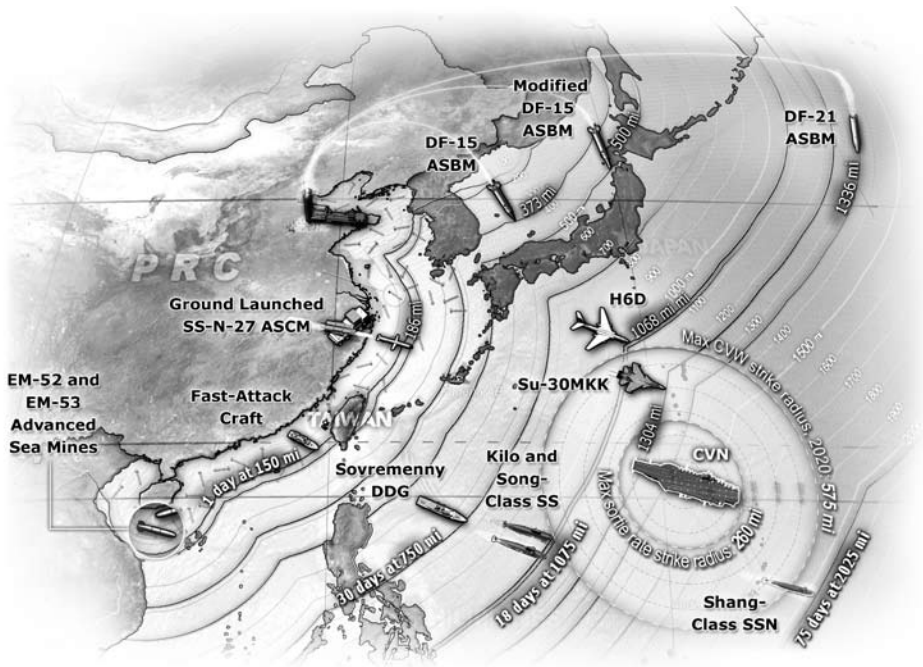

analyst at the Institute for Foreign Policy Analysis, wrote that, “Unfortunately, the capabilities of ship-based defenses against projected cruise missile threats are not keeping pace with the anticipated deployment of new families of anti-ship cruise missiles.”⁴⁵⁸

- From the inner to outer zone of the PRC maritime reconnaissance-strike network, US surface ships will be threatened by salvos of long-range, heavyweight, wake-homing torpedoes launched by PLAN nuclear-powered and diesel-electric attack submarines.
- The PRC’s over-the-horizon targeting network promises to be much more effective than the earlier Soviet system, with more capable space-based radars, electro-optical sensors, and

⁴⁵⁸ Ibid., p. 6.

electronic, signal, and communications intelligence collection capabilities. Moreover, having already demonstrated a workable ASAT capability, the Chinese are ready to fight for a space-based ISR advantage—or at least to deny the US a similar advantage—in the case of a shooting war. Supplementing the space-based sensors will be a land-based OTH-B radar system that is much better than anything the Soviets had. Airborne and submarine shadowing of US naval forces operating in the Western Pacific will provide further information.

- American ships will face an entirely new generation of weapon systems especially designed to defeat naval task force defenses. For example, the SS-N-27B Sizzler's attack profile is designed to defeat the Aegis anti-air warfare system. Similarly, the new multi-band seeker on the Kh-31Pm/PMK long-range anti-radiation missile gives it a good capability against both the SPY-1 and the E-2C/D AEW radars. These weapons are among those that the former Soviet Union would have fielded in the 1990s had the Cold War continued. Today, the Russians sell them to the highest bidder.⁴⁵⁹
- While the PLAN has just begun to demonstrate an ability to coordinate submarine ASCM strikes, its ultimate aim is to launch mass strikes against carrier strike forces using a combination of ballistic missiles and both submarine- and air-launched cruise missiles. As discussed earlier, coordinated ripple attacks using ASBMs, submarine-launched SS-N-27B Sizzlers, air-launched Kh-31ADs, Kh-59MKs and SS-N-27Bs, and Kh-31PM/MPK anti-radiation missiles, and newer, more stealthy ASCMs will likely pose one of the most difficult defensive problems the carrier force has ever faced.

⁴⁵⁹ There are persistent reports that Russia and China are selling some of their most advanced weapons to Iran. If true, US surface ships operating within the Persian Gulf might be seriously challenged over time. For example, any of the numerous commercial ships or small craft in the Persian Gulf could cue Iranian land-based supersonic Moskit or SS-N-27B Sizzler ASCMs. Iranian strike aircraft and Kilo submarines could employ similar missiles well out into the Arabian Sea. Andrew Feickert, "Cruise Missile Proliferation," Congressional Research Service, Report RS21252, updated July 28, 2005, p. 5. Tony Capaccio quoted a government official as saying that Russia offered to sell Sizzler anti-ship cruise missiles to Iran. Capaccio, "Navy Lacks Plan to Defend Against 'Sizzler' Missile."

- If that were not daunting enough, the carrier force is already faced with a PRC fourth-generation fighter and strike-fighter force as large as its own entire front-line strike-fighter fleet. Of course, not all of these aircraft will be dedicated to anti-carrier operations. However, the number of PRC aircraft will likely only go up over time, while carrier deck space inherently limits the maximum carrier strike-fighter force. Worse, every plane in the PRC strike-fighter force has an unrefueled combat radius greater than 850 nm. The only carrier-based aircraft that comes close to matching this range is the F-35C, which will not reach the fleet until sometime after 2010. Under the very best of circumstances, there will be only 200 of these aircraft in the 2020 carrier force, and perhaps as few as 100. In other words, the worst dreams of pre-World War II carrier planners have once again resurfaced. In a conflict over Taiwan, a US aircraft carrier operating within striking range of an enemy's coast *will be under constant threat of attack from longer-range, dual-purpose strike-fighters and fighter-bombers*, meaning its CVW will likely have to put proportionately more emphasis on carrier combat air patrols, and far less emphasis on strike missions.

It is certainly true that the PRC military is some time away from completing its maritime battle network. Moreover, even when PRC engineers fit all of the technical pieces together, it will take even more time for the PLAN, PLANAF, and PLAAF to develop the tactics, techniques, and procedures necessary to convert their disparate systems and combat methods into a truly effective joint operational network. However, consider the enormous strides in the Soviet maritime reconnaissance-strike complex made between the time Admiral Gorshkov arrived on the scene in 1956 and the appearance of the RORSAT/EORSAT, Backfire bomber, and Victor III nuclear-attack submarine in the 1970s. In comparison, the Chinese are starting from a much more advanced technical level and benefit greatly both from old Soviet operational experience and new Russian tactical advice and assistance.

It also appears that the PLAN might receive a higher degree of resource support than that ever given to the Soviet Navy. In September 2004, for the first time ever, the PLAN commander was elevated to the Vice Chairman-level of the Central Military Commission. Further, on December 27, 2006, when addressing representatives of the PLAN, Chinese Communist Party Secretary General and CMC Chairman Hu Jintao said, "We should strive to build a powerful navy to adapt

to the needs of our military's historic mission in this new century *and this new stage*" (emphasis added).⁴⁶⁰ As long as the Chinese economic engine keeps chugging along, the PRC maritime reconnaissance-strike complex will surely benefit from top-level CMC support and a steady stream of funding.

The bottom line is that the Chinese battle network is likely only to get better over time. Prudence dictates that the Navy develop systems, tactics, techniques, and procedures to allow it to prevail over such a network if circumstances require.

A RETURN TO THE *MARITIME STRATEGY*?

A review of the Navy's program of record suggests that fleet operators plan to fight a possible future network-versus-network battle in East Asia in much the same way as the Navy planned to fight the Soviets in the 1980s—that is, by accepting a severe CVW range disadvantage, improving task force defenses, and fighting a close-in fight. Is this strategy a sound one against a new, young challenger with a slightly shorter reach but potentially far heavier punch than the Soviets? Not likely.

Too Close for Comfort

The average unrefueled range of the aircraft in the 2020 CVW will be no greater than the 1980s air wing that had found the Soviet Backfire threat so challenging. However, the CVW's lack of improved reach will actually put future US carrier battle forces at a greater disadvantage against a Chinese battle network, even though the Chinese currently have no long-range maritime strike aircraft or anti-ship ballistic missiles with the range of the Backfire. Why? Because the Cold War *Maritime Strategy* was, at its core, an *offensive* strategy in which the US carrier force had the initiative. Although their CVWs were outranged, US carriers could use their mobility and deception to keep Soviet planners from knowing exactly when and where they were going to strike along their defensive perimeter. In sharp contrast, in a fight against the Chinese network, US carriers will most likely be tasked with defending

⁴⁶⁰ Fairclough, "Surface Tensions: As China Grows, So Does Its Long-Neglected Navy."

a particular piece of real estate—Taiwan and the Taiwan Strait—and they will need to respond immediately to prevent Taiwan from being overwhelmed. As a result, they will be forced to give up their mobility and to stand toe-to-toe with Chinese land, air, and sea forces, getting close enough to establish persistent anti-surface and air defense CAPs over the Taiwan Strait.

The currently optimal carrier operating range is 200 to 225 nm from the mid-line of the Taiwan Strait, which would allow a CVW to support the maximum number of combat sorties over the Strait with little reliance on land-based tanker support. However, this would mean the carrier would be only 245 to 270 nm from the Chinese coast—not a happy place to be. At this range, the carrier would be under constant threat of ASCM strikes from PRC SSNs, SSs, SAGs, bombers, and strike-fighters, and, very soon, ASBM attacks as well. The 2020 CVW could operate from 450 to 500 nm out, which would lessen the threat from PLAN SAGs. However, even at this range, the overall threat to the carrier would remain quite high. The carrier would be well within the short-range ASBM envelope and the unrefueled strike reach of virtually every strike aircraft in the PLAAF and PLANAF inventory, as well as PLAN submarine operating areas. Moreover, by moving out to 450 miles, the maximum number of CVW sorties would begin to drop, and maintaining surveillance-strike CAPs over the Strait would require dedicated, land-based tanker support—from bases which would likely be under threat of ballistic missile attack.

Improving Naval Battle Network Defenses: CEC

Obviously, when operating so close to the Chinese mainland, the demands on task force defenses will be quite high. The Navy is therefore expending considerable time, effort, and resources to improve its task force air and missile defenses. The first stage of this process is to complete the fielding of the new cooperative engagement capability, or CEC. The Naval Tactical Data System (NTDS), long the central nervous system of US naval battle networks, uses data-links to transmit commands among task force ships, which then fire defensive missiles based on fire control data from their own onboard sensors. In contrast, CEC-equipped ships and aircraft use directional antennas to transmit the raw data from their onboard radars to nearby ships and aircraft.

Surface ships pass on the data derived from their SPY-1 passive phased array radars, while E-2C Hawkeyes share the take from their APS-145 radars, which, by virtue of operating at 25,000 feet, can monitor more than six million cubic miles of airspace and 150,000 square miles of ocean out to 300 miles.⁴⁶¹ The CEC hardware and software on the ships and planes integrate all shared radar data to create “composite tracks” of all targets seen by battle network sensors. By so doing, a CEC-enabled battle network can form a “single, real-time, fire-control-quality composite track picture.”⁴⁶²

CEC engagement networks aim for the holy grail of air defenses—a single integrated air picture (SIAP). CEC-enabled battle networks will also extend the range at which any given ship can engage a target to well beyond its own radar horizon. Indeed, with weapons that can *engage on remote*—that is, be guided toward their targets using off-board sensors like another ship’s or the E-2C’s radar—a CEC-equipped ship will be able to fire at a target that would not normally be seen, much less tracked, by its own sensors. Moreover, because most stealthy platforms are only “invisible” from certain radar aspects (e.g., head-on), and because CEC tracks are developed along multiple radar bearings, CEC networks should be able to detect and track stealthy aircraft and cruise missiles over both land and sea.⁴⁶³

It gets better. Area Air Defense Coordinators onboard the Ticonderoga-class guided-missile cruiser (CG) that accompanies every Carrier Strike Group will soon be assisted by a new CEC-enabled Area Air Defense Command Capability System (AADCCS). The AADCCS is a new three-dimensional, collaborative defensive planning tool designed to give a “god’s eye view” of the air and surface space around a CEC-equipped task group, including friendly forces, neutral contacts, and hostile aircraft, cruise missiles, and ballistic missiles—along with their

⁴⁶¹ See “APS-145 Radar,” *Seapower, 2007 Almanac*, January 2007, p. 80.

⁴⁶² “Cooperative Engagement Capability (CEC),” accessed online at <http://www.fas.org/man/dod-101/sys/ship/weaps/cec.htm> on August 15, 2007.

⁴⁶³ Polmar, *The Naval Institute Guide to the Ships and Aircraft of the U.S. Fleet*, 18th edition, p. 136; Daniel Busch and Conrad J. Grant, “Changing the Face of War: The Cooperative Engagement Capability,” *Sea Power*, March 2000, accessed online at http://findarticles.com/p/articles/mi_qa3738/is_200003/ai_n8878828/; and Norman Friedman, “They Link it Together: Data Exchange Requirements and Systems in Naval Warfare,” *Naval Forces*, Volume 26, Number 3, 2005, p. 42.

headings and impact zones (for weapons). Using this information, the AADCCS can generate new network air and missile defense plans in minutes. The Navy hopes that the introduction of the CEC and AADCCS will substantially improve the ability of future naval battle networks to withstand air and missile attacks—at least long enough for joint offensive counter-network operations to beat down the opposing reconnaissance-strike complex.⁴⁶⁴

Current CEC battle networks do have limitations. For example, in order to keep the data current, today's CEC networks are limited to only 19 participants.⁴⁶⁵ However, as was the case with earlier NTDS engagement networks, with further doctrinal, technical, and experimental development, the CEC seems certain to expand in both capability and effectiveness. For example, CEC engagement networks will soon be able to integrate non-radar sensor data from electronic intelligence or other links to further improve the quality of air and missile tracks.⁴⁶⁶ Future improvements will make CEC networks increasingly more powerful over time.

The Next Step: NIFC-CA

Indeed, the outlines of these improvements are already evident in the Navy's new Naval Integrated Fire Control-Counter Air (NIFC-CA) program. The key component in the Navy's future "Sea Shield" efforts, the NIFC-CA introduces three new systems to CEC-enabled networks: the E-2D Advanced Hawkeye; longer-range air-to-air missiles; and new, more capable surface-to-air missiles. Perhaps the most important of these capabilities is the E-2D Hawkeye and its new APY-9 ultra-high frequency (UHF) electronically scanned array (ESA). The UHF band

⁴⁶⁴ Richard Scott, "Joining the Dots: Networked Platforms Extend Air Defense," *Jane's Navy International*, December 2005, pp. 28–30; and David A. Fulghum, "It Takes a Network to Beat a Network," *Aviation Week & Space Technology*, November 11, 2002.

⁴⁶⁵ The reason for this is that each platform in a current CEC network only communicates with the two platforms nearest to it, passing on all plots it receives. Because none of the plots passing through the sending platform are edited out, the data load on the system rises as the square of the number of participants. The current limitations on data transfer and correlation limit the size of the networks to 19 ships. See Friedman, "They Link it Together: Data Exchange Requirements and Systems in Naval Warfare," p. 42.

⁴⁶⁶ Scott, "Joining the Dots: Networked Platforms Extend Air Defense," pp. 28–30.

is the best frequency for picking small targets out of the reflected electronic clutter over both ocean and land. This characteristic is enhanced by the APY-9 ESA, which combines an ability to conduct mechanical 360-degree scans around a carrier (at variable rates of four, five, or six revolutions per minute) with an ability to “lock down” and stare along a particular azimuth with a variable-sensor field of view of 90 to 30 degrees. The longer dwell time and increased radar focus gives the APY-9 a much better detection capability against small, stealthy targets than the APS-145 found on the E-2C. Moreover, new space-time adaptive processing (STAP) techniques onboard the E-2D enhance the system’s ability to detect small targets obscured by ocean wave action or jamming. As a result, the system’s detection range is limited only by the radar’s line-of-sight to the horizon (greater than 300 nm). Indeed, the Navy claims that the E-2D will increase the volumetric detection coverage around an aircraft carrier to more than 300 percent that of the current E-2C radar.⁴⁶⁷

The Navy’s program of record CVW has a five-plane E-2D squadron, which would allow for sustained, 24-hour radar coverage over a naval task force. The Navy is also considering whether or not to add an aerial refueling capability to the airplane, which would increase its mission endurance from 4.5 to 5 hours to 8.5 to 9 hours. Under high-threat conditions, this might allow the squadron to sustain two aircraft on orbit, with one doing mechanical 360-degree sweeps around the CSG and another staring on the most likely threat axis.⁴⁶⁸ This scenario would likely provide for good situational awareness and defensive battlespace management. In this regard, the E-2D’s ESA is designed to act in tandem with the smaller but more numerous active electronically scanned array radars carried aboard the Block II F/A-18E/F Super Hornet and F-35 Lightning II. These X-band radars are specifically designed to spot very small targets and to track them through dense clutter—which makes them ideally suited for cruise missile defense. However, they have much shorter detection ranges than the E-2D’s APY-9. The E-2D therefore focuses on detecting targets at long range, and then vectoring combat air patrol aircraft to a position where their X-band radars can detect the threat. Naturally, the E-2D is equipped with advanced digital

⁴⁶⁷ David A. Fulghum, “New Threats, New Counters,” *Aviation Week & Space Technology*, April 30, 2007, pp. 50-51; and David A. Fulghum, “Advanced Flying Saucers,” *Aviation Week & Space Technology*, April 30, 2007, pp. 48-49.

⁴⁶⁸ Fulghum, “New Threats, New Counters;” Fulghum, “Advanced Flying Saucers.”

data links to get the information to the right defending aircraft at the right time. Moreover, with its CEC equipment, the E-2D can provide its raw radar data to the defending Aegis escorts below, extending their radar horizons as well.⁴⁶⁹ With its powerful radar feeding into the CEC net and its onboard mission operators directing task force defensive CAPs, the E-2D will become the “digital defensive quarterback” for any future naval battle network.⁴⁷⁰

The Navy is pursuing new weapons to exploit its longer-range sensing and discrimination capability. Future combat air patrols will be equipped with a variety of new air-to-air missiles designed specifically to counter the stealthy cruise missile threat. The current AIM-120C-6 version of the standard AMRAAM has an improved target detection device in its seeker that optimizes the explosive cone of its warhead, allowing it to make head-on intercepts of small, stealthy missiles. The subsequent AIM-120C-7 version will have better range and electronic counter-countermeasures. This missile will also have an ability to better anticipate a cruise missile’s flight path, allowing for more efficient intercepts. The C-7 version of the AMRAAM will be followed, in turn, by the AIM-120D, which will have a two-way data link, a 50 percent improvement in range, and an ability to “maneuver vigorously” at the end of its flight. This missile will restore the reduction in the CVW CAP’s maximum engagement range caused by the retirement of the F-14 Tomcat and its Phoenix air-to-air missile.⁴⁷¹

Surface escort surface-to-air missiles are also being improved. Perhaps the most dramatic improvement will come with the planned SM-6 Extended-Range Active Missile, or ERAM, which will combine the missile and booster “stack” of the SM-2 Block IV extended-range SAM with the active radar seeker found on the AMRAAM. The addition of an active radar seeker will allow the ERAM to make surface-to-air intercepts at the maximum kinematic range of the SM-2 Block IV missile, which is about 200 nm—a potential doubling of the protective missile engagement envelope around the carrier.⁴⁷² Enemy cruise missiles and

⁴⁶⁹ Fulghum, “New Threats, New Counters,” p. 50. See also David A. Fulghum, “Hornet’s Electronic Sting,” *Aviation Week & Space Technology*, February 26, 2007, pp. 24–26.

⁴⁷⁰ “E-2D Advanced Hawkeye.”

⁴⁷¹ Fulghum, “Hornet’s Electronic Sting,” p. 26; and “AIM-120,” accessed online at <http://www.designation-systems.net/dusrm/m-120.html> on September 7, 2007.

⁴⁷² “Standard Missile-6 (SM-6) Moves Ahead,” accessed online at <http://www.worldmissiles.com/news/deco4.pdf> on September 4, 2007.

aircraft that evade both a carrier strike group's CAPs and ERAMs will then have to survive attacks from CEC-directed SM-2 medium-range SAMs, the Evolved Sea Sparrow Missile—a horizon-range missile capable of maneuvering at 50 Gs⁴⁷³—and finally the Rolling Airframe Missile (RAM), a quick reaction, short-range, terminal defense missile.⁴⁷⁴

Engineers believe that the combination of ESA-equipped E-2Ds and AESA-equipped strike-fighters armed with new air-to-air missiles will improve the CAP's ability to kill cruise missiles by 600 percent. They further expect that the E-2D and the ERAM will improve the Aegis escorts' ability to kill the same targets by 200 percent.⁴⁷⁵ Navy officials are more circumspect, saying merely that the addition of these new NIFC-CA systems will provide for a capabilities-based network solution to air and cruise missile defense that extends the defensive depth of a naval battle network to “well beyond the existing, stand-alone capability of surface ship-controlled air defense weapons.”⁴⁷⁶ Indeed, the SM-6 would give a naval task force a defensive SAM that outranges every surface- and air-launched ASCM in the PRC inventory—meaning any PRC airborne “archer” would have to penetrate both the CSG's defensive CAP line as well as its powered missile envelope before being able to fire its “arrows” at US carriers.

For any CSG operating within 500 nm of the Chinese mainland, these powerful new defensive capabilities would be welcome, indeed. However, even if NIFC-CA systems result in airtight task force defenses, they will not address the Achilles Heel of the naval task force in a close-in, battle network slugfest—the shallow depth of its collective SAM magazine. A Ticonderoga-class CG carries 122 vertical-launch missile cells, while a Burke-class DDG carries either 90 or 96. In a high-threat environment, five or six escorts with 500–600 available launch cells might accompany the carrier, providing a formidable defensive punch. However, many of these “holes” will be filled with TLAMs, vertical-launched anti-submarine rockets (ASROCs), or shorter-range SAMs. Moreover,

⁴⁷³ See “RIM-162,” accessed online at <http://www.designation-systems.net/dusrm/m-162.html> on September 7, 2007.

⁴⁷⁴ See “RIM-116 Rolling Airframe Missile,” accessed online at http://en.wikipedia.org/wiki/RIM-116_Rolling_Airframe_Missile on September 7, 2007.

⁴⁷⁵ Fulghum, “New Threats, New Counters,” p. 50.

⁴⁷⁶ From Exhibit R-2, RDT&E Budget Item Justification for Naval Integrated Fire Control — Counter Air (NIFC-CA) Systems Engineering Integration and Test (SEI&T), February 2006, accessed online at <http://www.dtic.mil/descriptivesum/Y2007/Navy/O604378N.pdf> on September 9, 2007.

a Carrier Strike Group would likely come under sustained ASBM and ASCM attacks from the time it crossed the second island chain. The first ASCM attacks would come from H-6K bombers and Shang SSNs, and once a carrier task force closed to within 1,000 nm from the Chinese mainland, the intensity of the attacks would increase as the carrier came within range of PRC fourth-generation strike-fighters and fighter-bombers armed with air-launched ASCMs. When operating within 250–500 nm from the mainland, the attacks from ASCMs launched from land-based aircraft and submarines would likely be relentless. The Navy long ago gave up trying to rearm its missile combatants at sea. How long will a CSG be able to remain on station after expending missiles all the way in from the second island chain, and before it reaches the SAM capacity level necessary to cover its withdrawal back out of range of PRC strike systems? Given the much greater depth of magazine of the Chinese anti-access/area-denial network, the answer may be: not very long.

Taking on the ASBMs

The need to swap out some number of surface-to-air interceptors with anti-tactical BMD interceptors will compound the problem of limited magazine depth. As the threat to surface ships from ASBMs goes up over time, ATBM interceptors will claim an ever-larger percentage of available magazine space. Indeed, given the emphasis that the Chinese are putting on developing TBM maritime strike systems, the lack of urgency in Navy ballistic missile defense plans is quite striking. Up to this point, the Navy has relied almost exclusively on the US Missile Defense Agency to pay for the development of working BMD capabilities.

The MDA is charged with developing a *global*, multilayered Joint Multidimensional Ballistic Missile Defense Network comprised of overlapping sensors and weapons capable of countering the entire array of emerging ballistic missile threats in all phases of their flight.⁴⁷⁷ As part of this effort, the MDA has funded a spiral development program to convert 18 Aegis ships (three Ticonderoga-class guided-missile cruisers and 15 Burke-class guided-missile destroyers) into *national* ballistic missile defense ships. Between now and 2010, the ships will receive a new, open-architecture Aegis BMD signal processor (Aegis BSP) to improve both their tracking and range resolution of ballistic missile trajectories

⁴⁷⁷ For a thorough overview of the evolving US Ballistic Missile Defense System, see “A Day in the Life of the BMDS,” accessed online at <http://www.mda.mil/mdalink/pdf/bmdsbook.pdf> on September 9, 2007.

as well as their ability to discriminate targets in an RV/decoy complex. This new processor is being accompanied by successive commercial-off-the-shelf (COTS)/open architecture upgrades to other Aegis and missile hardware and software components. The ships will also be modified to carry increasingly capable versions of the new Standard SM-3 (ballistic missile interceptor). With these improvements, the 18 modified ships will ultimately be able to track all types of ballistic missiles, and to intercept and destroy them during their mid-course flight phase while they are flying through outer space.⁴⁷⁸

The first converted ballistic missile defense ships became operational in 2004. These early BMD ships could conduct long-range surveillance and tracking of ballistic missiles, but only a few were capable of engaging short- and medium-range ballistic missiles with the earliest Block IA version of the SM-3.⁴⁷⁹ Moreover, when performing in the BMD role, the ships could not perform any other battle network defensive duties such as anti-air warfare. However, by 2006, improvements to both the Aegis BSP and other software components of the Aegis combat system meant that a steadily growing number of the BMD ships could track and engage short- and medium-range missiles, and some intermediate-range missiles, while performing all of their normal battle network duties.⁴⁸⁰ By 2010, when armed with the most capable version of the SM-3, all 18 ships will be able to track, classify, and engage most ballistic missile threats—to include some intercontinental ballistic missiles.⁴⁸¹

⁴⁷⁸ From “Aegis Ballistic Missile Defense Status Overview,” a PowerPoint briefing provided to the authors by Lockheed Martin Corporation on December 13, 2006.

⁴⁷⁹ The Block IA version of the standard ballistic missile interceptor (SM-3) has a 21-inch diameter booster rocket, a GPS/inertial guidance system, and a kinetic hit-to-kill warhead. See “RIM-66C/RIM-156/RIM-161 Standard Missile” in “Ship Weapons,” *Seapower, 2007 Almanac*, January 2007, p. 67.

⁴⁸⁰ By 2006, the Block IB version of the SM-3 was operational, with an advanced two-color infrared seeker to help discriminate between RVs and decoys, and a throttling divert-and-attitude control system for increased maneuverability against sophisticated warheads and intermediate-range missiles. See “RIM-66C/RIM-156/RIM-161 Standard Missile,” p. 67. Although the 2006 Aegis ballistic signal processor (BSP) upgrade allows an Aegis combatant to perform BMD and anti-aircraft warfare (AAW) missions simultaneously, the ship cannot engage as many simultaneous air targets as an Aegis combatant in a stand-alone AAW role. From “Aegis Ballistic Missile Defense Status Overview.”

⁴⁸¹ The Block IIA version of the SM-3, cooperatively developed with the Japanese Missile Defense Agency, has a 21-inch diameter second-stage booster, giving the missile a higher burn-out velocity, longer range, and better divert capability than earlier versions of the interceptor. See “Aegis Ballistic Missile Defense Status Overview.”

Consistent with battle network precepts, the ships will be able to *launch on remote*, using data provided by other BMDS sensors to initiate the engagement, but using onboard sensors to conduct the final intercept, and to *engage on remote*, turning over missile guidance and intercept entirely to off-board BMDS sensors. At that point, the 18 ships will be “an integral part of the BMDS—all ranges, all phases, all regions.”⁴⁸²

While the Navy has 66 other Aegis combatants it could modify to the same anti-missile standard as the 18 MDA-funded ships, it apparently has no plans to do so. Instead, it intends to speed up the design and building of an entirely new theater air and missile defense (TAMD) cruiser, now known as the CG(X). However, under current plans, the first of these ships will not be authorized until FY 2011, and the Navy plans to have only three of these ships in the fleet by 2020, 12 years from now. This plan suggests that either the Navy has concluded that it will take a decade or more for the Chinese to put together a workable TBM maritime strike system, or the Navy is confident that such missiles can be countered by other means, such as electronic attack, decoys, or deception.

Counting on the ASBM threat to develop more slowly seems more of a hope than a logical projection. Reports suggest that the DF-21C is nearing the end of its development, and the first Chinese radar- and photoreconnaissance satellites are expected to be on orbit by the end of this year. A working ASBM capability is thus not likely to take another 12 years to achieve. Similarly, it may very well be true that the most effective defenses against Chinese ASBMs will be “soft-kill” type measures, including high-quality ELINT and infrared spoofers and multi-phenomenology decoys. Without doubt, however, having a working BMD interceptor or perhaps another “hard-kill” system would provide added depth to carrier battle force anti-ballistic missiles defenses, and would provide a hedge against the failure of “soft-kill” systems. In this regard, a directed energy weapon (DEW) capable of destroying RVs or their guidance systems might be a more cost-effective hard-kill system than a missile interceptor. Regardless of what the final answer might be, it seems clear that some means to kill inbound tactical ballistic missiles is a pressing fleet requirement.

In any event, in a future confrontation with China, US carrier task forces operating in the Western Pacific are likely to come under

⁴⁸² Otto Kreisher, “Bigger Shield,” *Seapower*, December 2006, pp. 43–44; and “Aegis Ballistic Missile Defense Status Overview.”

sustained ballistic missile bombardment soon after they penetrate the second island chain, and the density of that bombardment will only increase the closer they venture toward the Taiwan Strait. Moreover, China may sell ASBM technologies to other countries such as Iran. Developing the means to cope with this growing threat should therefore be near the top of fleet priorities. Indeed, demonstrating an effective fleet tactical BMD capability is one of the best ways to inject uncertainty into PRC calculations surrounding a battle between its own reconnaissance-strike complex and a US maritime power-projection network, and to dissuade other potential adversaries from pursuing these anti-carrier capabilities.

A NEW FIGHT STRATEGY: FIGHTING FROM RANGE

An even better way to inject uncertainty into the minds of PRC planners and other potential adversaries would be to develop the capabilities necessary for US forward-deployed and reinforcing aircraft carriers to fight from beyond the range of most PRC strike systems. One of the best ways to do this might be to exploit the greatly increased range, persistence, and stealth of the N-UCAS. The N-UCAS is likely to change the long-established relationship between size and range for carrier aircraft, giving the CVW a desired capability first identified in December 1945—an ability to deliver strikes from 2,000-nm range and beyond.

One look at a map is all it takes to understand what this might mean in a confrontation with the PRC. The distance from the continental United States to Hawaii is 2,100 nm, and a flight from Hawaii to Taipei exceeds 4,400 nm. Even Guam, the westernmost US territory in the Pacific, is over 1,500 nm from the Taiwan Strait. Such distances simply beg for carrier-based systems with greatly increased range and endurance. For this reason, “...whatever payloads are deployed on carrier-based [UCASs], the ability to deploy those payloads on platforms with a 1,500 mile radius and 12 hour endurance will be the factor that drives their adoption.”⁴⁸³

⁴⁸³ Cote, *The Future of Naval Aviation*, p. 29.

Figure 12: Distances in the Pacific

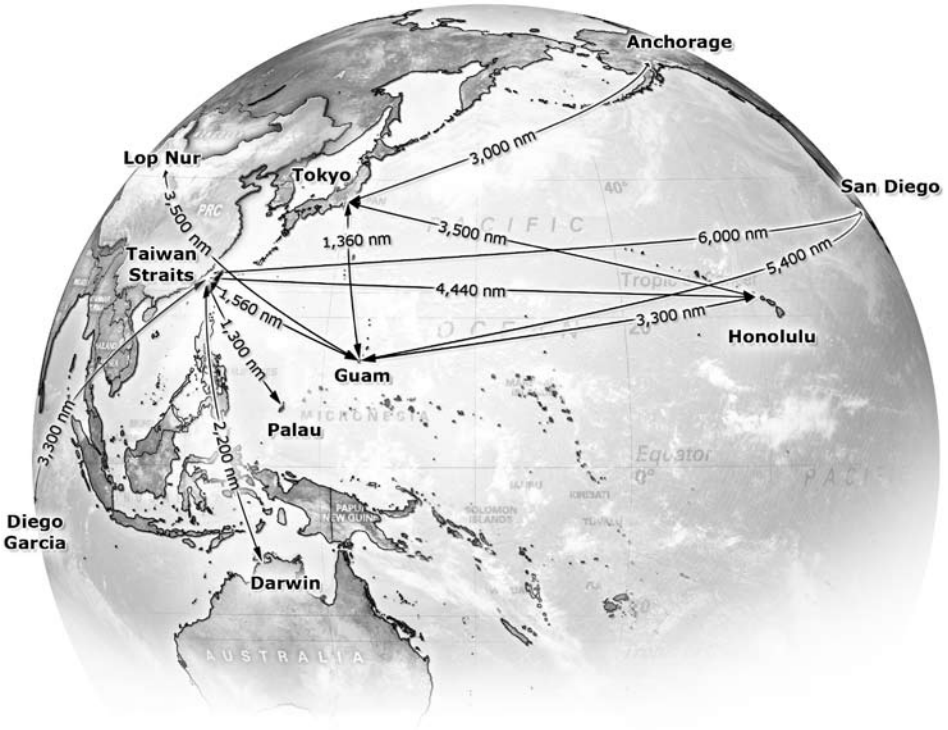

Owen Cote observed that the N-UCAS's combination of range *and* endurance—itsself a combination of being both air-refuelable and unmanned—makes it such a potentially “game-changing” system. Being able to loiter over a target area is an increasingly important characteristic of any future airborne system. Even the Navy’s new Tactical Tomahawk (TACTOM) missile is designed to loiter for two hours at 900 nm before attacking its target. With a two-way data link that allows the missile to be retargeted in flight, the TACTOM can thus be used to attack emergent targets.⁴⁸⁴ While this system improves the flexibility of extended-range strikes, consider the potential impact of being able to refuel an N-UCAS at the end of a 1,000-1,300 nm transit, giving it another seven to eight more hours over a target area. Moreover, it can then fly back out to the tanker safe line, refuel again, and return to the target area again, staying on station for over a day. This type of

⁴⁸⁴ The maximum range of the TACTOM can be extended beyond 1,000 nm if the missile is not required to loiter. See “BGM-109 Tomahawk.”

persistence at range would be a first for a carrier-based air system, providing the CVW with a degree of power and flexibility unmatched by any previous air wing.

Of course, in any confrontation with China, persistence at range will be closely associated with, and perhaps inseparable from, platform survivability. PRC forces will operate under the cover of a formidable land-based integrated aerospace defense network. While many of the specific elements of modern integrated air defense systems remain classified, “Moore’s Law”—which proposes steady geometric increases in computing speed and power—will inevitably mean that the discrimination capabilities of air defense radars will continue to improve. Moreover, radars will become increasingly difficult to jam, and missile seekers will get better and more difficult to spoof and decoy. The Russians (in particular) continue to advance SAM technology to the point where improvements to older systems like their SA-10 (or naval version of the same missile, the SA-N-6), and newer systems like their SA-20, pose a grave threat to anything flying within 125–250 nm of the system. By deploying these SAMs on the western side of the Taiwan Strait, the Chinese can threaten aircraft flying inside Taiwanese airspace, as well as carrier aircraft operating at their optimally effective strike range.⁴⁸⁵ Furthermore, as described earlier, the Chinese are now taking these systems to sea on DDGs that will be able to project modern air defenses along a 125+ nm radius from their operating locations in and around the Strait. Add to this the increasingly capable PLAF and PLANAF strike-fighter forces directed by new, sophisticated airborne warning and control aircraft like the A-50, a radar-equipped version of the Russian Il-76 Candid strategic airlifter, and the life expectancy of any non-stealthy system operating near the Taiwan Strait becomes exceedingly small.⁴⁸⁶

Under these circumstances, the stealthy N-UCAS would be a potential game-changer. Compared to the combat-loaded Super Hornet, which modern air search radars can detect at very long distances, both the F-35 Lightning II and the N-UCAS will have a much higher degree of stealth that should enable them to penetrate the PRC’s advanced air

⁴⁸⁵ For a map of current SA-10 coverage over the Taiwan Strait, see *Military Power of the People’s Republic of China 2006*, p. 31. The SA-20 theater air and ballistic missile defense system has a maximum effective engagement range of 250 nm. See “S-300PMU3 / S-400 Triumf / SA-21 Growler,” accessed online at <http://www.globalsecurity.org/military/world/russia/s-400.htm> on September 10, 2007.

⁴⁸⁶ *Military Power of the People’s Republic of China 2006*, p. 30.

Figure 13: PRC Air Defense Coverage in the Taiwan Strait



defense network. However, the N-UCAS will separate itself from even the very stealthy F-35C when it comes to *loitering* inside a modern integrated air defense system. Because the N-UCAS does not have a cockpit, it has a significant low-observable advantage over the Lighting II. However, it is the system's tailless design that will provide its greatest stealth advantage, giving it a far greater degree of broadband, all aspect stealth than the F-35's twin-tail configuration. This should free the N-UCAS from the flight path constraints that burden other aircraft trying to avoid enemy radars, and give it the ability to operate undetected inside the PRC air defense network for long periods.⁴⁸⁷

The N-UCAS's unique combination of range, endurance, and stealth, which translates into CVW persistence at range, would be

⁴⁸⁷ For a more elaborate but accessible explanation of low-observable aircraft designs, see Rebecca Grant, *The Radar Game: Understanding Stealth and Aircraft Survivability* (Arlington, VA: Iris Independent Research, 1998).

especially critical in any confrontation with China for two additional reasons. First, any PRC military attack against Taiwan would be supported from hundreds of bases located on the Chinese mainland, an advantage not unlike the one enjoyed by the allies in Europe in 1944, when they were able to stage massive invasion forces within easy striking distance from the French coast. In contrast, the US military has precious little Pacific real estate from which to operate tactical aviation to defend Taiwan. Indeed, it is in the process of giving up some of what little access it has. Although the US military is building up its bases in Alaska, Hawaii, and Guam, it is closing down potentially useful installations on Wake, Midway, and Johnson Islands. True, it does have access to bases in Japan, Australia, and Singapore, but operations from these locations will inevitably suffer from political and operational constraints. Having 11 highly mobile, defended airbases that can operate without political constraint in the Pacific, concentrate their effects over extended ranges, and fight cooperatively as part of a dispersed maritime battle network will provide US forces with an asymmetric capability of their own that will help to offset, at least to some degree, the Chinese basing advantage. The central importance of carrier aviation to any US defense of Taiwan explains the keen Chinese interest in keeping carriers at bay. A CVW equipped with longer-range, persistent air combat systems, which allow the carriers to operate and fight cooperatively over longer ranges, is one way to frustrate Chinese intentions.

Second, given the advantage the Chinese battle network seems sure to enjoy in magazine depth, US naval task forces and land-based aerospace forces would likely lose an extended long-range guided weapons duel unless they were authorized to hunt down and kill PRC sensors and strike systems located on the Chinese mainland. Despite the risks involved, it seems highly unlikely that any President who decided to commit US armed forces to Taiwan's defense would allow PRC anti-access/area-denial systems operating on Chinese territory to operate freely and without risk. These targets will not be vulnerable to short-range, non-stealthy aircraft. Moreover, China's great strategic depth will allow the PRC armed forces to position many of their anti-access/area-denial systems out of the reach of most current and planned US aviation systems and air-delivered weapons. To offset this advantage, the US joint multidimensional battle network may be required to find and destroy targets located deep inside China's defended airspace.⁴⁸⁸

⁴⁸⁸ Any US attack against the Chinese mainland would be fraught with risks. Therefore, this discussion is speculative. However, when discussing a potential confrontation with the United States over Taiwan, Chinese defense analysts talk openly of attacking US operating bases, including those on Guam. At the

While extended-range strike weapons are clearly the best means for hitting deep *fixed* targets, dealing with *mobile* targets will likely require different types of penetrating, extended-range air combat systems. US forces have been down this road before. For example, during the Cold War, the Air Force argued that the stealthy B-2 bomber could penetrate deep inside Soviet territory and use its onboard sensors to locate and kill mobile strategic systems like the SS-24 (rail-mobile) and SS-25 (road-mobile) intercontinental ballistic missiles. In a similar way, the PLA's extensive use of mobile systems—whether they are air defense radars or missiles, ASBM or ASCM launchers, land-attack ballistic and cruise missiles launchers, missiles, or mobile command centers—will likely require US forces to establish a persistent overwatch of broad swaths of Chinese territory. Indeed, the first requirement in any confrontation with China would be to establish persistent coverage over multiple target areas in order to find, fix, and track emergent targets—whether or not the target is attacked by a missile or a penetrating air vehicle. However, as the B-2 bomber demonstrated, and as more recently confirmed by the non-stealthy MQ-1 and MQ-9 hunter-killer UASs over less threatening skies, it often makes the most sense to combine surveillance and strike systems on one platform, allowing for the immediate attack of any discovered target.

This is why the stealthy, extended-range, dual-role N-UCAS would be so valuable in a confrontation with a country the size of China. Its combination of range and endurance would allow the system to range the entire depth of Chinese territory, enabling future CVWs to undertake missions that currently only the Air Force B-2 could perform (and even that in a limited fashion). After refueling at a tanker safe line, a stealthy N-UCAS could either fly an in-and-out strike nearly 1,500 nm deep into PRC territory, topping off at another tanker to refuel prior to returning to its carrier, or it could hit an even deeper target while flying a 3,000 nm one-way overflight of the entire country, refueling at a tanker operating along a distant border before recovering at a land base Central or Southern Asia. Although just one data point, a recent wargame conducted by the Center for Strategic and Budgetary Assessments, which assumed US access to bases in Afghanistan, suggested that weapons with a strike range of 1,900 nm, or air systems with an unrefueled combat radius of 1,900 nm, would have the range and endurance to allow the United States to hold virtually every part of Chinese

very least, the United States would benefit from having the capabilities to hold at-risk operating bases and targets on the Chinese mainland.

territory at risk. This range is not far off from the 1,400-nm range expected from the X-47B demonstrator air vehicles.

Of course, the N-UCAS would lack the carrying capacity of a B-2, which can carry up to 20 2,000-pound or 80 500-pound JDAMs. However, any operational N-UCAS would carry a useful combat load that, when combined with other N-UCASs, would provide a formidable punch. Each of the two bomb bays in the X-47B demonstrator air vehicle are sized to carry either one 2,000-pound JDAM or six 250-pound Small Diameter Bombs, giving the system a maximum weapons load out of either two JDAMs or 12 SDBs. In other words, a single 12-plane UCAS squadron with tanker support could thus maintain five ISR-strike CAPs up to 3,250 nm from the carrier (10 one-ton JDAMs or 60 SDBs); six ISR-strike CAPS up to 1,750 nm from the carrier (12 one-ton JDAMs or 72 SDBs); and seven CAPs (14 one-ton JDAMs or 84 SDBs) at 500 nm from the carrier. These weapon densities would provide US strike planners with a range of attack options.

After expending their weapons, the N-UCASs could continue to perform a variety of useful functions, particularly as the eyes of a joint, over-the-horizon battle network. The N-UCAS could use its organic sensors and act as a relay for ground or ocean sensors seeded around the battle area. Given the short-transmission range issues associated with small sensors, not all of them would be able to transmit to space-based nodes. Under these circumstances, very long-loiter communications relay systems on a stealthy N-UCAS may be the only way for ground and ocean sensor networks to send their “takes” back to US commanders.

FIGHTING THE OUTER NETWORK BATTLE

The previous discussion suggests an entirely new N-UCAS-enabled fight strategy which would allow a US joint power-projection battle network to engage the PRC maritime reconnaissance-strike network from extended ranges. By achieving parity in strike reach with the PRC battle network and operating in conjunction with Air Force long-range strike systems, the US carriers would be able wage an entirely different fight, largely on their own terms. In short, they could establish numerous surveillance-strike CAPs inside the PRC’s integrated air defense systems or over enemy territory beyond the range of most PRC anti-access systems. US carrier strike forces operating 1,600 nm or more from the PRC coast

would automatically reduce the densities of any PRC weapon salvos, which would in turn enhance the effectiveness of task force defenses. Fighting at such long ranges would also force PLAAF and PLANAF assets to operate at the very edge of their operational ranges, with all the problems that entails (e.g., ample early warning and concentration of carrier CAPs, etc.). Additionally, the carriers would not have to advance toward PLAN submarines waiting in ambush positions. Instead, PLAN submarines would have to sail into the open ocean to find and engage the carriers, in the process becoming vulnerable to American ASW forces. CVWs capable of fighting and erecting persistent surveillance-strike CAPs from extended ranges would thus change the way that carriers now fight. Indeed, gaining an ability to fight from ranges as far away as 1,600 to 3,000 nm would be as dramatic an advance in naval warfare as was the jump from 20-nm range battleship gun battles to carrier airstrikes from 300 nm.

How might this “Outer Network Battle” unfold? As tensions rose, N-UCASs on carriers already forward-deployed in the Western Pacific would begin flying surveillance missions near the enemy coast in order to build as complete a picture of the battlespace as possible. Air-to-air configured N-UCASs, operating under the control of operators on E-2D Advanced Hawkeyes, could trail any PRC airborne shadowers of US task forces, ready to shoot them down at the first sign that they were preparing to launch strikes against US naval forces (e.g., turning on their targeting radars). Manned aircraft have normally performed these missions. However, the N-UCAS’s great endurance and stealth could make it an ideal platform for these trailing missions during the pre-hostility phase of a crisis.

The N-UCAS’s great unrefueled range would also allow forward-deployed carriers to position themselves to maximize their survivability against a surprise first strike by PRC forces. For example, although the carrier would still be held at risk by DF-21C ASBMs, H-6K bombers, and submarines, by operating beyond 850 nm it would remain outside the unrefueled strike range of PRC land-based strike-fighters, which would help diminish the initial operational risk to the aircraft carrier. Most importantly, at a range of 850 nm, with a 12-aircraft N-UCAS squadron, a CVW could maintain six or seven ISR-strike CAPs over the Taiwan Strait 24-hours-a-day. This would place as many as 84 SDBs over the Strait, ready to attack any hostile PRC amphibious task force. This might provide a powerful deterrent against any PRC attack.

Should hostilities begin, the orbiting N-UCASs could mount immediate attacks. Whether on orbit for ten or over 50 hours, they would be ready to transition to combat quickly and without fatigue. Reinforcing carriers surging toward the Western Pacific could lend support from the earliest hours of the war. For example, with a single 12-plane N-UCAS squadron, aircraft carriers leaving Pearl Harbor could immediately launch five N-UCASs and have them in a fight over the Taiwan Strait 4,450 nm away in just over ten hours, given a 450-knot cruising speed and two aerial refuelings from land-based Air Force tankers operating out of either Guam or Japan.⁴⁸⁹ A stealthy F-35C attempting the same mission would have to receive four more aerial refuelings from Air Force tankers just to get to the area, slowing down transit time and causing a substantial refueling opportunity cost to the entire force. More importantly, the F-35C would have to land in Taiwan or Okinawa immediately after the transit due to crew endurance limits.

In contrast, after being refueled at a tanker safe line some distance from the Strait, arriving N-UCASs would be immediately ready and able to fight. They could stealthily transit to the battle area and spread out over the Taiwan Strait, forming up to five independent 200-nm radius surveillance-strike CAPs, a radius which would allow the attack of any target within 15 minutes from sighting.⁴⁹⁰ Of course, overlapping CAPs would allow even more responsive attacks. Alternately, one or two of the aircraft could transit another 1,000 nm to hit PLAN targets in the South China Sea near the Spratley Islands before returning to the refueling orbit east of Taiwan on their way back toward their carrier. Others might be tasked to penetrate Chinese airspace and attack components of the PRC integrated air defense network. The point here is that the N-UCAS's great unrefueled range and superhuman endurance would provide the US joint force with enormous operational and tactical flexibility, especially early in the fight when reinforcing carriers have not yet closed the range.

Other carriers could approach the war zone along the Great Circle Route, under the added protection of land-based missile defense forces

⁴⁸⁹ It might be possible in 2020 for N-UCASs to conduct four-ship open-ocean transits like a flock of geese in tight formation using station-keeping technology developed for aerial refueling, while rotating the lead and conserving group fuel consumption, further extending range and relieving pressure on overstressed aerial refueling assets.

⁴⁹⁰ "X-47 Carrier Compatibility: A Day in the Life," a PowerPoint presentation briefed by Northrop Grumman at a press availability the week after its contract award on August 2, 2007.

stationed in Alaska. The flight distances for the N-UCASs would be shorter by 500-1,000 nm, perhaps cutting out one aerial refueling in the process. Two added advantages of this approach would be that N-UCAS flights could be supported exclusively by air refueling forces stationed in Japan, and there would be multiple choices for emergency airfields if anything went wrong in transit and a sortie had to be diverted.⁴⁹¹

As reinforcing carriers closed the range, they could either maintain more surveillance-strike CAPs over the Strait or begin to send more strikes deep into China, focused primarily on PRC maritime anti-access/area-denial systems. Importantly, the reinforcing carriers could slow their advance once they were 1,500–1,600 nm from the Chinese mainland—at the very outer edges of the PRC anti-access/area-denial network—where they could exploit their inherent mobility, as well as the great range and endurance of their N-UCASs, to avoid PRC targeting and attacks. From there, the carriers could use N-UCASs to continue the Outer Network Battle with the intent of collapsing the PRC network from the inside out. For example, N-UCASs armed with a boost-phase ballistic missile defense interceptor like the NCADE could establish persistent BMD CAPs over suspected ASBM launching areas, as well as over PRC short-range ballistic missiles aimed at Taiwan and Japan, taking many of these missiles out of the fight. Other N-UCASs might attack PRC OTH-B radar systems located deep inside Chinese territory, since these targets would be unreachable by any manned carrier aircraft.

As discussed earlier, even after the systems expend their onboard ordnance, with their 50- to 100-hour endurance, N-UCASs could be continuously refueled and stay in the battle area for another two to three days. While there, they could perform a variety of important tasks, such as providing continuous ISR support to the joint force commander, jamming PRC air defense radars, or covertly monitoring ocean acoustic arrays designed to locate PLAN submarines, or providing communication relays for joint multidimensional battle network sensors.

As the PRC maritime battle network was degraded, all US carriers could begin to close the range, which would mean that they would

⁴⁹¹ Another interesting option involves long-range carrier operations conducted in the vicinity of Darwin, Australia. The transit distance to the Taiwan Strait from a carrier in the waters near Darwin is about 2,200 nm; allowing a pre-planned strike package of N-UCASs to fly the entire mission with one aerial refueling, and with the added bonus of numerous divert bases in the Philippines.

have to guard against threats from PLAAF and PLANAF strike aircraft. Under these circumstances, N-UCASs would serve as remote missile magazines for the E-2D Hawkeyes. When armed with AIM-120Ds with two-way data links, N-UCASs could intercept and attack PRC aircraft at ranges well beyond 500 nm from the carrier, and far beyond the effective strike range of air-launched ASCMs. Alternatively, when so equipped, the N-UCASs could work in tandem with AESA-equipped F/A-18E/Fs, in effect providing them with a greater engagement range and larger missile load outs. Indeed, F/A-18E/Fs conducting cooperative missile engagements using stealthy forward N-UCASs might make future carrier CAPs far more flexible and lethal.

The Outer Network Battle would likely extend thousands of miles over land and sea, and also hundreds of miles into outer space. In this regard, Massachusetts Institute of Technology (MIT) scholar and naval aviation expert Owen Cote recommended that the Navy “get back into the business of denying its opponent a reliable ocean surveillance capability.”⁴⁹² As noted earlier, the last time a space-based reconnaissance system materially threatened the carrier strike group, President Ford ordered the Department of Defense to develop an anti-satellite capability, which resulted in a fighter-launched, direct-ascent ASAT.⁴⁹³ It might be possible to develop a new direct-ascent ASAT that could be fired from an N-UCAS. This would allow a carrier strike force to conduct defensive counter-space missions, firing N-UCAS-launched ASATs at some distance from the carrier so as not to give away its operating location to PRC infrared satellite systems, and in a location that maximized the likelihood of a successful satellite intercept. Of course, a boost-phase weapon combination like N-UCAS/NCADE would provide future CVWs with the means to conduct offensive counter-space operations by shooting down both PRC space-launched vehicles as well as Chinese ground-launched ASAT missiles.

The Outer Network Battle would not be a Navy-only endeavor. It would depend critically on space-based sensors, long-range strike and air dominance platforms, aerial tankers, reconnaissance platforms, and electronic and computer network attack capabilities operated by the US Air Force. Indeed, so important would the Air Force contribution be to the Outer Network Battle that the Navy and Air Force should consider

⁴⁹² Cote, *The Future of Naval Aviation*, p. 10.

⁴⁹³ The Air Force program involved a fairly large hit-to-kill missile launched from an F-15 Eagle in a power-climb at 40,000 feet. Friedman, *Seapower and Space: From the Dawn of the Missile Age to Net-Centric Warfare*, p. 196.

the development of a new AirSea Battle Doctrine, along the lines of the AirLand Battle Doctrine developed jointly by the Air Force and the Army during the 1980s. The Outer Network Battle might also include special operations attacks against high-value PRC battle network nodes. In other words, the battle would hinge on the joint application of effects in and from all dimensions—air, land, sea, undersea, space, and cyberspace.

As the US joint multidimensional battle network gained a decisive upper hand in the Outer Network Battle, US carriers could close the range even further, bringing their manned aircraft to bear—first, their stealthy F-35Cs from ranges as far as 650 nm from the Strait. Once the PRC air defense network was neutralized, the F/A-18E/Fs, which up to this point would have been concentrating on fleet air defense, would get into the fight. Meanwhile, N-UCASs would range throughout the depth and breadth of China.

N-UCASs would also provide other tangible benefits in a fight against a future PRC anti-access/area-denial network. For example, unmanned aircraft would offer the ability to sustain flight operations in weather too poor for manned flight, robbing PRC military planners of the option of exploiting the effects of bad weather in their offensive planning.⁴⁹⁴ In addition, while the N-UCAS's extended unrefueled range would certainly provide future Carrier Strike Groups with greater independent freedom of action, equally important would be its impact on the already overtaxed US aerial refueling fleet. Greater unrefueled flight ranges translate directly into fewer required aerial refuelings, which lowers the demands on tankers and means fewer tankers will need to be based in theater. All of this would lead to greater overall operational flexibility and an expanded set of options for the joint force commander—at lower risk.

TOWARD A GLOBAL SURVEILLANCE-STRIKE NETWORK

The foregoing descriptions of a future Outer Network Battle and the N-UCAS's contributions to it are, of course, mere speculation. While based on reasonable assumptions about an operational N-UCAS, the actual development of any Outer Network Battle concept or related AirSea

⁴⁹⁴ Fulghum, Chavanne, and Butler, "Stealth at Sea," p. 34.

Battle Doctrine would be based on experimentation, analysis, and system developments. However, it provides some useful hints about the “game-changing” potential of the N-UCAS, as well as why the system was singled out in the 2006 QDR.

More importantly, a US move toward an N-UCAS-type system might cause the Chinese to conclude that the future firepower cost-benefit ratio might be trending in favor of the United States. A stealthy N-UCAS would likely be able to penetrate PRC defensive space as reliably and at a far cheaper cost than PRC missiles could penetrate the US defensive space. Moreover, since the system is reusable, the cost-benefit equation might tilt even more solidly in the US favor. Worse, at least from the Chinese perspective, an operational N-UCAS with an unrefueled combat radius of 1,500-2,000 nm would likely negate much of the PRC’s investment on ASBMs, and possibly totally upend Chinese calculations over the potential correlation of forces in the Western Pacific, as well as the risks and benefits of taking on the United States in a “local war under high technology conditions.”

Figure 14: Potential PRC Strike Coverage with N-UCAS

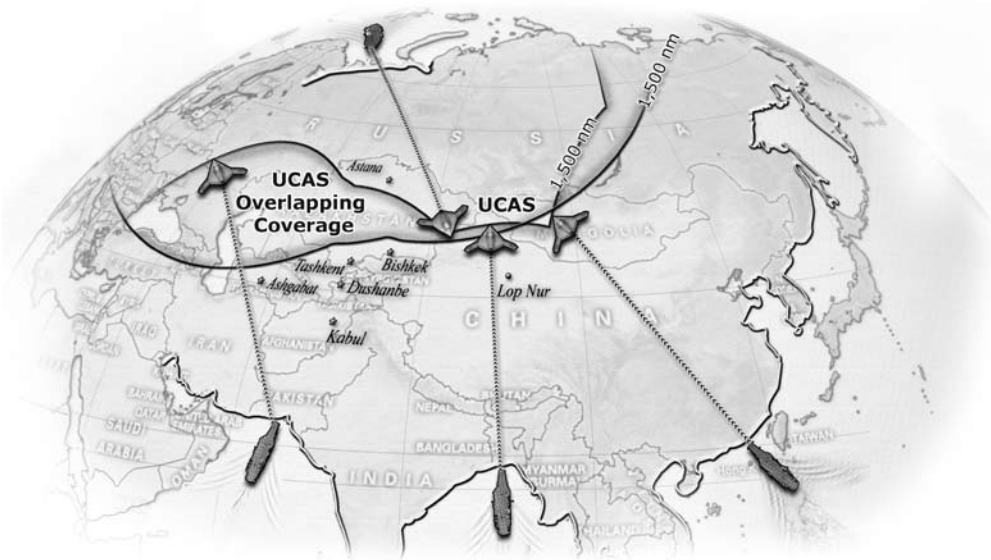

Indeed, an N-UCAS-equipped carrier force would greatly tax any future Chinese anti-access/area-denial network. Consider this: with a conservative unrefueled strike radius of 1,500 nm, an N-UCAS could range the Chinese nuclear test site at Lop Nur, located deep in central China, from a carrier operating in the Bay of Bengal (approximately 1,200 nm away), or from a carrier operating in the North Arabian Sea (approximately 1,500 nm away). Given a conservative 3,000-nm unrefueled cruise endurance (double the 1,500-nm combat radius), an N-UCAS could cross much of China and refuel at the end of its journey, diverting to another carrier or to a nearby land base. In fact, given an aerial refueling capability that extends its range to an astonishing 21,600 nm (conservatively—48 hours at 450-knot cruising speed), a flight of N-UCASs could take off from a carrier just leaving North Island Naval Air Station, San Diego, fly past Hawaii to the South Pacific, skirt the northern border of Australia, proceed past Diego Garcia in the Indian Ocean, and rendezvous with a tanker in the North Arabian Sea for a final run-in to military targets in the vicinity of Lop Nur. The literally tireless N-UCAS could then return to the North Arabian Sea, refueling once more, and fly south of Yemen and through the Red Sea to meet another carrier strike group in the eastern Mediterranean, where it would recover.⁴⁹⁵

While there are other and potentially more efficient ways to conduct a strike on targets as inaccessible as Lop Nur, the fact remains that a carrier armed with N-UCASs would be theoretically capable of launching strikes against targets located half a world away. Being able to launch long-range strikes from the sea would be especially helpful when an adversary was watching US land air bases for signs of impending strikes. In any case, the combination of a carrier's great global mobility with the extended endurance of the N-UCAS would give the US aircraft carrier fleet a degree of global reach, power, and persistence that no potential adversary could ignore. When operating in conjunction with stealthy Air Force long-range bombers and as part of a joint multidimensional battle network, N-UCASs could present an adversary with a formidable dilemma. The bigger the country, and the longer its borders, the less defensible it would be against this sort of one-two, long-range, networked punch, even with projected advances

⁴⁹⁵ Note that, given diplomatic clearance to refuel N-UCAS over Thailand or India, virtually the entire western Chinese frontier and the eastern coastline (including Beijing) would be open to an approach from the southwest, further complicating Chinese air defense plans. The air defense network required to hold a stealthy aircraft at risk over that broad an area would cause compelling tradeoffs in offensive systems.

in air defense capability. In other words, N-UCASs would make future air carriers a vital part of a true global surveillance-strike network, with enormous deterrent and warfighting implications.

XII. Preventing a Missed Opportunity

THE NAVY MOVES OUT

The Navy moved quickly to implement the QDR decision for a more focused development program on carrier-based unmanned air combat systems. In March 2006, the month after the QDR was published, the Navy directed Boeing Integrated Defense Systems and Northrop Grumman Corporation—the two companies that built the X-45 and X-47 demonstrators for the J-UCAS program—to extend their J-UCAS “bridge agreement” contracts through mid-2007, in preparation for a new UCAS-D competition. In late 2006, the Navy issued a Request for Proposal for an operationally relevant unmanned aircraft flight demonstrator with a tailless, low-observable (i.e., stealthy) platform that could be safely integrated into US Navy aircraft carrier flight deck operations. On April 2, 2007, the two teams submitted their responses.⁴⁹⁶ Only four months later, on August 2, the Navy awarded NGC a six-year, \$636 million contract to plan and execute the UCAS-D program. The contract called for Northrop Grumman to “...mature critical technologies, reduce unmanned air system carrier integration risks and provide information necessary to support a potential follow-on acquisition milestone.”⁴⁹⁷

When the contract was awarded, the Navy announced its plan to acquire an operational N-UCAS would include two principal phases: a critical technology maturation/demonstration phase, followed by an

⁴⁹⁶ Butler, “Let the Race Begin,” p. 34.

⁴⁹⁷ “U.S. Navy Awards \$635.8 Million UCAS-D Contract to Northrop Grumman-Led X-47 Team,” Northrop Grumman News Release, August 3, 2007, accessed online at http://www.irconnect.com/noc/press/pages/news_releases.html?d=124333 on August 15, 2007.

operational system acquisition phase. The most visible aspect of the first phase would be the carrier demonstration segment, which involves the building of two X-47B demonstration vehicles and at-sea tests to prove that unmanned air combat systems can effectively operate on the carrier and in carrier-controlled airspace. As now planned, the “new” X-47B will have slightly different performance parameters than those touted during the J-UCAS program. Its overall size will be the same as the earlier aircraft, with a carrier spot factor only .87 times that of an F/A-18C Hornet. However, the X-47B will have a slightly shorter planned unrefueled combat radius of 1,400 nm, and a higher planned operating ceiling of 40,000 feet.⁴⁹⁸

If all goes well, the X-47B’s first flight would occur in late 2009 or early 2010. After initial flight tests aimed at expanding their flight envelopes, the X-47Bs would then begin a series of land-based arrested landing tests, scheduled for early 2011, followed by the first sea trials in either the summer or fall of that year. The first “trap” (i.e., arrested landing) aboard a carrier at sea should occur in the summer of 2012. The entire demonstration phase was projected to be completed no later than the fourth quarter of Fiscal Year 2013.⁴⁹⁹

The \$636 million awarded to NGC for the UCAS-D program covers only development, flight tests, and sea trials of the X-47B demonstration vehicles, which will be less capable than any operational N-UCAS. For example, the X-47B’s aerodynamic design will take precedence over its shaping for low observability; to shave costs, the demonstration vehicles will lack the stealthiest, radar-defeating, S-shaped exhaust that would likely be found on an operational system.⁵⁰⁰ Moreover, federal law requires the Navy to reach a high level of readiness on all of the critical technology enablers for UCAS carrier and combat operations before the program can proceed to Milestone B (the acquisition phase).⁵⁰¹ Therefore, at the same time that the X-47Bs are being

⁴⁹⁸ “X-47 Carrier Compatibility: A Day in the Life.” The decrease in range is due to a new Navy fuel reserve requirement for several carrier approaches and a long-range divert. The actual performance of the air vehicle is unchanged.

⁴⁹⁹ Fulghum, Chavanne, and Butler, “Stealth at Sea.” p. 39.

⁵⁰⁰ *Ibid.*

⁵⁰¹ In technical terms, this means the program must demonstrate Technology Level 6 maturity before proceeding to full-scale development. See National Defense Authorization Act for Fiscal Year 2006, Public Law 109–163 (Section 801), accessed online at <http://www.dod.mil/dodgc/olc/docs/PL109-163.pdf> on March 18, 2008.

built and flown, the Navy will be supporting a parallel UCAS technology maturation effort, which could push the total value of the UCAS-D program to \$1.2 billion.⁵⁰²

Assuming that UCAS-D carrier suitability tests prove the viability of integrated manned and unmanned carrier deck and flight operations, and that all remaining technological hurdles are overcome, the Navy would then—after another competition—shift over to a formal systems development and demonstration (SDD) effort for an operational N-UCAS. The first production version of the system could well be significantly different from the X-47B demonstrator, and will certainly reflect knowledge gained during the demonstration program. Such an aircraft could be flying as early as 2018, although initial operational capability (i.e., the first squadron in service) would likely not be reached until FY 2020–2023.⁵⁰³ This is approximately eight years later than the planned IOC for the J-UCAS's ISR version.

A CONSERVATIVE APPROACH

Given its prompt action and plans, one might conclude that the Navy had finally enthusiastically embraced the idea of a mixed CVW containing both manned and unmanned aircraft. Upon closer examination, however, given the potential revolutionary impact that an operational N-UCAS is likely to have on future aircraft carrier operations, the plan suggests a different conclusion. For example, the UCAS-D program has been significantly scaled back from earlier plans developed by the J-UCAS office. During the demonstration phase, Northrop Grumman is expected only to demonstrate “carrier approach control operations, launch and recovery, deck operations and supportability.” As a result, its demonstration program is focused on operations on and in close proximity to the carrier, such as carrier catapult launches and arrested landings; operations inside carrier-controlled airspace; deck refueling and defueling; taxiing, towing, and maneuvering on and off the carrier's elevators; and mission planning and integration into CV information/communications systems. It will not demonstrate hangar deck operations or demonstrate the *operational* potential of N-UCAS. As such,

⁵⁰² Fulghum, Chavanne, and Butler, “Stealth at Sea,” p. 34.

⁵⁰³ “X-47 Carrier Compatibility: A Day in the Life.”

the demonstration program lacks such things as tests of autonomous, multi-UCAS strike operations or integrated manned-unmanned carrier strike packages.⁵⁰⁴

Similarly, the technology maturation phase does not include several obvious system requirements, such as automated aerial refueling, which is needed to take full advantage of the N-UCAS's great potential airborne endurance. The earlier J-UCAS program included an unmanned aircraft aerial refueling demonstration, but this task has been dropped from the UCAS-D program.⁵⁰⁵ Overall, the program's lack of an aerial refueling demonstration appears inconsistent with the guidance found in the 2006 QDR, which directed the Navy to "develop an unmanned longer-range carrier-based aircraft *capable of being air-refueled* to provide greater standoff capability, to expand payload and launch options, and to increase naval reach and persistence" (emphasis added).⁵⁰⁶

Adding these demonstrations in would not appear to be a major or costly addition to the test program. The X-47B demonstrator has provisions to allow boom-and-receptacle air-to-air refueling operations, and therefore conducting such a demonstration would be relatively simple. Indeed, in order to demonstrate boom-and-receptacle air-to-air refueling successfully, the X-47B would not actually need to receive fuel, only autonomously maintain position behind the tanker while the tanker performed its standard air refueling maneuvers. On the other hand, the Navy is relying on the Air Force Research Laboratory (AFRL) to deliver automated aerial refueling functionality for UCAS, and AFRL does not plan to develop Navy-style probe-and-drogue automated aerial refueling. The Navy should seriously consider funding dual-compatible (Navy and Air Force-style), automated aerial refueling demonstrations for UCAS to ensure that the operational system has access to the entire Air Force tanker fleet, and can also conduct contingency refueling operations around aircraft carriers.

The Navy's conservative and incomplete development plans for the N-UCAS perhaps suggests that the carrier community is reticent to fully embrace the new system. On one hand, this reticence is somewhat understandable. The carrier flight deck is arguably one of the most

⁵⁰⁴ See "NAVAIR Will Release Request for Proposals for UCAS Late Next Month," *Inside the Navy*, October 22, 2006; see also Butler, "Let the Race Begin," p. 51.

⁵⁰⁵ Fulghum, Chavanne, and Butler, "Stealth at Sea," p. 34.

⁵⁰⁶ *2006 QDR Report*, p. 46.

dangerous workplaces in the world, and the job of spotting, fueling, arming, launching, and recovering aircraft is a complex process requiring close teamwork and timing.⁵⁰⁷ As a result, many carrier aviators remain highly skeptical that unmanned air systems can be safely integrated into carrier operations, and insist that they “earn their way” aboard the ship.⁵⁰⁸ To many Navy carrier aviators, a simple naval UCAS demonstration focused on carrier flight deck and flight operations is thus the prudent way to go. As Rear Admiral Anthony Winns told *Seapower* magazine, “Carrier suitability is the Navy’s primary objective for the [new UCAS-D] program.” The admiral went on to say:

Can these vehicles take off and land on an aircraft carrier? We’ve never done that before with a vehicle shaped quite like these. It’s going to be a challenge, but we think that with the technology, with the full push by industry, we are going to be successful.⁵⁰⁹

This rather timid, less-than-certain development approach stands in stark contrast to the period between the two World Wars, when the Navy aggressively worked to integrate aircraft into naval operations. Then, the prevailing attitude seemed to be to prove why aircraft should *not* be taken to sea and incorporated into fleet operations. There was never any doubt in the minds of naval officers that aircraft would improve fleet operations in important ways. The only debate was over the best way to leverage the airplane’s new capabilities. Figuring out how to operate airplanes safely off of a heaving deck at sea was an important consideration, but one pursued with dogged determination and a willingness to take risks, since the payoff was deemed to be worth it. As a result, there was no talk about aircraft having to “earn their way” into fleet operations. Indeed, the Navy’s relentless determination to integrate airplanes into battle fleet tactics was never discouraged by the lack of proper ships, tactics, techniques, procedures, or even capable airplanes. The result, as seen in Chapter II, was no less than a revolution in naval warfare.⁵¹⁰ One has to wonder why the mere hint of a system with the great improvements in range, persistence, stealth, and

⁵⁰⁷ For a good, easy-to-understand discussion of carrier flight deck operations, see Clancy, *Carrier: A Guided Tour of an Aircraft Carrier*, pp. 107–115.

⁵⁰⁸ Butler, “Let the Race Begin,” p. 51; and Cortes, “Tomcat Transition to Super Hornet Complete by Fall ’06, Admiral Says,” p. 9.

⁵⁰⁹ Burgess, “Mother Ship.”

⁵¹⁰ The steely determination of fleet operators to take aircraft to sea is well captured in Hone, Friedman, and Mandeles, *American & British Aircraft Carrier Development 1919–1941*.

networking like the N-UCAS is not enough to spur calls for a far more aggressive program, designed to get an operational, multi-mission aircraft into the fleet sooner rather than later. As Admiral John Nathman, a retired four-star naval aviator, recently co-wrote: “While it’s still early, the Navy seems hesitant to make the logical connection between the UCAS and the return of a long-range strike role for the carriers. That’s unfortunate, because unmanned systems should be a big part of the next revolution in strike warfare.”⁵¹¹

A STEP FORWARD OR A STEP BACK?

More support for Admiral Nathman’s observation that the Navy seems hesitant to commit firmly in favor of a carrier-based unmanned combat air system may be found in the most recent update to the Navy’s long-range aviation planning guidance, *Navy Aviation Plan (NAVPLAN 2030) Guidance*, dated August 23, 2007 (the same month that the UCAS-D contract was awarded to Northrop Grumman Corporation). The guidance had this to say about the Navy’s long-range plans for N-UCAS:

Navy will complete the Navy Unmanned Combat Aircraft System (N-UCAS) carrier demonstration in 2013, to confirm the validity of operating a representative low observable platform in the carrier environment. The N-UCAS program will be refocused in POM-10 from a carrier-based penetrating, persistent ISR/Tactical Support Team Capability to a 6th generation strike-fighter capability that will recapitalize the F/A-18E/F [around] 2025. It will be renamed F/A-XX and will incorporate USMC Joint Program *and manned/unmanned decision points* in the Technical Development phase (emphasis added).⁵¹²

⁵¹¹ Rebecca Grant, Admiral John Nathman, USN (Ret.), and Loren Thompson, “Get the Carriers!” *Proceedings*, U.S. Naval Institute, September 2007, p. 41.

⁵¹² Vice Admiral J. W. Greenert, USN, “Navy Aviation Plan (NAVPLAN 2030) Guidance,” Department of the Navy Memorandum for Distribution, Office of the Chief of Naval Operations, August 23, 2007, pp. 4–5.

NAVPLAN 2030 was followed by a new *Naval Aviation Vision*, published in January 2008. This vision left little doubt that the Navy hoped the future F/A-XX would be a version of the N-UCAS. As the vision stated:

Future Carrier Air Wings (circa 2025) will be transitioning from a mix of F/A-18 and F-35 squadrons to a mix of F-35 and N-UCAS / F/A-18 squadrons. The mix will provide the Navy with the capability to conduct non-traditional ISR in denied access areas, initial SEAD [and Destruction of Enemy Air Defenses], and penetrating strike missions at reduced risk during the early phases of a campaign.⁵¹³

An optimist would say that the Navy's willingness to consider an unmanned carrier-based aircraft as an alternative for a future strike-fighter reflects a growing realization within the carrier aviation community of the bright future for unmanned aircraft. While that may be the case, the net result of this new guidance is that *the earliest* IOC for an N-UCAS-like system has slid even further into the future—a full decade later than originally planned. Moreover, it is by no means certain that an unmanned system will be able to accomplish all future required strike-fighter tasks, as indicated by the insertion of “manned/unmanned decision points” into the F/A-XX technical development phase. It seems just as likely that the Navy might opt for a manned strike-fighter. A pessimist thus might see *NAVPLAN 2030* and the new *Naval Aviation Vision* as simply another indication that the Navy is not fully committed to the N-UCAS.

WHAT'S THE PROBLEM?

What accounts for the Navy's apparent lack of enthusiasm over a system that could spark Admiral Nathman's “next revolution in strike warfare”? Unquestionably, the Navy's experience with unmanned aircraft stands at the top. The DASH and the Pioneer remain the only major operational unmanned aircraft systems ever used by the Navy on ships at sea, and neither proved to be a success. Some still remember the DASH as a

⁵¹³ Department of the Navy, *Naval Aviation Vision*, January 2008, accessed online at <http://www.cnaf.navy.mil/nae/content.aspx?AttachmentID=23> on April 28, 2008.

balky, unreliable, and ultimately failed system, while any support for Navy (as distinct from Marine) Pioneer operations evaporated with the final retirement of the World War II battleships. There is a significant residual degree of skepticism over the utility of unmanned aircraft operating from ships at sea.

The carrier community is perhaps the most skeptical naval community of all when it comes to unmanned systems. As a result, while the carrier community follows a plan that will not see unmanned aircraft incorporated into carrier operations until 2020, if then, the surface warfare community is actively pursuing the 21st century version of DASH—the MQ-8B Fire Scout—to operate off its planned fleet of Littoral Combat Ships. At the same time, the Navy’s maritime patrol community is planning to operate the large, land-based BAMS in conjunction with its new P-8 Poseidon multi-mission maritime aircraft, and the Marines and Navy Special Forces use UASs of various shapes and sizes for a variety of tasks. Even submariners are discussing how UASs might be used in littoral waters.

Moreover, the combat value of unmanned aircraft is no longer much debated. With operations of the RQ-4 Global Hawk UAS and the MQ-1 Predator and MQ-9 Reaper hunter-killer UASs over Afghanistan and Iraq, the Air Force demonstrates daily the ever-increasing combat power of unmanned aerial systems. As several experts note, given the vast improvements over unmanned systems since the days of DASH and Lightning Bug, “What’s surprising is that the Navy is taking a cautious attitude toward the potential for unmanned, long-range strike from carrier decks.”⁵¹⁴

Indeed, as early as 2004, the Defense Science Board concluded that there was “no longer any question about the technical viability and operational utility” of unmanned air systems, and operations appear to prove them right.⁵¹⁵ In 2005, after three overseas deployments, six RQ-4 prototype aircraft maintained a better than a 90 percent mission-capable rate during more than 180 missions and more than 4,000

⁵¹⁴ Ibid., pp. 38, 40.

⁵¹⁵ *Unmanned Aerial Vehicles and Unmanned Combat Air Vehicles* (Washington, DC: Defense Science Board, 2004), pp. ii–iv.

combat flight hours.⁵¹⁶ Moreover, these systems now routinely land autonomously within centimeters of runway centerline after day-long flights, in crosswinds and bad weather. For indefatigable robotic systems with inhuman courage and computer-backed flight control systems, autonomous carrier landings would appear to present little problem. In fact, in May 2007, pilots flying F/A-18F Super Hornets made hands-free autonomous approaches to within 137 meters of the deck of the aircraft carrier USS *Harry S. Truman*.⁵¹⁷ Can anyone really imagine that autonomous landings will be beyond the reach of future N-UCASs?

One has to wonder if the carrier community's skepticism over the N-UCAS goes beyond its unhappy earlier operational experience with unmanned systems. Referring to a much publicized article by retired Admiral Stansfield Turner, who called carriers "superfluous," three proponents of naval aviation wrote, "Maybe Admiral Turner was right. It's hard for military organizations to abandon familiar weapons systems—and to take on new ones." This oblique reference, one fully supported by Clay Christenson's research about disruptive innovations, refers to the aircraft that carrier aviators are now clearly the most comfortable with and anxious to get—the F-35C Lightning II (manned) Joint Strike Fighter. As discussed earlier, the F-35C will surely be a welcome addition to the CVW. While the F/A-18E/F Super Hornet now entering the fleet is claimed to have "an order of magnitude" more stealth than the earlier F/A-18C,⁵¹⁸ the newer F-35C will be the first true stealthy carrier aircraft, fulfilling the role first envisioned for the A-12 Avenger II in the 1980s. As a result, it will be the first plane ever to allow "a carrier air wing to operate on day one in an advanced air defense environment."⁵¹⁹ However, its range will be not much better than the long-retired A-6 Intruder, and because it will be a manned aircraft, its maximum mission endurance will be inherently limited. Therefore, while "The F-35 needs to be on the deck in significant numbers...it will not give the carrier all of the long range and persistence it needs."⁵²⁰

⁵¹⁶ "Northrop Grumman Global Hawk Team Efforts Recognized by U.S. Air Force," Northrop Grumman News Release, June 21, 2005, accessed online at http://www.irconnect.com/noc/press/pages/news_releases.html?d=80268 on September 20, 2007.

⁵¹⁷ Mark Daly, "Naval Unmanned Aerial Vehicles," *Jane's Defense Weekly*, August 1, 2007, p. 30.

⁵¹⁸ Tara Copp and Caitlin Harrington, "Super Hornet Delivers Its Sting," *Jane's Defense Weekly*, September 19, 2007, p. 28.

⁵¹⁹ Grant, Nathman, and Thompson, "Get the Carriers!" p. 40.

⁵²⁰ *Ibid.*

AT A COMPETITIVE DISADVANTAGE?

Despite the F-35C's deficiencies in long range and persistence, however, there are few vocal proponents for the N-UCAS among active naval aviators. This observation gets to the nub of the N-UCAS's biggest potential problem. As a true disruptive innovation, this unmanned system is perceived as a threat by the Navy's well-established and powerful *manned* tactical aviation community. Thus, up to this point, the N-UCAS has lacked any sort of a strong, clear advocate inside the Navy. As one analyst recently wrote:

The naval [UCAS] has several battles to fight and win, not the least of which may be natural conservatism on behalf of the Navy itself, leading to the reluctance to threaten manned carrier aircraft, or to disturb any planned procurement of the Lockheed Martin F-35B/C Joint Strike-fighter. No comprehensive naval requirement for [UCASs] has yet been laid out.⁵²¹

One of the best ways to overcome the Navy's "natural conservatism" might be for more and more retired naval aviators—those who are part of the carrier aviation fraternity but who are less constrained by institutional Navy positions—to come out strongly in favor of the N-UCAS. This may now be happening. Retired Admiral John "Black" Nathman, the aforementioned former head of Naval Aviation and commander of the Combined Fleet Forces Command, is one of the most vocal proponents of aircraft carriers the Navy has ever produced. His recent call for the carrier community to pursue a carrier-based unmanned aircraft more aggressively therefore carries much weight. He thinks that the N-UCAS gives the Navy "a chance...to do something it hasn't done for a long time: take the lead in the development of a highly innovative air weapon system."⁵²²

However, Admiral Nathman's ringing endorsement of the N-UCAS has yet to be echoed by the Navy's active-duty carrier aviation community. As a result, the aircraft is likely to remain at a competitive disadvantage in the annual budget deliberations at both OSD and the Department of the Navy levels for some time to come. As a disruptive technology, *any* unmanned combat air system is in constant danger of becoming a victim of what Jim Thomas, a former Deputy Assistant

⁵²¹ Daly, "Naval Unmanned Aerial Vehicles," p. 29.

⁵²² Grant, Nathman, and Thompson, "Get the Carriers!" p. 41.

Secretary of Defense for Strategy, refers to as “defense infanticide”—where established programs continually draw off the funds necessary to sustain promising new systems and eventually kill them.⁵²³ For example, Presidential Budget Decision 753, signed out before the 2006 QDR, reduced FY 2006 funding of the old J-UCAS program from \$745 million to \$350 million, and cut a billion dollars out of the Future Years Defense Program (FYDP). Then, after the J-UCAS program was cancelled and replaced by the UCAS-D program, the Senate Appropriations Committee (Defense) (SAC-D) zeroed the Navy’s \$239 million FY 2007 budget request, while the House Appropriations Committee (Defense) (HAC-D) cut the program by \$50 million. Although the conference funded the program at \$100 million, the resulting \$139 million cut in program funds caused a reorientation of the entire UCAS-D program. The principle result of the cut was to delay the target date for carrier demonstrations from 2011 to 2013, and to set back the start of a follow-on systems development and demonstration program to 2014.⁵²⁴ This caused the first big delay to the initial operational capability for a carrier-based unmanned combat air system.

The UCAS-D program fared much better in the FY 2008 budget cycle, with both the Senate and House endorsing full funding of the Navy’s request. However, given the other competing requirements facing Navy planners, how hard will carrier aviators fight for the UCAS-D program in the future if DoN aviation budgets are less than expected, or if they are faced with a choice of funding either the UCAS-D or another competing priority? If history is any guide, given the inattention to and lack of interest in unmanned systems within the carrier aviation community, the answer to this question is not likely to be encouraging. This seems especially true given that the new *NAVPLAN 2030* guidance now folds the N-UCAS program into a broader F/A-XX program, and slips the new program further into the future. This will make it far easier to shift the funds from the UCAS-D program in the face of sharp budget pressures over the next several years.

⁵²³ Jim Thomas, former Deputy Assistant Secretary of Defense for Strategy, at a CSBA-sponsored event on the Navy’s Unmanned Air Combat System Demonstration Program, Washington, DC, July 11, 2007.

⁵²⁴ From a discussion with Northrop Grumman’s N-UCAS office on July 11, 2007.

THE ROLE OF CONGRESS AND OSD

Indeed, only strong Congressional and OSD support will likely keep this disruptive innovation on track. Both institutions should be prepared to encourage, prod, and, if necessary, direct the Department of the Navy to continue fully funding the carrier demonstration program and its parallel technology maturation effort, and to resist slipping the program any further. By so doing, Congress and OSD would reprise the role they played in fielding the new conventional cruise missile and special operations transport submarines, now known as SSGNs. After the Nuclear Posture Review, the Ohio-class strategic ballistic missile submarine (SSBN) force was reduced from 18 to 14 boats. The “excess” Ohios had over two decades of service life remaining. OSD and Congress successfully argued that the Navy should convert the SSBNs into SSGNs over the vociferous counter-arguments of the Navy. Now, the Navy considers these boats to be among the most “transformational” platforms in the fleet.⁵²⁵

At a minimum, OSD and Congress should demand that the current demonstration program and technology maturation effort be fully funded, so as to prevent any further delays in the N-UCAS’s testing and development. Indeed, given the great potential of Navy UCASs, OSD and Congress should consider *accelerating* the demonstration program to “buy back” the two-year delay caused by previous program cuts. If the rapidly improving reliability and effectiveness of UASs like the Global Hawk and Predator and hands-free carrier approaches are any indication, the planned sea trials will most likely prove that unmanned aircraft can be safely integrated into a carrier air wing. If true, waiting until 2025 to *possibly* introduce them appears to undervalue the system’s great potential contribution to carrier operations. If the X-47B was deployed today, it would already be one of the most capable carrier aircraft ever—and it is only a *demonstrator* that uses extensive COTS technologies and a readily-available engine to reduce cost and risk. An operational N-UCAS would likely have even greater range and persistence, and offer even greater combat capability. Delaying its *potential* arrival until 2025 or later seems very hard to justify.

Some may argue against an expansion or acceleration of the program by pointing out that the N-UCAS is a “paper airplane” without

⁵²⁵ See, for example, “SSGN: A Transformational Force for the US Navy,” accessed online at http://www.navy.mil/navydata/cno/n87/usw/issue_13/ssgn.htm on March 18, 2008.

a single flight under its belt. But the same holds true for both the F-35B and C, and the Navy and Marines are more than willing to make concrete plans for their incorporation into future carrier air wings. By speeding up the UCAS-D program, OSD and Congress could ensure that both the N-UCAS and the carrier version of the JSF prove themselves and their design and cost goals at about the same time, providing an opportunity to judge the two systems more fully and equitably. This would allow for a more informed decision on the best mix of F/A-18E/Fs, F-35B/Cs, and operational N-UCASs in the Navy's future CVW.

The next step might be to *expand* the demonstration program and technology maturation effort to resolve any additional questions over the system's utility. At the very minimum, demonstrating an ability to refuel the N-UCAS safely and reliably from both Air Force and Navy tankers should be re-added to the demonstration effort. Recent developments make this a low-risk, high-payoff proposition. In November 2006, the Air Force Research Laboratory conducted a station-keeping flight test of a surrogate UAS in that succeeded in holding a proper refueling position behind a KC-135 Stratotanker boom for 23 consecutive minutes.⁵²⁶ More importantly, at least from the Navy's perspective, DARPA recently completed its Autonomous Airborne Refueling Demonstration (AARD), which proved that unmanned aircraft could perform autonomous in-flight probe-and-drogue refueling under operational conditions. Using an F/A-18 testbed flown "hands off" and controlled by precise inertial, GPS, and video measurements, and advanced guidance and control methods, DARPA demonstrated that an unmanned aircraft could easily plug into a 32-inch drogue refueling basket trailing behind a tanker, even during turns. The AARD also demonstrated refueling in turbulent conditions, with peak-to-peak drogue motions of up to five feet—near the limit of manned refueling operations. One NASA test pilot characterized the final AARD software configuration as being "better than a skilled pilot."⁵²⁷ By including this capability on the demonstration program, the carrier community would be provided a much better glimpse of the potential combat multiplier effect of aircraft unconstrained by human endurance.

⁵²⁶ "AFRL Completes Automated Aerial Refueling Station-Keeping Flight Test," AFRL/XP, accessed online at http://www.wpafb.af.mil/news/story_print.asp?id=123034903 on March 29, 2007.

⁵²⁷ "DARPA Completes Autonomous Airborne Refueling Demonstration," Defense Advanced Research Project Agency News Release, August 9, 2007, accessed online at <http://www.darpa.mil/body/news/2007/aard.pdf> on September 15, 2007.

Next, an expanded demonstration program should aim to allay lingering fears about the vulnerability of air systems of all kinds in a combat environment. For example, Owen Cote worries about the vulnerability created by the requirement for data links that connect the N-UCAS to human operators.⁵²⁸ It is certainly true that reliable communications are critical if N-UCASs are to operate effectively as part of future naval and joint multidimensional battle networks. However, this is not a requirement unique to unmanned systems. *All* next-generation combat aircraft, manned or unmanned, will require extremely high levels of connectivity to operate as components in planned future battle networks. In fact, high-bandwidth, jam-resistant connectivity is one of the F-35's most important capabilities. The UCAS-D program could easily be modified to demonstrate the reliability of its own long-range data links in a contested environment and in the face of jamming, electronic attack, and deception.

Finally, even if the UCAS-D program conclusively proves that the UCAS can be safely operated aboard carriers, can be refueled, and can be reliably controlled, some will undoubtedly continue to disbelieve that N-UCASs can perform much more than penetrating ISR missions, or that “[N-UCASs] can perform their expected missions better than manned aircraft in high-threat and high-risk environments.”⁵²⁹ Unquestionably, having operated only non-stealthy, manned tactical reconnaissance aircraft in the past, a future carrier air wing would definitely benefit from having a stealthy, long-range, and persistent, penetrating ISR platform. As one analyst noted, “Persistent surveillance, whether manned or unmanned, land or sea-based, is the foundation for success in all mission areas in the new security environment.”⁵³⁰ However, to envision the N-UCAS as solely or even primarily a penetrating or persistent ISR platform detracts from its equally important potential as a persistent, multi-role, surveillance-strike system.

Accordingly, expanded demonstration and technology maturation programs could be structured to highlight the longer-term *multi-mission* potential of the N-UCAS. The aircraft could be reconfigured to demonstrate a wider variety of payloads than now being considered, including AMRAAMs, NCADES, torpedoes, mines, auxiliary “buddy” store fuel tanks, High-Speed Anti-Radiation missiles, jamming

⁵²⁸ Cote, *The Future of Naval Aviation*, p. 29.

⁵²⁹ Lambeth, *American Carrier Air Power at the Dawn of a New Century*, pp. 93–94.

⁵³⁰ Cote, *The Future of Naval Aviation*, p. 12.

packages, communications relay packages, and multi-phenomenology sensors. That would allow the N-UCAS to demonstrate some of the missions suggested in the previous chapter, such as air-to-air warfare, anti-submarine warfare, anti-surface warfare, BMD, suppression of enemy air defenses, maritime patrol aircraft escort, and deep strike. The more N-UCAS missions demonstrated under a variety of realistic conditions, the greater the likelihood that the system will gain more champions.

There are several additional steps that could be taken to improve the X-47B's contribution to the technology maturation effort. For example, the Navy removed the requirement to demonstrate advanced sensors originally included in the J-UCAS demonstration program. The integration of powerful, capable sensors (such as the AESA radar) into relatively small airframes is necessary if an operational N-UCAS is to fulfill its essential role as a persistent surveillance-strike system. Additionally, further research into automated target recognition and automated sensor fusion would reduce the need for off-board processing and thus reduce bandwidth requirements. New miniaturized kinetic weapons and directed energy weapons would increase magazine depth, thereby enhancing combat persistence in the strike role. Lastly, an investment in advanced propulsion systems such as the Air Force Research Laboratory's Adaptive Versatile Engine Technology (ADVENT) program might reduce an operational system's fuel consumption and increase both its unrefueled range and endurance.⁵³¹ Many of these technology research areas would benefit not merely N-UCASs but potentially all other UASs and manned aircraft.

Finally, even if the N-UCAS proves to be more difficult to integrate into a CVW than expected, the Navy could still operate all-N-UCAS air wings. As mentioned earlier in this report, although the Navy's recently published long-term shipbuilding plan shows that the fleet will have a twelfth aircraft carrier after FY 2019, there are as yet no plans to stand up an eleventh active carrier air wing to equip the ship.⁵³² The Navy might start planning to give this "spare" carrier an all-N-UCAS CVW. A CVN operating six 12-plane squadrons would be a powerful addition to any future Carrier Strike Force. Such a carrier should be able

⁵³¹ Larine Barr, "Air Force plans to develop revolutionary engine," Air Force Research Laboratory Public Affairs, March 27, 2007, accessed online at <http://www.af.mil/news/story.asp?id=123046410> on May 1, 2007.

⁵³² OPNAV N8F, "Report to Congress on Annual Long-Range Plan for Construction of Naval Vessels for FY 2008" (Washington, DC: Office of the Chief of Naval Operations, February 2007), p. 6.

to sustain 30 persistent surveillance strike CAPs at ranges up to 3,250 nm from the carrier; 36 CAPs at ranges up to 1,750 nm from the carrier; or 42 CAPs at ranges up to 500 nm from the carrier. A “deck-load strike” of 50 N-UCASs could deliver 600 SDBs against a target area, even one defended by advanced air defenses. Experiments with an all-N-UCAS wing could result in a different mix of fleet carriers, such as four three-carrier Carrier Strike Forces, with two manned- and one all-N-UCAS airwing. Or, they might point the way toward smaller carriers optimized for unmanned operations, opening the way for a more distributed unmanned aviation capability in fleet operations like the one developed during World War II. The point here is that there are many potential ways to exploit N-UCASs, provided adequate development is pursued to make them reliable and effective.

N-UCAS: A NEW REVOLUTION IN CARRIER AVIATION?

The US Navy—and the nation—benefit greatly from having a large-deck carrier aviation force. Since World War II, the great freedom of action and operational flexibility these mobile floating airfields provide national leaders and the Joint Force have been proven time and again. However, due to the limitations inherent in operating high-performance aircraft off of a relatively small deck area, the limits of contemporary technology, and the observed operational demands for sea-based aviation, US carrier air wings have gradually been optimized for relatively short-range tactical aircraft operations. Consequently, US aircraft carriers have evolved into operational strike systems with outstanding global mobility but relatively limited tactical reach and persistence.

This evolutionary outcome is perhaps understandable. The carrier air wing’s relative lack of range and persistence posed little problem in the past. Since the end of World War II, aircraft carriers have generally operated from relatively secure operational sanctuaries close off the coasts of US adversaries. Only when faced by the Soviets’ maritime anti-access/area-denial network, which enjoyed a great relative advantage in strike reach, did the CVW’s lack of range and endurance cause a substantial problem. Now, however, a range of emerging 21st century defense challenges—including defending the homeland in depth, fighting against radical extremists and terrorist networks, preparing for a range of WMD elimination operations, and hedging against the

**Figure 15: N-UCAS: A New Revolution
in Carrier Aviation?**



appearance of more lethal maritime reconnaissance-strike complexes—all strongly suggest that a carrier air wing best suited for operations over ranges between 200 and 600 nm may no longer be adequate. Indeed, all suggest a growing operational demand for greatly improved CVW **range, persistence, stealth, and networking.**

A promising potential means to meet these higher demands is at hand. The N-UCAS's unique combination of great unrefueled range and dramatically improved endurance and stealth translate into lasting battlespace persistence, under foreseeable combat conditions. Moreover, its ability to operate as part of a future joint multidimensional battle network will greatly expand the offensive and defensive options of future joint commanders. As a result, the N-UCAS has the potential to spark a new carrier revolution—a revolution that could transform US aircraft carriers and their embarked air wings into key components of a persistent global surveillance-strike network effective across multiple 21st century security challenges.

This revolution is not preordained. Because the N-UCAS is a classic disruptive innovation, the system must overcome an entrenched bureaucracy and disprove a host of doubts and doubters. At a minimum, to give this system a fighting chance, Congress and the Office of the Secretary of Defense should continue to fully fund the N-UCAS carrier demonstration program and its associated technology maturation effort to ensure that it will not be further delayed. They might also consider speeding up the demonstration program and expanding the technology maturation effort to better demonstrate the N-UCAS's great potential, and to gain additional champions for the system. If they do, the future combat relevance of the US carrier force—a force that helps to separate the US Navy from all other navies in the world and helps to provide the United States with enormous global freedom of action—will likely be assured.

Glossary

A2/AD	Anti-Access/Area-Denial
AADCCS	Area Air Defense Command Capability System
AAW	Anti-Aircraft Warfare
AESA	Active Electronically Scanned Array
AEW	Airborne Early Warning
AFRL	Air Force Research Laboratory
AIM	Advanced Induction Motor
AMRAAM	Advanced Medium-Range Air-to-Air Missile
ASAT	Anti-Satellite
ASBM	Anti-Ship Ballistic Missile
ASCM	Anti-Ship Cruise Missile
ASW	Anti-Submarine Warfare
BAMS	Broad Area Maritime Surveillance
BMD	Ballistic Missile Defense
C3I	Command, Control, Communications, and Intelligence
CAP	Combat Air Patrol
CCP	Chinese Communist Party
CEC	Cooperative Engagement Capability
CG	Guided-Missile Cruiser
CMC	Chinese Central Military Commission
CNO	Chief of Naval Operations
CSF	Carrier Strike Force
CSG	Carrier Strike Group
CV	Aircraft Carrier
CVE	Escort Carrier
CVL	Light Aircraft Carrier

CVN	Nuclear-Powered Aircraft Carrier
CVW	Carrier Air Wing
DARPA	Defense Advanced Projects Research Agency
DASH	Drone Antisubmarine Helicopter
DDG	Guided-Missile Destroyer
DoD	Department of Defense
DoN	Department of the Navy
DSP	Defense Support Program
ELINT	Electronic Intelligence
EMP	Electromagnetic Pulse
EORSAT	Electronic Intelligence Ocean Reconnaissance Satellite
ESA	Electronically Scanned Array
FLD	Full Load Displacement
FRP	Fleet Response Plan
FY	Fiscal Year
GIUK	Greenland-Iceland-United Kingdom
GPS	Global Positioning System
GWOT	Global War on Terror
HF	High Frequency
IADS	Integrated Air Defense System
IOC	Initial Operational Capability
ISR	Intelligence, Surveillance, and Reconnaissance
JCS	Joint Chiefs of Staff
JDAM	Joint Direct Attack Munition
JSF	Joint Strike Fighter
LACM	Land-Attack Cruise Missile
LAMPS	Light Airborne Multipurpose Systems
LHA	Amphibious Assault Ship
MDA	Missile Defense Agency
MMA	Multi-Mission Maritime Aircraft
MRC	Major Regional Contingency
NATO	North Atlantic Treaty Organization
NCADE	Network-Centric Airborne Defense Element

NGC	Northrop Grumman Corporation
NIFC-CA	Naval Integrated Fire Control-Counter Air
nm	Nautical Miles
N-UCAS / UCAS-N	Naval Unmanned Combat Air System
OEF	Operation Enduring Freedom
OIF	Operation Iraqi Freedom
OSD	Office of the Secretary of Defense
PLA	People's Liberation Army
PLAAF	People's Liberation Army Air Force
PLAN	People's Liberation Army Navy
PLANAF	People's Liberation Army Navy Air Force
PRC	People's Republic of China
QDR	Quadrennial Defense Review
RATO	Rocket-Assisted Take-Off
RFP	Request for Proposal
RORSAT	Radar Ocean Reconnaissance Satellite
SAG	Surface Action Group
SAM	Surface-to-Air Missile
SAR	Synthetic-Aperture Radar
SDB	Small Diameter Bomb
SEAD	Suppression of Enemy Air Defenses
SF	Strike-Fighter
SLBM	Submarine-Launched Ballistic Missile
SM	Standard Missile (US Naval SAM)
SM-3	Standard Ballistic Missile Interceptor
SOSUS	Sound Surveillance System
SSBN	Nuclear-Powered Strategic Ballistic Missile Submarine
SSGN	Nuclear-Powered Cruise Missile/Special Operations Transport Submarine
SSN	Nuclear-Powered Attack Submarine
STOVL	Short Take-Off and Vertical Landing
TBM	Tactical Ballistic Missile

TFBN	Total Force Battle Network
TLAM	Tomahawk Land-Attack Missile
TSBF	Total Ship Battle Force
UAS	Unmanned Aircraft System
UAV	Unmanned Aerial Vehicle
UCAS	Unmanned Combat Air System
UCAS-D	Unmanned Combat Air System Demonstration
UCAS-N / N-UCAS	Naval Unmanned Combat Air System
UHF	Ultra-High Frequency
VLS	Vertical Launch System
VTOL	Vertical Take-Off and Landing
WMD	Weapons of Mass Destruction



**Center for Strategic
and Budgetary
Assessments**

1667 K Street, NW
Suite 900
Washington, DC 20006
Tel. 202-331-7990
Fax 202-331-8019
www.CSBAonline.org