

**AGES 5+**  
87627/87628 Asst.

**STAR  
WARS**

THE CLONE WARS



Clone Trooper™ Voice Changer

 **x3** 1.5V AA/R6 size  
**BATTERIES INCLUDED**

Replace with 3 x 1.5V "AA" or R6 size batteries. Alkaline batteries recommended. Phillips/cross head screwdriver (not included) needed to replace batteries.

**IMPORTANT! PLEASE READ INSTRUCTIONS  
COMPLETELY BEFORE WEARING TOY.**



Product and colors may vary.  
© 2007 Lucasfilm Ltd. & © or TM where indicated. All rights reserved.  
®\* and/or TM\* & © 2007 Hasbro. All Rights Reserved.  
®\* TM & © denote U.S. Trademarks.

P/N 6779630000

## ASSEMBLY & STRAP ADJUSTMENT



Adjust straps to fit child's head. Straps can be readjusted once they are attached to helmet. To adjust, lift straps off posts, slide straps to desired position, and press straps onto posts.

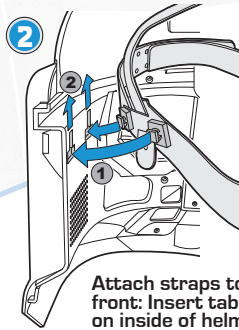

Attach straps to helmet front: Insert tabs into holes on inside of helmet and slide up towards top of helmet. Make sure all four mounting points are secure.

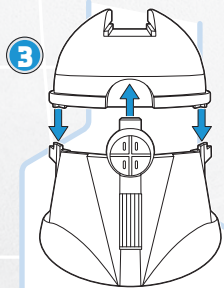

Attach upper and lower halves of helmet back.

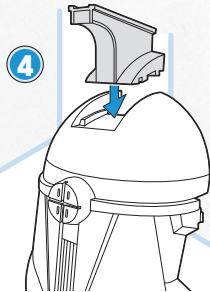

Attach crest to helmet back.

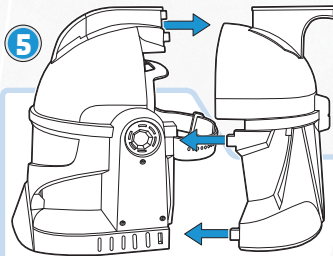

Attach helmet back to helmet front.

## WEARING HELMET

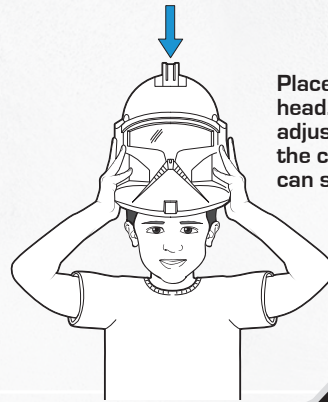

Place helmet straight down on head. Make sure the straps are adjusted to keep it steady on the child's head so your child can see through the eyes.

## BUTTONS

The helmet comes packaged in a "try me" mode. Move switch from "Try Me" position to "On" position for full activation of features.

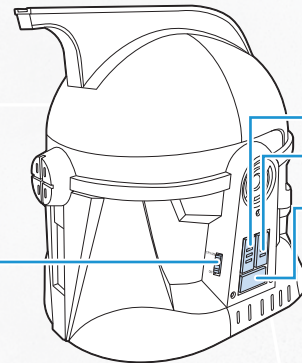

Clone Trooper Commands Button

Clone Trooper Phrases Button

Radio Static Button/Voice Amplifier

Power

When helmet is not in use, slide switch to "Off" to help conserve battery life.



## BUTTONS (CONTINUED)

**Radio Static Button:** Wearing the helmet, press the button to activate radio static sounds and voice amplification. Speak your own commands to create realistic-sounding clone trooper radio "chatter."

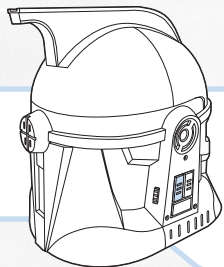
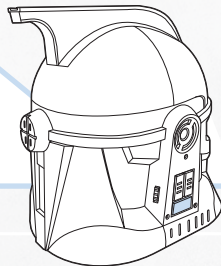

**Clone Trooper Commands Button:** Wearing the helmet, press the button to hear clone trooper commands from *Star Wars* entertainment. The commands are:  
Green light! Go! Go! Go!  
All forward positions are advancing.  
Come on, hurry, hurry!  
Get ready to turn those clankers into scrap metal.  
Cover me.  
All units, fire at will!  
We've got you outnumbered.

**Clone Trooper Phrases Button:** Wearing the helmet, press the button to hear clone trooper phrases from *Star Wars* entertainment. The phrases are:  
Roger that, sir.  
I'm on my way.  
I've got a bad feeling about this, sir.  
The mission always comes first, sir.  
Gunships are holding at a safe distance.  
The droid army is in full retreat.  
All clear, General.  
Sir, we're taking heavy fire.

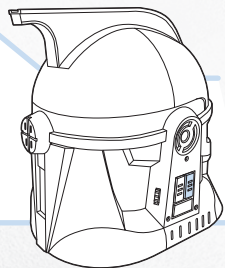

## TO REPLACE BATTERIES

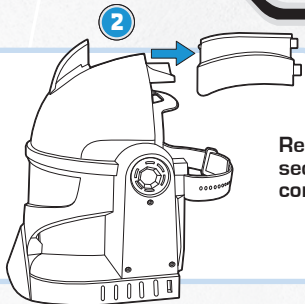
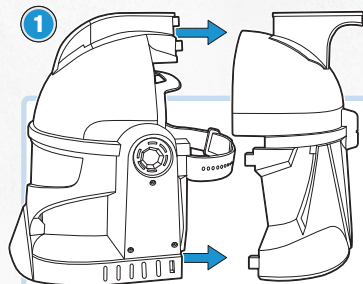

Remove crest section over battery compartment door.

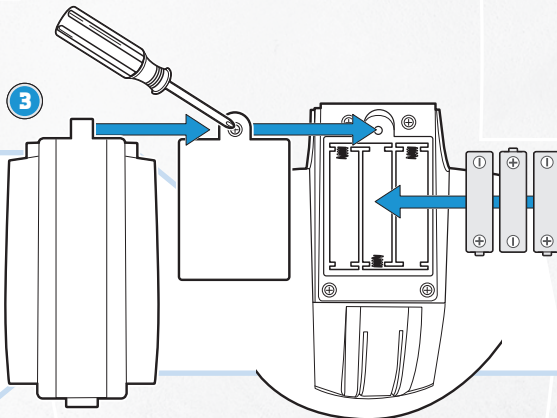

Loosen screw in battery compartment door with a Phillips/cross head screwdriver (not included). Remove door. Remove and discard batteries. Insert 3 x 1.5V "AA" or R6 size batteries. Alkaline batteries recommended. Replace door, and tighten screw. Re-attach crest to helmet.



## CAUTION: TO AVOID BATTERY LEAKAGE

1. Be sure to insert the batteries correctly and always follow the toy and battery manufacturers' instructions;
2. Do not mix old and new batteries or alkaline, standard (carbon-zinc) or rechargeable (nickel-cadmium) batteries;
3. Always remove weak or dead batteries from the product.

### IMPORTANT: BATTERY INFORMATION

Please retain this information for future reference.  
Batteries should be replaced by an adult.



## CAUTION:

1. Always follow the instructions carefully. Use only batteries specified and be sure to insert them correctly by matching the + and - polarity markings.
2. Do not mix old batteries and new batteries, or standard (carbon-zinc) with alkaline batteries.
3. Remove exhausted or dead batteries from the product.
4. Remove batteries if product is not to be played with for a long time.
5. Do not short-circuit the supply terminals.
6. Should this product cause, or be affected by, local electrical interference, move it away from other electrical equipment. Reset (switching off and back on again or removing and re-inserting batteries) if necessary.
7. RECHARGEABLE BATTERIES: Do not mix these with any other types of battery. Always remove from the product before recharging. Recharge batteries under adult supervision. DO NOT RECHARGE OTHER TYPES OF BATTERIES.

### FCC Statement:

This equipment has been tested and found to comply with the limits for a Class B digital device, pursuant to part 15 of the FCC Rules. These limits are designed to provide reasonable protection against harmful interference in a residential installation. This equipment generates, uses and can radiate radio frequency energy, and, if not installed and used in accordance with the instructions, may cause harmful interference to radio communications. However, there is no guarantee that interference will not occur in a particular installation. If this equipment does cause harmful interference to radio or television reception, which can be determined by turning the equipment off and on, the user is encouraged to try to correct the interference by one or more of the following measures:

- Reorient or relocate the receiving antenna.
- Increase the separation between the equipment and receiver.
- Consult the dealer or an experienced radio/TV technician for help.

CAUTION: Changes or modifications not expressly approved by the party responsible for compliance could void the user's authority to operate the equipment.