



OFFICE OF THE PRIME MINISTER

Department of Protocol

THE ITALIAN HONOURS PROCEDURE

THE RULES OF PROTOCOL REGARDING NATIONAL HOLIDAYS
AND THE USE OF THE ITALIAN FLAG

Alessandra Malesci Baccani
Department of Protocol
Presidency of the Council of Ministries
Office of the Knighthood of Honours

INDEX

PRIME MINISTERIAL CIRCULAR OF 30 OCTOBER 2001

CIVIL KNIGHTHOODS AND HONOURS OF THE ITALIAN REPUBLIC
WEARING THE INSIGNIA OF THE ORDER OF MERIT OF THE ITALIAN REPUBLIC
WEARING THE INSIGNIA OF THE ORDER OF THE ITALIAN SOLIDARITY STAR
ORDER OF PRECEDENCE

ORDER OF MERIT OF THE ITALIAN REPUBLIC

INSIGNIA
TECHNICAL TABLES

ORDER OF THE ITALIAN SOLIDARITY STAR

INSIGNIA

PRIME MINISTERIAL CIRCULAR OF 22 MARCH 2002

ROSETTES FOR CIVIL HONOURS OF THE REPUBLIC
ICONOGRAPHIC TABLE OF CIVIL HONOURS OF THE REPUBLIC

PRIME MINISTERIAL CIRCULAR OF 15 OCTOBER 2001

NATIONAL HOLIDAYS

LAW No. 22 of 5 FEBRUARY 1998

GENERAL RULES GOVERNING THE USE OF THE FLAGS OF THE ITALIAN REPUBLIC AND THE EUROPEAN UNION

DECREE OF THE PRESIDENT OF THE REPUBLIC OF 7 APRIL 2000

GOVERNMENT REGULATION ON THE USE OF THE FLAGS OF THE ITALIAN REPUBLIC AND THE EUROPEAN UNION BY GOVERNMENT DEPARTMENTS AND AGENCIES

**ALL THE IMAGES ARE REPRODUCED BY THE KIND PERMISSION GRANTED BY THE EDITOR OF THE BOOK
'VESTIRE GLI ONORI', IN.EDIT SRL EDITIONS**

PRIME MINISTERIAL CIRCULAR
30 OCTOBER 2001

CIVIL KNIGHTHOODS AND HONOURS OF THE ITALIAN REPUBLIC
WEARING THE INSIGNIA OF THE ORDER OF MERIT OF THE ITALIAN REPUBLIC
WEARING THE INSIGNIA OF THE ORDER OF THE STAR OF ITALIAN SOLIDARITY
ORDER OF PRECEDENCE

PRIME MINISTERIAL CIRCULAR

30 OCTOBER 2001

CIVIL KNIGHTHOODS AND HONOURS OF THE ITALIAN REPUBLIC
WEARING THE INSIGNIA OF THE ORDER OF MERIT OF THE ITALIAN REPUBLIC
WEARING THE INSIGNIA OF THE ORDER OF THE STAR OF ITALIAN SOLIDARITY
ORDER OF PRECEDENCE

1. CIVIL KNIGHTHOODS AND HONOURS OF THE ITALIAN REPUBLIC

The Republic rewards individual and collective meritorious service by conferring membership of national Orders of **Knighthoods** and Honours (Decorations, Awards, Medals).

The President of the Republic is the Head of the National Orders of **Knights** and confers the knighthoods and honours referred to in this Circular. The circular does not regulate exclusively military Orders of **Knighthoods**, distinctions and honours, or distinctions awarded by individual State awarding authorities.

Members of Orders of **Knighthoods** and awardees of Honours of the Republic may use their titles in public.

The insignia of the Orders of **Knighthoods** and Honours of the Republic may be freely worn according to the rules laid down for this purpose. The insignia is normally required to be worn on national holidays in the presence of the President of the Republic at official civil or military ceremonial events.

The Order of Merit of the Italian Republic is the highest of the National Orders of **Knighthoods**.

Each Government Department shall organise central and local level ceremonies for the awarding of the diplomas and scrolls issued by the Chancellor of the Order of Merit of the Italian Republic to their civil servants honoured during the course of the year. These forms of conferral may also take place during the course of celebrations on Italian Republic Day.

The Heads of Italian diplomatic and consular missions shall arrange for similar ceremonial events to be held for the conferral of membership of Orders of **Knights** and honours on Italian Nationals resident abroad and on foreign nationals, in coordination with their respective Italian communities.

The insignia for Italian Orders of **Knighthoods** shall be made in strict compliance with the technical prescriptions set out in the tables annexed to this Circular (see page 43). They shall be certified as appropriate by the Prefects of the Regional Government Offices, and by the Department of State Ceremonial Protocol - Honours and Heraldry Office - at the Office of the Prime Minister.

The use of rosettes or other insignia which differ from those prescribed in this Circular in terms of dimension or material is prohibited.

1.1. NATIONAL KNIGHTHOODS ORDERS

The National **KNIGHTHOODS** Orders are listed below by date of institution or renewal under the Republic:

THE MILITARY ORDER OF ITALY

Renewed by Decree of the Provisional Head of State No. 4(1) of January 2nd 1947, effective since January 1st 1947, and Law No 25 of January 9th 1956.

The first Decree Law changed the original name of the Military Order of Savoy, founded under Letters Patent of August 14th 1815, renewed by Royal Decree on September 27th and March 28th 1857. It is awarded to Units of the Italian Armed Forces units and individual Italian or foreign military personnel.

There are five classes:

Knight Grand Cross
Grand Officer
Commander
Officer
Knight

ORDER OF THE STAR OF ITALIAN SOLIDARITY

Instituted by Decree Law of the Provisional Head of State No 703 of January 27th 1947, amended by Decree Law No. 812 of March 9th 1948; with new insignia instituted by Presidential Decree of September 21st 2001. It is conferred on Italians living abroad and foreign nationals, civilian and military.

There are three classes:

1st Class (Grand Officer)
2nd Class (Commander)
3rd Class (Knight)

ORDER OF MERIT OF THE ITALIAN REPUBLIC

Instituted by Law No. 178 of March 3rd 1951 with the insignia modified by Presidential Decree No. 173 of March 30th 2001. It may be conferred on Italian and foreign civilians and military personnel.

There are five classes:

Knight Grand Cross
Grand Officer
Commander
Officer
Knight.

In exceptionally meritorious cases, the Knight Grand Cross may also be awarded the Grand Collar.

THE ORDER OF MERIT FOR LABOUR

Renewed by Law No. 199 of March 27th 1952, and most recently modified by Law No. 194 of May 15th 1986. It was instituted by Royal Decree on May 9th 1901 which transformed the earlier decoration for "Merits for Agriculture and Industry" and the "Medal of Honour for Outstanding Services to Agriculture, Industry and Commerce" created by Royal Decree on March 1st 1898 into an Order of **Knighthood**. It is conferred on Italian citizens.

It comprises one rank of **Knight of Labour**.

THE ORDER OF VITTORIO VENETO

Instituted by Law No.263 of March 18th 1968 to award combatants in the 1915-1918 war and earlier wars, who were holders of War Merit Cross or who were then eligible to obtain one.
It comprises one rank of **Knight of Vittorio Veneto**.

1.2 CIVIL DISTINCTIONS AND HONOURS

The civil distinctions and honours of the Republic, which also include military distinctions and honours that are conferrable on civilians, local authorities, associations and institutions, are the following:

DECORATIONS:

MEDAL OF MILITARY VALOUR

It is subdivided into:
Gold Medal
Silver Medal
Bronze Medal
Cross

STAR OF LABOUR MERIT

It comprises one class and confers the title of *Maestro of Labour*

AWARDS

(Listed in order of institution or Republican renewal)

MEDAL OF OUTSTANDING MERIT FOR SERVICES TO PUBLIC HEALTH

It is subdivided into:
Certificate of Merit, 1st class, equivalent to a Gold Medal
Certificate of Merit, 2nd class, equivalent to a Silver Medal
Certificate of Merit, 3rd class, equivalent to a Bronze Medal

MEDAL FOR SERVICE TO PUBLIC HEALTHCARE

It is subdivided into:
Certificate of Merit, 1st Class, equivalent to a Gold Medal
Certificate of Merit, 2nd Class, equivalent to a Silver Medal
Certificate of Merit, 3rd Class, equivalent to a Bronze Medal

MEDAL OF OUTSTANDING MERIT FOR SERVICES TO EDUCATION, CULTURE AND ART

It is subdivided into:
Certificate of Merit, 1st Class, equivalent to a Gold Medal
Certificate of Merit, 2nd Class, equivalent to a Silver Medal
Certificate of Merit, 3rd Class, equivalent to a Bronze Medal

MEDAL OF OUTSTANDING MERIT FOR SERVICES TO CULTURE AND ART

It is subdivided into:

Certificate of Merit, 1st Class, equivalent to a Gold Medal
Certificate of Merit, 2nd Class, equivalent to a Silver Medal
Certificate of Merit, 3rd Class, equivalent to a Bronze Medal

MEDAL OF OUTSTANDING MERIT FOR SERVICES TO SCIENCE AND CULTURE

It is subdivided into:

Certificate of Merit, 1st Class, equivalent to a Gold Medal
Certificate of Merit, 2nd Class, equivalent to a Silver Medal
Certificate of Merit, 3rd Class, equivalent to a Bronze Medal

MEDAL OF OUTSTANDING MERIT FOR SERVICES TO PUBLIC FINANCE

It is subdivided into:

Certificate of Merit, 1st Class, equivalent to a Gold Medal
Certificate of Merit, 2nd Class, equivalent to a Silver Medal
Certificate of Merit, 3rd Class, equivalent to a Bronze Medal

There is also an annual Prize of 1 million lire for an Italian author whose works or writings published in the previous two-year period have made the most original contribution to studies of public finance.

MEDAL OF OUTSTANDING MERIT FOR SERVICES TO ELEMENTARY AND PRE-SCHOOL EDUCATION

It is subdivided into:

Certificate of Merit, 1st Class, equivalent to a Gold Medal
Certificate of Merit, 2nd Class, equivalent to a Silver Medal
Certificate of Merit, 3rd Class, equivalent to a Bronze Medal

MEDAL FOR FORTY YEARS OF OUTSTANDING SERVICE TO ELEMENTARY SCHOOLS

It is subdivided into:

Certificate of Merit, 1st Class, equivalent to a Gold Medal
Certificate of Merit, 2nd Class, equivalent to a Silver Medal
Certificate of Merit, 3rd Class, equivalent to a Bronze Medal

MEDAL OF CIVIL MERIT

Subdivided into:

Gold Medal
Silver Medal
Bronze Medal

The Ministry of Home Affairs can also award a Certificate of Outstanding Public Merit

MEDAL OF CIVIL VALOUR

Subdivided into:

Gold Medal
Silver Medal
Bronze Medal

The Ministry of Home Affairs can also award a Certificate of Outstanding Public Merit

MEDAL OF VALOUR AND MERIT TO THE NAVY CORP

It is subdivided;

For Acts of Naval Valour into:

Gold Medal for Naval Valour
Silver Medal for Naval Valour
Bronze Medal for Naval Valour
There is also a Special Mention by the Minister of Defence

For undertakings, studies and actions demanding outstanding expertise into:
Gold Medal for Naval Merit
Silver Medal for Naval Merit
Bronze Medal for Naval Merit

ARMY MERIT CROSS

It is for undertakings, studies and actions demanding outstanding expertise, divided into:
Gold Cross of Army Merit
Silver Cross of Army Merit
Bronze Cross of Army Merit

MEDALS

LONG SERVING NAVAL COMMAND MEDAL

Subdivided into
1st Class (gold) for 20 years' service
2nd Class (silver) for 15 years' service
3rd Class (bronze) for 10 years' service

2. FEATURE OF THE INSIGNIA OF THE ORDER “MERIT OF THE ITALIAN REPUBLIC”

The Presidential Decree March 30th 2001 n. 173 had modified and renewed the feature of the Insignia of the Order “Merit of the Italian Republic”, though allowing the use of the previous Insignia.

The ribbon of the Order “Merit of the Italian Republic” is green, with two red stripes at each border.

A)

The Insignia of 1st Class (Knight of Great Cross) consist of:

1-The 52mm round Cross enamelled in white, bordered with gold, with two golden yielded olive and oak twigs, in a circle. The cross has a gold round shield in the centre, which is bordered in sky blue, carrying in the back the gold emblem of the Republic of Italy; inside the border, the words “AL MERITO DELLA REPUBBLICA” are written in golden roman capitals letters; on the other side of the shield there is the golden effigy of Italy’s profile and inside the upper side of the borders in golden capital roman letters the words. “PATRIAE UNITATI”, in the lower side the words: “CIVIUM LIBERTATI”, separated by two golden points. The Cross is hanging on a silk 101mm band (82mm. for women) with the colours of the Order ending with a bow, to be worn from the right shoulder to the left hip;

2. The 85mm Plaque, looks like a convex radiant, made of eight groups of silver rays, cut like diamonds and carrying in the middle the Cross above described. Gentlemen wear the Plaque on the left, below the pocket jacket; Ladies wear the Plaque on the left side below the chest;

3. The 16mm Miniature of the Plaque above described (2.), hung on a 13mm silk ribbon with the colours of the Order; Gentlemen wear it on the left side of the jacket collar; Ladies wear it like a bow below the left shoulder;

4. The 12mm silk Rosette with colours of the Order carrying in the centre the miniature of the Plaque mentioned in point 2., Gentlemen wear it on the left side of the jacket collar; Ladies, wear the Miniature of Plaque as a brooch to be pinned below the left shoulder;

5. With the Uniform: the small horizontal ribbon with the colours of the Order, 37mm wide and 10mm high, carrying in the centre the Miniature of the Plaque described in point 2.

The Insignia of the Knight of Great Cross decorated with Great Ribbon are the same as the one for the Knight of Great Cross, with the exception of the Plaque with golden rays. Moreover, in special formal occasions, the Knight of Great Cross with Great Ribbon wears, instead of the ribbon, a Golden Collar from which hangs the Cross mentioned above.

B)

The Insignia of 2nd Class (The Great Officer) are:

1. The Cross, mentioned above, has to be worn around the neck with a ribbon of 50mm with the colours of the Order. Ladies wear the decorations in the same way but the ribbon is made as a bow below the left shoulder. For Ladies the Cross is made of 40mm. and the ribbon of 37mm.

2. The 80mm Plaque like a convex radiant, made of four groups of silver rays, cut like diamonds and carrying in the middle the Cross above described. Gentlemen wear the Plaque on the left side below the pocket jacket. Ladies wear the Plaque on the left side below the chest;

3. The 16mm Miniature of the Plaque as described above in point 2. Paragraph B) hanging from a vertical silk ribbon of 13mm with the colours of the Order to be worn on the left side of the men jacket. Ladies hang the Miniature on the same ribbon as a bow to be worn below the left shoulder.

4. The 12mm silk Rosette with the colour of the Order carrying the Miniature of the Plaque as mentioned at point 2 Paragraph B); Gentlemen wear it on the left side of the jacket; Ladies wear the Miniature of the Plaque as described above as a brooch to be pinned below the left shoulder.

5. With the Uniform: the horizontal ribbon, 37mm wide and 10mm high, with the Miniature of the Plaque in the centre as described in point 2 Paragraph B).

C)

The Insignia of 3rd Class (Commander) are:

1. The Cross as described above, to be worn from the neck with a 50mm ribbon with the colours of the Order. Ladies wear the Cross from the same ribbon as a bow below the left shoulder. For Ladies the

ribbon has to be of 37mm and the Cross of 40mm;

2. The 16mm Miniature of the Cross above described, to be worn with a 13mm silk ribbon with the colours of the Order. Gentlemen wear it on the left side of the jacket collar; Ladies wear the Miniature on the same ribbon but like a bow below the left shoulder;
3. The 10mm silk Rosette with the colours of the Order carrying the Miniature of the Cross described above, Gentlemen wear it on the left side of the jacket collar; Ladies a Miniature of the Cross as a pin below the left shoulder;
4. With the Uniform: the horizontal 37mm ribbon wide and 10mm high with the colours of the Order carrying in the centre of the Miniature the Cross described above.

D)

The Insignia of 4th Class (Officer) are:

1. The Cross as described above with 40mm golden metal rays hanging from a 37mm silk ribbon with the colours of the Order. Gentlemen wear the Insignia on the left side of the chest. Ladies hang the Cross on the same ribbon, but as a bow below the left shoulder;
2. The 16mm Miniature of the Officer Cross to be worn with a 13mm silk ribbon with the colours of the Order. Gentlemen wear it on the left side of the jacket collar. Ladies wear the Miniature on the same ribbon as a bow below the left shoulder;
3. The 10mm silk Rosette with the colours of the Order carrying the Miniature of the Cross described above. Gentlemen wear it in the left side of the jacket collar; Ladies wear a Miniature of the Officer Cross as a pin below the left shoulder;
4. With the Uniform: the 37mm ribbon wide and 10mm high, carrying in the centre the Miniature of the Officer Cross.

E)

The Insignia of 5th Class (Knight) are:

1. The Officer Cross, with silver metal rays hanging on a 37mm silk ribbon with the colours of the Order. Gentlemen wear the Insignia on the left side of the chest. Ladies hang the Cross on the same type of ribbon, as a bow below the left shoulder.
2. The 16mm Miniature of the Cross of the Knight hanging on a 13mm silk ribbon with the colours of the Order. Gentlemen wear it on the left side of the jacket. Ladies hang the Miniature on the same type of ribbon, as a bow below the left shoulder.
3. The 10mm silk Rosette with the colour of the Order, carrying the Miniature of the Cross of the Knight. Gentlemen wear it on the left side of the jacket collar. Ladies wear a Miniature of the Cross as a

brooch to be pinned below the left shoulder.

4. With the Uniform: the 37mm ribbon wide and 10mm high, carrying the Miniature of the Cross of the Knight.

2) SPECIAL PROVISIONS FOR THE USE OF THE INSIGNIA OF ORDER OF MERIT OF THE ITALIAN REPUBLIC

Insignia for Ladies in Uniform follow the same rules as for Gentlemen.

With due Uniforms, Members of the non military Corps and State Departments wear the Officer or Knight decorations on a 37mm neck ribbon.

In this case the eventual non National honours to be worn around the neck consist of a Plaque of the Great Officer and, for the Commandership the decoration on a 37mm wide ribbon. If the Insignia go to those who have other National Honours or when there are International Courtesy conditions this faculty doesn't apply.

Members of the non military Corps and State Departments awarded with Honour of Commandership of the Italian Republic if awarded also with other superior National Honour to be worn around the neck, wear the 40mm Insignia on the left side of the Uniform with a 37mm wide ribbon during International Ceremonies.



fig. 1

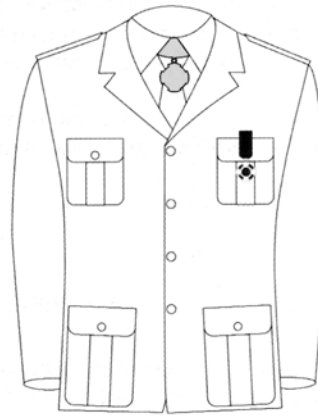

fig. 2

3. FEATURE OF THE INSIGNIA OF THE ORDER OF “THE STAR OF ITALIAN SOLIDARITY”

The Presidential Decree September 21st 2001 had modified and renewed the feature of the Insignia of

the Order of “The Star of Italian Solidarity” but also kept the use of the previous insignia to those who already got them.

The ribbon of the Order of The Star of the Italian Solidarity is red with green and white lateral stripes.

A)

The Insignia of 1st Class (Great Officer) are:

1. The 50mm Star Cross enamelled in white with golden stripes crossing by another green Star Cross with golden stripes; both Crosses are crossed by two golden yielded olive and oak twigs. The white Star Cross carrying in the centre a golden round shield with sky blue borders painted in gold the episode of the Good Samaritan; inside the borders, in the upper side in capital golden roman letters the word: SOLIDARITY, in the lower side the word: ITALIAN. The Cross has to be worn around the neck with a 50mm ribbon with the colours of the Order. Ladies wear on the left side of the shoulder the 40mm Cross with a 37mm ribbon as a bow with a golden crown made of four towers (only three visible);

2. The 75mm Plaque looks like a convex radiant, made of eight groups of silver rays, cut like diamonds and carrying in the middle the round shield as above described. Gentlemen wear the Plaque on the left, below the pocket jacket; Ladies wear the Plaque on the left side below the chest;

3. The 16mm Miniature of the Plaque as mentioned at paragraph 2. to be worn with a 13mm silk ribbon with the colours of the Order. Gentlemen wear it on the left side of the jacket collar. Ladies wear the Miniature on the same kind of ribbon as a bow below the left shoulder;

4. The 12mm Rosette with the colours of the Order carrying the Miniature of the Plaque as described in paragraph 2. Gentlemen wear it in the left side of the jacket collar; Ladies wear a Miniature as a pin below the left shoulder;

5. With the Uniform the 37mm wide and 10mm high ribbon with the colours of the Order carrying in the centre the Miniature of the Plaque as described above in paragraph 2.

B)

The Insignia of 2nd Class (Commander) are

1. The Cross as described above to be worn with a 50mm ribbon with the colours of the Order. Ladies wear below the left shoulder the 40mm Decoration with a 37mm. ribbon as a bow with a golden crown made of four towers (only three visible)

2. The 16mm. Miniature of the Cross described above, to be worn with a 13mm silk ribbon with the colours of the Order with a golden crown made of four towers, (only three visible); Gentlemen wear it on the left side of the jacket. Ladies wear below the left shoulder the Miniature around the neck with a ribbon as blow with the same golden crown.

3. The 10mm Rosette with the colours of the Orders with a Miniature of the Cross as above described, made as a pin to be wear below the left shoulder.

4. With the Uniform the 37mm wide and 10mm large ribbon with the colours of the Order in the centre the Miniature of the Cross.

C)

The Insignia of 3rd Class (Knight) are:

1. The Cross as above described to be worn with a 37mm green ribbon at the left side of the chest: Ladies wear the Cross with the ribbon as a blow below the left shoulder;
2. The 16mm Miniature of the Knight Cross to be worn with a 13mm silk ribbon with the colours of the Order on the left side of the jacket collar. Ladies wear the Miniature with the ribbon as a blow below the left shoulder;
3. The 10mm Rosette with the colour of the order carrying the Miniature of a Round Shield with the Cross to be worn on the left side of the jacket collar. Ladies wear the Miniature of the Round Shield as a pin below the left shoulder;
4. With the Uniform the 37mm wide and 10mm large ribbon carrying the Miniature of the Round Shield with the Cross described above.

4. ORDER OF PRECEDENCE

The order of precedence of degrees and classes of the Italian civil Orders of Knighthoods and Honours and Distinctions

KNIGHT GRAND CROSS WITH GRAND COLLAR OF THE ORDER OF MERIT OF THE ITALIAN REPUBLIC

1st category

.GOLD MEDAL OF MILITARY VALOUR
GOLD MEDAL OF CIVIL VALOUR
KNIGHT GRAND CROSS ORDER OF MERIT OF THE ITALIAN REPUBLIC
GOLD MEDAL OF CIVIL VALOUR
KNIGHT OF LABOUR

2nd category

GOLD MEDAL OF NAVAL VALOUR (for civilians enlisted as seafarers)
SILVER MEDAL OF MILITARY VALOUR
SILVER MEDAL OF CIVIL VALOUR
GRAND OFFICER, ORDER OF MERIT OF THE ITALIAN REPUBLIC
GRAND OFFICER, ORDER OF THE ITALIAN SOLIDARITY STAR
SILVER MEDAL OF CIVIL MERIT

3rd category

SILVER MEDAL OF NAVAL VALOUR
BRONZE MEDAL OF MILITARY VALOUR
BRONZE MEDAL OF CIVIL VALOUR
COMMANDER, ORDER OF MERIT OF THE ITALIAN REPUBLIC
COMMANDER, ORDER OF THE ITALIAN SOLIDARITY STAR
MEDAL OF OUTSTANDING MERIT FOR SERVICES TO PUBLIC HEALTH 1ST CLASS
MEDAL OF OUTSTANDING MERIT FOR SERVICES TO PUBLIC HEALTHCARE 1ST CLASS
MEDAL OF OUTSTANDING MERIT FOR SERVICES TO CULTURE AND ART 1ST CLASS
MEDAL OF OUTSTANDING MERIT FOR SERVICES TO EDUCATION, CULTURE AND ART 1ST CLASS
MEDAL OF OUTSTANDING MERIT FOR SERVICES TO SCIENCE AND CULTURE 1ST CLASS
MEDAL OF OUTSTANDING MERIT FOR SERVICES TO PUBLIC FINANCE 1ST CLASS
MEDAL OF OUTSTANDING MERIT FOR SERVICES TO ELEMENTARY AND PRE-SCHOOL EDUCATION
1ST CLASS
GOLD CROSS OF ARMY MERIT (for civilian holders)
GOLD MEDAL FOR NAVAL MERIT (for civilians enlisted as seafarers)
BRONZE MEDAL OF CIVIL MERIT
BRONZE MEDAL FOR NAVAL VALOUR (for civilians enlisted as seafarers)

4th category

CROSS OF MILITARY VALOUR
KNIGHT OF VITTORIO VENETO
OFFICER, ORDER OF MERIT OF THE ITALIAN REPUBLIC
KNIGHT, ORDER OF THE ITALIAN SOLIDARITY STAR
STAR OF LABOUR MERIT
KNIGHT, ORDER OF MERIT OF THE ITALIAN REPUBLIC
MEDAL OF OUTSTANDING MERIT FOR SERVICES TO PUBLIC HEALTH 2ND CLASS
MEDAL OF OUTSTANDING MERIT FOR SERVICES TO PUBLIC HEALTHCARE 2ND CLASS
MEDAL OF OUTSTANDING MERIT FOR SERVICES TO CULTURE AND ART 2ND CLASS
MEDAL OF OUTSTANDING MERIT FOR SERVICES TO EDUCATION, CULTURE AND ART 2ND CLASS
MEDAL OF OUTSTANDING MERIT FOR SERVICES TO SCIENCE AND CULTURE 2ND CLASS
MEDAL OF OUTSTANDING MERIT FOR SERVICES TO PUBLIC FINANCE 2ND CLASS
MEDAL OF OUTSTANDING MERIT FOR SERVICES TO ELEMENTARY AND PRE-SCHOOL EDUCATION
2ND CLASS
SILVER CROSS OF ARMY MERIT (for civilians)
SILVER MEDAL FOR NAVAL MERIT (for civilians enlisted as seafarers)
MEDAL FOR FORTY YEARS OF OUTSTANDING SERVICE TO ELEMENTARY SCHOOLS 1ST CLASS
MEDAL OF HONOUR FOR 20 YEARS' NAVAL SERVICE (for civilians enlisted as seafarers)

5th category

MEDAL OF OUTSTANDING MERIT FOR SERVICES TO PUBLIC HEALTH 3RD CLASS
MEDAL OF OUTSTANDING MERIT FOR SERVICES TO PUBLIC HEALTHCARE 3RD CLASS
MEDAL OF OUTSTANDING MERIT FOR SERVICES TO CULTURE AND ART 3RD CLASS
MEDAL OF OUTSTANDING MERIT FOR SERVICES TO EDUCATION, CULTURE AND ART 2ND CLASS
MEDAL OF OUTSTANDING MERIT FOR SERVICES TO SCIENCE AND CULTURE 3RD CLASS
MEDAL OF OUTSTANDING MERIT FOR SERVICES TO PUBLIC FINANCE 3RD CLASS

MEDAL OF OUTSTANDING MERIT FOR SERVICES TO ELEMENTARY AND PRE-SCHOOL EDUCATION
3RD CLASS

BRONZE CROSS OF ARMY MERIT (for civilians)

BRONZE MEDAL FOR NAVAL MERIT (for civilians enlisted as seafarers)

MEDAL OF HONOUR FOR 15 YEARS' NAVAL SERVICE (for civilians enlisted as seafarers)

MEDAL FOR FORTY YEARS OF OUTSTANDING SERVICE TO ELEMENTARY SCHOOLS 1ST CLASS

MEDAL OF HONOUR FOR 10 YEARS' NAVAL SERVICE (for civilians enlisted as seafarers)

**UNDER-SECRETARY OF STATE
GIANNI LETTA**

ORDER OF MERIT OF THE ITALIAN REPUBLIC

INSIGNIA



recto



verso



COLLARE

misura della croce mm. 52



FASCIA

*larghezza della fascia mm. 101
misura della croce mm. 52*



PLACCA

diametro mm. 85



NASTRINO

*larghezza del nastrino mm. 13
diametro della placca mm. 16*



ROSETTA

diametro mm. 12



NASTRINO DA UNIFORME

*larghezza del nastrino mm. 37
altezza del nastrino mm. 10*



FASCIA

*larghezza della fascia mm. 82
misura della croce mm. 52*



PLACCA

diametro mm. 85



FIOCCO DI NASTRINO

*altezza del nastrino mm. 13
diametro della placca mm. 16*



NASTRINO DA UNIFORME

*larghezza del nastrino mm. 37
altezza del nastrino mm. 10*



SPILLA

diametro mm. 10



FASCIA

*larghezza della fascia mm. 101
misura della croce mm. 52*



PLACCA

diametro mm. 85



NASTRINO

*larghezza del nastrino mm. 13
diametro della placca mm. 16*



ROSETTA

diametro mm. 12



NASTRINO DA UNIFORME

*larghezza del nastrino mm. 37
altezza del nastrino mm. 10*



FASCIA

*larghezza della fascia mm. 82
misura della croce mm. 52*



PLACCA

diametro mm. 85



FIOCCO DI NASTRINO

*altezza del nastrino mm. 13
diametro della placca mm. 16*



NASTRINO DA UNIFORME

*larghezza del nastrino mm. 37
altezza del nastrino mm. 10*



SPILLA

diametro mm. 10



NASTRO DA COLLO

altezza del nastro mm. 50
misura della croce mm. 52



PLACCA

diametro mm. 80



NASTRINO

larghezza del nastrino mm. 13
diametro della placca mm. 16



ROSETTA

diametro mm. 12



NASTRINO DA UNIFORME

larghezza del nastrino mm. 13
altezza del nastrino mm. 10



**FIOTTO DI NASTRO
REGOLAMENTARE**

altezza del nastro mm. 50
misura della croce mm. 52



**FIOTTO DI NASTRO
AMMESSO**

altezza del nastro mm. 37
misura della croce mm. 40



PLACCA

diametro mm. 80



**FIOTTO DI
NASTRINO**

larghezza del
nastrino mm. 13
diametro della
placca mm. 16



NASTRINO DA UNIFORME

larghezza del nastrino mm. ~~37~~ 13
altezza del nastrino mm. 10



SPILLA

diametro mm. 10



NASTRO DA COLLO

altezza del nastro mm. 50
misura della croce mm. 52



NASTRINO

larghezza del nastrino mm. 13
diametro della croce mm. 16



ROSETTA

diametro mm. 10



NASTRINO DA UNIFORME

larghezza del nastrino mm. 37
altezza del nastrino mm. 10



**FIOCO DI NASTRO
REGOLAMENTARE**

altezza del nastro mm. 50
misura della croce mm. 52



**FIOCO DI NASTRO
AMMESSO**

altezza del nastro mm. 37
misura della croce mm. 40



FIOCO DI NASTRINO

larghezza del nastrino mm. 13
diametro della croce mm. 16



SPILLA

diametro mm. 10



NASTRINO DA UNIFORME

larghezza del nastrino mm. 37
altezza del nastrino mm. 10



NASTRO

*larghezza del nastro mm. 37
misura della croce mm. 40*



NASTRINO

*larghezza del nastrino mm. 13
diametro della croce mm. 16*



ROSETTA

diametro mm. 10



NASTRINO DA UNIFORME

*larghezza del nastrino mm. 37
altezza del nastrino mm. 10*

INSEGNE FEMMINILI



NASTRO

*altezza del nastro mm. 37
misura della croce mm. 40*



SPILLA

diametro mm. 10



FIOCO DI NASTRINO

*altezza del nastrino mm. 13
misura della croce mm. 16*



NASTRINO DA UNIFORME

*larghezza del nastrino mm. 37
altezza del nastrino mm. 10*



NASTRO

larghezza del nastro mm. 37
misura della croce mm. 40



NASTRINO

larghezza del nastrino mm. 13
misura della croce mm. 16



ROSETTA

diametro mm. 10



NASTRINO DA UNIFORME

larghezza del nastrino mm. 37
altezza del nastrino mm. 10

INSEGNE FEMMINILI



FIOCO DI NASTRO

altezza del nastro mm. 37
misura della croce mm. 40



FIOCO DI NASTRINO

altezza del nastrino mm. 13
misura della croce mm. 16



SPILLA

misura mm. 10



NASTRINO DA UNIFORME

larghezza del nastrino mm. 37
altezza del nastrino mm. 10

ORDER OF MERIT OF THE ITALIAN REPUBLIC

TECHNICAL TABLES

ORDER OF MERIT OF THE ITALIAN REPUBLIC

INSIGNIA OF THE KNIGHTS GRAND CROSS, GRAND OFFICERS, COMMANDERS

Dimensions of the badge: 52 mm

MATERIALS AND DESCRIPTION

Cross: *silver gilt*

Leaves: *gilt silver, modelled relief*

Arms of the Cross: *white enamel*

Circular shield: *gilt silver*

Border of circular shield: *blue enamel with golden letters in relief, level with the enamel*

Emblem of the Republic: *gilt silver, modelled in relief*

Symbol of Italy crowned with a castle: *gilt silver, modelled in relief*

INSIGNIA OF OFFICERS

Dimensions of the badge: 40 mm

MATERIALS AND DESCRIPTION

Cross: *silver gilt*

Leaves: *gilt silver, modelled relief*

Arms of the Cross: *shiny silver gilt*

Circular shield: *gilt silver*

Border of circular shield: *blue enamel with golden letters in relief, level with the enamel*

Emblem of the Republic: *gilt silver, modelled in relief*

Symbol of Italy crowned with a castle: *gilt silver, modelled in relief*

INSIGNIA OF KNIGHTS

Dimensions of the badge: 40 mm

MATERIALS AND DESCRIPTION

Cross: *silver*

Leaves: *gilt silver, modelled relief*

Arms of the Cross: *shiny silver*

Circular shield: *gilt silver*

Border of circular shield: *blue enamel with golden letters in relief, level with the enamel*

Emblem of the Republic: *gilt silver, modelled in relief*

Symbol of Italy crowned with a castle: *gilt silver, modelled in relief*

INSIGNIA PERMITTED TO FEMALE GRAND OFFICERS AND COMMANDERS

Cross with the same features as the Grand Cross, Grand Officer and Commander, but 40 mm in size

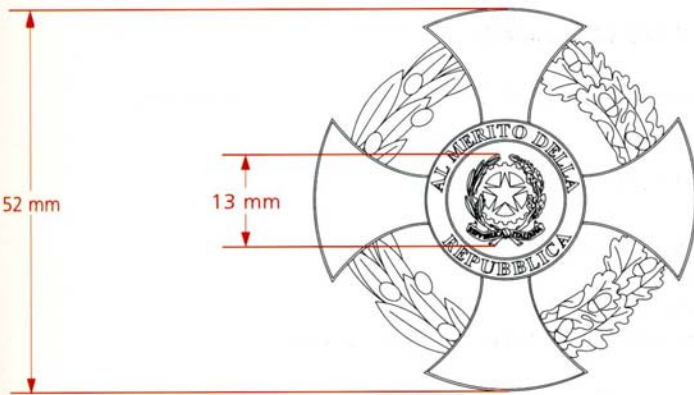

recto

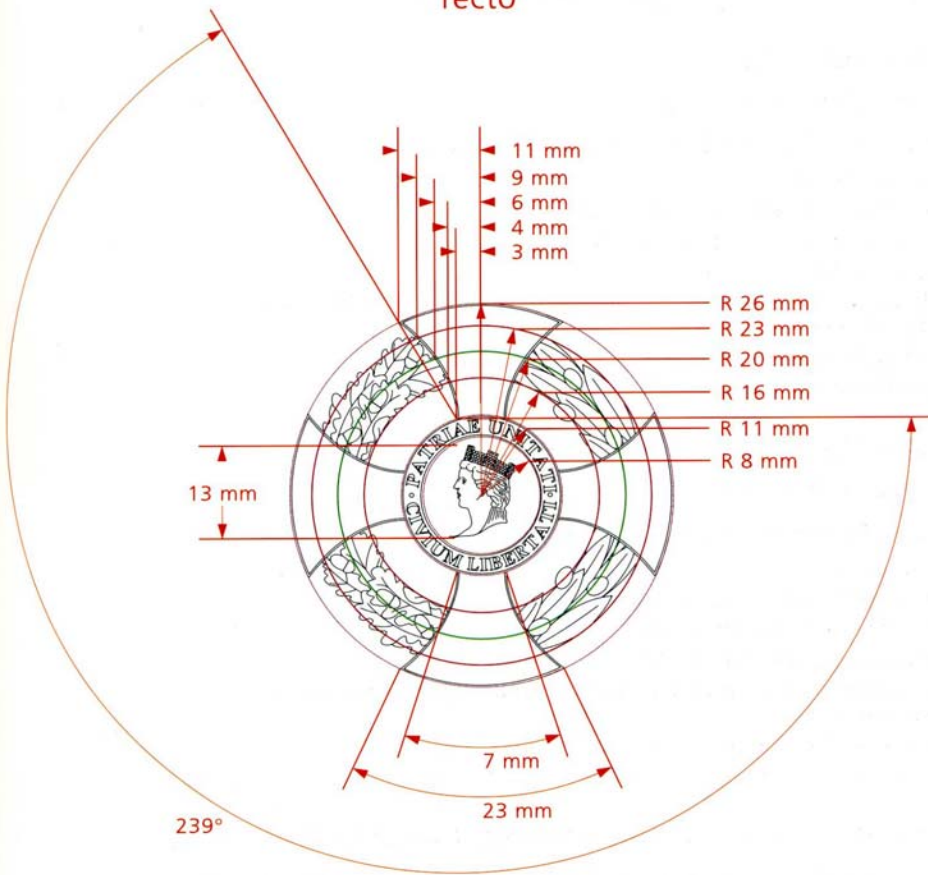

verso

PRIME MINISTERIAL CIRCULAR

22 MARCH 2002

ADOPTION OF ROSETTES FOR CIVIL DISTINCTIONS AND HONOURS OF THE REPUBLIC

PRIME MINISTERIAL CIRCULAR

22 MARCH 2002

ADOPTION OF ROSETTES FOR CIVIL DISTINCTIONS AND HONOURS OF THE REPUBLIC

1. (Omissis)

2. Holders of civil distinctions and honours of the Italian Republic may wear the relevant rosette.

The rosette shall be made of silk, 8 mm in diameter, with the combinations of colours specific to each honour or distinction.

When the honours or distinctions are subdivided into classes of merit, a horizontal bar, 13 mm wide and 7 mm high shall be placed behind it, made of yellow silk for 1st class or a gold medal, light grey silk for 2nd class or a silver medal, and dark green silk for 3rd class or a bronze medal.

Rosettes may be freely worn on day attire, and are normally mandatory on national holidays in the presence of the President of the Republic, at official civil or military ceremonial events and ceremonies expressly dedicated to the distinction or honour in question. The use of the rosettes on evening wear is governed by the rules of protocol.

3. The rosette shall be displayed as follows:

<u>DISTINCTION</u>	<u>ROSETTE</u>	<u>BAR</u>
<u>DECORATION OF MILITARY VALOUR</u>		
Gold medal	light blue	gold
Silver medal	light blue	silver
Bronze medal	light blue	bronze
Cross	light blue	----
<u>STAR OF LABOUR MERIT</u>		
yellow and green		
<u>MERIT FOR SERVICES TO PUBLIC HEALTH</u>		
Diploma 1 st class equivalent to a Gold Medal	light blue, black border	gold
Diploma 2 nd class equivalent to Silver Medal	light blue, black border	silver
Diploma 3 rd class equivalent to a Bronze Medal	light blue, black border	bronze
<u>MERIT FOR SERVICES TO PUBLIC HEALTHCARE</u>		
Diploma 1 st class equivalent to a Gold Medal	light blue, black braided	gold
Diploma 2 nd class equivalent to Silver Medal	light blue, black braided	silver
Diploma 3 rd class equivalent to a Bronze Medal	light blue, black braided	bronze
<u>MERIT FOR SERVICES TO EDUCATION, CULTURE AND ART</u>		
Diploma 1 st class equivalent to a Gold Medal	green	gold
Diploma 2 nd class equivalent to a Silver Medal	green	silver
Diploma 3 rd class equivalent to a Bronze Medal	green	bronze
<u>MERIT FOR SERVICES TO CULTURE AND ART</u>		
Diploma 1 st class equivalent to a Gold Medal	deep red	gold
Diploma 2 nd class equivalent to a Silver Medal	deep red	silver

<u>Diploma 3rd class equivalent to a Bronze Medal</u>	deep red	bronze
MERIT FOR SERVICES TO SCIENCE AND CULTURE		
Diploma 1 st class equivalent to a Gold Medal	violet	gold
Diploma 2 nd class equivalent to a Silver Medal	violet	silver
<u>Diploma 3rd class equivalent to a Bronze Medal</u>	violet	bronze
MERIT FOR SERVICES TO PUBLIC FINANCE		
Diploma 1 st class equivalent to a Gold Medal	yellow	gold
Diploma 2 nd class equivalent to a Silver Medal	yellow	silver
<u>Diploma 3rd class equivalent to a Bronze Medal</u>	yellow	bronze
SERVICES TO ELEMENTARY AND PRE-SCHOOL EDUCATION		
Diploma 1 st class equivalent to a Gold Medal	ivory	gold
Diploma 2 nd class equivalent to a Silver Medal	ivory	silver
<u>Diploma 3rd class equivalent to a Bronze Medal</u>	ivory	bronze
FORTY YEARS OF SERVICE TO ELEMENTARY SCHOOLS		
Diploma 1 st class equivalent to a Gold Medal	ivory and black	gold
Diploma 2 nd class equivalent to a Silver Medal	ivory and black	silver
<u>Diploma 3rd class equivalent to a Bronze Medal</u>	ivory and black	bronze
CIVIL MERIT		
Gold Medal	braided tricolour	gold
Silver Medal	braided tricolour	silver
<u>Bronze Medal</u>	braided tricolour	bronze
CIVIL VALOUR		
Gold Medal	tricolour	gold
Silver Medal	tricolour	silver
<u>Bronze Medal</u>	tricolour	bronze
NAVAL VALOUR		
Gold Medal	light blue, white	gold
Silver Medal	light blue, white	silver
<u>Bronze Medal</u>	light blue, white	bronze
NAVAL MERIT		
Gold Medal	dark blue and red	gold
Silver Medal	dark blue and red	silver
<u>Bronze Medal</u>	dark blue and red	bronze
ARMY MERIT		
Gold Medal	light blue, braided red and yellow	gold
Silver Medal	light blue, braided red and yellow	silver
<u>Bronze Medal</u>	light blue, braided red and yellow	bronze
LONG NAVAL SERVICE		
Gold Medal (20 years)	light blue and white	gold
Silver Medal (15 years)	light blue and white	silver
<u>Bronze Medal (10 years)</u>	light blue and white	bronze





































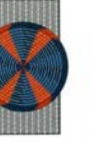

UNDER-SECRETARY OF STATE
GIANNI LETTA

**ICONOGRAPHIC TABLE
OF THE CIVIL HONOURS
OF THE REPUBLIC**

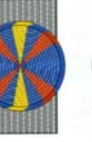
**PRIME MINISTERIAL CIRCULAR
15 OCTOBER 2001**

NATIONAL HOLIDAYS

Foggia della decorazione	Colori del nastro	Rosetta di classe unica, I classe o medaglia d'oro	Rosetta di II classe o medaglia d'argento	Rosetta di III classe o medaglia di bronzo
AL VALOR MILITARE *				
STELLA AL MERITO DEL LAVORO				
AI BENEMERITI DELLA SALUTE PUBBLICA				
AI BENEMERITI DELLA SANITÀ PUBBLICA				
AI BENEMERITI DELLA SCUOLA, DELLA CULTURA E DELL'ARTE				
AI BENEMERITI DELLA CULTURA E DELL'ARTE				
AI BENEMERITI DELLA SCIENZA E DELLA CULTURA				
AI BENEMERITI DELLA PUBBLICA FINANZA				

AI BENEMERITI DELL'ISTRUZIONE ELEMENTARE E MATERNA					
AI BENEMERITI PER OTTO LUSTRI NELLA SCUOLA ELEMENTARE					
AL MERITO CIVILE					
AL VALOR CIVILE					
AL VALOR DI MARINA					
AL MERITO DI MARINA					
AL MERITO DELL'ESERCITO					
A ONORE DI LUNGA NAVIGAZIONE MARITTIMA					

* La Croce di Guerra al Valor Militare, conferibile solo in tempo bellico, ha la rosetta d'azzurro, senza barretta.

**PRIME MINISTERIAL CIRCULAR ON NATIONAL HOLIDAYS
15 OCTOBER 2001**

1. NATIONAL CIVIL HOLIDAYS

The national civil holidays of 2 June (Anniversary of the Foundation of the Republic), 4 November (National Unity Day) and 25 April (Anniversary of the Liberation) are celebrated in the capital and in all the provincial capitals.

International Labour Day, which falls on 1 May is celebrated in the capital and in the regional capitals.

2. FLYING FLAGS

On national civil holidays public buildings shall fly the flag. On buildings which normally fly the flag daily, additional Italian and the European Union flags may be flown. Wherever possible, they shall be floodlit.

3. CONFERRAL OF HONOURS

On national civil holidays, holders of the Order of Merit of the Italian Republic shall wear the insignia in the form of a rosette (women shall wear the pin).

Members of the military shall follow their specific rules.

On 2 June, Italian diplomatic representatives abroad and representatives of the Government in the Italian Provinces shall award the Diplomas of Merit to the new members of the Order of Merit of the Italian Republic.

4. PLACES FOR THE CELEBRATION

The Rome celebrations of 2 June, 4 November and 25 April shall be held at the "Altar of the Homeland".

The 2 June and 4 November celebrations shall also be held at the War Graves Memorial at Redipuglia and the Monument to the Fallen Overseas at Bari.

Any ceremony at which the President of the Republic presides, in Rome or in any other Italian locality, is ranked as a national celebration.

National Day on 2 June is celebrated in Italy and locally by the heads of Italian Diplomatic Missions abroad and of Central Government Offices in the provinces.

5. THE ALTAR OF THE HOMELAND

The national holidays of 2 June, 4 November and 25 April shall be celebrated with the following ceremonial at the Altar of the Homeland:

- military honours shall be paid to the President of the Republic or to the most senior Authority present;
- homage shall be paid to the Unknown Warrior with the laying of a laurel wreath on the Tomb by the President of the Republic or the most senior Authority present;

- the President of the Republic or the most senior Authority present shall meet the military and civil authorities convened to attend the ceremony at the Altar of the Homeland;
- final military honours shall be paid to the President of the Republic or to the most senior Authority present.

The military honours and the act of homage to the Unknown Warrior shall be organised by the Minister of Defence who may also arrange for further units and aircraft to take part, by agreement with the Prime Minister.

The President of the Republic shall be accompanied up and down the steps of the Altar of the Homeland by:

- the President of the Senate of the Republic;
- the President of the Chamber of Deputies;
- the Prime Minister;
- the President of the Constitutional Court;
- the Minister of Defence;
- the Chief of Defence Staff;
- the Secretary General of the Presidency of the Republic and the Military Adviser of the President of the Republic;
- the Secretaries General of the Senate, the Chamber of Deputies, the Office of the Prime Minister and the Constitutional Court.

The following shall be present on the forecourt before the Tomb of the Unknown Warrior with the Advisers in the party accompanying the President of the Republic:

- the President of the Lazio Region;
- the Mayor of Rome;
- the President of the Rome Province;
- the Government Commissioner of the Lazio Region;
- the Prefect of Rome;
- the President of the Appeal Court;
- the Director of the Public Security Department - Chief of Police;
- the Chiefs of Staff of the Army, Navy, Air Force and the Commander-in-Chief of the Carabinieri Corps;
- the Secretary General of Defence;
- the Commander-in-Chief of the Guardia di Finanza;
- the Commander of the State Forest Rangers Corps;
- the Commander-in-Chief of the Harbourmasters' Corps;
- The Director of Prisons;
- the Military Adviser to the Prime Minister;
- the Commander of the Military Command of the Capital;
- the National Military Chaplain;
- the representatives of the Officers and NCOs of the Armed Forces;
- the Presidents of Veterans and Carabinieri Associations.

The ceremony shall be coordinated by the Director of the Department of State Ceremonial Protocol of the Office of the Prime Minister.

6. THE WAR GRAVES MEMORIAL AT REDIPUGLIA

The ceremony shall approximately take the following form:

- arrival at the Memorial by the senior Authority, with military honours;
- the laying of the wreath by the most senior Authority;
- honours paid to the Fallen;
- the lighting of the Eternal Flame;
- a religious ceremony, if arranged;
- reading of the Citation of the Gold Medal for Military Valour awarded to the Unknown Warrior;
- address;
- final honours paid to the senior Authority, who then departs.

7. THE MONUMENT TO THE FALLEN OVERSEAS AT BARI

The ceremony shall approximately take the following form:

- arrival at the Memorial by the senior Authority, with military honours;
- the laying of the wreath by the most senior Authority;
- honours paid to the Fallen;
- the signing of the Book of Honour by the senior Authority;
- a religious ceremony if arranged;
- reading of the Prayer of the Fallen in War and the Citation of the Gold Medal for Military Valour awarded to the unknown Warrior
- address;
- final honours paid to the senior Authority, who then departs.

8. MILITARY HONOURS

On national holidays the military honours shall be paid to the Fallen, the President of the Republic and the senior local Authority present.

On Republic Day there shall be a military parade in the Capital and military ceremonies may also be held in the Regional capitals or Provincial capitals where military units are stationed.

9. RECEPTIONS

Italian Diplomatic Representatives abroad and Prefects of the Provinces shall give a reception for the local authorities on their premises to celebrate 2 June, Republic Day.

10. POPULAR PARTICIPATION

For Republic Day, the Government authorities, by agreement with the local authorities, shall encourage the public to take part in the celebrations, for which they may also open public sites and buildings, with ribbons and concerts and other celebratory events.

11. LABOUR DAY

On 1 May each year, Labour Day shall be celebrated in the regional capitals with the award of "Star of Merit for Labour", in the presence of a government representative.

In the Capital, at the Quirinale Palace, in the presence of the President of the Republic, a national ceremony shall be held attended by representatives of the Award- holders from each region.

12. INVITATIONS

The Minister of Defence shall invite the authorities to attend the ceremonies at the Altar of the Homeland and the military ceremonies in Rome. The local military authorities shall issue invitations to attend the War Monuments of Redipuglia and for the Fallen Overseas in Bari, and local military ceremonies.

The heads of Diplomatic Missions abroad shall invite persons to attend any local ceremonies held there.

The heads of the Government offices in the Provinces shall issue invitations to attend government offices, and the mayor shall issue invitations to attend local ceremonies.

The head of the local Government Office in the Regional capitals shall issue invitations to celebrate 1 May.

Invitations to attend official celebrations shall be sent to the office-holders, while invitations to attend receptions shall also be extended to their partners.

13. FORMALITIES

The war standard shall be flown and the national anthem played at ceremonies attended by the President of the Republic.

At other ceremonies the national flag shall be flown, and for the celebrations of 2 June the National Anthem shall be played.

14. COORDINATION

The ceremonial for celebrating national holidays in the Capital shall be coordinated by the Department of State Ceremonial Protocol at the Office of the Prime Minister. When the President of the Republic is in attendance, the ceremonial shall be jointly coordinated with the Ceremonial Protocol Service of the Presidency of the Republic. At ceremonies held abroad, the Head of the Italian Diplomatic Mission shall arrange ceremonies, while in the Regional and Provincial Capitals this task falls to the Prefect heading the government Territorial Office.

15. COSTS

The costs of staging the celebrations shall be met by the local authorities, while the costs for receptions on Central Government premises shall be paid out of the respective central government Departments' budgets.

The costs of the military parades shall be met from the Ministry of Defence budget.

UNDER-SECRETARY OF STATE
GIANNI LETTA

LAW No 22 of 5 FEBRUARY 1998

USE OF THE FLAG OF THE ITALIAN REPUBLIC AND THE FLAG OF THE EUROPEAN UNION

LAW No 22 of 5 FEBRUARY 1998

GENERAL PROVISIONS REGARDING THE USE OF THE FLAG OF THE ITALIAN REPUBLIC AND THE FLAG OF THE EUROPEAN UNION

Art. 1

This law, implementing article 12 of the Constitution, and as a result of Italy's membership of the European Union, lays down the general provisions governing the use and displaying of the flag of the Italian Republic and the flag of the European Union, save for the special provisions governing the use of military flags.

The Regional Governments may, in the cases provided by Article 2 (1) (c) issue rules for the implementation of this law pursuant to article 117 (2) of the Constitution. The provisions of this Law are also general rules governing the subject-matter, under which the Government is authorised, in the cases referred to in article 2 (2) (1) (a), b), d), to issue regulations pursuant to article 17 (2) of Law No 400 of 23 August 1988, within five months from the date of entry into force of this law, after consulting the competent Parliamentary Committees having jurisdiction by subject matter.

Art. 2

The flag of the Italian Republic and the flag of the European Union shall be flown outside public buildings housing the headquarters of the following public law entities during the period in which they are performing their functions and activities:

- (a) constitutional organs and those of constitutional rank, and at all events the Central Government premises whenever the Council of Ministers is in session;
- (b) ministries;
- (c) Regional, Provincial and Municipal Council offices, while the Councils are in session;
- (d) judicial offices;
- (e) state schools and universities.

The flag of the Italian Republic and the flag of the European Union shall also be flown outside polling stations during elections, and outside the premises of Italian diplomatic and consular missions abroad.

The regulation and the regional rules referred to in article 1 (2) can, within the limits of their powers, introduce supplementary rules governing the procedures for flying the flag of the Italian Republic and the flag of the European Union as well as standards, arms and banners, also with reference to entities incorporated under public law not included in the list referred to in paragraph (1) of this article.

Art. 3

The provisions of this Law shall apply to the Special Statute Regions and the Autonomous Provinces of Trent and Bolzano within the limits of their Special Statutes and the rules of implementation.

Art. 4

From the date of entry into force of the regulation referred to in article 1 (2) of this Law, Royal Decree No 2072 of 24 September 1923, enacted into law and amended by Law No 2264 of 24 December 1925 and Law No 1085 of 24 June 1929, shall be repealed. From that same date the Prime Ministerial Decree of 3 June 1986, published in the Official Gazette No 128 of 5 June 1986 shall come into force.

Art. 5

(Omissis)

SCALFARO
PRODI
Minister of Justice
FLICK

DECREE OF THE PRESIDENT OF THE REPUBLIC
No. 121 of 7 APRIL 2000

THE USE OF FLAGS BY GOVERNMENT DEPARTMENTS AND AGENCIES

DECREE OF THE PRESIDENT OF THE REPUBLIC
No.121 of 7 APRIL 2000

REGULATION GOVERNING THE USE OF THE FLAGS OF THE ITALIAN REPUBLIC AND THE EUROPEAN UNION
BY GOVERNMENT DEPARTMENTS AND AGENCIES

CHAPTER I

FLYING THE FLAGS IS OUTSIDE PUBLIC BUILDINGS

Art. 1

In addition to the cases indicated in article 2 (1) and (2) of Law No. 22 of 5 February 1998 (hereafter referred to as "the Law") the flag of the Italian Republic and the European Union shall be flown, in the following places:

- a) outside buildings housing the headquarters of the Government Commissioners to the Regions and the Central Government Representatives in the Provinces;
- b) outside the buildings housing other local offices of the Central Government at general executive or executive level, of a territorial division no smaller than a Province;
- c) outside the central offices of independent Authorities or national Agencies and their local offices referred to in b) above.

Flags shall also be flown on other buildings housing public offices and institutions:

- a) on 7 January (Tricolour Day), 11 February (Anniversary of the Lateran Pacts), 25 April (Liberation Day), 1 May (Labour Day), 9 May (Europe Day), 2 June (Republic Day), 28 September (Popular Uprising in Naples), 4 October (Feast of the Patrons of Italy), and 4 November (National Unity Day);
- b) on 24 October (United Nations day) only the United Nations flag shall be flown;
- c) on other anniversaries, following the instructions issued, case by case, by the Prime Minister or, for local celebrations, by the Prefect.

For the purposes of implementing article 2 (1) (d) of the Law the term "judicial offices" shall also include the offices of all the courts provided by article 1 of Royal Decree No. 12 of 30 January 1941 and/or the Public Prosecutors/State Attorneys' Offices belonging to these courts within the meaning of article 2 of the same Law.

For the purposes of implementing article 2 (1) (e) of the Law, flags shall be flown on all schools, of every order and degree, instituted by the State and on the buildings housing the central organs of the Government of each university, and the main buildings housing individual Faculties and Schools.

On the occasions indicated under paragraph (2), on buildings which normally fly the flag daily, further Italian or European flags made also be flown.

Art. 2

The Italian flag and the European flag, identical in size and made of identical materials, shall be flown on flagpoles or masts of the same height.

The Italian flag shall be raised first and lowered last, and shall occupy the place of honour, on the right, or when multiple flags are flying, it shall always occupy the central position. If three fixed masts are available and there are two flags to be raised, the central mast shall be left free.

The European flag occupied second place, even when multiple flags are flying.

Art. 3

As a sign of mourning flags flown externally shall be lowered to half-mast. Two black ribbons may be attached to the top of the mast.

Art. 4

Save in the cases indicated in article 1(2) the time during which flags may be flown externally is governed by the following provisions.

Flags flown on the outside of public buildings referred to in article 2 (1) (a), (b) and (d) of the Law, and those referred to in article 1 (1) of this Regulation, shall be flown during the working hours of the offices in question.

Flags on schools and State universities shall be flown on days when lessons or examinations are being held.

Flags flown on the outside of buildings housing one or more polling stations shall be raised from the moment the polling stations are opened and lowered when the stations are closed for the ballots to be counted.

The flying of flags outside diplomatic missions, consular offices and Italian Cultural Institutes abroad shall follow the instructions issued by the Ministry of Foreign Affairs.

Save in the case provided by paragraph (4) above, flags shall normally not be raised before sunrise and shall be lowered at sunset. In all instances, flags may only be flown during the night hours if the place is adequately illuminated.

CHAPTER II

THE FLYING OF FLAGS AT CEREMONIES

Art. 5

If the Italian flag is borne in public ceremonies, it shall be given pride of place.

In public funeral ceremonies two black ribbons shall be attached to the flag.

CHAPTER III

DISPLAYING FLAGS INSIDE PUBLIC BUILDINGS

Art. 6

Inside public buildings the flag of the Italian Republic and the flag of the European Union shall be displayed in the offices:

- a) of members of the Council of Ministers and of Undersecretaries of State;
 - b) of executive offices of Directorates General or equivalent offices in Central Government Departments, and of executives responsible for local Central Government offices with jurisdiction over territories no smaller than the Province;
 - c) the holders of the highest institutional posts in nationwide public agencies and of executive offices corresponding to those indicated under b) above;
 - d) holders of the highest institutional offices of independent Authorities;
 - e) managers of the judicial offices referred to in article 1 (3);
 - f) heads of diplomatic missions, consular offices and Italian Cultural Institutes abroad.
- Displaying the flag is optional in the offices of honorary consuls.

The Italian flag and the European flag shall be displayed in court rooms at all instances.

At in the places indicated under paragraph (1) the portrait of the Head of State shall also be displayed.

Art. 7

In the cases indicated in article 6, the Italian and the European flags, of identical size and made of identical materials, shall be displayed on poles resting on the ground behind, and close to, the desk of the office-holder. The Italian flag shall occupy the place of honour on the right and in the centre.

In sign of mourning, two black ribbons may be attached to the flags.

CHAPTER IV

GENERAL AND FINAL PROVISIONS

Art. 8

Outside and inside public buildings the flags of foreign countries shall only be displayed for conferences, meetings and international

For international conferences, meetings and events, or during the course of official visits of foreign authorities, or for similar ceremonial reasons, notwithstanding the provisions of article 2 (2) and (3) of these Regulations, notwithstanding the ceremonial rules to be applied on individual occasions acting on instructions from the Government.

Art. 9

The flags displayed shall be in good condition and shall be completely unfurled; no written figures or letters of any kind whatsoever may be placed on them or on the mast.

Only one flag may hang on one mast.

Article 10

Every entity shall appoint the officials responsible for ascertaining that the flags are displayed properly, inside and outside the premises.

The representatives of the Central Government in the Provinces shall oversee compliance with the provisions governing the display of flags.

Article 11

These provisions shall not apply to particular provisions regarding military flags and those of other State bodies and organisations, including customary practices, and the military ceremonial, including international military ceremonial.

Article 12

The display of flags inside and outside the buildings housing Regional and Local Government Authorities shall be autonomously regulated by their respective Administrations. In every instance the Italian flag and the European flag shall be displayed jointly with the standard or banner of the Agency or Entity, whenever the latter is required to be displayed, giving prior dignity to the Italian flag.

This decree, bearing the Seal of State, shall be recorded in the Statute Book of the Italian Republic. Everyone is required to comply with, and enforce, it.