



White Paper Blu-ray Disc™ Format

1.C Physical Format Specifications for BD-ROM

6th Edition

October, 2010

White Paper Blu-ray Disc™ Format
1C. Physical Format Specifications for BD-ROM

Condition of Publication

COPYRIGHT

All rights reserved. This document contains information that is proprietary information of the Blu-ray Disc Association and its members and may not be used, copied or distributed without the written permission of the Blu-ray Disc Association or its License Office. All other use, copying and distribution are prohibited.

TRADEMARK

Blu-ray Disc™, Blu-ray™, Blu-ray 3D™, BD-Live™, BONUSVIEW™, BDXL™, AVCREC™ and the logos are trademarks of the Blu-ray Disc Association.

DISCLAIMER

The information contained herein is believed to be accurate as of the date of publication. However, none of the Blu-ray Disc Association, its Members, or its License Office will be liable for any damages, including indirect or consequential, from use of the White Paper or reliance on the accuracy of this document.

LICENSING

License is required from the Blu-ray Disc Association for the application of the System Description Blu-ray Disc™ Format in both disc and equipment products.

NOTICE

For any further explanation of the contents of this document, or in case of any perceived inconsistency or ambiguity of interpretation, please consult with:

Blu-ray Disc Association

License Office
10 Universal City Plaza, T-100,
Universal City, CA 91608 U.S.A.

Fax.: +1-818-763-9027
Web Site: <http://www.blu-raydisc.info>
E-mail: agent@blu-raydisc.info

INDEX

1: Introduction	4
2: Capacity of BD-ROM specifications version 1.0	6
2-1: Capacity 25GB/layer	6
2-2: High NA and blue laser contribution to the large capacity	7
3: Data rate	9
4: Disc structure	10
4-1: Configuration of SL and DL	10
4-2: The advantage of the BD Substrate	10
4-3: The method to form the Cover Layer	12
5: Bare disc	14
5-1: Strong Error Correction Code (ECC)	14
5-2: Servo stability	16
5-3: Taber abrasion test.....	18
6: Reflectivity	20
7: In-Pit and On-Pit	21
8: DPD and Push-Pull tracking error	22
9: Modulation	23
10: Data structure	24
11: Jitter measurement using the Limit-Equalizer	25
12: Disc manufacturing process	28
12-1: Mastering.....	28
12-1-1: PTM (Phase Transition Metal) mastering.....	28
12-1-2: Deep-UV Liquid Immersion mastering.....	30
12-1-3: Electron beam mastering.....	32
12-2: Disc Replication process	33
13: Representative parameters.....	38
14: SID code	40
15: BCA.....	41
16: Random Symbol Error Rate (RSER) measurement	42
17: Hybrid disc.....	44
18: DVD Read-Only disc with an AV application according to the BD Read-Only System Description Part3, with capacities of 4.7 or 8.5 GB	46
19: Recommendation for the maximum read power of BD-ROM devices	47
20: Conclusions.....	48

1: Introduction

The Read-Only Blu-ray Disc™ (BD-ROM) uses a Substrate of about 1.1 mm nominal thickness. In the case of a Single Layer disc the Substrate is covered with 1 Recorded Layer on top of which a transparent Cover Layer of about 0.1 mm is applied.

In the case of a Dual Layer disc the Substrate is covered with 2 Recorded Layers, each separated by a transparent Space Layer of about 0.025 mm. The first Recorded Layer seen from the read-out side of the disc is semi-transparent. On top of this first Recorded Layer, a transparent Cover Layer of about 0.075 mm is applied.

Both Recorded Layers contain Pits and Spaces that have been recorded during manufacturing of the disc. The Pits and Spaces form Tracks containing User Data and Addresses which serve as a navigation system.

Read-out of the data is accomplished through the Cover Layer or through the total stack of Cover Layer, first Recorded Layer and Space Layer, depending on which Recorded Layer is involved. The different maximum capacities of the Recorded Layers are realized by changing the “in-Track” or tangential density (varying the Channel bit length).

The disc is intended to be used without a Cartridge. For special applications or for severe environments a Cartridge may be used.

In this White Paper we introduce the key technologies underlying BD-ROM. In Chapter 2 the fundamental attributes contributing to the high capacity of BD-ROM are explained. Another BD-ROM advantage is its high data rate, which is explained in Chapter 3. In Chapter 4 items related to disc structure are explained, such as the 0.1 mm thick Cover Layer and 1.1 mm thick Substrate. How the lack of transparency requirement for the 1.1 mm Substrate contributes to reduce the manufacturing cycle time of BD-ROM is explained in Chapter 4-2. The Cover Layer formation technology is explained in Chapter 4-3. BD-ROM was required to be a bare disc system, so this was a large focus of the effort of the BD-ROM technical working group. In Chapter 5 some key technologies and the test method for the bare disc are explained. Chapter 6 describes why the reflectivity of BD-ROM is higher than that of BD-RE. Both concave and convex Pit structures are allowed, which is explained in Chapter 7. One difference from DVD is that both DPD (Differential Phase Detection) and Push-Pull for BD-ROM have been specified and they are described in Chapter 8. The BD family employs 17PP ((1, 7) RLL Parity-Preserve, Prohibit Repeated Minimum Transition Runlength code) modulation in combination with a Viterbi decoder in order to give wide system margins. This 17PP modulation is also effective for the BD-ROM disc system and is explained in Chapter 9.

In the case of the CD and DVD formats, the Read-Only ROM specifications were created first, and ROM data were recorded continuously. Thus when Recordable CD-R and DVD-R were developed, the problem of linking of different recordings to make a compatible, continuous recording was a challenge. In Blu-ray Disc™, the Rewritable BD-RE specifications were created, before the BD-ROM specifications, and therefore there was full freedom to define the Linking Area. Chapter 10 describes the BD-ROM data structure including the Linking Frame. The Viterbi decoder dramatically expands the system margin in comparison to simple bit-by-bit detection. It also has Error Correction capability with a nonlinear relationship between the input error rate and the output error rate. Although the Viterbi decoder is very useful for players or recorders, it is

difficult to use it for disc measurements. A Limit-Equalizer, on the other hand, has a nonlinear function but the relationship of input to output is linear. Thus a Limit-Equalizer is substituted for the Viterbi decoder for jitter measurements. An explanation of the Limit-Equalizer is contained in Chapter 11. Disc manufacturing process such as mastering and replication are explained in Chapter 12, and Chapter 13 summarizes the main specifications of BD-ROM.

When considering the storage of Audio or Video contents in BD-ROM discs, it is crucial to also include the possibility of content protection technology. Details on content protection technology are not discussed in this document. The BD-ROM specifications include a source Identification (SID) code and a Burst Cutting Area (BCA) similar to what is used already in CD and DVD. SID code and BCA are explained in Chapter 14 and 15 respectively. The background of RSER measurement is explained in Chapter 16, while the Hybrid disc combination with DVD-ROM or CD-ROM is described in Chapter 17. DVD Read-Only disc with BD AV application is explained in Chapter 18. The maximum read power for BD devices is explained in Chapter 19.

2: Capacity of BD-ROM specifications version 1.0

2-1: Capacity 25GB/layer

BD-RE version 1.0 specifies the capacities of 23.3GB/layer, 25GB/layer and 27GB/layer (reserved). The 27GB/layer specifications need further confirmation with mass production data and so remain reserved at this time. In technical conferences such as ISOM (International Symposium on Optical Memory) and ODS (Optical Data Storage), some companies have already reported the possibility of BD-ROM discs. To maintain compatibility with BD-RE version 1.0, we specified 23.3GB/layer and 25GB/layer for BD-ROM version 1.0 specifications. Testing was conducted on 23.3GB and 25GB Single Layer discs and 46.6GB and 50GB Dual Layer discs, and the feasibility of concept and mass manufacturing was confirmed.

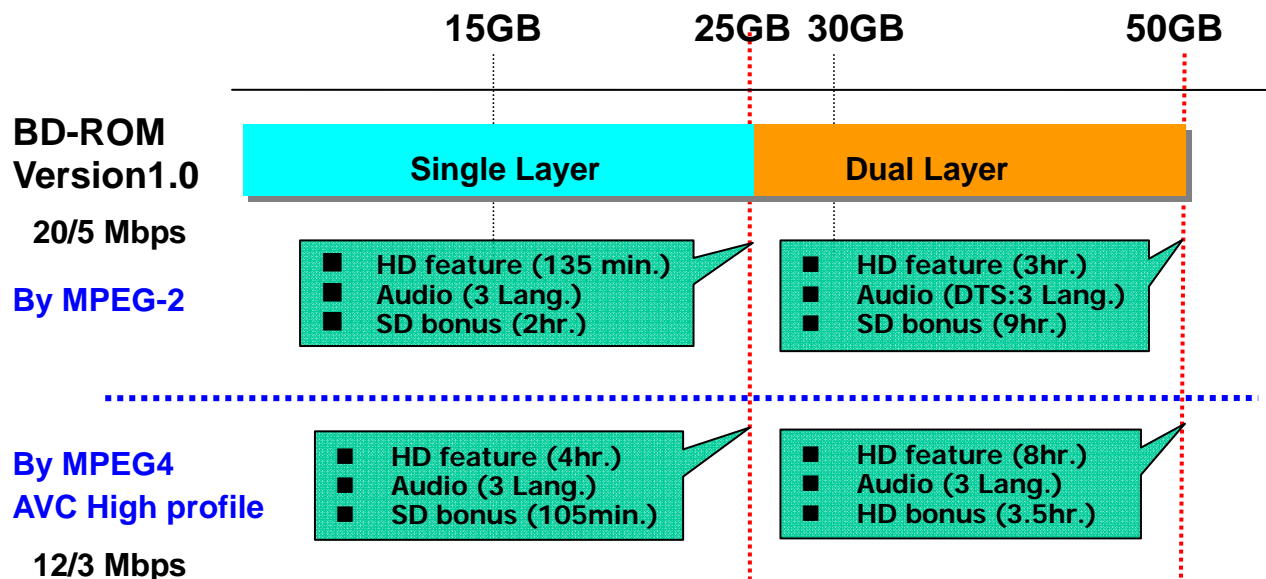

Fig. 2-1 BD-ROM version 1.0 capacity

Figure 2-1, most movie applications can be recorded on a Single Layer disc and we can expect a reasonable cost for such discs. Dual Layer discs expand the application range even more.

From BD-ROM version 1.3 the lowest capacities of 23.3GB/46.6GB were excluded from the specifications. One reason was that the disc manufacturing technology progressed and the other reason was to reduce the effort for the test procedure and test discs for a drive.

Table 2-1 shows the Channel bit length and related maximum capacities of BD-ROM.

Main parameters		
Channel bit length	74.50 nm	69.00 nm
Data bit length	111.75 nm	103.50 nm
Reference Velocity (1X)	4.917 m/s	4.544 m/s
Maximum User Data rate		
Single Layer	25.025 Gbytes	27.020 Gbytes (reserved)
Dual Layer	50.050 Gbytes	54.040 Gbytes (reserved)

Table2-1 Channel bit length and related maximum capacities

2-2: High NA and blue laser contribution to the large capacity

Like the BD-RE system, the pick up head for BD-ROM uses a high numerical aperture (NA) lens of 0.85 and a 405 nm blue laser. In early BD-RE systems the high NA was realized by using 2 lenses in combination. Today many single lenses with working distance larger than 0.5 mm have been developed, and even lenses which can be used in DVD/BD compatible pick ups and CD/DVD/BD compatible pick ups have been developed.

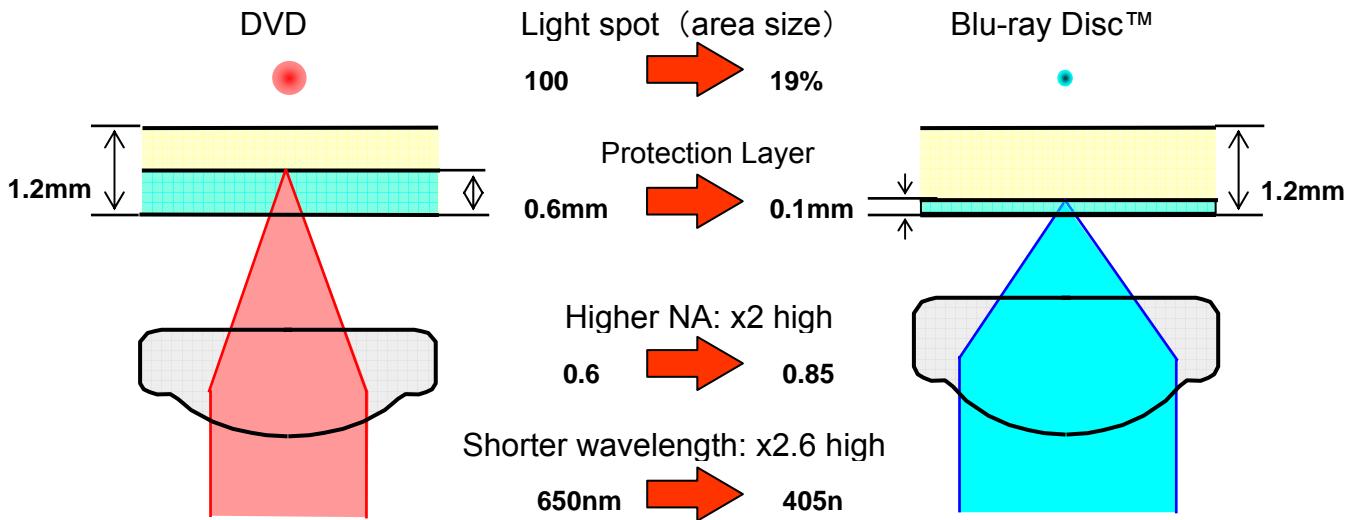

Fig.2-2 High-capacity contribution

Figure 2-2 shows that the high NA lens increases the areal density by 2 times while the blue laser contributes an additional factor of 2.6 times compared to the areal density of DVD. In total, the Blu-ray™ spot size is less than 1/5 that of DVD, resulting in more than 5 times the capacity of DVD.

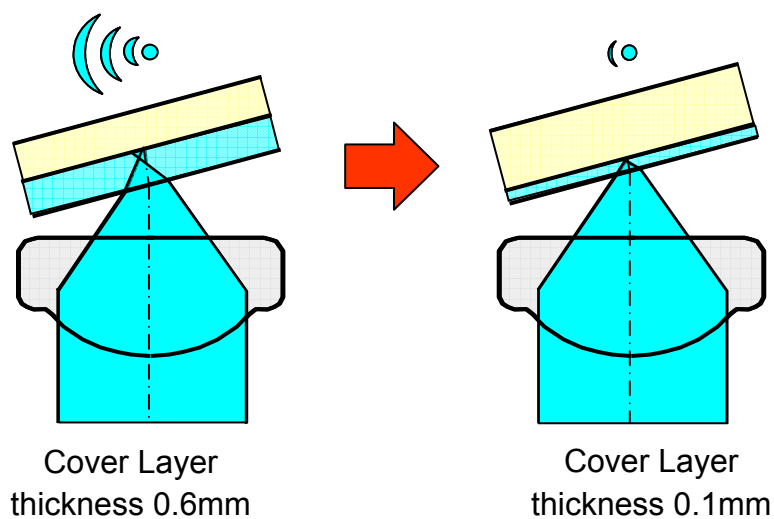

Fig.2-3 Necessity of 0.1 mm Cover Layer

White Paper Blu-ray Disc™ Format
1C. Physical Format Specifications for BD-ROM

2: Capacity of BD-ROM specifications version 1.0

Figure2-3 shows the optical beam degradation due to the disc tilt. This degradation is proportional to NA^3 and the thickness of the Cover Layer. We selected 0.1 mm as the thickness of the Cover Layer, achieving more than ± 1.60 deg (in α angle (see Fig.2-4)) for the radial tilt margin for BD-ROM, which is similar to that of DVD-ROM.

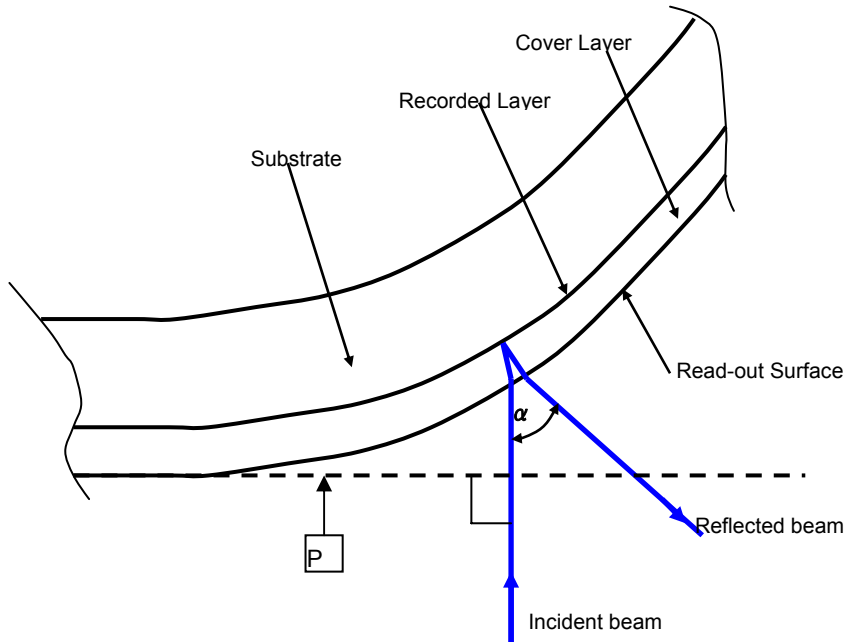

Fig.2-4 α angle explanation

3: Data rate

For high-definition movies a much higher data rate is needed than for standard definition. With the BD format's choices for both NA and wavelength we have been able to realize a format with 5X higher data rate while only doubling the rotation rate of DVD-ROM discs.

The following numbers offer a comparison:

Data bit length: 111.75 nm (25GB) (267 nm for DVD)

Linear Velocity: 7.367 m/s (Movie application) (3.49 m/s for DVD).

User Data transfer rate: 53.948 Mbit/s (Movie application) (10.08 Mbps for DVD)

The BD system has the potential for future higher speed drives.

4: Disc structure

4-1: Configuration of SL and DL

Figure 4-1 shows the outline of a Single Layer BD Read-Only disc and Figure 4-2 shows the outline of a Dual Layer BD Read-Only disc. To improve scratch resistance, the Cover Layer can optionally be protected with an additional Hard coat Layer.

4-2: The advantage of the BD Substrate

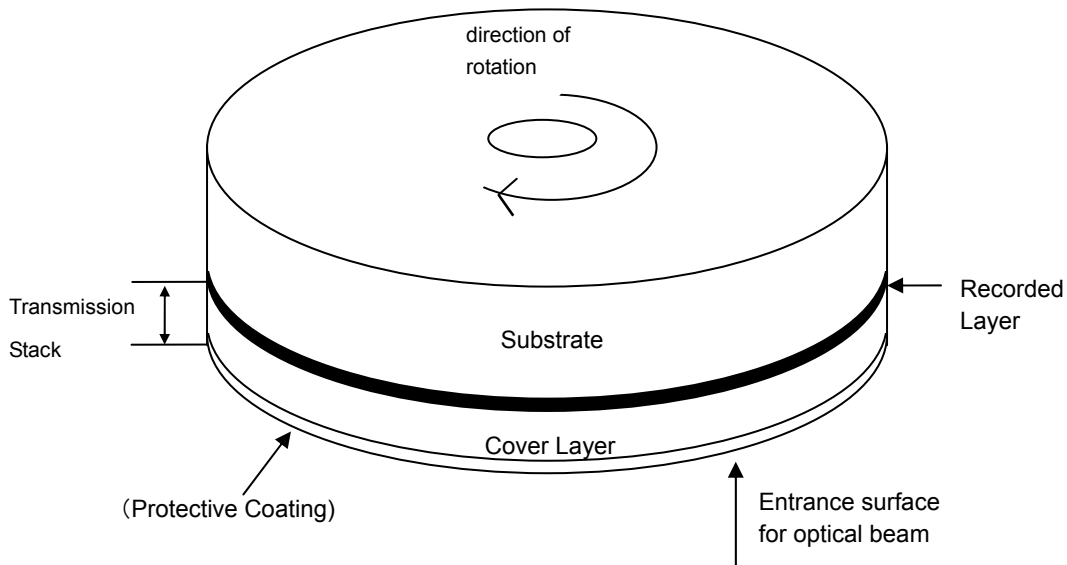

Fig.4-1 Outline of Single Layer BD Read-Only disc

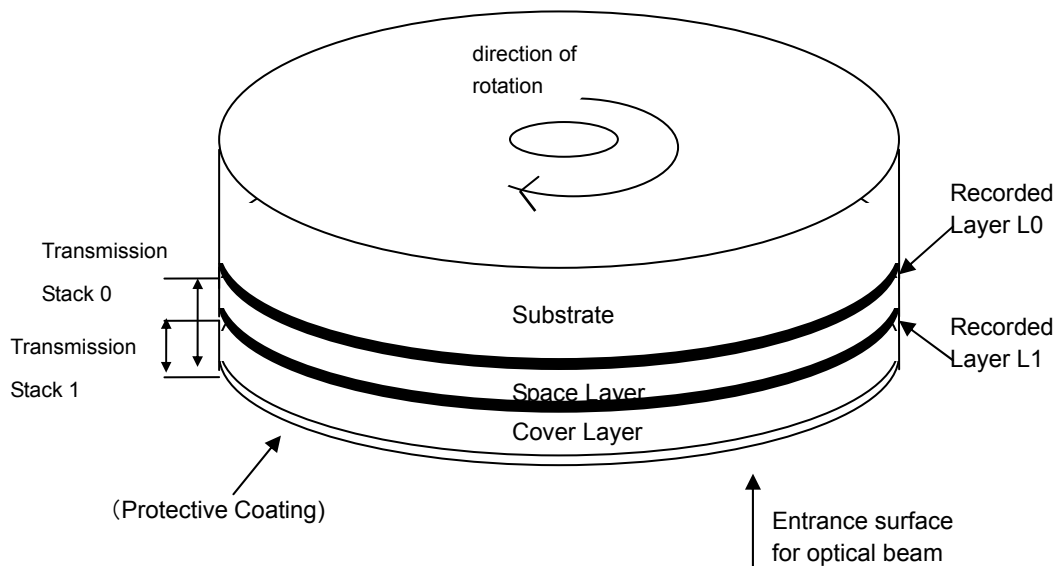

Fig.4-2 Outline of Dual Layer BD Read-Only disc

As you can see in Figures 4-1 and 4-2, the optical beam for reading a BD-ROM disc impinges on the Cover Layer and does not go through the Substrate. Therefore the Substrate does not need to be transparent. The Substrate contains the Pits structure and so replication of the Pit pattern is

required. But problems of birefringence in the Substrate, which affect the cycle time of the injection mold, are not present.

Figure 4-3 shows the injection mold machine. Melted plastic is injected into the mold cavity and the Pit pattern of the stamper is replicated to the plastic by the pressure applied to the mold. If the temperature of the mold is low then the melted plastic becomes rigid near the surface of the mold. Then several Skin Layers of the plastic are made near the surface of the Substrate, causing birefringence.

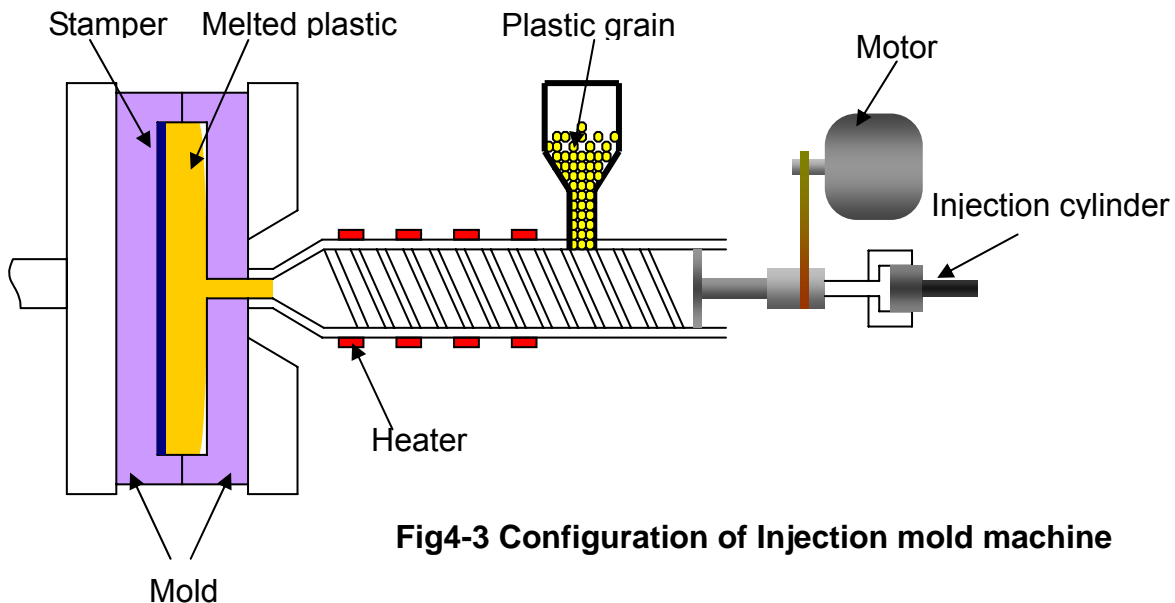

Fig4-3 Configuration of Injection mold machine

Figure 4-4 shows this mechanism of birefringence formation. In order to prevent birefringence, the mold temperature must be kept high during plastic injection. After cooling the Substrate inside the mold so that it becomes rigid and no additional bending will occur, the Substrate is removed from the mold. In order to prevent birefringence a high mold temperature, followed by a long cooling time, is required.

For BD-ROM disc injection molding we do not have the birefringence problem, which allows a reduced cycle time for the replication process. Also the BD format does not have to consider the optical transparency of the Substrate material, enabling a wide choice of easily moldable plastics (or even paper). By comparison, any format requiring an injection mold process aiming for low birefringence requires a long cycle time. The short wavelength of the blue laser makes formats with these requirements even more susceptible to birefringence. Avoiding these issues is a clear benefit of the BD-ROM approach.

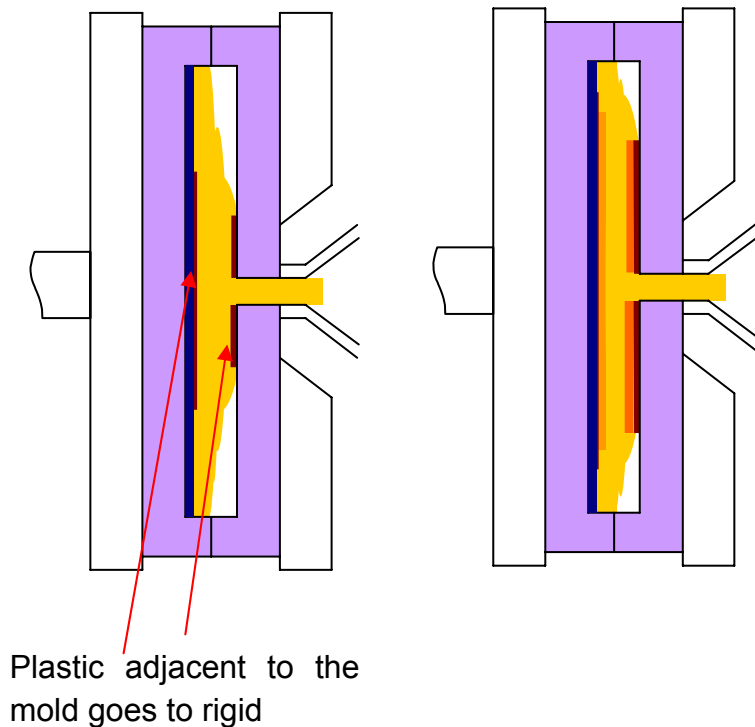

Fig.4-4 Mechanism of the birefringence formation

4-3: The method to form the Cover Layer

During the early development stage of Blu-ray™ Rewritable disc, two different methods were studied to form the 0.1 mm thick Cover of the disc. One was to transfer the data pattern to a 0.1-mm-thick base material and then bond a 1.1-mm-thick Substrate to the base material. The other is to transfer the pattern to a 1.1-mm-thick Substrate by injection molding and then bond a 100µm-thick Cover to the Substrate. For use in the former method, various pattern-transfer techniques were studied, such as injection molding, and sheet transfer. However, the study revealed that the former method had various problems to overcome: difficulties in transfer itself and in handling the post-processes, such as lamination of the pattern-transferred sheet or base material molded into the sheet, formation of layers, and bonding. On the other hand, the latter method, in which a Cover is bonded to the 1.1-mm-thick Substrate, also had a challenge: the Recording Layer or Reflective Layer is formed on the opposite side from that of the conventional optical disc. However, due to optimization of the Groove or Pit configuration and development of suitable Recording Layer materials, Cover formation by the latter method has become relatively easy. The Blu-ray Disc™ Cover is mainly produced by the latter method at present and is used for ROM discs also.

The Cover formation techniques can be divided roughly into two groups. One is to form a 100µm thick layer on the Substrate using an ultraviolet curing resin (hereafter referred to as the “UV resin”), similar to that employed as the Protective Layer of CD and as an adhesive in DVD. The other is to bond a Cover sheet to the Substrate.

Figure 4-5 shows the basic process for each of these techniques: from upper to lower, forming

the entire Cover using a UV resin (Resin Coating Process), bonding a Cover sheet using a UV resin, and bonding a Cover sheet using a pressure sensitive adhesive (PSA). A Cover formation difficulty arises from the low Cover thickness of 100 μm and the thickness error requirement of $\pm 3\mu\text{m}$. The thickness precision depends on the resin application precision, manufacturing technique, and the thickness of the sheet and Adhesive Layer. The Resin Coating Process has two challenges: unevenness of resin thickness at the inner and outer peripheries, and resin upheaval on the outer peripheral area due to surface tension. We have overcome these problems by placing a Center Cap over the Center hole, irradiating the resin coat with UV light while spinning the Substrate, improving the Substrate shape, and so on.

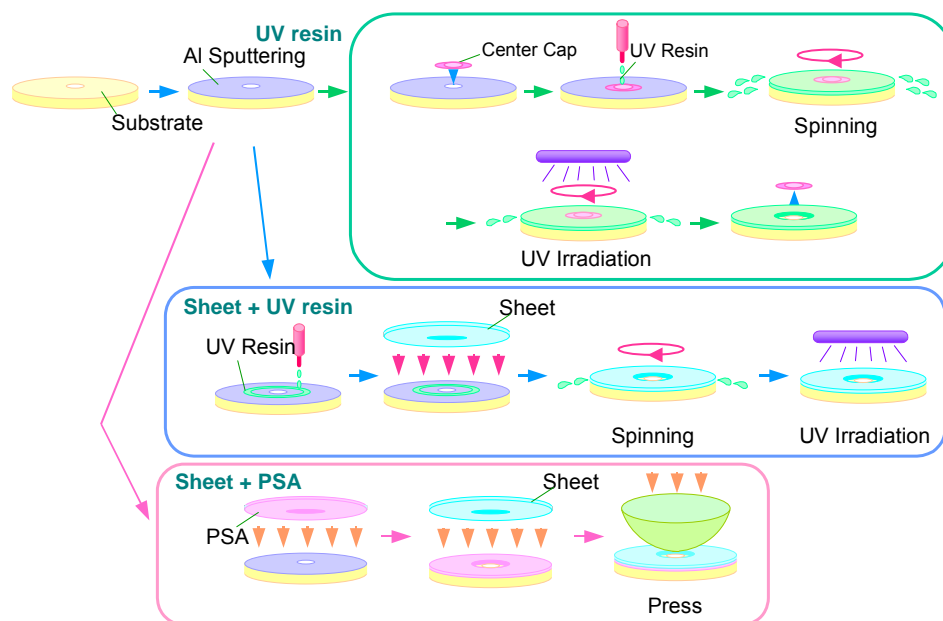

Fig.4-5 Cover Layer process

5: Bare disc

In order to realize a bare disc system for the 0.1 mm Cover Layer disc, significant robustness against dust, defects, scratches and fingerprints is required. Error Correction Code (ECC) is the key technology for reading data. For stable system operation, servo stability is the key issue. To wipe out fingerprints a hard disc surface is required and a test method for hardness is necessary. These key technologies are explained in this chapter.

5-1: Strong Error Correction Code (ECC)

It has been regarded that one of principal advantages of optical discs is that the influence of dust or fingerprints on the disc surface is limited because the optical beam is defocused for dust or fingerprints on the surface of the Cover Layer when information is recorded and read. When the Cover Layer thickness is reduced, the NA value of objective lens can easily be increased, and this defocus effect is sacrificed. Since the Cover Layer thickness required for the defocus effect is different for digital and analog recordings, a reexamination was needed.

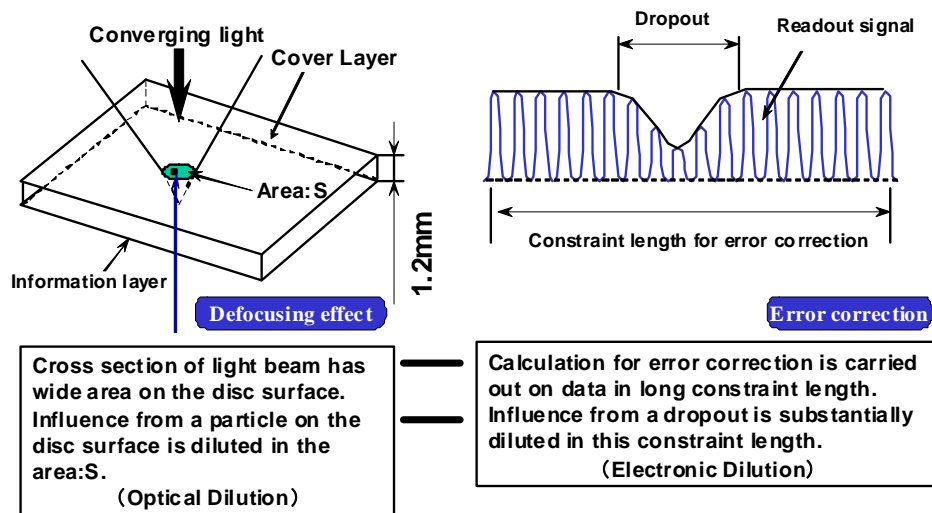

Fig. 5-1 Cover Layer has a function of optically diluting influence from a particle on the disc surface. Error correction has a function of electronically diluting influence from a dropout. Both of these functions are similar to each other.

The defocusing effect when light passes through the Cover Layer means that by increasing the cross section of incoming laser beam on the Surface Layer, the influence of small dust or fingerprints is diluted within the large cross section area of the beam. In other words, although the area influenced by dust or fingerprints is enlarged to the size of the light beam, the signal deterioration is reduced and reading errors are prevented. On the other hand, what we call Error Correction is generally used as a means to remove reading errors. During this operation, some redundancy data calculated from a large block of data is attached to the block as error check data. After the block is read, the check data is inversely calculated to correct partial errors. This can be compared to an image modification process where a partial defect of a photograph is corrected through estimations using adjacent image data. Through this method, errors are prevented by

diluting the influence of partial signal defects in a large-scale data block. It can be said that this Error Correction method is the electronic version of defocusing by the Cover Layer. This further suggests that defocusing by the Cover Layer partially can be compensated by Error Correction (Figure 5-1).

Figure 5-2 shows the comparison of a BD ECC Block and a DVD ECC Block, which is applied to 0.1 mm Cover Layer disc. In the figure 30 μm size defects and 138 μm beam spot size, which corresponds to the spot size on the Cover Layer, are plotted.

The ECC size of the BD is 2 times of that of DVD. BD ECC has 32 bytes parity, which is also 2 times of that of DVD. Within this large BD ECC area, data is de-interleaved 2 times. Thus the defects are converted to small random errors by the de-interleaving process. Due to the large parities, randomized defects data are corrected. Figure 5-3 shows the ECC ability of BD in the comparison of DVD ECC ability in case of 90 bytes length burst errors. As seen from the figure you can see the very strong defects correction capability of BD ECC. With this strong ECC, BD realizes the electronic defocus effect as shown in Figure 5-1.

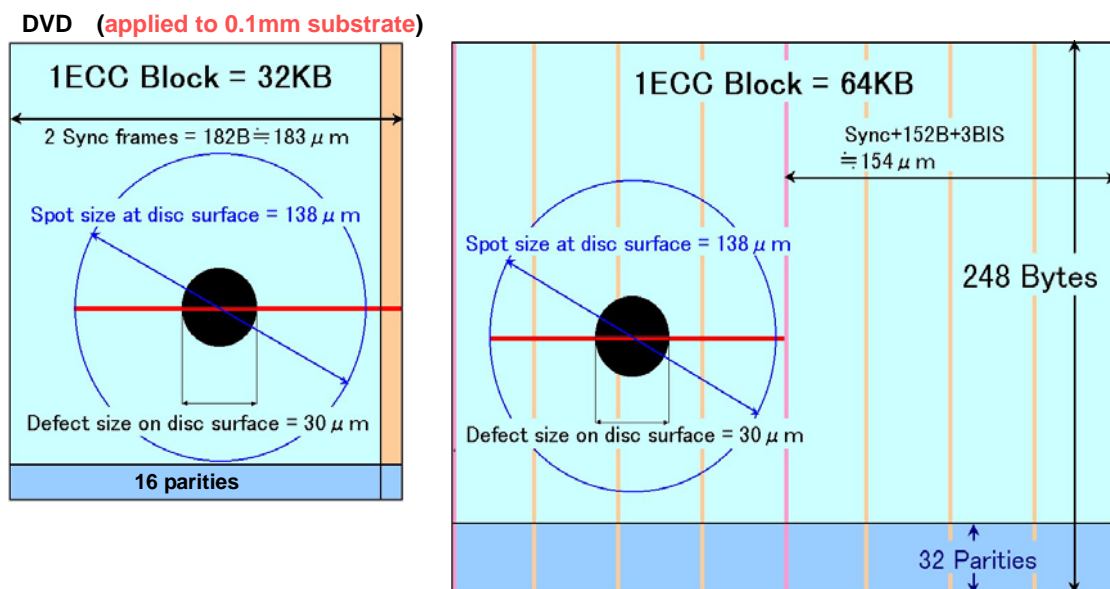

Fig.5-2 Comparison of BD ECC Block and DVD ECC Block, which is the case applied to 0.1 mm Cover Layer system

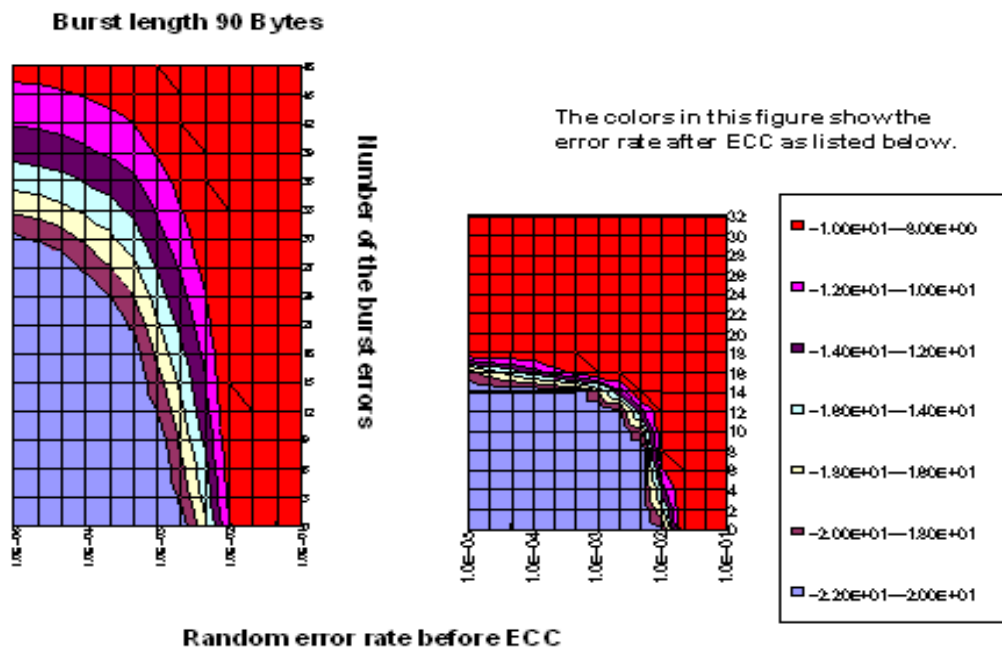

Fig.5-3 ECC ability of BD and DVD in case of 90 bytes length burst Error (Full erasure correction)

5-2: Servo stability

As explained in section 5.1, the beam spot size on the surface of the 0.1 mm Cover Layer is smaller than that of DVD. The diameter of the BD optical beam spot on the surface of the Cover Layer is 138 μm. The diameter of the DVD optical spot on the surface is 520 μm. Thus the surface spot size of BD is roughly 1/4 of that of DVD. This smaller beam spot naturally causes a concern that the effect of fingerprints on the servo signal could be larger than that of DVD. On the other hand the Linear Velocity of a BD player is higher than that of DVD. The Linear Velocity of DVD player is 3.49 m/sec. In BD-Movie applications a BD player rotates discs 1.5 times the Reference Linear Velocity of the BD-ROM measuring condition – 7.38 m/sec or 2.11 times that of DVD player. Servo stability depends on the error signal amplitude and the duration time during which the error signal appears. Thus there are both benefits and challenges in a BD player related to the servo system.

In order to verify servo stability, artificial fingerprints were investigated for test repeatability. There are many kinds of fingerprints and their size and pattern depends on each individual. We checked a large number of fingerprints and observed the focus error signal, the tracking error signal, HF signal and some calculated signals using the former 3 signals. We found that a repeated stripe pattern using UV resin showed signals very close that of real fingerprints.

Figure 5-4 shows the photo picture of the artificial fingerprints for the servo stability test. In the figure, we defined the ratio of the pattern width to the repetition pitch as the duty. In case of a small duty the artificial fingerprints are like a weak fingerprint, or in other words, a “soft touch” fingerprint. In the case of a large duty the artificial fingerprint is like a heavy real fingerprint, or in other words, one applied with strong pressure. After printing these artificial fingerprints on the surface of

DVD-ROM discs and BD-ROM discs, we compared the servo stability of the players.

Figure 5-5 shows examples of the servo signals observed when these discs were used in a DVD player and in a BD player. Figure 5-6 shows the results of the servo stability test. Figure 5-6 shows that the servo stability of BD players is very similar to that of DVD players. Actually, with the fingerprints, playback robustness data on the first commercial BD recorder were in general a little bit better than on most DVD recorders. We expect further improvement on BD when the player designs become more mature. Unlike write once or Rewritable discs, ROM discs have the data already recorded in the Pits pattern and so recording is not necessary.

Considering the existence of super heavy fingerprints, we had to enable wipe off fingerprints from the surface of a disc.

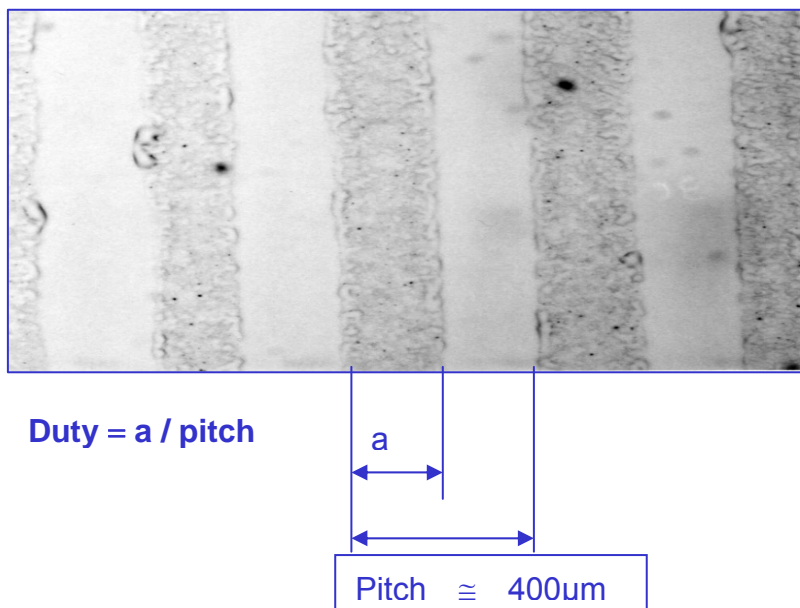

Fig.5-4 Artificial finger prints for the servo stability test

5: Bare disc



Fig.5-5 Example of the servo error signals of DVD player and BD player

**** F.E: Focus Error T.E: Tracking Error Sum: Focus sum signal. ****

Servo stability test result

	In DVD case		In BD case	
	Focusing	Tracking	Focusing	Tracking
Weak finger print	OK	OK	OK	OK
Strong finger print	OK	OK	OK	OK
Super heavy finger print	OK	OK or NG*	OK	OK or NG*

* Depends on player

Fig. 5-6 Results of the servo stability test

5-3: Taber abrasion test

In order to wipe off fingerprints from the surface of a disc, the surface of the Cover Layer of a ROM disc must be hard enough to avoid damage by a wiping action. We investigated test methods for scratch resistance. To specify hardness, we selected the Taber abrasion test. It uses a kind of abrasive roll. Two abrasive rolls are pressed on the surface of a disc with certain pressure and the disc is rotated. We investigated the relationship of jitter to the error rate and decided on the jitter value as the criterion for this test. Figure 5-7 shows a picture of the Taber abrasion test equipment and the error rate without and with hard coat.

Taber abrasion test
(ASTM-D1044)

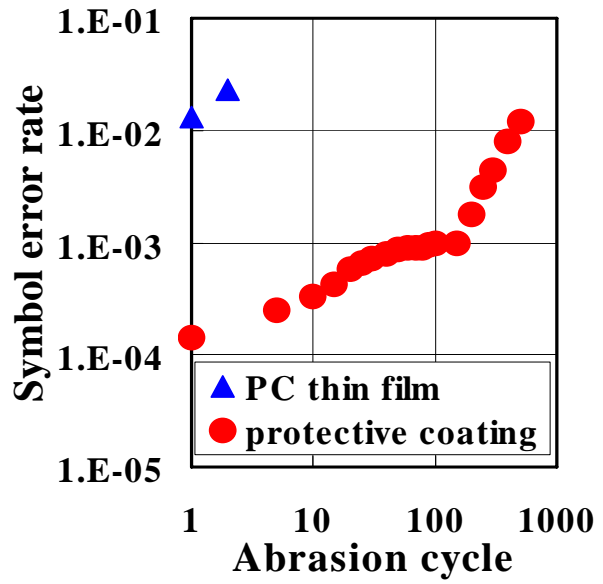

Fig.5-7 Taber abrasion test

6: Reflectivity

Since a basic concept in the creation of the family of BD specifications was to maintain compatibility, it was determined that the BD-ROM reflectivity should be close to that of the existing BD-RE format. Technically this is possible, but disc costs have to be taken into consideration as well. For CD and DVD, Al-based Reflective Layers had been used, and no better material was found to replace this for BD-ROM. Two types reflectivity of BD-ROM are specified as 35% to 70% /12% to 28% for the Recorded Layer of a Single Layer (SL) disc and one type of 12% to 28% for each layer of a Dual Layer (DL) disc, which are higher than the comparable specifications for BD-RE. (Refer to chapter 17: Hybrid disc)

7: In-Pit and On-Pit

In general two different Pit shapes are possible as shown in Figure 7-1. The concave Pit seen from the optical beam is defined as In-Pit and the other case (convex Pit) as On-Pit. Usually Pits that are replicated on the Substrate are In-Pits. Therefore this is the easiest way to produce BD-ROM Single Layer discs. For Layer 1 of Dual Layer discs the situation is different (see also Fig. 4-2). One method to make the Pits in Layer 1 is to replicate Pits to the Space Layer, which results in In-Pits. A second method is to replicate Pits to the Cover sheet, which results in On-Pits. In order to expand the possibility of disc manufacturing, both In-Pit and On-Pit geometries are allowed for BD-ROM.

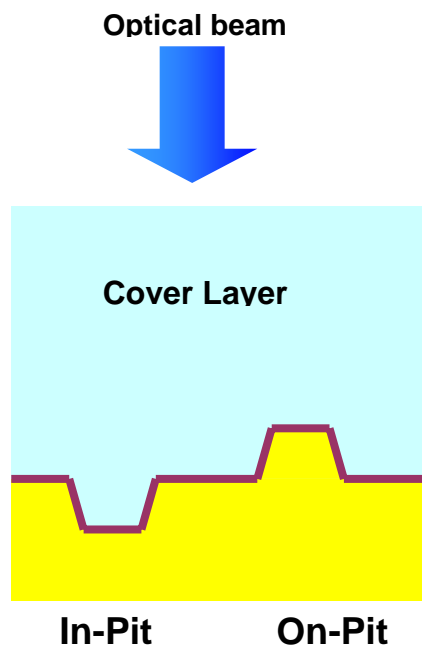

Fig. 7-1 Pit shape

8: DPD and Push-Pull tracking error

Pit depth is important for a ROM disc. In order to pursue the best jitter, DVD-ROM used $\lambda/4$ for Pit depth. At $\lambda/4$ the Push-Pull signal level is almost zero and so a DPD signal was used for the tracking signal. In the BD-ROM case the jitter is also best around a Pit depth of $\lambda/4$. Unlike DVD-ROM, the signal obtained from BD-ROM discs could not be analyzed using scalar diffraction simulation due to the high NA and shorter wavelength. Even at a Pit depth of $\lambda/4$ we can obtain a Push-Pull signal. Beyond that, we can realize good jitter and enough Push-Pull signal both below and above a Pit depth of $\lambda/4$. Thus it is not necessary to define Pit depth, which is usually defined as Pit phase.

9: Modulation

The modulation technique of the main channel recorded along a track is called 17PP ((1, 7) RLL Parity-Preserve, Prohibit Repeated Minimum Transition Runlength code). This is a so-called d=1 code. As the examination results show for Rewritable discs, the d=1 code was employed for BD because of the wider detection window as compared with the d=2 code used for CDs and DVDs (see Figure 9-1). Further, a low Channel clock can be used when recording at high speed. This data was obtained from a past experiment using a wavelength of 650 nm. Although the horizontal axis must be transformed to the density of Blu-ray Disc™, this result was obtained when recorded and played back on a Phase change film. The use of d =1 means that a non-linear Equalizer and PRML detection represented by a Limit-Equalizer act more effectively. This type of signal processing is more important in Blu-ray Disc™ compared with CD and DVD. Although the mastering and embossing ROM Pits seemed difficult at first because the minimum Pit is shorter than that of d=2, those processes were eventually successful thanks to the progress of mastering technology. The Parity preserve means that the DC balance of signals after modulation can be evaluated without looking at the 0-1 series, which is effective in reducing the hardware load. Prohibit RMTR (Repeated Minimum Transition Run length) is limited not to run seven or more in 17PP by preventing long runs of minimum length (which is represented by 101 after modulation).

Reference:

“Optical Disc System for Digital Video Recording”, T. Narahara et.al., Jpn. J. Appl. Phys. 39 (2000) pp. 912-919.

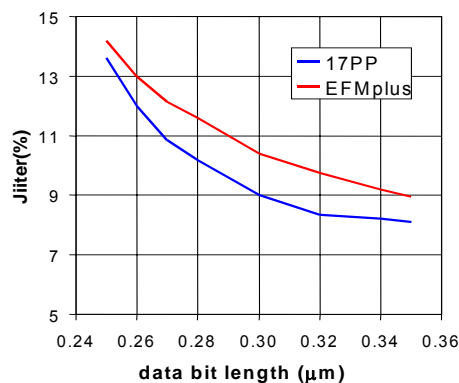

**Fig.9-1 The density comparison
in two modulation codes**

10: Data structure

As mentioned previously, in the case of CD and DVD, ROM discs were specified first. The data of a ROM disc are continuously recorded in those formats. When data is appended to the previously recorded data using the same data format as that of ROM for Rewritable or Write once CD or DVD discs, Zero Linking is the goal (Zero Linking means linking data without any gap or overlap). The Data Block Unit recorded on BD-RE is a LDC (Long Distance Code) Block of 64Kbytes. Between the adjacent two Recording Unit Blocks, a two Sync Frame length (Run-in + Run-out) Area is prepared, in order to handle the possible variation in Linear Velocity. We created the BD-RE specification first and so we had the flexibility to adjust the BD-ROM specification to make it similar to BD-RE specifications. For BD-RE, a wobbled groove is employed. We can use that wobble signal when we pull in the read clock during a link. But in the ROM case we do not have a wobble signal. For ROM we prepared 2 Linking Frames, which have the same length of (Run-in + Run-out) of BD-RE. We aligned the Sync Frame in the Linking Frames of a ROM disc using the same interval of the Sync Frames in the Data Area so that we can continue clocking while reading ROM discs. The Sync Frame in the Linking Frame has a unique pattern so that we can recognize the Linking Frame Area. Figure 10-1 and Figure 10-2 shows the linking part of BD-RE and BD-ROM.

Physical Cluster	Run-out	Run-in	Physical Cluster
498 frame	0.57 frame	1.43 frame	498 frame

Fig.10-1 Continuously recorded Linking part of BD-RE

Physical Cluster	Link Frame1	Link Frame2	Physical Cluster
498 frame	1 frame	1 frame	498 frame

Fig.10-2 Linking part of BD-ROM

11: Jitter measurement using the Limit-Equalizer

Generally, a playback signal reading system uses a Linear Equalizer to improve the Signal to Noise Ratio (SNR) around minimum-length Pits and to suppress Inter-Symbol Interference. Disc noise exists mainly in a low-frequency region as shown in Figure 11-1. When high frequency around minimum-length Pits is selectively boosted using the Linear Equalizer, the minimum-Pit-length signal level can be markedly enhanced with only a small increase in the total amount of noise. That is, it is possible to improve the SNR by using a Linear Equalizer that boosts high frequencies. However, since an excessive boosting of high frequencies causes an increase in Inter-Symbol Interference, the Conventional Linear Equalizer has a limit to SNR improvement.

A Limit-Equalizer is capable of boosting high frequencies without increasing Inter-Symbol Interference. Figure 11-2 shows the configuration of the Limit-Equalizer system used in 17PP modulation. In this system, a Pre-Equalizer first minimizes Inter-Symbol Interference.

A Conventional Linear Equalizer is used as the Pre-Equalizer. The Limit-Equalizer is located next to the Pre-Equalizer. The Limit-Equalizer has almost the same construction as a Finite-Impulse-Response (FIR) Linear Equalizer, except that the Limiter restricts the amplitude of part of playback signal. The FIR filter acts as a high-frequency-boosting Equalizer, and its gain is determined by coefficient "k." The gain of the FIR filter increases with the value of k.

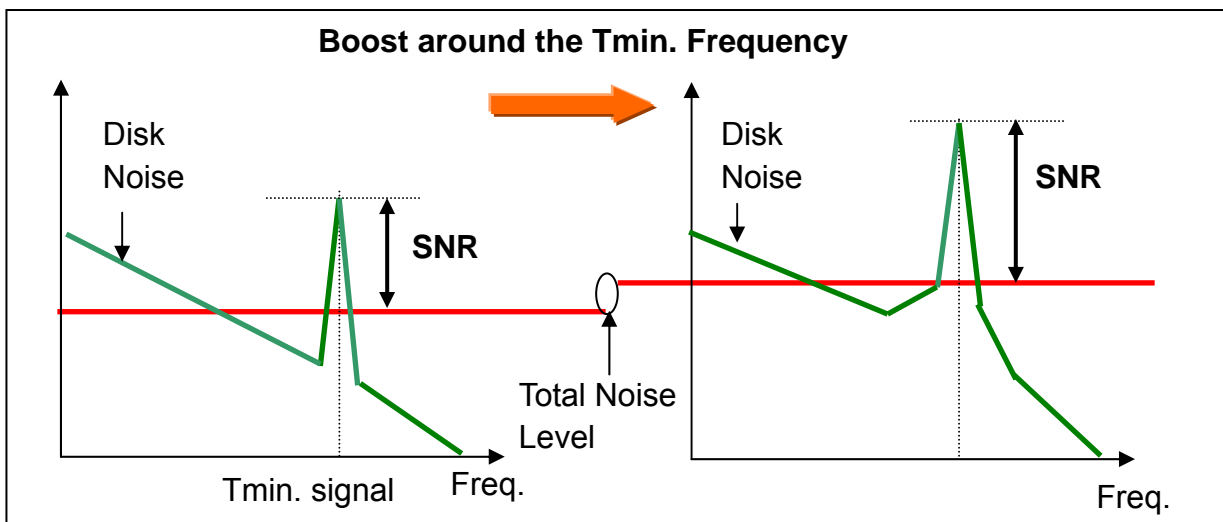

Fig.11-1 SNR improvement of a Limit-Equalizer

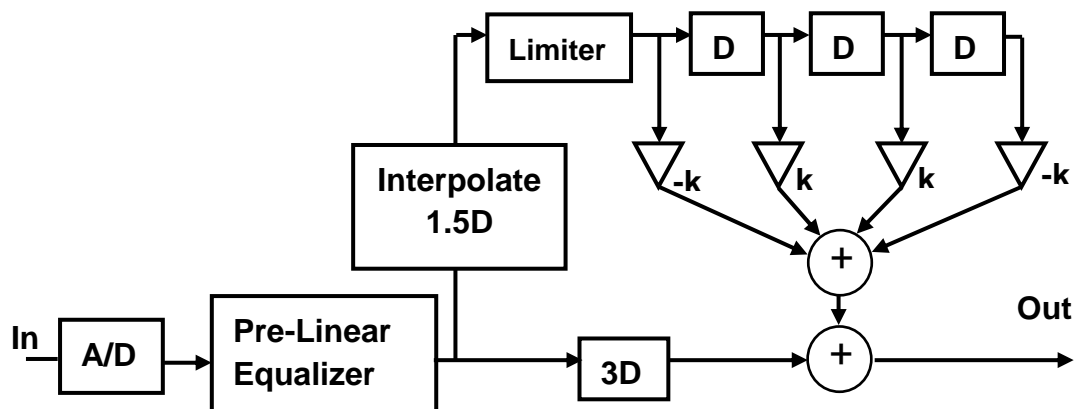

Fig.11-2 The configuration of a Limit-Equalizer

Sample values of the playback signal are indicated at the small-circle points in Figure 11-3. To understand the operation of the Limit-Equalizer, we pay attention to the zero-cross point and the sample values at points close to the zero-cross point. The operation of the Equalizer without a Limiter is as follows.

Referring to the left-side chart of Figure 11-3, if the playback signal waveform is symmetrical as indicated by the solid line, the data summed up by the Equalizer becomes 0 as expressed in Equation (1), and the zero-cross point does not move.

$$(-k)x(-a) + (k)x(-a) + (k)x(a) + (-k)x(a) = 0 \quad \text{--- (1)}$$

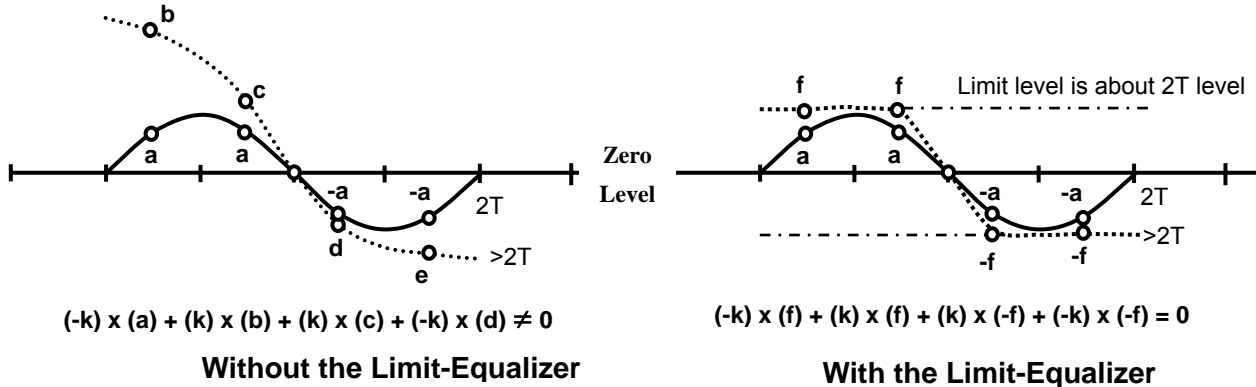

Fig.11-3 Behavior of a Linear Equalizer and Limit-Equalizer

However, if the playback signal waveform is asymmetrical as shown in the dotted line, the data summed up by the Equalizer does not become 0 as indicated by Equation (2), resulting in the Inter-Symbol Interference.

$$(-k)x(b) + (k)x(c) + (k)x(d) + (-k)x(e) \neq 0 \quad \text{--- (2)}$$

However, if a Limiter is used to restrict the signal amplitude to around the peak amplitude level of the shortest wavelength signal, the waveform becomes symmetrical as shown by the dotted line in the right-side chart of Figure 11-3. In that case, the data summed up by the Equalizer is constantly 0, as expressed in Equation (3).

$$(-k)x(-f) + (k)x(-f) + (k)x(f) + (-k)x(f) = 0 \quad \text{--- (3)}$$

The Limiter does not act on a signal with minimum-length Mark, and the Equalizer amplifies the signal amplitude. For a low-frequency signal with high amplitude, the Limiter restricts the amplitude around the center tap, which is to be added to the sum. The filter gain is effectively decreased. Thus, the Limit-Equalizer can boost high frequencies without increasing Inter-Symbol Interference, and SNR is improved.

Since the Blu-ray Disc™ format adopts high-density recording and 17PP modulation, the minimum Mark length is shorter than for a conventional optical disc, and its SNR is lower. Viterbi decoding in the disc drive can compensate for the lower SNR to achieve good playback performance. However, since Viterbi decoding output is the result after 1/0 determination and is poor in sensitivity, it is not suitable for use in evaluating optical discs in general. The jitter of signals processed by a Linear Equalizer is dominated by the component attributed to the noise of disc itself rather than the component attributed to the quality of Recording Marks, making it difficult to determine whether or not the recording state is optimal. In this regard, a Linear Equalizer is not

suitable for use in disc evaluation.

The Blu-ray Disc™ system employs a Limit-Equalizer to improve the SNR and to measure jitter for disc evaluation. With the Limit-Equalizer, it is possible to determine the quality of Recorded Marks with high sensitivity. Figure 11-4 shows the relation of jitter to the error rate.

Though the Limit-Equalizer has a non linear operation block inside, the relationship of input to output is linear and suitable as measurement system.

1-7 25GROM Jitter vs. SER (defocus)

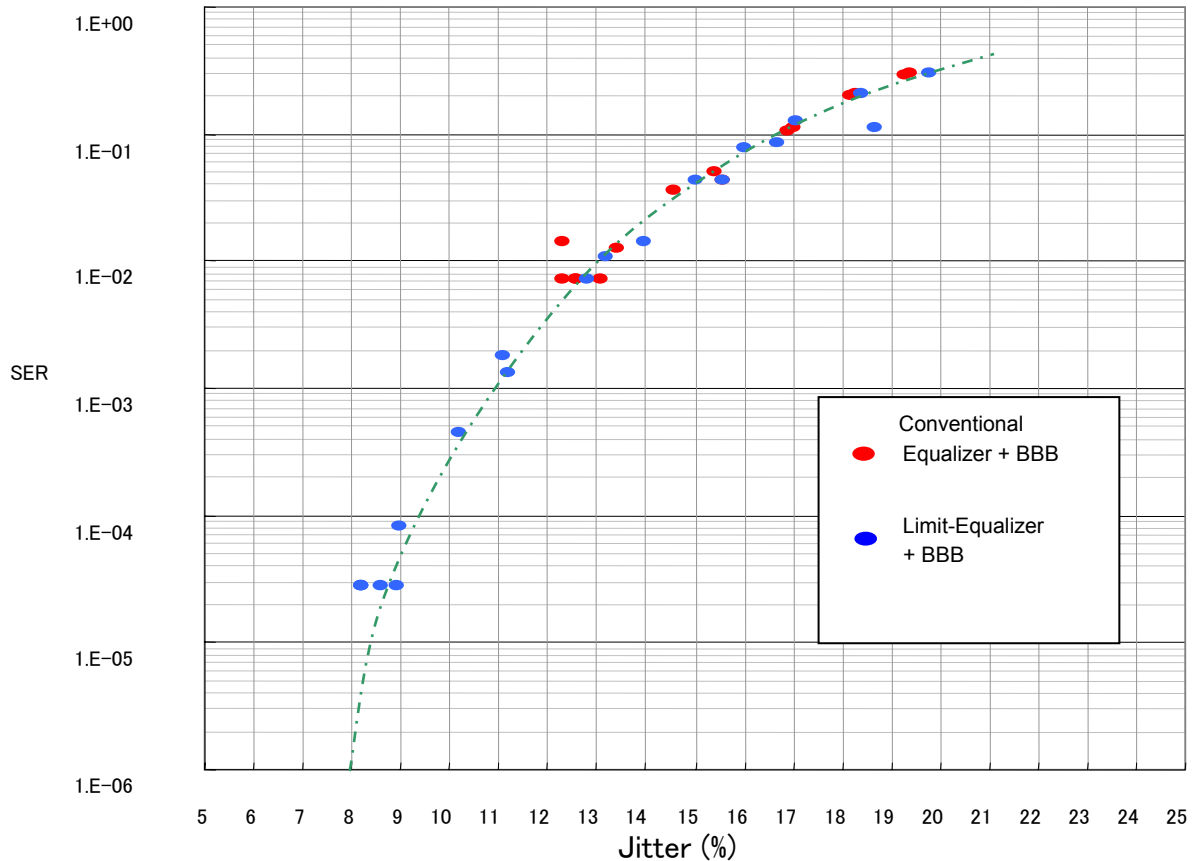

Fig.11-4 The relation of the error rate and Jitter of the Conventional Equalizer and the Limit-Equalizer

12: Disc manufacturing process

Currently a 3 to 3.5 sec. cycle time for BD-ROM disc manufacturing has been confirmed; as well as cost estimation compared to red DVD (1.1 times up for SL and 1.5 times up for DL). In this chapter the key technologies for disc manufacturing are explained.

12-1: Mastering

Three kinds of mastering systems are available now. Those three methods were used to make the test discs for the BD-ROM specification working group. The PTM (Phase Transition Metal) mastering system uses a blue laser diode as light source and it is a promising method to realize a compact and low cost mastering system. The deep-UV liquid immersion mastering system uses water between the high NA lens and the resist. It resembles a conventional mastering system and is already available from a European company. The electron beam recorder is more expensive but it gives the highest resolution. An electron beam recorder is currently available from a Japanese company.

12-1-1: PTM (Phase Transition Metal) mastering

The PTM Recorder

The basic concept of this technique is to use a special inorganic material that changes phase from as-deposited amorphous to crystal when exposed to laser light. The exposed or crystallized region becomes soluble in conventional developing fluid. The material is thus a kind of inorganic photo-resist.

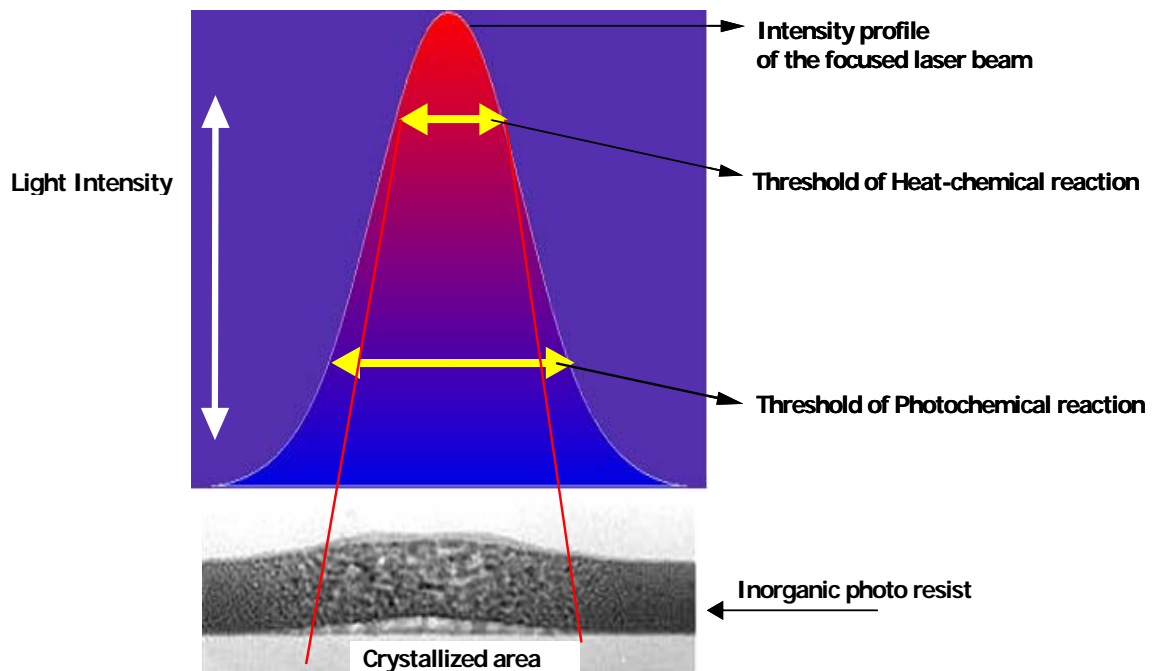

Fig.12-1 PTM recording mechanism

Figure 12-1 explains the mechanism of the cutting process. This inorganic material has sensitivity at a wavelength of 405nm, which is close to that of the conventional gas laser used for cutting CD and DVD signals. A 0.95 numerical aperture lens is employed in this recorder, which is

also implemented in conventional mastering systems. The phase change of this inorganic resist is induced through a heat-chemical reaction, not through a photochemical one. So only the material area that is heated above the threshold temperature reacts to the laser and gets crystallized. This is the reason why the Recorded Mark is smaller than the laser spot. A silicon wafer is used for the Substrate for sputtering this inorganic material mainly because of its moderate heat conductivity, which is larger than the conventional glass master but not by much. The optical pickup and the drive electronics for the laser of the PTM system are quite similar to those used in the Blu-ray™ recorder. We can apply a variety of multi-pulse write strategies to improve signal quality, if necessary. A change in reflectivity accompanies the Phase change process. So, we can watch the cutting performance during cutting just by observing the changes in reflectivity. Taking advantage of this, we can find out the optimum cutting condition easily and quickly with the PTM system. We no longer have to go through the whole mastering process to make a stamper in order to get feedback for a next trial cutting. Real time optimization of the cutting condition is one of the key features of the PTM system. Because its optical pick-up is similar to one for a conventional Blu-ray™ recorder, the PTM system is small, light, reliable and stable with low energy consumption. Plus, unlike the conventional cutters with gas lasers, no cooling water is needed at all.

The PTM process

As we use a silicon wafer and an inorganic photo-resist for PTM, we can make a stamper directly after developing the silicon wafer. In addition, because the inorganic photo-resist is hard and robust, we can multiply the original stamper as many as 10 times, simply by replicating, without any deterioration in signal quality. By use of relatively cheap and abundant silicon wafers for the master substrates, we succeeded in eliminating many of conventional processes like glass polishing, drop out checking, photo-resist coating, metal plating, metal mastering and mother fabrication. This simplification of the process provides us with numerous benefits of comprehensive cost reduction. These include, for example, cutting down the consumption of chemicals, minimizing the clean room footprint, elimination of inspection processes and reduction of utility and maintenance costs. Lastly, with fewer process steps made possible by PTM, reproducibility of the products will be improved dramatically. Thus PTM is an ideal mastering system both for mass production and for R&D (Figure 12-2).

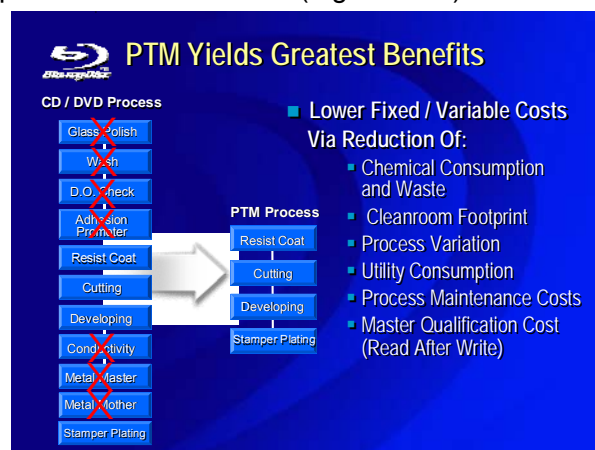

Fig.12-2 Great benefits for PTM process

White Paper Blu-ray Disc™ Format
1C. Physical Format Specifications for BD-ROM

12: Disc manufacturing process

SEM observation of the Ni stamper mastered with PTM reveals the characteristic shape of the Pits (Figure 12-3). A Push-Pull signal is used for radial tracking in the Blu-ray™ RE format. To make BD-ROM and RE compatible, it is preferable to define a Push-Pull signal in the BD-ROM format also. The Pit shape materialized by the PTM process is almost ideal in that we can reproduce excellent Push-Pull signals and RF signals from those Pits at constant Pit depth. A ROM disc was made for signal evaluation, forming a 0.1mm-thick Cover Layer in line with the basic concept of the Blu-ray™ format. Judging from the eye patterns and the jitter values, we can confirm the ROM signals mastered by PTM are compatible with the specifications for BD-RE. The signal properties also proved homogeneous over all disc radii (Figure 12-4). Also, in the Dual Layer structure, the signals mastered by PTM reveal equivalent properties (Figure 12-5). Furthermore, the discs made from the stamper of 10th replication show almost the same jitter values as the one made from the first stamper.



Fig.12-3 SEM photo of BD compared with CD and DVD

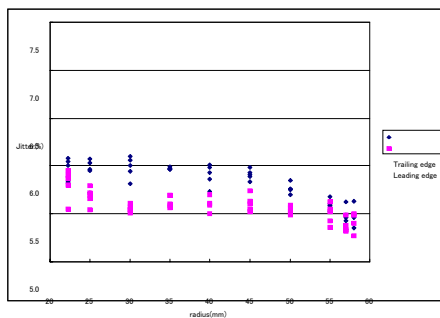
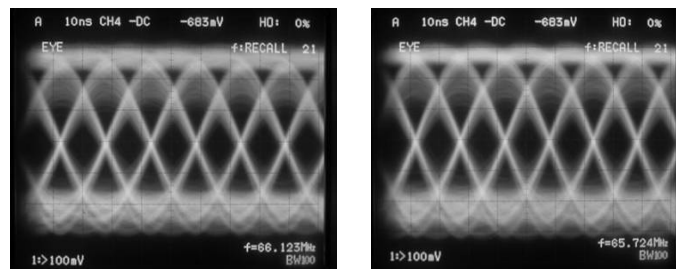

Fig.12-4 Jitter distribution



Layer 0 Layer 1
 Jitter 5.6 % Jitter 5.8 %
 (Limit-Equalizer)

Fig.12-5 Jitter of Dual Layer

12-1-2: Deep-UV Liquid Immersion mastering

Introduction

One of the greatest advantages of optical discs such as CD and DVD is the ease and low costs of ROM reproduction. Mastering is the key step in making the stamper from which ROM discs are replicated. For the Blu-ray Disc™ generation, evolutionary optical disc mastering equipment as yet is unable to write the 25 GB ROM required in BD-ROM because of the size of the writing spot.

Liquid immersion is an elegant solution to this problem, adding to the advantages of optical disc mastering without too large impact on existing infrastructure.

Method and Results

The small spot necessary to write the tiny pits in BD-ROM can be made using the Liquid immersion principle, well known in microscopy. At first sight, Liquid immersion seems impractical in a mastering machine with high writing velocities and with high demands on mechanical stability. However, the solution developed eliminates these issues, as is illustrated in Figure 12-6 and Figure 12-7. A minimal amount of liquid, in total 30 ml per 25 GB disc, is injected upstream of the writing spot and removed downstream. The resulting system is very much like a normal laser beam recorder as is applied in CD and DVD mastering. Figure 12-8 shows an AFM image of the resulting Pits and Figure 12-9 shows the corresponding read-out signals. The jitter is better than 5%, which is well below the limit of 6.5%.

Cross-Section

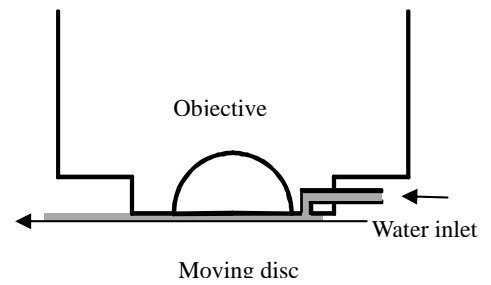

Bottom view

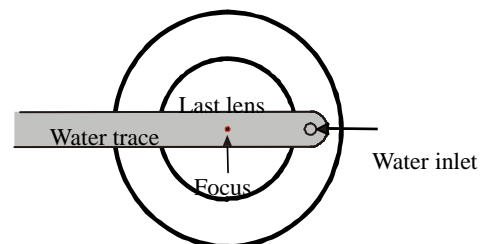

Fig.12-6 Liquid immersion concept

Concluding remarks

Liquid immersion mastering is an optical mastering solution capable of mastering BD-ROM without too large impact on existing mastering infrastructure.



Fig.12-7 Bottom element of Liquid immersion objective.

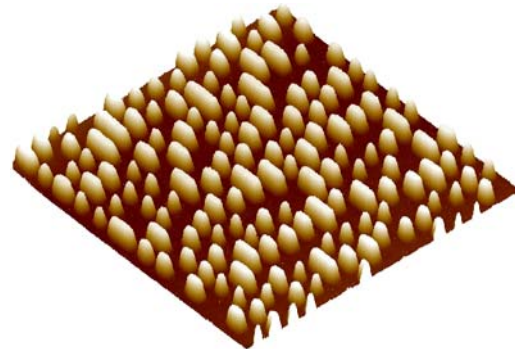

Fig.12-8 AFM measurements of 25 GB

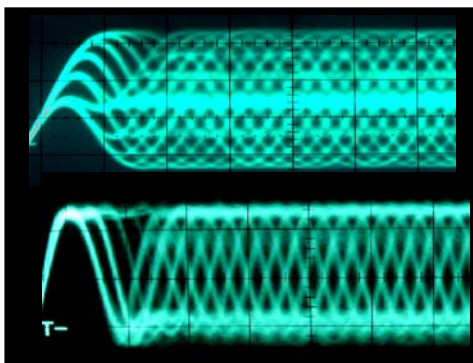

Fig.12-9 Eye-pattern without and with Limit-Equalizer

12-1-3: Electron beam mastering

High-resolution performance of a mastering machine is required to produce high density optical discs. A conventional-type Laser Beam Recorder (LBR) can not master a high density optical disc because of its low resolution performance. To improve resolution, the Electron Beam Recorder (EBR), which has an electron-emitting source, was developed. The outline of the EBR developed by PIONEER Corporation is explained as an example. Its schematic illustration is shown in Figure 12-10. A work chamber is supported with the vibration control unit which works as the foundation. The electron beam column is mounted on the center of the work chamber. The secondary electron detector is on one side of the column. An illumination part and a detection part of a height sensor are located on opposite sides of the column.

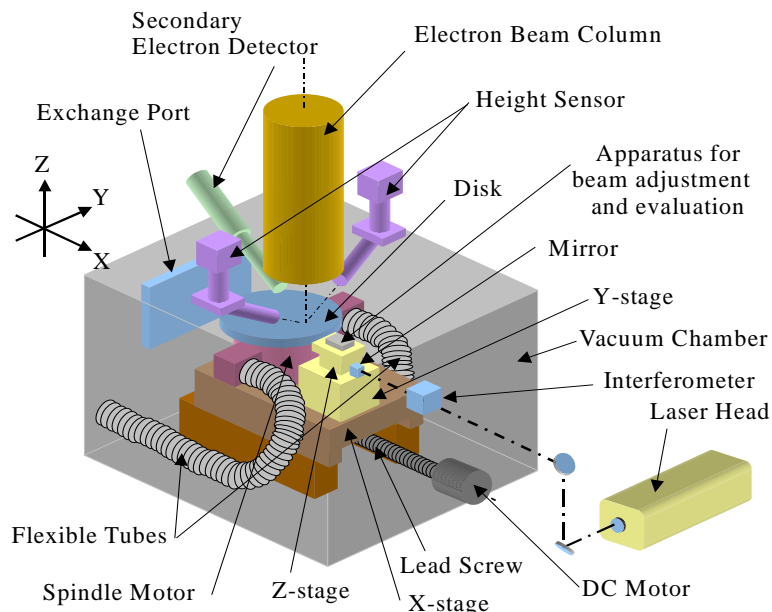

Fig.12-10 Schematic view of PIONEER EBR

A carriage stage moves in the X-direction by a dc motor and a lead screw. A vacuum sealed air spindle motor is mounted on the top of the stage. The emitting source is a thermal field emitter (TFE). The electron beam emitted from the TFE is focused onto the disc surface with two lenses within the column. Using a 6 m-rad convergence semi-angle with 50 keV beam energy, a beam current and a beam diameter (full width half maximum) are measured as 130 nA and 55 nm respectively. Beam modulation is carried out by a pair of blanking plates, arrayed in the column, with a rise time of about 10 ns. Surface vibration and the height of the disc are constantly measured during recording by the optical height sensor. Beam focus is controlled at the disc surface by adjusting the focal distance according to the signal information from the optical height sensor. The recording position in the track direction is controlled as follows. The stage position is determined by measuring a mirror position placed on the stage with a laser interferometer. The residual error signal of a position servo system is fed forward to the dc motor and also to the beam deflector in the column. Thus, the recording track position is corrected with the beam deflection.

Figure 12-11 shows the spiral recording patterns made by using the EBR. Figure 12-11 (a) shows the pit pattern of a 25 GB ROM disc. The recording parameters are a 320nm-Track Pitch and 149 nm minimum Pit length. A jitter value below 5% was achieved. Though apart from BD

specifications, Figure 12-11 (b) and (c) show the high density recording possibility of EBR, with Pit and line patterns at a 3 mrad convergence semi-angle. The EBR is confirmed as a promising technology for advanced high density recording. The development of the EBR with high resolution performance is almost complete, and development and commercialization of the EBR are going ahead in consideration of future disc mass production. EBR is available through PFA (Pioneer FA), Japan now. For electron beam recording, the key remaining issue is the efficiency of mass production caused by slower recording speeds. It requires about 10 hours to record a full size disc using a conventional-type resist. As one solution for this issue, using a chemically amplified resist is a promising scheme to greatly improve the efficiency of mass production. Several companies reported recording experiments at over 2.5 m/s speed at a recent international conference on optical discs. The possibility of real time recording is expected by selecting a suitable resist for optical disc mastering and by improving the recording strategy.

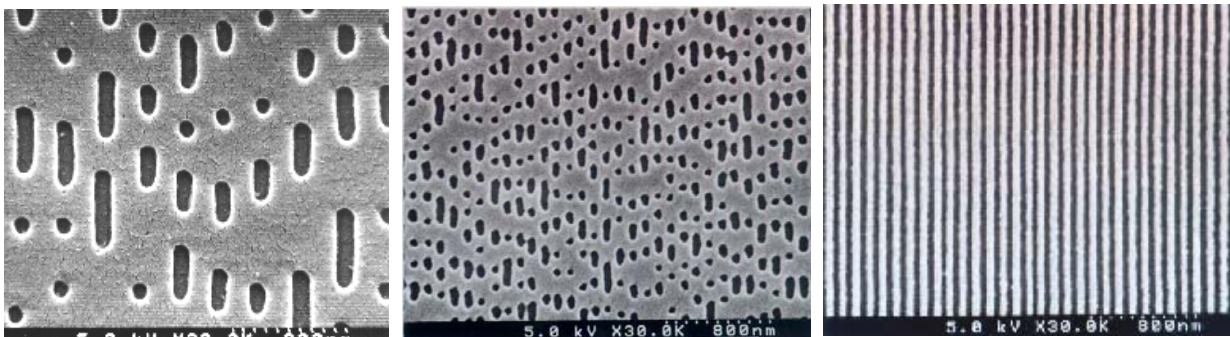

Fig.12-11 (a) 25GB ROM (b) 201 GB ROM (c) 50 nm line and space

12-2: Disc Replication process

The Replication process

Figure 12-12 shows a manufacturing process for a Single Layer disc. The injection-molded Substrate cools down while moving to the bonding unit. Then the Reflective Layer is formed on the Substrate by sputtering. The Reflective Layer is covered with UV-curable resin by spin coating. Next the outer round area of the Resin Layer is heated by IR irradiation so that its viscosity is decreased.

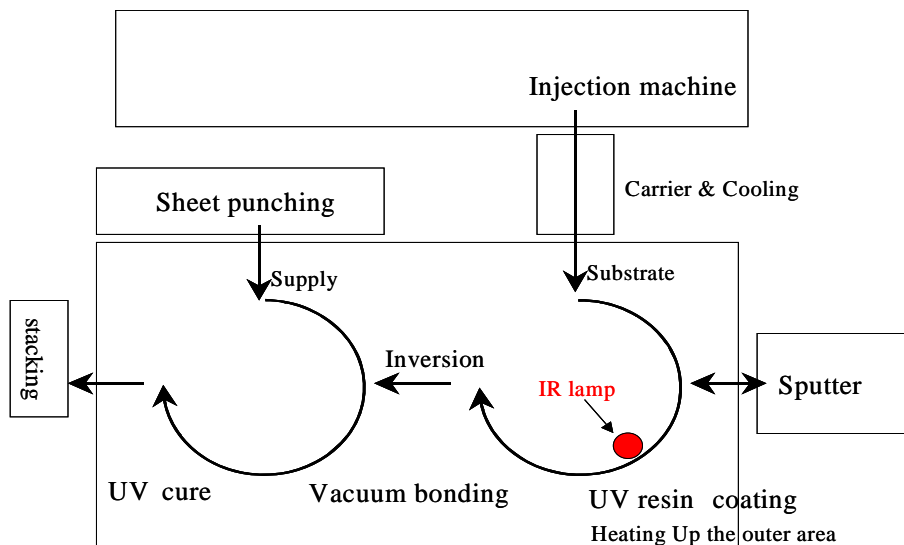

Fig.12-12 Single Layer process

White Paper Blu-ray Disc™ Format
1C. Physical Format Specifications for BD-ROM

12: Disc manufacturing process

In the meantime Cover sheets are punched out from a roll and supplied to another rotating part of this unit one after another. The Substrate with UV resin is turned over and set on the Cover sheet. Finally, the Cover sheet is glued to the Substrate by curing the resin through UV irradiation.

Figure 12-13 shows the variation of the Cover Layer thickness of a disc that satisfies the specification. Figure 12-14 shows the thickness variation of 3,000 discs produced by this process consecutively. Figure 12-15 shows disc warp caused by a sudden environmental change from 30 deg.C and 90%RH to 23 deg.C and 50%RH. We confirmed that the disc warp was well within the

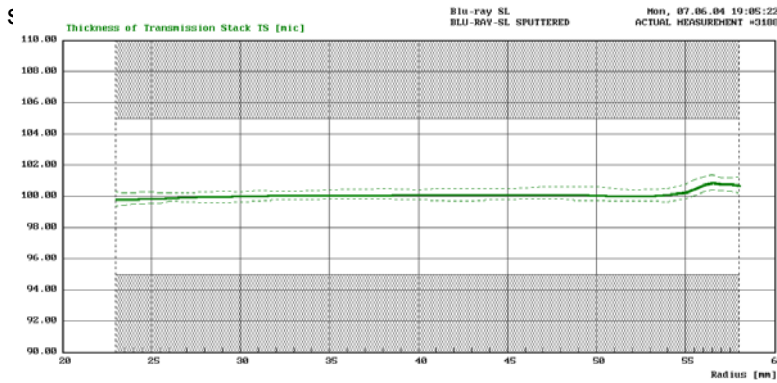

Fig.12-13 Thickness variation

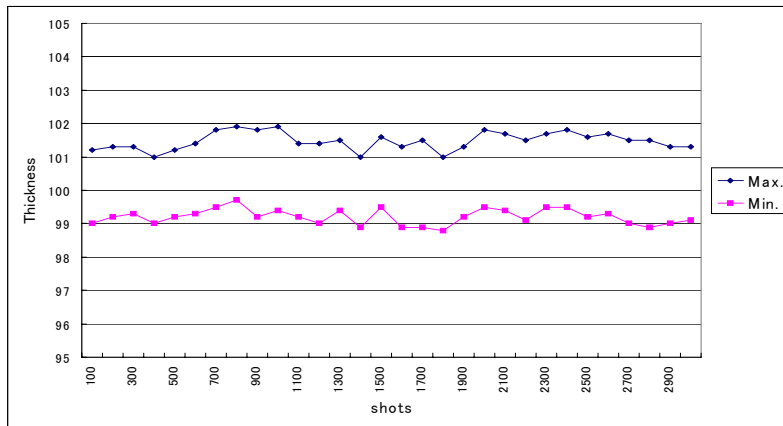

Fig.12-14 Cover thickness variation for a 3,000 disc series

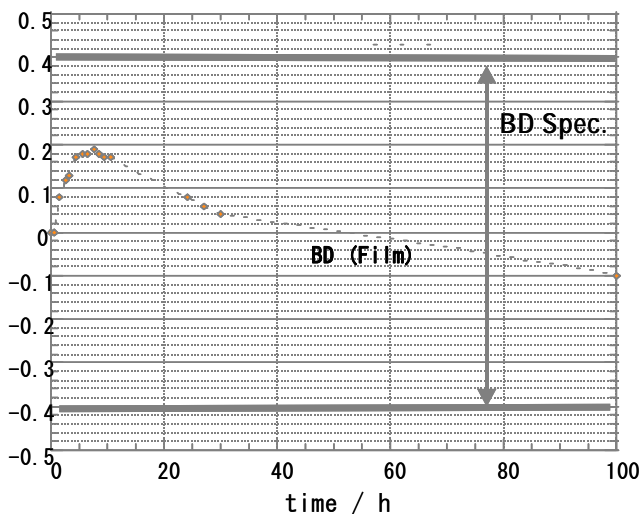

Fig.12-15 Disc warp in sudden environmental change

30°C、90%RH、3days→23°C、50%RH (r = 57mm)

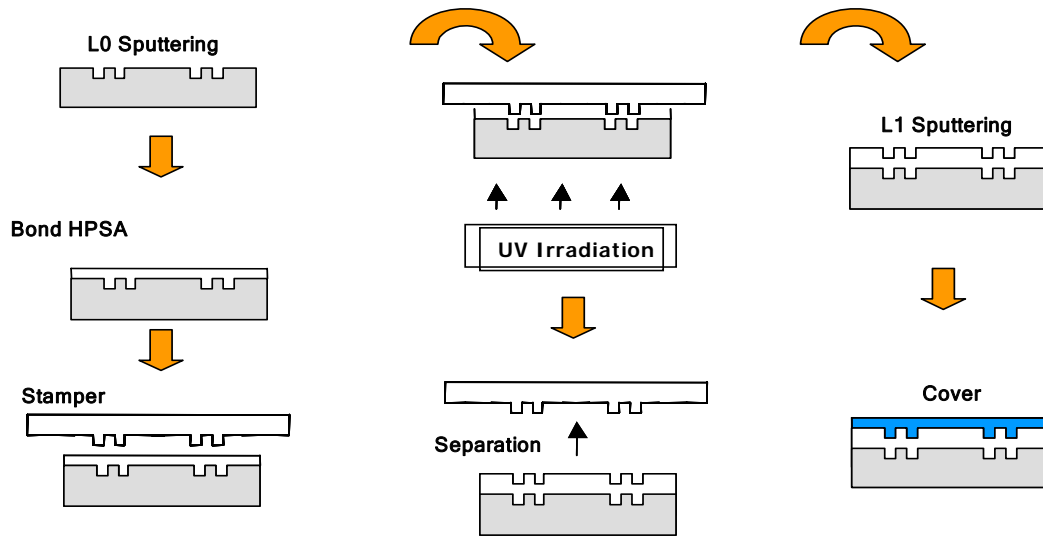

Fig.12-16 Manufacturing process for the Dual Layer disc

Figure 12-16 shows a manufacturing process for a Dual Layer disc. L0 Layer is formed on the Substrate by sputtering first and the Space Layer, which is made of UV-curable adhesive called HPSA (Hardenable Pressure-Sensitive Adhesive), is formed on it by pressure-bonding. A stamper is set on the HPSA and pressed for replicating the signal Pits. Then UV light is irradiated from the underside. After that, the stamper is removed and the semi-reflective L1 Layer is sputtered on the HPSA. The Cover Layer process is then the same as one for the Single Layer disc. Jitter data for Dual Layer discs is already shown in Figure 12-5. Figure 12-17 to Figure 12-20 show the thickness variation of a typical Cover Layer, a typical L1 Layer, a series of 1000 L1 Layers, a typical L0 Layer and a series of 1000 L0 Layers, respectively.

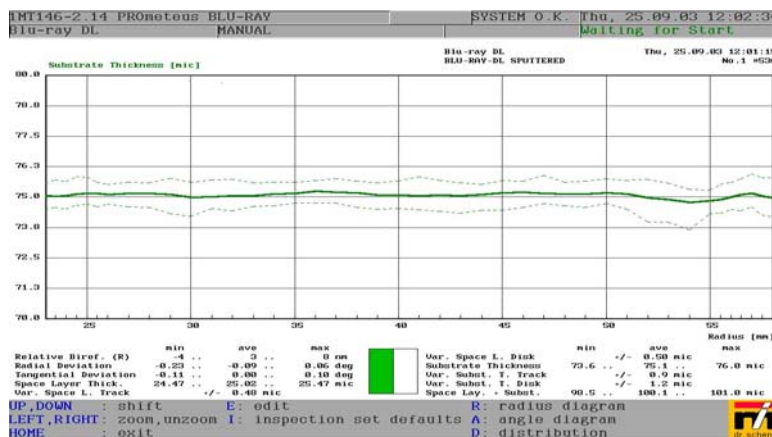

Fig.12-17 Thickness variation of L1 Layer

White Paper Blu-ray Disc™ Format

1C. Physical Format Specifications for BD-ROM

12: Disc manufacturing process

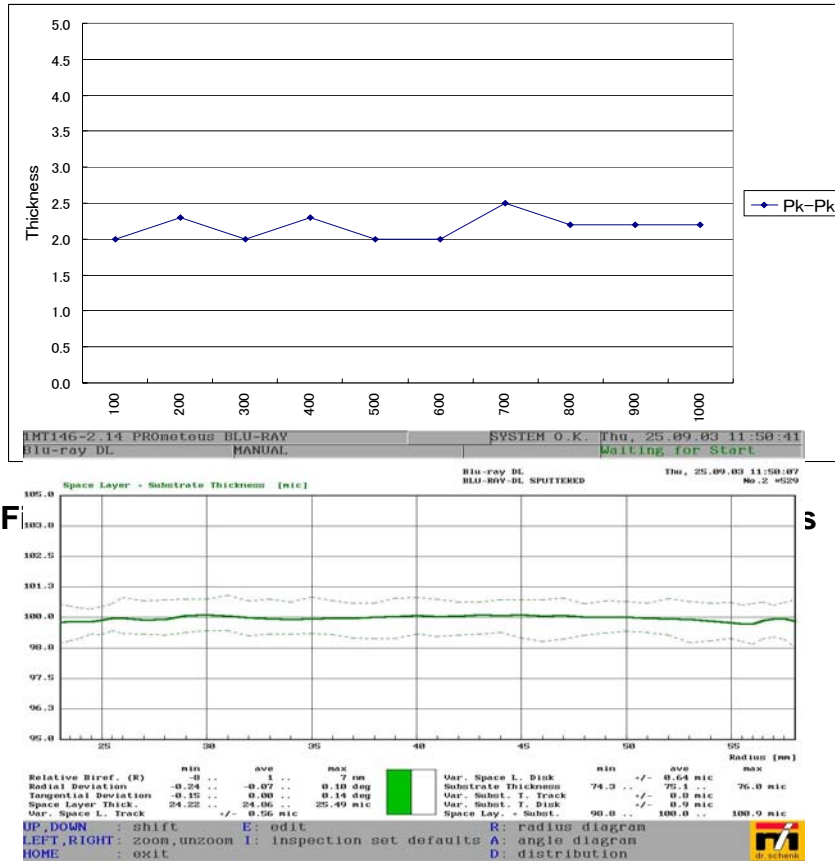

Fig.12-19 Thickness variation of a L0

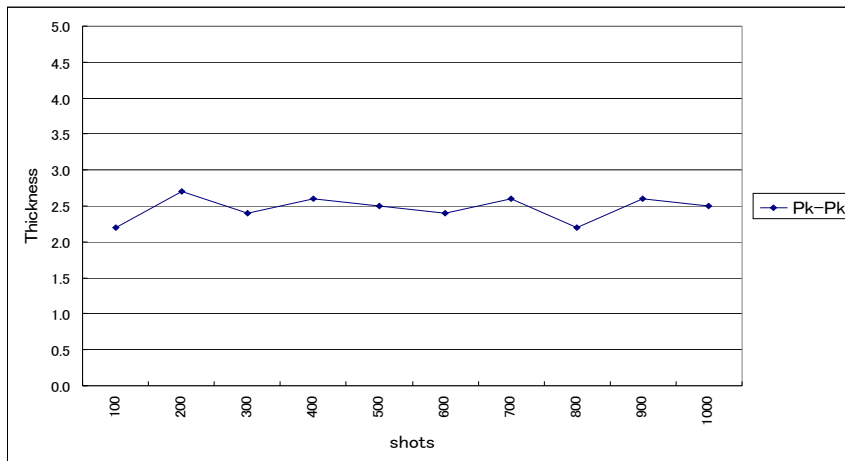

Fig.12-20 L0 thickness variation for a 1000 disc series

White Paper Blu-ray Disc™ Format
1C. Physical Format Specifications for BD-ROM

12: Disc manufacturing process

Lastly, Figure 12-21 compares the main specifications with a typical result.

		BD-ROM specifications	Measured result
Scanning Velocity	[m/s]	4.92	4.92
Disc unbalance	[gmm]	< 4.0	1
Disc mass	[g]	12 to 17	15.6
Space Layer thickness	[μm]	20 to 30	24 to 26
Cover Layer thickness variation	[μm]	± 3	± 1.2
Refractive index		1.45 to 1.70	1.61
Radial tilt	[°]	1.60 p-p	0.80 p-p
Birefringence	[nm]	30	10
Reflectivity of SL	[%]	35 to 70	50
Reflectivity of DL	[%]	12 to 28	20
Lead-in start radius	[mm]	22.0 +0.2, -0	22
Data start radius	[mm]	24.0 ;0, -0.1	24
Radial run-out of DL	[μm]	75 p-p	50 p-p
Radial LF residual error	[nm]	9	7
Radial HF residual error	[nm]	6.4 rms	4 rms
Jitter L0 (Limit-Equalizer)	[%]	6.5	5.8
Jitter L1(Limit-Equalizer)	[%]	8.5	6.5
Asymmetry		-0.10 to +0.15	+0.08
Symbol Error Rate		2 X 10 ⁻⁴	1 X 10 ⁻⁵

White Paper Blu-ray Disc™ Format
1C. Physical Format Specifications for BD-ROM

13: Representative parameters

13: Representative parameters

The following charts show the representative specifications of BD-ROM. They are divided into the categories of Disc structure, Capacity related items, Measuring condition, Mechanical parameters, Optical parameters and Operational signals.

Disc Structure		
Single sided disc Both Single Layer disc(SL) and Dual Layer disc(DL)		
Recording method		In-pit / On-pit
BCA	[mm radius]	21.0 to 22.2
Lead-in Area	[mm radius]	22.0 to 24.0
Data Area	[mm radius]	24.0 to 58.0
Scratch resistance		Taber abrasion test
Capacity related items		
Total capacity SL (DL)	[GB]	25.0 (50.0)
User bit rate	[Mb/s]	35.965
Channel bit rate	[Mb/s]	66.000
Shortest Pit length	[nm]	149.0
Linear Velocity @ 1x	[m/s]	4.917
Track Pitch	[μm]	0.32
Measuring condition		
Wave length	[nm]	405 ± 5
NA		0.85 ± 0.01
Polarization		circular
Rim intensity		
Radial	[%]	60 ± 5
Tangential	[%]	65 ± 5
Wave front aberration		[λ rms] 0.033
Relative intensity noise of the laser		-125 dBHz max.
Normalized detector size	[μm ²]	S/M ² ≤ 25
Read power	[mW]	0.35 ± 0.1

White Paper Blu-ray Disc™ Format
1C. Physical Format Specifications for BD-ROM

13: Representative parameters

Mechanical parameters		
Radial tracking		
Run-out SL and DL	[μm]	75 p-p max.
LF residual error (SL)	[nm]	9 max.
HF residual error(SL)	[nm]	6.4 rms max.
Axial tracking		
Run-out [mm]		0.3 max.
LF residual error	[nm]	45 max.
HF residual error	[nm]	32 rms max.
Disc thickness	[mm]	0.9 to 1.4
Disc mass	[g]	12 to 17
Disc unbalance	[gmm]	≤ 4.0
Disc radial tilt (α angle)	[$^\circ$]	1.60 p-p max.
Disc tangential tilt (α angle)	[$^\circ$]	0.60 p-p max.
Optical parameters		
Cover Layer		
Thickness (SL)	[μm]	100
Thickness (DL)	[μm]	75
Thickness variation	[μm]	≤ 3.0
Space Layer		
Thickness (DL)	[μm]	25 ± 5
Thickness variation including Cover Layer	[μm]	≤ 3.0
Substrate		
No requirement		
Reflectivity SL	[%]	35 to 70 / 12 to 28
Reflectivity DL	[%]	12 to 28
In-plane birefringence	[$\Delta n_{//}$]	$\leq 1.5 \cdot 10^{-4}$
Perpendicular birefringence	[Δn_{\perp}]	$\leq 1.2 \cdot 10^{-3}$
Refractive index		1.45 to 1.70
Operational signals		
Limit-Equalizer Jitter [%]		
SL disc		≤ 6.5
DL L0		≤ 6.5
DL L1		≤ 8.5
Symbol Error Rate without defects		$< 2 \times 10^{-4}$
Defect size (black dot with birefringence)	[μm]	< 300
Asymmetry		-0.10 to +0.15
DPD		0.28 to 0.62
Push-Pull		0.10 to 0.35
Track cross		≥ 0.10

White Paper Blu-ray Disc™ Format
1C. Physical Format Specifications for BD-ROM

14: SID code

14: SID code

The SID (Source Identification) code is a code to be recorded at the inner part of a disc. It is made up of visible characters that identify the manufacturer of the disc. There are two kinds of codes: a Mastering Code and a Mold Code.

The Mastering Code is created by using the master recorder, so this code will be present on the stamper.

The Mold Code is etched on the mirror block side of the mold.

When a Substrate is replicated, the Master Code will appear on the same side of the Substrate as the embossed Pits, the Mold Code will appear on the opposite side of the Substrate.

These 2 codes can be used to trace the location where discs are made.

Figure 14-1 shows an example of the Mold Code.

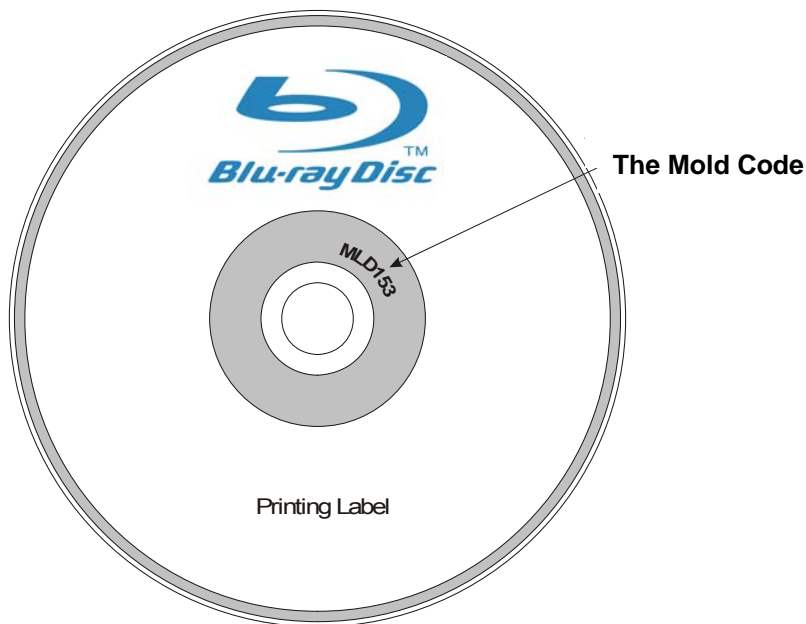

Fig. 14-1 An example of the Mold Code

15: BCA

The zone between radius 21.0 mm and 22.2 mm is reserved to be used as an optional Burst Cutting Area (BCA) defined by the application. The BCA is used to add unique information, such as the serial number, to the individual disc after completion of the manufacturing process. The BCA-code can be written by a high-power laser system.

The BCA-code is recorded in CAV mode. Then BCA-code is written as a series of low-reflectance stripes arranged in circumferential direction. Figure 15-1 shows the schematic representation of the BCA.

At the early stage of DVD, BCA was recorded by using a YAG laser. But the YAG laser is expensive and the lifetime of YAG laser is not long enough. For the BCA cutting of BD-ROM a cutting system using a high power laser diode was used in order to make the low cost manufacturing system. Due to the limited power of the laser diode there remained some small dots reflective layer material in the BCA striped part. Those dots were the cause of HF noise in the reproduced BCA signal. To remove the HF noise a low pass filter is used for the measurement system of BCA and drives as shown in Figure 15-2.

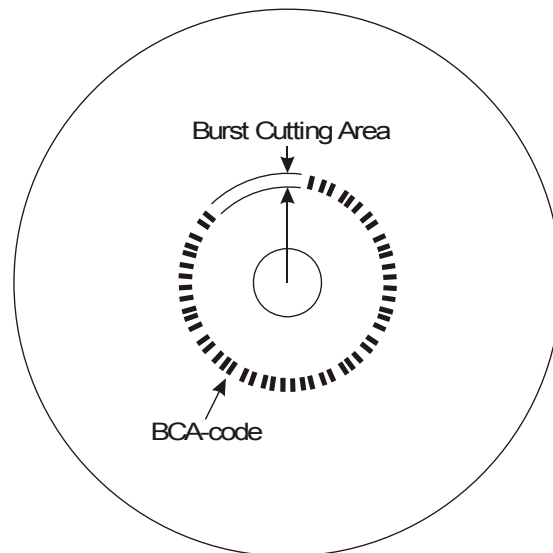

Fig. 15-1 Schematic representation of the BCA

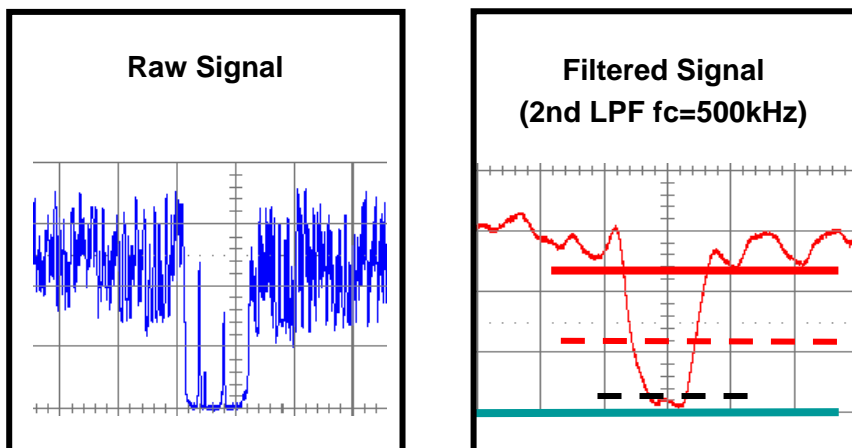

Fig. 15-2
BCA
measurement
with LPF

16: Random Symbol Error Rate (RSER) measurement

ECC is designed to recover the correct data from the data damaged by defects. But ECC ability for correcting data in a disc is used not only for defects but also for the random error in a disc. In order to guarantee the ECC power for the user oriented defects such as fingerprints and scratches, both the Random Symbol Error Rate (RSER) of a disc and defects should be specified. Roughly more than half of the ECC power is reserved for the user oriented defects.

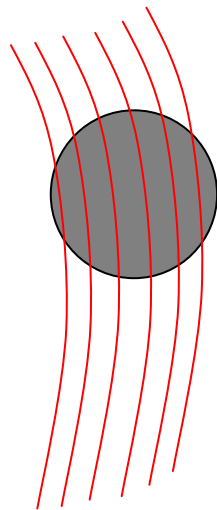

Fig.16-1 The multiple error count due to a defect

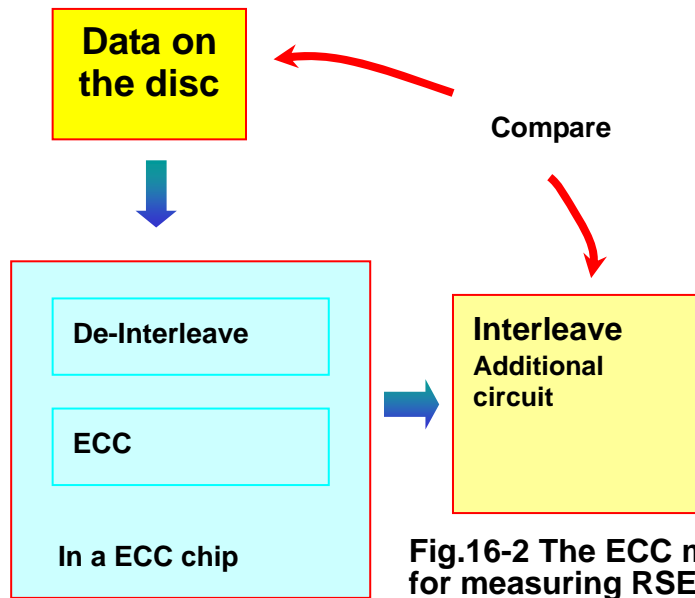

Fig.16-2 The ECC method for measuring RSER

The RSER for judging the system margin is 4.2×10^{-3} . This value is derived from the worst condition that all degradations of a disc and a drive occur simultaneously. Thus such a value is too high for the RSER value in which ECC works. The RSER of 1.0×10^{-3} was used for DVD. The value corresponds to a boundary condition + some degradation such as the worst radial tilt with some tangential tilt and some defocus in a rather bad drive. In the BD system a Viterbi decoder is located between the retrieved HF signal and an ECC circuit. The Viterbi decoder has the ability of the SNR improvement and it can reduce the RSER value below 1/10. The measurement circuit Limit-Equalizer also can improve SNR as same as the Viterbi decoder and it also can reduce the RSER value below 1/10. For the RSER value of a disc measured after the Limit-Equalizer a value of 2.0×10^{-4} is specified, which is 1/5 of 1.0×10^{-3} . In order to measure RSER the degradation due to the defects should be taken out. At the development stage the averaging in a large ECC Blocks was used for removing the effects of defects. But the averaging method was not enough for measuring such a low RSER value. In the inner radius there are 2.11 ECC Blocks within one rotation. If there is a large defects as shown in Figure 16-1 then some 100 bytes errors are counted in every 2.11 ECC Blocks. That is the reason why the measured RSER jumped up around a defect.

Then it was decided to separate the defects and the RSER in the measurement method. Considering the ECC ability the allowed defects in an ECC Block (In the specification the block is called LDC Block.) is specified as 600 bytes in total and the maximum number of defects is

specified as 7. From the measured RSER the consecutive errors longer than or equal 40 bytes are excluded. 40 bytes is the length of the 2 BIS (Burst Indicating Subcode) + data between BIS (38 bytes) and it corresponds to the minimum burst error length BIS can detect. In order to detect the burst error correctly the ECC method measurement as shown in Figure 16-2 is used. The correct data can be obtained after an ECC. By using additional circuit for the measurement the correct data after ECC are interleaved in order to get the correct data allocation on a disc. It is compared with the data on a disc and the erroneous symbols are identified.

There are many cases where some correct bytes exist between the erroneous bytes. Figure 16-3 shows an example of an error pattern. In order to judge the 40 bytes burst error length the following procedure was specified. The burst starts after the correct bytes longer than or equal 3 bytes. The error length count continues if the correct bytes length between error bytes is less than or equal 2. The error length count stops if there appears correct bytes longer than or equal 3 bytes. Though the error length includes the correct bytes less than or equal 2 bytes, those correct bytes are excluded from the number of the erroneous bytes.

The errors longer than or equal 40 bytes are excluded from both the numerator and the denominator of the RSER calculation. But the burst errors below 40 bytes are still included in the erroneous bytes. Although RSER is averaged over 10000 ECC Blocks, for the measurement 1000 Blocks averaging is allowed if the disc shows good RSER.

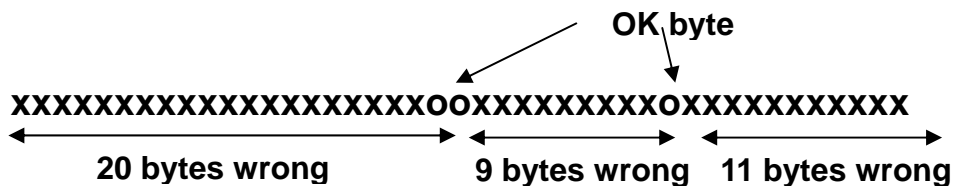

Fig.16-3 An example of the error pattern

17: Hybrid disc

Hybrid discs within BD families such as the Dual Layer discs with the combination of BD-ROM Layer and BD-R Layer can be considered. The feasibility of this type of Hybrid discs, which is called as Intra-Hybrid disc, still has to be confirmed by the BDA. Therefore, the specifications for Intra-Hybrid discs are reserved in the current physical specifications of BD-ROM.

Hybrid discs with the combination of BD-ROM Layer and other type layer such as DVD-ROM Layer or CD-ROM Layer are also possible. This ROM-ROM type Hybrid disc combination is defined in the BD Hybrid disc specifications. Figure 16-1 shows the examples of ROM-ROM type Hybrid discs. At the 0.1 mm depth from the surface there is BD-ROM Layer. The DVD-ROM Layer is located at 0.6 mm depth and the CD-ROM Layer at 1.2 mm depth. These layers can be read from one side of a disc. The CD-ROM and DVD-ROM Layers should satisfy the relevant specifications (ISO/IEC 10149, ISO/IEC 16448/16449) so that legacy players can recognize and read these layers as CD-ROM and DVD-ROM. However, the readability of the CD and DVD Layers does not only depend on the quality or conformance of the CD and DVD Layers itself. Another condition is that the BD-ROM Layer(s) should be almost transparent at the wavelength of 780 nm or 650 nm. On the other hand BD-ROM Layer(s) should have enough reflectivity at 405 nm. In order to realize this requirement, the low reflectivity range of 12-28 % is allowed for a Single Layer BD-ROM.

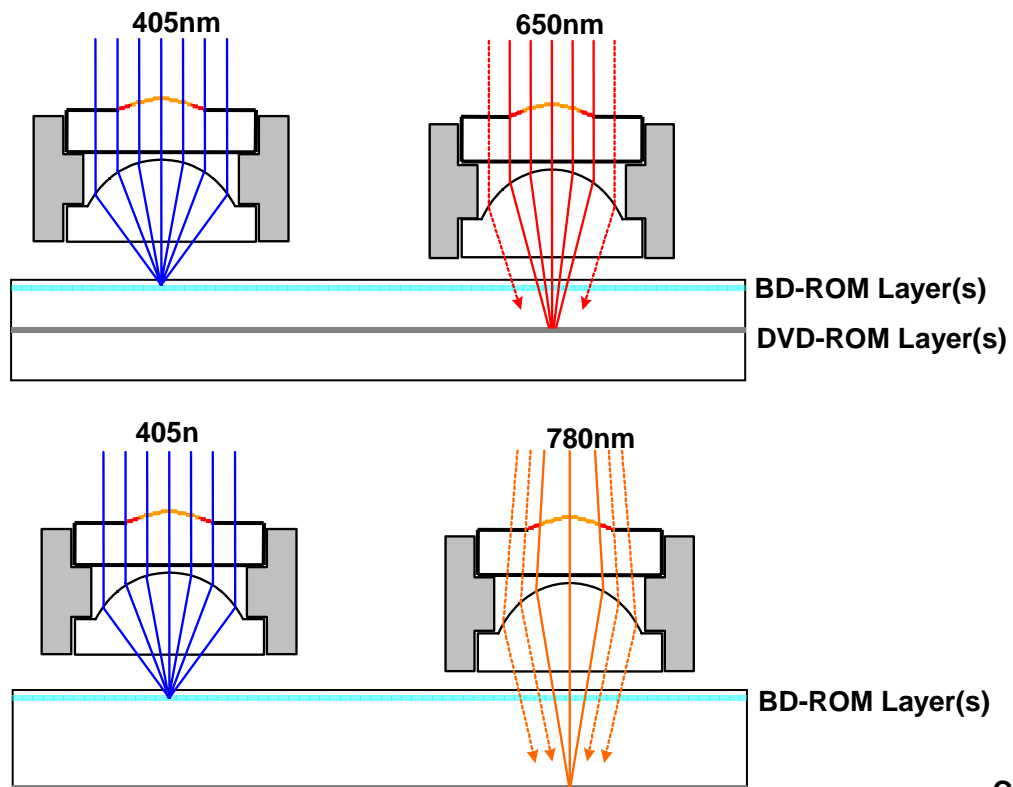

Fig. 16-1 Examples of ROM-ROM type Hybrid discs

There is a possibility for BD/DVD/CD compatible drives that they first focus in DVD-ROM or CD-ROM Layer of a Hybrid disc and never going to read BD-ROM Layer. In order to prevent such a problem, the Hybrid disc information (existence of DVD-ROM or CD-ROM Layer) is recorded in the Disc Information in PIC Zone and copied to the optional BCA. A drive is recommended to read such DI information of Layer 0 (either in PIC Zone or BCA or both) at the start up procedure.

White Paper Blu-ray Disc™ Format
1C. Physical Format Specifications for BD-ROM

18. DVD Read-Only disc with an AV application
according to the BD Read-Only System Description Part3, with capacities of 4.7 or 8.5 GB

18: DVD Read-Only disc with an AV application according to the BD Read-Only System Description Part3, with capacities of 4.7 or 8.5 GB

DVD Read-Only Disc with an AV application according to the BD Read-Only System Description Part3, with capacities of 4.7 or 8.5 GB was included in BD-ROM disc specifications as the mandatory specifications for the BD-ROM disc. Basically the physical specifications of this disc refer ECMA-267 (ISO/IEC16448). The only physical difference is the dynamic imbalance. The value of the dynamic imbalance was changed from 0.01 g.m. to 0.0044 g.m.. This disc should be rotated at 3X speed or more to satisfy the maximum transfer rate of 30.24Mbit/sec. Then for the practical implementation of a drive the relevant system parts such as: servo systems, PLL (Phase Lock Loop), Equalizer, slicer bandwidth, filter characteristics, etc. have to be scaled accordingly relative to the values given in the ECMA-267.

19: Recommendation for the maximum read power of BD-ROM devices

In 2006, the BDMV application was extended to include BD-R and BD-RE, allowing a BD player to retrieve video from all disc types (i.e. BD-ROM/R/RE). Therefore, as a precaution to prevent possible damage to discs, a recommendation for the maximum read power was added in System Description Blu-ray Disc™ Read-Only Format Part1 Basic Format Specifications Version 1.31. In Clause 1.4.2 (Conformance of devices) it is recommended, that the maximum read power* of BD-ROM devices shall not exceed the read powers defined in the read stability test of System Description Blu-ray Disc™ Rewritable Format Part1 or in the read stability test of System description Blu-ray Disc™ Recordable Format Part1. (* *Read power at intermediate speed can be obtained by interpolation.*)

20: Conclusions

In this BD-ROM White Paper the design considerations that played a role in determining the format parameters are explained. A short list of format parameters and format characteristics has been included. The technical experts of the Blu-ray Disc Association are confident that they have succeeded in realizing what they set out to achieve: defining a long-term solution for High-Definition movie distribution on blue laser discs.