



# **OpenMAX Development Layer API Specification**

Version 1.0.2

Copyright© 2005-07, The Khronos Group Inc.

Dec. 21, 2007

Document version 1.0.2

| Version | Date        | Version Information   |
|---------|-------------|---|
| 1.0     |             | Originate   |
| 1.0.1   | 30-Jun-2006 | Minor clarifications and bug fixes; motion compensation primitives added to domain omxVC  |
| 1.0.2   | 21-Dec-2007 | Minor clarifications and changes to resolve the following Khronos Bugzilla ( <a href="http://cvs.khronos.org/bugzilla">http://cvs.khronos.org/bugzilla</a> ) entries: 522, 523, 633, 634, 641, 703, 704, 718, 719, 736, 754, 756, 757, 778, 802, 806, 831, 872, 873, 880, 1089, 1112, 1113, 1120, 1134, 1136, 1137, 1138, 1191, 1193, 1195, 1196, 1199, 1200, 1201, 1202, 1206, 1209, 1210, 1213, 1214, 1215, 1218, 1219, 1250, 1255, 1264, 1265, 1272, 1300, 1304, 1305, 1306, 1335, 1336, 1351, 1363, 1364, 1365, 1371, 1373, 1374, 1403, 1404, 1430, 1456, 1676, 1678, 1688, 1740, 1819, 1857, 1888, 1911, 1912, 1929, 1946, 1958, 1982, 2094, 2103, 2128, 2199, 2202, 2209, 2225, 2226, 2230, 2337, 2339, 2367, 2543, 2578, 2579, 2580, 2665, 2666, 2710, 2713, 2726, 2728, 2729, and 2741. |

Copyright © 2005-07 The Khronos Group Inc. All Rights Reserved.

This specification is protected by copyright laws and contains material proprietary to the Khronos Group, Inc. It or any components may not be reproduced, republished, distributed, transmitted, displayed, broadcast, or otherwise exploited in any manner without the express prior written permission of the Khronos Group. You may use this specification for implementing the functionality therein, without altering or removing any trademark, copyright or other notice from the specification, but the receipt or possession of this specification does not convey any rights to reproduce, disclose, or distribute its contents, or to manufacture, use, or sell anything that it may describe, in whole or in part.

Khronos Group grants express permission to any current Promoter, Contributor or Adopter member of Khronos to copy and redistribute UNMODIFIED versions of this specification in any fashion, provided that NO CHARGE is made for the specification and the latest available update of the specification for any version of the API is used whenever possible. Such distributed specification may be reformatted AS LONG AS the contents of the specification are not changed in any way. The specification may be incorporated into a product that is sold as long as such product includes significant independent work developed by the seller. A link to the current version of this specification on the Khronos Group website should be included whenever possible with specification distributions.

Khronos Group makes no, and expressly disclaims any, representations or warranties, express or implied, regarding this specification, including, without limitation, any implied warranties of merchantability or fitness for a particular purpose or non-infringement of any intellectual property. Khronos Group makes no, and expressly disclaims any, warranties, express or implied, regarding the correctness, accuracy, completeness, timeliness, and reliability of the specification. Under no circumstances will the Khronos Group, or any of its Promoters, Contributors or Members or their respective partners, officers, directors, employees, agents or representatives be liable for any damages, whether direct, indirect, special or consequential damages for lost revenues, lost profits, or otherwise, arising from or in connection with these materials.

SAMPLE CODE, EXAMPLES, and INFORMATIVE TEXT as identified herein, are expressly depicted herein with a “grey” watermark and are included for illustrative purposes only and are expressly outside of the Scope as defined in Attachment A - Khronos Group Intellectual Property (IP) Rights Policy of the Khronos Group Membership Agreement. A Member or Promoter Member shall have no obligation to grant any licenses under any Necessary Patent Claims covering SAMPLE CODE, EXAMPLES, and INFORMATIVE TEXT.

Khronos and OpenMAX are trademarks of the Khronos Group Inc.

Version 1.0.2 – Dec. 21, 2007

# Table of Contents

---

|   |          |
|---|----------|
| <b>1.0 Overview.....</b>                                  | <b>1</b> |
| <b>1.1 Introduction.....</b>                              | <b>1</b> |
| 1.1.1 About the Khronos Group .....                       | 1        |
| 1.1.2 A Brief History of OpenMAX .....                    | 1        |
| <b>1.2 The OpenMAX Development Layer .....</b>            | <b>1</b> |
| 1.2.1 Software Landscape .....                            | 1        |
| 1.2.2 The Interface .....                                 | 2        |
| <b>1.3 Definitions .....</b>                              | <b>2</b> |
| <b>1.4 Authors.....</b>                                   | <b>4</b> |
| <b>1.5 Document Organization .....</b>                    | <b>5</b> |
| <b>1.6 API Conventions.....</b>                           | <b>5</b> |
| 1.6.1 Function Naming.....                                | 5        |
| 1.6.2 Function Arguments .....                            | 7        |
| 1.6.3 Data Types .....                                    | 8        |
| 1.6.4 Common Data Structures.....                         | 8        |
| 1.6.4.1 Rectangle.....                                    | 9        |
| 1.6.4.2 Point .....                                       | 9        |
| 1.6.4.3 Size.....   | 9        |
| 1.6.5 Qm.n Format .....                                   | 9        |
| 1.6.6 Qm.n Notation Convention .....                      | 12       |
| 1.6.7 Scaling, Saturation, and Rounding Conventions ..... | 12       |
| 1.6.8 Function Variants .....                             | 13       |
| 1.6.9 Return Codes.....                                   | 14       |
| 1.6.10 Error Status .....                                 | 16       |
| 1.6.11 Implementation-Dependent Data Structures .....     | 16       |

|   |           |
|---|-----------|
| <b>1.7 Header Files .....</b>                             | <b>16</b> |
| <b>1.8 Implementation Methodologies.....</b>              | <b>17</b> |
| <b>1.9 Accuracy Criteria.....</b>                         | <b>17</b> |
| <b>2.0 Signal Processing .....</b>                        | <b>18</b> |
| <b>2.1 Data Structures.....</b>                           | <b>18</b> |
| <b>2.2 Functions .....</b>                                | <b>18</b> |
| <b>2.2.1 Vector Manipulation.....</b>                     | <b>18</b> |
| 2.2.1.1 Block Copy.....                                   | 18        |
| <b>2.2.2 Vector Arithmetic .....</b>                      | <b>19</b> |
| 2.2.2.1 Dot Product.....                                  | 19        |
| 2.2.2.2 Block Exponent .....                              | 20        |
| <b>2.2.3 Filtering.....</b>                               | <b>21</b> |
| 2.2.3.1 FIR Filters.....                                  | 21        |
| 2.2.3.2 IIR Filters .....                                 | 25        |
| 2.2.3.3 Biquad IIR Filters .....                          | 28        |
| 2.2.3.4 Median Filters .....                              | 30        |
| 2.2.3.5 Filtering Usage Examples .....                    | 31        |
| <b>2.2.4 FFT .....</b>                                    | <b>35</b> |
| 2.2.4.1 FFT Helper Functions .....                        | 36        |
| 2.2.4.2 FFT for Complex-Valued Signals .....              | 39        |
| 2.2.4.3 Example, FFT for Complex-Valued Signals.....      | 41        |
| 2.2.4.4 FFT for Real-Valued Signals .....                 | 42        |
| 2.2.4.5 Example, FFT for Real-Valued Signals .....        | 44        |
| <b>3.0 Audio Coding .....</b>                             | <b>47</b> |
| <b>3.1 MP3 Decoder Sub-Domain (omxACMP3) .....</b>        | <b>47</b> |
| <b>3.1.1 Constants .....</b>                              | <b>47</b> |
| <b>3.1.2 Data Structures .....</b>                        | <b>48</b> |
| 3.1.2.1 Frame Header.....                                 | 48        |
| 3.1.2.2 Side Information .....                            | 48        |
| 3.1.2.3 Long Block Scalefactor Band Table .....           | 49        |
| 3.1.2.4 Short Block Scalefactor Band Table .....          | 51        |
| 3.1.2.5 Scalefactor Band Mixed Block Partition Table..... | 52        |
| <b>3.1.2.6 Buffer Conventions .....</b>                   | <b>54</b> |
| 3.1.2.6.1 Bitstream Buffers .....                         | 54        |
| <b>3.1.3 Functions.....</b>                               | <b>55</b> |
| 3.1.3.1 Bitstream Unpacking .....                         | 55        |
| 3.1.3.2 Huffman Decoding .....                            | 59        |

|   |            |
|---|------------|
| 3.1.3.3 Inverse Quantization .....                      | 62         |
| 3.1.3.4 Synthesis Filterbank .....                      | 64         |
| <b>3.2 AAC-LC/LTP Decoder Sub-Domain</b>                |            |
| <b>(omxACAAC).....</b>                                  | <b>67</b>  |
| 3.2.1 Constants .....                                   | 67         |
| 3.2.2 Data Structures .....                             | 68         |
| 3.2.2.1 ADIF Header .....                               | 68         |
| 3.2.2.2 ADTS Frame Header .....                         | 68         |
| 3.2.2.3 Individual Channel Stream Side Information..... | 69         |
| 3.2.2.4 Program Configuration Element.....              | 70         |
| 3.2.2.5 LTP Information.....                            | 71         |
| 3.2.2.6 Channel Pair Element.....                       | 72         |
| 3.2.2.7 Channel Information .....                       | 72         |
| 3.2.2.8 Data Structutre Element Naming Conventions..... | 73         |
| 3.2.3 Functions.....                                    | 74         |
| 3.2.3.1 Bitstream Unpacking .....                       | 74         |
| 3.2.3.2 Inverse Quantization .....                      | 81         |
| 3.2.3.3 Joint Stereo Decoding .....                     | 82         |
| 3.2.3.4 Temporal Noise Shaping .....                    | 85         |
| 3.2.3.5 Synthesis Filterbank .....                      | 87         |
| 3.2.3.6 Perceptual Noise Substitution.....              | 90         |
| 3.2.3.7 Long-Term Prediction .....                      | 91         |
| 3.2.3.8 Huffman Decoding .....                          | 95         |
| <b>4.0 Image Processing.....</b>                        | <b>99</b>  |
| <b>4.1 Common Definitions .....</b>                     | <b>99</b>  |
| 4.1.1 Image Representation.....                         | 99         |
| 4.1.2 Image Processing Models.....                      | 101        |
| 4.1.3 Neighborhood Operations.....                      | 101        |
| 4.1.4 Rectangle or Region of Interest.....              | 101        |
| 4.1.5 Data Types and Enumerators.....                   | 102        |
| 4.1.5.1 Rotations .....                                 | 102        |
| 4.1.5.2 Moment States.....                              | 103        |
| <b>4.2 Bitmap Manipulation Sub-Domain (omxIPBM)</b>     |            |
| <b>.....</b>  | <b>103</b> |
| 4.2.1 Functions.....                                    | 103        |
| 4.2.1.1 Block Copy.....                                 | 103        |
| 4.2.1.2 Arithmetic.....                                 | 105        |
| 4.2.1.3 Mirror .....                                    | 106        |

|  |            |
|--|------------|
| <b>4.3 Pre- and Post-Processing Sub-Domain (omxIPPP)</b> .....       | <b>107</b> |
| 4.3.1 Functions.....   | 107        |
| 4.3.1.1 Filtering.....   | 107        |
| 4.3.1.2 Statistical.....   | 112        |
| 4.3.1.3 Deblocking .....   | 115        |
| <b>4.4 Color Space Conversion Sub-Domain (omxIPCS)</b> .....         | <b>117</b> |
| 4.4.1 Definitions.....   | 117        |
| 4.4.1.1 Color Space Conversions.....                                 | 117        |
| 4.4.1.2 Color Space Subsampling.....                                 | 118        |
| 4.4.2 Data Structures and Enumerators .....                          | 118        |
| 4.4.2.1 Interpolation Schemes .....                                  | 118        |
| 4.4.2.2 Color Spaces .....   | 118        |
| 4.4.3 Functions.....   | 119        |
| 4.4.3.1 YCbCr to BGR.....  | 119        |
| 4.4.3.2 Color Twist .....  | 122        |
| 4.4.3.3 Integrated CSC/Rotate/Integer Resize.....                    | 123        |
| 4.4.3.4 Integrated Rotate/Fractional Resize.....                     | 126        |
| 4.4.3.5 Integrated CSC/Rotate/Fractional Resize.....                 | 130        |
| 4.4.3.6 Integrated CSC/Rotate .....                                  | 135        |
| 4.4.3.7 JPEG-Specific RGB to YCbCr with Integrated Level Shift ..... | 138        |
| 4.4.3.8 JPEG-Specific YCbCr to BGR with Integrated Level Shift ..... | 141        |
| <b>5.0 Image Coding</b> .....  | <b>144</b> |
| <b>5.1 JPEG Sub-domain (omxICJP)</b> .....                           | <b>144</b> |
| 5.1.1 Definitions.....   | 144        |
| 5.1.1.1 JPEG Coefficient Buffer Organization .....                   | 144        |
| 5.1.1.2 Image Representation .....                                   | 146        |
| 5.1.2 Data Structures .....  | 146        |
| 5.1.2.1 JPEG Markers .....   | 146        |
| 5.1.2.2 Vendor-Specific Data Structures .....                        | 148        |
| 5.1.3 Functions.....   | 148        |
| 5.1.3.1 Copy with Padding.....                                       | 148        |
| 5.1.3.2 Forward DCT and Quantization .....                           | 149        |
| 5.1.3.3 Inverse DCT and Inverse Quantization .....                   | 154        |
| 5.1.3.4 Huffman Encoding .....                                       | 158        |
| 5.1.3.5 Huffman Decoding .....                                       | 162        |

|  |            |
|--|------------|
| <b>6.0 Video Coding .....</b>                      | <b>166</b> |
| <b>6.1 Common Sub-Domain (omxVCCOMM).....</b>      | <b>166</b> |
| 6.1.1 Data Structures and Enumerators .....        | 166        |
| 6.1.1.1 Motion Vectors .....                       | 166        |
| 6.1.2 Buffer Conventions .....                     | 166        |
| 6.1.2.1 Bitstream Buffers .....                    | 166        |
| 6.1.3 Encoder/Decoder Functions.....               | 167        |
| 6.1.3.1 Interpolation.....                         | 167        |
| 6.1.3.2 Frame Expansion .....                      | 169        |
| 6.1.3.3 Block Copy.....                            | 170        |
| 6.1.4 Encoder Functions .....                      | 171        |
| 6.1.4.1 Motion Estimation.....                     | 171        |
| <b>6.2 MPEG-4 Simple Profile Sub-Domain</b>        |            |
| <b>(omxVCM4P2) .....</b>                           | <b>177</b> |
| 6.2.1 Data Structures and Enumerators .....        | 177        |
| 6.2.1.1 Direction.....                             | 177        |
| 6.2.1.2 Bilinear Interpolation .....               | 177        |
| 6.2.1.3 Neighboring Macroblock Availability.....   | 177        |
| 6.2.1.4 Video Components .....                     | 178        |
| 6.2.1.5 MacroblockTypes.....                       | 178        |
| 6.2.1.6 Coordinates.....                           | 178        |
| 6.2.1.7 Motion Estimation Algorithms .....         | 178        |
| 6.2.1.8 Motion Estimation Parameters.....          | 178        |
| 6.2.1.9 Macroblock Information .....               | 179        |
| 6.2.2 Buffer Conventions .....                     | 179        |
| 6.2.2.1 Pixel Planes .....                         | 179        |
| 6.2.2.2 Texture Motion Vectors (in Q1 format)..... | 180        |
| 6.2.2.3 Quantization Parameter .....               | 181        |
| 6.2.2.4 Coefficient buffers.....                   | 181        |
| 6.2.3 Encoder/Decoder Functions.....               | 185        |
| 6.2.3.1 Motion Vector Prediction.....              | 185        |
| 6.2.3.2 Inverse DCT .....                          | 186        |
| 6.2.4 Encoder Functions .....                      | 187        |
| 6.2.4.1 Motion Estimation Helper.....              | 187        |
| 6.2.4.2 Motion Estimation, Low-Level .....         | 188        |
| 6.2.4.3 MotionEstimation, High-Level .....         | 192        |
| 6.2.4.4 DCT and Quantization .....                 | 194        |
| 6.2.4.5 Motion Vector Encoding and VLC.....        | 198        |
| 6.2.5 Decoder Functions .....                      | 201        |
| 6.2.5.1 Motion Vector Decoding.....                | 201        |



|            |   |            |
|------------|---|------------|
| 6.2.5.2    | VLC Decoding/Inverse Zig-Zag Scan.....                          | 202        |
| 6.2.5.3    | Inverse Quantization.....                                       | 205        |
| 6.2.5.4    | Inverse Quantization/Zig-Zag Scan/DCT .....                     | 205        |
| 6.2.5.5    | Motion Compensation.....  | 209        |
| 6.2.6      | Limitations.....  | 210        |
| <b>6.3</b> | <b>MPEG-4 Part 10 (H.264) Sub-Domain<br/>(omxVCM4P10) .....</b> | <b>210</b> |
| 6.3.1      | Data Structures and Enumerators .....                           | 210        |
| 6.3.1.1    | Intra 16x16 Prediction Modes.....                               | 210        |
| 6.3.1.2    | Intra 4x4 Prediction Modes.....                                 | 210        |
| 6.3.1.3    | Chroma Prediction Modes .....                                   | 211        |
| 6.3.1.4    | Motion Estimation Modes .....                                   | 211        |
| 6.3.1.5    | Macroblock Types.....   | 211        |
| 6.3.1.6    | Sub-Macroblock Types.....                                       | 212        |
| 6.3.1.7    | Variable Length Coding (VLC) Information .....                  | 212        |
| 6.3.1.8    | Macroblock Information .....                                    | 213        |
| 6.3.1.9    | Motion Estimation Parameters.....                               | 213        |
| 6.3.2      | Buffer Conventions .....  | 214        |
| 6.3.2.1    | Neighboring Macroblock Availability.....                        | 214        |
| 6.3.2.2    | Coefficient-Position Pair Buffer .....                          | 214        |
| 6.3.3      | Encoder/Decoder Functions.....                                  | 215        |
| 6.3.3.1    | Intra Prediction .....  | 215        |
| 6.3.3.2    | Interpolation.....  | 219        |
| 6.3.3.3    | Deblocking .....  | 221        |
| 6.3.4      | Decoder Functions .....   | 227        |
| 6.3.4.1    | CAVLC Decoding .....  | 227        |
| 6.3.4.2    | Inverse Quantization/Transform/Add Residual.....                | 229        |
| 6.3.5      | Encoder Functions .....   | 231        |
| 6.3.5.1    | Motion Estimation Helper.....                                   | 232        |
| 6.3.5.2    | Motion Estimation , Low-Level .....                             | 233        |
| 6.3.5.3    | Motion Estimation , High-Level .....                            | 238        |
| 6.3.5.4    | SAD/SATD.....   | 240        |
| 6.3.5.5    | Interpolation.....  | 243        |
| 6.3.5.6    | Transform and Quantization .....                                | 246        |
| 6.3.5.7    | Transform and Compensation.....                                 | 248        |
| 6.3.5.8    | Compensation, Transform, and Quantization.....                  | 249        |
| 6.3.5.9    | VLC.....  | 250        |
| <b>7.0</b> | <b>Concurrency Mechanisms .....</b>                             | <b>252</b> |
| <b>7.1</b> | <b>Asynchronous DL (aDL) .....</b>                              | <b>252</b> |
| 7.1.1      | Overview .....  | 252        |
| 7.1.2      | Upgrading DL API to aDL API.....                                | 252        |

|  |            |
|--|------------|
| 7.1.3 aDL Control APIs .....   | 253        |
| 7.1.3.1 omxaDL_Control .....   | 254        |
| 7.1.3.2 omxaDL_RegisterIndex.....  | 256        |
| 7.1.3.3 Parameter Controls.....  | 258        |
| 7.1.4 Errors .....   | 260        |
| 7.1.5 Example of Utilization .....   | 261        |
| aDL Code Examples .....  | 261        |
| 7.1.5.1 Simple Example.....  | 261        |
| 7.1.5.2 RegisterIndex Setup Example.....   | 263        |
| 7.1.5.3 Concurrent Chains Example.....   | 264        |
| <b>7.2 Integrated DL (iDL) .....</b>   | <b>265</b> |
| 7.2.1 Overview .....   | 265        |
| 7.2.2 Upgrading a DL codec to an iDL codec.....  | 266        |
| 7.2.3 iDL Concurrent Execution.....  | 266        |
| 7.2.4 Errors .....   | 266        |
| 7.2.5 Example of Utilization .....   | 267        |
| <b>A Optional Extensions (DLx) .....</b>   | <b>270</b> |
| <b>A.1 Overview .....</b>  | <b>270</b> |
| A.1.1 Purpose.....   | 270        |
| A.1.2 Scope.....   | 270        |
| A.1.3 Compliance .....   | 270        |
| <b>A.2 Image Processing, Pre-Processing/Post-Processing Sub-Domain (omxIPPP) and Color Space Conversion Sub-Domain (omxIPCS) .....</b> | <b>270</b> |
| A.2.1 Data Structures .....  | 270        |
| A.2.1.1 OMXIPCSGammaTableType.....   | 270        |
| A.2.1.2 OMXIPCSRawPixProcCfg_P3R.....  | 271        |
| A.2.1.3 OMXIPCSRGGBSensorCfg .....   | 271        |
| A.2.1.4 OMXIPCSRawPixProcSpec_P3R .....  | 272        |
| A.2.2 Functions, omxIPCS Sub-Domain .....  | 272        |
| A.2.2.1 Raw Pixel Processing .....   | 272        |
| Gamma Correction Requirements .....  | 275        |
| A.2.3 Functions, omxIPPP Sub-Domain.....   | 276        |
| A.2.3.1 Dering.....  | 276        |

|  |            |
|--|------------|
| <b>A.3 Image Coding, JPEG Sub-Domain (omxICJP)</b>                             | <b>278</b> |
| .....  |            |
| <b>A.3.1 Encoder Functions</b> .....   | <b>278</b> |
| A.3.1.1 Integrated Forward DCT + Quantization.....                             | 278        |
| <b>A.3.2 Decoder Functions</b> .....   | <b>279</b> |
| A.3.2.1 Integrated Inverse Quantization + Inverse DCT .....                    | 279        |
| <b>A.4 Image Coding, JPEG2K Sub-Domain (omxICJP2K)</b>                         | <b>279</b> |
| .....  |            |
| <b>A.4.1 Encoder/Decoder Functions</b> .....                                   | <b>279</b> |
| A.4.1.1 Discrete Wavelet Transform Helper .....                                | 279        |
| <b>A.4.2 Encoder Functions</b> .....   | <b>281</b> |
| A.4.2.1 Forward DWT .....  | 281        |
| <b>A.4.3 Decoder Functions</b> .....   | <b>285</b> |
| A.4.3.1 Inverse DWT .....  | 285        |
| <b>A.5 Video Coding, Common (omxVCCOMM) and MPEG-4 (omxVCM4P2) Sub-Domains</b> | <b>288</b> |
| .....  |            |
| <b>A.5.1 Data Structures and Enumerators</b> .....                             | <b>288</b> |
| A.5.1.1 Transparent Status.....  | 288        |
| A.5.1.2 OMXSadmultipleParam.....   | 289        |
| A.5.1.3 OMXSadmultipleInterpParam .....  | 289        |
| A.5.1.4 OMXSoSmultipleInterpParam .....  | 289        |
| <b>A.5.2 Encoder/Decoder Functions</b> .....                                   | <b>290</b> |
| A.5.2.1 Inverse DCT.....   | 290        |
| <b>A.5.3 Encoder Functions</b> .....   | <b>291</b> |
| A.5.3.1 Forward DCT .....  | 291        |
| A.5.3.2 Motion Estimation.....   | 291        |
| A.5.3.3 Quantization .....   | 300        |
| <b>A.5.4 Decoder Functions</b> .....   | <b>301</b> |
| A.5.4.1 Inverse Quantization.....  | 301        |
| A.5.4.2 Integrated IDCT + Inverse Quantization .....                           | 302        |
| A.5.4.3 Motion Vector Decoding.....  | 305        |
| A.5.4.5 Context-Based Arithmetic Decoding .....                                | 310        |
| A.5.4.6 Padding .....  | 312        |
| <b>A.6 Video Coding, H.264 Sub-Domain (omxVCM4P10)</b>                         | <b>316</b> |
| .....  |            |
| <b>A.6.1 Decoder Functions</b> .....   | <b>316</b> |
| A.6.1.1 Inverse Quantization + Inverse Integer Transform.....                  | 316        |

|                          |            |
|--------------------------|------------|
| A.6.1.2 Deblocking ..... | 317        |
| <b>B References.....</b> | <b>319</b> |

# List of Tables

---

|  |              |
|--|--------------|
| <i>Table 1-5: Enumerated OpenMAX DL Return Codes.....</i>  | <i>1-14</i>  |
| <i>Table 3-1: MP3 Macro and Constant Definitions .....</i>   | <i>3-47</i>  |
| <i>Table 3-2: Long Block Scalefactor Band Table Organization.....</i>  | <i>3-50</i>  |
| <i>Table 3-3: Short Block Scalefactor Band Table Organization .....</i>  | <i>3-51</i>  |
| <i>Table 3-4: Scalefactor Band Mixed Block Partition Table Organization .....</i>  | <i>3-53</i>  |
| <i>Table 3-5: OMX_Sts_BadArgErr Conditions for HuffmanDecode/Sfb/SfbMbp_S32.....</i>   | <i>3-61</i>  |
| <i>Table 3-6: OMX_Sts_BadArgErr Conditions for ReQuantize_S32_I and ReQuantizeSfb_S32_I...3-63</i>                                     |              |
| <i>Table 3-7: AAC-LC/LTP Constants .....</i>   | <i>3-67</i>  |
| <i>Table 3-8: OmxAC AAC Sub-Domain Data Structure Element Naming Conventions .....</i>   | <i>3-73</i>  |
| <i>Table 3-9: pIcsInfo Members Modified Conditionally by DecodeChanPairElt .....</i>   | <i>3-78</i>  |
| <i>Table 3-10: pChanPairElt Members Modified Conditionally by DecodeChanPairElt .....</i>  | <i>3-79</i>  |
| <i>Table 3-11: *(pChanInfo-&gt;pIcsInfo) Members Modified Conditionally by NoiselessDecoder When Input Parameter commonWin==0.....</i> | <i>3-97</i>  |
| <i>Table 4-1: Memory Organization for Interleaved (Pixel-Oriented) Color Space Data .....</i>  | <i>4-100</i> |
| <i>Table 4-2: Memory Organization for Planar Color Space Data.....</i>   | <i>4-101</i> |
| <i>Table 4-3: Arithmetic Operators.....</i>  | <i>4-105</i> |
| <i>Table 4-4: FIR Filtering Definition .....</i>   | <i>4-107</i> |
| <i>Table 4-5: Median Filtering Definition .....</i>  | <i>4-108</i> |
| <i>Table 4-6: Statistical Moments Definitions.....</i>   | <i>4-112</i> |
| <i>Table 4-7: Color Model Conversions .....</i>  | <i>4-117</i> |
| <i>Table 4-8: Color Conversion Subsampling Conventions.....</i>  | <i>4-118</i> |
| <i>Alignment requirements .....</i>  | <i>A-275</i> |
| <i>Gamma Table Usage.....</i>  | <i>A-276</i> |
| <i>Gamma Tables and Indexes .....</i>  | <i>A-276</i> |

# Table of Figures

---

|  |       |
|--|-------|
| <i>Figure 1-1: <math>Q_{m.n}</math> Representation</i> .....                             | 1-10  |
| <i>Figure 1-2: Q3.4 Format</i> .....   | 1-10  |
| <i>Figure 1-3: <math>Q_{0.15}</math> with <math>OMX\_S16</math></i> .....                | 1-11  |
| <i>Figure 1-4: <math>Q_{16.15}</math> Example with <math>OMX\_S32</math></i> .....       | 1-12  |
| <i>Figure 2-1: Combined Coefficient Vector Organization</i> .....                        | 2-28  |
| <i>Figure 4-1: Image, ROI, and Offsets</i> .....   | 4-102 |
| <i>Figure 5-1: Interleaved and Non-Interleaved Image Data Formats</i> .....              | 5-145 |
| <i>Figure 5-2: Rectangle Of Interest (ROI) for Encoding Procedure</i> .....              | 5-146 |
| <i>Figure 6-1: Motion Vector Limiting</i> .....  | 6-174 |
| <i>Figure 6-2: Pixel Plane, VOL, and VOP</i> .....                                       | 6-180 |
| <i>Figure 6-3: Row/Column Coefficient Buffer Updates for A Single Block</i> .....        | 6-182 |
| <i>Figure 6-4: Row/Column Coefficient Buffer Updates for A Complete Macroblock</i> ..... | 6-183 |
| <i>Figure 6-5: Neighboring Macroblock Availability</i> .....                             | 6-214 |
| <i>Figure 6-6: Coefficient-Position Pair Buffer Definition</i> .....                     | 6-215 |

# 1.0 Overview

# 1

## 1.1 Introduction

This document defines the Application Programming Interface (API) for the OpenMAX Development Layer (DL). Published as an open standard by the Khronos Group, the DL provides a set of low-level primitives to ensure portability across processors and hardware acceleration units for audio, video, and imaging codecs used within embedded and/or mobile devices. The principal goal of the DL is to enable portability of silicon acceleration for rich media codecs across diverse processor and acceleration hardware architectures by providing an essential set of “hotspot” primitives.

### 1.1.1 About the Khronos Group

The Khronos Group is a member-funded industry consortium focused on the creation of open standard APIs to enable the authoring and playback of dynamic media on a wide variety of platforms and devices. All Khronos members are able to contribute to the development of Khronos API specifications, are empowered to vote at various stages before public deployment, and are able to accelerate the delivery of their multimedia platforms and applications through early access to specification drafts and conformance tests. The Khronos Group is responsible for open APIs such as OpenGL ES, OpenML, and OpenVG.

### 1.1.2 A Brief History of OpenMAX

The OpenMAX set of APIs was originally conceived as a method of enabling portability of codecs and media applications with the mobile device landscape. Brought into the Khronos Group in mid 2004 by a handful of key mobile hardware companies, OpenMAX has gained the contributions of companies and institutions stretching the breadth of the multimedia field. As such, OpenMAX stands to unify the industry in taking steps toward media codec portability. Stepping beyond mobile platforms, the general nature of OpenMAX DL API makes it applicable to all media platforms.

## 1.2 The OpenMAX Development Layer

### 1.2.1 Software Landscape

The OpenMAX DL is a part of the larger multimedia software landscape depicted in the figure below.

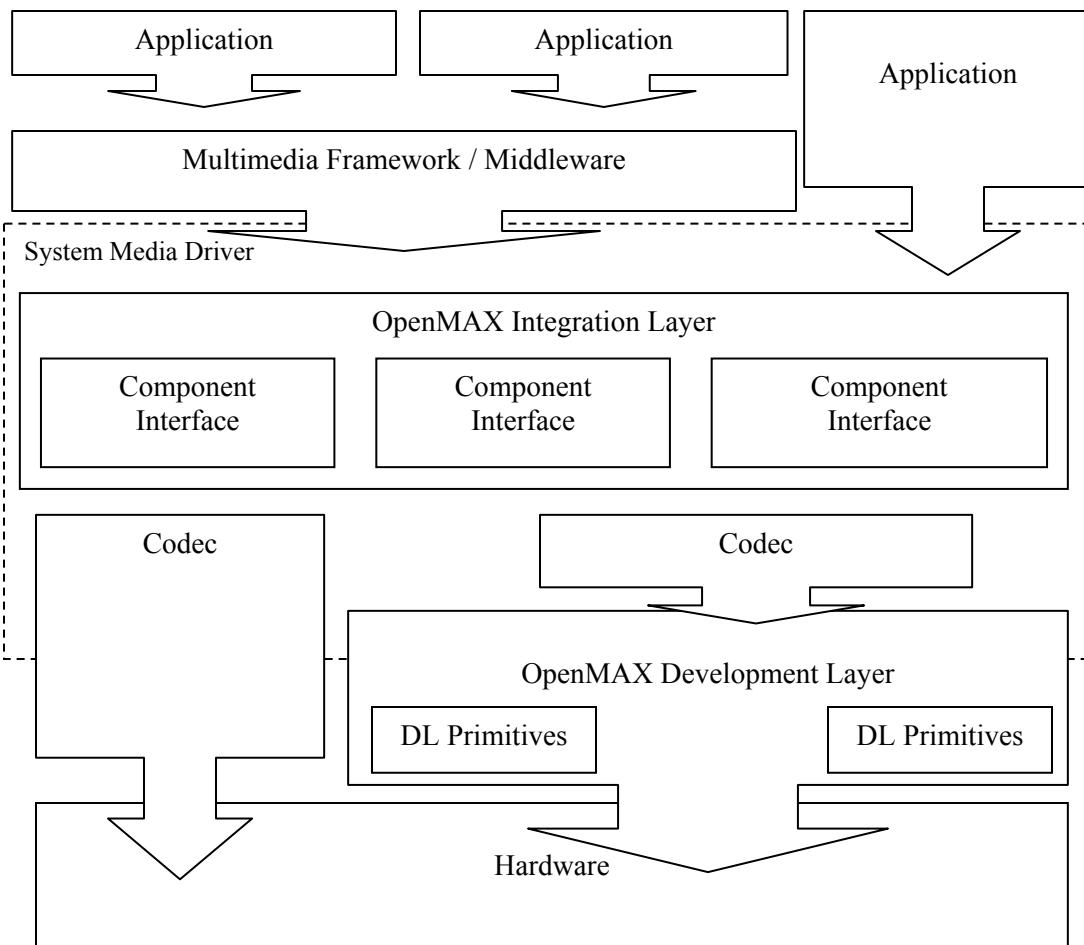

To remove possible reader confusion, the OpenMAX standard also defines an Integration Layer (IL). The IL and its full relationship to the DL are specified in other OpenMAX specification documents [*OpenMAX Integration Layer API Specification, Version 1.0*, Khronos Group, 2006]

### 1.2.2 The Interface

The DL API defines a set low-level multimedia kernels or media processing building blocks that might be used to accelerate traditional computational hotspots within standardized media codecs and other integrated media processing engines. The functional scope of the DL API spans several domains key to mobile multimedia platforms, including the following: signal and image processing, audio coding, image coding, and video coding. As such, the DL API is organized into a collection of function domains named, respectively, omxSP, omxIP, omxAC, omxIC, and omxVC. Each domain is further decomposed into sub-domains that address the needs of specific standardized media codecs. Within each sub-domain, a set of low-level kernels is defined to provide functional coverage that tends to obey the 80/20 rule.

### 1.3 Definitions

When this specification discusses requirements and features of the OpenMAX DL API, several specific words are used to convey their necessity in an implementation. A list of these words can



be found in Table 1-1.

**Table 1-1: Terminology**

---

| <b>Word</b> | <b>Definition</b>   |
|-------------|---|
| Shall       | “Shall” means that the stated functionality is a requirement for an implementation of the OpenMAX DL API. If a component fails to meet a “shall” statement, it is not considered to be conformant to this specification. Shall is always used as a requirement as in “The component designers shall produce good documentation.”  |
| Will        | “Will” means that the stated functionality is not a requirement for an implementation of the OpenMAX DL API. The word “Will” is usually used when referring to a third party as in “the application framework will correctly handle errors.”  |
| Should      | “Should” means that the stated functionality is not a requirement for an implementation of the OpenMAX DL API, but is the recommended thing to do or is a good practice. The word “Should” is usually used as follows: “The component should begin processing buffers immediately after it receives a Start Command.” While this is good practice, there may be a valid reason to delay processing buffers such as not having input data available. |
| May         | “May” means that the stated functionality is optional requirement for an implementation of the OpenMAX DL API. Optional features are not required by the specification, but may have conformance requirements if they are implemented. This is an optional feature as in “The component may have vendor specific extensions”  |

## 1.4 Authors

The following individuals contributed to the OpenMAX Development Layer Specification (listed alphabetically by company):

- Martyn Capewell (ARM)
- Hedley Francis (ARM)
- Dominic Symes (ARM)
- Brian Murray (Freescale)
- Yolanda Prieto (Freescale)
- Yong Yan (Freescale)
- Julian Vlaiko (Intel)
- Ted Painter (Intel/Marvell)
- Omry Paiss (Intel/Marvell)
- Beryl Xu (Intel/Marvell)
- Kathy Moseler (Motorola)
- Doina Petrescu (Motorola)
- Rags Subramaniyan (Motorola)
- Mark Kokes (Nokia)
- Leo Estevez (TI)
- Joseph Meehan (TI)

## 1.5 Document Organization

The rest of this specification is organized as follows. The remainder of Chapter 1 introduces DL conventions common to all function domains and sub-domains. Chapter 2 defines the signal processing domain (omxSP). Chapter 3 defines the audio coding domain (omxAC), including the MP3 and AAC-LC/LTP sub-domains (omxACMP3, and omxACAAC, respectively). Chapter 4 defines the image processing domain (omxIP). Chapter 5 defines the image coding domain (omxIC), including the JPEG sub-domain (omxICJP). Chapter 6 defines the video coding domain (omxVC), including the MPEG-4 simple profile sub-domain (omxVCM4P2), the H.264 baseline sub-domain (omxVCM4P10), and a set of functions common to both video coding sub-domains (omxVCCOMM). Chapter 7 defines concurrency mechanisms. Finally, Appendix A contains optional API extensions, and Appendix B provides a set of references.

## 1.6 API Conventions

### 1.6.1 Function Naming

OpenMAX DL function names are constructed as follows:

*omx*<domain><sub\_domain>\_<operation>\_<function-specific modifier>\_<datatype>\_<data modifier>(parameter list)

<domain> - two character function domain specifier; the following domains are defined:

**Table 1-2: Function Domain definitions**

---

| Domain | Meaning           |
|--------|-------------------|
| AC     | Audio Coding      |
| SP     | Signal Processing |
| VC     | Video Coding      |
| IP     | Image Processing  |
| IC     | Image Coding      |

<sub-domain> - two character sub-domain specifier; the following sub-domains are defined:

**Table 1-3: Function sub-domain definitions**

---

| Domain | Sub-domain | Meaning                  |
|--------|------------|--------------------------|
| AC     | MP3        | MP3                      |
|        | AAC        | AAC                      |
| VC     | COMM       | Common                   |
|        | M4P2       | MPEG4 Part 2             |
|        | M4P10      | MPEG4 Part 10            |
| IP     | PP         | Pre- and Post-processing |
|        | CS         | Color Space Conversion   |
|        | BM         | Bitmap Manipulation      |
| IC     | JP         | JPEG codec functions     |

<operation> - an abbreviated descriptor that encapsulates function behavior. For example, "FIR".

<*function-specific modifier*> - a short mnemonic string that augments the operation descriptor; used typically when the operation name is imprecise. For example, consider the function `omxSP_FFTFwd_CToC_SC16_Sfs( . . . )`. The operation “FFTFwd” is a generic operation for which there are multiple instantiations, each with unique characteristics (e.g., real-to-complex, complex-to-complex). The function-specific modifier “CToC” informs the user of the data types processed by this particular function, namely complex-valued input and output vectors.

<*data type*> - Specifies bit depth and/or data layout using a string of the form:

<U|S>#[c]

Where the “#” symbol is replaced by an integer that indicates the bit depth, either of the symbols “U” or “S” is included to denote, respectively, “unsigned integer” or “signed integer”, and the optional symbol “C” denotes complex data. For the functions described in this manual, the “#” symbol is replaced by one of the following bit depth indicators: 8, 16, 32, or 64.

For example, the following function operates exclusively on a single data type:

```
omxSP_Copy_S16(OMX_S16 *pSrc1, OMX_S16 *pSrc2, OMX_S16 *pDst, OMX_INT len)
```

The data type is specified by the suffix “\_S16,” which implies that both the input and output operands are represented by 16-bit signed integers (OMX\_S16). For functions that operate on more than one data type, the source data type is listed first, followed by destination data type.

<*data modifier*> - The data modifier further describes the data associated with the operation. It may contain implied parameters and/or indicate additional required parameters. The set of OMX data modifiers is given in the list below. Data modifiers are always presented in alphabetical order.

- D2 - two-dimensional signal
- I - in-place operation
- Sfs - Saturated fixed scale operation

## 1.6.2 Function Arguments

The OpenMAX DL convention for function argument lists can be generally expressed as follows:

```
<input>, <input data length>, <output>, <output data length>,  
<parameter list>
```

Whenever an input or output argument is a scalar rather than a vector (non-array), the associated data length argument is eliminated, as in the case of the following example function that computes the standard deviation of a vector:

```
omxSP_StdDev_S16(OMX_S16 *pSrc, OMX_INT len, OMX_S16 *pResult)
```

Whenever the input and output vectors have the same length, the input vector length argument will be eliminated. For example, consider the following function for pointwise vector addition:

```
omxSP_Add_S16(OMX_S16 *pSrc1, OMX_S16 *pSrc2, OMX_S16 *pDst, OMX_INT len)
```

### 1.6.3 Data Types

The table below shows OpenMAX data types. Complex-valued sequences are represented using structures that interleave the real and imaginary components.

**Table 1-4: OMX Data Types**

| Data Type | Corresponding Data Type in C  | Default Alignment |
|-----------|---|-------------------|
| OMX_U8    | 8-bit unsigned integer, i.e., unsigned char   | 8-bit             |
| OMX_S8    | 8-bit signed integer, i.e., char  | 8-bit             |
| OMX_U16   | 16-bit unsigned integer, i.e., unsigned short, unsigned short int                     | 16-bit            |
| OMX_S16   | 16-bit integer, i.e., short, short int, signed short int                              | 16-bit            |
| OMX_U32   | 32-bit unsigned integer, i.e., unsigned int, unsigned long, unsigned long int         | 32-bit            |
| OMX_S32   | 32-bit signed integer, i.e., int, long, long int, signed long int                     | 32-bit            |
| OMX_U64   | 64-bit unsigned integer   | 64-bit            |
| OMX_S64   | 64-bit signed integer   | 64-bit            |
| OMX_SC8   | struct {OMX_S8 Re; OMX_S8 Im;}, i.e., real/imaginary interleaved complex              | 8-bit             |
| OMX_SC16  | struct {OMX_S16 Re; OMX_S16 Im;}, i.e., real/imaginary interleaved complex            | 16-bit            |
| OMX_SC32  | struct {OMX_S32 Re; OMX_S32 Im;}, i.e., real/imaginary interleaved complex            | 32-bit            |
| OMX_SC64  | struct {OMX_S64 Re; OMX_S64 Im;}, i.e., real/imaginary interleaved complex            | 64-bit            |
| OMX_F32   | single-precision floating-point, IEEE 754   | 32-bit            |
| OMX_F64   | Double-precision floating-point, IEEE 754   | 64-bit            |
| OMX_INT   | signed integer corresponding to machine word length, has maximum signed value INT_MAX | 32-bit            |
| OMXResult | identical to OMX_INT  | 32-bit            |

Unless otherwise specified, function parameters of a given data type should follow the default alignments specified in the table above.

### 1.6.4 Common Data Structures

Data structures common across function domains are defined below.

### 1.6.4.1 Rectangle

The structure `OMXRect`, used for storing the geometric position and size of a rectangle, is defined as follows:

```
typedef struct {
    OMX_INT x;
    OMX_INT y;
    OMX_INT width;
    OMX_INT height;
} OMXRect;
```

where the points `x` and `y` specify the coordinates of the top left corner of the rectangle, and the parameters `width` and `height` specify dimensions in the `x`- and `y`- directions, respectively.

### 1.6.4.2 Point

The structure `OMXPoint` is used to represent the geometric position of a point, is defined as follows:

```
typedef struct {
    OMX_INT x;
    OMX_INT y;
} OMXPoint;
```

where `x`, `y` define the coordinates of the point.

### 1.6.4.3 Size

The structure `OMXSize`, used for storing the size of a rectangular region, is defined as follows:

```
typedef struct {
    OMX_INT width;
    OMX_INT height;
} OMXSize;
```

where `width` and `height` denote the dimensions of the rectangle in the `x`- and `y` directions, respectively.

## 1.6.5 Qm.n Format

Some OpenMAX DL functions require a fractional interpretation of integer input and/or output parameters. The “Qm.n” format provides a standard mechanism for representing fractional values using an integer data type. Under Qm.n, the integer binary word is partitioned using an imaginary fixed point. The `n`-bits to the right of the imaginary point comprise the fractional portion of the value being represented, and act as weights for negative powers of 2. The `m`-bits to the left of the imaginary point comprise the integer portion of the value being represented, and act as weights for positive powers of 2. The overall signed Qm.n representation requires a total of `m+n+1` bits, with the additional bit required for the sign. In general, the `m+n+1`-bit Qm.n word can be represented as shown in Figure 1-1.

**Figure 1-1: Qm.n Representation**

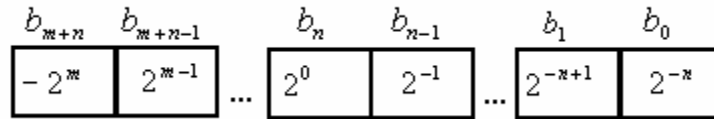

In the figure, each bit cell has the value indicated by a power of 2, and the Qm.n word value is determined by adding together the individual bit cell values weighted by the bits,  $b_i$ , i.e.,

$$value = -b_{m+n}2^m + \sum_{i=1}^{m+n} b_{m+n-i}2^{m-i},$$

where  $b_i \in \{0,1\}$ ,  $0 \leq i \leq m+n$ , the parameter  $m$  (number of bits to the left of the point) determines the dynamic range

$$range = [-2^m, 2^m)$$

and the parameter  $n$  (number of bits to the right of the point) determines the precision, i.e.,

$$precision = 2^{-n}$$

Three examples are given below.

**Example 1-1: Q3.4, OMX\_S8**

Figure 1-2 illustrates a Q3.4 word with the underlying data type of OMX\_S8. As shown in the figure, the Q3.4 word occupies  $3+4+1 = 8$  bits. The dynamic range for the Q3.4 word spans the open interval  $[-8, 8)$ , and the precision (or “quantization error”) is  $1/16$ . The value represented by a particular set of Q3.4 bits is given by the adding up the weighted powers of 2:

$$value = -b_72^3 + b_62^2 + \dots + b_02^{-4}$$

where  $b_i \in \{0,1\}$  are the bits.

**Figure 1-2: Q3.4 Format**

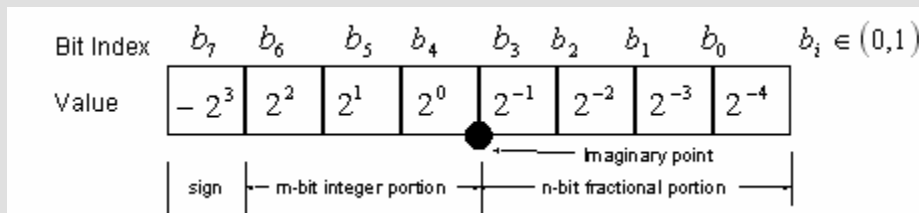



### Example 1-2: Q0.15, OMX\_S16

Figure 1-3 illustrates the case of a Q0.15 parameter with underlying data type OMX\_S16. In this case,  $L=16$ , and therefore a Q0.15 interpretation is as shown in the figure.

**Figure 1-3: Q0.15 with OMX\_S16**

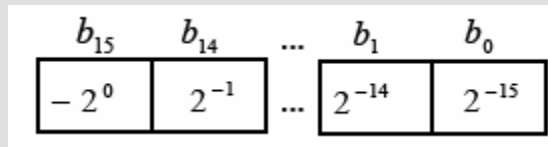

The value, dynamic range, and precision can be obtained using the expressions given for a general Qm.n; for  $m=0$  and  $n=15$ , the value, range, and precision, respectively, are given by

$$\text{value} = -b_{15}2^0 + \sum_{i=1}^{15} b_{15-i}2^{-i}$$
$$\text{range} = [-1,1)$$
$$\text{precision} = 2^{-15}$$

An example OpenMAX DL function that makes use of Q0.15 in combination with OMX\_S16 is the FIR filter.

### Example 1-3: Q16.15, OMX\_S32

Figure 1-4 illustrates the case of a Q16.15 parameter with underlying data type OMX\_S32. In this case,  $L=32$ , and therefore a Q16.15 interpretation is as shown in the figure.

**Figure 1-4: Q16.15 Example with OMX\_S32**

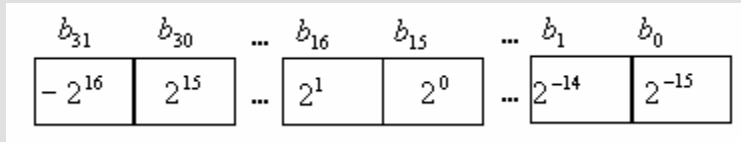

The value, dynamic range, and precision can be obtained using the expressions given for a general Q $m.n$ ; for  $m=16$  and  $n=15$ , the value, range, and precision, respectively, are given by

$$\text{value} = -b_{31}2^{16} + \sum_{i=1}^{31} b_{31-i}2^{16-i}$$

$$\text{range} = [-65536, 65536)$$

$$\text{precision} = 2^{-15}$$

### 1.6.6 Q $m.n$ Notation Convention

In this specification the abbreviated notation “Q $n$ ” is used to denote “Q $m.n$ ,” where  $m = L - n - 1$ , and  $L$  is the word length, in bits, of the underlying data type. In other words, a particular value for  $m$  is implied by the combination of a data type and the particular choice of  $n$  specified by “Q $n$ .”

### 1.6.7 Scaling, Saturation, and Rounding Conventions

The OpenMAX DL API includes a scaling mechanism to achieve the maximum possible precision for fixed-point integer operations. Many functions may perform internal computation using a precision higher than the data types that are used for the input and output parameters. Therefore, it may be necessary to scale the function output arguments to achieve a desired precision in the result. OpenMAX DL provides saturated fixed scaling as a mechanism that allows users to control the precision of output arguments. In functions that use it, saturated fixed scaling (Sfs) is controlled by the input argument, “scalefactor.” For Sfs functions, the output will be multiplied by  $2^{-\text{scalefactor}}$  before returning to the caller. In other words, for

functions that internally accumulate results having precision higher than the input and output arguments, it is possible for the user to control which subset of the most significant bits is returned.

A typical function with scaled output has the following format:

```
omxSP_Function_Sfs(..., OMX_INT scaleFactor)
```

In all cases, the mnemonic “Sfs” denotes “Saturated fixed scaling.”

The Sfs-enabled function performs the required calculation using an internal data type having a higher precision (larger number of bits) than the input and/or output parameters. Once the computation has been completed, the internal high-precision result is shifted by the number of bits indicated in the scale factor (positive scalefactors correspond to right shifts, negative scalefactors to left shifts) and copied into the low-precision output variable.

Scalefactors are chosen to ensure that significant bits are not truncated from the scaled result. A scaled vector operation using two 16-bit input operands (OMX\_S16) could potentially produce a result having 32 significant bits. The internal accumulator might actually contain 32 bits. By supplying a scalefactor, the user is able to choose any 16 out of the available 32 result bits. If the top 16 bits of the 32-bit result were needed, then the user would set the scalefactor to 16. On the other hand, if the dynamic range of the input data was constrained such that only 24 significant bits were contained in the internal multiplication result, then the user would select a scalefactor of 8, which would mean that bits 8 through 23 (assuming that bit indices start from 0) were returned in the 16-bit output argument.

Rounding of the result in conjunction with the scaling shift is optional unless otherwise specified within the detailed description for a particular OpenMAX DL function.

#### Example 1-4: Example Rounding Scheme

*Given a positive scalefactor, sf, rounding toward the nearest representable value could be realized as follows:*

$$result = (result + (1 \ll (sf-1))) \gg sf$$

Some implementations of non-Sfs OpenMAX DL function variants may also use internal data types having a higher precision than the associated output parameters. Unless otherwise specified, implementations of these functions must implement overflow saturation on all outputs. Upon overflow, non-scaled OMX integer output arguments must saturate to the nearest representable value, e.g., upon overflow beyond 16 bits, a non-scaled output argument of the type OMX\_S16 must saturate to 0x8000 (-32768) for a negative overflow or to 0x7fff (32767) for a positive overflow.

### 1.6.8 Function Variants

To maximize flexibility and ease of use, the OpenMAX DL API offers up to four variants on each function:

- Basic or default
- In-place (I)
- Saturation fixed scale (Sfs)

- In-place and saturation fixed scale (ISfs)

For in-place function variables, input and output vectors share common memory. As a result, the contents of the input vector are replaced by contents of the output vector upon return from the function call. For non-in-place variables, input and output vectors use distinct memory blocks, and therefore the input vector remains unmodified upon return from the function call. As described previously, saturation fixed scale function variables return outputs that have been scaled by  $2^{-scaleFactor}$ . i.e., output values have been shifted `scaleFactor` bits to the left or right for negative or positive `scaleFactor` values, respectively. Non-Sfs function variables can be viewed as a special case of the Sfs variables in which `scaleFactor` has been set to 0. The ISfs function variables combine in-place and saturation fixed scale behavior with the underlying default function functionality.

In the interest of clarity and simplicity, the block diagrams, equations, and other detailed behavioral descriptions given throughout the remainder of this specification apply only to the non-in-place and non-scaled (so-called “default”) function variants, unless explicitly otherwise noted. Behavior of the scaled and in-place variables can be understood easily by applying the generic in-place and scaled function behavioral rules given above to the default behavioral specification.

### 1.6.9 Return Codes

Unless otherwise specified, all OpenMAX DL functions return status codes to report either successful completion of the function (`OMX_Sts_NoErr`) or to report errors and warnings to the calling program. The calling function may or may not choose to implement an appropriate exception handling scheme. All DL return codes are of enumerated type `OMXResult`, and all enumerated warnings and errors take negative values, as specified in the `omxtypes.h` header file.

Return codes are classified into two types: mandatory and optional. Mandatory return codes are required for all DL implementations. Optional return codes are recommended but are not required. The error codes do not overlap, i.e., the function cannot return both mandatory and optional codes for the same error, since for each error there is a unique error code. Thus, not all errors are captured by the mandatory return codes. Therefore, it is possible to have two implementations of a function: an optimised (“Release”) version and a “debug” version. The optimised version could return only the mandatory error codes, while the “debug” version could return both the mandatory and the optional codes. The user could check for all error codes in the “debug” version of the application that uses the “debug” version of the DL functions.

The complete set of status codes, their associated messages, and their classifications are listed in Table 1-5. The definitions for each function in sections two through six of this specification document define which mandatory or optional return codes, respectively, shall or may be returned by each particular function.

**Table 1-5: Enumerated OpenMAX DL Return Codes**

| Return Code                                 | Associated Message                                 | Classification |
|---|--|----------------|
| <code>OMX_Sts_NoErr</code>                  | No error   | Mandatory      |
| <code>OMX_Sts_Err</code>                    | Unknown/unspecified error                          | Mandatory      |
| <code>OMX_Sts_BadArgErr</code>              | Bad Arguments                                      | Optional       |
| <code>OMX_Sts_InvalidBitstreamValErr</code> | Invalid value detected during bitstream processing | Mandatory      |

| <b>Return Code</b>          | <b>Associated Message</b>  | <b>Classification</b>  |
|-----------------------------|--|--|
| OMX_Sts_MaximumEnumeration  | Placeholder, forces enum of size OMX_INT   | Never returned by any function; used as a placeholder in the header file to force correct enum size. |
| OMX_Sts_MemAllocErr         | Not enough memory for the operation  | Mandatory  |
| OMX_Sts_NoErr               | No error   | Mandatory  |
| OMX_Sts_NullPtrErr          | Null pointer error   | Optional   |
| OMX_StsACAAC_GainCtrErr     | Unsupported gain control data detected   | Mandatory  |
| OMX_StsACAAC_PrgNumErr      | Invalid number of elements for one program   | Mandatory  |
| OMX_StsACAAC_CoefValErr     | Invalid quantized coefficient value  | Mandatory  |
| OMX_StsACAAC_MaxSfbErr      | Invalid maxSfb value in relation to numSwb   | Mandatory  |
| OMX_StsACAAC_PlsDataErr     | Invalid pulse escape sequence data   | Mandatory  |
| OMX_StsACAAC_TnsNumFiltErr  | Invalid number of TNS filters  | Optional   |
| OMX_StsACAAC_TnsLenErr      | Invalid TNS region length  | Optional   |
| OMX_StsACAAC_TnsOrderErr    | Invalid order of TNS filter  | Optional   |
| OMX_StsACAAC_TnsCoefResErr  | Invalid bit-resolution for TNS filter coefficients   | Optional   |
| OMX_StsACAAC_TnsCoefErr     | Invalid TNS filter coefficients  | Optional   |
| OMX_StsACAAC_TnsDirectErr   | Invalid TNS filter direction   | Optional   |
| OMX_StsICJP_JPEGMarkerErr   | JPEG marker encountered within an entropy-coded block; Huffman decoding operation terminated early | Optional   |
| OMX_StsICJP_JPEGMarker      | JPEG marker encountered; Huffman decoding operation terminated early                               | Optional   |
| OMX_StsIP_SizeErr           | One or more ROI size fields has negative or zero value   | Optional   |
| OMX_StsIP_StepErr           | Step value is less or equal zero   | Optional   |
| OMX_StsIPBM_MirrorFlipErr   | Invalid flip mode  | Optional   |
| OMX_StsIPBM_ScaleRangeErr   | Scale bounds is out of range   | Optional   |
| OMX_StsIPPP_AnchorErr       | The anchor point is outside mask   | Optional   |
| OMX_StsIPPP_ChannelErr      | Illegal channel number   | Optional   |
| OMX_StsIPPP_ContextMatchErr | The context parameter doesn't match to   | Optional   |

| Return Code                     | Associated Message                                      | Classification |
|---------------------------------|---|----------------|
|                                 | the operation   |                |
| OMX_StsSP_EvenMedianMaskSizeErr | Even size of median filter mask was replaced by odd one | Optional       |

When an error occurs, function execution is interrupted and control is returned to the caller. The status codes ending with “Err,” except for the `OMX_Sts_NoErr` status, indicate an error. When a warning condition occurs, execution is completed, and the warning status code is returned.

### 1.6.10 Error Status

If an error occurs and an error code is returned, then the values of all output parameters shall be undefined UNLESS otherwise explicitly specified in the description of an individual function.

### 1.6.11 Implementation-Dependent Data Structures

The OpenMAX DL API provides a facility (void \*) to represent vendor-specific information that may be implementation-dependent. For example, the `OMXFFTSPEC_C_SC32` structure might be used to store twiddle factors and bit reversal indices that are needed to compute the fast Fourier transform. The contents of implementation-dependent data structures are not defined in public header files.

## 1.7 Header Files

The API set forth in this specification is formalized in the companion set of ANSI-C header files (.h) listed in Table 1-6. The contents this document shall supersede the header files in the event of any inconsistencies between this document and the header files.

**Table 1-6: OpenMAX-DL Header Files**

| Filename | Domain           | Sub-Domains              | API Specification Section Reference(s) |
|----------|------------------|--------------------------|--|
| omxAC.h  | Audio Coding     | MP3                      | 1.6, 3.0, 3.1                          |
|          |                  | AAC-LC                   | 1.6, 3.0, 3.2                          |
| omxIC.h  | Image Coding     | JPEG                     | 1.6, 5.0, 5.1                          |
| omxIP.h  | Image Processing | Bitmap Manipulation      | 1.6, 4.0, 4.1, 4.2                     |
|          |                  | Pre- and Post-Processing | 1.6, 4.0, 4.1, 4.3                     |
|          |                  | Color Space Conversion   | 1.6, 4.0, 4.1, 4.4                     |

|            |                                    |                  |                    |
|------------|------------------------------------|------------------|--------------------|
| omxSP.h    | Signal Processing                  | None             | 1.6, 2.0 – 2.2     |
| omxVC.h    | Video Coding                       | Common           | 1.6, 6.0 – 6.1     |
|            |                                    | MPEG4 Part 2     | 1.6, 6.0 – 6.2     |
|            |                                    | MPEG4 Part 10    | 1.6, 6.0, 6.1, 6.3 |
| omxtypes.h | Data Types and General Definitions | N/A              | 1.6, 1.6.3-1.6.4   |
| omxDLx.h   | Optional Extensions                | Image Processing | A.1, A.2           |
|            |                                    | Image Coding     | A.1, A.3-A.4       |
|            |                                    | Video Coding     | A.1, A.5-A.6       |

## 1.8 Implementation Methodologies

There are three implementation methodologies associated with OpenMAX DL: synchronous, asynchronous, and integration. The synchronous methodology is on a DL API basis as specified in this document. The asynchronous and integration methodologies are defined in Chapter 7, "Concurrency Mechanisms." These methodologies are defined in this specification document, but are not defined in any public header files.

## 1.9 Accuracy Criteria

The implementation accuracy and conformance criteria set forth in the OpenMAX DL 1.0 Adopter's Package Conformance Test Specification shall supersede numerical accuracy criteria specified directly in this document (OpenMAX DL 1.0 API Specification) or incorporated by reference to another document.

# 2.0 Signal Processing

## 2

This section describes the functions and data structures that comprise the OpenMAX DL signal processing domain (omxSP) API. It includes functions for digital filtering, discrete transforms, and vector manipulation.

## 2.1 Data Structures

The following vendor-specific data structures are defined for the omxSP domain:

- OMXFFTSpec\_C\_SC16
- OMXFFTSpec\_C\_SC32
- OMXFFTSpec\_R\_S16S32
- OMXFFTSpec\_R\_S32

The contents of vendor-specific data structures may be implementation-dependent.

## 2.2 Functions

### 2.2.1 Vector Manipulation

#### 2.2.1.1 Block Copy

##### 2.2.1.1.1 Copy\_S16

###### Prototype

```
OMXResult omxSP_Copy_S16(const OMX_S16 *pSrc, OMX_S16 *pDst, OMX_INT len);
```

###### Description

Copies the `len` elements of the vector pointed to by `pSrc` into the `len` elements of the vector pointed to by `pDst`. That is:

$$pDst[i] = pSrc[i], i=0, 1, \dots, len-1$$



### Input Arguments

- `pSrc` – pointer to the source vector
- `len` – number of elements contained in the source and destination vectors

### Output Arguments

- `pDst` – pointer to the destination vector

### Returns

- `OMX_Sts_NoErr` – no error
- `OMX_Sts_BadArgErr` – bad arguments detected; returned if one or more of the following is true:
  - `pSrc` or `pDst` is `NULL`
  - `len < 0`

## 2.2.2 Vector Arithmetic

### 2.2.2.1 Dot Product

#### 2.2.2.1.1 DotProd\_S16

##### Prototype

```
OMX_S32 omxSP_DotProd_S16 (const OMX_S16 *pSrc1, const OMX_S16 *pSrc2,  
    OMX_INT len);
```

##### Description

Calculates the dot product of the two input vectors. This function does not perform scaling. The internal accumulator width must be at least 32 bits. If any of the partially accumulated values exceeds the range of a signed 32-bit integer then the result is undefined.

##### Input Arguments

- `pSrc1` – pointer to the first input vector; must be aligned on an 8-byte boundary.
- `pSrc2` – pointer to the second input vector; must be aligned on an 8-byte boundary.
- `len` – length of the vectors in `pSrc1` and `pSrc2`

##### Returns

- The dot product result



*Note: this function returns the actual result rather than the standard OMXError.*

---

## 2.2.2.1.2 DotProd\_S16\_Sfs

### Prototype

```
OMX_S32 omxSP_DotProd_S16_Sfs (const OMX_S16 *pSrc1, const OMX_S16 *pSrc2,  
    OMX_INT len, OMX_INT scaleFactor);
```

### Description

Calculates the dot product of the two input signals with output scaling and saturation, i.e., the result is multiplied by two to the power of the negative (-)scalefactor (scaled) prior to return. The result is saturated with rounding if the scaling operation produces a value outside the range of a signed 32-bit integer. Rounding behavior is defined in section 1.6.7 Integer Scaling and Rounding Conventions. The internal accumulator width must be at least 32 bits. The result is undefined if any of the partially accumulated values exceeds the range of a signed 32-bit integer.

### Input Arguments

- pSrc1 – pointer to the first input vector; must be aligned on an 8-byte boundary.
- pSrc2 – pointer to the second input vector; must be aligned on an 8-byte boundary.
- len – length of the vectors in pSrc1 and pSrc2
- scaleFactor – integer scalefactor

### Returns

- The dot product result



*Note: This function returns the actual result rather than the standard OMXError.*

---

## 2.2.2.2 Block Exponent

### 2.2.2.2.1 BlockExp\_S16

### 2.2.2.2.2 BlockExp\_S32

#### Prototype

```
OMX_INT omxSP_BlockExp_S16 (const OMX_S16 *pSrc, OMX_INT len);  
OMX_INT omxSP_BlockExp_S32 (const OMX_S32 *pSrc, OMX_INT len);
```

#### Description

Block exponent calculation for 16-bit and 32-bit signals (count leading sign bits). These functions compute the number of extra sign bits of all values in the 16-bit and 32-bit input vector pSrc and return the minimum sign bit count. This is also the maximum shift value that could be used in scaling the block of data. The functions BlockExp\_S16 and BlockExp\_S32 return the values 15 and 31, respectively, for

input vectors in which all entries are equal to zero.



*Note: These functions differ from other DL functions by not returning the standard OMXError but the actual result.*

---

### Input Arguments

- `pSrc` – pointer to the input vector
- `len` – number of elements contained in the input and output vectors ( $0 < \text{len} < 65536$ )

### Output Arguments

- none

### Return

- Maximum exponent that may be used in scaling

## 2.2.3 Filtering

This section defines functions for digital filtering. Supported filter types include the following:

- Finite Impulse Response (FIR)
- Infinite Impulse Response (IIR)
- Biquad IIR

For simplicity and consistency, the mathematical expressions in this section that describe the behavior of each filter function represent the case of the non-in-place and non-scaled variable (the default version). The behavior of any scaled and/or in-place variables can be best understood by applying to the default behavioral specification the generic in-place and scaled function behavioral rules that are given in section 1.6, “API Conventions.” Moreover, several of the filters described in this section make use of the Qm.n integer fixed-point representation of floating-point parameters. A detailed description of the Qm.n format are given in section 1.6, “API Conventions.”

### 2.2.3.1 FIR Filters

This section describes the FIR filtering functions, including block- and single-sample instantiations. An FIR filter is a discrete-time linear system for which the value of the current output sample can be determined by computing a weighted sum of the current and past input samples. In particular, the operation of an FIR filter can be described in terms of the time-domain difference equation:

$$y(n) = \sum_{k=0}^K b_k x(n-k)$$

where  $x(n)$  is the input sequence,  $y(n)$  is the output sequence,  $b_k$  are the filter coefficients (called “taps”),  $K$  is the filter order, and  $n$  is the discrete-time (sample) index. For the omxSP functions that implement FIR

filtering, the floating point filter coefficients,  $b_k$ , are represented using Q15 parameters, such that

$$pTapsQ15(k) = b_k \cdot 32768, \quad 0 \leq k < tapsLen$$

Because the underlying type is `OMX_S16`, the filter coefficients must be normalized so that  $|b_k| \leq 1$  prior to the Q0.15 scaling. In addition to Q0.15 coefficient representations, the block- and single-sample FIR functions require external state buffers (filter memories).

### 2.2.3.1.1 FIR\_Direct\_S16

#### Prototype

```
OMXResult omxSP_FIR_Direct_S16(const OMX_S16 *pSrc, OMX_S16 *pDst, OMX_INT
    sampLen, const OMX_S16 *pTapsQ15, OMX_INT tapsLen, OMX_S16 *pDelayLine,
    OMX_INT *pDelayLineIndex);

OMXResult omxSP_FIR_Direct_S16_I(OMX_S16 *pSrcDst, OMX_INT sampLen, const
    OMX_S16 *pTapsQ15, OMX_INT tapsLen, OMX_S16 *pDelayLine, OMX_INT
    *pDelayLineIndex);

OMXResult omxSP_FIR_Direct_S16_Sfs(const OMX_S16 *pSrc, OMX_S16 *pDst,
    OMX_INT sampLen, const OMX_S16 *pTapsQ15, OMX_INT tapsLen, OMX_S16
    *pDelayLine, OMX_INT *pDelayLineIndex, OMX_INT scaleFactor);

OMXResult omxSP_FIR_Direct_S16_Isfs(OMX_S16 *pSrcDst, OMX_INT sampLen, const
    OMX_S16 *pTapsQ15, OMX_INT tapsLen, OMX_S16 *pDelayLine, OMX_INT
    *pDelayLineIndex, OMX_INT scaleFactor);
```

#### Description

`omxSP_FIR_Direct_S16` and `omxSP_FIR_Direct_S16_I`

Block FIR filtering for 16-bit data type. This function applies the FIR filter defined by the coefficient vector `pTapsQ15` to a vector of input data. The result is saturated with rounding if the operation produces a value outside the range of a signed 16-bit integer. Rounding behavior is defined in section 1.6.7 Integer Scaling and Rounding Conventions. The internal accumulator width must be at least 32 bits. The result is undefined if any of the partially accumulated values exceeds the range of a signed 32-bit integer.

`omxSP_FIR_Direct_S16_Sfs` and `omxSP_FIR_Direct_S16_Isfs`

Block FIR filtering for 16-bit data type. This function applies the FIR filter defined by the coefficient vector `pTapsQ15` to a vector of input data. The output is multiplied by  $2^{-\text{scalefactor}}$  before returning to the caller. Scaling and rounding conventions are defined in section 1.6.7. The internal accumulator width must be at least 32 bits. The result is undefined if any of the partially accumulated values exceeds the range of a signed 32-bit integer.

#### Input Arguments

- `pSrc`, `pSrcDst` – pointer to the vector of input samples to which the filter is applied
- `sampLen` – the number of samples contained in the input and output vectors

- `pTapsQ15` – pointer to the vector that contains the filter coefficients, represented in Q0.15 format (defined in section 1.6.5). Given that  $-32768 \leq pTapsQ15(k) < 32768$ ,  $0 \leq k < tapsLen$ , the range on the actual filter coefficients is  $-1 \leq b_k < 1$ , and therefore coefficient normalization may be required during the filter design process.
- `tapsLen` – the number of taps, or, equivalently, the filter order + 1
- `pDelayLine` – pointer to the  $2 \cdot tapsLen$  -element filter memory buffer (state). The user is responsible for allocation, initialization, and de-allocation. The filter memory elements are initialized to zero in most applications.
- `pDelayLineIndex` – pointer to the filter memory index that is maintained internally by the function. The user should initialize the value of this index to zero.
- `scaleFactor` – saturation fixed scalefactor (only for the scaled function).

### Output Arguments

- `pDst`, `pSrcDst` – pointer to the vector of filtered output samples

### Returns

- `OMX_Sts_NoErr` – no error
- `OMX_Sts_BadArgErr` – bad arguments; returned if one or more of the following is true:
  - One or more of the following pointers is NULL: `pSrc`, `pDst`, `pSrcDst`, `pTapsQ15`, `pDelayLine`, or `pDelayLineIndex`
  - `samplen < 0`
  - `tapslen < 1`
  - `scaleFactor < 0`
  - `*pDelayLineIndex < 0` or `*pDelayLineIndex >= (2 * tapslen)`

□

## 2.2.3.1.2 FIROne\_Direct\_S16

### Prototype

```
OMXResult omxSP_FIROne_Direct_S16(OMX_S16 val, OMX_S16 *pResult, const
    OMX_S16 *pTapsQ15, OMX_INT tapsLen, OMX_S16 *pDelayLine, OMX_INT
    *pDelayLineIndex);

OMXResult omxSP_FIROne_Direct_S16_I(OMX_S16 *pValResult, const OMX_S16
    *pTapsQ15, OMX_INT tapsLen, OMX_S16 *pDelayLine, OMX_INT
    *pDelayLineIndex);

OMXResult omxSP_FIROne_Direct_S16_Sfs(OMX_S16 val, OMX_S16 *pResult, const
    OMX_S16 *pTapsQ15, OMX_INT tapsLen, OMX_S16 *pDelayLine, OMX_INT
    *pDelayLineIndex, OMX_INT scaleFactor);

OMXResult omxSP_FIROne_Direct_S16_ISfs(OMX_S16 *pValResult, const OMX_S16
    *pTapsQ15, OMX_INT tapsLen, OMX_S16 *pDelayLine, OMX_INT
    *pDelayLineIndex, OMX_INT scaleFactor);
```

## Description

`omxSP_FIROne_Direct_S16` and `omxSP_FIROne_Direct_S16_I`: Single-sample FIR filtering for 16-bit data type. These functions apply the FIR filter defined by the coefficient vector `pTapsQ15` to a single sample of input data. The result is saturated with rounding if the operation produces a value outside the range of a signed 16-bit integer. Rounding behavior is defined in section 1.6.7 Integer Scaling and Rounding Conventions. The internal accumulator width must be at least 32 bits. The result is undefined if any of the partially accumulated values exceeds the range of a signed 32-bit integer.

`omxSP_FIROne_Direct_S16_Sfs` and `omxSP_FIROne_Direct_S16_ISfs`: Single-sample FIR filtering for 16-bit data type. These functions apply the FIR filter defined by the coefficient vector `pTapsQ15` to a single sample of input data. The output is multiplied by 2 to the negative power of scalefactor (i.e.,  $2^{-\text{scalefactor}}$ ) before returning to the user. Scaling and rounding conventions are defined in section 1.6.7. The internal accumulator width must be at least 32 bits. The result is undefined if any of the partially accumulated values exceeds the range of a signed 32-bit integer.

## Input Arguments

- `val`, `pValResult` – the single input sample to which the filter is applied. A pointer is used for the in-place version.
- `pTapsQ15` – pointer to the vector that contains the filter coefficients, represented in Q0.15 format (as defined in section 1.6.5). Given that  $-32768 \leq pTapsQ15(k) < 32768$ ,  $0 \leq k < tapsLen$ , the range on the actual filter coefficients is  $-1 \leq b_k < 1$ , and therefore coefficient normalization may be required during the filter design process.
- `tapsLen` – the number of taps, or, equivalently, the filter order + 1
- `pDelayLine` – pointer to the  $2 \cdot tapsLen$  -element filter memory buffer (state). The user is responsible for allocation, initialization, and de-allocation. The filter memory elements are initialized to zero in most applications.
- `pDelayLineIndex` – pointer to the filter memory index that is maintained internally by the function. The user should initialize the value of this index to zero.
- `scaleFactor` – saturation fixed scaleFactor (only for the scaled function)

## Output Arguments

- `pResult`, `pValResult` – pointer to the filtered output sample

## Returns

- `OMX_Sts_NoErr` – no error
- `OMX_Sts_BadArgErr` – bad arguments; returned if one or more of the following is true:
  - One or more of the following pointers is NULL: `pResult`, `pValResult`, `pTapsQ15`, `pDelayLine`, or `pDelayLineIndex`
  - `tapslen < 1`
  - `scaleFactor < 0`
  - `*pDelayLineIndex < 0` or `*pDelayLineIndex >= (2 * tapslen)`

### 2.2.3.2 IIR Filters

This section describes the IIR filtering functions, including block and single sample variants. An IIR filter is a discrete-time linear system for which the value of the current output sample can be determined by computing a weighted sum of the current input sample, past input samples, and past output samples. In particular, the operation of an IIR filter can be described in terms of the time-domain difference equation, i.e.,

$$y(n) = \sum_{k=0}^K b_k x(n-k) - \sum_{m=1}^M a_m y(n-m)$$

where  $x(n)$  is the input sequence,  $y(n)$  is the output sequence,  $n$  is the discrete-time (sample) index, and  $a_m$  and  $b_K$  are the filter coefficients (aka “taps”). For the omxSP IIR filter implementations, the filter coefficients  $b_k$  and  $a_m$  are represented in a combined coefficient vector that is referenced by the parameter `pTaps` and is organized as follows:

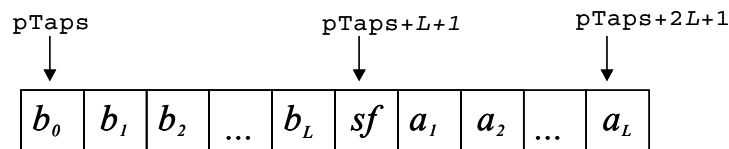

The combined coefficient vector contains  $2L+2$  elements, where  $L = \max\{K, M\}$ . Therefore, if  $K \neq M$  for a particular filter design, the user must pad with zeros the smaller set of coefficients such that the organization of the combined coefficient vector matches the figure. For example, if  $K=2$  and  $M=3$ , then the combined coefficient vector would be arranged as follows:

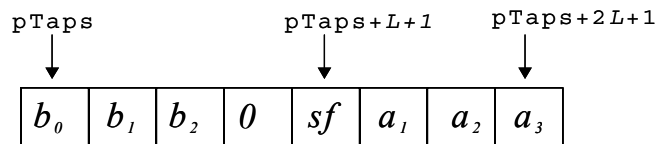

The specific Q-format used to represent the elements of the IIR coefficient vector is controlled by the scaling coefficient denoted in the above figure by  $sf$ . In particular, the actual filter coefficients are related to the elements of the coefficient vector in the following way:

$$b_k = pTaps(k) \cdot 2^{-sf}, \quad 0 \leq k \leq K$$

and

$$a_m = pTaps(m+L+2) \cdot 2^{-sf}, \quad 0 \leq m \leq M$$

where

$$sf = pTaps(L+1), \text{ and } sf \geq 0.$$

### 2.2.3.2.1 IIR\_Direct\_S16

#### Prototype

```
OMXResult omxSP_IIR_Direct_S16(const OMX_S16 *pSrc, OMX_S16 *pDst, OMX_INT
    len, const OMX_S16 *pTaps, OMX_INT order, OMX_S32 *pDelayLine);
OMXResult omxSP_IIR_Direct_S16_I(OMX_S16 *pSrcDst, OMX_INT len, const
    OMX_S16 *pTaps, OMX_INT order, OMX_S32 *pDelayLine);
```

#### Description

Block IIR filtering for 16-bit data. This function applies the direct form II IIR filter defined by the coefficient vector `pTaps` to a vector of input data. The internal accumulator width must be at least 32 bits, and the result is saturated if the operation produces a value outside the range of a signed 16-bit integer, i.e., the output will saturate to `0x8000` (-32768) for a negative overflow or `0x7fff` (32767) for a positive overflow. The result is undefined if any of the partially accumulated values exceeds the range of a signed 32-bit integer.

#### Input Arguments

- `pSrc`, `pSrcDst` – pointer to the vector of input samples to which the filter is applied
- `len` – the number of samples contained in both the input and output vectors
- `pTaps` – pointer to the  $2L+2$ -element vector that contains the combined numerator and denominator filter coefficients from the system transfer function,  $H(z)$ . Coefficient scaling and coefficient vector organization should follow the conventions described above. The value of the coefficient scaleFactor exponent must be non-negative ( $sf \geq 0$ ).
- `order` – the maximum of the degrees of the numerator and denominator coefficient polynomials from the system transfer function,  $H(z)$ . In the notation of section 2.2.3.2, the parameter  $order = \max(K, M) = L$  gives the maximum delay, in samples, used to compute each output sample.
- `pDelayLine` – pointer to the  $L$ -element filter memory buffer (state). The user is responsible for allocation, initialization, and deallocation. The filter memory elements are initialized to zero in most applications.

#### Output Arguments

- `pDst`, `pSrcDst` – pointer to the vector of filtered output samples

#### Returns

- `OMX_Sts_NoErr` – no error
- `OMX_Sts_BadArgErr` – bad arguments; returned if one or more of the following is true:
  - one or more of the following pointers is NULL: `pSrc`, `pDst`, `pSrcDst`, `pTaps`, or `pDelayLine`.
  - `len < 0`
  - `order < 1`
  - `pTaps[order+1] < 0` (negative scaling)



## 2.2.3.2.2 IIROne\_Direct\_S16

### Prototype

```
OMXResult omxSP_IIROne_Direct_S16 (OMX_S16 val, OMX_S16 *pResult, const
    OMX_S16 *pTaps, OMX_INT order, OMX_S32 *pDelayLine);
OMXResult omxSP_IIROne_Direct_S16_I(OMX_S16 *pValResult, const OMX_S16
    *pTaps, OMX_INT order, OMX_S32 *pDelayLine);
```

### Description

Single sample IIR filtering for 16-bit data. This function applies the direct form II IIR filter defined by the coefficient vector `pTaps` to a single sample of input data. The internal accumulator width must be at least 32 bits, and the result is saturated if the operation produces a value outside the range of a signed 16-bit integer, i.e., the output will saturate to 0x8000 (-32768) for a negative overflow or 0x7fff (32767) for a positive overflow. The result is undefined if any of the partially accumulated values exceeds the range of a signed 32-bit integer.

### Input Arguments

- `val`, `pValResult` – the single input sample to which the filter is applied. A pointer is used for the in-place version.
- `pTaps` – pointer to the  $2L+2$  -element vector that contains the combined numerator and denominator filter coefficients from the system transfer function,  $H(z)$ . Coefficient scaling and coefficient vector organization should follow the conventions described above. The value of the coefficient scaleFactor exponent must be non-negative ( $sf \geq 0$ ).
- `order` – the maximum of the degrees of the numerator and denominator coefficient polynomials from the system transfer function,  $H(z)$ . In the notation of section 2.2.3.2, the parameter  $order = \max(K, M) = L$  gives the maximum delay, in samples, used to compute each output sample.
- `pDelayLine` – pointer to the  $L$ -element filter memory buffer (state). The user is responsible for allocation, initialization, and deallocation. The filter memory elements are initialized to zero in most applications.

### Output Arguments

- `pResult`, `pValResult` – pointer to the filtered output sample

### Returns

- `OMX_Sts_NoErr` – no error
- `OMX_Sts_BadArgErr` – bad arguments; returned if one or more of the following is true:
  - one or more of the following pointers is NULL: `pResult`, `pValResult`, `pTaps`, or `pDelayLine`.
  - `order < 1`
  - `pTaps[order+1] < 0` (negative scaling)

### 2.2.3.3 Biquad IIR Filters

For the block and single-sample variables, the floating point filter coefficients  $b_k$  and  $a_m$  for all of the biquad stages are represented in a combined coefficient vector that the parameter `pTaps` points to and is organized as shown in Figure 2-1:

**Figure 2-1: Combined Coefficient Vector Organization**

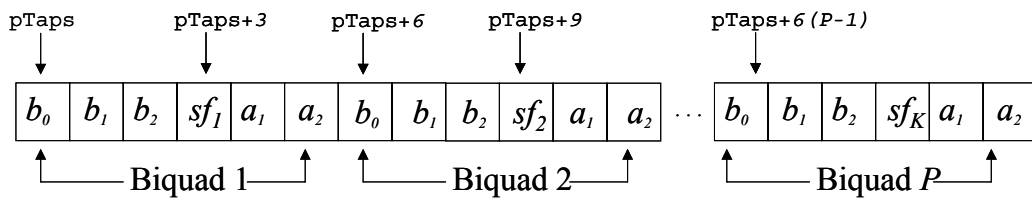

The combined coefficient vector contains  $6P$  elements, where  $P$  is the number of biquad stages in the cascade structure. As with the coefficient vector for the standard IIR function, if  $K \neq M$  for any constituent filter, then the user must pad with zeros the smaller set of coefficients such that the organization of the combined coefficient vector matches the figure. The specific Q-format used to represent the elements of the  $P^{\text{th}}$  biquad section is controlled by the scaling coefficient denoted in the above figure by  $sf_p$ ,  $1 \leq p \leq P$ , where  $sf_p \geq 0$ . In particular, the actual filter coefficients for the  $P^{\text{th}}$  biquad section are related to the elements of the coefficient vector in the following way:

$$b_k = pTaps(6(p-1)+k) \cdot 2^{-sf_p}, \quad 0 \leq k \leq k_p$$

and

$$a_m = pTaps(6(p-1)+m+4) \cdot 2^{-sf_p}, \quad 0 \leq m \leq M_p.$$

where  $sf_p = pTaps(6(p-1)+3)$ ,  $K_p$  is the order of the  $P^{\text{th}}$  biquad numerator polynomial, and  $M_p$  is the order of the  $P^{\text{th}}$  biquad denominator polynomial.

#### 2.2.3.3.1 IIR\_BiQuadDirect\_S16

##### Prototype

```
OMXResult omxSP_IIR_BiQuadDirect_S16(const OMX_S16 *pSrc, OMX_S16 *pDst,
    OMX_INT len, const OMX_S16 *pTaps, OMX_INT numBiquad, OMX_S32
    *pDelayLine);
OMXResult omxSP_IIR_BiQuadDirect_S16_I(OMX_S16 *pSrcDst, OMX_INT len, const
    OMX_S16 *pTaps, OMX_INT numBiquad, OMX_S32 *pDelayLine);
```

## Description

Block biquad IIR filtering for 16-bit data type. This function applies the direct form II biquad IIR cascade defined by the coefficient vector `pTaps` to a vector of input data. The internal accumulator width must be at least 32 bits, and the result is saturated if the operation produces a value outside the range of a signed 16-bit integer, i.e., the output will saturate to 0x8000 (-32768) for a negative overflow or 0x7fff (32767) for a positive overflow. The result is undefined if any of the partially accumulated values exceeds the range of a signed 32-bit integer.

## Input Arguments

- `pSrc`, `pSrcDst` – pointer to the vector of input samples to which the filter is applied
- `len` – the number of samples contained in both the input and output vectors
- `pTaps` – pointer to the  $6P$ -element vector that contains the combined numerator and denominator filter coefficients from the biquad cascade. Coefficient scaling and coefficient vector organization should follow the conventions described above. The value of the coefficient `scaleFactor` exponent must be non-negative. ( $sfp \geq 0$ ).
- `numBiquad` – the number of biquads contained in the IIR filter cascade: ( $P$ )
- `pDelayLine` – pointer to the  $2P$ -element filter memory buffer (state). The user is responsible for allocation, initialization, and de-allocation. The filter memory elements are initialized to zero in most applications.

## Output Arguments

- `pDst`, `pSrcDst` – pointer to the vector of filtered output samples

## Returns

- `OMX_Sts_NoErr` – no error
- `OMX_Sts_BadArgErr` – bad arguments; returned if one or more of the following is true:
  - one or more of the following pointers is NULL: `pSrc`, `pDst`, `pSrcDst`, `pTaps`, or `pDelayLine`.
  - `len < 0`
  - `numBiquad < 1`
  - `pTaps[3+n*6] < 0`, for  $0 \leq n < \text{numBiquad}$  (negative scaling)

### 2.2.3.3.2 IIROne\_BiQuadDirect\_S16

#### Prototype

```
OMXResult omxSP_IIROne_BiQuadDirect_S16(OMX_S16 val, OMX_S16 *pResult, const
    OMX_S16 *pTaps, OMX_INT numBiquad, OMX_S32 *pDelayLine);
OMXResult omxSP_IIROne_BiQuadDirect_S16_I(OMX_S16 *pValResult, const OMX_S16
    *pTaps, OMX_INT numBiquad, OMX_S32 *pDelayLine);
```

## Description

Single-sample biquad IIR filtering for 16-bit data type. This function applies the direct form II biquad IIR cascade defined by the coefficient vector `pTaps` to a single sample of input data. The internal accumulator width must be at least 32 bits, and the result is saturated if the operation produces a value outside the range of a signed 16-bit integer, i.e., the output will saturate to `0x8000` (-32768) for a negative overflow or `0x7fff` (32767) for a positive overflow. The result is undefined if any of the partially accumulated values exceeds the range of a signed 32-bit integer.

## Input Arguments

- `val`, `pValResult` – the single input sample to which the filter is applied. A pointer is used for the in-place version.
- `pTaps` – pointer to the 6P-element vector that contains the combined numerator and denominator filter coefficients from the biquad cascade. Coefficient scaling and coefficient vector organization should follow the conventions described above. The value of the coefficient scalefactor exponent must be non-negative: (`sfp`≥0).
- `numBiquad` – the number of biquads contained in the IIR filter cascade: (P)
- `pDelayLine` – pointer to the 2p-element filter memory buffer (state). The user is responsible for allocation, initialization, and deallocation. The filter memory elements are initialized to zero in most applications.

## Output Arguments

- `pResult`, `pValResult` – pointer to the filtered output sample

## Returns

- `OMX_Sts_NoErr` – no error
- `OMX_Sts_BadArgErr` – bad arguments; returned if one or more of the following is true:
  - one or more of the following pointers is NULL: `pResult`, `pValResult`, `pTaps`, or `pDelayLine`.
  - `numBiquad` < 1
  - `pTaps[3+n*6] < 0`, for  $0 \leq n < \text{numBiquad}$  (negative scaling)

## 2.2.3.4 Median Filters

### 2.2.3.4.1 FilterMedian\_S32

#### Prototype

```
OMXResult omxSP_FilterMedian_S32(const OMX_S32 *pSrc, OMX_S32 *pDst, OMX_INT len, OMX_INT maskSize);  
OMXResult omxSP_FilterMedian_S32_I(OMX_S32 *pSrcDst, OMX_INT len, OMX_INT maskSize);
```

## Description

This function computes the median over the region specified by the median mask for the every element of the input array. The median outputs are stored in the corresponding elements of the output vector.

## Input Arguments

- `pSrc` – pointer to the input vector
- `pSrcDst` – pointer to the input vector
- `len` – number of elements contained in the input and output vectors ( $0 < \text{len} < 65536$ )
- `maskSize` – median mask size; if an even value is specified, the function subtracts 1 and uses the odd value of the filter mask for median filtering ( $0 < \text{maskSize} < 256$ )

## Output Arguments

- `pDst` – pointer to the median-filtered output vector
- `pSrcDst` – pointer to the median-filtered output vector

## Return

- `OMX_Sts_NoErr` – no error
- `OMX_Sts_BadArgErr` – bad arguments; returned if one or more of the following is true:
  - one or more of the following pointers is NULL: `pSrc`, `pDst`, or `pSrcDst`.
  - `len < 0`
  - `maskSize < 1` or `maskSize > 255`
- `OMX_StsSP_EvenMedianMaskSizeErr` – even mask size replaced by odd mask size

## 2.2.3.5 Filtering Usage Examples

This section provides 'C' language source listings that illustrate the usage of the FIR, IIR, and biquad IIR filtering functions.

### 2.2.3.5.1 FIR Filter Example

#### Example 2-1: `omxSP_FIR_Direct_S16_Sfs` Usage

*This example illustrates the usage of the scaled FIR filtering function, `FIR_Direct_S16_Sfs`. The example code implements a linear-phase, lowpass, 19<sup>th</sup> order FIR filter having the coefficient:*

$$b_k = \{.08, 0.10492407, 0, 0.17699537, 0.28840385, \dots, 0.08\}$$

*Given that*

$$\sum_{k=0}^{19} |b_k| = 10.34$$

*the dynamic range on the output, y(n), is  $-10.34 \leq y(n) < 10.34$ , which means that a Q4.11 output representation is required to avoid saturation in the 16-bit output word. Therefore, the scaled FIR function is used to accommodate the dynamic range on the output with a scalefactor value of 4.*

```
#include <stdio.h>
#include <stdlib.h>
#include <math.h>
#include "omxSP.h"
#define tapsLen 20
#define N 40
#define scaleFactor 4

OMX_INT main()
{
    OMX_INT    i;
    OMX_S16    pSrc[N], pDst[N];
    OMX_S32    pDelayLine[tapsLen*2];
    OMX_INT    delayLineIndex;
    OMX_S16    pTaps[tapsLen];
    float b[tapsLen] =
    { 0.080000000, 0.104924069, 0.176995366, 0.288403847, 0.427076676,
      0.577986499, 0.724779895, 0.851549523, 0.944557926, 0.993726200,
      0.993726200, 0.944557926, 0.851549523, 0.724779895, 0.577986499,
      0.427076676, 0.288403847, 0.176995366, 0.104924069, 0.080000000 };

    /* scale the filter taps to Q15 */
    for ( i = 0; i < tapsLen; i ++ ) {
        b[i] *= (1<<14);
        pTaps[i] = (b[i] > 32767)?32767 : b[i];
    }
    /* random input signal */
    srand(200);
    for ( i = 0; i < N; i ++ )
        pSrc[i] = rand() - 32768/2;
```

```

delayLineIndex = 0;
for ( i = 0; i < tapsLen*2; i ++ )
    pDelayLine[i] = 0;
omxSP_FIR_Direct_S16_Sfs(pSrc, pDst, N, pTaps, tapsLen, pDelayLine,
    &delayLineIndex, scaleFactor);
/* display out signal vector */
for ( i = 0; i < N; i ++ ) {
    printf("%8d", pDst[i]);
    if ( (i+1)%5 == 0 ) {
        printf("\n");
    }
}
return(0);
}

```

### 2.2.3.5.2 IIR

The example below illustrates the usage of the omxSP\_IIR\_Direct\_S16 function.

#### Example 2-2: omxSP\_IIR\_Direct\_S16 Usage

```

#include <stdio.h>
#include "omxSP.h"
#define tapsLen 4
#define N 40

OMX_INT main()
{
    OMX_INT    i;
    OMX_S16 pSrc[N], pDst[N];

    /* here, the scaleFactor is 15 */
    OMX_S16 pTapsIIR[(tapsLen+1)*2] = {
        7922, 16348, 22394, 16348, 7922,    15,
        6338, 29356, 1841, 4222
    };
    OMX_S32 pDelayLineIIR[tapsLen];

```

```

for ( i = 0; i < tapsLen; i ++ ) {
    pDelayLineIIR[i] = 0;
}

printf("\nTesting <omxSP_IIR_Direct_S16>: \n");
for ( i = 0; i < N; i ++ ) {
    pSrc[i] = i;
}

omxSP_IIR_Direct_S16(pSrc, pDst, N, pTapsIIR,
tapsLen, pDelayLineIIR);
for ( i = 0; i < N; i ++ ) {
    printf("%8d", pDst[i]);
    if ( i%5 == 0 && i != 0 ) {
        printf("\n");
    }
}
return(0);
}
#undef N
#undef tapsLen

```

### 2.2.3.5.3 Biquad IIR

The example below illustrates the usage of the `omxSP_IIROne_BiQuadDirect_S16_I` function.

#### Example 2-3: `omxSP_IIROne_BiQuadDirect_S16_I` Usage

```

#include <stdio.h>
#include "omxSP.h"
#define numBiQuad 4
#define N 40

OMX_INT main()
{

```



```

    OMX_INT    i;

    OMX_S16 pValResult;
    OMX_S16 pTapsIIR[numBiQuad*6] = {
        3178,  4488,  3178, 14,  -922,  1766,
        7569, 2155,  7569, 14,  -225,  7572,
        9458,  513,  9458, 14,   11,  9542,
        9895,  159,  9895, 14,   55,  9934
    };

    OMX_S32 pDelayLineIIR[numBiQuad*2];

    for ( i = 0; i < numBiQuad*2; i ++ ) {
        pDelayLineIIR[i] = 0;
    }
    printf("\nTesting <omxSP_IIROne_BiQuadDirect_S16_I>:\n");
    for ( i = 0; i < N; i ++ ) {
        pValResult = i;
        omxSP_IIROne_BiQuadDirect_S16_I(&pValResult, pTapsIIR,
            numBiQuad, pDelayLineIIR);
        printf("%8d", pValResult);
        if ( i != 0 && i%5 == 0 ) {
            printf("\n");
        }
    }

    return(0);
}
#undef numBiQuad
#undef N

```

## 2.2.4 FFT

This section describes functions for computing variable-length FFTs, including:

- Forward and Inverse FFT for complex-valued sequences (“CToC”)

- Forward and Inverse FFT for real-valued input sequences (“RToCCS, CCSToR”)

The FFT functions support radix-2 block lengths of  $2^N$  for  $0 \leq N \leq 12$ . Helper functions are provided to initialize length-dependent specification structures that are required for each FFT. Example programs are provided to illustrate calling conventions. Throughout section 2.2.4 of this specification, the three letter acronym “CCS” shall be used to denote “complex conjugate symmetric.”

## 2.2.4.1 FFT Helper Functions

### 2.2.4.1.1 FFTInit\_C\_SC16

### 2.2.4.1.2 FFTInit\_C\_SC32

#### Prototype

```
OMXResult omxSP_FFTInit_C_SC16(OMXFFTSpec_C_SC16 *pFFTSpec, OMX_INT order);
OMXResult omxSP_FFTInit_C_SC32(OMXFFTSpec_C_SC32 *pFFTSpec, OMX_INT order);
```

#### Description

These functions initialize the specification structures required for the complex FFT and IFFT functions. Desired block length is specified as an input.

- The function <FFTInit\_C\_SC16> is used to initialize the specification structures for functions <FFTfwd\_CToC\_SC16\_Sfs> and <FFTInv\_CToC\_SC16\_Sfs>
- The function <FFTInit\_C\_SC32> is used to initialize the specification structures for the functions <FFTfwd\_CToC\_SC32\_Sfs> and <FFTInv\_CToC\_SC32\_Sfs>

Memory for the specification structure \*pFFTSpec must be allocated prior to calling these functions and should be 4-byte aligned for omxSP\_FFTInit\_C\_SC16 and 8-byte aligned for omxSP\_FFTInit\_C\_SC32. The space required for \*pFFTSpec, in bytes, can be determined using <FFTGetBufSize\_C\_SC16> and <FFTGetBufSize\_C\_SC32>, respectively, for the 16-bit and 32-bit functions.

#### Input Arguments

- order – base-2 logarithm of the desired block length; valid in the range [0,12]

#### Output Arguments

- pFFTSpec – pointer to initialized specification structure

#### Return

- OMX\_Sts\_NoErr - no error
- OMX\_Sts\_BadArgErr – bad arguments; returned if one or more of the following is true:
  - pFFTSpec is either NULL or violates the 8-byte alignment restrictions
  - order < 0 or order > 12

### 2.2.4.1.3 FFTInit\_R\_S16S32

### 2.2.4.1.4 FFTInit\_R\_S32

#### Prototype

```
OMXResult omxSP_FFTInit_R_S16S32(OMXFFTSpec_R_S16S32*pFFTFwdSpec, OMX_INT
    order);
OMXResult omxSP_FFTInit_R_S32(OMXFFTSpec_R_S32*pFFTFwdSpec, OMX_INT order);
```

#### Description

These functions initialize specification structures required for the real FFT and IFFT functions.

- The function <FFTInit\_R\_S16S32> is used to initialize the specification structures for functions <FFTFwd\_RTtoCCS\_S16S32\_sfs> and <FFTInv\_CCSToR\_S32S16\_sfs>.
- The function <FFTInit\_R\_S32> is used to initialize the specification structures for functions <FFTFwd\_RTtoCCS\_S32\_sfs> and <FFTInv\_CCSToR\_S32\_sfs>.

Memory for \*pFFTFwdSpec must be allocated before calling these function and should be 8-byte aligned. The number of bytes required for \*pFFTFwdSpec can be determined using <FFTGetBufSize\_R\_S16S32> and <FFTGetBufSize\_R\_S32>, respectively, for the 16-bit and 32-bit functions.

#### Input Arguments

- order – base-2 logarithm of the desired block length; valid in the range [0,12]

#### Output Arguments

- pFFTFwdSpec – pointer to the initialized specification structure

#### Return

- OMX\_Sts\_NoErr – no error
- OMX\_Sts\_BadArgErr – bad arguments; returned if one or more of the following is true:
  - pFFTFwdSpec is either NULL or violates the 8-byte alignment restrictions
  - order < 0 or order > 12

### 2.2.4.1.5 FFTGetBufSize\_C\_SC16

### 2.2.4.1.6 FFTGetBufSize\_C\_SC32

#### Prototype

```
OMXResult omxSP_FFTGetBufSize_C_SC16(OMX_INT order, OMX_INT *pSize);
OMXResult omxSP_FFTGetBufSize_C_SC32(OMX_INT order, OMX_INT *pSize);
```

## Description

These functions compute the size of the specification structure required for the length  $2^{order}$  complex FFT and IFFT functions.

- The function <FFTGetBufSize\_C\_SC16> is used in conjunction with the 16-bit functions <FFTFwd\_CToC\_SC16\_Sfs> and <FFTInv\_CToC\_SC16\_Sfs>.
- The function <FFTGetBufSize\_C\_SC32> is used in conjunction with the 32-bit functions <FFTFwd\_CToC\_SC32\_Sfs> and <FFTInv\_CToC\_SC32\_Sfs>.

## Input Arguments

- `order` – base-2 logarithm of the desired block length; valid in the range [0,12]

## Output Arguments

- `pSize` – pointer to the number of bytes required for the specification structure

## Return

- `OMX_Sts_NoErr` – no error
- `OMX_Sts_BadArgErr` – bad arguments; returned if one or more of the following is true:
  - `pSize` is NULL
  - `order < 0` or `order > 12`

### 2.2.4.1.7 FFTGetBufSize\_R\_S16S32

### 2.2.4.1.8 FFTGetBufSize\_R\_S32

## Prototype

```
OMXResult omxSP_FFTGetBufSize_R_S16S32(OMX_INT order, OMX_INT *pSize);  
OMXResult omxSP_FFTGetBufSize_R_S32(OMX_INT order, OMX_INT *pSize);
```

## Description

These functions compute the size of the specification structure required for the length  $2^{order}$  real FFT and IFFT functions.

- The function <FFTGetBufSize\_R\_S16S32> is used in conjunction with the 16-bit functions <FFTFwd\_RToCCS\_S16S32\_Sfs> and <FFTInv\_CCSToR\_S32S16\_Sfs>.
- The function <FFTGetBufSize\_R\_S32> is used in conjunction with the 32-bit functions <FFTFwd\_RToCCS\_S32\_Sfs> and <FFTInv\_CCSToR\_S32\_Sfs>.

## Input Arguments

- `order` – base-2 logarithm of the length; valid in the range [0,12]

## Output Arguments

- `pSize` – pointer to the number of bytes required for the specification structure

## Return

- OMX\_Sts\_NoErr – no error
- OMX\_Sts\_BadArgErr – bad arguments

The function returns OMX\_Sts\_BadArgErr if one or more of the following is true:

- pSize is NULL
- order < 0 or order > 12

## 2.2.4.2 FFT for Complex-Valued Signals

### 2.2.4.2.1 FFTFwd\_CToC\_SC16\_Sfs

### 2.2.4.2.2 FFTFwd\_CToC\_SC32\_Sfs

## Prototype

```
OMXResult omxSP_FFTFwd_CToC_SC16_Sfs(const OMX_SC16 *pSrc, OMX_SC16 *pDst,  
    const OMXFFTSpec_C_SC16 *pFFTSpec, OMX_INT scaleFactor);  
OMXResult omxSP_FFTFwd_CToC_SC32_Sfs(const OMX_SC32 *pSrc, OMX_SC32 *pDst,  
    const OMXFFTSpec_C_SC32 *pFFTSpec, OMX_INT scaleFactor);
```

## Description

Compute an FFT for a complex signal of length of  $2^{order}$ , where  $0 \leq order \leq 12$ . Transform length is determined by the specification structure, which must be initialized prior to calling the FFT function using the appropriate helper, i.e., <FFTInit\_C\_sc32> or <FFTInit\_C\_sc16>. The relationship between the input and output sequences can be expressed in terms of the DFT, i.e.,

$$X[k] = 2^{-scaleFactor} \cdot \sum_{n=0}^{N-1} x[n] \cdot e^{-j\frac{2\pi}{N}nk}, k = 0,1,2,\dots,N-1; N = 2^{order}$$

## Input Arguments

- pSrc – pointer to the input signal, a complex-valued vector of length  $2^{order}$ ; must be aligned on a 32-byte boundary.
- pFFTSpec – pointer to the preallocated and initialized specification structure
- scaleFactor – output scale factor; the range for <omxSP\_FFTFwd\_CToC\_SC16\_Sfs> is [0,16], and for <omxSP\_FFTFwd\_CToC\_SC32\_Sfs> the range is [0,32]

## Output Arguments

- pDst – pointer to the complex-valued output vector, of length  $2^{order}$ ; must be aligned on a 32-byte boundary.

## Return

- OMX\_Sts\_NoErr – no error

- OMX\_Sts\_BadArgErr – returned if one or more of the following conditions is true:
  - one or more of the following pointers is NULL: pSrc, pDst, or pFFTSpec.
  - pSrc or pDst is not 32-byte aligned
  - scaleFactor<0 or scaleFactor >16 for <omxSP\_FFTFwd\_CToC\_SC16\_Sfs>
  - scaleFactor<0 or scaleFactor >32 for <omxSP\_FFTFwd\_CToC\_SC32\_Sfs>

### 2.2.4.2.3 FFTInv\_CToC\_SC16\_Sfs

### 2.2.4.2.4 FFTInv\_CToC\_SC32\_Sfs

#### Prototype

```
OMXResult omxSP_FFTInv_CToC_SC16_Sfs(const OMX_SC16 *pSrc, OMX_SC16 *pDst,
  const OMXFFTSpec_C_SC16 *pFFTSpec, OMX_INT scaleFactor);
```

```
OMXResult omxSP_FFTInv_CToC_SC32_Sfs(const OMX_SC32 *pSrc, OMX_SC32 *pDst,
  const OMXFFTSpec_C_SC32 *pFFTSpec, OMX_INT scaleFactor);
```

#### Description

These functions compute an inverse FFT for a complex signal of length of  $2^{order}$ , where  $0 \leq order \leq 12$ . Transform length is determined by the specification structure, which must be initialized prior to calling the FFT function using the appropriate helper, i.e., <FFTInit\_C\_sc32> or <FFTInit\_C\_SC16>. The relationship between the input and output sequences can be expressed in terms of the IDFT, i.e.,:

$$x[n] = \frac{2^{-scaleFactor}}{N} \cdot \sum_{k=0}^{N-1} X[k] \cdot e^{j\frac{2\pi}{N}nk}, n = 0,1,2,\dots,N-1; N = 2^{order}$$

#### Input Arguments

- pSrc – pointer to the complex-valued input signal, of length  $2^{order}$ ; must be aligned on a 32-byte boundary.
- pFFTSpec – pointer to the preallocated and initialized specification structure
- scaleFactor – scale factor of the output. Valid range for <omxSP\_FFTInv\_CToC\_SC16\_Sfs> is [0,16] and for <omxSP\_FFTInv\_CToC\_SC32\_Sfs> is [0,32].

#### Output Arguments

- pDst – pointer to the complex-valued output signal, of length  $2^{order}$ ; must be aligned on a 32-byte boundary.

#### Return

- OMX\_Sts\_NoErr – no error
- OMX\_Sts\_BadArgErr – returned if one or more of the following conditions is true:
  - one or more of the following pointers is NULL: pSrc, pDst, or pFFTSpec.
  - pSrc or pDst is not 32-byte aligned
  - scaleFactor<0 or scaleFactor >16 for <omxSP\_FFTInv\_CToC\_SC16\_Sfs>

— scaleFactor<0 or scaleFactor >32 for <omxSP\_FFTFwd\_CToC\_SC32\_Sfs>

### 2.2.4.3 Example, FFT for Complex-Valued Signals

#### Example 2-4: Complex-Valued FFT Usage

```
#include <stdio.h>
#include <stdlib.h>
#include <time.h>
#include "OMXSP.h"

OMXResult FFT_ctoc_example();

OMX_INT main()
{
    FFT_ctoc_example();
}

OMXResult FFT_ctoc_example()
{
    OMX_SC16 x[8], y[8], z[8];
    OMX_INT n, bufSize;
    OMXResult status;
    OMXFFTSpec_C_SC16 * pFwdSpec = NULL;
    OMXFFTSpec_C_SC16 * pInvSpec = NULL;

    srand( (unsigned)time( NULL ) );

    for(n=0; n<8; n++) {
        x[n].re = (OMX_S16)((rand()%1024)-512);
        x[n].im = (OMX_S16)((rand()%1024)-512);
    }

    status = omxSP_FFTGetBufSize_C_SC16(3, &bufSize);
    pFwdSpec = (OMX_U8*)malloc(bufSize);
    pInvSpec = (OMX_U8*)malloc(bufSize);
    status = omxSP_FFTInit_C_SC16( pFwdSpec, 3 );
}
```

```

    status = omxSP_FFTInit_C_SC16( pInvSpec, 3 );
    status = omxSP_FFTFwd_CToC_SC16_Sfs ( x, y, pFwdSpec, 0 );
    status = omxSP_FFTInv_CToC_SC16_Sfs ( y, z, pInvSpec, 0 );
    printf("n\tx.r\tx.i\tty.r\tty.i\ttz.r\ttz.i\n");
    for(n=0; n<8; n++) {
        printf("%d\t%d\t%d\t%d\t%d\t%d\t%d\n", n, x[n].re,
            x[n].im, y[n].re, y[n].im, z[n].re, z[n].im );
    }

    free( pFwdSpec );
    free( pInvSpec );

    return status;
}

```

## 2.2.4.4 FFT for Real-Valued Signals

### 2.2.4.4.1 FFTFwd\_RTCCS\_S16S32\_Sfs

### 2.2.4.4.2 FFTFwd\_RTCCS\_S32\_Sfs

#### Prototype

```

OMXResult omxSP_FFTFwd_RTCCS_S16S32_Sfs(const OMX_S16 *pSrc, OMX_S32 *pDst,
    const OMXFFTSpec_R_S16S32 *pFFTSpec, OMX_INT scaleFactor);

```

```

OMXResult omxSP_FFTFwd_RTCCS_S32_Sfs (const OMX_S32 *pSrc, OMX_S32 *pDst,
    const OMXFFTSpec_R_S32 *pFFTSpec, OMX_INT scaleFactor);

```

#### Description

These functions compute an FFT for a real-valued signal of length of  $2^{order}$ , where  $0 \leq order \leq 12$ . Transform length is determined by the specification structure, which must be initialized prior to calling the FFT function using the appropriate helper, i.e., <FFTInit\_R\_S16S32> or <FFTInit\_R\_S32>. The relationship between the input and output sequences can be expressed in terms of the DFT, i.e.,:

$$x[n] = \frac{2^{-scaleFactor}}{N} \cdot \sum_{k=0}^{N-1} X[k] \cdot e^{j\frac{2\pi}{N}nk}, n = 0,1,2,\dots,N-1; N = 2^{order}$$

The conjugate-symmetric output sequence is represented using a CCS vector, which is of length N+2, and is organized as follows:



|           |    |   |    |    |    |    |     |                    |                    |                  |     |
|-----------|----|---|----|----|----|----|-----|--------------------|--------------------|------------------|-----|
| Index:    | 0  | 1 | 2  | 3  | 4  | 5  | ... | N-2                | N-1                | N                | N+1 |
| Component | R0 | 0 | R1 | I1 | R2 | I2 | ... | R <sub>N/2-1</sub> | I <sub>N/2-1</sub> | R <sub>N/2</sub> | 0   |

where  $R_n$  and  $I_n$ , respectively, denote the real and imaginary components for FFT bin  $n$ . Bins are numbered from 0 to  $N/2$ , where  $N$  is the FFT length. Bin index 0 corresponds to the DC component, and bin index  $N/2$  corresponds to the foldover frequency.

### Input Arguments

- `pSrc` – pointer to the real-valued input sequence, of length  $2^{order}$ ; must be aligned on a 32-byte boundary.
- `pFFTSpec` – pointer to the preallocated and initialized specification structure
- `scaleFactor` – output scale factor; valid range is [0, 32]

### Output Arguments

- `pDst` – pointer to output sequence, represented using CCS format, of length  $2^{order}+2$ ; must be aligned on a 32-byte boundary.

### Return

- `OMX_Sts_NoErr` – no error
- `OMX_Sts_BadArgErr` – bad arguments

The function returns `OMX_Sts_BadArgErr` if one or more of the following is true:

- one of the pointers `pSrc`, `pDst`, or `pFFTSpec` is `NULL`
- `pSrc` or `pDst` is not aligned on a 32-byte boundary
- `scaleFactor < 0` or `scaleFactor > 32`

#### 2.2.4.4.3 FFTInv\_CCSToR\_S32S16\_Sfs

#### 2.2.4.4.4 FFTInv\_CCSToR\_S32\_Sfs

### Prototype

```
OMXResult omxSP_FFTInv_CCSToR_S32S16_Sfs(const OMX_S32 *pSrc, OMX_S16 *pDst,
    const OMXFFTSpec_R_S16S32 *pFFTSpec, OMX_INT scaleFactor);
```

```
OMXResult omxSP_FFTInv_CCSToR_S32_Sfs (const OMX_S32 *pSrc, OMX_S32 *pDst,
    const OMXFFTSpec_R_S32 *pFFTSpec, OMX_INT scaleFactor);
```

### Description

These functions compute the inverse FFT for a conjugate-symmetric input sequence. Transform length is determined by the specification structure, which must be initialized prior to calling the FFT function using either `<FFTInit_R_S16S32>` or `<FFTInit_R_S32>`. For a transform of length  $M$ , the input sequence is represented using a packed CCS vector of length  $M+2$ , and is organized as follows:

|        |   |   |   |   |   |   |     |     |     |   |     |
|--------|---|---|---|---|---|---|-----|-----|-----|---|-----|
| Index: | 0 | 1 | 2 | 3 | 4 | 5 | ... | M-2 | M-1 | M | M+1 |
|--------|---|---|---|---|---|---|-----|-----|-----|---|-----|

Component    R0 0    R1 I1    R2 I2    ...    R<sub>M/2-1</sub> I<sub>M/2-1</sub>    R<sub>M/2</sub> 0

where R<sub>n</sub> and I<sub>n</sub>, respectively, denote the real and imaginary components for FFT bin n. Bins are numbered from 0 to M/2, where M is the FFT length. Bin index 0 corresponds to the DC component, and bin index M/2 corresponds to the foldover frequency.

### Input Arguments

- pSrc – pointer to the complex-valued input sequence represented using CCS format, of length  $2^{order} + 2$ ; must be aligned on a 32-byte boundary.
- pFFTSpec – pointer to the preallocated and initialized specification structure
- scaleFactor – output scalefactor; range is [0,32] for the function <omxSP\_FFTInv\_CCSToR\_S32\_Sfs>, and [0,16] for the function <omxSP\_FFTInv\_CCSToR\_S32S16\_Sfs>

### Output Arguments

- pDst – pointer to the real-valued output sequence, of length  $2^{order}$ ; must be aligned on a 32-byte boundary.

### Return

- OMX\_Sts\_NoErr – no error
- OMX\_Sts\_BadArgErr – bad arguments

The function returns OMX\_Sts\_BadArgErr if one or more of the following is true:

- pSrc, pDst, or pFFTSpec is NULL
- pSrc or pDst is not aligned on a 32-byte boundary
- scaleFactor < 0 or scaleFactor > 16 for <omxSP\_FFTInv\_CCSToR\_S32S16\_Sfs>
- scaleFactor < 0 or scaleFactor > 32 for <omxSP\_FFTInv\_CCSToR\_S32\_Sfs>

## 2.2.4.5 Example, FFT for Real-Valued Signals

### Example 2-5: Real-Valued FFT Usage

```
#include <stdio.h>
#include <stdlib.h>
#include <time.h>
#include "OMXSP.h"

OMXResult FFT_rtoccs_example();

OMX_INT main()
{
    FFT_rtoccs_example();
}
```

```

}

OMXResult FFT_rtoccs_example()
{
    OMX_S16 x[8];
    OMX_S32 y[10];
    OMX_S16 z[8];
    OMX_INT n, bufSize;
    OMXResult status;
    OMXFFTSpec_R_S16S32 * pFwdSpec = NULL;
    OMXFFTSpec_R_S16S32 * pInvSpec = NULL;

    srand( (unsigned)time( NULL ) );

    for(n=0; n<8; n++) {
        x[n] = (OMX_S32)((rand()%1024)-512);
    }

    status = omxSP_FFTGetBufSize_R_S16S32( 3, &bufSize);
    pFwdSpec = (OMXFFTSpec_R_S16S32 *)malloc(bufSize);
    pInvSpec = (OMXFFTSpec_R_S16S32 *)malloc(bufSize);
    status = omxSP_FFTInit_R_S16S32( pFwdSpec, 3 );
    status = omxSP_FFTInit_R_S16S32( pInvSpec, 3 );
    status = omxSP_FFTFwd_RTtoCCS_S16S32_Sfs ( x, y, pFwdSpec, 0 );
    status = omxSP_FFTInv_CCSToR_S32S16_Sfs ( y, z, pInvSpec, 0 );

    printf("FFT Input\n");
    printf("n\tx[n]\n");
    for(n=0; n<7; n++) {
        printf("%d\t%d",n,x[n]);
    }

    printf("FFT Output / IFFT Input\n");
    printf("n\ty.re[n]\ty.im[n]\n");
    for(n=0; n<=4; n++) {
        printf("%d\t%d\t%d\n",n,y[2*n],y[2*n+1]);
    }
    printf("IFFT Output\n");
    printf("n\tz[n]\n");

```

```
for(n=0; n<7; n++) {  
    printf("%d\t%d",n,z[n]);  
}  
  
free( pFwdSpec );  
free( pInvSpec );  
return status;  
}
```

# 3.0 Audio Coding



This section describes the functions and data types that comprise the OpenMAX DL audio coding domain (omxAC) API, including functions that can be used to construct the MPEG-1/MPEG-2 layer 3 decoders (“MP3”), the “MPEG-2.5” decoder (omxACMP3 sub-domain), as well as functions that can be used to construct MPEG-2/MPEG-4 AAC-LC/LTP decoders (omxACAAC sub-domain).

## 3.1 MP3 Decoder Sub-Domain (omxACMP3)

### 3.1.1 Constants

**Table 3-1: MP3 Macro and Constant Definitions**

| Global Macro's Name         | Definition | Notes                                   |
|-----------------------------|------------|---|
| OMX_MP3_GRANULE_LEN         | 576        | The number of samples in one granule    |
| OMX_MP3_SF_BUF_LEN          | 40         | Scalefactor buffer length (8-bit words) |
| OMX_MP3_V_BUF_LEN           | 512        | V data buffer length (32-bit words)     |
| OMX_MP3_SFB_TABLE_LONG_LEN  | 138        |   |
| OMX_MP3_SFB_TABLE_SHORT_LEN | 84         |   |
| OMX_MP3_SFB_MBP_TABLE_LEN   | 12         |   |

## 3.1.2 Data Structures

### 3.1.2.1 Frame Header

```
typedef struct {
    OMX_INT idEx;
    OMX_INT id;                /** idEx/id 1/1: MPEG-1, idEx/id: 1/0
    * MPEG-2, idEx/id: 0/0    MPEG-2.5
    */

    OMX_INT layer;            /** layer index 0x3: Layer I
    *          0x2: Layer II
    *          0x1: Layer III
    */

    OMX_INT protectionBit;    /** CRC flag 0: CRC on, 1: CRC off */
    OMX_INT bitRate;          /** bit rate index */
    OMX_INT samplingFreq;     /** sampling frequency index */
    OMX_INT paddingBit;      /** padding flag 0: no padding, 1 padding
    */

    OMX_INT privateBit;      /** private_bit, no use */
    OMX_INT mode;            /** mono/stereo select information */
    OMX_INT modeExt;         /** extension to mode */
    OMX_INT copyright;       /** copyright or not, 0: no, 1: yes */
    OMX_INT originalCopy;    /** original bitstream or copy, 0: copy, 1:
    original */

    OMX_INT emphasis;        /** flag indicates the type of de-emphasis
    that shall be used */

    OMX_INT CRCWord;         /** CRC-check word */

} OMXMP3FrameHeader;
```

### 3.1.2.2 Side Information

```
typedef struct {
    OMX_INT part23Len;        /** number of main_data bits */
    OMX_INT bigVals;         /** half the number of values in the
    "bigvalues" section, regions 0-2, i.e.,
    half the number of Huffman code words
    whose maximum amplitudes may exceed 1. */
}
```

```

OMX_INT  globGain;          /* quantizer step size */
OMX_INT  sfCompress;       /* number of bits used for scale factors */
OMX_INT  winSwitch;       /* window switching flag */
OMX_INT  blockType;       /* block type flag */
OMX_INT  mixedBlock;      /* flag 0: non-mixed block, 1: mixed block */
OMX_INT  pTableSelect[3]; /* Huffman table indices for each of the 3
                           <big_values> regions: region0, region1, and
                           region2. */

OMX_INT  pSubBlkGain[3];  /* gain offset from the global gain for one
                           subblock */

OMX_INT  reg0Cnt;         /* the number of scale factor bands in the
                           first <big_values> region less one */

OMX_INT  reg1Cnt;         /* the number of scale factor bands in the
                           second <big_values> region less one */

OMX_INT  preFlag;        /* flag indicating high frequency boost */
OMX_INT  sfScale;        /* scalefactor scaling */
OMX_INT  cnt1TabSel;     /* Huffman table index for the <count1>
                           quadruples */

} OMXMP3SideInfo;

```

### 3.1.2.3 Long Block Scalefactor Band Table

The long block scalefactor band table specifies SFB boundaries in terms of spectral samples for six unique SFB partitions. Each SFB partition clusters the 576 long-block spectral samples into a set of 22 SFBs. The Huffman decoder and requantization primitives select one of six SFB partitions from the table as a function of the MP3 header ID bit field and the MP3 header sample rate index. The six SFB partitions are stored contiguously as follows: (id==0 && samplingFreq==0), (id==0 && samplingFreq==1), (id==0 && samplingFreq==2); (id==1 && samplingFreq==0), (id==1 && samplingFreq==1), and (id==1 && samplingFreq==2). Within each partition, the N<sup>th</sup> entry specifies simultaneously the lower bound for the N<sup>th</sup> SFB and the upper bound +1 for SFB N-1. The final entry on each partition specifies the upper bound for SFB 21.

The long block scalefactor band (SFB) table data structure is defined as

```

#define OMX_MP3_SFB_TABLE_LONG_LEN 138
typedef const OMX_S16
    OMXMP3ScaleFactorBandTableLong[OMX_MP3_SFB_TABLE_LONG_LEN];

```

Entries for the SFB data structure representing each SFB partition are defined in Table 3-2. In the table, the column labels “ID0”/”ID1” denote MP3 header field id==0/id==1, and the column labels “R0/R1/R2” denote MP3 header field samplingFreq==0/samplingFreq==1/samplingFreq==2. The “Index” column entries indicate the array index, and the SFB labels indicate which SFB bound is defined by the corresponding table entry. The last SFB entry (SFB21H) in each partition signifies the upper bound for SFB 21.

**Table 3-2: Long Block Scalefactor Band Table Organization**

| Bounds |         | Bounds |         | Bounds |         | Bounds |         | Bounds |         | Bounds |         |
|--------|---------|--------|---------|--------|---------|--------|---------|--------|---------|--------|---------|
| Index  | ID0/R0  | Index  | ID0/R1  | Index  | ID0/R2  | Index  | ID1/R0  | Index  | ID1/R1  | Index  | ID1/R2  |
| 0      | SFB 0   | 23     | SFB 0   | 46     | SFB 0   | 69     | SFB 0   | 92     | SFB 0   | 115    | SFB 0   |
| 1      | SFB 1   | 24     | SFB 1   | 47     | SFB 1   | 70     | SFB 1   | 93     | SFB 1   | 116    | SFB 1   |
| 2      | SFB 2   | 25     | SFB 2   | 48     | SFB 2   | 71     | SFB 2   | 94     | SFB 2   | 117    | SFB 2   |
| 3      | SFB 3   | 26     | SFB 3   | 49     | SFB 3   | 72     | SFB 3   | 95     | SFB 3   | 118    | SFB 3   |
| .      | .       | .      | .       | .      | .       | .      | .       | .      | .       | .      | .       |
| .      | .       | .      | .       | .      | .       | .      | .       | .      | .       | .      | .       |
| .      | .       | .      | .       | .      | .       | .      | .       | .      | .       | .      | .       |
| 19     | SFB 19  | 42     | SFB 19  | 65     | SFB 19  | 88     | SFB 19  | 111    | SFB 19  | 134    | SFB 19  |
| 20     | SFB 20  | 43     | SFB 20  | 66     | SFB 20  | 89     | SFB 20  | 112    | SFB 20  | 135    | SFB 20  |
| 21     | SFB 21L | 44     | SFB 21L | 67     | SFB 21L | 90     | SFB 21L | 113    | SFB 21L | 136    | SFB 21L |
| 22     | SFB 21H | 45     | SFB 21H | 68     | SFB 21H | 91     | SFB 21H | 114    | SFB 21H | 137    | SFB 21H |

**Example 3-1: Long Block Scalefactor Band Table**

An example long block SFB table is given below. The table entries correspond to the standard SFB partitions given in [ISO11172-3] and [ISO13818-3].

```

OMXMP3ScaleFactorBandTableLong SFBTableLongBlockExample =
{
    /* MPEG-2 (id==0) */
    /* 22.050 kHz (samplingFreq==0) */
    0,6,12,18,24,30,36,44,54,66,80,96,
    116,140,168,200,238,284,336,396,464,522,576,
    /* MPEG-2 (id==0) */
    /* 24 kHz (samplingFreq==1) */
    0,6,12,18,24,30,36,44,54,66,80,96,
    114,136,162,194,232,278,332,394,464,540,576,
    /* MPEG-2 (id==0) */
    /* 16 kHz (samplingFreq==2) */
    0,6,12,18,24,30,36,44,54,66,80,96,
    116,140,168,200,238,284,336,396,464,522,576,
    /* MPEG-1 (id==1) */
    /* 44.1 kHz (samplingFreq==0) */
    0,4,8,12,16,20,24,30,36,44,52,62,
    74,90,110,134,162,196,238,288,342,418,576,
    /* MPEG-1 (id==1) */
    /* 48 kHz (samplingFreq==1) */
    0,4,8,12,16,20,24,30,36,42,50,60,
    72,88,106,128,156,190,230,276,330,384,576,
    /* MPEG-1 (id==1) */
    /* 32 kHz (samplingFreq==2) */
    0,4,8,12,16,20,24,30,36,44,54,66,82,
    102,126,156,194,240,296,364,448,550,576
};

```



### 3.1.2.4 Short Block Scalefactor Band Table

The short block scalefactor band table specifies SFB boundaries in terms of spectral samples for six unique SFB partitions. Each SFB partition clusters the 576 long-block spectral samples into a set of 13 SFBs. The Huffman decoder and requantization primitives select one of six SFB partitions from the table as a function of the MP3 header ID bit field and the MP3 header sample rate index. The six SFB partitions are stored contiguously as follows: (id==0 && samplingFreq==0), (id==0 && samplingFreq==1), (id==0 && samplingFreq==2); (id==1 && samplingFreq==0), (id==1 && samplingFreq==1), and (id==1 && samplingFreq==2). Within each partition, the N<sup>th</sup> entry specifies simultaneously the lower bound for the N<sup>th</sup> SFB and the upper bound +1 for SFB N-1. The final entry on each partition specifies the upper bound for SFB 12.

The short block scalefactor band (SFB) table data structure is defined as

```
#define OMX_MP3_SFB_TABLE_SHORT_LEN    84
typedef const OMX_S16
OMXMP3ScaleFactorBandTableShort[OMX_MP3_SFB_TABLE_SHORT_LEN];
```

Entries for the SFB data structure representing each SFB partition are defined in Table 3-3. In the table, the column labels “ID0”/”ID1” denote MP3 header field id==0/id==1, and the column labels “R0/R1/R2” denote MP3 header field samplingFreq==0/samplingFreq==1/samplingFreq==2. The “Index” column entries indicate the array index, and the SFB labels indicate which SFB bound is defined by the corresponding table entry. The last SFB entry (SFB12H) in each partition signifies the upper bound for SFB 12.

**Table 3-3: Short Block Scalefactor Band Table Organization**

| Bounds |        | Bounds |        | Bounds |        | Bounds |        | Bounds |        | Bounds |        |
|--------|--------|--------|--------|--------|--------|--------|--------|--------|--------|--------|--------|
| Index  | ID0/R0 | Index  | ID0/R1 | Index  | ID0/R2 | Index  | ID1/R0 | Index  | ID1/R1 | Index  | ID1/R2 |
| 0      | SFB 0  | 14     | SFB 0  | 28     | SFB 0  | 42     | SFB 0  | 56     | SFB 0  | 70     | SFB 0  |
| 1      | SFB 1  | 15     | SFB 1  | 29     | SFB 1  | 43     | SFB 1  | 57     | SFB 1  | 71     | SFB 1  |
| 2      | SFB 2  | 16     | SFB 2  | 30     | SFB 2  | 44     | SFB 2  | 58     | SFB 2  | 72     | SFB 2  |
| 3      | SFB 3  | 17     | SFB 3  | 31     | SFB 3  | 45     | SFB 3  | 59     | SFB 3  | 73     | SFB 3  |
| .      | .      | .      | .      | .      | .      | .      | .      | .      | .      | .      | .      |
| .      | .      | .      | .      | .      | .      | .      | .      | .      | .      | .      | .      |
| .      | .      | .      | .      | .      | .      | .      | .      | .      | .      | .      | .      |
| 10     | SFB10  | 24     | SFB10  | 38     | SFB10  | 52     | SFB10  | 66     | SFB10  | 80     | SFB10  |
| 11     | SFB11  | 25     | SFB11  | 39     | SFB11  | 53     | SFB11  | 67     | SFB11  | 81     | SFB11  |
| 12     | SFB12L | 26     | SFB12L | 40     | SFB12L | 54     | SFB12L | 68     | SFB12L | 82     | SFB12L |
| 13     | SFB12H | 27     | SFB12H | 41     | SFB12H | 55     | SFB12H | 69     | SFB12H | 83     | SFB12H |

### Example 3-2: Short Block Scalefactor Band Table

An example short block table is given below. The table entries correspond to the standard SFB partitions given in [ISO11172-3] and [ISO13818-3].

```
OMXMP3ScaleFactorBandTableShort SFBTableShortBlockExample =
{
    /* MPEG-2 (id==0) */
    /* 22.050 kHz (samplingFreq==0) */
    0,4,8,12,18,24,32,
    42,56,74,100,132,174,192,
    /* MPEG-2 (id==0) */
    /* 24 kHz (samplingFreq==1) */
    0,4,8,12,18,26,36,
    48,62,80,104,136,180,192,
    /* MPEG-2 (id==0) */
    /* 16 kHz (samplingFreq==2) */
    0,4,8,12,18,26,36,
    48,62,80,104,134,174,192,
    /* MPEG-1 (id==1) */
    /* 44.1 kHz (samplingFreq==0) */
    0,4,8,12,16,22,30,
    40,52,66,84,106,136,192,
    /* MPEG-1 (id==1) */
    /* 48 kHz (samplingFreq==1) */
    0,4,8,12,16,22,28,
    38,50,64,80,100,126,192,
    /* MPEG-1 (id==1) */
    /* 32 kHz (samplingFreq==2) */
    0,4,8,12,16,22,30,
    42,58,78,104,138,180,192
};
```

#### 3.1.2.5 Scalefactor Band Mixed Block Partition Table

The SFB mixed block partition (MBP) table informs the Huffman decoder of how many SFBs to count in region\_0 using the long block boundaries versus how many SFBs to count using short block boundaries. This table is used by the Huffman decoder to compute region\_0 length in mixed-block mode (mixedBlock==1).

The SFB MBP data structure is defined as

```
#define OMX_MP3_SFB_MBP_TABLE_LEN 12
typedef const OMX_S16 OMXMP3MixedBlockPartitionTable
    [OMX_MP3_SFB_MBP_TABLE_LEN];
```

The MBP table entries are organized into pairs as shown in Table 3-4. When a mixed block frame is encountered (mixedBlock==1), the Huffman decoder reads from the MBP table the “L” and “S” pair (“Mode” column) corresponding to values of samplingFreq (“Rate” column) and id (“id” column)

fields associated with the current frame header. Then, the Huffman decoder counts SFBs for region\_0 using long block SFB boundaries for the number of SFBs indicated by the “L” entry, and counts SFBs for region\_0 using short block boundaries on the number of SFBs indicated by the “S” entry.

**Table 3-4: Scalefactor Band Mixed Block Partition Table Organization**

| Index | Mode | Rate | ID |
|-------|------|------|----|
| 0     | L    | 0    | 0  |
| 1     | S    |      |    |
| 2     | L    | 1    |    |
| 3     | S    |      |    |
| 4     | L    | 2    |    |
| 5     | S    |      |    |
| 6     | L    | 0    | 1  |
| 7     | S    |      |    |
| 8     | L    | 1    |    |
| 9     | S    |      |    |
| 10    | L    | 2    |    |
| 11    | S    |      |    |

**Example 3-3: Scalefactor Band Mixed-Block Partition Table**

An example MBP table is given below. For mixed block frames in this example, the Huffman decoder will determine region\_0 length by counting six SFBs using six long-block SFB boundaries and two SFBs using short block boundaries whenever id==0 (MPEG-2 @ 16/22.050/24 kHz). On the other hand whenever id==1 (MPEG-1 @ 16/22.050/24 kHz) region\_0 length will be determined by counting eight SFBs using long-block boundaries.

```
OMXMP3MixedBlockPartitionTable mbpTableExample =
{
    /* MPEG-2 (id==0) */
    /* 22.050 kHz (samplingFreq==0) */
    /* Long block SFBs          Short block SFBs */
        6,                          2,
    /* MPEG-2 (id==0) */
    /* 24 kHz (samplingFreq==1) */
    /* Long block SFBs          Short block SFBs */
        6,                          2,
    /* MPEG-2 (id==0) */
    /* 16 kHz (samplingFreq==2) */
    /* Long block SFBs          Short block SFBs */
        6,                          2,
    /* MPEG-1 (id==1) */
    /* 44.1 kHz (samplingFreq==0) */
    /* Long block SFBs          Short block SFBs */

```

```

        8,                                0,
/* MPEG-1 (id==1) */
/* 48 kHz (samplingFreq==1) */
/* Long block SFBS          Short block SFBS */
        8,                                0,
/* MPEG-1 (id==1) */
/* 32 kHz (samplingFreq==2) */
/* Long block SFBS          Short block SFBS */
        8,                                0
};

```

### 3.1.2.6 Buffer Conventions

#### 3.1.2.6.1 Bitstream Buffers

In omxAC, bitstreams are represented using two parameters, namely, a double pointer to the stream buffer, **\*\*ppBitStream**, and a pointer to the next available bit in the stream, **\*pBitOffset**. Unless otherwise specified in the description for a particular function, the standard conventions that are observed for stream buffers and buffer pointer maintenance are as follows:

- The parameter **\*\*ppBitStream** points to the current byte in the stream upon function entry, and is updated by the function such that it references the current byte in the stream upon function exit.
- The parameter **\*pBitOffset** points to the next available bit in the stream upon function entry, and is updated by the function such that it points to the next available bit in the stream upon function exit. **\*pBitOffset** is valid in the range 0 to 7. The value 0 corresponds the most significant bit cell, and the value 7 corresponds to the least significant bit cell, i.e.,

|                           |      |   |   |   |   |   |   |       |
|---------------------------|------|---|---|---|---|---|---|-------|
| Bit Position in one byte: | Most |   |   |   |   |   |   | Least |
| <b>*pBitOffset</b>        | 0    | 1 | 2 | 3 | 4 | 5 | 6 | 7     |

- Stream buffer space is allocated outside of the function and is maintained by the DL user, client, or application.
- It is recommended in all cases that eight additional padding bytes beyond the minimum required buffer size be allocated to a stream buffer in order to protect against data aborts under exception conditions.
- If an error occurs during bitstream processing, the values referenced by the parameters **\*\*ppBitStream** and **\*pBitOffset** shall be undefined upon return. The calling application may maintain a local copy of these parameters for the purposes of error exception handling, but it is not required to do so.

## 3.1.3 Functions

### 3.1.3.1 Bitstream Unpacking

#### 3.1.3.1.1 UnpackFrameHeader

##### Prototype

```
OMXResult omxACMP3_UnpackFrameHeader (const OMX_U8 **ppBitStream,  
    OMXMP3FrameHeader *pFrameHeader);
```

##### Description

Unpacks the audio frame header. If CRC is enabled, this function also unpacks the CRC word. Before calling `omxACMP3_UnpackFrameHeader`, the decoder application should locate the bit stream sync word and ensure that `*ppBitStream` points to the first byte of the 32-bit frame header. If CRC is enabled, it is assumed that the 16-bit CRC word is adjacent to the 32-bit frame header, as defined in the MP3 standard. Before returning to the caller, the function updates the pointer `*ppBitStream`, such that it references the next byte after the frame header or the CRC word. The first byte of the 16-bit CRC word is stored in `pFrameHeader->CRCWord[15:8]`, and the second byte is stored in `pFrameHeader->CRCWord[7:0]`. The function does not detect corrupted frame headers.

##### Reference

[ISO13818-3], sub-clause 2.4.2.3

##### Input Arguments

- `ppBitStream` – double pointer to the first byte of the MP3 frame header

##### Output Arguments

- `pFrameHeader` – pointer to the MP3 frame header structure (defined in section “Data Structures”)
- `ppBitStream` – double pointer to the byte immediately following the frame header

##### Returns

- `OMX_Sts_NoErr` – no error
- `OMX_Sts_BadArgErr` – invalid arguments – either `ppBitStream`, `pFrameHeader`, or `*ppBitStream` is NULL

#### 3.1.3.1.2 UnpackSideInfo

##### Prototype

```
OMXResult omxACMP3_UnpackSideInfo (const OMX_U8 **ppBitStream,  
    OMXMP3SideInfo *pDstSideInfo, OMX_INT *pDstMainDataBegin, OMX_INT  
    *pDstPrivateBits, OMX_INT *pDstScfsi, OMXMP3FrameHeader *pFrameHeader);
```

## Description

Unpacks the side information from the input bit stream. Before `omxACMP3_UnpackSideInfo` is called, the pointer `*ppBitStream` must point to the first byte of the bit stream that contains the side information associated with the current frame. Before returning to the caller, the function updates the pointer `*ppBitStream` such that it references the next byte after the side information.

## References

1. [ISO13818-3], sub-clause 2.4.1.7
2. [ISO11172-3], sub-clauses 2.4.2.7 and 2.4.3.4.10.3

## Input Arguments

- `ppBitStream` – double pointer to the first byte of the side information associated with the current frame in the bit stream buffer
- `pFrameHeader` – pointer to the structure that contains the unpacked MP3 frame header. The header structure provides format information about the input bit stream. Both single- and dual-channel MPEG-1 and MPEG-2 modes are supported.

## Output Arguments

- `pDstSideInfo` – array of pointers to the MP3 side information structure(s). The structure(s) contain(s) side information that applies to all granules and all channels for the current frame. Depending on the number of channels and granules associated with the current frame, one or more of the structures are placed contiguously in the buffer pointed to by `pDstSideInfo` in the following order: { granule 0 (channel 0, channel 1), granule 1 (channel 0, channel 1) }.
- `pDstMainDataBegin` – pointer to the `main_data_begin` field
- `pDstPrivateBits` – pointer to the `private_bits` field
- `pDstScfsi` – pointer to the scalefactor selection information associated with the current frame, organized contiguously in the buffer pointed to by `pDstScfsi` in the following order: {channel 0 (scfsi\_band 0, scfsi\_band 1, ..., scfsi\_band 3), channel 1 (scfsi\_band 0, scfsi\_band 1, ..., scfsi\_band 3)}.
- `ppBitStream` – double pointer to the bit stream buffer byte immediately following the side information for the current frame

## Returns

- `OMX_Sts_NoErr` – no error
- `OMX_Sts_BadArgErr` – bad argument; at least one of the following pointers is NULL:
  - `ppBitStream`
  - `pDstSideInfo`
  - `pDstMainDataBegin`
  - `pDstPrivateBits`
  - `pDstScfsi`
  - `pFrameHeader`
  - `*ppBitStream`

- `OMX_Sts_Err` – one or more elements of the MP3 frame header structure is invalid, i.e., one or more of the following conditions is true:

- `pFrameHeader->id` exceeds `[0,1]`;
- `pFrameHeader->layer!=1`
- `pFrameHeader->mode` exceeds `[0,3]`
- `pDstSideInfo[]->blockType==0` (“normal”) and `pDstSideInfo[]->winSwitch==1` (“set”).

### 3.1.3.1.3 UnpackScaleFactors\_S8

#### Prototype

```
OMXResult omxACMP3_UnpackScaleFactors_S8 (const OMX_U8 **ppBitStream,
    OMX_INT *pOffset, OMX_S8 *pDstScaleFactor, OMXMP3SideInfo *pSideInfo,
    OMX_INT *pScfsi, OMXMP3FrameHeader *pFrameHeader, OMX_INT granule,
    OMX_INT channel);
```

#### Description

Unpacks short and/or long block scalefactors for one granule of one channel and places the results in the vector `pDstScaleFactor`. Special scalefactor values on the right channel of intensity-coded scalefactor bands are returned to indicate illegal intensity positions. Before returning to the caller, the function updates `*ppBitStream` and `*pOffset` such that they point to the next available bit in the input bit stream.

#### Reference

[ISO13818-3], sub-clause 2.4.1.7

#### Input Arguments

- `ppBitStream` – double pointer to the first bit stream buffer byte that is associated with the scalefactors for the current frame, granule, and channel
- `pOffset` – pointer to the next bit in the byte referenced by `*ppBitStream`. Valid within the range of 0 to 7, where 0 corresponds to the most significant bit and 7 corresponds to the least significant bit.
- `pSideInfo` – pointer to the MP3 side information structure associated with the current granule and channel
- `pScfsi` – pointer to scalefactor selection information for the current channel
- `channel` – channel index; can take on the values of either 0 or 1
- `granule` – granule index; can take on the values of either 0 or 1
- `pFrameHeader` – pointer to MP3 frame header structure for the current frame

## Output Arguments

- `pDstScaleFactor` – pointer to the scalefactor vector for long and/or short blocks. Special scalefactor values on the right channel of intensity-coded scalefactor bands shall be used to indicate illegal intensity positions as follows: i) for MPEG-1 streams (`pFrameHeader->id==1`), the value 7 [ISO11172-3, section 2.4.3.4.9.3], and ii) for MPEG-2 streams (`pFrameHeader->id==0`), a negative value.
- `ppBitStream` – updated double pointer to the next bit stream byte
- `pOffset` – updated pointer to the next bit in the bit stream (indexes the bits of the byte pointed to by `*ppBitStream`). Valid within the range of 0 to 7, where 0 corresponds to the most significant bit and 7 corresponds to the least significant bit.

## Returns

- `OMX_Sts_NoErr` – no error
- `OMX_Sts_BadArgErr` – Bad arguments; one or more of the following pointers is NULL:

- `*ppBitStream`
- `pOffset`
- `pDstScaleFactor`
- `pSideInfo, pScfsi`
- `ppBitStream`
- `pFrameHeader`

Bad arguments are also flagged when the value of `*pOffset` exceeds [0,7] or the granule or channel indices have values other than 0 or 1.

- `OMX_Sts_Err` – input data errors detected; one or more of the following are true:
  - `pFrameHeader->id` exceeds [0,1],
  - `pSideInfo->blockType` exceeds [0,3],
  - `pSideInfo->mixedBlock` exceeds [0,1] when `pFrameHeader->id==1`, `pSideInfo->blockType==2`, and `pSideInfo->winSwitch==1`.
  - `pScfsi[0..3]` exceeds [0,1] when `pFrameHeader->id==1` and either `pSideInfo->blockType!=2` or `pSideInfo->winSwitch!=1`.
  - `pFrameHeader->id` indicates that the bit stream is MPEG-1 and `pSideInfo->sfCompress` exceeds [0,15]
  - `pFrameHeader->id` indicates the bit stream is MPEG-2 and `pSideInfo->sfCompress` exceeds [0,511]
  - `pFrameHeader->modeExt` exceeds [0, 3]



## 3.1.3.2 Huffman Decoding

### 3.1.3.2.1 HuffmanDecode\_S32

### 3.1.3.2.2 HuffmanDecodeSfb\_S32

### 3.1.3.2.3 HuffmanDecodeSfbMbp\_S32

#### Prototype

```
OMXResult omxACMP3_HuffmanDecode_S32 (const OMX_U8 **ppBitStream, OMX_INT
    *pOffset, OMX_S32 *pDstIs, OMX_INT *pDstNonZeroBound, OMXMP3SideInfo
    *pSideInfo, OMXMP3FrameHeader *pFrameHeader, OMX_INT hufSize);

OMXResult omxACMP3_HuffmanDecodeSfb_S32(const OMX_U8 **ppBitStream, OMX_INT
    *pOffset, OMX_S32 *pDstIs, OMX_INT *pDstNonZeroBound, OMXMP3SideInfo
    *pSideInfo, OMXMP3FrameHeader *pFrameHeader, OMX_INT hufSize,
    OMXMP3ScaleFactorBandTableLong pSfbTableLong);

OMXResult omxACMP3_HuffmanDecodeSfbMbp_S32(const OMX_U8 **ppBitStream,
    OMX_INT *pOffset, OMX_S32 *pDstIs, OMX_INT *pDstNonZeroBound,
    OMXMP3SideInfo *pSideInfo, OMXMP3FrameHeader *pFrameHeader, OMX_INT
    hufSize, OMXMP3ScaleFactorBandTableLong pSfbTableLong,
    OMXMP3ScaleFactorBandTableShort pSfbTableShort,
    OMXMP3MixedBlockPartitionTable pMbpTable);
```

#### Description

Decodes Huffman symbols for the 576 spectral coefficients associated with one granule of one channel.

#### References

1. [ISO11172-3], Table B.8 (“MPEG-1”)
2. [ISO13818-3], sub-clause 2.5.2.8 and Table B.2 (“MPEG-2”)
3. [ISO14496-3], sub-part 9, “MPEG-1/2 Audio in MPEG-4”

#### Input Arguments

- `ppBitStream` – double pointer to the first bit stream byte that contains the Huffman code words associated with the current granule and channel
- `pOffset` – pointer to the starting bit position in the bit stream byte pointed by `*ppBitStream`; valid within the range of 0 to 7, where 0 corresponds to the most significant bit, and 7 corresponds to the least significant bit
- `pSideInfo` – pointer to MP3 structure that contains the side information associated with the current granule and channel
- `pFrameHeader` – pointer to MP3 structure that contains the header associated with the current frame
- `hufSize` – the number of Huffman code bits associated with the current granule and channel

- `pSfbTableLong` – pointer to the long block scalefactor band table, formatted as described in section 3.1.2.3. Table entries optionally may follow the MPEG-1, MPEG-2, or MPEG-4 audio standards as shown in Example 3-1. Alternatively the table entries may be defined to suit a special purpose. References: [ISO11172-3], Table B.8, [ISO13818-3], Table B.2, [ISO14496-3], sub-part 9.
- `pSfbTableShort` – pointer to the short block scalefactor band table, formatted as described in section 3.1.2.4. Table entries optionally may follow the MPEG-1, MPEG-2, or MPEG-4 audio standards as shown in Example 3-2. Alternatively the table entries may be defined to suit a special purpose. References: [ISO11172-3], Table B.8, [ISO13818-3], Table B.2, [ISO14496-3], sub-part 9.
- `pMbpTable` – pointer to the mixed block partitioning table, formatted as described in section 3.1.2.5. Table entries optionally may follow the MPEG-1, MPEG-2, or MPEG-4 audio standards as shown in Example 3-3. Alternatively the table entries may be defined to suit a special purpose. References: [ISO11172-3], Table B.8, [ISO13818-3], Table B.2, [ISO14496-3], sub-part 9.

### Output Arguments

- `pDstIs` – pointer to the vector of decoded Huffman symbols used to compute the quantized values of the 576 spectral coefficients that are associated with the current granule and channel
- `pDstNonZeroBound` – pointer to the spectral region above which all coefficients are set equal to zero
- `ppBitStream` – updated double pointer to the particular byte in the bit stream that contains the first new bit following the decoded block of Huffman codes
- `pOffset` – updated pointer to the next bit position in the byte pointed by `*ppBitStream`; valid within the range of 0 to 7, where 0 corresponds to the most significant bit, and 7 corresponds to the least significant bit

### Returns

- `OMX_Sts_NoErr` – no error
- `OMX_Sts_BadArgErr` – Bad arguments detected;

at least one of the following pointers is NULL:

- `ppBitStream`
- `pOffset`
- `pDstIs`
- `pDstNonZeroBound`
- `pSideInfo`
- `pFrameHeader`
- `pSfbTableLong`
- `*ppBitStream`

Or either of the following two conditions is true:

- `*pOffset < 0`, or `*pOffset > 7`.
- `hufSize < 0` or `hufSize > pSideInfo->part23Len`

Or one or more of the conditions listed in Table 3-5 was detected.

- `OMX_Sts_Err` – indicates that the number of remaining Huffman code bits for `<count1>` partition is less than zero after decoding the `<big_values>` partition.

**Table 3-5:OMX\_Sts\_BadArgErr Conditions for HuffmanDecode/Sfb/SfbMbp\_S32**

| Input Parameter   | Fault Condition   |
|---|---|
| <code>pSideInfo-&gt; bigVals * 2</code>                           | <code>&gt; OMX_MP3_GRANULE_LEN</code>                                 |
| <code>pSideInfo-&gt;bigVals * 2</code>                            | <code>&lt; 0</code>   |
| <code>pSideInfo-&gt;winSwitch</code>                              | outside the range [0,1]   |
| <code>pSideInfo-&gt; blockType</code>                             | outside the range [0,3]   |
| <code>pSideInfo-&gt;blockType</code>                              | <code>pSideInfo -&gt;winSwitch==1 when blockType==0</code>            |
| <code>pSideInfo-&gt;cnt1TabSel</code>                             | outside the range [0,1]   |
| <code>pSideInfo-&gt; reg0Cnt</code>                               | <code>&lt; 0 when pSideInfo-&gt;blockType==0</code>                   |
| <code>pSideInfo-&gt; reg1Cnt</code>                               | <code>&lt; 0 when pSideInfo-&gt;blockType==0</code>                   |
| <code>pSideInfo-&gt; reg0Cnt + pSideInfo -&gt; reg1Cnt + 2</code> | <code>&gt; 22 when pSideInfo-&gt;blockType==0</code>                  |
| <code>pSideInfo-&gt; pTableSelect [0]</code>                      | outside the range [0,31]  |
| <code>pSideInfo-&gt; pTableSelect [1]</code>                      | outside the range [0,31]  |
| <code>pSideInfo-&gt; pTableSelect [2]</code>                      | outside the range [0,31] when <code>pSideInfo-&gt;blockType==0</code> |
| <code>pFrameHeader-&gt; id</code>                                 | outside the range [0,1]   |
| <code>pFrameHeader-&gt; idEX</code>                               | outside the range [0,1]   |
| <code>pFrameHeader-&gt; idEX</code>                               | <code>== 0 when pFrameHeader-&gt;id==1</code>                         |
| <code>pFrameHeader-&gt;layer</code>                               | <code>!=1</code>  |
| <code>pFrameHeader-&gt; samplingFreq</code>                       | outside the range [0,2]   |
| <code>hufSize</code>  | outside the range [0, <code>pSideInfo-&gt; part23Len</code> ]         |

### 3.1.3.3 Inverse Quantization

#### 3.1.3.3.1 ReQuantize\_S32\_I

#### 3.1.3.3.2 ReQuantizeSfb\_S32\_I

##### Prototype

```
OMXResult omxACMP3_ReQuantize_S32_I(OMX_S32 *pSrcDstIsXr, OMX_INT
    *pNonZeroBound, OMX_S8 *pScaleFactor, OMXMP3SideInfo *pSideInfo,
    OMXMP3FrameHeader *pFrameHeader, OMX_S32 *pBuffer);

OMXResult omxACMP3_ReQuantizeSfb_S32_I(OMX_S32 *pSrcDstIsXr, OMX_INT
    *pNonZeroBound, OMX_S8 *pScaleFactor, OMXMP3SideInfo *pSideInfo,
    OMXMP3FrameHeader *pFrameHeader, OMX_S32 *pBuffer,
    OMXMP3ScaleFactorBandTableLong pSfbTableLong,
    OMXMP3ScaleFactorBandTableShort pSfbTableShort);
```

##### Description

Requantizes the decoded Huffman symbols. Spectral samples for the synthesis filter bank are derived from the decoded symbols using the requantization equations given in the ISO standard. Stereophonic mid/side (M/S) and/or intensity decoding is applied if necessary. Requantized spectral samples are returned in the vector `pSrcDstIsXr`. The reordering operation is applied for short blocks. Users must preallocate a workspace buffer pointed to by `pBuffer` prior to calling the requantization function. The value pointed by `pNonZeroBound` will be recalculated according to the output data sequence. Special scalefactor values on the right channel of intensity-coded scalefactor bands are used to indicate illegal intensity positions.

##### References

1. [ISO11172-3], Table B.8 (“MPEG-1”)
2. [ISO13818-3], sub-clause 2.5.3.2.2 and Table B.2 (“MPEG-2”)
3. [ISO14496-3], sub-part 9, “MPEG-1/2 Audio in MPEG-4”

##### Input Arguments

- `pSrcDstIsXr` – pointer to the vector of decoded Huffman symbols; for stereo and dual-channel modes, right channel data begins at the address `&(pSrcDstIsXr[576])`. This pointer must be aligned on an 8-byte boundary.
- `pNonZeroBound` – (Inout/output argument) pointer to the spectral bound above which all coefficients are set to zero; for stereo and dual-channel modes, the left channel bound is `pNonZeroBound[0]`, and the right channel bound is `pNonZeroBound[1]`
- `pScaleFactor` – pointer to the scalefactor buffer; for stereo and dual-channel modes, the right channel scalefactors begin at `&(pScaleFactor[OMX_MP3_SF_BUF_LEN])`. Special scalefactor values on the right channel of intensity-coded scalefactor bands shall be used to indicate an illegal intensity position as follows: i) for MPEG-1 streams (`pFrameHeader->id==1`), the value 7 [ISO11172-3, section 2.4.3.4.9.3], and ii) for MPEG-2 streams (`pFrameHeader->id==0`), a negative value.

- `pSideInfo` – pointer to the side information for the current granule
- `pFrameHeader` – pointer to the frame header for the current frame
- `pBuffer` – pointer to a workspace buffer. The buffer length must be 576 samples, and the pointer must be 8-byte aligned.
- `pSfbTableLong` – pointer to the long block scalefactor band table, formatted as described in section 3.1.2.3. Table entries optionally may follow the MPEG-1, MPEG-2, or MPEG-4 audio standards as shown in Example 3-1. Alternatively the table entries may be defined to suit a special purpose. References: [ISO11172-3], Table B.8, [ISO13818-3], Table B.2, [ISO14496-3], sub-part 9.
- `pSfbTableShort` – pointer to the short block scalefactor band table, formatted as described in section 3.1.2.4. Table entries optionally may follow the MPEG-1, MPEG-2, or MPEG-4 audio standards as shown in Example 3-2. Alternatively the table entries may be defined to suit a special purpose. References: [ISO11172-3], Table B.8, [ISO13818-3], Table B.2, [ISO14496-3], sub-part 9.

### Output Arguments

- `pSrcDstIsXr` – pointer to the vector of requantized spectral samples for the synthesis filter bank, in Q5.26 format (Qm.n defined in “Introduction”). Only the first  $(pNonZeroBound[ch]+17)/18$  18-point blocks are updated by the function. This pointer must be aligned on an 8-byte boundary.
- `pNonZeroBound` – (Input/output argument) pointer to the spectral bound above which all coefficients are set to zero; for stereo and dual-channel modes, the left channel bound is `pNonZeroBound[0]`, and the right channel bound is `pNonZeroBound[1]`.

### Returns

- `OMX_Sts_NoErr` – no errors
- `OMX_Sts_BadArgErr` – bad arguments detected; either `pSrcDstIsXr` or `pBuffer` are not 8-byte aligned, or one or more of the following pointers is NULL: `pSrcDstIsXr`, `pNonZeroBound`, `pScaleFactor`, `pSideInfo`, `pFrameHeader`, or `pBuffer`, or one or more of the input error conditions listed in Table 3-6 is detected.

**Table 3-6: OMX\_Sts\_BadArgErr Conditions for ReQuantize\_S32\_I and ReQuantizeSfb\_S32\_I**

| Input Parameter                             | Fault Condition           |
|---|---------------------------|
| <code>pNonZeroBound[ch]</code>              | outside the range [0,576] |
| <code>pFrameHeader-&gt;id</code>            | outside the range [0,1]   |
| <code>pFrameHeader-&gt; samplingFreq</code> | outside the range [0,2]   |
| <code>pFrameHeader-&gt;mode</code>          | outside the range [0,3]   |
| <code>pSideInfo[ch].blockType</code>        | outside the range [0,3]   |
| <code>pFrameHeader-&gt;modeExt</code>       | outside the range [0,3]   |
| <code>pSideInfo[ch].mixedBlock</code>       | outside the range [0,1]   |
| <code>pSideInfo[ch].globGain</code>         | outside the range [0,255] |
| <code>pSideInfo[ch].sfScale</code>          | outside the range [0,1]   |

| Input Parameter               | Fault Condition   |
|-------------------------------|---|
| pSideInfo [ch].preFlag        | outside the range [0,1]   |
| pSideInfo [ch].pSubBlkGain[w] | outside the range [0,7]   |
| pSrcDstIsXr[i]                | > 8206  |
| pScaleFactor[sfb]             | > 7 when pScaleFactor[sfb] is the intensity position for an MPEG-1 stream                             |
| pSideInfo[ch].blockType       | pSideInfo[0].blockType != pSideInfo[1].blockType and the bit stream is encoded in joint stereo mode   |
| pSideInfo[ch].mixedBlock      | pSideInfo[0].mixedBlock != pSideInfo[1].mixedBlock and the bit stream is encoded in joint stereo mode |

 **Note:** In Table 3-6, the range on the parameter *ch* is from 0 to *chNum*-1, and the range on the parameter *w* is from 0 to 2, where *chNum* is the number of channels associated with value of the *pFrameHeader ->mode*. If *pFrameHeader ->mode* == 3 then *chNum*==1, otherwise *chNum*==2.

### 3.1.3.4 Synthesis Filterbank

#### 3.1.3.4.1 MDCTInv\_S32

##### Prototype

```
OMXResult omxACMP3_MDCTInv_S32 ( OMX_S32 *pSrcXr, OMX_S32 *pDstY, OMX_S32
    *pSrcDstOverlapAdd, OMX_INT nonZeroBound, OMX_INT *pPrevNumOfImdct,
    OMX_INT blockType, OMX_INT mixedBlock);
```

##### Description

Stage 1 of the hybrid synthesis filter bank. This performs the following operations:

- a) Alias reduction
- b) Inverse MDCT according to block size specifiers and mixed block modes
- c) Overlap add of IMDCT outputs, and
- d) Frequency inversion prior to PQMF bank

Because the IMDCT is a lapped transform, the user must preallocate a buffer referenced by *pSrcDstOverlapAdd* to maintain the IMDCT overlap-add state. The buffer must contain 576 elements. Prior to the first call to the synthesis filter bank, all elements of the overlap-add buffer should be set equal to zero. In between all subsequent calls, the contents of the overlap-add buffer should be preserved. Upon

entry to `omxACMP3_MDCTInv_S32`, the overlap-add buffer should contain the IMDCT output generated by operating on the previous granule; upon exit from `omxACMP3_MDCTInv_S32`, the overlap-add buffer will contain the overlapped portion of the output generated by operating on the current granule. Upon return from the function, the IMDCT sub-band output samples are organized as follows:  
`pDstY[ j*32+subband ]`, for `j=0` to `17`; `sub-band=0` to `31`.



**Note:** *The pointers `pSrcXr` (input argument) and `pDstY` (output argument) must reference different buffers.*

---

## Reference

[ISO13818-3], sub-clause 2.5.3.3.2

## Input Arguments

- `pSrcXr` – pointer to the vector of requantized spectral samples for the current channel and granule, represented in Q5.26 format.



**Note:** *The vector buffer is used as a workspace buffer when the input data has been processed. So the data in the buffer is meaningless when exiting the function*

---

- `pSrcDstOverlapAdd` – pointer to the overlap-add buffer; contains the overlapped portion of the previous granule's IMDCT output
- `nonZeroBound` – the bound above which all spectral coefficients are zero for the current granule and channel
- `pPrevNumOfImdct` – pointer to the number of IMDCTs computed for the current channel of the previous granule
- `blockType` – block type indicator
- `mixedBlock` – mixed block indicator

## Output Arguments

- `pDstY` – pointer to the vector of IMDCT outputs in Q7.24 format, for input to PQMF bank
- `pSrcDstOverlapAdd` – pointer to the updated overlap-add buffer; contains overlapped portion of the current granule's IMDCT output
- `pPrevNumOfImdct` – pointer to the number of IMDCTs, for current granule, current channel

## Returns

- `OMX_Sts_NoErr` – no error
- `OMX_Sts_BadArgErr` – bad arguments detected; one or more of the pointers `pSrcXr`, `pDstY`, `pSrcDstOverlapAdd`, and/or `pPrevNumOfImdct` is NULL

- `OMX_Sts_Err` – one or more of the following input data errors detected: either `blockType` exceeds [0,3], `mixedBlock` exceeds [0,1], `nonZeroBound` exceeds [0,576], or `*pPrevNumOfImdct` exceeds [0,32]

### 3.1.3.4.2 SynthPQMF\_S32\_S16

#### Prototype

```
OMXResult omxACMP3_SynthPQMF_S32_S16(OMX_S32 *pSrcY, OMX_S16 *pDstAudioOut,
    OMX_S32 *pVBuffer, OMX_INT *pVPosition, OMX_INT mode);
```

#### Description

Stage 2 of the hybrid synthesis filter bank; a critically-sampled 32-channel PQMF synthesis bank that generates 32 time-domain output samples for each 32-sample input block of IMDCT outputs. For each input block, the PQMF generates an output sequence of 16-bit signed little-endian PCM samples in the vector pointed to by `pDstAudioOut`. If `mode` equals 2, the left and right channel output samples are interleaved (i.e., LRLRLR), such that the left channel data is organized as follows: `pDstAudioOut[2*i]`, `i=0 to 31`. If `mode` equals 1, then the left and right channel outputs are not interleaved. A workspace buffer of size 512 x Number of Channels must be preallocated (`pVBuffer`). This buffer is referenced by the pointer `pVBuffer`, and its elements should be initialized to zero prior to the first call. During subsequent calls, the `pVBuffer` input for the current call should contain the `pVbuffer` output generated by the previous call. The state variable `pVPosition` should be initialized to zero and preserved between calls. The values contained in `pVBuffer` or `pVPosition` should be modified only during decoder reset, and the reset values should always be zero.

#### Reference

[ISO13818-3], sub-clause 2.5.3.3.2

#### Input Arguments

- `pSrcY` – pointer to the block of 32 IMDCT sub-band input samples, in Q7.24 format
- `pVBuffer` – pointer to the input workspace buffer containing Q7.24 data. The elements of this buffer should be initialized to zero during decoder reset. During decoder operation, the values contained in this buffer should be modified only by the PQMF function.
- `pVPosition` – pointer to the internal workspace index; should be initialized to zero during decoder reset. During decoder operation, the value of this index should be preserved between PQMF calls and should be modified only by the function.
- `mode` – flag that indicates whether or not the PCM audio output channels should be interleaved
  - 1 – not interleaved
  - 2 – interleaved

#### Output Arguments

- `pDstAudioOut` – pointer to a block of 32 reconstructed PCM output samples in 16-bit signedQ0.15 format (little-endian); left and right channels are interleaved according to the mode flag. This should be aligned on a 4-byte boundary



- `pVBuffer` – pointer to the updated internal workspace buffer containing Q7.24 data; see usage notes under input argument discussion
- `pVPosition` – pointer to the updated internal workspace index; see usage notes under input argument discussion

### Returns

- `OMX_Sts_NoErr` – No errors
- `OMX_Sts_BadArgErr` – bad arguments detected; one or more of the following conditions is true:
  - `mode < 1` or `mode > 2`
  - `*pVPosition` is outside the range `[0, 15]`
  - at least one of the following pointers is `NULL`: `pSrcY`, `pDstAudioOut`, `pVBuffer`, and/or `pVPosition`.

## 3.2 AAC-LC/LTP Decoder Sub-Domain (omxACAAC)

### 3.2.1 Constants

**Table 3-7: AAC-LC/LTP Constants**

| Global Macro Name                  | Definition | Notes   |
|------------------------------------|------------|---|
| <code>OMX_AAC_FRAME_LEN</code>     | 1024       | The number of data in one frame                               |
| <code>OMX_AAC_SF_LEN</code>        | 120        | scalefactor buffer length                                     |
| <code>OMX_AAC_GROUP_NUM_MAX</code> | 8          | maximum group number for one frame                            |
| <code>OMX_AAC_TNS_COEF_LEN</code>  | 60         | TNS coefficients buffer length                                |
| <code>OMX_AAC_TNS_FILT_MAX</code>  | 8          | maximum TNS filters for one frame                             |
| <code>OMX_AAC_PRED_SFB_MAX</code>  | 41         | maximum prediction scalefactor bands for one frame            |
| <code>OMX_AAC_ELT_NUM</code>       | 16         | maximum number of elements for one program.                   |
| <code>OMX_AAC_LFE_ELT_NUM</code>   | 4          | maximum Low Frequency Enhance elements number for one program |
| <code>OMX_AAC_DATA_ELT_NUM</code>  | 8          | maximum data elements number for one program                  |
| <code>OMX_AAC_COMMENTS_LEN</code>  | 256        | maximum length of the comment field, in bytes.                |

| Global Macro Name   | Definition | Notes   |
|---------------------|------------|---|
| OMX_AAC_SF_MAX      | 60         | maximum number of scalefactor bands in one window |
| OMX_AAC_WIN_MAX     | 8          |   |
| OMX_AAC_MAX_LTP_SFB | 40         |   |

## 3.2.2 Data Structures

### 3.2.2.1 ADIF Header

```
typedef struct {
    OMX_U32 ADIFId;           /** 32-bit, "ADIF" ASCII code */
    OMX_INT copyIdPres;      /** copy id flag: 0: off, 1: on */
    OMX_INT originalCopy;    /** 0: copy, 1: original */
    OMX_INT home;
    OMX_INT bitstreamType;   /** 0: constant rate, 1: variable rate */
    OMX_INT bitRate;        /** bit rate. if 0, unkown bit rate */
    OMX_INT numPrgCfgElt;    /** number of program config elements */
    OMX_INT pADIFBufFullness[OMX_AAC_ELT_NUM]; /** buffer fullness */
    OMX_U8 pCopyId[9];       /** 72-bit copy id */
} OMXAACADIFHeader;
```

### 3.2.2.2 ADTS Frame Header

```
typedef struct {
    /** ADTS fixed header */
    OMX_INT id;              /** ID 1*/
    OMX_INT layer;           /** layer index 0x3: Layer I
    *                        0x2: Layer II
    *                        0x1: Layer III
    */
    OMX_INT protectionBit;   /** 0: CRC on, 1: CRC off */
    OMX_INT profile;         /** profile: 0:MP, 1:LP, 2:SSR */
    OMX_INT samplingRateIndex; /** sampling rate index */
    OMX_INT privateBit;      /** private_bit */
    OMX_INT chConfig;        /** channel configuration */
    OMX_INT originalCopy;    /** 0: copy, 1: original */
}
```

```

OMX_INT home;

/** ADTS variable header */
OMX_INT cpRightIdBit;      /** copyright id bit */
OMX_INT cpRightIdStart;   /** copyright id start */
OMX_INT frameLen;         /** frame length in bytes */
OMX_INT ADTSBufFullness;  /** buffer fullness */
OMX_INT numRawBlock;      /** number of raw data blocks in frame */

/** ADTS CRC error check, 16 bits */
OMX_INT CRCWord;          /** CRC-check word */
} OMXAACADTSFrameHeader;

```

### 3.2.2.3 Individual Channel Stream Side Information

```

typedef struct {
    /** unpacked from the bitstream */
    OMX_INT icsReservedBit;
    OMX_INT winSequence;      /** window sequence flag */
    OMX_INT winShape;         /** window shape, 0: sine, 1: KBD */
    OMX_INT maxSfb;           /** maximum effective scalefactor bands */
    OMX_INT sfGrouping;       /** scalefactor grouping flag */
    OMX_INT predDataPres;     /** 0: prediction off. 1: prediction on */
    OMX_INT predReset;        /** 0: reset off, 1: reset on */
    OMX_INT predResetGroupNum; /** prediction reset group number */
    OMX_U8 pPredUsed[OMX_AAC_PRED_SFB_MAX+3]; /** prediction flag
                                                buffer for each
                                                scalefactor band: 0:
                                                off, 1: on;
                                                buffer length 44
                                                bytes, 4-byte align */

    /** decoded from the above info */
    OMX_INT numWinGrp;        /** number of window_groups */
    OMX_INT pWinGrpLen[OMX_AAC_GROUP_NUM_MAX]; /** buffer for
                                                windows in each group*/
} OMXAACIcsInfo;

```

### 3.2.2.4 Program Configuration Element

The program configuration element (PCE) structure is defined below. The elements of this structure correspond to the PCE syntactical unit defined in [ISO14496-3], subpart 4, section 4.5.1.2.

```
typedef struct {
    OMX_INT eltInstTag;          /* element instance tag */
    OMX_INT profile;            /* 0: main, 1: LC, 2: SSR
                                3: LTP */
    OMX_INT samplingRateIndex;  /* sampling rate index */
                                Reference: [ISO14496-3], Table 1.6.2
                                0: 96000, 1: 88200, 2: 64000, 3: 48000
                                4: 44100, 5: 32000, 6: 24000, 7: 22050
                                8: 16000, 9: 12000, 10: 11025,
                                11: 8000, 12: 7350, 13/14: rsvd,
                                15: escape val */
    OMX_INT numFrontElt;       /* number of front elements */
    OMX_INT numSideElt;        /* number of side elements */
    OMX_INT numBackElt;        /* number of back elements */
    OMX_INT numLfeElt;         /* number of LFE elements */
    OMX_INT numDataElt;        /* number of data elements */
    OMX_INT numValidCcElt;     /* number of channel coupling elements */
    OMX_INT monoMixdownPres;   /* mono mixdown flag: 0: off, 1: on */
    OMX_INT monoMixdownEltNum; /* number of SCE that is the mixdown */
    OMX_INT stereoMixdownPres; /* stereo mixdown flag: 0: off, 1: on */
    OMX_INT stereoMixdownEltNum; /* number of CPE that is the mixdown */
    OMX_INT matrixMixdownIdxPres; /* matrix mixdown: 0: off, 1: on */
    OMX_INT matrixMixdownIdx;   /* matrix mixdown coef index */
    OMX_INT pseudoSurroundEnable; /* pseudo surround: 0: off, 1: on */
    OMX_INT pFrontIsCpe[OMX_AAC_ELT_NUM]; /* indicates whether the
                                           * associated SCE or CPE is
                                           * addressed as a front
                                           * element. '0' selects an
                                           * SCE, '1' selects a CPE.
                                           * The instance of the SCE or
                                           * CPE addressed is given by
                                           * the corresponding entry in
                                           * the pFrontElementTagSel
                                           * array */
    OMX_INT pFrontTagSel[OMX_AAC_ELT_NUM]; /* instance tags of the
```

```

SCE/CPE addressed as a
front element */
OMX_INT pSideIsCpe[OMX_AAC_ELT_NUM]; /* same as pFrontIsCPE, but for
side elements */
OMX_INT pSideTagSel[OMX_AAC_ELT_NUM]; /* same as pFrontTagSel, but for
Side elements */
OMX_INT pBackIsCpe[OMX_AAC_ELT_NUM]; /* same as pFrontIsCPE, but for
back elements */
OMX_INT pBackTagSel[OMX_AAC_ELT_NUM]; /* same as pFrontTagSel, but
For back elements. */
OMX_INT pLfeTagSel[OMX_AAC_LFE_ELT_NUM]; /* instance tag of
the LFE addressed */
OMX_INT pDataTagSel[OMX_AAC_DATA_ELT_NUM]; /* instance tag of the
DSE addressed */
OMX_INT pCceIsIndSw[OMX_AAC_ELT_NUM]; /* CCE independence bit flag;
0: corresponding CCE is not
independently switched 1:
corresponding CCE is
independently switched */
OMX_INT pCceTagSel[OMX_AAC_ELT_NUM]; /* instance tags of the CCE
addressed */
OMX_INT numComBytes; /* length, in bytes, of
the comment field */
OMX_S8 pComFieldData[OMX_AAC_COMMENTS_LEN]; /* comment data */
} OMXAACPrpCfElt;

```

### 3.2.2.5 LTP Information

```

typedef struct{
    OMX_INT ltpDataPresent; /* 0: LTP used, 1: LTP not used */
    OMX_INT ltpLag; /* LTP lag; range 0 to 2047 */
    OMX_S16 ltpCoef; /* LTP coefficient, represented using
Q14, valid in the range 9352 to 22438
*/
    OMX_INT pLtpLongUsed[OMX_AAC_MAX_LTP_SFB+1]; /* SFB LTP indicators */
} OMXAACLtpInfo, *OMXAACLtpInfoPtr;

```

### 3.2.2.6 Channel Pair Element

```
typedef struct {
    OMX_INT commonWin;    /** common window flag, 0: off, 1: on */
    OMX_INT msMaskPres;  /** MS stereo mask present flag */
    OMX_U8 ppMsMask[OMX_GROUP_NUM_MAX][OMX_AAC_SF_MAX]; /** MS stereo flag
                                                             buffer for each
                                                             SFB */
} OMXAACChanPairElt;
```

### 3.2.2.7 Channel Information

```
typedef struct {
    OMX_INT tag;          /* element_instance_tag (0-15)*/
    OMX_INT id;           /* syntactic element id
                          0: SCE, 1: CPE, 2: CCE, 3: LFE,
                          4: DSE, 5: PCE, 6: FIL, 7: END */
    OMX_INT samplingRateIndex; /* sample rate index
                               Reference: [ISO14496-3], Table 1.6.2
                               0: 96000, 1: 88200, 2: 64000, 3: 48000
                               4: 44100, 5: 32000, 6: 24000, 7: 22050
                               8: 16000, 9: 12000, 10: 11025, 11: 8000
                               12: 7350, 13/14: rsvd, 15: escape val */
    OMX_INT predSfbMax;   /* maximum prediction scalefactor bands */
    OMX_INT preWinShape;  /* previous block window shape */
    OMX_INT winLen;       /* 128: short window, 1024: others */
    OMX_INT numWin;       /* 1: long block, 8: short block */
    OMX_INT numSwb;       /* depends on sample freq. + block type */
    OMX_INT globGain;     /* global gain */
    OMX_INT pulseDataPres; /* pulse data present flag, 0: off, 1: on */
    OMX_INT tnsDataPres;  /* TNS data present flag, 0: off, 1: on */
    OMX_INT gainContrDataPres; /* gc data present flag, 0: off, 1: on */
    OMXAACIcsInfo *pIcsInfo; /* pointer to OMXAACIcsInfo struct */
    OMXAACChanPairElt *pChanPairElt; /* ptr to OMXAACChanPairElt struct */
    OMX_U8 pSectCb[OMX_AAC_SF_LEN]; /* section codebook buffer */
    OMX_U8 pSectEnd[OMX_AAC_SF_LEN]; /* last SFB in each section */
    OMX_INT pMaxSect[OMX_AAC_GROUP_NUM_MAX]; /* num sections each group*/
    OMX_INT pTnsNumFilt[OMX_AAC_GROUP_NUM_MAX]; /* num TNS filters */
    OMX_INT pTnsFiltCoefRes[OMX_AAC_GROUP_NUM_MAX]; /* TNS coef res flags */
}
```

```

    OMX_INT pTnsRegionLen[OMX_AAC_TNS_FILT_MAX];    /* TNS filter lens */
    OMX_INT pTnsFiltOrder[OMX_AAC_TNS_FILT_MAX];    /* TNS filter orders */
    OMX_INT pTnsDirection[OMX_AAC_TNS_FILT_MAX];    /* TNS filter dirs */
} OMXAACChanInfo;

```

### 3.2.2.8 Data Structure Element Naming Conventions

Table 3-8 details the relationship between several OmxAC AAC sub-domain structure field names and the associated syntax elements in [ISO14496-3].

**Table 3-8: OmxAC AAC Sub-Domain Data Structure Element Naming Conventions**

| Parameter Name | ISO Syntax Element | Description   | Reference                            |
|----------------|--------------------|---|--------------------------------------|
| maxSfb         | max_sfb            | The parameter maxSfb corresponds to the AAC syntax element max_sfb decoded from the elementary stream being processed. This parameter indicates the number of scalefactor bands transmitted per group.  | [ISO14496-3], Part 4, sub-clause 4.4 |
| numSwb         | num_swb            | The parameter numSwb is associated with AAC syntax element num_swb decoded from the elementary stream being processed. This parameter indicates the number of scalefactor window bands for both short and long blocks. Its value is a function of the sampling rate and block type. | [ISO14496-3], Part 4, sub-clause 4.4 |
| numWin         | num_windows        | The parameter numWin corresponds to the number of windows in a window sequence of the current frame. numWin is 8 if window sequence is EIGHT_SHORT_SEQUENCE, or it is 1 for other window sequences.   | [ISO14496-3], Part 4, sub-clause 4.4 |

## 3.2.3 Functions

### 3.2.3.1 Bitstream Unpacking

#### 3.2.3.1.1 UnpackADIFHeader

##### Prototype

```
OMXResult omxACAAC_UnpackADIFHeader(const OMX_U8 **ppBitStream,  
    OMXAACADIFHeader *pADIFHeader, OMXAACPrnCfElt *pPrnCfElt, OMX_INT  
    prnCfEltMax);
```

##### Description

Unpacks the AAC ADIF format header and all program configuration elements from the input bit stream and copies the contents into the ADIF header and program configuration element data structures.

##### Reference

[ISO14496-3], Table 1.A.2

##### Input Arguments

- `ppBitStream` – double pointer to the current byte before the ADIF header
- `prnCfEltMax` – the maximum allowed number of program configuration elements; an error is returned by the function if the value of the parameter `numPrnCfElt` encountered in the input stream is larger than `prnCfEltMax`
- `pADIFHeader` – pointer to an uninitialized `OMXACCADIFHeader` structure
- `pPrnCfElt` – pointer to an array of uninitialized `OMXAACPrnCfElt` structures. There should be sufficient space in the buffer to contain `prnCfEltMax` elements.

##### Output Arguments

- `ppBitStream` – double pointer to the current byte after the ADIF header
- `pADIFHeader` – pointer to the updated `OMXACCADIFHeader` structure. `UnpackADIFHeader` updates all `OMXAACADIFHeader` members to reflect the contents of the ADIF header in the input stream, with the following limitations: i) the member `pCopyId` is updated only if `copyIdPres==1`; ii) Elements 0, 1, ..., `numPrnCfElt-1` of the `pADIFFullness` array are updated only if `bistreamType==0`. The other elements of ADIF fullness array are not modified.



- `pPrgCfgElt` – pointer to the updated array of `OMXAACPrGCfgElt` structures. All program configuration element structures (i.e., elements 0, 1, ..., (`pADIFHeader->numPrgCfgElt`)-1 of the array `pPrgCfgElt`) are updated by the function to reflect the contents of the ADIF header in the input stream, with the following limitations for each PCE structure: i) the member `monoMixdownEltNum` is updated only if `monoMixdownPres==1`; ii) the member `stereoMixdownEltNum` is updated only if `stereoMixdownPres==1`; iii) the members `matrixMixdownIdx` and `pseudoSourroundEnable` are updated only if `matrixMixdownIdxPres==1`; iv) Only elements 0, 1, ..., `numFrontElt-1` of the `pFrontIsCpe` and `pFrontTagSel` arrays are updated; v) Only elements 0, 1, ..., `numSideElt-1` of the `pSideIsCpe` and `pSideTagSel` arrays are updated; vi) Only elements 0, 1, ..., `numBackElt-1` of the `pBackIsCpe` and `pBackTagSel` arrays are updated; vii) Only elements 0, 1, ..., `numLfeElt-1` of the `pLfeTagSel` array are updated; viii) Only elements 0, 1, ..., `numDataElt-1` of the `pDataTagSel` array are updated; ix) Only elements 0, 1, ..., `numValidCceElt-1` of the `pCceIsIndSw` and `pCceTagSel` arrays are updated; x) Only elements 0, 1, ..., `numComBytes-1` of the `pComFieldData` array are updated.

### Returns

- `OMX_Sts_NoErr` – no error
- `OMX_Sts_BadArgErr` – bad arguments
  - At least one of the following pointers: `ppBitStream`, `pADIFHeader`, `pPrgCfgElt`  
\*`ppBitStream` is NULL
  - `prgCfgEltMax` exceeds [1, 16]
- `OMX_StsACAAC_PrgNumErr` – the decoded `pADIFHeader->numPrgCfgElt` > `prgCfgEltMax`.



*Note: `pADIFHeader->numPrgCfgElt` is the number directly unpacked from bit stream plus 1. `prgCfgEltMax` is the number of the program configuration elements that the user wants to support. The valid range is [1, 16]*

---

### 3.2.3.1.2 UnpackADTSFrameHeader

#### Prototype

```
OMXResult omxACAAC_UnpackADTSFrameHeader (const OMX_U8 **ppBitStream,
      OMXAACADTSFrameHeader *pADTSFrameHeader);
```

#### Description

Unpacks the ADTS frame header from the input bit stream and copies the contents into an ADTS header data structure. If the ADTS protection bit is asserted (`pADTSFrameHeader->protectionBit==0`) then the 16-bit CRC word is copied into `pADTSFrameHeader->CRCWord`. The first byte is stored in `pADTSFrameHeader->CRCWord[15:8]`, and the second byte is stored in `pADTSFrameHeader->CRCWord[7:0]`. This function does not test for header corruption.

## Reference

[ISO14496-3], Table 1.A.6

## Input Arguments

- `ppBitStream` – double pointer to the current byte in the input stream
- `pADTSFrameHeader` – pointer an uninitialized `OMXACADTSHeader` structure

## Output Arguments

- `ppBitStream` – double pointer to the current byte after unpacking the ADTS frame header.
- `pADTSFrameHeader` – pointer to the updated `OMXAACADTSFrameHeader` structure. All ADTS header structure members are updated by the function to reflect the contents of the ADTS header in the input stream. The structure member `CRCWord` is updated only if `protectionBit==1`.

## Returns

- `OMX_Sts_NoErr` – no error
- `OMX_Sts_BadArgErr` – bad arguments. At least one of the following pointers: `ppBitStream`, `*ppBitStream`, or `pADTSFrameHeader` is NULL

### 3.2.3.1.3 DecodePrgCfgElt

## Prototype

```
OMXResult omxACAAC_DecodePrgCfgElt(const OMX_U8 **ppBitStream, OMX_INT
    *pOffset, OMXAACPrGCfgElt *pPrgCfgElt);
```

## Description

Unpacks one program configuration element (PCE) from the input bit stream and copies the contents into a PCE data structure.

## Reference

[ISO14496-3], sub-clause 4.5.1.2

## Input Arguments

- `ppBitStream` – double pointer to the current byte
- `pOffset` – pointer to the bit position in the byte pointed by `*ppBitStream`. Valid within the range 0 to 7; 0: MS bit, 7: LS bit.
- `pPrgCfgElt` – pointer an uninitialized `OMXACCPrgCfgElt` structure

## Output Arguments

- `ppBitStream` – updated double pointer to the current byte after decoding the PCE.
- `pOffset` – pointer to the bit position in the byte pointed by `*ppBitStream`. Valid within the range 0 to 7. 0: MS bit, 7: LS bit.

- `pPrgCfgElt` – pointer to updated `OMXAACPrgCfgElt` structure. All structures members are updated by the function to reflect the contents of the program configuration element in the input stream, with the following limitations: i) the member `monoMixdownEltNum` is updated only if `monoMixdownPres==1`, otherwise it is set equal to 0; ii) the member `stereoMixdownEltNum` is updated only if `stereoMixdownPres==1`, otherwise it is set equal to 0; iii) the members `matrixMixdownIdx` and `pseudoSourroundEnable` are updated only if `matrixMixdownIdxPres==1`; iv) Only elements 0, 1, ..., `numFrontElt-1` of the `pFrontIsCpe` and `pFrontTagSel` arrays are updated; v) Only elements 0, 1, ..., `numSideElt-1` of the `pSideIsCpe` and `pSideTagSel` arrays are updated; vi) Only elements 0, 1, ..., `numBackElt-1` of the `pBackIsCpe` and `pBackTagSel` arrays are updated; vii) Only elements 0, 1, ..., `numLfeElt-1` of the `pLfeTagSel` array are updated; viii) Only elements 0, 1, ..., `numDataElt-1` of the `pDataTagSel` array are updated; ix) Only elements 0, 1, ..., `numValidCceElt-1` of the `pCceIsIndSw` and `pCceTagSel` arrays are updated; x) Only elements 0, 1, ..., `numComBytes-1` of the `pComFieldData` array are updated

### Returns

- `OMX_Sts_NoErr` – no error
- `OMX_Sts_BadArgErr` – Bad arguments
  - At least one of the following pointers: `ppBitStream`, `pOffset`, `pPrgCfgElt`, `*ppBitStream` is NULL
  - `*pOffset` exceeds [0, 7]

### 3.2.3.1.4 DecodeChanPairElt

#### Prototype

```
OMXResult omxACAAC_DecodeChanPairElt(const OMX_U8 **ppBitStream, OMX_INT
    *pOffset, OMXAACIcsInfo *pIcsInfo, OMXAACChanPairElt *pChanPairElt,
    OMX_INT audioObjectType, OMXAACLtpInfoPtr *pLtpInfo);
```

#### Description

Decodes the contents of a channel pair element (CPE) from the input bitstream and copies the information into the output CPE data structure `*pChanPairElt`, output individual channel stream side information structure (ICS) `*pIcsInfo`, and output array of LTP information structures `*(pLtpInfo[0])`, `*(pLtpInfo[1])`. Updates are conditional and depend on the contents of the bitstream. The ICS information structure `*pIcsInfo` is updated only if the flag parameter `pChanPairElt->CommonWin == 1`. The array of LTP information structures `*pLtpInfo` is updated only if `(pChanPairElt->CommonWin == 1) && (audioObjectType==4)`. If `pChanPairElt->CommonWin == 0`, then `DecodeChanPairElt` updates only the structure member `pChanPairElt->commonWin`, and all other `*pIcsInfo`, `*pChanPairElt`, and `*pLtpInfo` structure members/array elements remain unchanged.

#### Reference

[ISO14496-3], Table 4.5

## Input Arguments

- `ppBitStream` – double pointer to the current byte in the input bitstream
- `pOffset` – pointer to the next available bit of the input bitstream byte referenced by `*ppBitStream`. Valid in the range 0 to 7, where 0 signifies the most significant bit and 7 signifies the least significant bit
- `audioObjectType` – index of the audio object type: 2=LC, 4=LTP

## Output Arguments

- `ppBitStream` – double pointer to the current byte in the input bitstream, updated after decoding the channel pair element.
- `pOffset` – pointer to the next available bit of the input bitstream byte referenced by `*ppBitStream`. Valid in the range 0 to 7, where 0 signifies the most significant bit and 7 signifies the least significant bit.
- `pIcsInfo` – if `pChanPairElt->CommonWin == 1`, then `pIcsInfo` points to the updated `OMXAACIcsInfo` structure. In this case, all structure elements are updated unconditionally except as shown in Table 3-9. Also in this case, only the first `pIcsInfo->numWinGrp` elements in `pIcsInfo->pWinGrpLen` are updated. Otherwise, if `pChanPairElt->CommonWin == 0` then none of the structure members are modified; in this case the array `pIcsInfo` will be updated by the function `omxACAAC_NoiselessDecode`.
- `pChanPairElt` – pointer to the updated `OMXAACChanPairElt` structure. The function modifies the `commonWin` structure member unconditionally, but modifies the other members (`msMaskPres` and `ppMsMask` array) only if `(pChanPairElt->CommonWin == 1)`, as shown in Table 3-10.
- `pLtpInfo` – array containing two LTP information structure pointers. If `(pChanPairElt->CommonWin == 1) && (audioObjectType==4)`, then the structures referenced by the pointers in this array are updated to contain the LTP information associated with the individual channels in the current CPE on which LTP has been enabled. Four update scenarios are possible: i) *no LTP information* - if the bit field `predictor_data_present==0` within the `ics_info` syntax element of the current CPE, then the array `pLtpInfo` is not modified ii) *LTP on the first CPE channel* - if the elementary stream bit field `predictor_data_present==1 &&` the first occurrence of the bit field `ltp_data_present==1` then the contents of `*(pLtpInfo[0])` are updated; iii) *LTP on the second CPE channel* - if `predictor_data_present==1 &&` the second occurrence of the bit field `ltp_data_present==1` then the contents of `*(pLtpInfo[1])` are updated; iv) *LTP on both CPE channels* - both cases ii) and iii) may occur simultaneously, in which case both array elements are updated. Otherwise, if `(pChanPairElt->CommonWin == 0) || (audioObjectType!=4)` then the function `omxACAAC_DecodeChanPairElt` does not update the contents of the structures referenced by the pointers in the array. Under this condition, the array will be updated later in the stream decoding process by the function `omxACAAC_NoiselessDecode`. Reference: [ISO14496-3], sub-clause 4.4.2.1 and Tables 4.5-4.6.

**Table 3-9: plcsInfo Members Modified Conditionally by DecodeChanPairElt**

| Members    | Required Condition  |
|------------|---|
| SfGrouping | <code>pChanPairElt-&gt;CommonWin == 1 &amp;&amp; plcsInfo-&gt;winSequence == 2</code> |

| Members           | Required Condition |
|-------------------|--------------------|
| predResetGroupNum | Never modified     |
| predReset         | Never modified     |
| pPredUsed[.]      | Never modified     |

**Table 3-10: pChanPairElt Members Modified Conditionally by DecodeChanPairElt**

| Members      | Required Condition  |
|--------------|---|
| msMaskPres   | pChanPairElt->CommonWin == 1                                |
| pMsMask[sfb] | pChanPairElt->CommonWin==1 && pChanPairElt->msMaskPres == 1 |

### Returns

- OMX\_Sts\_NoErr – no error
- OMX\_Sts\_BadArgErr – bad arguments
  - at least one of the following pointers is NULL: ppBitStream, pOffset, \*ppBitStream, pIcsInfo or pChanPairElt.
  - \*pOffset exceeds [0, 7]
  - audioObjectType!=2 && audioObjectType!=4
- OMX\_Sts\_InvalidBitstreamValErr – invalid bitstream parameter value detected
  - commonWin==1 and the decoded value of pIcsInfo->maxSfb is out of range, i.e., exceeds [0, 51]

### 3.2.3.1.5 DecodeDatStrElt

#### Prototype

```
OMXResult omxACAAC_DecodeDatStrElt(const OMX_U8 **ppBitStream, OMX_INT
    *pOffset, OMX_INT *pDataTag, OMX_INT *pDataCnt, OMX_U8 *pDstDataElt);
```

#### Description

Gets data\_stream\_element from the input bit stream.

#### Reference

[ISO14496-3], Table 4.10

#### Input Arguments

- ppBitStream – double pointer to the current byte

- `pOffset` – pointer to the bit position in the byte pointed by `*ppBitStream`. Valid within 0 to 7. 0: MSB of the byte, 7: LSB of the byte.

### Output Arguments

- `ppBitStream` – double pointer to the current byte after the decode data stream element
- `pOffset` – pointer to the bit position in the byte pointed by `*ppBitStream`. Valid within 0 to 7. 0: MSB of the byte, 7: LSB of the byte.
- `pDataTag` – pointer to `element_instance_tag`.
- `pDataCnt` – pointer to the value of length of total data in bytes
- `pDstDataElt` – pointer to the data stream buffer that contains the data stream extracted from the input bit stream. There are 512 elements in the buffer pointed by `pDstDataElt`.

### Returns

- `OMX_Sts_NoErr` – no error
- `OMX_Sts_BadArgErr` – bad arguments
  - At least one of the following pointers: `ppBitStream`, `pOffset`, `*ppBitStream`, `pDataTag`, `pDataCnt` or `pDstDataElt` is NULL.
  - `*pOffset` exceeds [0, 7]

## 3.2.3.1.6 DecodeFillElt

### Prototype

```
OMXResult omxACAAC_DecodeFillElt(const OMX_U8 **ppBitStream, OMX_INT
    *pOffset, OMX_INT *pFillCnt, OMX_U8 *pDstFillElt);
```

### Description

Gets the fill element from the input bit stream.

### Reference

[ISO14496-3], Table 4.11

### Input Arguments

- `ppBitStream` – pointer to the pointer to the current byte
- `pOffset` – pointer to the bit position in the byte pointed by `*ppBitStream`. Valid within 0 to 7. 0: MSB of the byte, 7: LSB of the byte

### Output Arguments

- `ppBitStream` – pointer to the pointer to the current byte after the decode fill element
- `pOffset` – pointer to the bit position in the byte pointed by `*ppBitStream`. Valid within 0 to 7. 0: MSB of the byte, 7: LSB of the byte.
- `pFillCnt` – pointer to the value of the length of total fill data in bytes
- `pDstFillElt` – pointer to the fill data buffer of length 270

## Returns

- OMX\_Sts\_NoErr – no error
- OMX\_Sts\_BadArgErr – bad arguments
  - At least one of the following pointers: `ppBitStream`, `pOffset`, `*ppBitStream`, `pFillCnt` or `pDstFillElt` is NULL
  - `*pOffset` exceeds [0, 7]

## 3.2.3.2 Inverse Quantization

### 3.2.3.2.1 QuantInv\_S32\_I

#### Prototype

```
OMXResult omxACAAC_QuantInv_S32_I(OMX_S32 *pSrcDstSpectralCoef, const
    OMX_S16 *pScalefactor, OMX_INT numWinGrp, const OMX_INT *pWinGrpLen,
    OMX_INT maxSfb, const OMX_U8 *pSfbCb, OMX_INT samplingRateIndex, OMX_INT
    winLen);
```

#### Description

Inverse quantize the Huffman symbols for current channel. The equation is shown below.

$$pSrcDst[i] = \text{sign}(pSrcDst[i]) * (pSrcDst[i])^{\frac{4}{3}} * 2^{\left\lfloor \frac{1}{4} (pScalefactor[sfb] - 100) \right\rfloor}$$

#### Reference

[ISO14496-3], sub-clause 4.6.1

#### Input Arguments

- `pSrcDstSpectralCoef` – pointer to the quantized coefficients extracted from the input stream by the Huffman decoder. The quantized coefficients are integer values represented using Q0, i.e., no scaling. For short blocks the coefficients are interleaved by `scalefactor` window bands in each group. Buffer must have sufficient space to contain 1024 elements.
- `pScalefactor` – pointer to the scalefactor buffer, of length 120
- `numWinGrp` – group number
- `pWinGrpLen` – pointer to the number of windows in each group, of length 8
- `maxSfb` – max scalefactor bands number for the current block
- `pSfbCb` – pointer to the scalefactor band codebook, of length 120. Only `maxSfb` elements for each group are meaningful. There are no spaces between the sequence groups.
- `samplingRateIndex` – sampling rate index. Valid in [0, 11]
- `winLen` – the data number in one window

## Output Arguments

- `pSrcDstSpectralCoef` – pointer to the inverse quantized coefficient array, in Q28.3 format and of length 1024. For short blocks, the coefficients are interleaved by scalefactor window bands in each group.

## Returns

- `OMX_Sts_NoErr` – no error
- `OMX_Sts_BadArgErr` – bad arguments
  - At least one of the following pointers: `pSrcDstSpectralCoef`, `pScalefactor`, `pWinGrpLen` or `pSfbCb` is NULL
  - If short block `numWinGrp` exceeds [1, 8]
  - If long block, `numWinGrp` != 1
  - `maxSfb` exceed [0, 51]
  - `samplingRateIndex` exceeds [0, 11]
  - `winLen` is neither 1024 nor 128
- `OMX_StsACAAC_CoefValErr` – an input coefficient value contained in the array referenced by `pSrcDstSpectralCoef` exceeds the range [-8191, 8191].
- `OMX_StsACAAC_MaxSfbErr` – invalid `maxSfb` value in relation to `numSwb`

## 3.2.3.3 Joint Stereo Decoding

### 3.2.3.3.1 DecodeMsStereo\_S32\_I

#### Prototype

```
OMXResult omxACAAC_DecodeMsStereo_S32_I(OMX_S32 *pSrcDstL, OMX_S32
    *pSrcDstR, OMXAACChanPairElt *pChanPairElt, OMX_U8 *pSfbCb, OMX_INT
    numWinGrp, const OMX_INT *pWinGrpLen, OMX_INT maxSfb, OMX_INT
    samplingRateIndex, OMX_INT winLen);
```

#### Description

Performs M-S stereo decoding; converts the MS stereo jointly-coded scalefactor bands of a channel pair from the M-S representation to the L-R representation; also performs the `invert_intensity(group, sfb)` function and stores the values in the `pSfbCb` buffer. If `invert_intensity(group, sfb) = -1`, and if `*pSfbCb = INTERITY_HCB`, let `*pSfbCb = INTERITY_HCB2`; else if `*pSfbCb = INTERITY_HCB2`, let `*pSfbCb = INTERITY_HCB`. For scalefactor bands in which the MS stereo flag is asserted, the individual left and right channel spectral samples `pSrcDstL[i]` and `pSrcDstR[i]` are computed as follows:

$$\begin{aligned} pSrcDstL'[i] &= pSrcDstL[i] + pSrcDstR[i], \\ pSrcDstR'[i] &= pSrcDstL[i] - pSrcDstR[i]. \end{aligned}$$



## Reference

[ISO14496-3], sub-clause 4.6.8.1

## Input Arguments

- `pSrcDstL` – pointer to left channel data in Q28.3 format. For short blocks, the coefficients are interleaved by scalefactor window bands in each group, of length 1024. `pSrcDstL` must be 8-byte aligned.
- `pSrcDstr` – pointer to right channel data in Q28.3 format. For short block, the coefficients are interleaved by scalefactor window bands in each group, of length 1024. `pSrcDstr` must be 8-byte aligned.
- `pChanPairElt` – pointer to a Channel Pair Element structure that has been previously populated. At minimum, the contents of `msMaskPres` and `pMsUsed` fields are used to control MS decoding process and must be valid. These provide, respectively, the MS stereo mask for a scalefactor band (0: MS Off, 1: MS On, 2: all bands on), and the MS stereo flag buffer, of length 120.
- `pSfbCb` – pointer to the scalefactor band codebook, of length 120. Stores `maxSfb` elements for each group. There is no space between the sequence groups
- `numWinGrp` – group number
- `pWinGrpLen` – pointer to the number of windows in each group, of length 8
- `maxSfb` – max scalefactor bands number for the current block
- `samplingRateIndex` – sampling rate index; valid in the range [0, 11]
- `winLen` – the data number in one window

## Output Arguments

- `pSrcDstL` – pointer to left channel data in Q28.3 format. For short blocks, the coefficients are interleaved by scalefactor window bands in each group, of length 1024. `pSrcDstL` must be 8-byte aligned.
- `pSrcDstr` – pointer to right channel data in Q28.3 format. For short blocks, the coefficients are interleaved by scalefactor window bands in each group, of length 1024. `pSrcDstr` must be 8-byte aligned.
- `pSfbCb` – pointer to the scalefactor band codebook. If `invert_intensity_group, sfb) = -1`, and if `*pSfbCb = INTERITY_HCB`, let `*pSfbCb = INTERITY_HCB2`; else if `*pSfbCb = INTERITY_HCB2`, let `*pSfbCb = INTERITY_HCB`. Buffer length is 120. Store `maxSfb` elements for each group. There is no space between the sequence groups.

## Returns

- `OMX_Sts_NoErr` – no error
- `OMX_Sts_BadArgErr` – bad arguments
  - At least one of the following pointers: `pSrcDstL`, `pSrcDstr`, `pMsUsed`, `pWinGrpLen`, `pSfbCb` is NULL.
  - `pSrcDstL` or `pSrcDstr` is not 8-byte aligned
  - For short blocks, `numWinGrp` exceeds [1, 8]
  - For long blocks, `numWinGrp` != 1

- `maxSfb` exceeds [0, 51]
- `msMaskPres` exceeds [1, 2]
- `samplingRateIndex` exceeds [0, 11]
- `winLen` is neither 1024 nor 128
- `OMX_StsACAAC_MaxSfbErr` – invalid `maxSfb` value in relation to `numSwb`

### 3.2.3.3.2 DecodelsStereo\_S32

#### Prototype

```
OMXResult omxACAAC_DecodeIsStereo_S32(const OMX_S32 *pSrcL, OMX_S32 *pDstR,
    const OMX_S16 *pScalefactor, const OMX_U8 *pSfbCb, OMX_INT numWinGrp,
    const OMX_INT *pWinGrpLen, OMX_INT maxSfb, OMX_INT samplingRateIndex,
    OMX_INT winLen);
```

#### Description

Decodes jointly-coded scalefactor bands into discrete L/R stereo pairs for scalefactor bands in which the intensity stereo indicator flag stored in `pSfbCb[sfb]` is asserted. As described in [ISO14496-3], the discrete L/R signals `pSrcL[i]`, `pDstR[i]` are recovered from the intensity-coded representation (single channel spectral coefficients + scalefactor) using the scaling operation expressed below. The parameter `invert_intensity(g, sfb)` is *not* used in the formula, since it decoded and stored in `pSfbCb[sfb]` by the MS stereo decoder.

$$pDstR[i] = pSrcL[i] * is\_intensity(g, sfb) * 2^{\left(-\frac{1}{4} pScalefactor[sfb]\right)}$$

#### Reference

[ISO14496-3], sub-clause 4.6.8.2

#### Input Arguments

- `pSrcL` – pointer to left channel data in Q28.3 format. For short block, the coefficients are interleaved by scalefactor window bands in each group. Buffer length is 1024. `pSrcL` must be 8-byte aligned.
- `pScalefactor` – pointer to the scalefactor buffer, of length 120
- `pSfbCb` – pointer to the scalefactor band codebook, of length 120. Store `maxSfb` elements for each group. There are no spaces between the sequence groups.
- `numWinGrp` – group number
- `pWinGrpLen` – pointer to the number of windows in each group, of length 8
- `maxSfb` – Max scalefactor bands number for the current block
- `samplingRateIndex` – sampling rate index. Valid in [0, 11]
- `winLen` – the data number in one window

## Output Arguments

- `pDstR` – pointer to right channel data in Q28.3 format. For short block, the coefficients are interleaved by scalefactor window bands in each group. Buffer length is 1024. `pDstR` must be 8-byte aligned.

## Returns

- `OMX_Sts_NoErr` – no error
- `OMX_Sts_BadArgErr` – bad arguments
  - At least one of the following pointers: `pSrcL`, `pDstR`, `pWinGrpLen`, `pScalefactor`, `pSfbCb` is NULL.
  - If `pSrcL`, `pDstR` is not 8-byte aligned.
  - If short block, `numWinGrp` exceeds [1, 8]
  - If long block, `numWinGrp` != 1
  - `maxSfb` exceeds [0, 51]
  - `samplingRateIndex` exceeds [0, 11]
  - `winLen` is neither 1024 nor 128
- `OMX_StsACAAC_MaxSfbErr` – invalid `maxSfb` value in relation to `numSwb`

## 3.2.3.4 Temporal Noise Shaping

### 3.2.3.4.1 DecodeTNS\_S32\_I

#### Prototype

```
OMXResult omxACAAC_DecodeTNS_S32_I(OMX_S32 *pSrcDstSpectralCoefs, const
    OMX_INT *pTnsNumFilt, const OMX_INT *pTnsRegionLen, const OMX_INT
    *pTnsFiltOrder, const OMX_INT *pTnsFiltCoefRes, const OMX_S8
    *pTnsFiltCoef, const OMX_INT *pTnsDirection, OMX_INT maxSfb, OMX_INT
    profile, OMX_INT samplingRateIndex, OMX_INT winLen);
```

#### Description

This function applies all-pole Temporal Noise Shaping (TNS) decoding filters to selected spectral coefficient regions. The output sequence is ready for the IMDCT synthesis bank.

#### Reference

[ISO14496-3], sub-clause 4.6.9

#### Input Arguments

- `pSrcDstSpectralCoefs` – spectral coefficient input vector, of length 1024, represented using Q28.3 format

- `pTnsNumFilt` – pointer to a table containing the number of TNS filters that are applied on each window of the current frame. The table elements are indexed as follows:  
`pTnsNumFilt[w]`,  $w=0$  to  $\text{numWin}-1$ ; depending upon the current window sequence, this vector may contain up to 8 elements.
- `pTnsRegionLen` – pointer to a table containing TNS region lengths (in scalefactor band units) for all regions and windows on the current frame; the table entry `pTnsRegionLen[i]` specifies the region length for  $k$ -th filter on the  $w$ -th window. The table index,  $i$ , is computed as follows:

$$i = \sum_{j=0}^{w-1} pTnsNumFilt[j] + k$$

where  $0 \leq w \leq \text{numWin}-1$ , and  $0 \leq k \leq pTnsNumFilt[w]-1$ .

- `pTnsFiltOrder` – pointer to a table containing TNS filter orders for all regions and windows on the current frame; the table entry `pTnsFiltOrder[i]` specifies the TNS filter order for the  $k$ -th filter on the  $w$ -th window. The table index,  $i$ , is computed as follows

$$i = \sum_{j=0}^{w-1} pTnsNumFilt[j] + k$$

where  $0 \leq w \leq \text{numWin}-1$ , and  $0 \leq k \leq pTnsNumFilt[w]-1$ .

- `pTnsFiltCoefRes` – pointer to a table of TNS filter coefficient resolution indicators for each window on the current frame. Resolutions for filters on the  $w$ -th window are specified in table entry `pTnsFiltCoefRes[w]`, and  $w=0$  to  $\text{numWin}-1$ .
- `pTnsFiltCoef` – pointer to a table containing the complete set of TNS filter coefficients for all windows and regions on the current frame. Filter coefficients are stored contiguously in filter-major order, i.e., the table is organized such that the filter coefficients for the  $k$ -th filter of the  $w$ -th window are indexed using `pTnsFiltCoef[w][k][i]`, where  $0 \leq i \leq pTnsFiltOrder[j]-1$ ,  $0 \leq k \leq pTnsNumFilt[w]-1$ ,  $0 \leq w \leq \text{numWin}-1$ , and the filter order index  $j$  is computed as shown above.
- `pTnsDirection` – pointer to a table of tokens that indicate the direction of TNS filtering for all regions and windows on the current frame, with 0 indicating upward and 1 indicating downward; in particular the table entry `pTnsDirection[i]` specifies direction for  $k$ -th filter on the  $w$ -th window, and the table index,  $i$ , is computed as follows:

$$i = \sum_{j=0}^{w-1} pTnsNumFilt[j] + k$$

where  $0 \leq w \leq \text{numWin}-1$ , and  $0 \leq k \leq pTnsNumFilt[w]-1$ .

- `maxSfb` – number of scalefactor bands transmitted per window group on the current frame
- `profile` – profile index, 0=main, 1=LC, 2=SSR as shown in [ISO14496-3], Table 4.6.9
- `samplingRateIndex` – sample rate index for the current frame
- `winLen` – window length

## Output Arguments

`pSrcDstSpectralCoefs` – pointer to the output spectral coefficients after TNS filtering represented

using Q28.3 format.

### Returns

- OMX\_Sts\_NoErr – no error
- OMX\_Sts\_BadArgErr – bad arguments
  - At least one of the following pointers is NULL: pSrcDstSpectralCoefs, pTnsNumFilt, pTnsRegionLen, pTnsFiltOrder, pTnsFiltCoefRes, pTnsFiltCoef, or pTnsDirection.
  - profile!=1
  - samplingRateIndex exceeds [0, 11]
  - winLen!=128 and winLen!=1024
  - maxSfb exceeds [0,51]
- OMX\_StsACAAC\_TnsNumFiltErr – for a short window sequence, pTnsNumFilt[w] exceeds [0, 1]; For long window sequence, pTnsNumFilt[w] exceeds [0, 3], w=0 to numWin-1.
- OMX\_StsACAAC\_TnsLenErr – \*pTnsRegionLen exceeds [0, numSwb]
- OMX\_StsACAAC\_TnsOrderErr – for short window sequence, \*pTnsFiltOrder exceeds [0, 7]; For long window sequence, \*pTnsFiltOrder exceeds [0, 12]
- OMX\_StsACAAC\_TnsCoefResErr – pTnsFiltCoefRes[w] exceeds [3, 4], w=0 to numWin-1
- OMX\_StsACAAC\_TnsCoefErr – \*pTnsFiltCoef exceeds [-8, 7]
- OMX\_StsACAAC\_TnsDirectErr – \*pTnsDirection exceeds [0, 1]
- OMX\_StsACAAC\_MaxSfbErr – invalid maxSfb value in relation to numSwb

## 3.2.3.5 Synthesis Filterbank

### 3.2.3.5.1 DeinterleaveSpectrum\_S32

#### Prototype

```
OMXResult omxACAAC_DeinterleaveSpectrum_S32 (const OMX_S32 *pSrc, OMX_S32 *pDst, OMX_INT numWinGrp, const OMX_INT *pWinGrpLen, OMX_INT maxSfb, OMX_INT samplingRateIndex, OMX_INT winLen);
```

#### Description

Deinterleaves spectral coefficients for short block. Sets coefficients above maxSfb equal to zero.

#### Reference

[ISO14496-3], sub-clause 4.5.2.3.5 and Figures 4.22-4.24.

#### Input Arguments

- pSrc – pointer to source coefficients buffer. The coefficients are interleaved by scalefactor window bands in each group. Buffer length is 1024. pSrc must be 8-byte aligned.

- numWinGrp – group number
- pWinGrpLen – pointer to the number of windows in each group. Buffer length is 8
- maxSfb – Max scalefactor bands number for the current block
- samplingRateIndex – sampling rate index. Valid in [0, 11]
- winLen – the data number in one window

### Output Arguments

- pDst – pointer to the output of coefficients. Data sequence is ordered in  $pDst[w*128+sfb*sfbWidth[sfb]+i]$ . Where  $w$  is window index,  $sfb$  is scalefactor band index,  $sfbWidth$  is the scalefactor band width table,  $i$  is the index within scalefactor band. Buffer length is 1024. The pDst pointer must be aligned on an 8-byte boundary.

### Returns

- OMX\_Sts\_NoErr – no error
- OMX\_Sts\_BadArgErr – bad arguments
  - at least one of the following pointers is NULL: pSrc, pDst, pWinGrpLen.
  - either pSrc or pDst are not 8-byte aligned
  - numWinGrp exceeds [1, 8]
  - maxSfb exceeds [0, 51]
  - samplingRateIndex exceeds [0, 11]
  - winLen is not 128
- OMX\_StsACAAC\_MaxSfbErr – invalid maxSfb value in relation to numSwb

## 3.2.3.5.2 MDCTInv\_S32\_S16

### Prototype

```
OMXResult omxACAAC_MDCTInv_S32_S16(const OMX_S32 *pSrcSpectralCoefs, OMX_S16
  *pDstPcmAudioOut, OMX_S32 *pSrcDstOverlapAddBuf, OMX_INT winSequence,
  OMX_INT winShape, OMX_INT prevWinShape, OMX_INT pcmMode);
```

### Description

This function computes an inverse MDCT to generate 1024 reconstructed 16-bit signed little-endian PCM samples as output for each channel. In order to adapt the time/frequency resolution of the filterbank to the characteristics of the input signal, a block switching tool is also adopted. For each channel, 1024 time-frequency domain samples are transformed into the time domain via the IMDCT. After applying the windowing operation, the first half of the windowed sequence is added to the second half of the previous block windowed sequence to reconstruct 1024 output samples for each channel. Output can be interleaved according to pcmMode.

If pcmMode equals 2, output is in the sequence  $pDstPcmAudioOut[2*i]$ ,  $i=0$  to 1023, i.e., 1024 output samples are stored in the sequence:  $pDstPcmAudioOut[0]$ ,  $pDstPcmAudioOut[2]$ ,  $pDstPcmAudioOut[4]$ , ...,  $pDstPcmAudioOut[2046]$ . If pcmMode equals 1, output is in the sequence  $pDstPcmAudioOut[i]$ ,  $i=0$  to 1023. User must also preallocate an input-output buffer

pointed by `pSrcDstOverlapAddBuf` for overlap-add operation. Reset this buffer to zero before first call, then use the output of the current call as the input of the next call for the same channel.

## Reference

[ISO14496-3], sub-clause 4.6.11

## Input Arguments

- `pSrcSpectralCoefs` – pointer to the input time-frequency domain samples in Q28.3 format. There are 1024 elements in the buffer pointed by `pSrcSpectralCoefs`.
- `pSrcDstOverlapAddBuf` – pointer to the overlap-add buffer which contains the second half of the previous block windowed sequence in Q28.3. There are 1024 elements in this buffer.
- `winSequence` – analysis window sequence specifier for the current block; the following values are allowed: 0=only\_long\_sequence/long\_window, 1=long\_start\_sequence/long\_start\_window, 2=eight\_short\_sequence/short window, 3=long\_stop\_sequence/long\_stop\_window. The function will return an error if `winSequence < 0` or `winSequence > 3`.
- `winShape` – analysis window shape specifier for the current block. The following values are allowed: 0=sine window, 1=Kaiser-Bessel derived (KBD) window. The function will return an error if this parameter is not equal to either 0 or 1.
- `prevWinShape` – analysis window shape specifier for the previous block. The following values are allowed: 0=sine window, 1=Kaiser-Bessel derived (KBD) window. The function will return an error if this parameter is not equal to either 0 or 1.
- `pcmMode` – flag that indicates whether the PCM audio output is interleaved (LRLRLR...) or not:  
1 = not interleaved  
2 = interleaved

## Output Arguments

- `pDstPcmAudioOut` – Pointer to the output 1024 reconstructed 16-bit signed little-endian PCM samples in Q15.0, interleaved if needed.
- `pSrcDstOverlapAddBuf` – pointer to the overlap-add buffer which contains the second half of the current block windowed sequence in Q28.3.

## Returns

- `OMX_Sts_NoErr` – no error
- `OMX_Sts_BadArgErr` – bad arguments
  - at least one of the pointers is NULL: `pSrcSpectralCoefs`, `pSrcDstOverlapAddBuf`, or `pDstPcmAudioOut`
  - `winSequence < 0`, or `winSequence > 3`
  - `winShape < 0`, or `winShape > 1`
  - `prevWinShape < 0`, or `prevWinShape > 1`
  - `pcmMode < 1`, or `pcmMode > 2`

## 3.2.3.6 Perceptual Noise Substitution

### 3.2.3.6.1 DecodeMsPNS\_S32\_I

#### Prototype

```
OMXResult omxACAAC_DecodeMsPNS_S32_I (OMX_S32 *pSrcDstSpec, OMX_INT
    *pSrcDstLtpFlag, OMX_U8 *pSfbCb, OMX_S16 *pScaleFactor, OMX_INT maxSfb,
    OMX_INT numWinGrp, OMX_INT *pWinGrpLen, OMX_INT samplingFreqIndex,
    OMX_INT winLen, OMX_INT *pRandomSeed, OMX_INT channel, OMX_U8 *pMsUsed,
    OMX_INT *pNoiseState);
```

#### Description

Performs perceptual noise substitution for one channel across all window groups and scalefactor bands. PNS is activated for SFBs labeled in the pSfbCb vector to be of type NOISE\_HCB. For PNS scalefactor bands, spectral coefficients are derived from random vectors rather than from decoded Huffman symbols.

#### Reference

[ISO14496-3], sub-clause 4.6.13

#### Input Arguments

- pSrcDstSpec – pointer to the spectral coefficient vector to which PNS should be applied
- pSrcDstLtpFlag – pointer to LTP used flag
- pSfbCb – pointer to scalefactor codebook; PNS is applied to SFBs tagged with NOISE\_HCB
- pScaleFactor – pointer to the scalefactor value
- maxSfb – number of scale factor bands used
- numWinGrp – number of window group
- pWinGrpLen – pointer to the length of every window group
- samplingFreqIndex – sampling frequency index
- winLen – window length, 1024 for long, 128 for short
- pRandomSeed – random seed for PNS
- channel - index of current channel, 0:left, 1:right
- pMsUsed - pointer to MS used buffer from the CPE structure
- pNoiseState – pointer to random noise generator seed history buffer, of dimension [OMX\_GROUP\_NUM\_MAX][OMX\_AAC\_SF\_MAX]. If channel==0, this buffer is used only as an output and the contents upon input are ignored. If channel==1 the entries in this buffer are used to seed the PNS random number generator for each scalefactor band in which pMsUsed==1 in order to guarantee L-R correlation in those particular SFBs. Correlation is guaranteed as long as the seed entries were previously stored into this buffer during a prior call to the function with the input parameter channel==0.

#### Output Arguments

- pSrcDstSpec – pointer to updated spectral coefficient vector after completion of PNS



- `pSrcDstLtpFlag` – pointer to the LTP used flag
- `pRandomSeed` – updated PNS random seed
- `pNoiseState` – random seed buffer, of dimension `[OMX_GROUP_NUM_MAX][OMX_AAC_SF_MAX]`. Two possible return conditions are possible: If `channel==0`, this buffer returns the complete set of left channel random seeds used at the start of PNS synthesis for every scalefactor band in every group for which `pSfbCb == NOISE_HCB`. If `channel==1` the buffer is used as an input only and the contents are unchanged from input to output.

### Returns

- `OMX_Sts_NoErr` – no error
- `OMX_Sts_ACAAC_MaxSfbErr` – invalid `maxSfb` value in relation to `numSwb`
- `OMX_Sts_BadArgErr` – bad arguments
  - at least one of the pointers: `pSrcDstSpec`, `pSfbCb`, `pScaleFactor`, `pWinGrpLen` or `pSrcDstLtpFlag` is NULL
  - `numWinGrp` exceeds `[1, 8]`
  - `samplingFreqIndex` exceeds `[0,12]`
  - `winLen` is neither 128 nor 1024
  - `maxSfb` not in `[0,51]`

## 3.2.3.7 Long-Term Prediction

### 3.2.3.7.1 LongTermReconstruct\_S32\_I

#### Prototype

```
OMXResult omxACAAC_LongTermReconstruct_S32_I(OMX_S32 *pSrcDstSpec, OMX_S32
    *pSrcEstSpec, OMX_INT *pLtpFlag, OMX_INT samplingFreqIndex);
```

#### Description

Reconstruction portion of the LTP loop; adds the vector of decoded spectral coefficients and the corresponding spectral-domain LTP output vector to obtain a vector of reconstructed spectral samples.

#### Reference

[ISO14496-3], sub-clause 4.6.7

#### Input Arguments

- `pSrcDstSpec` – pointer to decoded spectral coefficients; coefficients are represented using Q28.3
- `pSrcEstSpec` – pointer to the spectral-domain LTP output vector; coefficients are represented using Q28.3
- `samplingFreqIndex` – sampling frequency index
- `pLtpFlag` – pointer to the vector of scalefactor band LTP indicator flags

## Output Arguments

`pSrcDstSpec` – pointer to reconstructed spectral coefficient vector; coefficients are represented using Q28.3

## Returns

- `OMX_Sts_NoErr` – no error
- `OMX_Sts_BadArgErr` – bad arguments
  - one or more of the following pointers is NULL: `pSrcDstSpec`, `pSrcEstSpec`, or `pLtpFlag`
  - `samplingFreqIndex` is outside the range [0,12]

### 3.2.3.7.2 MDCTFwd\_S32

#### Prototype

```
OMXResult omxACAAC_MDCTFwd_S32(OMX_S32 *pSrc, OMX_S32 *pDst, OMX_INT  
    winSequence, OMX_INT winShape, OMX_INT preWinShape, OMX_S32  
    *pWindowedBuf);
```

#### Description

Forward MDCT portion of the LTP loop; used only for audio objects of type LTP.

#### Reference

[ISO14496-3], sub-clause 4.6.7.3

#### Input Arguments

- `pSrc` – pointer to the time-domain input sequence; samples are represented using Q28.3
- `winSequence` – window sequence specifier for the current block; the following values are allowed: 0=only\_long\_sequence/long\_window, 1=long\_start\_sequence/long\_start\_window, 3=long\_stop\_sequence/long\_stop\_window. The function will return an error if `winSequence==2`, as short window sequences are not allowed in the LTP reconstruction loop for AAC LTP audio objects.
- `winShape` – window shape specifier for the current block. The following values are allowed: 0=sine window, 1=Kaiser-Bessel derived (KBD) window. The function will return an error if this parameter is not equal to either 0 or 1.
- `preWinShape` – analysis window shape specifier for the previous block. The following values are allowed: 0=sine window, 1=Kaiser-Bessel derived (KBD) window. The function will return an error if this parameter is not equal to either 0 or 1.
- `pWindowedBuf` – work buffer; minimum length 2048 elements

#### Output Arguments

- `pDst` – pointer to MDCT output sequence; coefficients are represented using Q28.3

## Returns

- OMX\_Sts\_NoErr – no error
- OMX\_Sts\_BadArgErr – bad arguments
  - one or more of the following pointers is NULL: pSrc, pDst, or pWindowedBuf
  - winShape is outside the range [0,1]
  - preWinShape is outside the range [0,1]
  - winSequence == 2 (eight\_short\_sequence/short\_window)

### 3.2.3.7.3 EncodeTNS\_S32\_I

## Prototype

```
OMXResult omxACAAC_EncodeTNS_S32_I(OMX_S32 *pSrcDstSpectralCoefs, const
    OMX_INT *pTnsNumFilt, const OMX_INT *pTnsRegionLen, const OMX_INT
    *pTnsFiltOrder, const OMX_INT *pTnsFiltCoefRes, const OMX_S8
    *pTnsFiltCoef, const OMX_INT *pTnsDirection, OMX_INT maxSfb, OMX_INT
    profile, OMX_INT samplingRateIndex);
```

## Description

This function applies a TNS analysis (encoding) filter to spectral coefficients in the LTP feedback loop for one channel.

## Reference

[ISO14496-3], sub-clause 4.6.9

## Input Arguments

- pSrcDstSpectralCoefs – pointer to the unprocessed spectral coefficient vector for one channel; coefficients are represented using Q28.3
- pTnsNumFilt – pointer to a table containing the number of TNS filters that are applied on each window of the current frame for the current channel. The table elements are indexed as follows:
  - pTnsNumFilt[w]  
w=0 to numWin-1; depending upon the current window sequence, this vector may contain up to 8 elements
- pTnsRegionLen – pointer to a table containing TNS region lengths (in scalefactor band units) for all regions and windows on the current frame for the current channel; the table entry pTnsRegionLen[i] specifies the region length for k-th filter on the w-th window. The table index, i, is computed as follows:

$$i = \sum_{j=0}^{w-1} pTnsNumFilt[j] + k$$

where  $0 \leq w \leq \text{numWin}-1$ , and  $0 \leq k \leq pTnsNumFilt[w]-1$ .

- `pTnsFiltOrder` – pointer to a table containing TNS filter orders for all regions and windows on the current frame for the current channel; the table entry `pTnsFiltOrder[i]` specifies the TNS filter order for the  $k$ -th filter on the  $w$ -th window. The table index,  $i$ , is computed as follows:

$$i = \sum_{j=0}^{w-1} pTnsNumFilt[j] + k$$

where  $0 \leq w \leq \text{numWin}-1$ , and  $0 \leq k \leq pTnsNumFilt[w]-1$ .

- `pTnsFiltCoefRes` – pointer to a table of TNS filter coefficient resolution indicators for each window on the current frame for the current channel. Resolutions for filters on the  $w$ -th window are specified in table entry `pTnsFiltCoefRes[w]`, and  $w=0$  to  $\text{numWin}-1$ .
- `pTnsFiltCoef` – pointer to a table containing the complete set of TNS filter coefficients for all windows and regions on the current frame for the current channel. Filter coefficients are stored contiguously in filter-major order, i.e., the table is organized such that the filter coefficients for the  $k$ -th filter of the  $w$ -th window are indexed using `pTnsFiltCoef[w][k][i]`, where  $0 \leq i \leq pTnsFiltOrder[j]-1$ ,  $0 \leq k \leq pTnsNumFilt[w]-1$ ,  $0 \leq w \leq \text{numWin}-1$ , and the filter order index  $j$  is computed as shown above.
- `pTnsDirection` – pointer to a table of tokens that indicate the direction of TNS filtering for all regions and windows on the current frame, with 0 indicating upward and 1 indicating downward; in particular the table entry `pTnsDirection[i]` specifies direction for  $k$ -th filter on the  $w$ -th window, and the table index,  $i$ , is computed as follows:

$$i = \sum_{j=0}^{w-1} pTnsNumFilt[j] + k$$

where  $0 \leq w \leq \text{numWin}-1$ , and  $0 \leq k \leq pTnsNumFilt[w]-1$ .

- `maxSfb` – number of scalefactor bands
- `profile` – audio profile
- `samplingRateIndex` – sampling rate index

## Output Arguments

- `pSrcDstSpectralCoefs` – pointer to the TNS-encoded spectral coefficient vector; coefficients are represented using Q28.3

## Returns

- `OMX_Sts_NoErr` – no error
- `OMX_StsACAAC_MaxSfbErr` – invalid `maxSfb` value in relation to `numSwb`
- `OMX_Sts_BadArgErr` – bad arguments
  - at least one of the pointers: `pSrcDstSpectralCoefs`, `pTnsNumFilt`, `pTnsRegionLen`, `pTnsFiltOrder`, `pTnsFiltCoefRes`, `pTnsFiltCoef` or `pTnsDirection` is NULL
  - `samplingRateIndex` exceeds [0,12]
  - `maxSfb` not in [0,51]

### 3.2.3.7.4 LongTermPredict\_S32

#### Prototype

```
OMXResult omxACAAC_LongTermPredict_S32(OMX_S32 *pSrcTimeSignal, OMX_S32
    *pDstEstTimeSignal, OMXAACLtpInfo *pACLtpInfo);
```

#### Description

LTP analysis portion of the LTP loop.

#### Reference

[ISO14496-3], sub-clause 4.6.7

#### Input Arguments

- `pSrcTimeSignal` – pointer to the time-domain sequence to be predicted; samples are represented using Q28.3
- `pACLtpInfo` – pointer to the LTP configuration information

#### Output Arguments

- `pDstEstTimeSignal` – pointer to the LTP output sequence; samples are represented using Q28.3

#### Returns

- `OMX_Sts_NoErr` – no error
- `OMX_Sts_BadArgErr` – bad arguments:
  - one or more of the following pointers is NULL: `pSrcDstTime`, `pACLtpInfo`, or `pDstEstTimeSignal`
  - the value of the parameter `pACLtpInfo->ltpCoef` does not lie in the range [ 9352, 22438 ]

### 3.2.3.8 Huffman Decoding

#### 3.2.3.8.1 NoiselessDecode

#### Prototype

```
OMXResult omxACAAC_NoiselessDecode(const OMX_U8 **ppBitStream, OMX_INT
    *pOffset, OMX_S16 *pDstScalefactor, OMX_S32 *pDstQuantizedSpectralCoef,
    OMX_U8 *pDstSfbCb, OMX_S8 *pDstTnsFiltCoef, OMXAACChanInfo *pChanInfo,
    OMX_INT commonWin, OMX_INT audioObjectType, OMXAACLtpInfo *pLtpInfo);
```

#### Description

Noiseless decoder for a single channel of AAC LC and LTP audio objects. Extracts side information, scalefactor information, quantized spectral coefficients, TNS parameters, and LTP parameters from the input stream for one channel and places the contents into the arrays referenced by the parameters

pChanInfo, pDstScalefactor, pDstQuantizedSpectralCoef, pDstTnsFiltCoef, and pLtpInfo, respectively. Individual output structure member update dependencies on elementary stream properties are specified below under “Output Arguments” for each parameter.

## Reference

[ISO14496-3], sub-clause 4.6.3

## Input Arguments

- ppBitStream – double pointer to current byte in the input bitstream
- pOffset – pointer to the offset indicating the next available bit in the current byte of the input bitstream; valid in the range [0,7].
- pChanInfo – pointer to the channel information structure; the structure member samplingRateIndex must contain valid information prior to calling this function. The remaining structure members are updated upon return as described under “Output Arguments.”
- commonWin – commonWin==1 indicates that the channel pair uses the same individual channel stream information (ICS); commonWin==0 indicates that ICS is not shared across a channel pair.
- audioObjectType – audio object type indicator: 2=LC, 4=LTP

## Output Arguments

- ppBitStream – double pointer to the updated stream pointer; references the current byte in the input bitstream after Huffman decoding has been completed
- pOffset – pointer to the updated bit index indicating the next available bit in the input stream following after Huffman decoding has been completed
- pChanInfo – pointer to the updated channel information structure. NoiselessDecode updates all members of this structure, with the following exceptions: i) the following members are never updated by this function: tag, id, predSfbMax, preWinShape, and pChanPairElt; ii) if commonWin==1 then the contents of ICS structure \*(pChanInfo->pIcsInfo) are not modified (for the common window case, refer to function omxACAAC\_DecodeChanPairElt); iii) if commonWin==0 then all members of the ICS structure \*(pChanInfo->pIcsInfo) are modified unconditionally except as shown in Table 3-11, and only the first pIcsInfo->numWinGrp elements in pIcsInfo->pWinGrpLen are updated; iv) only elements 0, 1, 2,...pIcsInfo->maxSfb-1 of arrays pSectCb[.] and pSectEnd[.] are updated; v) only elements 0, 1, 2, ..., pIcsInfo->numWinGrp of arrays pMaxSect[.], pTnsNumFilt[.], and pTnsFiltCoefRes[.] are updated; vi) only elements 0, 1, 2, ..., sum(pTnsNumFilt[i]) for i = 0, 1, ..., (pIcsInfo->numWinGrp)-1 are updated for arrays pTnsRegionLen[.], pTnsFilterOrder[.], and pTnsDirection[.]. The updated TNS parameters returned in the TNS parameter arrays pTnsNumFilt, pTnsFiltCoefRes, pTnsRegionLen, pTnsFiltOrder, and pTnsDirection are organized as described in the corresponding input parameter descriptions given in section 3.2.7.2.3 (EncodeTNS\_S32\_I).
- pDstScalefactor – pointer to the updated scalefactor table; the buffer must have sufficient space to contain up to 120 scalefactor elements.
- pDstQuantizedSpectralCoef – pointer to the 1024-element array containing the decoded, quantized spectral coefficients, all of which are integer values represented using Q0, i.e., no scaling.
- pDstSfbCb – pointer to the updated table of scalefactor band codebook indices; the buffer must have sufficient space to contain up to 120 SFB codebook indices.

- `pDstTnsFiltCoef` – pointer to the updated table containing the complete set of TNS filter coefficients for all windows and regions on the current channel. Filter coefficients are stored contiguously in filter-major order, i.e., the table is organized such that the filter coefficients for the  $k$ -th filter of the  $w$ -th window are indexed using `pTnsFiltCoef[w][k][i]`, where  $0 \leq i \leq \text{pTnsFiltOrder}[j]-1$ ,  $0 \leq k \leq \text{pTnsNumFilt}[w]-1$ ,  $0 \leq w \leq \text{numWin}-1$ , and the filter order index,  $j$ , is computed as described in section 3.2.7.2.3 (EncodeTNS\_S32\_I) under the `pTnsFiltOrder` input parameter description.
- `pLtpInfo` – pointer to the LTP information structure associated with the current channel; updated only if `(pChanPairElt->CommonWin == 0) && (audioObjectType==4)` and the elementary stream bit field `predictor_data_present==1`. Otherwise, if `(pChanPairElt->CommonWin == 1) || (audioObjectType!=4) || predictor_data_present==0` then the function `omxACAAC_NoiselessDecode` will not update the contents of the structure `*pLtpInfo`. The LTP information structure will be updated by the function `omxACAAC_DecodeChanPairElt` if `(pChanPairElt->CommonWin == 1) && (audioObjectType==4)`. Reference: [ISO14496-3], sub-clause 4.4.2.1 and Tables 4.5 4.6.

**Table 3-11: \*(pChanInfo->plcsInfo) Members Modified Conditionally by NoiselessDecoder When Input Parameter commonWin==0**

| Members           | Required Condition                                       |
|-------------------|--|
| SfGrouping        | <code>pChanInfo-&gt;plcsInfo-&gt;winSequence == 2</code> |
| predReset         | Never modified   |
| predResetGroupNum | Never modified   |
| pPredUsed[]       | Never modified   |

### Returns

- `OMX_Sts_NoErr` – no error
- `OMX_Sts_BadArgErr` – bad arguments
  - at least one of the pointers: `ppBitStream`, `pOffset`, `*ppBitStream`, `pDstScaleFactor`, `pDstTnsFiltCoef`, `pDstQuantizedSpectralCoef`, `pChanInfo` or `pDstSfbCb` is NULL.
  - `*pOffset` exceeds `[0,7]`
  - `commonWin` exceeds `[0,1]`
  - `audioObjectType` is not equal to either 2 or 4
  - `commonWin==1` and `pChanInfo->pIcsInfo->winSequence` exceeds `[0,3]`
- `OMX_Sts_InvalidBitstreamValErr` – invalid bitstream parameter value detected
  - `commonWin==0` and the decoded value of `pChanInfo->pIcsInfo->maxSfb` is out of range, i.e., exceeds `[0,51]`

- `OMX_StsACAAC_PlsDataErr` - pulse data error; returned if one or more of the following conditions is true: i) pulse data is present during a short window sequence, i.e., `pChanInfo->pIcsInfo->winSequence==EIGHT_SHORT_SEQUENCE` && `pChanInfo->pulsePres==1`;  
ii) the start scalefactor band for pulse data (`pulse_start_sfb`) is out of range, i.e., `(pulse_start_sfb >= pChanInfo->numSwb) || (pulse_start_sfb >= 51)`; iii) pulse data position offset (`pulse_offset[i]`), is out of range, i.e., `pulse_offset[i] >= pChanInfo->winLen`. Reference: [ISO14496-3], sub-clause 4.6.3.
- `OMX_StsACAAC_GainCtrErr` - `pChanInfo->gainContrDataPres==1`.



# 4.0 Image Processing

## 4

This section describes the functions and data types that comprise the OpenMAX DL image processing domain (omxIP) API, including functions that support bitmap manipulation (omxIPBM), image pre- and post-processing (omxIPPP), and color space conversion (omxIPCS).

## 4.1 Common Definitions

This section defines constants, data structures, buffer organizations, and image processing conventions that shall be followed for all image processing sub-domains.

### 4.1.1 Image Representation

The image processing domain supports absolute color images in which each pixel is represented by its channel intensities. The data storage for an image can be either pixel-orientation (also called interleaved format) or plane-oriented (also called planar format). For images in pixel-oriented, all channel values for each pixel are clustered and stored consecutively. For example, BGRBGRBGR..... for an RGB image. The number of channels in a pixel-oriented image can be one, two, or three (the fourth channel alpha channel is not currently supported) and is identified by the function name descriptor C1, C2, or C3. As a special case, the C2 designator is used with pixel-oriented YCbCr422 data even though the Cb and Cr channels are strictly speaking distinct and there are in fact three channels. This convention is adopted because the pixels are organized in memory as shown in Table 4-1, i.e., Y-Cb-Y-Cr. Also as shown in Table 4-1, the name BGR indicates that the data are stored in BGR order.

For example, in function

```
omxIPCS_BGRToYCbCr_C3R(const OMX_U8* pSrc, OMX_INT srcStep, OMX_U8*
pDst, OMX_INT dstStep, OMXSize roiSize),
```

both input and output are in C3 format. The input pointer `pSrc` will point to data formatted as BGRBGRBGR....., and similarly output pointer `pDst` will point to data formatted as YCbCrYCbCrYCbCr....

For planar images, all image data for each channel is stored contiguously. Functions that operate on planar images are identified by the presence of P3 descriptor. In this case, three pointers (one for each plane) are specified.

For example, in function

```
omxIPCS_BGRToYCbCr_C3P3R( const OMX_U8 *pSrc, OMX_INT srcStep,
                           OMX_U8 *pDst[3], OMX_INT dstStep,
                           OMXSize roiSize )
```

the descriptor “C3P3” means that the input is in pixel-oriented format (3 channels) and output is in planar format (3 channels). Therefore input pointer `pSrc` will point to data block BGRBGRBGR..... The output pointer `pDst[0]` will point to data block YYY....., the output pointer `pDst[1]` will point to data block

CbCbCb....., and the output pointer `pDst [ 2 ]` will point to data block CrCrCr.

The image data type is determined by the pixel depth in bits per channel, or bit depth. Bit depth for each channel can be 8, 16 or 32 and is included in the function name as one of these numbers. The data type may be signed (s) or unsigned (u). All channels in an image must have the same data type.

For example, in an absolute color 24-bit RGB image, three consecutive bytes (24 bits) per pixel represent the three channel intensities in pixel mode. This data type is identified in function names as `U8_C3` descriptor, where `U8` represents 8-bit unsigned data for each channel and `C3` represents three channels.

The tables below define how buffers in memory are organized for the interleaved and planar representations of the various color spaces supported in the `omxIP`, `omxIC`, and `omxVC` domains. These memory organizations shall be followed unless otherwise specified in the description for a particular function or function set.

**Table 4-1: Memory Organization for Interleaved (Pixel-Oriented) Color Space Data**

| Color Space | Byte Address | Bit 7            | Bit 6            | Bit 5            | Bit 4            | Bit 3            | Bit 2            | Bit 1            | Bit 0            |
|-------------|--------------|------------------|------------------|------------------|------------------|------------------|------------------|------------------|------------------|
| BGR565      | Base+0x0     | G                | G                | G                | B                | B                | B                | B                | B                |
|             | Base+0x1     | R                | R                | R                | R                | R                | G                | G                | G                |
| BGR444      | Base+0x0     | G                | G                | G                | G                | B                | B                | B                | B                |
|             | Base+0x1     | 0                | 0                | 0                | 0                | R                | R                | R                | R                |
| BGR555      | Base+0x0     | G                | G                | G                | B                | B                | B                | B                | B                |
|             | Base+0x1     | 0                | R                | R                | R                | R                | R                | G                | G                |
| BGR888      | Base+0x0     | B                | B                | B                | B                | B                | B                | B                | B                |
|             | Base+0x1     | G                | G                | G                | G                | G                | G                | G                | G                |
|             | Base+0x2     | R                | R                | R                | R                | R                | R                | R                | R                |
| YCbCr444    | Base+0x0     | Y                | Y                | Y                | Y                | Y                | Y                | Y                | Y                |
|             | Base+0x1     | Cb               | Cb               | Cb               | Cb               | Cb               | Cb               | Cb               | Cb               |
|             | Base+0x2     | Cr               | Cr               | Cr               | Cr               | Cr               | Cr               | Cr               | Cr               |
| YCbYCr422   | Base+0x0     | Y <sub>0</sub>   | Y <sub>0</sub>   | Y <sub>0</sub>   | Y <sub>0</sub>   | Y <sub>0</sub>   | Y <sub>0</sub>   | Y <sub>0</sub>   | Y <sub>0</sub>   |
|             | Base+0x1     | Cb <sub>01</sub> | Cb <sub>01</sub> | Cb <sub>01</sub> | Cb <sub>01</sub> | Cb <sub>01</sub> | Cb <sub>01</sub> | Cb <sub>01</sub> | Cb <sub>01</sub> |
|             | Base+0x2     | Y <sub>1</sub>   | Y <sub>1</sub>   | Y <sub>1</sub>   | Y <sub>1</sub>   | Y <sub>1</sub>   | Y <sub>1</sub>   | Y <sub>1</sub>   | Y <sub>1</sub>   |
|             | Base+0x3     | Cr <sub>01</sub> | Cr <sub>01</sub> | Cr <sub>01</sub> | Cr <sub>01</sub> | Cr <sub>01</sub> | Cr <sub>01</sub> | Cr <sub>01</sub> | Cr <sub>01</sub> |
|             | Base+0x4     | Y <sub>2</sub>   | Y <sub>2</sub>   | Y <sub>2</sub>   | Y <sub>2</sub>   | Y <sub>2</sub>   | Y <sub>2</sub>   | Y <sub>2</sub>   | Y <sub>2</sub>   |
|             | Base+0x5     | Cb <sub>23</sub> | Cb <sub>23</sub> | Cb <sub>23</sub> | Cb <sub>23</sub> | Cb <sub>23</sub> | Cb <sub>23</sub> | Cb <sub>23</sub> | Cb <sub>23</sub> |
|             | Base+0x6     | Y <sub>3</sub>   | Y <sub>3</sub>   | Y <sub>3</sub>   | Y <sub>3</sub>   | Y <sub>3</sub>   | Y <sub>3</sub>   | Y <sub>3</sub>   | Y <sub>3</sub>   |
|             | Base+0x7     | Cr <sub>23</sub> | Cr <sub>23</sub> | Cr <sub>23</sub> | Cr <sub>23</sub> | Cr <sub>23</sub> | Cr <sub>23</sub> | Cr <sub>23</sub> | Cr <sub>23</sub> |
| CbYCrY422   | Base+0x0     | Cb <sub>01</sub> | Cb <sub>01</sub> | Cb <sub>01</sub> | Cb <sub>01</sub> | Cb <sub>01</sub> | Cb <sub>01</sub> | Cb <sub>01</sub> | Cb <sub>01</sub> |
|             | Base+0x1     | Y <sub>0</sub>   | Y <sub>0</sub>   | Y <sub>0</sub>   | Y <sub>0</sub>   | Y <sub>0</sub>   | Y <sub>0</sub>   | Y <sub>0</sub>   | Y <sub>0</sub>   |
|             | Base+0x2     | Cr <sub>01</sub> | Cr <sub>01</sub> | Cr <sub>01</sub> | Cr <sub>01</sub> | Cr <sub>01</sub> | Cr <sub>01</sub> | Cr <sub>01</sub> | Cr <sub>01</sub> |
|             | Base+0x3     | Y <sub>1</sub>   | Y <sub>1</sub>   | Y <sub>1</sub>   | Y <sub>1</sub>   | Y <sub>1</sub>   | Y <sub>1</sub>   | Y <sub>1</sub>   | Y <sub>1</sub>   |
|             | Base+0x4     | Cb <sub>23</sub> | Cb <sub>23</sub> | Cb <sub>23</sub> | Cb <sub>23</sub> | Cb <sub>23</sub> | Cb <sub>23</sub> | Cb <sub>23</sub> | Cb <sub>23</sub> |
|             | Base+0x5     | Y <sub>2</sub>   | Y <sub>2</sub>   | Y <sub>2</sub>   | Y <sub>2</sub>   | Y <sub>2</sub>   | Y <sub>2</sub>   | Y <sub>2</sub>   | Y <sub>2</sub>   |
|             | Base+0x6     | Cr <sub>23</sub> | Cr <sub>23</sub> | Cr <sub>23</sub> | Cr <sub>23</sub> | Cr <sub>23</sub> | Cr <sub>23</sub> | Cr <sub>23</sub> | Cr <sub>23</sub> |
|             | Base+0x7     | Y <sub>3</sub>   | Y <sub>3</sub>   | Y <sub>3</sub>   | Y <sub>3</sub>   | Y <sub>3</sub>   | Y <sub>3</sub>   | Y <sub>3</sub>   | Y <sub>3</sub>   |

Note on YCbCr422 organization: The entries in the YCbCr422 table correspond to pixels as they appear in raster-scan order, i.e., the  $Y_0$  pixel occupies the left-most position, followed by  $Y_1, Y_2, Y_3, \dots$  scanning from left to right, and the subscripts are intended to convey the associations between luminance and sub-sampled chrominance components. The luminance pixels  $Y_0$  and  $Y_1$  are paired with the sub-sampled chrominance pixels  $Cb_{01}$  and  $Cr_{01}$ , and the luminance pixels  $Y_2$  and  $Y_3$  are paired with the sub-sampled chrominance pixels  $Cb_{23}$  and  $Cr_{23}$ .

**Table 4-2: Memory Organization for Planar Color Space Data**

|          |                 |          |
|----------|-----------------|----------|
| YCbCrxxx | pSrc[0]/pDst[0] | Y block  |
|          | pSrc[1]/pDst[1] | Cb block |
|          | pSrc[2]/pDst[2] | Cr block |

### 4.1.2 Image Processing Models

Most omxIP functions perform identical and independent operations on all channels of the processed image. The same operation is applied to each channel, and the computed results do not depend upon values of other channels. The only exceptions are the color conversion functions, which process three channels together.

### 4.1.3 Neighborhood Operations

The result of a neighborhood operation is based on values of a certain group of pixels, located near a given input pixel. The set of neighboring pixels is typically defined by the size of rectangular mask (or kernel) and anchor cell, specifying the mask alignment with respect to the position of the input pixel.

The omxIP functions that process a neighborhood operate on the assumption that all referred points of the image are available. To support this mode, the application must check that ROI parameters passed to the function have such values that all processed neighborhood pixels actually exist in the image.

The following are examples of functions that perform neighborhood operations.

- `omxIPPP_FilterMedian`

### 4.1.4 Rectangle or Region of Interest

Some omxIP functions can operate not only on entire images but also on a part of the image. The Region of Interest or Rectangle of Interest (ROI) are rectangular areas which may be either some part of the image or the whole image.

The omxIP functions with ROI support are distinguished by the presence of an R descriptor in their names. ROI of an image is defined by the size and offset from the image's origin as shown in Figure 4-1. The origin of an image is implied to be in the top left corner, with x values increasing from left to right and y values increasing downwards.

Both the source and destination images can have a rectangle of interest. In such cases, the sizes of ROIs are assumed to be the same while offsets may differ. The image processing is then performed on data of the source ROI, and the results are written to the destination ROI. In function call sequences, an ROI is specified by:

- `roiSize` argument of the `OMXSize` type

- pSrc and pDst pointers to the starts of source and destination ROI buffers
- srcStep and dstStep arguments which are equal to distances in bytes between the starts of consecutive lines in source and destination images, respectively.

Thus, the arguments srcStep, dstStep set steps in bytes through image buffers to start processing a new line in the ROI of an image

**Figure 4-1: Image, ROI, and Offsets**

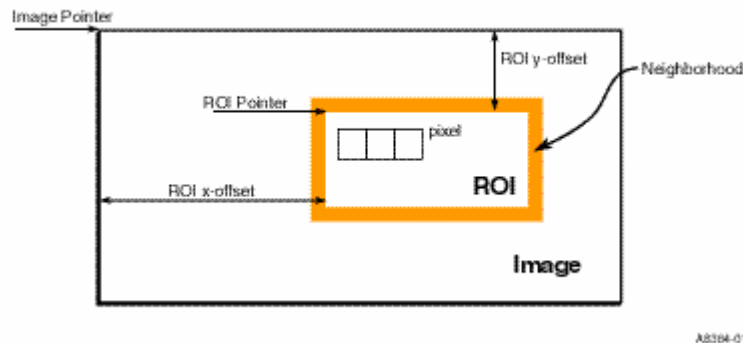

## 4.1.5 Data Types and Enumerators

### 4.1.5.1 Rotations

OMXIPRotation, a data type that enumerates image rotations, is defined as follows:

```
typedef enum {
    OMX_IP_DISABLE = 0,
    OMX_IP_ROTATE90L = 1,           /* counter-clockwise */
    OMX_IP_ROTATE90R = 2,          /* clockwise */
    OMX_IP_ROTATE180 = 3,
    OMX_IP_FLIP_HORIZONTAL = 4,    /* from R to L, about V axis */
    OMX_IP_FLIP_VERTICAL = 5,     /* from top to bottom, about H axis */
} OMXIPRotation;
```

Counter-clockwise rotation is denoted by the “L” postfix, and clockwise rotation is denoted by the “R” postfix. A horizontal flip creates a “mirror” image with respect to the vertical image axis, i.e.,

**ROT** →horizontal flip→ **TOR**

and a vertical flip creates a “mirror” image with respect to the horizontal image axis, i.e.,

**ROT** →vertical flip→ **BOI**

### 4.1.5.2 Moment States

The `OMXMomentState` data structure is used by the image moment functions to store intermediate computational results. It is defined as follows:

```
typedef void OMXMomentState;
```

Structure contents may be implementation-dependent.

## 4.2 Bitmap Manipulation Sub-Domain (omxIPBM)

This section defines functions that perform image data set and initialization operations, including functions that support bitmap copy, add, and multiply operations.

### 4.2.1 Functions

#### 4.2.1.1 Block Copy

##### 4.2.1.1.1 Copy\_U8\_C1R

##### 4.2.1.1.2 Copy\_U8\_C3R

#### Prototype

```
OMXResult omxIPBM_Copy_U8_C1R(const OMX_U8 *pSrc, OMX_INT srcStep, OMX_U8  
    *pDst, OMX_INT dstStep, OMXSize roiSize);
```

```
OMXResult omxIPBM_Copy_U8_C3R(const OMX_U8 *pSrc, OMX_INT srcStep, OMX_U8  
    *pDst, OMX_INT dstStep, OMXSize roiSize);
```

#### Description

Copy pixel values from the ROI of the source image referenced by the pointer `pSrc` to the ROI of the destination image referenced by the pointer `pDst`. The source ROI should not overlap the destination ROI within the same image buffer.

#### Input Arguments

- `pSrc` – pointer to the source ROI
- `srcStep` – distance in bytes between the starts of consecutive lines in the source image
- `dstStep` – distance in bytes between the starts of consecutive lines in the destination image
- `roiSize` – size of the source and destination ROI in pixels

#### Output Arguments

- `pDst` – pointer to the destination ROI

## Returns

- `OMX_Sts_NoErr` – no errors detected
- `OMX_Sts_BadArgErr` – bad arguments detected; at least one of the following is true:
  - `pSrc` or `pDst` is `NULL`
  - `srcStep` or `dstStep` is less than or equal to zero
  - `roiSize` has a field with zero or negative value.

The following example describes a simple initialization routine. The following example describes how to copy one image to another.

### Example 4-1: Copying One Image to Another

```
int main()
{
    /* One-channel source and destination images */
    const OMX_INT SIDE = 16;
    OMX_U8 src[SIDE*SIDE];
    OMX_U8 dst[SIDE*SIDE];
    OMXSize imgSize = {SIDE,SIDE};

    /* Init source image here */

    /* Specify ROI location and size */
    OMXPoint srcROIlocation = {2,2};
    OMXPoint dstROIlocation = {1,1};
    OMXSize dstROIsize = {7,7};

    /* Copy source ROI to the destination */
    omxIPBM_Copy_U8_C1R(AddressOf(src,SIDE,srcROIlocation), SIDE,
    AddressOf(dst,SIDE,dstROIlocation), SIDE, dstROIsize);

    /* Print result */
    OMXSize showSize = {9,9};
    PrintROI_C1(_T("Example: OMXCopy"), dst, SIDE, showSize);
    return 0;
}
/*
 * Returns address of ROI
 */
OMX_U8* AddressOf(OMX_U8* pImg, OMX_INT sLine, OMXPoint aLocation)
{
```

```

    return pImg +sLine*aLocation.y +aLocation.x;
}

```

### 4.2.1.2 Arithmetic

Bitmap arithmetic operators are defined in the table below. Rounding behavior follows the conventions defined in section 1.6.7.

**Table 4-3: Arithmetic Operators**

| Operation | Description  |
|-----------|--|
| AddC      | <p>Add a constant with scaling and saturation, i.e.,</p> $Z_{n,m} = SAT_{U8}((x_{n,m} + c) * 2^{-S})$ <p>where the parameter x is the input image, the parameters n and m are the pixel indices, the parameter c is the constant value to be added to each pixel, the parameter S is the scalefactor, SAT denotes saturation to an unsigned 8-bit result, and the parameter Z is the output image.</p>                 |
| MulC      | <p>Multiply by a constant with scaling and saturation, i.e.,</p> $Z_{n,m} = SAT_{U8}((x_{n,m} * c) * 2^{-S})$ <p>where the parameter x is the input image, the parameters n and m are the pixel indices, the parameter c is the constant value by which each pixel is multiplied, the parameter S is the scalefactor, SAT denotes saturation to an unsigned 8-bit result, and the parameter Z is the output image.</p> |

#### 4.2.1.2.1 AddC\_U8\_C1R\_Sfs

#### 4.2.1.2.2 MulC\_U8\_C1R\_Sfs

##### Prototype

```

OMXResult omxIPBM_AddC_U8_C1R_Sfs(const OMX_U8 *pSrc, OMX_INT srcStep,
    OMX_U8 value, OMX_U8 *pDst, OMX_INT dstStep, OMXSize roiSize, OMX_INT
    scaleFactor);

```

```

OMXResult omxIPBM_MulC_U8_C1R_Sfs(const OMX_U8 *pSrc, OMX_INT srcStep,
    OMX_U8 value, OMX_U8 *pDst, OMX_INT dstStep, OMXSize roiSize, OMX_INT
    scaleFactor);

```

## Description

Computes corresponding arithmetic operation with a constant and each element of the source ROI and places the scaled result in the destination image referenced by the pointer `pDst`.

## Input Arguments

- `pSrc` – pointer to the source ROI
- `srcStep` – distance in bytes between the starts of consecutive lines in the source image
- `value` – constant for operation
- `dstStep` – distance in bytes between the starts of consecutive lines in the destination image
- `roiSize` – size of the source and destination ROI in pixels
- `scaleFactor` – scale factor value, valid in the range `[-7,7]`

## Output Arguments

- `pDst` – pointer to the destination ROI

## Returns

- `OMX_Sts_NoErr` – no errors detected
- `OMX_Sts_BadArgErr` – bad arguments detected; at least one of the following is true:
  - `pSrc` or `pDst` is `NULL`
  - `srcStep` or `dstStep` is less than or equal to zero
  - `roiSize` has a field with zero or negative value.
  - `scaleFactor` is outside the range `[-7,7]`

## 4.2.1.3 Mirror

### 4.2.1.3.1 Mirror\_U8\_C1R

#### Prototype

```
OMXResult omxIPBM_Mirror_U8_C1R(const OMX_U8 *pSrc, OMX_INT srcStep, OMX_U8 *pDst, OMX_INT dstStep, OMXSize roiSize, OMXIPRotation axis);
```

#### Description

This function mirrors the source image `pSrc` about a horizontal or vertical axis or both, depending on the value of the parameter `axis`, and writes it to the destination image `pDst`.

#### Input Arguments

- `pSrc` – pointer to the source buffer
- `srcStep` – distance in bytes between the starts of consecutive lines in the source image
- `dstStep` – distance in bytes between the starts of consecutive lines in the destination image
- `roiSize` – size of the source and destination ROI in pixels.
- `axis` – specifies the axis about which to mirror the image. Must use one of the following `OMXIPRotation` values:



- OMX\_IP\_FLIP\_HORIZONTAL to mirror about the vertical axis
- OMX\_IP\_FLIP\_VERTICAL to mirror about the horizontal axis
- OMX\_IP\_ROTATE180 to mirror about both horizontal and vertical axes

### Output Arguments

- pDst – pointer to the destination buffer

### Returns

- OMX\_Sts\_NoErr – no errors detected
- OMX\_Sts\_BadArgErr – bad arguments detected; at least one of the following is true:
  - pSrc or pDst is NULL
  - srcStep or dstStep is less than or equal to zero
  - roiSize has a field with zero or negative value.
  - axis contains an illegal value

## 4.3 Pre- and Post-Processing Sub-Domain (omxIPPP)

This section defines functions that perform image pre- and post-processing operations.

### 4.3.1 Functions

#### 4.3.1.1 Filtering

This section describes image processing functions that perform linear and non-linear filtering operations on an image. The tables below provide detailed mathematical definitions of supported filtering operations.

**Table 4-4: FIR Filtering Definition**

| Operation             | Description   |
|-----------------------|---|
| General FIR filtering | <p>Filters an image using a general rectangular convolution kernel. Basic equation of general 2D filter is the following:</p> $y_{n,m} = \Psi_{2D}(h, a, x) \equiv \sum_{i=0}^{H-1} \sum_{j=0}^{W-1} h_{i,j} \cdot x_{n+ay-i, m+ax-j}$ <p>where:</p> <p><math>h</math> 2D kernel of <math>W \times H</math> size with anchor location <math>(ay, ax)</math></p> <p><math>x_{n,m}</math> and <math>y_{n,m}</math> are input and output signals respectively.</p> |

**Table 4-5: Median Filtering Definition**

| Operation                   | Description   |
|-----------------------------|---|
| single-channel (gray) image | <p>Filters an image using a median filter, defined as</p> $y = MED_{(W \times H)}(x, a, ROI)$ <p>where the parameter <math>x</math> is the input image, the parameter <math>y</math> is the output image, the parameter <math>a</math> specifies the anchor, the parameters <math>W</math> and <math>H</math> specify the width and height, respectively, of the mask, the parameter <math>ROI</math> specifies the region of interest in the input image <math>x</math>, and the parameter <math>a</math> defines the mask anchor point, which is specified in terms of coordinates <math>a.x</math> and <math>a.y</math>. The median filter operator, <math>MED</math>, generates an output image of dimension <math>W \times H</math>. Each output pixel takes the median value of the masked region associated with the corresponding pixel from the input <math>ROI</math>. Median values are computed as follows: for each <math>ROI</math> input pixel, the top-left corner of the mask is offset and overlaid according to <math>(a.x, a.y)</math>. Next, the median is identified within the masked region. For a mask of dimension <math>W \times H</math>, the <math>W \times H</math> pixels are ordered in terms of intensity from smallest to largest and the value of the median (middle) element is returned as output. If <math>W \times H</math> is odd then the median will be the <math>(W \times H + 1) / 2</math> entry in the list of ordered pixels.</p> <p>The median filter operation can also be described in terms of a distance minimization. In particular, the median filtered output pixels <math>y_{n,m}</math> can be expressed in terms of the input pixels, <math>x_{n,m}</math>, as follows</p> $MED_{(W \times H)}(x, a, ROI) \equiv y_{n,m} = x_{n-a.y+r_M(n,m), m-a.x+c_M(n,m)}$ <p>where the parameters <math>a.x</math> and <math>a.y</math> define the anchor point, the parameters <math>n</math> and <math>m</math> are the indices of the input and output images, and the parameters <math>r_M(n,m)</math> and <math>c_M(n,m)</math> reflect, respectively, the values of the parameters <math>r</math> and <math>c</math> that minimize for the pixel in location <math>n,m</math> the magnitude of the distance measure <math>\Psi_{r,c}</math>, defined as</p> $\Psi_{r,c} = \sum_{i=0}^{H-1} \sum_{j=0}^{W-1}  x_{n-a.y+r, m-a.x+c} - x_{n-a.y+i, m-a.x+j} $ <p>The search is bounded by the mask region, i.e., <math>0 \leq r \leq H - 1</math> and <math>0 \leq c \leq W - 1</math>.</p> |

#### 4.3.1.1.1 FilterFIR\_U8\_C1R

##### Prototype

```
OMXResult omxIPPP_FilterFIR_U8_C1R(const OMX_U8 *pSrc, OMX_INT srcStep,
    OMX_U8 *pDst, OMX_INT dstStep, OMXSize roiSize, const OMX_S32 *pKernel,
    OMXSize kernelSize, OMXPoint anchor, OMX_INT divider);
```

## Description

Performs filtering of the ROI of the source image pointed to by `pSrc` using a general rectangular (WxH size) convolution kernel. The value of the output pixel is normalized by the divider and saturated as:

$$SAT_{U8}\left(\frac{1}{divider}\Psi_{2D}(h,a,x)\right)$$

The result is placed into the ROI of the destination image pointed to by `pDst`.

## Input Arguments

- `pSrc` – pointer to the source ROI
- `srcStep` – distance in bytes between the starts of consecutive lines in the source image
- `dstStep` – distance in bytes between the starts of consecutive lines in the destination image
- `roiSize` – size of the source and destination ROI in pixels
- `pKernel` – pointer to the 2D FIR filter coefficients
- `kernelSize` – size of the FIR filter kernel. The minimum valid size is 1x1. There is no limit on the maximum size other than the practical limitation imposed by the ROI size and location relative to the image boundaries. The caller should avoid kernel overlap with invalid buffer locations given ROI size, ROI placement relative to the image buffer boundaries, and the FIR operator definition given in Table 4-4.
- `anchor` – anchor cell specifying the alignment of the array of filter taps with respect to the position of the input pixel
- `divider` – value of the divider used to normalize the result

## Output Arguments

- `pDst` – pointer to the destination ROI

## Returns

- `OMX_Sts_NoErr` – no errors detected
- `OMX_Sts_BadArgErr` – bad arguments detected; at least one of the following is true:
  - `pSrc` or `pDst` is NULL
  - `srcStep` or `dstStep` is less than or equal to zero
  - `roiSize` has a field with zero or negative value.
  - `anchor` specifies a point outside of the mask
  - `divider` is out of range

## Example 4-2: FIR Image Filtering

```
#include <stdlib.h>
#include "extools.h" /* print/display tool */
int main()
{
    /* One-channel source and destination images */
    const OMX_INT SIDE = 16;
    OMX_U8 src[SIDE*SIDE];
    OMX_U8 dst[SIDE*SIDE];
    /* Fill source image with data */
    for(OMX_INT i=0; i<SIDE*SIDE; i++)
        src[i] = (OMX_U8)(rand()&0xFF);
    /* 3x3 filter with anchor at the middle */
    const OMX_INT FSIDE = 3;
    OMXSize filterSize = {FSIDE,FSIDE};
    OMXPoint anchor = {1,1};
    OMX_S32 filter[FSIDE][FSIDE] = {
        {1,1,1},
        {1,1,1},
        {1,1,1}
    };
    /* Specify ROI location and size */
    OMXPoint srcLocation = {1,1};
    OMXPoint dstLocation = {0,0};
    OMXSize roiSize = {7,7};
    /* Apply 2D averaging FIR Filter */
    omxIPPP_Filter_U8_C1R(AddressOf(src,SIDE,srcLocation),SIDE,
        AddressOf(dst,SIDE,dstLocation),SIDE,roiSize,
            (OMX_S32*)filter,filterSize,anchor,
            FSIDE*FSIDE);
    /* Print result */
    OMXSize showSize = {9,9};
    PrintROI_C1(_T("Example: OMXFilter (source)"), src, SIDE,
        showSize);
    PrintROI_C1(_T("Example: OMXFilter (destination)"), dst, SIDE,
        roiSize);
    return 0;
}
```

```

/*
 * Returns address of ROI
 */
OMX_U8* AddressOf(OMX_U8* pImg, OMX_INT sLine, OMXPoint aLocation)
{
    return pImg + sLine*aLocation.y + aLocation.x
}

```

#### 4.3.1.1.2 FilterMedian\_U8\_C1R

##### Prototype

```

OMXResult omxIPPP_FilterMedian_U8_C1R(const OMX_U8 *pSrc, OMX_INT srcStep,
    OMX_U8 *pDst, OMX_INT dstStep, OMXSize roiSize, OMXSize maskSize,
    OMXPoint anchor);

```

##### Description

Performs median filtering of the ROI of the source image pointed to by `pSrc` using the median filter of the size `maskSize` and location `anchor`, and places the result into the ROI of the destination image pointed to by `pDst`.

##### Input Arguments

- `pSrc` – pointer to the source ROI
- `srcStep` – distance in bytes between the starts of consecutive lines in the source image
- `dstStep` – distance in bytes between the starts of consecutive lines in the destination image
- `roiSize` – size of the source and destination ROI, in pixels
- `maskSize` – size of the mask, in pixels; minimum size is 3x3; maximum size is 31x31.
- `anchor` – anchor cell specifying the mask alignment with respect to the position of the input pixels

##### Output Arguments

- `pDst` – pointer to the destination ROI

##### Returns

- `OMX_Sts_NoErr` – no errors detected
- `OMX_Sts_BadArgErr` – bad arguments detected; at least one of the following is true:
  - `pSrc` or `pDst` is `NULL`
  - `srcStep` or `dstStep` is less than or equal to zero
  - `roiSize` has a field with zero or negative value.
  - `anchor` specifies a point outside of the mask
  - `maskSize` is out of range, i.e., smaller than 3x3 or larger than 31x31

### 4.3.1.2 Statistical

This section describes functions that compute statistical image moments. The associated mathematical definitions are given in Table 4-6.

**Table 4-6: Statistical Moments Definitions**

| Operation      | Description   |
|----------------|---|
| spatial moment | <p>The spatial moment of (p,q) order is defined as follows:</p> $m_{pq} = \sum_{-\infty}^{\infty} \sum_{-\infty}^{\infty} x^p y^q f(x, y)$ <p>where:</p> <p><math>f(x, y)</math> input image pixel at the <math>(x, y)</math> location, and the infinite summation limits indicate that the sum is accumulated over all rows and columns in the image.</p> <p>Reference: [Dough94], p. 432.</p>   |
| central moment | <p>Basic equation of central moment of (p,q) order is the following:</p> $\mu_{pq} = \sum_{-\infty}^{\infty} \sum_{-\infty}^{\infty} (x - \hat{x})^p (y - \hat{y})^q f(x, y)$ $\hat{x} = \frac{m_{10}}{m_{00}} \quad \hat{y} = \frac{m_{01}}{m_{00}}$ <p>are coordinates of the center of mass, and the parameters <math>m_{01}</math>, <math>m_{10}</math>, and <math>m_{00}</math> are the order (1,0), (0,1), and (0,0), spatial moments, respectively.</p> <p>Reference: [Dough94], p. 432.</p> |

#### 4.3.1.2.1 MomentGetStateSize

##### Prototype

```
OMXResult omxIPPP_MomentGetStateSize(OMX_INT *pSize);
```

##### Description

Get size of state structure in bytes; returned in \*pSize.

##### Output Arguments

- pSize – pointer to the size of structure

## Returns

- `OMX_Sts_NoErr` – no errors detected
- `OMX_Sts_BadArgErr` – bad arguments detected; at least one of the following is true:
  - `pSize` is `NULL`

### 4.3.1.2.2 MomentInit

## Prototype

```
OMXResult omxIPPP_MomentInit(OMXMomentState *pState);
```

## Description

Initialize moment state structure.

## Input Arguments

- `pState` – pointer to the uninitialized state structure

## Output Arguments

- `pState` – pointer to the initialized state structure

## Returns

- `OMX_Sts_NoErr` – no errors detected
- `OMX_Sts_BadArgErr` – bad arguments detected; at least one of the following is true:
  - `pState` is `NULL`

### 4.3.1.2.3 Moments\_U8\_C1R

### 4.3.1.2.4 Moments\_U8\_C3R

## Prototype

```
OMXResult omxIPPP_Moments_U8_C1R(const OMX_U8 *pSrc, OMX_INT srcStep,  
    OMXSize roiSize, OMXMomentState *pState);
```

```
OMXResult omxIPPP_Moments_U8_C3R(const OMX_U8 *pSrc, OMX_INT srcStep,  
    OMXSize roiSize, OMXMomentState *pState);
```

## Description

Computes statistical spatial moments of order 0 to 3 for the ROI of the image pointed to by `pSrc`.

## Input Arguments

- `pSrc` – pointer to the source ROI
- `srcStep` – distance in bytes between the starts of consecutive lines in the source image
- `roiSize` – size of the ROI in pixels

## Output Arguments

- pState – pointer to the state structure

## Returns

- OMX\_Sts\_NoErr – no errors detected
- OMX\_Sts\_BadArgErr – bad arguments detected; at least one of the following is true:
  - pSrc or pState is NULL
  - srcStep is less than or equal to zero
  - roiSize has a field with zero or negative value.
- OMX\_StsIPPP\_ContextMatchErr – contents of the implementation-specific structure OMXMomentState are invalid

### 4.3.1.2.5 GetSpatialMoment\_S64

#### Prototype

```
OMXResult omxIPPP_GetSpatialMoment_S64(const OMXMomentState *pState, OMX_INT mOrd, OMX_INT nOrd, OMX_INT nChannel, OMXPoint roiOffset, OMX_S64 *pValue, OMX_INT scaleFactor);
```

#### Description

Returns nOrd by mOrd spatial moment calculated by the Moments\_U8 function. Places the scaled result into the memory pointed to by pValue.

#### Input Arguments

- nOrd, mOrd – moment specifiers
- pState – pointer to the state structure
- nChannel – specifies the desired image channel from which to extract the spatial moment. For a C3 input image, the valid range is from 0-2. For a C1 input image, the only valid value is 0.
- roiOffset – offset in pixels of the ROI origin (top left corner) from the image origin
- scaleFactor – value of the scale factor

#### Output Arguments

- pValue – pointer to the computed moment value

#### Returns

- OMX\_Sts\_NoErr – no error
- OMX\_Sts\_BadArgErr – bad arguments detected; at least one of the following is true:
  - pState or pValue is NULL
  - nChannel contains an invalid channel number
- OMX\_StsIPPP\_ContextMatchErr – contents of the implementation-specific structure OMXMomentState are invalid



### 4.3.1.2.6 GetCentralMoment\_S64

#### Prototype

```
OMXResult omxIPPP_GetCentralMoment_S64(const OMXMomentState *pState,  
    OMX_INT mOrd, OMX_INT nOrd, OMX_INT nChannel, OMX_S64 *pValue, OMX_INT  
    scaleFactor);
```

#### Description

Returns the nOrd by mOrd central moment calculated by the Moments\_U8 function, and places the scaled result into the memory pointed to by pValue.

#### Input Arguments

- pState – pointer to the state structure
- mOrd, nOrd – specify the required spatial moment
- nChannel – specifies the desired image channel from which to extract the spatial moment. For a C3 input image, the valid range is from 0-2. For a C1 input image, the only valid value is 0.
- scaleFactor – value of the scale factor

#### Output Arguments

- pValue – pointer to the computed moment value

#### Returns

- OMX\_Sts\_NoErr – no error
- OMX\_Sts\_BadArgErr – bad arguments detected; at least one of the following is true:
  - pState or pValue is NULL
  - nChannel contains an invalid channel number
- OMX\_StsIPPP\_ContextMatchErr – contents of the implementation-specific structure OMXMomentState are invalid

### 4.3.1.3 Deblocking

#### 4.3.1.3.1 Deblock\_HorEdge\_U8\_I

#### 4.3.1.3.2 Deblock\_VerEdge\_U8\_I

#### Prototype

```
OMXResult omxIPPP_Deblock_HorEdge_U8_I (OMX_U8 *pSrcDst, OMX_INT step,  
    OMX_INT QP);  
OMXResult omxIPPP_Deblock_VerEdge_U8_I (OMX_U8 *pSrcDst, OMX_INT step,  
    OMX_INT QP);
```

#### Description

Performs deblock filtering for a single 8x8 macroblock along a block edge (horizontal-top or vertical-left), as shown in the figure below. Block edges are represented in the figure by heavy lines. The horizontal

edge deblocking function processes the top edge of the block referenced by `pSrcDst`. The vertical edge deblocking function processes the left edge of the block referenced by `pSrcDst`. For each processed column, the horizontal edge deblocking operation modifies two pixels from the source block (pixels C,D) and two pixels in the neighboring block (pixels A,B). For each processed row, the vertical edge deblocking operation modifies two pixels from the source block (pixels C,D) and two pixels from the neighboring block (A,B).

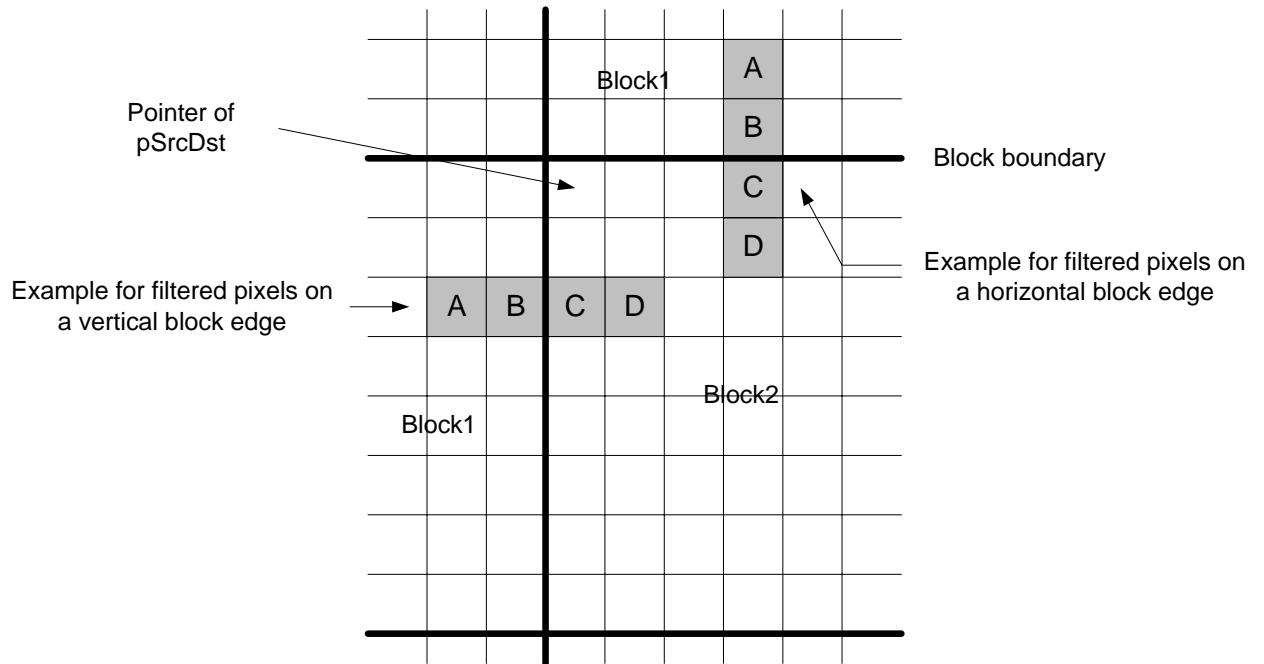

### Input Arguments

- `pSrcDst` – pointer to the first pixel of the second block (labeled “block 2” in the figure); must be aligned on an 8-byte boundary.
- `step` – distance, in bytes; between start of each line; must be a multiple of 8
- `QP` – quantization parameter, as described in Section J.3 of Annex J in H.263+; valid in the range 1 to 31.

### Output Arguments

- `pSrcDst` – pointer to the first pixel of the second output block (labeled “block 2” in the figure below); must be aligned on an 8-byte boundary.

### Returns

- `OMX_Sts_NoErr` – no error
- `OMX_Sts_BadArgErr` – bad arguments
  - `pSrcDst` is NULL or not aligned on an 8-byte boundary
  - `QP` exceeds [1,31]
  - `step` is not a multiple of 8 or `step` is less than 8

## 4.4 Color Space Conversion Sub-Domain (omxIPCS)

This section defines functions that perform color space conversion. Table 4-7 presents analytical expressions that define each of the color conversion methodologies referenced in the omxIPCS sub-domain. In addition, color space subsampling conventions that shall be observed are summarized in Table 4-8.

### 4.4.1 Definitions

#### 4.4.1.1 Color Space Conversions

**Table 4-7: Color Model Conversions**

| Functions    | Mathematical Descriptions  |
|--------------|--|
| Color Twist  | <p>Linear transform of an original Color model (RGB) to another (ABC) by user defined transformation</p> $\begin{bmatrix} A \\ B \\ C \end{bmatrix} = \begin{bmatrix} T_{00} & T_{01} & T_{02} \\ T_{10} & T_{11} & T_{12} \\ T_{20} & T_{21} & T_{22} \end{bmatrix} \cdot \begin{bmatrix} R \\ G \\ B \end{bmatrix} + \begin{bmatrix} T_{03} \\ T_{13} \\ T_{23} \end{bmatrix}$ |
| RGB to YCbCr | <p>RGB color model is transformed to YCbCr Color model as follows:</p> $Y = 0.257R + 0.504G + 0.098B + 16$ $Cb = -0.148R - 0.291G + 0.439B + 128$ $Cr = 0.439R - 0.368G - 0.071B + 128$ <p>Note: OpenMAX DL color conversion equations are implemented using integer data types.<br/>Reference: [ITUBT601-6]</p>   |
| YCbCr to RGB | <p>YCbCr color model is transformed to RGB Color model as follows:</p> $R = 1.164(Y - 16) + 1.596(Cr - 128)$ $G = 1.164(Y - 16) - 0.813(Cr - 128) - 0.392(Cb - 128)$ $B = 1.164(Y - 16) + 2.017(Cb - 128)$ <p>Note: OpenMAX DL color conversion equations are implemented using integer data types.<br/>Reference: [ITUBT601-6]</p>  |

### 4.4.1.2 Color Space Subsampling

**Table 4-8: Color Conversion Subsampling Conventions**

| Image Type  | Downsampling                 | Description  |
|-------------|------------------------------|--|
| 4:4:4 YCbCr | None                         | Y, Cb, Cr sampled on every pixel.<br>8 bits per component = 24 bits per pixel.   |
| 4:2:2 YCbCr | 2:1 horizontal               | Y sampled on every pixel; Cb and Cr sampled every 2 pixels horizontally.<br>8 bits per component = 32 bits per pixel pair.   |
| 4:1:1 YCbCr | 4:1 horizontal               | Y sampled on every pixel; Cb and Cr sampled every 4 pixels horizontally.<br>8 bits per component = 48 bits for four pixels.  |
| 4:2:0 YCbCr | 2:1 horizontal, 2:1 vertical | Y sampled on every pixel, Cb and Cr sampled once on each 2x2 pixel block.<br>8 bits per component = 48 bits for four pixels. |

### 4.4.2 Data Structures and Enumerators

Two enumerated types are defined to support the integrated color space conversion/resize/rotation function set.

#### 4.4.2.1 Interpolation Schemes

OMXIPInterpolation, a data type that enumerates image interpolation schemes, is defined as follows:

```
typedef enum {  
    OMX_IP_NEAREST = 0,  
    OMX_IP_BILINEAR = 1,  
    OMX_IP_MEDIAN = 2  
} OMXIPInterpolation;
```

#### 4.4.2.2 Color Spaces

OMXIPColorSpace, a data type that enumerates color spaces, is defined as follows:

```
typedef enum {  
    OMX_IP_BGR565 = 0,  
    OMX_IP_BGR555 = 1,  
    OMX_IP_BGR444 = 2,  
    OMX_IP_BGR888 = 3,  
    OMX_IP_YCBCR422 = 4,
```

```

    OMX_IP_YCBCR420 = 5,
} OMXIPColorSpace;

```

## 4.4.3 Functions

### 4.4.3.1 YCbCr to BGR

#### 4.4.3.1.1 YCbCr444ToBGR888\_U8\_C3R

#### 4.4.3.1.2 YCbCr444ToBGR565\_U8\_U16\_C3R

##### Prototype

```

OMXResult omxIPCS_YCbCr444ToBGR888_U8_C3R(const OMX_U8 *pSrc, OMX_INT
    srcStep, OMX_U8 *pDst, OMX_INT dstStep, OMXSize roiSize);
OMXResult omxIPCS_YCbCr444ToBGR565_U8_U16_C3R(const OMX_U8 *pSrc, OMX_INT
    srcStep, OMX_U16 *pDst, OMX_INT dstStep, OMXSize roiSize);

```

##### Description

Converts a pixel-oriented YCbCr444 image to BGR888 or BGR565 color space. The ROI of the source image is pointed to by `pSrc`, and the result is placed into the ROI of the destination image pointed to by `pDst`. The input and output images are organized, respectively, as specified by the Table 4-1 entries labeled “YCbCr444” and “BGR888”/“BGR565.”

##### Input Arguments

- `pSrc` – pointer to the source ROI
- `srcStep` – distance in bytes between the starts of consecutive lines in the source image
- `dstStep` – distance in bytes between the starts of consecutive lines in the destination image
- `roiSize` – size of the source and destination ROI in pixels

##### Output Arguments

- `pDst` – pointer to the destination ROI

##### Returns

- `OMX_Sts_NoErr` – no error
- `OMX_Sts_BadArgErr` – bad arguments detected; at least one of the following is true:
  - `pSrc` or `pDst` is `NULL`
  - `srcStep/3 < roiSize.width`
  - **omxIPCS\_YCbCr444ToBGR888\_U8\_C3R() only:** `dstStep/3 < roiSize.width`
  - **omxIPCS\_YCbCr444ToBGR565\_U8\_U16\_C3R() only:** `dstStep/2 < roiSize.width`
  - `roiSize` has a field with zero or negative value

### 4.4.3.1.3 YCbCr444ToBGR565\_U8\_U16\_P3C3R

#### Prototype

```
OMXResult omxIPCS_YCbCr444ToBGR565_U8_U16_P3C3R(const OMX_U8 *pSrc[3],  
    OMX_INT srcStep, OMX_U16 *pDst, OMX_INT dstStep, OMXSize roiSize);
```

#### Description

Converts a planar YCbCr444 input image to a pixel-oriented BGR565 output image. The ROI of the source image is pointed to by `pSrc`, and the result is placed into the ROI of the destination image pointed to by `pDst`. The YCbCr444 input image is organized in memory as specified in Table 4-2. The pixel-oriented BGR565 output image is organized in memory as specified in Table 4-1.

#### Input Arguments

- `pSrc` – vector containing pointers to Y, Cb, and Cr planes
- `srcStep` – distance in bytes between the starts of consecutive lines in the source image
- `dstStep` – distance in bytes between the starts of consecutive lines in the destination image
- `roiSize` – size of the source and destination ROI in pixels

#### Output Arguments

- `pDst` – pointer to the destination buffer

#### Return Values

- `OMX_Sts_NoErr` – No error.
- `OMX_Sts_BadArgErr` – bad arguments detected; at least one of the following is true:
  - `pSrc` or `pDst` is NULL
  - `srcStep < roiSize.width`
  - `dstStep/2 < roiSize.width`
  - `roiSize` has a field with zero or negative value

### 4.4.3.1.4 YCbCr420ToBGR565\_U8\_U16\_P3C3R

#### Prototype

```
OMXResult omxIPCS_YCbCr420ToBGR565_U8_U16_P3C3R(const OMX_U8 *pSrc[3],  
    OMX_INT srcStep[3], OMX_U16 *pDst, OMX_INT dstStep, OMXSize roiSize);
```

#### Description

This function converts a planar YCbCr420 input image to a pixel-oriented BGR565 output image. The memory organization for a planar YCbCr420 image is specified in Table 4-2. The memory organization for a pixel-oriented BGR565 image is specified in Table 4-1.

#### Input Arguments

- `pSrc` – an array of pointers to the YCbCr420 source planes

- `srcStep` – an array of three step values; which represent for each image plane, respectively, the distance in bytes between the starts of consecutive lines in the source image. The following must be true: `srcStep[0] >= roiSize.width`, `srcStep[1]*2 >= roiSize.width`, and `srcStep[2]*2 >= roiSize.width`.
- `dstStep` – distance in bytes between the starts of consecutive lines in the destination image, must be an even number, and the following condition must be true: `dstStep/2 >= roiSize.width`.
- `roiSize` – size of the source and destination ROI in pixels

### Output Arguments

- `pDst` – pointer to the destination buffer; BGR565 is represented using 16-bit words that are organized as specified in Table 4-1.

### Return Values

- `OMX_Sts_NoErr` – No error. Any other value indicates an error or a warning
- `OMX_Sts_BadArgErr` – bad arguments detected; at least one of the following is true:
  - `pSrc` or `pDst` is `NULL`
  - `dstStep` has a non-even value
  - at least one of the values `srcStep[0..2]` or `dstStep[0..2]` is negative
  - `srcStep[0] < roiSize.width`
  - `srcStep[1]*2 < roiSize.width`
  - `srcStep[2]*2 < roiSize.width`
  - `dstStep/2 < roiSize.width`

#### 4.4.3.1.5 YCbYCr422ToBGR888\_U8\_C2C3R

#### 4.4.3.1.6 YCbYCr422ToBGR565\_U8\_U16\_C2C3R

### Prototype

```
OMXResult omxIPCS_YCbYCr422ToBGR888_U8_C2C3R(const OMX_U8 *pSrc, OMX_INT
    srcStep, OMX_U8 *pDst, OMX_INT dstStep, OMXSize roiSize);
OMXResult omxIPCS_YCbYCr422ToBGR565_U8_U16_C2C3R(const OMX_U8 *pSrc, OMX_INT
    srcStep, OMX_U16 *pDst, OMX_INT dstStep, OMXSize roiSize);
```

### Description

Convert a pixel-oriented YCbYCr422 input image to a pixel-oriented BGR888 or BGR565 output image. The ROI of the source image is pointed to by `pSrc`, and the result is placed into the ROI of the destination image referenced by `pDst`. Memory organization for pixel-oriented YCbYCr422, BGR888, and BGR565 images is specified in Table 4-1.

### Input Arguments

- `pSrc` – pointer to the source ROI
- `srcStep` – distance in bytes between the starts of consecutive lines in the source image
- `dstStep` – distance in bytes between the starts of consecutive lines in the destination image
- `roiSize` – size of the source and destination ROI in pixels

## Output Arguments

- `pDst` – pointer to the destination ROI

## Returns

- `OMX_Sts_NoErr` – no error
- `OMX_Sts_BadArgErr` – bad arguments detected; at least one of the following is true:
  - `pSrc` or `pDst` is `NULL`
  - `srcStep` or `dstStep` is less than or equal to zero
  - `srcStep/2 < roiSize.width`
  - **omxIPCS\_YCbYCr422ToBGR888\_U8\_C2C3R() only:** `dstStep/3 < roiSize.width`
  - **omxIPCS\_YCbYCr422ToBGR565\_U8\_U16\_C2C3R() only:** `dstStep/2 < roiSize.width`
  - `roiSize` has a field with zero or negative value

## 4.4.3.2 Color Twist

### 4.4.3.2.1 ColorTwistQ14\_U8\_C3R

#### Prototype

```
OMXResult omxIPCS_ColorTwistQ14_U8_C3R(const OMX_U8 *pSrc, OMX_INT srcStep,
    OMX_U8 *pDst, OMX_INT dstStep, OMXSize roiSize, const OMX_S32
    twistQ14[3][4]);
```

#### Description

Applies a Q17.14 color twist matrix to the ROI of the source image pointed to by `pSrc`. Places the results into the ROI of the destination image pointed to by `pDst`. The Q14 modifier with a parameter of type `OMX_S32` is used to indicate the fact that the matrix entries are obtained by multiplying the entries of the equivalent floating-point color twist matrix with  $(1 \ll 14)$ .

#### Input Arguments

- `pSrc` – pointer to the source ROI; should contain three interleaved (“C3”) channels of 8-bit image data.
- `srcStep` – distance in bytes between the starts of consecutive lines in the source image
- `dstStep` – distance in bytes between the starts of consecutive lines in the destination image
- `roiSize` – size of the source and destination ROI in pixels
- `twistQ14` – twist matrix

#### Output Arguments

- `pDst` – pointer to the destination ROI; contains transformed version of the input ROI.

#### Returns

- `OMX_Sts_NoErr` – no error



- `OMX_Sts_BadArgErr` – bad arguments detected; at least one of the following is true:
  - `pSrc` or `pDst` is `NULL`
  - `srcStep` or `dstStep` is less than or equal to zero
  - `srcStep/3 < roiSize.width`
  - `dstStep/3 < roiSize.width`
  - `roiSize` has a field with zero or negative value

### 4.4.3.3 Integrated CSC/Rotate/Integer Resize

#### 4.4.3.3.1 CbYCrY422RszCscRotBGR\_U8\_U16\_C2R

##### Prototype

```
OMXResult omxIPCS_CbYCrY422RszCscRotBGR_U8_U16_C2R(const OMX_U8 *pSrc,
  OMX_INT srcStep, OMX_U16 *pDst, OMX_INT dstStep, OMXSize roiSize,
  OMX_INT scaleFactor, OMXIPInterpolation interpolation, OMXIPColorSpace
  RGBSpec, OMXIPRotation rotation);
```

##### Description

This function synthesizes a low-resolution preview image from the input image. In particular, the following sequence of operations is applied to the input image:

1. Scale reduction by an integer scalefactor. First, the input image scale is reduced by an integer scalefactor of either 2, 4, or 8 on both axes using the interpolation methodology specified by the control parameter `interpolation`. The following interpolation schemes are supported: nearest neighbor, bilinear.
2. Color space conversion. Following scale reduction, color space conversion is applied from the CbYCrY422 input color space to a particular BGR target space determined by the control parameter `RGBSpec`.
3. Rotation. After color space conversion, the preview output image is rotated according to the control parameter `rotation`.

##### Input Arguments

- `pSrc` – pointer to the start of the buffer containing the pixel-oriented input image
- `srcStep` – distance, in bytes, between the start of lines in the source image
- `dstStep` – distance, in bytes, between the start of lines in the destination image
- `roiSize` – dimensions, in pixels, of the source region of interest
- `scaleFactor` – reduction scalefactor; values other than 2, 4, or 8 are invalid
- `interpolation` – interpolation methodology control parameter; must take one of the following values: `OMX_IP_NEAREST` or `OMX_IP_BILINEAR` for nearest neighbor or bilinear interpolation, respectively
- `RGBSpec` – color conversion control parameter; must be set to one of the following pre-defined values: `OMX_IP_BGR565` or `OMX_IP_BGR555`
- `rotation` – rotation control parameter; must be set to one of the following pre-defined values: `OMX_IP_DISABLE`, `OMX_IP_ROTATE90L`, `OMX_IP_ROTATE90R`, or `OMX_IP_ROTATE180`

## Output Arguments

- `pDst` – pointer to the start of the buffer containing the resized, color-converted, and rotated output image

## Returns

If the function runs without error, it returns `OMX_Sts_NoErr`

If one of the following occurs, the function returns `OMX_Sts_BadArgErr`:

- `pSrc` or `pDst` is `NULL`
- `pSrc` or `pDst` is not aligned on an 8-byte boundary
- `srcStep` or `dstStep` is less than 1, or `srcStep`, or `dstStep` is not multiple of 8
- `roiSize.width` is larger than half of `srcStep`
- `roiSize.width` or `roiSize.height` is less than `scaleFactor`
- Invalid values of one or more of the following control parameters:
  - `scaleFactor`, `interpolation`, `colorConversion` or `rotation`
  - Half of the `dstStep` is less than width of downsampled, color-converted and rotated image

## Alignment Requirement

The start address of `pSrc`, `pDst`, must be aligned at 8-byte boundary; `srcStep` and `dstStep` must be multiple of 8.

## Size of Output Image

If `roiSize.width` or `roiSize.height` cannot be divided by `scaleFactor` exactly, it will be cut to be the multiple of `scaleFactor`. For example, if the rotation control parameter is `OMX_IP_DISABLE` or `OMX_IP_ROTATE180`, the output image's `roiSize.width` is equal to `round((input image's roiSize.width)/scaleFactor)`.

### Example 4-3: Integrated Scaling, Color Space Conversion, and Rotation

```
#include <stdlib.h>
#include "OMXIP.h"
#define _ALIGN8(adr) (((OMX_U32)(adr)+7)&(~7))
int main()
{
    OMX_INT W, H, BufSize;
    /* Variables in preview function */
    OMX_U8 *pSrc, *pSrcAlign;
    OMX_U16 *pDst, *pDstAlign;
    OMX_INT scaleFactor;
    OMX_INT srcStep, dstStep;
    OMXCameraInterpolation interpolation;
    OMXCameraRotation rotation;
    OMXCameraCsc colorConversion;
```

```

OMXSize roiSize;

/* Initialize Width and Height of the input image */
W=320;
H=240;

/* Initialize control parameters */
interpolation = omxInterpBilinear;
rotation = omxRotate90R;
colorConversion = omxCscYCbCr422ToRGB565 ;

/* Initialize source parameter */
roiSize.width = W;
roiSize.height = H;
srcStep = 640;
dstStep = 240;
scaleFactor = 2;

/* Allocate buffer */
pSrc = (OMX_U8*) malloc(srcStep*H+7);
pDst = (OMX_U16*) malloc(dstStep*W+7);

/* Align Source and Output Buffer at 8-byte */
pDstAlign = (OMX_U16*)_ALIGN8(pDst);
pSrcAlign = (OMX_U8*)_ALIGN8(pSrc);

/* Rsz/Csc/Rot */
omxIPCS_YCbYCr422RszCscRotBGR_U8_C2R(pSrcAlign, srcStep, pDstAlign,
dstStep, roiSize, scaleFactor, interpolation, colorConversion,
rotation);

/* Free buffer */
free(pSrc);
free(pDst);
return (0);
}

```

## 4.4.3.4 Integrated Rotate/Fractional Resize

### 4.4.3.4.1 YCbCr420RszRot\_U8\_P3R

### 4.4.3.4.2 YCbCr422RszRot\_U8\_P3R

#### Prototype

```
OMXResult omxIPCS_YCbCr420RszRot_U8_P3R(const OMX_U8 *pSrc[3], OMX_INT
    srcStep[3], OMXSize srcSize, OMX_U8 *pDst[3], OMX_INT dstStep[3],
    OMXSize dstSize, OMXIPInterpolation interpolation, OMXIPRotation
    rotation, OMX_INT rcpRatiox, OMX_INT rcpRatioy);
```

```
OMXResult omxIPCS_YCbCr422RszRot_U8_P3R(const OMX_U8 *pSrc[3], OMX_INT
    srcStep[3], OMXSize srcSize, OMX_U8 *pDst[3], OMX_INT dstStep[3],
    OMXSize dstSize, OMXIPInterpolation interpolation, OMXIPRotation
    rotation, OMX_INT rcpRatiox, OMX_INT rcpRatioy);
```

#### Description

This function combines two atomic image processing kernels into a single function. The following sequence of operations is applied:

1. **Resize.** The input image of dimension `srcSize` is rescaled according to the Q16 reciprocal ratio scaling control parameters `rcpRatiox` and `rcpRatioy` using the interpolation/decimation methodology specified by the control parameter `interpolation`. Nearest neighbor and bilinear interpolation schemes are supported. The rescaled image is clipped to `dstSize` using a clipping rectangle, the origin of which coincides with the top, left corner of the input image, i.e., pixels are discarded along the right and bottom edges.
2. **Rotation.** The output image is rotated with respect to the input image according to the control parameter `rotation`.

The input data should be YCbCr420 planar format for `<omxIPCS_YCbCr420RszRot_U8_P3R>` and YCbCr422 planar format for `<omxIPCS_YCbCr422RszRot_U8_P3R>`.

#### Input Arguments

- `pSrc` – a 3-element vector containing pointers to the start of each of the YCbCr420 input planes for `<omxIPCS_YCbCr420RszRot_U8_P3R>` and YCbCr422 input planes for `<omxIPCS_YCbCr422RszRot_U8_P3R>`. The pointer `pSrc[0]` must be aligned on a 4-byte boundary.
- `srcStep` – a 3-element vector containing the distance, in bytes, between the start of lines in each of the input image planes; the parameter `srcStep[0]` must be a multiple of 4.
- `dstStep` – a 3-element vector containing the distance, in bytes, between the start of lines in each of the output image planes; the parameter `dstStep[0]` must be a multiple of 4.
- `srcSize` – dimensions, in pixels, of the source image
- `dstSize` – dimensions, in pixels, of the destination image (before applying rotation to the resized image). The parameters `dstSize.width` and `dstSize.height` must be even.
- `interpolation` – interpolation methodology control parameter; must take one of the following values: `OMX_IP_NEAREST`, or `OMX_IP_BILINEAR` for nearest neighbor or bilinear interpolation, respectively

- `rotation` – rotation control parameter; must be set to one of the following pre-defined values: `OMX_IP_DISABLE`, `OMX_IP_ROTATE90L`, `OMX_IP_ROTATE90R`, `OMX_IP_ROTATE180`, `OMX_IP_FLIP_HORIZONTAL`, or `OMX_IP_FLIP_VERTICAL`
- `rcpRatiox` – x direction scaling control parameter, specified in terms of a reciprocal resize ratio using a Q16 representation. Valid in the range  $[1, \text{xrr\_max}]$ , where  $\text{xrr\_max} = (\text{OMX\_INT}) (((\text{OMX\_F32}) ((\text{srcSize.width}\&\sim 1)-1) / ((\text{dstSize.width}\&\sim 1)-1)) * (1\ll 16) + 0.5)$ . Setting `rcpRatiox = xrr_max` guarantees that the output image size will be exactly `dstSize`; otherwise for values less than `xrr_max` the right hand side of the image will be clipped since the output image will extend beyond `dstSize`. Expansion in the x direction occurs for values of `rcpRatiox < 65536`; contraction in the x direction occurs for values  $> 65536$ . To avoid clipping, use the value `xrr_max`, which will ensure that the output image width == `dstSize.width`. Values larger than `xrr_max` are invalid, i.e., output images smaller than `dstSize` are not allowed.
- `rcpRatioy` – y direction scaling control parameter, specified in terms of a reciprocal resize ratio using a Q16 representation. Valid in the range  $[1, \text{yrr\_max}]$ , where  $\text{yrr\_max} = (\text{OMX\_INT}) (((\text{OMX\_F32}) (\text{srcSize.height}\&\sim 1)-1) / ((\text{dstSize.height}\&\sim 1)-1)) * (1\ll 16) + 0.5)$ . Setting `rcpRatioy = yrr_max` guarantees that the output image size will be exactly `dstSize`; otherwise for values less than `yrr_max` the bottom of the output image will be clipped since the output image will be larger than `dstSize`. Expansion in the y direction occurs for values of `rcpRatioy < 65536`; contraction in the y direction occurs for values  $> 65536$ . To avoid clipping, use the value `yrr_max`, which will ensure that the output image height == `dstSize.height`. Values larger than `yrr_max` are invalid, i.e., output images smaller than `dstSize` are not allowed.

## Output Arguments

- `pDst` – a 3-element vector containing pointers to the start of each of the YCbCr420 output planes for `<omxIPCS_YCbCr420RszRot_U8_P3R>` or YCbCr422 output planes for `<omxIPCS_YCbCr422RszRot_U8_P3R>`. The pointer `pDst[0]` must be aligned on a 4-byte boundary.

## Returns

If the function runs without error, it returns `OMX_Sts_NoErr`.

If one of the following cases occurs, the function returns `OMX_Sts_BadArgErr`:

- Any pointer is `NULL`
- Each of `srcSize.width`, `srcSize.height`, `dstSize.width` and `dstSize.height`  $\leq 0$ .
- `rcpRatioy` is outside of the range  $[1, \text{yrr\_max}]$ , where  $\text{yrr\_max} = (\text{OMX\_INT}) (((\text{OMX\_F32}) (\text{srcSize.height}\&\sim 1)-1) / ((\text{dstSize.height}\&\sim 1)-1)) * (1\ll 16) + 0.5)$ .
- `rcpRatiox` is outside of the range  $[1, \text{xrr\_max}]$ , where  $\text{xrr\_max} = (\text{OMX\_INT}) (((\text{OMX\_F32}) ((\text{srcSize.width}\&\sim 1)-1) / ((\text{dstSize.width}\&\sim 1)-1)) * (1\ll 16) + 0.5)$ .
- `pDst[0]` is not aligned on a 4-byte boundary
- `pSrc[0]` is not aligned on a 4-byte boundary
- `dstSize.width` or `dstSize.height` is not even
- `srcStep[0]`, `srcStep[1]`, `srcStep[2]` or `dstStep[0]`, `dstStep[1]`, `dstStep[2]` is less than 1
- `srcStep[0]` is not multiple of 4
- `dstStep[0]` is not multiple of 4
- `srcSize.width` is larger than `srcStep[0]`; `srcSize.width >> 1` is larger than `srcStep[1]` or `srcStep[2]`.

- Invalid values of one or both of the following control parameters: interpolation or rotation
- `dstSize.height` of output image is larger than `dstStep[0]`, `dstSize.height>>1` of output image is larger than `dstStep[1]` or `dstStep[2]` when rotation is `OMX_IP_ROTATE90L` or `OMX_IP_ROTATE90R`; `dstSize.width` of output image is larger than `dstStep[0]`, `dstSize.width>>1` of output image is larger than `dstStep[1]` or `dstStep[2]` when other valid rotation options.

## Size of Output Image

`dstSize` is the size of destination image before rotation, i.e., `dstSize` is the size of the image after resizing.

Below is an example that demonstrates how to call the `omxIPCS_YCbCr420RszRot_U8_P3R` function.

### Example 4-4:

```
#include <stdio.h>
#include <stdlib.h>
#include "OMXIP.h"
#define _ALIGN4(adr) (((OMX_U32)(adr))+3)&(~3)

OMXResult resize_rotate();

int main()
{
    resize_rotate();
}

OMXResult resize_rotate()
{
    OMX_U8    *pSrc1, *pSrc2, *pSrc3, *pDst1, *pDst2, *pDst3;
    OMX_U8    *pSrc[3], *pDst[3];
    OMXSize    srcSize, dstSize;
    OMXIPRotation    rotation;
    OMXIPInterpolation    interpolation;
    OMX_INT    rcpRatioX, rcpRatioY;
    OMX_INT    srcStep[3], dstStep, size;
    OMX_INT    status;

    /* Initialize parameters */
    srcSize.width = 176;
    srcSize.height = 144;
    dstSize.width = 320;
    dstSize.height = 240;
```

```

    srcStep[0]    = 176;
    srcStep[1]    = 88;
    srcStep[2]    = 88;
dstStep[0]      = 320;
dstStep[1]      = 160;
dstStep[2]      = 160;
interpolation   = OMX_IP_BILINEAR;
rotation        = OMX_IP_DISABLE;
    rcpRatioX = (OMX_INT)(((double)((srcSize.width-
1)<<16))/(dstSize.width-1));
rcpRatioY = (OMX_INT)(((double)((srcSize.height-
1)<<16))/(dstSize.height-1));

    pSrc1 = (OMX_U8*)malloc(srcSize.height*srcStep[0] + 8);
    pSrc2 = (OMX_U8*)malloc((srcSize.height>>1)*srcStep[1] + 8);
pSrc3 = (OMX_U8*)malloc((srcSize.height>>1)*srcStep[2] + 8);
pSrc[0] = (OMX_U8*)_ALIGN4(pSrc1);
pSrc[1] = pSrc2;
pSrc[2] = pSrc3;

    size = dstSize.height * dstStep[0] + 8;
pDst = (OMX_U8*)malloc(size);
    size = (dstSize.height>>1) * dstStep[1] + 8;
pDst2 = (OMX_U8*)malloc(size);
pDst3 = (OMX_U8*)malloc(size);

pDst[0] = (OMX_U8*)_ALIGN4(pDst1);
pDst[1] = pDst2;
pDst[2] = pDst3;

    /* here to initialize the content of pSrc[0], pSrc[1] and pSrc[2] */
pSrc[0] = ...;
pSrc[1] = ...;
pSrc[2] = ...;
    /* here to initialize the content of pSrc[0], pSrc[1] and pSrc[2] */
    /* resize & rotate */
status = omxIPCS_YCbCr420RszRot_U8_P3R(pSrc, srcStep, srcSize, pDst,
dstStep, dstSize, interpolate, rotation,
rcpRatioX, rcpRatioY);
    return status;

```

```
}
```

### 4.4.3.5 Integrated CSC/Rotate/Fractional Resize

#### 4.4.3.5.1 YCbCr420RszCscRotBGR\_U8\_P3C3R

#### 4.4.3.5.2 YCbCr422RszCscRotBGR\_U8\_P3C3R

##### Prototype

```
OMXResult omxIPCS_YCbCr420RszCscRotBGR_U8_P3C3R(const OMX_U8 *pSrc[3],  
    OMX_INT srcStep[3], OMXSize srcSize, void *pDst, OMX_INT dstStep,  
    OMXSize dstSize, OMXIPColorSpace colorConversion, OMXIPInterpolation  
    interpolation, OMXIPRotation rotation, OMX_INT rcpRatiox, OMX_INT  
    rcpRatioy);
```

```
OMXResult omxIPCS_YCbCr422RszCscRotBGR_U8_P3C3R(const OMX_U8 *pSrc[3],  
    OMX_INT srcStep[3], OMXSize srcSize, void *pDst, OMX_INT dstStep,  
    OMXSize dstSize, OMXIPColorSpace colorConversion, OMXIPInterpolation  
    interpolation, OMXIPRotation rotation, OMX_INT rcpRatiox, OMX_INT  
    rcpRatioy);
```

##### Description

This function combines several atomic image processing kernels into a single function. In particular, the following sequence of operations is applied to the input YCbCr image:

1. **Resize.** The input image of dimension `srcSize` is rescaled according to the Q16 reciprocal ratio scaling control parameters `rcpRatiox` and `rcpRatioy` using the interpolation/decimation methodology specified by the control parameter `interpolation`. Nearest neighbor and bilinear interpolation schemes are supported. The rescaled image is clipped to `dstSize` using a clipping rectangle, the origin of which coincides with the top, left corner of the input image, i.e., pixels are discarded along the right and bottom edges.
2. **Color space conversion.** Following scaling, color space conversion from either YCbCr420 or YCbCr422 to BGR is applied according to the control parameter `colorConversion`. The following target BGR color spaces are supported: BGR565, BGR888, BGR555, or BGR444.
3. **Rotation.** After color space conversion, the output image is rotated with respect to the input image according to the control parameter `rotation`.

The input data should be in YCbCr420 planar format for the function

<omxIPCS\_YCbCr420RszCscRotBGR\_U8\_P3CR> or YCbCr422 planar format for the function



<omxIPCS\_YCbCr422RszCscRotBGR\_U8\_P3CR>.

## Input Arguments

- `pSrc` – a 3-element vector containing pointers to the start of each of the YCbCr420 or YCbCr422 input planes
- `srcStep` – a 3-element vector containing the distance, in bytes, between the start of lines in each of the input image planes
- `dstStep` – distance, in bytes, between the start of lines in the destination image
- `srcSize` – dimensions, in pixels, of the source image
- `dstSize` – dimensions, in pixels, of the destination image (before applying rotation to the resizing image)
- `interpolation` – interpolation methodology control parameter; must take one of the following values: `OMX_IP_NEAREST`, or `OMX_IP_BILINEAR` for nearest neighbor or bilinear interpolation, respectively.
- `colorConversion` – color conversion control parameter; must be set to one of the following pre-defined values: `OMX_IP_BGR565`, `OMX_IP_BGR555`, `OMX_IP_BGR444`, or `OMX_IP_BGR888`.
- `rotation` – rotation control parameter; must be set to one of the following pre-defined values:
  - `OMX_IP_DISABLE`
  - `OMX_IP_ROTATE90L`
  - `OMX_IP_ROTATE90R`
  - `OMX_IP_ROTATE180`
  - `OMX_IP_FLIP_HORIZONTAL`
  - `OMX_IP_FLIP_VERTICAL`

Counter-clockwise rotation is denoted by the “L” postfix, and clockwise rotation is denoted by the “R” postfix. A horizontal flip creates a “mirror” image with respect to the vertical image axis, i.e.,

**ROT** →horizontal flip→ **TOA**

and a vertical flip creates a “mirror” image with respect to the horizontal image axis, i.e.,

**ROT** →vertical flip→ **BOI**

- `rcpRatioX` – x direction scaling control parameter, specified in terms of a reciprocal resize ratio using a Q16 representation. Valid in the range  $[1, \text{xrr\_max}]$ , where  $\text{xrr\_max} = (\text{OMX\_INT}) (((\text{OMX\_F32}) ((\text{srcSize.width}\&\sim 1) - 1) / ((\text{dstSize.width}\&\sim 1) - 1)) * (1 << 16) + 0.5)$ . Setting `rcpRatioX = xrr_max` guarantees that the output image size will be exactly `dstSize`; otherwise for values less than `xrr_max` the right hand side of the image will be clipped since the output image will extend beyond `dstSize`. Expansion in the x direction occurs for values of `rcpRatioX < 65536`; contraction in the x direction occurs for values `> 65536`. To avoid clipping, use the value `xrr_max`, which will ensure that the output image width == `dstSize.width`. Values larger than `xrr_max` are invalid, i.e., output images smaller than `dstSize` are not allowed.

- `rcpRatioy` – y direction scaling control parameter, specified in terms of a reciprocal resize ratio using a Q16 representation. Valid in the range  $[1, \text{yrr\_max}]$ , where  $\text{yrr\_max} = (\text{OMX\_INT}) (((\text{OMX\_F32}) (\text{srcSize.height}\&\sim 1) - 1) / ((\text{dstSize.height}\&\sim 1) - 1)) * (1 \ll 16) + 0.5$ . Setting `rcpRatioy = yrr_max` guarantees that the output image size will be exactly `dstSize`; otherwise for values less than `yrr_max` the bottom of the output image will be clipped since the output image will be larger than `dstSize`. Expansion in the y direction occurs for values of `rcpRatioy < 65536`; contraction in the y direction occurs for values  $> 65536$ . To avoid clipping, use the value `yrr_max`, which will ensure that the output image height  $\text{== dstSize.height}$ . Values larger than `yrr_max` are invalid, i.e., output images smaller than `dstSize` are not allowed.

## Output Arguments

- `pDst` – pointer to the start of the buffer containing the resized, color-converted, and rotated output image.

## Returns

If the function runs without error, it returns `OMX_Sts_NoErr`.

If one of the following cases occurs, the function returns `OMX_Sts_BadArgErr`:

- Any pointer is `NULL`
- `rcpRatioy` is outside of the range  $[1, \text{yrr\_max}]$ , where  $\text{yrr\_max} = (\text{OMX\_INT}) (((\text{OMX\_F32}) (\text{srcSize.height}\&\sim 1) - 1) / ((\text{dstSize.height}\&\sim 1) - 1)) * (1 \ll 16) + 0.5$ .
- `rcpRatiox` is outside of the range  $[1, \text{xrr\_max}]$ , where  $\text{xrr\_max} = (\text{OMX\_INT}) (((\text{OMX\_F32}) ((\text{srcSize.width}\&\sim 1) - 1) / ((\text{dstSize.width}\&\sim 1) - 1)) * (1 \ll 16) + 0.5$ .
- Each of `srcSize.width`, `srcSize.height`, `dstSize.width` and `dstSize.height`  $\leq 0$
- `pDst` is not aligned at 8 bytes boundary, `pSrc[0]` is not aligned at 4 bytes boundary, `pSrc[1]` is not aligned at 2 bytes boundary, or `pSrc[2]` is not aligned at 2 bytes boundary.
- `srcStep[0]`, `srcStep[1]`, `srcStep[2]` or `dstStep` is less than 1.
- `srcStep[0]` is not a multiple of 4, `srcStep[1]` is not multiple of 2, or `srcStep[2]` is not multiple of 2.
- `dstStep` is not a multiple of 8 when `colorConversion` is `OMX_IP_BGR565`, `OMX_IP_BGR555`, or `OMX_IP_BGR444`; `dstStep` is not multiple of 2 when `colorConversion` is `OMX_IP_BGR888`.
- `srcSize.width` is larger than `srcStep[0]`; `srcSize.width >> 1` is larger than half of `srcStep[1]` or `srcStep[2]`.
- Invalid values of one or more of the following control parameters:
  - `interpolation`
  - `colorConversion`
  - `rotation`
- `dstSize.height * bytes/pixel` of output image is larger than `dstStep` when rotation is `OMX_IP_ROTATE90L` or `OMX_IP_ROTATE90R`; `dstSize.width * bytes/pixel` of output image is larger than `dstStep` when other valid rotation options.

## Alignment Requirements

The starting address of `pDst` must be aligned at 8-byte boundary; and `dstStep` must be multiple of 8 when output format is `BGR444/555/565`, and `dstStep` must be multiple of 2 when output format is `BGR888`.

The starting address of `pSrc[0]` must be aligned at 4-byte boundary, `pSrc[1]` must be aligned at 2-boundary and `pSrc[2]` must be aligned at 2-boundary; and `srcStep[0]` must be multiple of 4, `srcStep[1]` must be multiple of 2 and `srcStep[2]` must be multiple of 2.

### Size of Output Image

The parameter `dstSize` specifies the size of the image after the resizing operation, but prior to the rotation operation.

An example is given below that demonstrates how to call the function `omxIPCS_YCbCr422RszCscRotBGR_U8_P3C3R`.

#### Example 4-5:

```
#include <stdio.h>
#include <stdlib.h>
#include "OMXIP.h"
#define _ALIGN8(adr) (((OMX_U32)(adr))+7)&(~7)
#define _ALIGN4(adr) (((OMX_U32)(adr))+3)&(~3)

OMXResult resize_rotate();

int main()
{
    resize_rotate();
}

OMXResult resize_rotate()
{
    OMX_U8    *pSrc1, *pSrc2, *pSrc3;
    OMX_U8    *pSrc[3];
    void      *pDst;
    OMXSize   srcSize, dstSize;
    OMXIPInterpolation .....
    OMX_INT   rcpRatioX, rcpRatioY;
    OMX_INT   srcStep[3], dstStep, size;
    OMX_INT   status;

    /* Initialize parameters */
    srcSize.width = 176;
    srcSize.height = 144;
    dstSize.width = 320;
    dstSize.height = 240;
    srcStep[0] = 176;
```

```

srcStep[1] = 88;
srcStep[2] = 88;
dstStep = 640;
colorConversion= OMX_IP_BGR565 ;
interpolation = OMX_IP_BILINEAR;
rotation      = OMX_IP_DISABLE;
rcpRatioX = (OMX_INT)(((double)((srcSize.width-
1)<<16))/(dstSize.width-1));
rcpRatioY = (OMX_INT)(((double)((srcSize.height-
1)<<16))/(dstSize.height-1));
size = dstSize.height * dstStep + 8;
pSrc1 = (OMX_U8*)malloc(srcSize.height*srcStep[0] + 8);
pSrc2 = (OMX_U8*)malloc((srcSize.height>>1)*srcStep[1] + 8);
pSrc3 = (OMX_U8*)malloc((srcSize.height>>1)*srcStep[2] + 8);
pSrc[0] = (OMX_U8*)_ALIGN4(pSrc1);
pSrc[1] = (OMX_U8*)_ALIGN4(pSrc2);
pSrc[2] = (OMX_U8*)_ALIGN4(pSrc3);
pDst = malloc(size);
pDst = (void*)_ALIGN8(pDst);

/* initialize the content of pSrc[0], pSrc[1] and pSrc[2] */
pSrc[0] = ...;
pSrc[1] = ...;
pSrc[2] = ...;

/* resize & rotate */
status = omxIPCS_YCbCr422RszCscRotBGR_U8_P3C3R(pSrc, srcStep,
srcSize, pDst, dstStep, dstSize, colorConversion, interpolate,
rotation, rcpRatioX, rcpRatioY);
return status;
}

```

## 4.4.3.6 Integrated CSC/Rotate

### 4.4.3.6.1 CbYCrY422ToYCbCr420Rotate\_U8\_C2P3R

#### Prototype

```
OMXResult omxIPCS_CbYCrY422ToYCbCr420Rotate_U8_C2P3R(const OMX_U8 *pSrc,  
    OMX_INT srcStep, OMX_U8 *pDst[3], OMX_INT dstStep[3], OMXSize roiSize,  
    OMXIPRotation rotation);
```

#### Description

CbYCrY422 to YCbCr420 planar format conversion with rotation function. This function decimates the color space of the input image from CbYCrY 422 to YCbCr 420, applies an optional rotation of -90, +90, or 180 degrees, and then rearranges the data from the pixel-oriented input format to a planar output format.

#### Input Arguments

- `pSrc` – pointer to the start of the buffer containing the pixel-oriented CbYCrY422 input; must be aligned on an 8-byte boundary.
- `srcStep` – distance, in bytes, between the start of lines in the source image; must be a multiple of 8.
- `dstStep` – a 3-element vector containing the distance, in bytes, between the start of lines in each of the output image planes. The parameter `dstStep[0]` must be a multiple of 8; the parameters `dstStep[1]` and `dstStep[2]` must be multiples of 4.
- `roiSize` – dimensions, in pixels, of the source and destination regions of interest
- `rotation` – rotation control parameter; must be set to one of the following pre-defined values: `OMX_IP_DISABLE`, `OMX_IP_ROTATE90L`, `OMX_IP_ROTATE90R`, or `OMX_IP_ROTATE180`.

#### Output Arguments

- `pDst` – a 3-element vector containing pointers to the start of each of the YCbCr420 output planes. The pointer `pDst[0]` must be aligned on an 8-byte boundary. The pointers `pDst[1]` and `pDst[2]` must be aligned on 4-byte boundaries.

#### Returns

If the function runs without error, it returns `OMX_Sts_NoErr`

If any of the following cases occurs, the function returns `OMX_Sts_BadArgErr`:

- `pSrc`, `pDst[0]`, `pDst[1]`, or `pDst[2]` is NULL
- `pSrc` or `pDst[0]` is not aligned at 8 bytes boundary
- `pDst[1]` or `pDst[2]` is not aligned at 4-byte boundary
- `srcStep`, `dstStep[1]`, `dstStep[2]`, or `dstStep[3]` is less than 1
- `srcStep` or `dstStep[0]` is not multiple of 8
- `dstStep[1]` or `dstStep[2]` is not multiple of 4
- `roiSize.width` is larger than half of `srcStep`
- Invalid values of rotation control parameters
- `dstStep[0]` is less than `roiSize.width`
- `dstStep[1]` or `dstStep[2]` is less than half `roiSize.width`

- `roiSize.width` or `roiSize.height` is less than 8

### Size of Output Image

If `roiSize.width` or `roiSize.height` cannot be divided by 8 exactly, it will be cut to be a multiple of 8.

#### Example 4-6:

```
#include <stdlib.h>
#include "OMXIP.h"

#define _ALIGN8(adr) (((OMX_U32)(adr))+7)&(~7)
#define _ALIGN4(adr) (((OMX_U32)(adr))+3)&(~3)

int main()
{
    OMX_INT W, H;
    OMX_U8 *pDst1, *pDst2, *pDst3;

    /* Variables used in Function */
    OMX_U8 *pSrc, *pDst[3];
    OMX_INT srcStep, dstStep[3];
    OMXSize roiSize;
    OMXIPInterpolation rotation;

    /* Initialize the width and height of input image */
    W = 320;
    H = 240;

    /* Initialize source parameters */
    rotation = OMX_IP_ROTATE180;
    roiSize.width = W;
    roiSize.height = H;
    srcStep = 640;
    dstStep[0] = 320;
    dstStep[1] = 160;
    dstStep[2] = 160;

    /* Allocate Buffer */
    pSrc = (OMX_U8*) malloc(W*H*2+7);
    pDst1 = (OMX_U8*) malloc(W*H+7);
```

```

pDst2 = (OMX_U8*) malloc(W*H/2+7);
pDst3 = (OMX_U8*) malloc(W*H/2+7);

/* Align buffer*/
pSrc = (OMX_U8*)_ALIGN8(pSrc);
pDst1 = (OMX_U8*)_ALIGN8(pDst1);
pDst2 = (OMX_U8*)_ALIGN4(pDst2);
pDst3 = (OMX_U8*)_ALIGN4(pDst3);

pDst[0] = pDst1;
pDst[1] = pDst2;
pDst[2] = pDst3;

/* Call omxIPCS_CbYCrY422ToYCbCr420Rotate_U8_C2P3R */
omxIPCS_CbYCrY422ToYCbCr420Rotate_U8_C2P3R(pSrc, srcStep, pDst,
dstStep, roiSize, rotation);

/* Free Buffer*/
free(pSrc);
free(pDst1);
free(pDst2);
free(pDst3);

return (0);
}

```

#### 4.4.3.6.2 YCbCr422ToYCbCr420Rotate\_U8\_P3R

##### Prototype

```

OMXResult omxIPCS_YCbCr422ToYCbCr420Rotate_U8_P3R(const OMX_U8 *pSrc[3],
OMX_INT srcStep[3], OMX_U8 *pDst[3], OMX_INT dstStep[3], OMXSize
roiSize, OMXIPRotation rotation);

```

##### Description

This function decimates the color space of the input image from YCbCr 422 planar data to YCbCr 420 planar data, and then applies an optional rotation of -90, +90, or 180 degrees. The difference between this function and omxIPCS\_CbYCrY422ToYCbCr420Rotate\_U8\_C2P3R is that this function supports the input YCbCr422 format in planar order.

## Input Arguments

- `pSrc` – a 3-element vector containing pointers to the start of each of the YCbCr422 input planes. The pointer `pSrc[0]` must be aligned on an 8-byte boundary; the pointers `pSrc[1]` and `pSrc[2]` must be aligned on a 4-byte boundaries.
- `srcStep` – a 3-element vector containing the distance, in bytes, between the start of lines in each of the input image planes. The parameter `srcStep[0]` must be a multiple of 8; the parameters `srcStep[1]` and `srcStep[2]` must multiples of 4.
- `dstStep` – a 3-element vector containing the distance, in bytes, between the start of lines in each of the output image planes. The parameter `dstStep[0]` must be a multiple of 8; the parameters `dstStep[1]` and `dstStep[2]` must multiples of 4.
- `roiSize` – dimensions, in pixels, of the source and destination regions of interest
- `rotation` – rotation control parameter; must be set to one of the following pre-defined values: `OMX_IP_DISABLE`, `OMX_IP_ROTATE90L`, `OMX_IP_ROTATE90R`, or `OMX_IP_ROTATE180`.

## Output Arguments

- `pDst` – a 3-element vector containing pointers to the start of each of the YCbCr420 output planes. The pointer `pDst[0]` must be aligned on an 8-byte boundary; the pointers `pDst[1]` and `pDst[2]` must be aligned on a 4-byte boundaries.

## Returns

If the function runs without error, it returns `OMX_Sts_NoErr`

The function returns `OMX_Sts_BadArgErr` if one or more of the following occurs:

- any pointer is `NULL`
- `pSrc[0]` or `pDst[0]` is not aligned on an 8-byte boundary
- `pSrc[1]`, `pSrc[2]`, `pDst[1]` or `pDst[2]` is not aligned on a 4-byte boundary
- any of the steps is less than 1
- `srcStep[0]` or `dstStep[0]` is not multiple of 8
- `srcStep[1]`, `srcStep[2]`, `dstStep[1]` or `dstStep[2]` is not multiple of 4
- `roiSize.width` is larger than `srcStep[0]`
- `roiSize.width` is larger than twice `srcStep[1]` or twice `srcStep[2]`
- invalid values of rotation control parameters
- `dstStep[0]` is less than `roiSize.width` of downsampled, color-converted and rotated image
- `dstStep[1]` or `dstStep[2]` is less than half `roiSize.width`
- `roiSize.width` or `roiSize.height` is less than 8.

## Size of Output Image

If the `roiSize.width` or `roiSize.height` cannot be divided by 8 exactly, it will be cut to be multiple of 8.

The following is an example of how to call the function  
`omxIPCS_YCbYCr422ToYCbCr420Rotate_U8_C2P3R`

### 4.4.3.7 JPEG-Specific RGB to YCbCr with Integrated Level Shift

The color conversion function defined below are provided to support MCU-based JPEG codec



construction. These functions convert RGB to YCbCr in the CCIR 601 color space. The following equations specify the mathematical definition of forward and inverse. Reference: [Hamil92].

(Y, Cb and Cr belong to [0, 1].)

- RGB -> YCbCr:
  - $Y = 0.29900 * R + 0.58700 * G + 0.11400 * B$
  - $Cb = -0.16874 * R - 0.33126 * G + 0.50000 * B + 0.5$
  - $Cr = 0.50000 * R - 0.41869 * G - 0.08131 * B + 0.5$
- YCbCr -> RGB:
  - $R = Y + 1.402(Cr-0.5)$
  - $G = Y - 0.34414(Cb-0.5) - 0.71414(Cr-0.5)$
  - $B = Y + 1.772(Cb-0.5)$

Level shift is integrated into the JPEG color conversion functions. So, the equations were modified as follows:

(Y, Cb and Cr belong to [-0.5, 0.5].)

- RGB -> YCbCr:
  - $Y = 0.29900 * R + 0.58700 * G + 0.11400 * B - 0.5$
  - $Cb = -0.16874 * R - 0.33126 * G + 0.50000 * B$
  - $Cr = 0.50000 * R - 0.41869 * G - 0.08131 * B$
- YCbCr -> RGB:
  - $R = (Y+0.5) + 1.402*Cr$
  - $G = (Y+0.5) - 0.34414*Cb - 0.71414*Cr$
  - $B = (Y+0.5) + 1.772*Cb$

The color conversion equations are implemented using integer data types and therefore the Y, Cb, and Cr channels are represented using Q8 such that each pixel takes a value between -128 and 127, inclusive.

#### 4.4.3.7.1 BGR888ToYCbCr444LS\_MCU\_U8\_S16\_C3P3

#### 4.4.3.7.2 BGR888ToYCbCr422LS\_MCU\_U8\_S16\_C3P3

#### 4.4.3.7.3 BGR888ToYCbCr420LS\_MCU\_U8\_S16\_C3P3

##### Prototype

```
OMXResult omxIPCS_BGR888ToYCbCr444LS_MCU_U8_S16_C3P3 (const OMX_U8 *pSrc,
    OMX_INT srcStep, OMX_S16 *pDstMCU[3]);
OMXResult omxIPCS_BGR888ToYCbCr422LS_MCU_U8_S16_C3P3 (const OMX_U8 *pSrc,
    OMX_INT srcStep, OMX_S16 *pDstMCU[3]);
OMXResult omxIPCS_BGR888ToYCbCr420LS_MCU_U8_S16_C3P3 (const OMX_U8 *pSrc,
    OMX_INT srcStep, OMX_S16 *pDstMCU[3]);
```

##### Description

These functions convert an input BGR888 MCU to one of the following sub-sampled color spaces with level-shift: YCbCr4:4:4, YCbCr4:2:2, and YCbCr4:2:0. The parameter pDstMCU[0] must point to the

start of a buffer with sufficient free space to contain the particular number of contiguously stored 8x8 Y blocks that constitute a complete MCU given the output chroma sub-sampling scheme, i.e., 1, 2, or 4 8x8 Y blocks for YCbCr 4:4:4, 4:2:2, or 4:2:0 output, respectively.

### Input Arguments

- `pSrc` – pointer to the source image data buffer. The source image data are stored in interleaved order as BGRBGRBGR... The image data buffer `pSrc` can support bottom-up storage formats. For bottom-up images, `srcStep` can be less than 0.
- `srcStep` – distance in bytes between the starts of consecutive lines in the source image; can be less than 0 to support bottom-up storage format.

### Output Arguments

- `pDstMCU[3]` – output MCU pointers. The parameter `pDstMCU[0]` must point to the start of a buffer with sufficient free space to contain the particular number of contiguously stored 8x8 Y blocks that constitute a complete MCU given the output chroma sub-sampling scheme, i.e., 1, 2, or 4 8x8 Y blocks for YCbCr 4:4:4, 4:2:2, or 4:2:0 output, respectively. The parameter `pDstMCU[1]` points to the Cb block, and the parameter `pDstMCU[2]` points to the Cr block. Output components are expressed using a Q8 representation and are bounded on the interval [-128, 127]. The buffers referenced by `pDstMCU[ ]` support top-down storage format only, and all pointers `pDstMCU[0..2]` must be 8-byte aligned.

### Returns

- `OMX_Sts_NoErr` – no error
- `OMX_Sts_BadArgErr` – one or more of the following bad argument conditions was detected:
  - a pointer was `NULL`
  - the absolute value of `srcStep` was smaller than 24 for YCbCr 444 or 48 for YCbCr422/ YCbCr 420
  - the start address of each pointer in `pDstMCU[ ]` was not 8-byte aligned

#### 4.4.3.7.4 BGR565ToYCbCr444LS\_MCU\_U16\_S16\_C3P3

#### 4.4.3.7.5 BGR565ToYCbCr422LS\_MCU\_U16\_S16\_C3P3

#### 4.4.3.7.6 BGR565ToYCbCr420LS\_MCU\_U16\_S16\_C3P3

### Prototype

```
OMXResult omxIPCS_BGR565ToYCbCr444LS_MCU_U16_S16_C3P3 (const OMX_U16 *pSrc,
    OMX_INT srcStep, OMX_S16 *pDstMCU[3]);
OMXResult omxIPCS_BGR565ToYCbCr422LS_MCU_U16_S16_C3P3 (const OMX_U16 *pSrc,
    OMX_INT srcStep, OMX_S16 *pDstMCU[3]);
OMXResult omxIPCS_BGR565ToYCbCr420LS_MCU_U16_S16_C3P3 (const OMX_U16 *pSrc,
    OMX_INT srcStep, OMX_S16 *pDstMCU[3]);
```

### Description

This function converts packed BGR565 image data to the following sub-sampled color spaces: YCbCr4:4:4, YCbCr4:2:2, and YCbCr4:2:0. The parameter `pDstMCU[0]` must point to the start of a buffer with sufficient free space to contain the particular number of contiguously stored 8x8 Y blocks that

constitute a complete MCU given the output chroma sub-sampling scheme, i.e., 1, 2, or 4 8x8 Y blocks for YCbCr 4:4:4, 4:2:2, or 4:2:0 output, respectively.

### Input Arguments

- `pSrc` – references the source image data buffer. Pixel intensities are interleaved as shown in Table 4-1, and G, B, and R are represented using, respectively, 6, 5, and 5 bits. The image data buffer `pSrc` supports bottom-up storage format, for which `srcStep` can be less than 0.
- `srcStep` – distance in bytes between the starts of consecutive lines in the source image; can be less than 0 to support bottom-up storage format.

### Output Arguments

- `pDstMCU[3]` – output MCU pointers. The parameter `pDstMCU[0]` must point to the start of a buffer with sufficient free space to contain the particular number of contiguously stored 8x8 Y blocks that constitute a complete MCU given the output chroma sub-sampling scheme, i.e., 1, 2, or 4 8x8 Y blocks for YCbCr 4:4:4, 4:2:2, or 4:2:0 output, respectively. The parameter `pDstMCU[1]` points to the Cb block, and the parameter `pDstMCU[2]` points to the Cr block. Output components are expressed using a Q8 representation and are bounded on the interval [-128, 127]. The buffers referenced by `pDstMCU[ ]` support top-down storage format only, and all pointers `pDstMCU[0..2]` must be 8-byte aligned.

### Returns

- `OMX_Sts_NoErr` – no error
- `OMX_Sts_BadArgErr` – bad arguments. Returned for any of the following conditions:
  - a pointer was `NULL`
  - `srcStep` was an odd number or its absolute value was less than 16 for YCbCr444 or 32 for YCbCr422/YCbCr420.
  - a pointer in `pDstMCU[ ]` was not 8-byte aligned

## 4.4.3.8 JPEG-Specific YCbCr to BGR with Integrated Level Shift

### 4.4.3.8.1 YCbCr444ToBGR888LS\_MCU\_S16\_U8\_P3C3

### 4.4.3.8.2 YCbCr422ToBGR888LS\_MCU\_S16\_U8\_P3C3

### 4.4.3.8.3 YCbCr420ToBGR888LS\_MCU\_S16\_U8\_P3C3

### Prototype

```
OMXResult omxIPCS_YCbCr444ToBGR888LS_MCU_S16_U8_P3C3(const OMX_S16
    *pSrcMCU[3], OMX_U8 *pDst, OMX_INT dstStep);
OMXResult omxIPCS_YCbCr422ToBGR888LS_MCU_S16_U8_P3C3(const OMX_S16
    *pSrcMCU[3], OMX_U8 *pDst, OMX_INT dstStep);
OMXResult omxIPCS_YCbCr420ToBGR888LS_MCU_S16_U8_P3C3(const OMX_S16
    *pSrcMCU[3], OMX_U8 *pDst, OMX_INT dstStep);
```

## Description

These functions convert sub-sampled YCbCr data to BGR888 data with level-shift. The parameter `pSrcMCU[0]` must point to the start of a sufficient number of contiguously stored 8x8 Y blocks to constitute a complete MCU given the source chroma sub-sampling scheme, i.e., 1, 2, or 4 blocks for YCbCr 4:4:4, 4:2:2, or YCbCr 4:2:0, respectively.

## Input Arguments

- `pSrcMCU` – buffer containing input MCU pointers: The parameter `pSrcMCU[0]` points to the first Y block, `pSrcMCU[1]` points to Cb the block, and `pSrcMCU[2]` points to the Cr block; all three pointers must be aligned on 8-byte boundaries. The parameter `pSrcMCU[0]` must point to the start of a sufficient number of contiguously stored 8x8 Y blocks to constitute a complete MCU given the source chroma sub-sampling scheme, i.e., 1, 2, or 4 blocks for YCbCr 4:4:4, 4:2:2, or YCbCr 4:2:0, respectively. Only top-down storage format is supported. Input components are expressed using a Q8 representation and are bounded on the interval [-128, 127].
- `dstStep` – distance in bytes between the starts of consecutive lines in the destination image; values less than 0 are allowed to support bottom-up storage format.

## Output Arguments

- `pDst` – points to the output image buffer in which the output data (C3 representation) are interleaved as follows: BGRBGRBGR... Bottom-up storage format is supported. Outputs are saturated to the OMX\_U8 range [0, 255]. The parameter `dstStep` can take negative values to support bottom-up storage format.

## Returns

- `OMX_Sts_NoErr` – no error
- `OMX_Sts_BadArgErr` – bad arguments. Returned if one or more of the following was true:
  - a pointer was NULL
  - the absolute value of `dstStep` was smaller than 24 (for YCbCr444) or 48 (for YCbCr422/YCbCr420)
  - a pointer in `pSrcMCU[ ]` was not 8-byte aligned

### 4.4.3.8.4 YCbCr444ToBGR565LS\_MCU\_S16\_U16\_P3C3

### 4.4.3.8.5 YCbCr422ToBGR565LS\_MCU\_S16\_U16\_P3C3

### 4.4.3.8.6 YCbCr420ToBGR565LS\_MCU\_S16\_U16\_P3C3

## Prototype

```
OMXResult omxIPCS_YCbCr444ToBGR565LS_MCU_S16_U16_P3C3 (const OMX_S16
    *pSrcMCU[3], OMX_U16 *pDst, OMX_INT dstStep);
OMXResult omxIPCS_YCbCr422ToBGR565LS_MCU_S16_U16_P3C3 (const OMX_S16
    *pSrcMCU[3], OMX_U16 *pDst, OMX_INT dstStep);
OMXResult omxIPCS_YCbCr420ToBGR565LS_MCU_S16_U16_P3C3 (const OMX_S16
    *pSrcMCU[3], OMX_U16 *pDst, OMX_INT dstStep);
```

## Description

These functions convert sub-sampled YCbCr data to BGR565 data with level-shift. The parameter `pSrcMCU[0]` must point to the start of a sufficient number of contiguously stored 8x8 Y blocks to constitute a complete MCU given the source chroma sub-sampling scheme, i.e., 1, 2, or 4 blocks for YCbCr 4:4:4, 4:2:2, or YCbCr 4:2:0, respectively.

## Input Arguments

- `pSrcMCU` – buffer containing input MCU pointers: `pSrcMCU[0]` points to the first Y block, `pSrcMCU[1]` points to Cb the block, and `pSrcMCU[2]` points to the Cr block; all three must be aligned on 8-byte boundaries. The parameter `pSrcMCU[0]` must point to the start of a sufficient number of contiguously stored 8x8 Y blocks to constitute a complete MCU given the source chroma sub-sampling scheme, i.e., 1, 2, or 4 blocks for YCbCr 4:4:4, 4:2:2, or YCbCr 4:2:0, respectively. Only top-down storage format is supported. Input components are represented using Q8 and are bounded on the interval [-128, 127].
- `dstStep` – distance in bytes between the starts of consecutive lines in the destination image; can take negative values to support bottom-up storage format.

## Output Arguments

- `pDst` – output image buffer pointer; data are interleaved as follows: [B G R B G R ...], where G is represented using 6 bits, and B and R are represented using 5 bits. Output components are saturated. The parameter `dstStep` can take negative values to support bottom-up storage.

## Returns

- `OMX_Sts_NoErr` – no error
- `OMX_Sts_BadArgErr` – bad arguments - returned if one or more of the following is true:
  - a pointer was `NULL`
  - the absolute value of `dstStep` was smaller than 16 (for YCbCr444) or 32 (for YCbCr422/YCbCr420)
  - a pointer in `pSrcMCU[ ]` was not 8-byte aligned

# 5.0 Image Coding

## 5

This section defines the functions and data types that comprise the OpenMAX DL image coding domain (omxIC) API, including functions that support construction of JPEG image codecs (omxICJP).

## 5.1 JPEG Sub-domain (omxICJP)

### 5.1.1 Definitions

#### 5.1.1.1 JPEG Coefficient Buffer Organization

The omxICJP coefficient buffers contain 8x8 blocks of 16-bit signed values.

Figure 5-1 illustrates the memory organization of omxICJP buffers for both interleaved (left side) and planar (right side) images. In the buffers shown in the figure, each square represents an 8x8 block. For each color space, the example shows the representation of two MCUs. In particular,

- (A) depicts the non-subsampled YCbCr4:4:4 buffer organization. Each MCU contains three blocks (1 Y, 1 Cb, 1 Cr) for the planar representation or one block (1 Y or 1 Cb or 1 Cr) for the interleaved representation.
- (B) depicts YCbCr4:2:2 buffer organization. Each MCU contains four blocks (2 Y, 1 Cb, 1 Cr) for the planar representation or in general (2N blocks in Y buffer, N blocks in Cb and Cr buffer). The interleaved representation contains one block (1Y or 1Cb or 1Cr).
- (C) depicts YCbCr4:2:0 buffer organization. Each MCU contains six blocks (4 Y, 1 Cb, 1 Cr) or in general (4N blocks in Y buffer, N blocks in Cb and Cr buffer). The interleaved representation or one block (1Y or 1Cb or 1Cr) for interleaved order.

The start address of each coefficient buffer must be aligned on an 8-byte boundary.

Figure 5-1: Interleaved and Non-Interleaved Image Data Formats

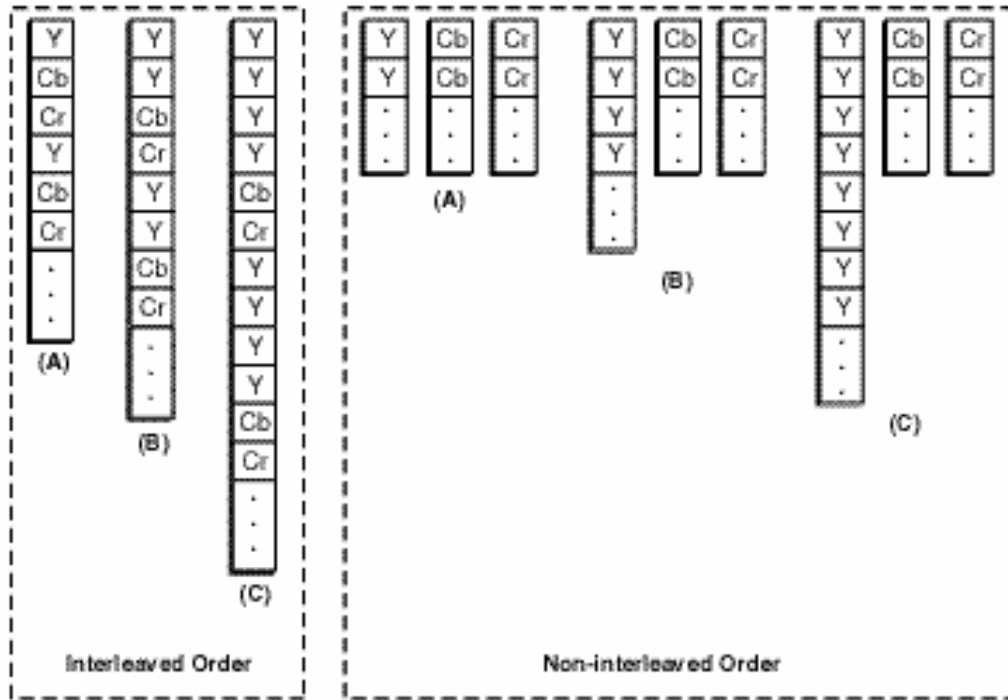

A0691-01

### 5.1.1.2 Image Representation

**Figure 5-2: Rectangle Of Interest (ROI) for Encoding Procedure**

Figure 5-2 illustrates the relationship between ROI, MCU of ROI, and the whole image data:

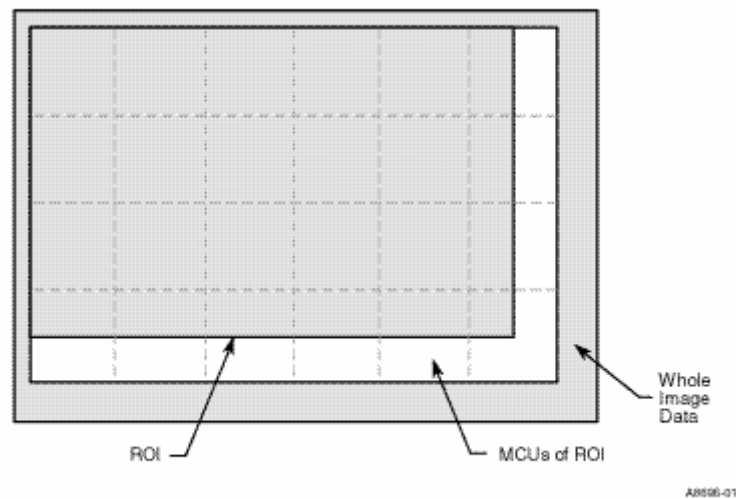

These parameters are used to indicate ROI:

- Start Pointer which points to the start address of ROI in the image data buffer
- Width is less than or equal to the width of the image
- Height is less than or equal to the height of the image
- Line Step of image data buffer

The procedure is:

1. Move the Start Pointer to indicate the start address of ROI.
2. Process MCUs on the boundary with padding function (Start Point, Width, Height, Line Step).
3. Encode each MCU

## 5.1.2 Data Structures

### 5.1.2.1 JPEG Markers

omxICJP\_Marker, a data type that enumerates JPEG markers, is defined as follows:

```
typedef enum {  
omxICJP_Marker_TEM    = 1,  
omxICJP_Marker_SOF0  = 192,  
omxICJP_Marker_SOF1  = 193,  
}
```



omxICJP\_Marker\_SOF2 = 194,  
omxICJP\_Marker\_SOF3 = 195,  
omxICJP\_Marker\_DHT = 196,  
omxICJP\_Marker\_SOF5 = 197,  
omxICJP\_Marker\_SOF6 = 198,  
omxICJP\_Marker\_SOF7 = 199,  
omxICJP\_Marker\_JPG = 200,  
omxICJP\_Marker\_SOF9 = 201,  
omxICJP\_Marker\_SOF10 = 202,  
omxICJP\_Marker\_SOF11 = 203,  
omxICJP\_Marker\_DAC = 204,  
omxICJP\_Marker\_SOF13 = 205,  
omxICJP\_Marker\_SOF14 = 206,  
omxICJP\_Marker\_SOF15 = 207,  
omxICJP\_Marker\_RST0 = 208,  
omxICJP\_Marker\_RST1 = 209,  
omxICJP\_Marker\_RST2 = 210,  
omxICJP\_Marker\_RST3 = 211,  
omxICJP\_Marker\_RST4 = 212,  
omxICJP\_Marker\_RST5 = 213,  
omxICJP\_Marker\_RST6 = 214,  
omxICJP\_Marker\_RST7 = 215,  
omxICJP\_Marker\_SOI = 216,  
omxICJP\_Marker\_EOI = 217,  
omxICJP\_Marker\_SOS = 218,  
omxICJP\_Marker\_DQT = 219,  
omxICJP\_Marker\_DNL = 220,  
omxICJP\_Marker\_DRI = 221,  
omxICJP\_Marker\_DHP = 222,  
omxICJP\_Marker\_EXP = 223,  
omxICJP\_Marker\_APP0 = 224,  
omxICJP\_Marker\_APP1 = 225,  
omxICJP\_Marker\_APP2 = 226,  
omxICJP\_Marker\_APP3 = 227,  
omxICJP\_Marker\_APP4 = 228,  
omxICJP\_Marker\_APP5 = 229,  
omxICJP\_Marker\_APP6 = 230,  
omxICJP\_Marker\_APP7 = 231,  
omxICJP\_Marker\_APP8 = 232,  
omxICJP\_Marker\_APP9 = 233,  
omxICJP\_Marker\_APP10 = 234,  
omxICJP\_Marker\_APP11 = 235,  
omxICJP\_Marker\_APP12 = 236,  
omxICJP\_Marker\_APP13 = 237,  
omxICJP\_Marker\_APP14 = 238,  
omxICJP\_Marker\_APP15 = 239,  
omxICJP\_Marker\_JPG0 = 240,  
omxICJP\_Marker\_JPG1 = 241,  
omxICJP\_Marker\_JPG2 = 242,  
omxICJP\_Marker\_JPG3 = 243,  
omxICJP\_Marker\_JPG4 = 244,  
omxICJP\_Marker\_JPG5 = 245,  
omxICJP\_Marker\_JPG6 = 246,  
omxICJP\_Marker\_JPG7 = 247,

```

omxICJP_Marker_JPG8 = 248,
omxICJP_Marker_JPG9 = 249,
omxICJP_Marker_JPG10 = 250,
omxICJP_Marker_JPG11 = 251,
omxICJP_Marker_JPG12 = 252,
omxICJP_Marker_JPG13 = 253,
omxICJP_Marker_COM = 254
} omxICJP_Marker;

```

### 5.1.2.2 Vendor-Specific Data Structures

The following vendor-specific Huffman specification structures are required to support the Huffman encoder and decoder functions. Helper functions are defined to maintain portability.

- void OMXICJPHuffmanEncodeSpec
- void OMXICJPHuffmanDecodeSpec

## 5.1.3 Functions

### 5.1.3.1 Copy with Padding

#### 5.1.3.1.1 CopyExpand\_U8\_C3

##### Prototype

```

OMXResult omxICJP_CopyExpand_U8_C3(const OMX_U8 *pSrc, OMX_INT srcStep,
    OMXSize srcSize, OMX_U8 *pDst, OMX_INT dstStep, OMXSize dstSize);

```

##### Description

This function copies an image block from the source image buffer to the destination image buffer. If the size of the destination block is larger than the size of the source block, then the function affects pixel expansion by filling extra space in the destination block with copies of pixel values from the edges of the source block. This function is intended for use in the JPEG encoder for completion of partial MCUs (e.g., BGR8:8:8, RGB8:8:8) along the vertical and horizontal image boundaries prior to conversion to the target encoded color space. As such, the destination block must be of size larger than or equal to the source block, and must have standard JPEG MCU [ISO10918-1] dimensions of either 8x8, 8x16, 16x8, or 16x16 horizontal by vertical pixels. Both top-down and bottom-up storage are supported, and are indicated, respectively, via positive and negative values for the parameters `srcStep/dstStep`. For example, given positive source and destination step values (top-down source and destination images), the function copies the source block to the destination block, and pads the the extra space in the destination block to the right of the source block boundary with copies of the right-most pixel from the source block on each scanline. Similarly, any extra space in the larger destination block below the source block boundary is padded with copies of the bottom-most pixel from the source block. This function supports only interleaved (C3) image blocks.

##### Input Arguments

- `pSrc` – pointer to the source block

- `srcStep` – distance in bytes between the starts of consecutive lines in the source image; a positive value may be used to indicate top-down storage, or a negative value may be used to indicate bottom-up storage
- `srcSize` – size of the source block
- `dstStep` – distance in bytes between the starts of consecutive lines in the destination image; a positive value may be used to indicate top-down storage, or a negative value may be used to indicate bottom-up storage
- `dstSize` – size of destination block; if `dstSize > srcSize` then pixel expansion is applied.

### Output Arguments

- `pDst` – pointer to the destination buffer

### Returns

- `OMX_Sts_NoErr` – no error
- `OMX_Sts_BadArgErr` – bad arguments; returned under one or more of the following conditions:
  - a pointer was `NULL`
  - one of the source or destination region rectangle dimensions was equal to 0
  - `dstSize` is not equal to one of the following: `{8,8}`, `{8,16}`, `{16,8}`, or `{16,16}`.
  - `srcSize.width > dstSize.width`.
  - `srcSize.height > dstSize.height`.
  - either `|srcStep| < 3` or `|dstStep| < 3`

### 5.1.3.2 Forward DCT and Quantization

The forward DCT (FDCT) and inverse DCT (IDCT) used in all DCT/DCTQuant/IDCT/IDCTQuantInv functions defined in section 5.1.3.2 and 5.1.3.3 are given by

$$S_{vu} = \frac{1}{4} C_u C_v \sum_{x=0}^7 \sum_{y=0}^7 s_{yx} \cos \frac{(2x+1)u\pi}{16} \cos \frac{(2y+1)v\pi}{16}$$

$$S_{yx} = \frac{1}{4} \sum_{u=0}^7 \sum_{v=0}^7 C_u C_v s_{vu} \cos \frac{(2x+1)u\pi}{16} \cos \frac{(2y+1)v\pi}{16}$$

where

$$C_u, C_v = 1/\sqrt{2} \text{ for } u, v = 0$$

otherwise

$$C_u, C_v = 1$$

The quantization and inverse quantization operations are defined as follows.

$$Sq_{v,u} = \text{round\_up} \left( \frac{R_{v,u}}{Q_{v,u}} \right)$$

$$R_{v,u} = Sq_{v,u} \times Q_{v,u}$$

## Reference

[ITUCCITT81], section A.3.3, FDCT and IDCT equations.

### 5.1.3.2.1 DCTQuantFwdTableInit

#### Prototype

```
OMXResult omxICJP_DCTQuantFwdTableInit(const OMX_U8 *pQuantRawTable,
    OMX_U16 *pQuantFwdTable);
```

#### Description

Initializes the JPEG DCT quantization table for 8-bit per component image data.

#### Input Arguments

- `pQuantRawTable` – pointer to the raw quantization table; must be arranged in raster scan order and aligned on an 8-byte boundary. The table must contain 64 entries. Table entries should lie within the range [1,255].

#### Output Arguments

- `pQuantFwdTable` – pointer to the initialized quantization table; must be aligned on an 8-byte boundary. The table must contain 64 entries, and the implementation-specific contents must match the table contents expected by the associated set of forward DCT quantization functions in the same OpenMAX DL implementation, including the functions `DCTQuantFwd_S16`, `DCTQuantFwd_S16_I`, and `DCTQuantFwd_Multiple_S16`.

#### Returns

- `OMX_Sts_NoErr` – no error
- `OMX_Sts_BadArgErr` – Bad arguments. Returned for any of the following conditions:
  - a pointer was `NULL`
  - the start address of a pointer was not 8-byte aligned.
  - one or more of the entries is equal to 0 in the table referenced by `pQuantRawTable`.

## Reference

[ITUCCITT81], section A.3.3 FDCT equation, and section A.3.4.

### 5.1.3.2.2 DCTQuantFwd\_S16

#### Prototype

```
OMXResult omxICJP_DCTQuantFwd_S16 (const OMX_S16 *pSrc, OMX_S16 *pDst, const
    OMX_U16 *pQuantFwdTable);
```

#### Description

Computes the forward DCT and quantizes the output coefficients for 8-bit image data; processes a single 8x8 block.

#### Input Arguments

- `pSrc` – pointer to the input data block (8x8) buffer; must be arranged in raster scan order and 8-byte aligned. The input components should be bounded on the interval [-128, 127].
- `pQuantFwdTable` – pointer to the 64-entry quantization table generated using `DCTQuantFwdTableInit`; must be aligned on an 8-byte boundary.

#### Output Arguments

- `pDst` – pointer to the output transform coefficient block (8x8) buffer; must be 8-byte aligned. The output 8x8 matrix is the transpose of the explicit result; this transpose will be handled in Huffman encoding.

#### Returns

- `OMX_Sts_NoErr` – no error
- `OMX_Sts_BadArgErr` – Bad arguments. Returned for any of the following conditions:
  - a pointer was NULL
  - one of the following pointers not 8-byte aligned: `pSrc`, `pDst`, or `pQuantFwdTable`.

#### Reference

[ITUCCITT81], section A.3.3 FDCT equation, and section A.3.4.

### 5.1.3.2.3 DCTQuantFwd\_S16\_I

#### Prototype

```
OMXResult omxICJP_DCTQuantFwd_S16_I (OMX_S16 *pSrcDst, const OMX_U16
    *pQuantFwdTable);
```

#### Description

Computes the forward DCT and quantizes the output coefficients for the 8-bit image data in-place; processes a single 8x8 block.

#### Input Arguments

- `pSrcDst` – pointer to input data block (8x8) buffer for in-place processing; must be arranged in raster scan order and 8-byte aligned. The input components should be bounded on the interval [-128, 127].

- `pQuantFwdTable` – pointer to the 64 entry quantization table generated using `DCTQuantFwdTableInit`; must be aligned on an 8-byte boundary.

### Output Arguments

- `pSrcDst` – pointer to the in-place output coefficient block (8x8) buffer; must be 8-byte aligned. The output 8x8 matrix is the transpose of the explicit result; this transpose will be handled in Huffman encoding.

### Returns

- `OMX_Sts_NoErr` – no error
- `OMX_Sts_BadArgErr` – Bad arguments. Returned for any of the following conditions:
  - a pointer was `NULL`
  - one of the following pointers not 8-byte aligned: `pSrcDst`, `pQuantFwdTable`.

### Reference

[ITUCCITT81], section A.3.3 FDCT equation, and section A.3.4.

## 5.1.3.2.4 DCTFwd\_S16

### Prototype

```
OMXResult omxICJP_DCTFwd_S16(const OMX_S16 *pSrc, OMX_S16 *pDst);
```

### Description

Performs an 8x8 block forward discrete cosine transform (DCT). This function implements forward DCT for the 8-bit image data (packed into signed 16-bit). The output matrix is the transpose of the explicit result. As a result, the Huffman coding functions in this library handle transpose as well.

### Input Arguments

- `pSrc` – pointer to the input data block (8x8) buffer. The data must be arranged in raster scan order, and the buffer start address must be 8-byte aligned. The input components are bounded on the interval  $[-128, 127]$ .

### Output Arguments

- `pDst` – pointer to the output DCT coefficient block(8x8) buffer. This start address must be 8-byte aligned. To achieve better performance, the output 8x8 matrix is the transpose of the explicit result. This transpose can be handled in later processing stages (e.g. Huffman encoding).

### Returns

- `OMX_Sts_NoErr` – no error
- `OMX_Sts_BadArgErr` – Bad arguments. Returned for any of the following conditions:
  - a pointer was `NULL`
  - the start address of a pointer was not 8-byte aligned.

## Reference

[ITUCCITT81], section A.3.3, FDCT equation.

### 5.1.3.2.5 DCTFwd\_S16\_I

#### Prototype

```
OMXResult omxICJP_DCTFwd_S16_I(OMX_S16 *pSrcDst);
```

#### Description

This function implements forward DCT for the 8-bit image data (packed into signed 16-bit). It processes one block (8x8) in-place. The output matrix is the transpose of the explicit result. As a result, the Huffman coding functions in this library handle transpose as well.

#### Input-Output Arguments

- `pSrcDst` – pointer to the input data block (8x8) buffer for in-place processing. The data must be arranged in raster scan order, and the buffer base address must be 8-byte aligned. The input components are bounded on the interval [-128, 127] within a 16-bit container. The output 8x8 matrix is the transpose of the explicit result. This transpose can be handled in later processing stages (e.g. Huffman encoding).

#### Returns

- `OMX_Sts_NoErr` – no error
- `OMX_Sts_BadArgErr` – Bad arguments. Returned for any of the following conditions:
  - a pointer was NULL
  - `pSrcDst` was not 8-byte aligned.

## Reference

[ITUCCITT81], section A.3.3, FDCT equation.

### 5.1.3.2.6 DCTQuantFwd\_Multiple\_S16

#### Prototype

```
OMXResult omxICJP_DCTQuantFwd_Multiple_S16 (const OMX_S16 *pSrc, OMX_S16 *pDst, OMX_INT nBlocks, const OMX_U16 *pQuantFwdTable);
```

#### Description

This function implements forward DCT with quantization for 8-bit image data. It processes multiple adjacent blocks (8x8). The blocks are assumed to be part of a planarized buffer. This function should be called separately for luma and chroma buffers with the respective quantization table. The output matrix is the transpose of the explicit result. As a result, the Huffman coding functions in this library handle transpose as well.

## Input Arguments

- `pSrc` – pointer to the start of the first 8x8 block in the input buffer, which should contain `nBlocks` blocks of 8 x 8 image data. The data within each block must be arranged in raster scan order, and the start address must be 8-byte aligned. The input components are bounded on the interval [-128, 127] within a signed 16-bit container. Each 8x8 block in the buffer is stored as 64 entries (16-bit) linearly in a buffer, and the multiple blocks must be stored contiguously.
- `pQuantFwdTable` – pointer to the 64-entry quantization table generated by "DCTQuantFwdTableInit." must be 8-byte aligned.
- `nBlocks` – the number of 8x8 blocks to be processed.

## Output Arguments

- `pDst` – pointer to the start of the first 8x8 output coefficient block in the multi-block coefficient output buffer. The start address must be 8-byte aligned. To achieve better performance, the output 8x8 matrices are the transpose of the explicit results for each of the `nBlocks` blocks. This transpose will be handled in Huffman encoding.

## Returns

- `OMX_Sts_NoErr` – no error
- `OMX_Sts_BadArgErr` – Bad arguments. Returned for any of the following conditions:
  - a pointer was `NULL`
  - one of the following pointers not 8-byte aligned: `pSrc`, `pDst`, or `pQuantFwdTable`.

## Reference

[ITUCCITT81], section A.3.3, FDCT equation.

## 5.1.3.3 Inverse DCT and Inverse Quantization

### 5.1.3.3.1 DCTQuantInvTableInit

#### Prototype

```
OMXResult omxICJP_DCTQuantInvTableInit(const OMX_U8 *pQuantRawTable,  
    OMX_U32 *pQuantInvTable);
```

#### Description

Initializes the JPEG IDCT inverse quantization table for 8-bit image data.

#### Input Arguments

- `pQuantRawTable` – pointer to the raw (unprocessed) quantization table, containing 64 entries; must be arranged in raster scan order and aligned on an 8-byte boundary. Table entries should lie within the range [1,255].



## Output Arguments

- `pQuantInvTable` – pointer to the initialized inverse quantization table; must be aligned on an 8-byte boundary. The table must contain 64 entries, and the implementation-specific contents must match the table contents expected by the associated set of inverse DCT quantization functions in the same OpenMAX DL implementation, including the functions `DCTQuantInv_S16`, `DCTQuantInv_S16_I`, and `DCTQuantInv_Multiple_S16`.

## Returns

- `OMX_Sts_NoErr` – no error
- `OMX_Sts_BadArgErr` – Bad arguments. Returned for any of the following conditions:
  - a pointer was `NULL`
  - the start address of a pointer was not 8-byte aligned.
  - one or more of the entries is equal to 0 in the table referenced by `pQuantRawTable`.

## Reference

[ITUCCITT81], section A.3.3 IDCT equation, and section A.3.4.

### 5.1.3.3.2 DCTQuantInv\_S16

#### Prototype

```
OMXResult omxICJP_DCTQuantInv_S16(const OMX_S16 *pSrc, OMX_S16 *pDst, const
    OMX_U32 *pQuantInvTable);
```

#### Description

Computes an inverse DCT and inverse quantization for 8-bit image data; processes one block (8x8).

#### Input Arguments

- `pSrc` – pointer to the input coefficient block (8x8) buffer; must be arranged in raster scan order and 8-byte aligned. Buffer values should lie in the range [-2040, 2040].
- `pQuantInvTable` – pointer to the quantization table initialized using the function `DCTQuantInvTableInit`. The table contains 64 entries and the start address must be 8-byte aligned.

#### Output Arguments

- `pDst` – pointer to the output pixel block (8x8) buffer; must be 8-byte aligned.

#### Returns

- `OMX_Sts_NoErr` – no error
- `OMX_Sts_BadArgErr` – Bad arguments. Returned for any of the following conditions:
  - a pointer was `NULL`
  - one of the following pointers was not 8-byte aligned: `pSrc`, `pDst`, `pQuantInvTable`.

## Reference

[ITUCCITT81], section A.3.3 IDCT equation, and section A.3.4.

### 5.1.3.3.3 DCTQuantInv\_S16\_I

#### Prototype

```
OMXResult omxICJP_DCTQuantInv_S16_I (OMX_S16 *pSrcDst, const OMX_U32
    *pQuantInvTable);
```

#### Description

Computes an inverse DCT and inverse quantization for 8-bit image data; processes one block (8x8) in-place.

#### Input Arguments

- `pSrcDst` – pointer to the input coefficient block/output pixel block buffer (8x8) for in-place processing; must be arranged in raster scan order and 8-byte aligned. Buffer values should lie in the range [-2040, 2040].
- `pQuantInvTable` – pointer to the quantization table initialized using the function `DCTQuantInvTableInit`. The table contains 64 entries and the start address must be 8-byte aligned.

#### Output Arguments

- `pSrcDst` – pointer to the in-place output pixel block(8x8) buffer; must be 8-byte aligned.

#### Returns

- `OMX_Sts_NoErr` – no error
- `OMX_Sts_BadArgErr` – Bad arguments. Returned for any of the following conditions:
  - a pointer was NULL
  - one of the following pointers was not 8-byte aligned: `pSrcDst`, `pQuantInvTable`.

## Reference

[ITUCCITT81], section A.3.3 IDCT equation, and section A.3.4.

### 5.1.3.3.4 DCTInv\_S16

#### Prototype

```
OMXRESULT OMXResult omxICJP_DCTInv_S16(const OMX_S16 *pSrc, OMX_S16 *pDst);
```

#### Description

This function implements inverse DCT for 8-bit image data. It processes one block (8x8).

### Input Arguments

- `pSrc` – pointer to the input DCT coefficient block (8x8) buffer; must be arranged in raster scan order, and the start address must be 8-byte aligned. Buffer values should lie in the range [-2040, 2040].

### Output Arguments

- `pDst` – pointer to the output image pixel data block(8x8) buffer. The start address must be 8-byte aligned.

### Returns

- `OMX_Sts_NoErr` – no error
- `OMX_Sts_BadArgErr` – Bad arguments. Returned for any of the following conditions:
  - a pointer was NULL
  - the start address of a pointer was not 8-byte aligned.

### Reference

[ITUCCITT81], section A.3.3, IDCT equation.

## 5.1.3.3.5 DCTInv\_S16\_I

### Prototype

```
OMXResult omxICJP_DCTInv_S16_I(OMX_S16 *pSrcDst);
```

### Description

This function implements an in-place inverse DCT for 8-bit image data. It processes one block (8x8).

### Input-Output Arguments

- `pSrcDst` – pointer to the in-place input DCT coefficient block (8x8) buffer and output image pixel data buffer; must be arranged in raster scan order and 8-byte aligned. Buffer values should lie in the range [-2040, 2040].

### Returns

- `OMX_Sts_NoErr` – no error
- `OMX_Sts_BadArgErr` – Bad arguments. Returned for any of the following conditions:
  - `pSrcDst` was NULL
  - `pSrcDst` was not 8-byte aligned.

### Reference

[ITUCCITT81], section A.3.3, IDCT equation.

### 5.1.3.3.6 DCTQuantInv\_Multiple\_S16

#### Prototype

```
OMXResult omxICJP_DCTQuantInv_Multiple_S16(const OMX_S16 *pSrc, OMX_S16
    *pDst, OMX_INT nBlocks, const OMX_U32 *pQuantInvTable);
```

#### Description

Multiple block dequantization and IDCT function. This function implements inverse DCT with dequantization for 8-bit image data. It processes multiple blocks (each 8x8). The blocks are assumed to be part of a planarized buffer. This function should be called separately for luma and chroma buffers with the respective quantization table. The start address of `pQuantInvTable` must be 8-byte aligned.

#### Input Arguments

- `pSrc` – pointer to the start of the first 8x8 coefficient block in the input buffer, which should contain a total of `nBlocks x 8 x 8` coefficients stored contiguously. The coefficients within each block must be arranged in raster scan order, and the start address must be 8-byte aligned. Buffer values should lie in the range [-2040, 2040].
- `nBlocks` – the number of 8x8 blocks to be processed.
- `pQuantInvTable` – pointer to the quantization table initialized using the function `DCTQuantInvTableInit`. The table contains 64 entries and the start address must be 8-byte aligned..

#### Output Arguments

- `pDst` – pointer to the start of the first 8x8 output pixel block in the multi-block output buffer; must be 8-byte aligned. The buffer referenced by `pDst` must have sufficient free space to contain `nBlocks` blocks of 8x8 pixels stored contiguously.

#### Returns

- `OMX_Sts_NoErr` – no error
- `OMX_Sts_BadArgErr` – Bad arguments. Returned for any of the following conditions:
  - one or more of the following pointers was NULL: `pSrc`, `pDst`, or `pQuantInvTable`
  - one or more of the following pointers was not 8-byte aligned: `pSrc`, `pDst`, or `pQuantInvTable`.

#### Reference

[ITUCCITT81], section A.3.3 IDCT equation, and section A.3.4.

## 5.1.3.4 Huffman Encoding

### 5.1.3.4.1 EncodeHuffmanSpecGetBufSize\_U8

#### Prototype

```
OMXResult omxICJP_EncodeHuffmanSpecGetBufSize_U8 (OMX_INT *pSize);
```

## Description

Returns the size, in bytes, of the buffer required to store the Huffman encoder table.

## Input Arguments

- none

## Output Arguments

- pSize - pointer to the size

## Returns

- OMX\_Sts\_NoErr - no error
- OMX\_Sts\_BadArgErr - bad arguments
  - a pointer was NULL

### 5.1.3.4.2 EncodeHuffmanSpecInit\_U8

## Prototype

```
OMXResult omxICJP_EncodeHuffmanSpecInit_U8 (const OMX_U8 *pHuffBits, const  
      OMX_U8 *pHuffValue, OMXICJPHuffmanEncodeSpec *pHuffTable);
```

## Description

Initializes the DC or AC Huffman encoder table specification structure. The helper function omxICJP\_EncodeHuffmanSpecGetBufSize\_U8 may be used to obtain the minimum necessary size, in bytes, of the buffer that will be required to contain the initialized structure \*pHuffTable.

## Input Arguments

- pHuffBits - pointer to the array of HUFFBITS, which contains the number of Huffman codes for size 1-16.
- pHuffValue - pointer to the array of HUFFVAL, which contains the symbol values to be associated with the Huffman codes ordering by size.
- pHuffTable – pointer to a buffer with sufficient free space to contain the initialized OMXICJPHuffmanEncodeSpec output. The buffer size, in bytes, should be equal to the value of the parameter \*pSize returned by the function omxICJP\_EncodeHuffmanSpecGetBufSize\_U8. Must be aligned on a 4-byte boundary.

## Output Arguments

- pHuffTable – pointer to an initialized OMXICJPHuffmanEncodeSpec data structure; must be aligned on a 4-byte boundary.

## Returns

- OMX\_Sts\_NoErr – no error
- OMX\_Sts\_BadArgErr – Bad arguments. Returned for any of the following conditions:
  - a pointer was NULL

## Reference

[ITUCCITT81], section C.2 and figures C-1 through C-3.

### 5.1.3.4.3 EncodeHuffman8x8\_Direct\_S16\_U1\_C1

#### Prototype

```
OMXResult omxICJP_EncodeHuffman8x8_Direct_S16_U1_C1 (const OMX_S16 *pSrc,  
    OMX_U8 *pDst, OMX_INT *pSrcDstBitsLen, OMX_S16 *pDCPred, const  
    OMXICJPHuffmanEncodeSpec *pDCHuffTable, const OMXICJPHuffmanEncodeSpec  
    *pACHuffTable);
```

#### Description

Implements the Huffman encoder for baseline mode. The input raster scanned source data block (8x8) is zigzag scanned, prior to encoding. To match the transposed order of the input DCT, an implicit transpose of the source data block is integrated into the zigzag scan.

The DC prediction coefficient (\*pDCPred) should be initialized to zero and reset to zero after every restart interval. Example 5-1 illustrates Huffman encoder buffer behavior.

#### Input Arguments

- pSrc – pointer to the source data block (8x8), in transposed order; must be aligned on a 32-byte boundary.
- pDCHuffTable – pointer to the OMXICJPHuffmanEncodeSpec data structure containing the DC Huffman encoder table; must be aligned on a 4-byte boundary.
- pACHuffTable – pointer to the OMXICJPHuffmanEncodeSpec data structure containing the AC Huffman encoder table; must be aligned on a 4-byte boundary.
- pSrcDstBitsLen – pointer to the next available bit in the output buffer (pDst); informs the Huffman encoder of where to start writing the output bits for the current block. To accommodate a non-empty pDst buffer upon function entry, the parameter pSrcDstBitsLen indicates the position of the current bit (output start position) as an offset relative to pDst, or equivalently, the buffer length upon entry in terms of bits. The number of bytes contained in the output buffer is given by  $pSrcDstBitsLen \gg 3$ , the number of bits contained in the current byte is given by  $pSrcDstBitsLen \& 0x7$ , and the number of bits free in the current byte is given by  $8 - (pSrcDstBitsLen \& 0x7)$ . There is no restriction on buffer length. It is the responsibility of the caller to maintain the buffer and limit its length as appropriate for the target application or environment. The value \*pSrcDstBitsLen is updated upon return as described below under “Output Arguments”. The parameter pSrcDstBitsLen must be aligned on a 4-byte boundary.
- pDCPred – pointer to the DC prediction coefficient. Upon input should contain the value of the quantized DC coefficient from the most recently coded block. Updated upon return as described below; must be aligned on a 4-byte boundary.

## Output Arguments

- `pDst` – pointer to the first byte in the JPEG output bitstream buffer both upon function entry and upon function return, i.e., the function does not modify the value of the pointer. The next available bit in the buffer is indexed by the parameter `pSrcDstBitsLen`, i.e., for a buffer of non-zero length, the value of the last bit written during the Huffman block encode operation is given by  $(pDst[currentByte] \gg currentBit) \& 0x1$ , where  $currentByte = (pSrcDstBitsLen - 1) \gg 3$ , and  $currentBit = 7 - ((pSrcDstBitsLen - 1) \& 0x7)$ . Within each byte, bits are filled from most significant to least significant, and buffer contents are formatted in accordance with CCITT T.81. The pointer `pDst` must be aligned on a 4-byte boundary.
- `pSrcDstBitsLen` – pointer to the next available bit position in the output buffer (`pDst`) following the block Huffman encode operation; informs the caller of where the Huffman encoder stopped writing bits for the current block. The updated value `*pSrcDstBitsLen` indexes the position following the last bit written to the output buffer relative to `pDst`, or equivalently, it indicates the updated number of bits contained in the output buffer after block encoding has been completed. Usage guidelines apply as described above under “Input Arguments.”
- `pDCPred` – pointer to the DC prediction coefficient. Updated upon return to contain the DC coefficient from the current block; the pointer must be aligned on a 4-byte boundary.

## Returns

- `OMX_Sts_NoErr` – no error
- `OMX_Sts_BadArgErr` – Bad arguments. Returned for any of the following conditions:
  - a pointer was `NULL`
  - the start address of a pointer was not 4-byte aligned.
  - `*pDstBitsLen` was less than 0.

## Reference

[ITUCCITT81], Annex D-1.

### Example 5-1: Huffman Encoder Buffer Pointer Behavior

The figure below shows an example Huffman output buffer containing five data bits (indicated by green shading) upon function entry. The pointer `pDst` points to the first byte in the buffer, and the location of the first available bit in the buffer is indexed by the value `*pSrcDstBitLen==5`. As a result, the Huffman encoder will start writing new data into bit cell 2 of byte 0x00.

#### Huffman Encoder Output Buffer Upon Entry

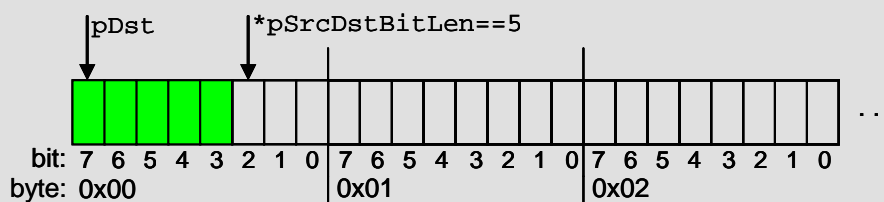

If the Huffman encoder generates a total of 4 new bits during the current block

encoding operation, then upon return the updated buffer would be modified as follows:

#### Huffman Encoder Output Buffer Upon Return

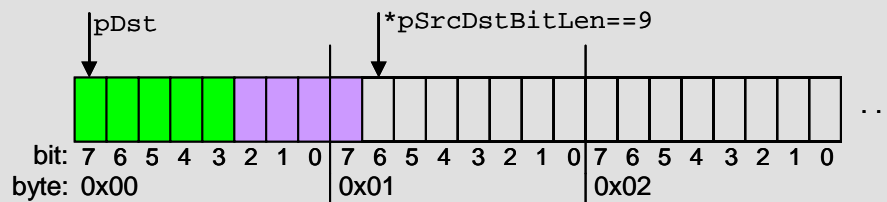

The encoder would write the new bits (as indicated by violet shading), and increase the bit index (buffer length in terms of bits) from the input value of 5 to the output value of 9. Note that the value of the pointer *pDst* is not modified by the function.

### 5.1.3.5 Huffman Decoding

#### 5.1.3.5.1 DecodeHuffmanSpecGetBufSize\_U8

##### Prototype

```
OMXResult omxICJP_DecompileHuffmanSpecGetBufSize_U8 (OMX_INT *pSize);
```

##### Description

Returns the size, in bytes, of the buffer required to store the Huffman decoder table.

##### Input Arguments

- none

##### Output Arguments

- *pSize* - pointer to the size

##### Returns

- *OMX\_Sts\_NoErr* - no error
- *OMX\_Sts\_BadArgErr* - bad arguments
- If following conditions are not satisfied, this function returns *OMX\_Sts\_BadArgErr*:
  - pointer cannot be NULL



### 5.1.3.5.2 DecodeHuffmanSpecInit\_U8

#### Prototype

```
OMXResult omxICJP_DecodeHuffmanSpecInit_U8 (const OMX_U8 *pHuffBits, const
      OMX_U8 *pHuffValue, OMXICJPHuffmanDecodeSpec *pHuffTable);
```

#### Description

Initializes the DC or AC Huffman decoder table specification.

#### Input Arguments

- `pHuffBits` – Pointer to the array of HUFFBITS, which contains the number of Huffman codes for size 1-16
- `pHuffValue` – Pointer to the array of HUFFVAL, which contains the symbol values to be associated with the Huffman codes ordering by size

#### Output Arguments

- `pHuffTable` – pointer to a `OMXICJPHuffmanDecodeSpec` data structure; must be aligned on a 4-byte boundary.

#### Returns

- `OMX_Sts_NoErr` – no error
- `OMX_Sts_BadArgErr` – Bad arguments. Returned for any of the following conditions:
  - a pointer was NULL

#### Reference

[ITUCCITT81], section C.2 and figures C-1 through C-3.

### 5.1.3.5.3 DecodeHuffman8x8\_Direct\_S16\_C1

#### Prototype

```
OMXResult omxICJP_DecodeHuffman8x8_Direct_S16_C1 (const OMX_U8 *pSrc,
      OMX_INT *pSrcDstBitsLen, OMX_S16 *pDst, OMX_S16 *pDCPred, OMX_INT
      *pMarker, OMX_U32 *pPrefetchedBits, OMX_INT *pNumValidPrefetchedBits,
      const OMXICJPHuffmanDecodeSpec *pDCHuffTable, const
      OMXICJPHuffmanDecodeSpec *pACHuffTable);
```

#### Description

Implements the JPEG baseline Huffman decoder. Decodes an 8x8 block of quantized DCT coefficients using the tables referenced by the parameters `pDCHuffTable` and `pACHuffTable` in accordance with the Huffman decoding procedure defined in [ISO10918-1], Annex F.2.2, *Baseline Huffman Decoding Procedures*. If a JPEG marker is detected during decoding, the function stops decoding and writes the marker to the location indicated by `pMarker`.

The decoded data is inverse zigzag scanned to produce the raster scanned output buffer (8x8).

The DC coefficient prediction parameter `pDCPred` should be set to 0 during initialization and after every

restart interval. The parameter `pMarker` should be set to 0 during initialization or after the found marker has been processed. The parameter `pNumValidPrefetchedBits` should be set to 0 in the following cases: 1) during function initialization, 2) after each restart interval, and 3) after each found marker has been processed. The parameter `pPrefetchedBits` should be set to 0 during function initialization.

## Input Arguments

- `pSrc` – pointer to the first byte of the input JPEG bitstream buffer both upon function entry and upon function return, i.e., the function does not modify the value of the pointer. The location of the first available bit in the buffer is indexed by the parameter `pSrcDstBitsLen`. For a buffer of non-zero length, the value of the first bit accessed during the Huffman block decode operation is given by  $(pSrc[currentByte] \gg currentBit) \& 0x1$ , where  $currentByte = (pSrcDstBitsLen - 1) \gg 3$ , and  $currentBit = 7 - ((pSrcDstBitsLen - 1) \& 0x7)$ . Within each byte, bits are consumed from most significant to least significant. The buffer contents should be formatted in accordance with CCITT T.81, and the pointer `pSrc` must be aligned on a 4-byte boundary.
- `pDCHuffTable` – pointer to the `OMXICJPHuffmanDecodeSpec` structure containing the DC Huffman decoding table; must be aligned on a 4-byte boundary.
- `pACHuffTable` – pointer to the `OMXICJPHuffmanDecodeSpec` structure containing the AC Huffman decoding table; must be aligned on a 4-byte aligned.
- `pSrcDstBitsLen` – pointer to the current bit position indicator for the input buffer (`pSrc`). This parameter informs the Huffman decoder of where to start reading input bits for the current block since the start of the current block may not necessarily be positioned at the start of the input buffer. The parameter `pSrcDstBitsLen` indicates the offset in terms of bits of the current bit relative to `pSrc`. Updated upon return as described below under “Output Arguments”. There is no restriction on buffer length. It is the responsibility of the caller to maintain the Huffman buffer and limit the buffer length as appropriate for the target application or environment. The parameter `pSrcDstBitsLen` must be aligned on a 4-byte boundary.
- `pDCPred` – pointer to the DC prediction coefficient. Upon input contains the quantized DC coefficient decoded from the most recent block. Should be set to 0 upon function initialization and after each restart interval. Updated upon return as described below under “Output Arguments.”
- `pMarker` – pointer to the most recently encountered marker. The caller should set this parameter to 0 during function initialization and after a found marker has been processed. Updated upon return as described below under “Output Arguments.”
- `pPrefetchedBits` – implementation-specific pre-fetch parameter; should be set to 0 during function initialization. This parameter shall not affect the value of the parameter `pSrcDstBitsLen`, i.e., the location of the next bit in the stream shall be fully determined by combining the parameters `pSrc` and `pSrcDstBitsLen` as described above under the description for the parameter `pSrc`.
- `pNumValidPrefetchedBits` – implementation-specific pre-fetch parameter that points to the number of valid bits in the pre-fetch buffer; should be set to 0 upon input under the following conditions: 1) function initialization, 2) after each restart interval, 3) after each found marker has been processed. This parameter shall not affect the value of the parameter `pSrcDstBitsLen`, i.e., the location of the next bit in the stream shall be fully determined by combining the parameters `pSrc` and `pSrcDstBitsLen` as described above under the description for the parameter `pSrc`.

## Output Arguments

- `pDst` – pointer to the output buffer; must be aligned on a 32-byte boundary.

- `pSrcDstBitsLen` – pointer to the updated value of the bit index for the input buffer (`pSrc`); informs the caller of where the Huffman decoder stopped reading bits for the current block. The value `*pSrcDstBitsLen` is modified by the Huffman decoder such that it indicates upon return the offset in terms of bits of the current bit relative to `pSrc` after block decoding has been completed. Usage guidelines apply as described above under “Input Arguments.”
- `pDCPred` – pointer to the DC prediction coefficient. Returns the quantized value of the DC coefficient from the current block.
- `pMarker` – pointer to the most recently encountered marker. If a marker is detected during decoding, the function stops decoding and returns the encountered marker using this parameter; returned value should be preserved between calls to the decoder or reset prior to input as described above under “Input Arguments.”
- `pPrefetchedBits` – implementation-specific pre-fetch parameter; returned value should be preserved between calls to the decoder or reset prior to input as described above under “Input Arguments.”
- `pNumValidPrefetchedBits` – pointer to the number of valid bits in the pre-fetch buffer; returned value should be preserved between calls to the decoder or reset prior to input as described above under “Input Arguments.”

## Returns

- `OMX_Sts_NoErr` – no error.
- `OMX_Sts_Err` – error, illegal Huffman code encountered in the input bitstream.
- `OMX_StsICJP_JPEGMarkerErr` – JPEG marker encountered within an entropy-coded block; Huffman decoding terminated early. Marker value returned by the parameter `*pMarker`.
- `OMX_StsICJP_JPEGMarker` – JPEG marker encountered before any Huffman symbols; Huffman decoding terminated early. Marker value returned by the parameter `*pMarker`.
- `OMX_Sts_BadArgErr` – bad arguments; returned under any of the following conditions:
  - a pointer was NULL
  - `*pSrcBitsLen` was less than 0.
  - `*pNumValidPrefetchedBits` was less than 0.
  - the start address of `pDst` was not 32-byte aligned.

## Reference

[ITUCCITT81], Annex D-2.

# 6.0 Video Coding

## 6

This section defines the functions and data types that comprise the OpenMAX DL video coding domain (omxVC), including functions that can be used to construct the MPEG-4 simple profile encoder and decoder (omxVCM4P2), as well as functions that can be used to construct the H.264 baseline encoder and decoder (omxVCM4P10). A sub-domain containing a set of functions common to MPEG-4 and H.264 sub-domains is also defined (omxVCCOMM).

## 6.1 Common Sub-Domain (omxVCCOMM)

The omxVCCOMM sub-domain defines data structures and functions that could be used in conjunction with data structures and functions from other omxVC sub-domains including omxVCM4P2 and omxVCM4P10 for implementation of simple profile MPEG-4 as well as baseline profile H.264 encoders or decoders.

### 6.1.1 Data Structures and Enumerators

The omxVCCOMM sub-domain defines data structures and bitstream buffer conventions that are common across all omxVC sub-domains.

#### 6.1.1.1 Motion Vectors

In omxVC, motion vectors are represented as follows:

```
typedef struct {
    OMX_S16 dx;
    OMX_S16 dy;
} OMXVCMotionVector;
```

Unless otherwise specified, texture motion vectors are represented using Q1.

### 6.1.2 Buffer Conventions

#### 6.1.2.1 Bitstream Buffers

In omxVC, bitstreams are represented using two parameters, namely, a double pointer to the stream buffer, `**ppBitStream`, and a pointer to the next available bit in the stream, `*pBitOffset`. Unless otherwise specified in the description for a particular function, the standard conventions that are observed for stream buffers and buffer pointer maintenance are as follows:

- The parameter `**ppBitStream` points to the current byte in the stream upon function entry, and is updated by the function such that it references the current byte in the stream upon function exit.
- The parameter `*pBitOffset` points to the next available bit in the stream upon function entry, and is updated by the function such that it points to the next available bit in the stream upon function exit. `*pBitOffset` is valid in the range 0 to 7. The value 0 corresponds to the most significant bit cell, and the value 7 corresponds to the least significant bit cell, i.e.,
 

| Bit Position in one byte: | Most |   |   |   |   |   | Least |   |
|---------------------------|------|---|---|---|---|---|-------|---|
| <code>*pBitOffset</code>  | 0    | 1 | 2 | 3 | 4 | 5 | 6     | 7 |
- Stream buffer space is allocated outside of the function and is maintained by the DL user, client, or application.
- It is recommended in all cases that eight additional padding bytes beyond the minimum required buffer size be allocated to a stream buffer in order to protect against data aborts under exception conditions.
- If an error occurs during bitstream processing, the values referenced by the parameters `**ppBitStream` and `*pBitOffset` shall be undefined upon return. The calling application may maintain a local copy of these parameters for the purposes of error exception handling, but it is not required to do so.

These standard bitstream conventions apply to a particular set of functions from the omxVCM4P2 and omxVCM4P10 sub-domains, including:

```

omxVCM4P2_EncodeVLCZigzag_IntraDCVLC
omxVCM4P2_EncodeVLCZigzag_IntraACVLC
omxVCM4P2_EncodeVLCZigzag_Inter
omxVCM4P2_DecompileVLCZigzag_IntraDCVLC
omxVCM4P2_DecompileVLCZigzag_IntraACVLC
omxVCM4P2_EncodeMV
omxVCM4P2_DecompilePadMV_PVOP
omxVCM4P2_DecompileVLCZigzag_Inter
omxVCM4P2_DecompileBlockCoef_Intra
omxVCM4P2_DecompileBlockCoef_Inter
omxVCM4P10_DecompileChromaDcCoeffsToPairCAVLC
omxVCM4P10_DecompileCoeffsToPairCAVLC

```

## 6.1.3 Encoder/Decoder Functions

### 6.1.3.1 Interpolation

#### 6.1.3.1.1 Average\_8x

##### Prototype

```

OMXResult omxVCCOMM_Average_8x (const OMX_U8 *pPred0, const OMX_U8 *pPred1,
    OMX_U32 iPredStep0, OMX_U32 iPredStep1, OMX_U8 *pDstPred, OMX_U32
    iDstStep, OMX_U32 iHeight);

```

##### Description

This function calculates the average of two 8x4, 8x8, or 8x16 blocks. The result is rounded according to

$(a+b+1)/2$ . The block average function can be used in conjunction with half-pixel interpolation to obtain quarter pixel motion estimates, as described in [ISO14496-10], subclause 8.4.2.2.1.

### Input Arguments

- `pPred0` - Pointer to the top-left corner of reference block 0
- `pPred1` - Pointer to the top-left corner of reference block 1
- `iPredStep0` - Step of reference block 0
- `iPredStep1` - Step of reference block 1
- `iDstStep` - Step of the destination buffer.
- `iHeight` - Height of the blocks

### Output Parameters

- `pDstPred` - Pointer to the destination buffer. 8-byte aligned.

### Returns

- `OMX_Sts_NoErr` - no error
- `OMX_Sts_BadArgErr` - bad arguments; returned under any of the following conditions:
  - one or more of the following pointers is NULL: `pPred0`, `pPred1`, or `pDstPred`.
  - `pDstPred` is not aligned on an 8-byte boundary.
  - `iPredStep0 <= 0` or `iPredStep0` is not a multiple of 8.
  - `iPredStep1 <= 0` or `iPredStep1` is not a multiple of 8.
  - `iDstStep <= 0` or `iDstStep` is not a multiple of 8.
  - `iHeight` is not 4, 8, or 16.

### Reference

[ISO14496-10], subclause 8.4.2.2.1, Eq. 8.194 – 8.205.

## 6.1.3.1.2 Average\_16x

### Prototype

```
OMXResult omxVCCOMM_Average_16x (const OMX_U8 *pPred0, const OMX_U8 *pPred1,  
    OMX_U32 iPredStep0, OMX_U32 iPredStep1, OMX_U8 *pDstPred, OMX_U32  
    iDstStep, OMX_U32 iHeight);
```

### Description

This function calculates the average of two 16x16 or 16x8 blocks. The result is rounded according to  $(a+b+1)/2$ . The block average function can be used in conjunction with half-pixel interpolation to obtain quarter pixel motion estimates, as described in [ISO14496-10], subclause 8.4.2.2.1.

### Input Arguments

- `pPred0` - Pointer to the top-left corner of reference block 0
- `pPred1` - Pointer to the top-left corner of reference block 1
- `iPredStep0` - Step of reference block 0

- `iPredStep1` - Step of reference block 1
- `iDstStep` - Step of the destination buffer
- `iHeight` - Height of the blocks

### Output Parameters

- `pDstPred` - Pointer to the destination buffer. 16-byte aligned.

### Returns

- `OMX_Sts_NoErr` – no error
- `OMX_Sts_BadArgErr` – bad arguments; returned under any of the following conditions:
  - one or more of the following pointers is NULL: `pPred0`, `pPred1`, or `pDstPred`.
  - `pDstPred` is not aligned on a 16-byte boundary.
  - `iPredStep0`  $\leq 0$  or `iPredStep0` is not a multiple of 16.
  - `iPredStep1`  $\leq 0$  or `iPredStep1` is not a multiple of 16.
  - `iDstStep`  $\leq 0$  or `iDstStep` is not a multiple of 16.
  - `iHeight` is not 8 or 16.

### Reference

[ISO14496-10], subclause 8.4.2.2.1, Eq. 8.194 – 8.205.

## 6.1.3.2 Frame Expansion

### 6.1.3.2.1 ExpandFrame\_I

#### Prototype

```
OMXResult omxVCCOMM_ExpandFrame_I(OMX_U8 *pSrcDstPlane, OMX_U32 iFrameWidth,
    OMX_U32 iFrameHeight, OMX_U32 iExpandPels, OMX_U32 iPlaneStep);
```

#### Description

This function expands a reconstructed frame in-place. The unexpanded source frame should be stored in a plane buffer with sufficient space pre-allocated for edge expansion, and the input frame should be located in the plane buffer center. This function executes the pixel expansion by replicating source frame edge pixel intensities in the empty pixel locations (expansion region) between the source frame edge and the plane buffer edge. The width/height of the expansion regions on the horizontal/vertical edges is controlled by the parameter `iExpandPels`.

#### Input Arguments

- `pSrcDstPlane` - pointer to the top-left corner of the frame to be expanded; must be aligned on an 8-byte boundary.
- `iFrameWidth` - frame width; must be a multiple of 8.
- `iFrameHeight` - frame height; must be a multiple of 8.
- `iExpandPels` - number of pixels to be expanded in the horizontal and vertical directions; must be a multiple of 8.

- `iPlaneStep` – distance, in bytes, between the start of consecutive lines in the plane buffer; must be larger than or equal to  $(iFrameWidth + 2 * iExpandPels)$ .

### Output Parameters

- `pSrcDstPlane` – Pointer to the top-left corner of the frame (NOT the top-left corner of the plane); must be aligned on an 8-byte boundary.

### Returns

- `OMX_Sts_NoErr` – no error
- `OMX_Sts_BadArgErr` – bad arguments; returned under any of the following conditions:
  - `pSrcDstPlane` is NULL.
  - `pSrcDstPlane` is not aligned on an 8-byte boundary.
  - one of the following parameters is either equal to zero or is a non-multiple of 8: `iFrameHeight`, `iFrameWidth`, `iPlaneStep`, or `iExpandPels`.
  - $iPlaneStep < (iFrameWidth + 2 * iExpandPels)$ .

## 6.1.3.3 Block Copy

### 6.1.3.3.1 Copy8x8

#### Prototype

```
OMXResult omxVCCOMM_Copy8x8 (const OMX_U8 *pSrc, OMX_U8 *pDst, OMX_INT
    step);
```

#### Description

Copies the reference 8x8 block to the current block.

#### Input Arguments

- `pSrc` – pointer to the reference block in the source frame; must be aligned on an 8-byte boundary.
- `step` – distance between the starts of consecutive lines in the reference frame, in bytes; must be a multiple of 8 and must be larger than or equal to 8.

#### Output Arguments

- `pDst` – pointer to the destination block; must be aligned on an 8-byte boundary.

#### Returns

- `OMX_Sts_NoErr` – no error
- `OMX_Sts_BadArgErr` – bad arguments; returned under any of the following conditions:
  - one or more of the following pointers is NULL: `pSrc`, `pDst`
  - one or more of the following pointers is not aligned on an 8-byte boundary: `pSrc`, `pDst`
  - $step < 8$  or `step` is not a multiple of 8.



### 6.1.3.3.2 Copy16x16

#### Prototype

```
OMXResult omxVCCOMM_Copy16x16 (const OMX_U8 *pSrc, OMX_U8 *pDst, OMX_INT  
    step);
```

#### Description

Copies the reference 16x16 macroblock to the current macroblock.

#### Input Arguments

- `pSrc` – pointer to the reference macroblock in the source frame; must be aligned on a 16-byte boundary.
- `step` – distance between the starts of consecutive lines in the reference frame, in bytes; must be a multiple of 16 and must be larger than or equal to 16.

#### Output Arguments

- `pDst` – pointer to the destination macroblock; must be aligned on a 16-byte boundary.

#### Returns

- `OMX_Sts_NoErr` – no error
- `OMX_Sts_BadArgErr` – bad arguments; returned under any of the following conditions:
  - one or more of the following pointers is NULL: `pSrc`, `pDst`
  - one or more of the following pointers is not aligned on a 16-byte boundary: `pSrc`, `pDst`
  - `step < 16` or `step` is not a multiple of 16.

## 6.1.4 Encoder Functions

### 6.1.4.1 Motion Estimation

#### 6.1.4.1.1 ComputeTextureErrorBlock\_SAD

#### Prototype

```
OMXResult omxVCCOMM_ComputeTextureErrorBlock_SAD(const OMX_U8 *pSrc, OMX_INT  
    srcStep, const OMX_U8 *pSrcRef, OMX_S16 *pDst, OMX_INT *pDstSAD);
```

#### Description

Computes texture error of the block; also returns SAD.

#### Input Arguments

- `pSrc` – pointer to the source plane; must be aligned on an 8-byte boundary.
- `srcStep` – step of the source plane
- `pSrcRef` – pointer to the reference buffer, an 8x8 block; must be aligned on an 8-byte boundary.

## Output Arguments

- `pDst` – pointer to the destination buffer, an 8x8 block; must be aligned on an 8-byte boundary.
- `pDstSAD` – pointer to the Sum of Absolute Differences (SAD) value

## Returns

- `OMX_Sts_NoErr` – no error
- `OMX_Sts_BadArgErr` – bad arguments
  - At least one of the following pointers is NULL: `pSrc`, `pSrcRef`, `pDst` and `pDstSAD`.
  - `pSrc` is not 8-byte aligned.
  - `srcStep <= 0` or `srcStep` is not a multiple of 8.
  - `pSrcRef` is not 8-byte aligned.
  - `pDst` is not 8-byte aligned.

### 6.1.4.1.2 ComputeTextureErrorBlock

#### Prototype

```
OMXResult omxVCCOMM_ComputeTextureErrorBlock(const OMX_U8 *pSrc, OMX_INT  
    srcStep, const OMX_U8 *pSrcRef, OMX_S16 *pDst);
```

#### Description

Computes the texture error of the block.

#### Input Arguments

- `pSrc` – pointer to the source plane. This should be aligned on an 8-byte boundary.
- `srcStep` – step of the source plane
- `pSrcRef` – pointer to the reference buffer, an 8x8 block. This should be aligned on an 8-byte boundary.

#### Output Arguments

- `pDst` – pointer to the destination buffer, an 8x8 block. This should be aligned on an 8-byte boundary.

#### Returns

- `OMX_Sts_NoErr` – no error
- `OMX_Sts_BadArgErr` – bad arguments
  - At least one of the following pointers is NULL: `pSrc`, `pSrcRef`, `pDst`.
  - `pSrc` is not 8-byte aligned.
  - `srcStep <= 0` or `srcStep` is not a multiple of 8.
  - `pSrcRef` is not 8-byte aligned.
  - `pDst` is not 8-byte aligned

### 6.1.4.1.3 LimitMVToRect

#### Prototype

```
OMXResult omxVCCOMM_LimitMVToRect(const OMXVMotionVector *pSrcMV,  
    OMXVMotionVector *pDstMV, const OMXRect *pRectVOPRef, OMX_INT Xcoord,  
    OMX_INT Ycoord, OMX_INT size);
```

#### Description

Limits the motion vector associated with the current block/macroblock to prevent the motion compensated block/macroblock from moving outside a bounding rectangle as shown in Figure 6-1.

#### Input Arguments

- `pSrcMV` – pointer to the motion vector associated with the current block or macroblock
- `pRectVOPRef` – pointer to the bounding rectangle
- `Xcoord`, `Ycoord` – coordinates of the current block or macroblock
- `size` – size of the current block or macroblock; must be equal to 8 or 16.

#### Output Arguments

- `pDstMV` – pointer to the limited motion vector

#### Returns

- `OMX_Sts_NoErr` – no error
- `OMX_Sts_BadArgErr` – bad arguments. Returned if one or more of the following conditions is true:
  - at least one of the following pointers is NULL: `pSrcMV`, `pDstMV`, or `pRectVOPRef`.
  - `size` is not equal to either 8 or 16.
  - the width or height of the bounding rectangle is less than twice the block size.

**Figure 6-1: Motion Vector Limiting**

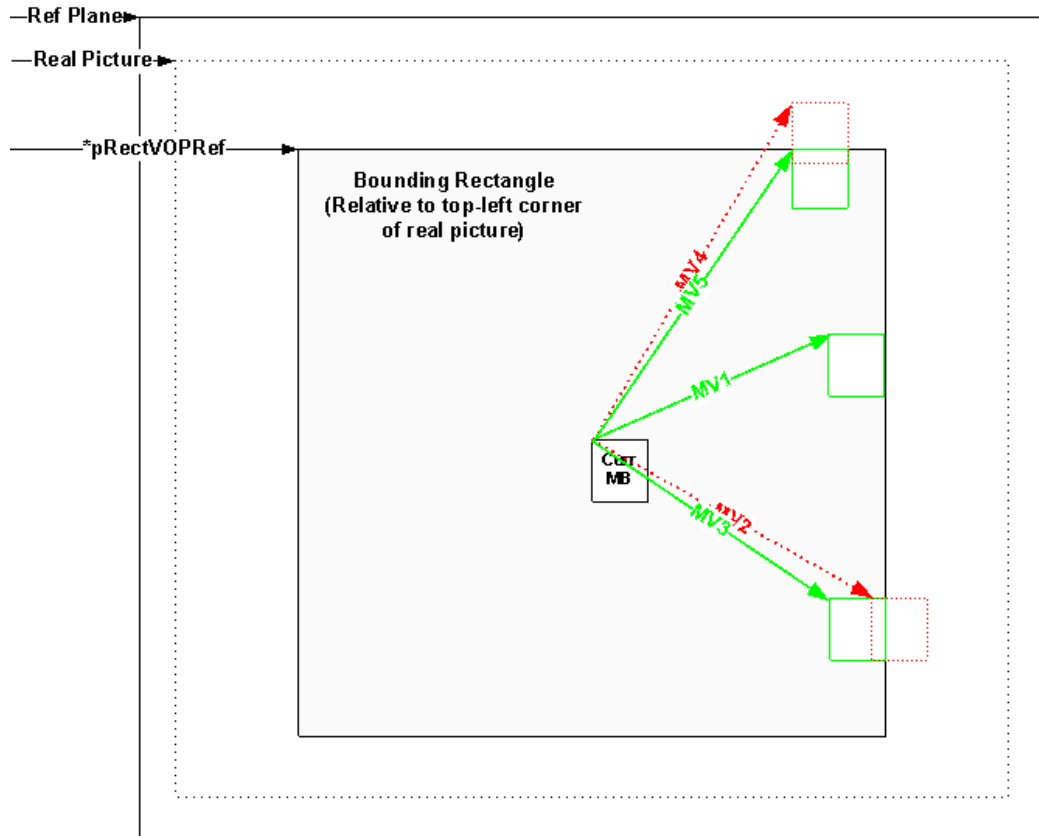

Figure 6-1 illustrates `LimitMVTToRect` behavior for the macroblock (“Curr MB”) shown near the center of the shaded bounding rectangle: Case i) no limiting – given `*pSrcMV=MV1`, `LimitMVTToRect` returns `*pDstMV=MV1` because the motion compensated result produced by MV1 lies within the bounding rectangle. Case ii) horizontal limiting – given `*pSrcMV=MV2` (red), `LimitMVTToRect` reduces the horizontal motion component to prevent the motion compensated result from crossing the vertical edge of the bounding rectangle and returns `*pDstMV=MV3` (green). Case iii) vertical limiting – given `*pSrcMV=MV4` (red), `LimitMVTToRect` reduces the vertical component to prevent the motion compensated result from crossing the horizontal edge of the bounding rectangle and returns `*pDstMV=MV5` (green). Combined vertical+horizontal limiting may also be applied if necessary.

#### 6.1.4.1.4 SAD\_16x

##### Prototype

```
OMXResult omxVCCOMM_SAD_16x (const OMX_U8 *pSrcOrg, OMX_U32 iStepOrg, const
    OMX_U8 *pSrcRef, OMX_U32 iStepRef, OMX_S32 *pDstSAD, OMX_U32 iHeight);
```

##### Description

This function calculates the SAD for 16x16 and 16x8 blocks.

### Input Arguments

- pSrcOrg - Pointer to the original block; must be aligned on a 16-byte boundary.
- iStepOrg - Step of the original block buffer
- pSrcRef - Pointer to the reference block
- iStepRef - Step of the reference block buffer
- iHeight - Height of the block

### Output Parameters

- pDstSAD - Pointer of result SAD

### Returns

- OMX\_Sts\_NoErr - no error
- OMX\_Sts\_BadArgErr - bad arguments. Returned if one or more of the following conditions is true:
  - at least one of the following pointers is NULL: pSrcOrg, pDstSAD, or pSrcRef
  - pSrcOrg is not 16-byte aligned.
  - iStepOrg <= 0 or iStepOrg is not a multiple of 16
  - iStepRef <= 0 or iStepRef is not a multiple of 16
  - iHeight is not 8 or 16

## 6.1.4.1.5 SAD\_8x

### Prototype

```
OMXResult omxVCCOMM_SAD_8x(const OMX_U8 *pSrcOrg, OMX_U32 iStepOrg, const
    OMX_U8 *pSrcRef, OMX_U32 iStepRef, OMX_S32*pDstSAD, OMX_U32 iHeight)
```

### Description

This function calculates the SAD for 8x16, 8x8, 8x4 blocks.

### Input Arguments

- pSrcOrg - Pointer to the original block; must be aligned on a 8-byte boundary.
- iStepOrg - Step of the original block buffer
- pSrcRef - Pointer to the reference block
- iStepRef - Step of the reference block buffer
- iHeight - Height of the block

### Output Parameters

- pDstSAD - Pointer of result SAD

### Returns

- OMX\_Sts\_NoErr - no error
- OMX\_Sts\_BadArgErr - bad arguments. Returned if one or more of the following conditions is true:
  - at least one of the following pointers is NULL: pSrcOrg, pDstSAD, or pSrcRef
  - pSrcOrg is not 8-byte aligned.

- `iStepOrg`  $\leq 0$  or `iStepOrg` is not a multiple of 8
- `iStepRef`  $\leq 0$  or `iStepRef` is not a multiple of 8
- `iHeight` is not 4, 8 or 16

## 6.2 MPEG-4 Simple Profile Sub-Domain (omxVCM4P2)

This section defines the omxVCM4P2 sub-domain, which includes data structures and functions that could be used to construct an MPEG-4 simple profile encoder or decoder.

### 6.2.1 Data Structures and Enumerators

#### 6.2.1.1 Direction

The direction enumerator is used with functions that perform AC/DC prediction and zig-zag scan.

```
enum {
    OMX_VC_NONE= 0,
    OMX_VC_HORIZONTAL= 1,
    OMX_VC_VERTICAL= 2
};
```

#### 6.2.1.2 Bilinear Interpolation

The bilinear interpolation enumerator is used with motion estimation, motion compensation, and reconstruction functions.

```
enum {
    OMX_VC_INTEGER_PIXEL= 0,      /* case a */
    OMX_VC_HALF_PIXEL_X= 1,      /* case b */
    OMX_VC_HALF_PIXEL_Y= 2,      /* case c */
    OMX_VC_HALF_PIXEL_XY= 3      /* case d */
};
```

#### 6.2.1.3 Neighboring Macroblock Availability

Neighboring macroblock availability is indicated using the following flags:

```
enum {
    OMX_VC_UPPER    = 1,          /** above macroblock is available */
    OMX_VC_LEFT     = 2,          /** left macroblock is available */
    OMX_VC_CENTER   = 4,
    OMX_VC_RIGHT    = 8,
    OMX_VC_LOWER    = 16,
    OMX_VC_UPPER_LEFT = 32,      /** above-left macroblock is available */
    OMX_VC_UPPER_RIGHT = 64,     /** above-right macroblock is available */
    OMX_VC_LOWER_LEFT  = 128,
    OMX_VC_LOWER_RIGHT = 256
};
```

```
};
```

### 6.2.1.4 Video Components

A data type that enumerates video components is defined as follows:

```
typedef enum {
    OMX_VC_LUMINANCE,      /** Luminance component */
    OMX_VC_CHROMINANCE    /** chrominance component */
} OMXVCM4P2VideoComponent;
```

### 6.2.1.5 MacroblockTypes

A data type that enumerates macroblock types is defined as follows:

```
typedef enum {
    OMX_VC_INTER          = 0,  /** P picture or P-VOP */
    OMX_VC_INTER_Q= 1,      /** P picture or P-VOP */
    OMX_VC_INTER4V= 2,     /** P picture or P-VOP */
    OMX_VC_INTRA          = 3,  /** I and P picture, I- and P-VOP */
    OMX_VC_INTRA_Q= 4,     /** I and P picture, I- and P-VOP */
    OMX_VC_INTER4V_Q= 5,   /** P picture or P-VOP (H.263)*/
} OMXVCM4P2MacroblockType;
```

### 6.2.1.6 Coordinates

Coordinates are represented as follows:

```
typedef struct {
    OMX_INT x;
    OMX_INT y;
} OMXVCM4P2Coordinate;
```

### 6.2.1.7 Motion Estimation Algorithms

A data type that enumerates motion estimation search methods is defined as follows:

```
typedef enum
{
    OMX_VC_M4P2_FAST_SEARCH = 0,  /** Fast motion search */
    OMX_VC_M4P2_FULLL_SEARCH = 1  /** Full motion search */
} OMXVCM4P2MEMode;
```

### 6.2.1.8 Motion Estimation Parameters

A data structure containing control parameters for motion estimation functions is defined as follows:



```

typedef struct
{
    OMX_INT searchEnable8x8;          /** enables 8x8 search */
    OMX_INT halfPelSearchEnable;     /** enables half-pel resolution */
    OMX_INT searchRange;             /** search range */
    OMX_INT rndVal;                   /** rounding control; 0-disabled, 1-enabled*/
} OMXVCM4P2MEParams;

```

### 6.2.1.9 Macroblock Information

A data structure containing macroblock parameters for motion estimation functions is defined as follows:

```

typedef struct {
    OMX_S32 sliceId;                  /* slice number */
    OMXVCM4P2MacroblockType mbType;  /* MB type: OMX_VC_INTRA,
                                       OMX_VC_INTER, or
                                       OMX_VC_INTER4 */
    OMX_S32 qp;                       /* quantization parameter*/
    OMX_U32 cbpy;                     /* CBP Luma */
    OMX_U32 cbpc;                     /* CBP Chroma */
    OMXVCMotionVector pMV0[2][2];     /* motion vector, represented
                                       using 1/2-pel units,
                                       pMV0[blocky][blockx]
                                       (blocky = 0~1, blockx = 0~1) */
    OMXVCMotionVector pMVPred[2][2]; /* motion vector prediction,
                                       represented using 1/2-pel
                                       units, pMVPred[blocky][blockx]
                                       (blocky = 0~1, blockx = 0~1) */
    OMX_U8 pPredDir[2][2];           /* AC prediction direction:
                                       OMX_VC_NONE, OMX_VC_VERTICAL,
                                       OMX_VC_HORIZONTAL */
} OMXVCM4P2MBInfo, *OMXVCM4P2MBInfoPtr;

```

## 6.2.2 Buffer Conventions

### 6.2.2.1 Pixel Planes

The encoder's input and output is stored in pixel planes denoted by Y plane (luminance component), Cb plane and Cr plane (chrominance components).

The size of Y plane relates to, but is not equal to, that defined in the VOL as a result of the VOP expansion. Since luminance VOP is expanded (and padded) with 16 pixels to each of the four directions, the width and height of the Y plane are 32 pixels larger than those defined in the VOL respectively.

The size (W, H) of Cb or Cr plane is half the size of Y plane, because chrominance VOPs are expanded with eight pixels in each direction.

Figure 6-2 shows the relationship among the pixel planes VOL and VOP.

Allocate three sets of four-byte-aligned pixel planes, each consisting of a Y plane, a Cb plane and a Cr plane.

**Figure 6-2: Pixel Plane, VOL, and VOP**

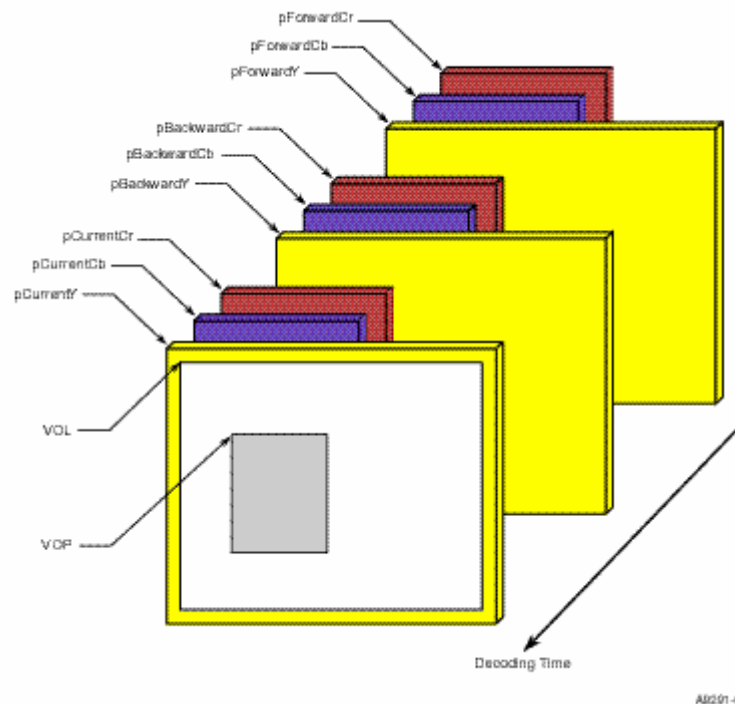

### 6.2.2.2 Texture Motion Vectors (in Q1 format)

Zero to four valid motion vector(s) are associated with each MB, depending on MB type. A motion vector (MV) buffer contains four block-based elements stored contiguously. One MV buffer per MB for shall be allocated for a P-VOP. The following conventions are adopted:

- Two buffers per MB in P-VOP are contained in `pMVForward[4]`
- Elements are block-based and stored contiguously
- If the MB type is “OMX\_VC\_INTER“ or “OMX\_VC\_INTER\_Q“, `pMVForward[0]-[3]` must be filled with the same decoded MV.
- If MB is INTRA coded or skipped, `pMVForward[0]-[3]` must be padded with zero MVs.

Coordinates are related to the absolute coordinate system shown in [ISO14496-2], Figure 7-19.

### 6.2.2.3 Quantization Parameter

Quantization parameters of intra-coded macroblocks must be stored to perform DC and AC prediction for the intra-coded macroblocks spatially to the right and/or below, if they exist.

- One row buffer for the current VOP is used for coefficient prediction
- Before decoding an `intra` or `intra+q` MB, the buffer saves the QPs of the upper MB and left MB if they exist.
- After an `intra` or `intra+q` MB is decoded, the corresponding QP buffer, which stored the MB spatially above before must be updated by the current QP.
- Each element is one byte (`OMX_U8`) for one MB.

### 6.2.2.4 Coefficient buffers

Two coefficient buffers should be allocated for Intra DC/AC prediction – a row buffer that contains  $((\text{mb\_num\_per\_row} * 2 + 1) * 8)$  elements of `OMX_S16`, and a column buffer that contains 16 elements of `OMX_S16`, where the number of macroblocks per row is denoted by the parameter `mb_num_per_row`.

Every eight elements of both row and column buffers, plus one element eight units ahead in row buffer, are used to perform DC/AC prediction for an INTRA coded block in a MB. Each group stores the coefficient predictors of the neighbor block spatially above or to the left of the block currently to be decoded. Within every group of eight elements, the first element stores the DC coefficient and the others store quantized AC coefficients. A negative-valued DC coefficient signals that this neighbor block is not INTRA coded, and therefore neither the DC nor the AC coefficients are valid.

All DC elements in the row buffer must be initialized to -1 prior to decoding each VOP. In addition, the two DC elements in column buffer should also be initialized to -1 prior decoding each MB row.

If the current `MB_Type` is either `OMX_VC_INTER`/`OMX_VC_INTER_Q`/`OMX_VC_INTER_4V`, then the corresponding DC elements in the row buffer and column buffer must also be initialized to -1 to indicate that no predictor for later AC/DC prediction.

The detailed coefficient buffer layout is illustrated in Figure 6-3.

#### 6.2.2.4.1 Internal Prediction Coefficient Buffer Update Procedures

The following prediction coefficient update procedures are followed inside of the `omxM4P2` functions that use row and column prediction coefficient buffers:

##### 1. INTRA Frame AC Coefficient Buffer Update

After encoding each 8x8 block, the AC coefficients from the first row and column are copied, respectively, to the row and column coefficient prediction buffers (Fig. 6-2).

##### 2. INTRA Frame DC Coefficient Buffer Update

A special DC coefficient update procedure is followed inside of the function to avoid overwriting the top-left DC prediction component for the right-hand block. The DC coefficient buffers are updated as follows:

```
(pPredBufRow - 8) = pPredBufCol; /* Fig. 6-2, Step 1 */
```

```
*pPredBufCol = *pDCTcoef; /* Fig. 6-2, Step 2 */
```

**Figure 6-3: Row/Column Coefficient Buffer Updates for A Single Block**

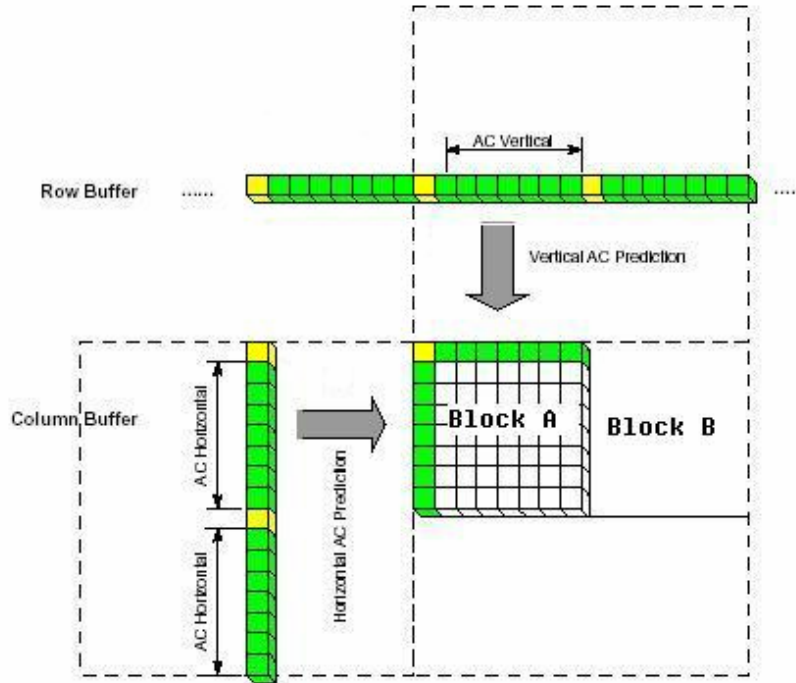

Figure 6-4 illustrates the DC coefficient update process during encoding of a complete macroblock. As shown in the figure, after block A is encoded, the DC value will first be copied to the column buffer. Then, after block B is encoded, this same DC coefficient will be moved to the row buffer from the column buffer. The dotted lines illustrate how the DC coefficients are updated after encoding the 8x8 block. For blocks BA, BB, and BC, the top DC component will be stored in location pPredBufRow[0]. For block BD, the top DC coefficient will be stored in location pPredBufCol[0], i.e.,

```

if( 3 == blockIndex ) {
tempPred = *(pPredBufCol-8);
} else {
tempPred = * pPredBufRow;
}

```

**Figure 6-4: Row/Column Coefficient Buffer Updates for A Complete Macroblock**

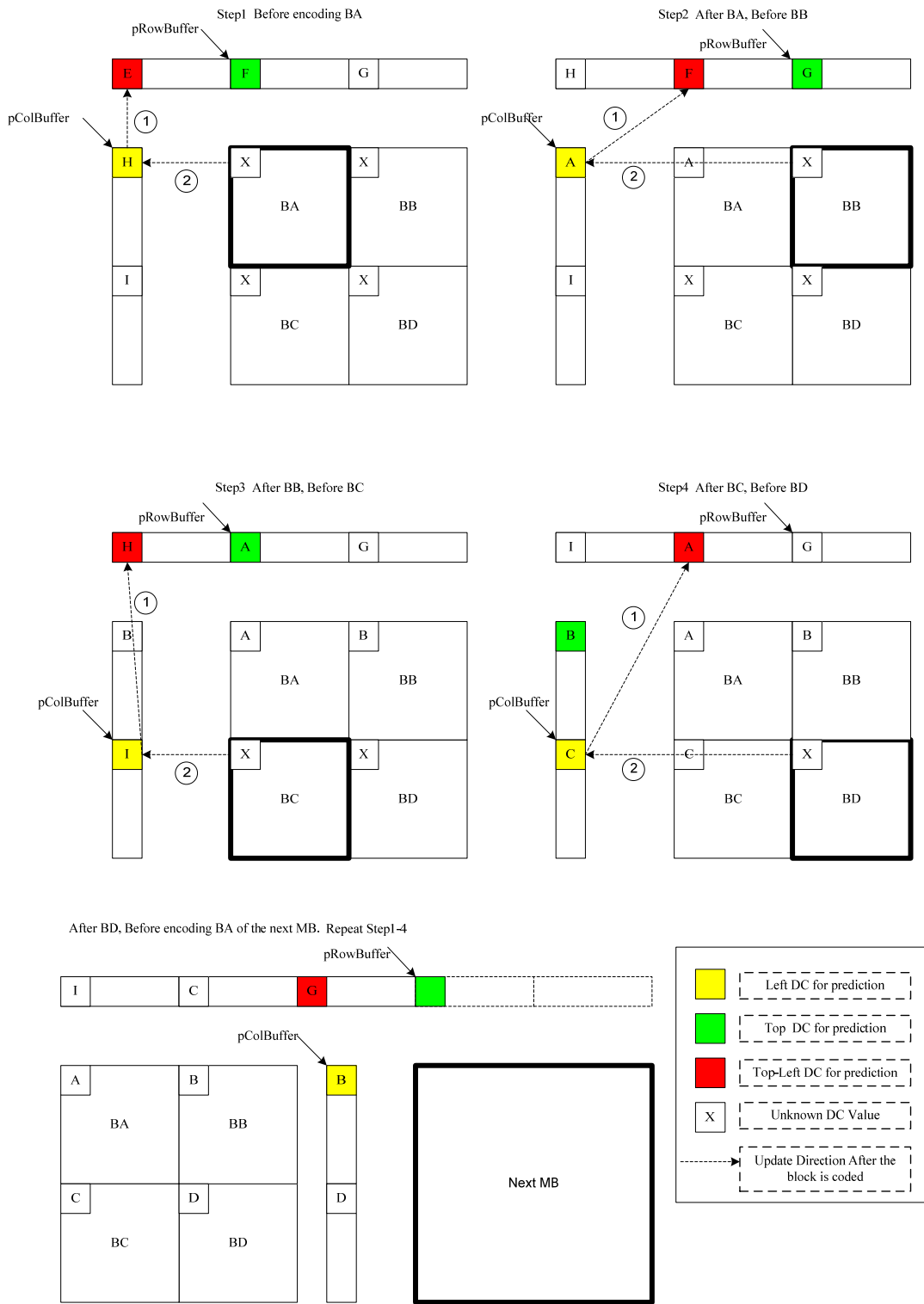

#### 6.2.2.4.2 External Prediction Coefficient Buffer Update Procedures

The following prediction coefficient update procedures should be implemented outside of the omxM4P2 functions that use row and column prediction coefficient buffers:

##### 1. INTRA Frame DC Coefficient Buffer Update

I (the DC coefficient of block BD in the previous MB) is updated to the location of H after encoding BC of the current MB. Similarly, D (the DC coefficient of block BD in the current MB) coefficient will be copied to the location of G after encoding BC of the next macroblock. This procedure works except the last MB in a row because the DC coefficient of block BD in the last MB of a row will not be updated into the row buffer. For an INTRA MB, the row coefficient prediction buffer must be updated externally after encoding the last MB of a row using the following procedure:

```
/* Special Update for the last MB in the ROW
 * pCoefBufRow - Pointers to the current position in Row Buffer
 * pCoefBufCol - Pointers to the current position in Column Buffer
 * pCoefBufRowStart - Pointers to the start of Row Buffer
 * pCoefBufColStart - Pointers to the start of Column Buffer
 */

if (Last MB in a row) {
    if (MBType == INTRA) {
        *( pCoefBufRow->pYPtr + 8 ) = *( pCoefBufCol->pYPtr + 8 );
        *( pCoefBufRow->pCbPtr ) = *( pCoefBufCol->pCbPtr );
        *( pCoefBufRow->pCrPtr ) = *( pCoefBufCol->pCrPtr );
    }

    /* Update Row Buffer Pointers */
    pCoefBufRow->pYPtr= pCoefBufRowStart->pYPtr + 16;
    pCoefBufRow->pCbPtr= pCoefBufRowStart->pCbPtr + 8;
    pCoefBufRow->pCrPtr= pCoefBufRowStart->pCrPtr + 8;
} else {
    /* Update Row Buffer Pointers */
    pCoefBufRow->pYPtr+=16;
    pCoefBufRow->pCbPtr+=8;
    pCoefBufRow->pCrPtr+=8;
}
```

##### 2. P-Frame Prediction Coefficient Buffer Update

The prediction coefficient buffer pointers are not updated during encoding P-MBs, and therefore the following update procedure should be implemented after encoding a P-MB:

```
/* Update the right-bottom block DC of BD of previous MB */
*(pCoefBufRow->pYPtr - 8) = *( pCoefBufCol->pYPtr + 8 );
/* Mark the buffer as invalid for AC/DC prediction since this is an
```

```

* INTER MB
*/
*(pCoefBufRow->pYPtr) = -1;
*(pCoefBufCol->pYPtr) = -1;
*(pCoefBufCol->pYPtr + 8) = -1;

```

## 6.2.3 Encoder/Decoder Functions

This section defines omxVCM4P2 functions that could be used to construct either an MPEG-4 simple profile encoder or an MPEG-4 simple profile decoder.

### 6.2.3.1 Motion Vector Prediction

#### 6.2.3.1.1 FindMVPred

##### Prototype

```

OMXResult omxVCM4P2_FindMVPred(const OMXVCMotionVector *pSrcMVCurMB, const
    OMXVCMotionVector *pSrcCandMV1, const OMXVCMotionVector *pSrcCandMV2,
    const OMXVCMotionVector *pSrcCandMV3, OMXVCMotionVector *pDstMVPred,
    OMXVCMotionVector *pDstMVPredME, OMX_INT iBlk);

```

##### Description

Predicts a motion vector for the current block using the procedure specified in [ISO14496-2], subclause 7.6.5. The resulting predicted MV is returned in `pDstMVPred`. If the parameter `pDstMVPredME` is not NULL then the set of three MV candidates used for prediction is also returned, otherwise `pDstMVPredME` is NULL upon return.

##### Input Arguments

- `pSrcMVCurMB` – pointer to the MV buffer associated with the current Y macroblock; a value of NULL indicates unavailability.
- `pSrcCandMV1` – pointer to the MV buffer containing the 4 MVs associated with the MB located to the left of the current MB; set to NULL if there is no MB to the left.
- `pSrcCandMV2` – pointer to the MV buffer containing the 4 MVs associated with the MB located above the current MB; set to NULL if there is no MB located above the current MB.
- `pSrcCandMV3` – pointer to the MV buffer containing the 4 MVs associated with the MB located to the right and above the current MB; set to NULL if there is no MB located to the above-right.
- `iBlk` – the index of block in the current macroblock
- `pDstMVPredME` – MV candidate return buffer; if set to NULL then prediction candidate MVs are not returned and `pDstMVPredME` will be NULL upon function return; if `pDstMVPredME` is non-NULL then it must point to a buffer containing sufficient space for three return MVs.

##### Output Arguments

- `pDstMVPred` – pointer to the predicted motion vector

- `pDstMVPredME` – if non-NULL upon input then `pDstMVPredME` points upon return to a buffer containing the three motion vector candidates used for prediction as specified in [ISO14496-2], subclause 7.6.5, otherwise if NULL upon input then `pDstMVPredME` is NULL upon output.

### Returns

- `OMX_Sts_NoErr` – no error
- `OMX_Sts_BadArgErr` – bad arguments; returned under any of the following conditions:
  - the pointer `pDstMVPred` is NULL
  - the parameter `iBlk` does not fall into the range  $0 \leq iBlk \leq 3$

### Reference

[ISO14496-2], subclause 7.6.5.

## 6.2.3.2 Inverse DCT

### 6.2.3.2.1 IDCT8x8blk

#### Prototype

```
OMXResult omxVCM4P2_IDCT8x8blk(const OMX_S16 *pSrc, OMX_S16 *pDst);
```

#### Description

Computes a 2D inverse DCT for a single 8x8 block, as defined in [ISO14496-2].

#### Input Arguments

- `pSrc` – pointer to the start of the linearly arranged IDCT input buffer; must be aligned on a 16-byte boundary. According to [ISO14496-2], the input coefficient values should lie within the range [-2048, 2047].

#### Output Arguments

- `pDst` – pointer to the start of the linearly arranged IDCT output buffer; must be aligned on a 16-byte boundary.

#### Returns

- `OMX_Sts_NoErr` – no error
- `OMX_Sts_BadArgErr` – bad arguments
  - Either `pSrc` or `pDst` is NULL.
  - Either `pSrc` or `pDst` is not 16-byte aligned.

#### Reference

[ISO14496-2]



## 6.2.4 Encoder Functions

This section defines the omxVCM4P2 sub-domain functions that could be used to construct an MPEG-4 simple profile encoder, including functions that support motion estimation, 2D discrete cosine transform (DCT), quantization, motion vector encoding, zig-zag scan, transform coefficient encoding, and variable-length coding (VLC). Both high-level and low-level motion estimation functions are defined, and helper functions are defined to initialize the necessary vendor-specific motion estimation specification structures.

### 6.2.4.1 Motion Estimation Helper

#### 6.2.4.1.1 MEGetBufSize

##### Prototype

```
OMXResult omxVCM4P2_MEGetBufSize (OMXVCM4P2MEMode MEmode, const
    OMXVCM4P2MEParams *pMEParams, OMX_U32 *pSize);
```

##### Description

Computes the size, in bytes, of the vendor-specific specification structure for the following motion estimation functions: BlockMatch\_Integer\_8x8, BlockMatch\_Integer\_16x16, and MotionEstimationMB.

##### Input Arguments

- MEmode – motion estimation mode; available modes are defined by the enumerated type OMXVCM4P2MEMode
- pMEParams – motion estimation parameters

##### Output Arguments

- pSize – pointer to the number of bytes required for the specification structure

##### Returns

- OMX\_Sts\_NoErr – no error
- OMX\_Sts\_BadArgErr – one or more of the following is true:
  - an invalid value was specified for the parameter MEmode
  - a negative or zero value was specified for the parameter pMEParams->searchRange

#### 6.2.4.1.2 MEInit

##### Prototype

```
OMXResult omxVCM4P2_MEInit (OMXVCM4P2MEMode MEmode, const OMXVCM4P2MEParams
    *pMEParams, void *pMESpec);
```

##### Description

Initializes the vendor-specific specification structure required for the following motion estimation functions: BlockMatch\_Integer\_8x8, BlockMatch\_Integer\_16x16, and

MotionEstimationMB. Memory for the specification structure \*pMESpec must be allocated prior to calling the function, and should be aligned on a 4-byte boundary. Following initialization by this function, the vendor-specific structure \*pMESpec should contain an implementation-specific representation of all motion estimation parameters received via the structure pMEParams, for example rndVal, searchRange, etc. The number of bytes required for the specification structure can be determined using the function omxVCM4P2\_MEGetBufSize.

### Input Arguments

- MEmode – motion estimation mode; available modes are defined by the enumerated type OMXVCM4P2MEMode
- pMEParams – motion estimation parameters
- pMESpec – pointer to the uninitialized ME specification structure

### Output Arguments

- pMESpec – pointer to the initialized ME specification structure

### Returns

- OMX\_Sts\_NoErr – no error
- OMX\_Sts\_BadArgErr – one or more of the following is true:
  - an invalid value was specified for the parameter MEmode
  - a negative or zero value was specified for the parameter pMEParams->searchRange

## 6.2.4.2 Motion Estimation, Low-Level

### 6.2.4.2.1 BlockMatch\_Integer\_16x16

#### Prototype

```
OMXResult omxVCM4P2_BlockMatch_Integer_16x16(const OMX_U8 *pSrcRefBuf,
      OMX_INT refWidth, const OMXRect *pRefRect, const OMX_U8 *pSrcCurrBuf,
      const OMXVCM4P2Coordinate *pCurrPointPos, const OMXVCMotionVector
      *pSrcPreMV, const OMX_INT *pSrcPreSAD, void *pMESpec, OMXVCMotionVector
      *pDstMV, OMX_INT *pDstSAD);
```

#### Description

Performs a 16x16 block search; estimates motion vector and associated minimum SAD. Both the input and output motion vectors are represented using half-pixel units, and therefore a shift left or right by 1 bit may be required, respectively, to match the input or output MVs with other functions that either generate output MVs or expect input MVs represented using integer pixel units.

#### Input Arguments

- pSrcRefBuf – pointer to the reference Y plane; points to the reference MB that corresponds to the location of the current macroblock in the current plane.
- refWidth – width of the reference plane

- `pRefRect` – pointer to the valid reference plane rectangle; coordinates are specified relative to the image origin. Rectangle boundaries may extend beyond image boundaries if the image has been padded. For example, if padding extends 4 pixels beyond frame border, then the value for the left border could be set to -4.
- `pSrcCurrBuf` – pointer to the current block in the current macroblock buffer extracted from the original plane (linear array, 256 entries); must be aligned on a 16-byte boundary. The number of bytes between lines (step) is 16.
- `pCurrPointPos` – position of the current macroblock in the current plane
- `pSrcPreMV` – pointer to predicted motion vector; NULL indicates no predicted MV
- `pSrcPreSAD` – pointer to SAD associated with the predicted MV (referenced by `pSrcPreMV`); may be set to NULL if unavailable.
- `pMESpec` – vendor-specific motion estimation specification structure; must have been allocated and then initialized using `omxVCM4P2_MEInit` prior to calling the block matching function.

### Output Arguments

- `pDstMV` – pointer to estimated MV
- `pDstSAD` – pointer to minimum SAD

### Returns

- `OMX_Sts_NoErr` – no error
- `OMX_Sts_BadArgErr` – bad arguments. Returned if one of the following conditions is true:
  - at least one of the following pointers is NULL: `pSrcRefBuf`, `pRefRect`, `pSrcCurrBuf`, `pCurrPointPos`, `pDstMV`, `pDstSAD` or `pMESpec`, or
  - `pSrcCurrBuf` is not 16-byte aligned

## 6.2.4.2.2 BlockMatch\_Integer\_8x8

### Prototype

```
OMXResult omxVCM4P2_BlockMatch_Integer_8x8(const OMX_U8 *pSrcRefBuf, OMX_INT
refWidth, const OMXRect *pRefRect, const OMX_U8 *pSrcCurrBuf, const
OMXVCM4P2Coordinate *pCurrPointPos, const OMXVCMotionVector *pSrcPreMV,
const OMX_INT *pSrcPreSAD, void *pMESpec, OMXVCMotionVector *pDstMV,
OMX_INT *pDstSAD);
```

### Description

Performs an 8x8 block search; estimates motion vector and associated minimum SAD. Both the input and output motion vectors are represented using half-pixel units, and therefore a shift left or right by 1 bit may be required, respectively, to match the input or output MVs with other functions that either generate output MVs or expect input MVs represented using integer pixel units.

### Input Arguments

- `pSrcRefBuf` – pointer to the reference Y plane; points to the reference block that corresponds to the location of the current 8x8 block in the current plane.
- `refWidth` – width of the reference plane

- `pRefRect` – pointer to the valid reference plane rectangle; coordinates are specified relative to the image origin. Rectangle boundaries may extend beyond image boundaries if the image has been padded.
- `pSrcCurrBuf` – pointer to the current block in the current macroblock buffer extracted from the original plane (linear array, 128 entries); must be aligned on an 8-byte boundary. The number of bytes between lines (step) is 16 bytes.
- `pCurrPointPos` – position of the current block in the current plane
- `pSrcPreMV` – pointer to predicted motion vector; NULL indicates no predicted MV
- `pSrcPreSAD` – pointer to SAD associated with the predicted MV (referenced by `pSrcPreMV`); may be set to NULL if unavailable.
- `pMESpec` – vendor-specific motion estimation specification structure; must have been allocated and then initialized using `omxVCM4P2_MEInit` prior to calling the block matching function.

### Output Arguments

- `pDstMV` – pointer to estimated MV
- `pDstSAD` – pointer to minimum SAD

### Returns

- `OMX_Sts_NoErr` – no error
- `OMX_Sts_BadArgErr` – bad arguments. Returned if one of the following conditions is true:
  - at least one of the following pointers is NULL: `pSrcRefBuf`, `pRefRect`, `pSrcCurrBuf`, `pCurrPointPos`, `pDstMV`, `pDstSAD` or `pMESpec`, or
  - `pSrcCurrBuf` is not 8-byte aligned

## 6.2.4.2.3 BlockMatch\_Half\_16x16

### Prototype

```
OMXResult omxVCM4P2_BlockMatch_Half_16x16(const OMX_U8 *pSrcRefBuf, OMX_INT
  refWidth, const OMXRect *pRefRect, const OMX_U8 *pSrcCurrBuf, const
  OMXVCM4P2Coordinate *pSearchPointRefPos, OMX_INT rndVal,
  OMXVCMotionVector *pSrcDstMV, OMX_INT *pDstSAD);
```

### Description

Performs a 16x16 block match with half-pixel resolution. Returns the estimated motion vector and associated minimum SAD. This function estimates the half-pixel motion vector by interpolating the integer resolution motion vector referenced by the input parameter `pSrcDstMV`, i.e., the initial integer MV is generated externally. The input parameters `pSrcRefBuf` and `pSearchPointRefPos` should be shifted by the winning MV of 16x16 integer search prior to calling `BlockMatch_Half_16x16`. The function `BlockMatch_Integer_16x16` may be used for integer motion estimation.

### Input Arguments

- `pSrcRefBuf` – pointer to the reference Y plane; points to the reference macroblock that corresponds to the location of the current macroblock in the current plane.
- `refWidth` – width of the reference plane
- `pRefRect` – reference plane valid region rectangle

- `pSrcCurrBuf` – pointer to the current block in the current macroblock buffer extracted from the original plane (linear array, 256 entries); must be aligned on a 16-byte boundary. The number of bytes between lines (step) is 16.
- `pSearchPointRefPos` – position of the starting point for half pixel search (specified in terms of integer pixel units) in the reference plane, i.e., the reference position pointed to by the predicted motion vector.
- `rndVal` – rounding control parameter: 0 – disabled; 1 - enabled.
- `pSrcDstMV` – pointer to the initial MV estimate; typically generated during a prior 16X16 integer search; specified in terms of half-pixel units.

### Output Arguments

- `pSrcDstMV` – pointer to estimated MV
- `pDstSAD` – pointer to minimum SAD

### Returns

- `OMX_Sts_NoErr` – no error
- `OMX_Sts_BadArgErr` – bad arguments. Returned if one of the following conditions is true:
  - at least one of the following pointers is NULL: `pSrcRefBuf`, `pRefRect`, `pSrcCurrBuf`, `pSearchPointRefPos`, `pSrcDstMV`, or
  - `pSrcCurrBuf` is not 16-byte aligned, or

## 6.2.4.2.4 BlockMatch\_Half\_8x8

### Prototype

```
OMXResult omxVCM4P2_BlockMatch_Half_8x8(const OMX_U8 *pSrcRefBuf, OMX_INT
    refWidth, const OMXRect *pRefRect, const OMX_U8 *pSrcCurrBuf, const
    OMXVCM4P2Coordinate *pSearchPointRefPos, OMX_INT rndVal,
    OMXVCMotionVector *pSrcDstMV, OMX_INT *pDstSAD);
```

### Description

Performs an 8x8 block match with half-pixel resolution. Returns the estimated motion vector and associated minimum SAD. This function estimates the half-pixel motion vector by interpolating the integer resolution motion vector referenced by the input parameter `pSrcDstMV`, i.e., the initial integer MV is generated externally. The input parameters `pSrcRefBuf` and `pSearchPointRefPos` should be shifted by the winning MV of 8x8 integer search prior to calling `BlockMatch_Half_8x8`. The function `BlockMatch_Integer_8x8` may be used for integer motion estimation.

### Input Arguments

- `pSrcRefBuf` – pointer to the reference Y plane; points to the reference block that corresponds to the location of the current 8x8 block in the current plane.
- `refWidth` – width of the reference plane
- `pRefRect` – reference plane valid region rectangle
- `pSrcCurrBuf` – pointer to the current block in the current macroblock buffer extracted from the original plane (linear array, 128 entries); must be aligned on a 8-byte boundary. The number of bytes between lines (step) is 16.

- `pSearchPointRefPos` – position of the starting point for half pixel search (specified in terms of integer pixel units) in the reference plane.
- `rndVal` – rounding control parameter: 0 – disabled; 1 - enabled.
- `pSrcDstMV` – pointer to the initial MV estimate; typically generated during a prior 8x8 integer search, specified in terms of half-pixel units.

### Output Arguments

- `pSrcDstMV` – pointer to estimated MV
- `pDstSAD` – pointer to minimum SAD

### Returns

- `OMX_Sts_NoErr` – no error
- `OMX_Sts_BadArgErr` – bad arguments. Returned if one of the following conditions is true:
  - at least one of the following pointers is NULL: `pSrcRefBuf`, `pRefRect`, `pSrcCurrBuf`, `pSearchPointRefPos`, `pSrcDstMV`, or
  - `pSrcCurrBuf` is not 8-byte aligned

## 6.2.4.3 MotionEstimation, High-Level

### 6.2.4.3.1 MotionEstimationMB

#### Prototype

```
OMXResult omxVCM4P2_MotionEstimationMB(const OMX_U8 *pSrcCurrBuf, OMX_S32
    srcCurrStep, const OMX_U8 *pSrcRefBuf, OMX_S32 srcRefStep, const OMXRect
    *pRefRect, const OMXVCM4P2Coordinate *pCurrPointPos, void *pMESpec,
    const OMXVCM4P2MBInfoPtr *pMBInfo, OMXVCM4P2MBInfo *pSrcDstMBCurr,
    OMX_U16 *pDstSAD, OMX_U16 *pDstBlockSAD);
```

#### Description

Performs motion search for a 16x16 macroblock. Selects best motion search strategy from among inter-1MV, inter-4MV, and intra modes. Supports integer and half pixel resolution.

#### Input Arguments

- `pSrcCurrBuf` – pointer to the top-left corner of the current MB in the original picture plane; must be aligned on a 16-byte boundary. The function does not expect source data outside the region bounded by the MB to be available; for example it is not necessary for the caller to guarantee the availability of `pSrcCurrBuf[-SrcCurrStep]`, i.e., the row of pixels above the MB to be processed.
- `srcCurrStep` – width of the original picture plane, in terms of full pixels; must be a multiple of 16.
- `pSrcRefBuf` – pointer to the reference Y plane; points to the reference plane location corresponding to the location of the current macroblock in the current plane; must be aligned on a 16-byte boundary.
- `srcRefStep` – width of the reference picture plane, in terms of full pixels; must be a multiple of 16.
- `pRefRect` – reference plane valid region rectangle, specified relative to the image origin
- `pCurrPointPos` – position of the current macroblock in the current plane

- `pMESpec` – pointer to the vendor-specific motion estimation specification structure; must be allocated and then initialized using `omxVCM4P2_MEInit` prior to calling this function.
- `pMBInfo` – array, of dimension four, containing pointers to information associated with four nearby MBs:
  - `pMBInfo[0]` – pointer to left MB information
  - `pMBInfo[1]` – pointer to top MB information
  - `pMBInfo[2]` – pointer to top-left MB information
  - `pMBInfo[3]` – pointer to top-right MB information

Any pointer in the array may be set equal to `NULL` if the corresponding MB doesn't exist. For each MB, the following structure members are used:

  - `mbType` - macroblock type, either `OMX_VC_INTRA`, `OMX_VC_INTER`, or `OMX_VC_INTER4V`
  - `pMV0[2][2]` – estimated motion vectors; represented in  $\frac{1}{2}$  pixel units
  - `sliceID` – number of the slice to which the MB belongs
- `pSrcDstMBCurr` – pointer to information structure for the current MB. The following entries should be set prior to calling the function: `sliceID` – the number of the slice the to which the current MB belongs. The structure elements `cbpy` and `cbpc` are ignored.

### Output Arguments

- `pSrcDstMBCurr` – pointer to updated information structure for the current MB after MB-level motion estimation has been completed. The following structure members are updated by the ME function:
  - `mbType` - macroblock type: `OMX_VC_INTRA`, `OMX_VC_INTER`, or `OMX_VC_INTER4V`.
  - `pMV0[2][2]` - estimated motion vectors; represented in terms of  $\frac{1}{2}$ -pel units.
  - `pMVPred[2][2]` - predicted motion vectors; represented in terms of  $\frac{1}{2}$ -pel units.

The structure members `cbpy` and `cbpc` are not updated by the function.
- `pDstSAD` – pointer to the minimum SAD for `INTER1V`, or sum of minimum SADs for `INTER4V`
- `pDstBlockSAD` – pointer to an array of SAD values for each of the four 8x8 luma blocks in the MB. The block SADs are in scan order for each MB.

### Returns

- `OMX_Sts_NoErr` – no error
- `OMX_Sts_BadArgErr` – bad arguments. Returned if one or more of the following conditions is true:
  - at least one of the following pointers is `NULL`: `pSrcCurrBuf`, `pSrcRefBuf`, `pRefRect`, `pCurrPointPos`, `pMBInter`, `pMBIntra`, `pSrcDstMBCurr`, or `pDstSAD`.

## 6.2.4.4 DCT and Quantization

### 6.2.4.4.1 DCT8x8blk

#### Prototype

```
OMXResult omxVCM4P2_DCT8x8blk(const OMX_S16 *pSrc, OMX_S16 *pDst);
```

#### Description

Computes a 2D forward DCT for a single 8x8 block, as defined in [ISO14496-2].

#### Input Arguments

- `pSrc` – pointer to the start of the linearly arranged input buffer; must be aligned on a 16-byte boundary. Input values (pixel intensities) are valid in the range [-255,255].

#### Output Arguments

- `pDst` – pointer to the start of the linearly arranged output buffer; must be aligned on a 16-byte boundary.

#### Returns

- `OMX_Sts_NoErr` – no error
- `OMX_Sts_BadArgErr` – bad arguments
  - Either `pSrc` or `pDst` is NULL.
  - Either `pSrc` or `pDst` is not 16-byte aligned.

#### Reference

[ISO14496-2]

### 6.2.4.4.2 QuantIntra\_I

#### Prototype

```
OMXResult omxVCM4P2_QuantIntra_I(OMX_S16 *pSrcDst, OMX_U8 QP, OMX_INT  
    blockIndex, OMX_INT shortVideoHeader);
```

#### Description

Performs quantization on intra block coefficients. This function supports `bits_per_pixel == 8`.

#### Input Arguments

- `pSrcDst` – pointer to the input intra block coefficients; must be aligned on a 16-byte boundary.
- `QP` – quantization parameter (`quantizer_scale`).
- `blockIndex` – block index indicating the component type and position, valid in the range 0 to 5, as defined in [ISO14496-2], subclause 6.1.3.8.



- `shortVideoHeader` – binary flag indicating presence of `short_video_header`; `shortVideoHeader==1` selects linear intra DC mode, and `shortVideoHeader==0` selects non-linear intra DC mode.

### Output Arguments

- `pSrcDst` – pointer to the output (quantized) interblock coefficients. When `shortVideoHeader==1`, AC coefficients are saturated on the interval [-127, 127], and DC coefficients are saturated on the interval [1, 254]. When `shortVideoHeader==0`, AC coefficients are saturated on the interval [-2047, 2047].

### Returns

- `OMX_Sts_NoErr` – no error
- `OMX_Sts_BadArgErr` – bad arguments
  - `pSrcDst` is NULL.
  - `blockIndex < 0` or `blockIndex >= 10`
  - `QP <= 0` or `QP >= 32`.

## 6.2.4.4.3 QuantInter\_I

### Prototype

```
OMXResult omxVCM4P2_QuantInter_I(OMX_S16 *pSrcDst, OMX_U8 QP, OMX_INT shortVideoHeader);
```

### Description

Performs quantization on an inter coefficient block; supports `bits_per_pixel == 8`.

### Input Arguments

- `pSrcDst` – pointer to the input inter block coefficients; must be aligned on a 16-byte boundary.
- `QP` – quantization parameter (`quantizer_scale`)
- `shortVideoHeader` – binary flag indicating presence of `short_video_header`; `shortVideoHeader==1` selects linear intra DC mode, and `shortVideoHeader==0` selects non-linear intra DC mode.

### Output Arguments

- `pSrcDst` – pointer to the output (quantized) interblock coefficients. When `shortVideoHeader==1`, AC coefficients are saturated on the interval [-127, 127], and DC coefficients are saturated on the interval [1, 254]. When `shortVideoHeader==0`, AC coefficients are saturated on the interval [-2047, 2047].

### Returns

- `OMX_Sts_NoErr` – no error
- `OMX_Sts_BadArgErr` – bad arguments
  - `pSrcDst` is NULL.
  - `QP <= 0` or `QP >= 32`.

## 6.2.4.4.4 TransRecBlockCoef\_intra

### Prototype

```
OMXResult omxVCM4P2_TransRecBlockCoef_intra(const OMX_U8 *pSrc, OMX_S16
    *pDst, OMX_U8 *pRec, OMX_S16 *pPredBufRow, OMX_S16 *pPredBufCol, OMX_S16
    *pPreACPredict, OMX_INT *pSumErr, OMX_INT blockIndex, OMX_U8 curQp,
    const OMX_U8 *pQpBuf, OMX_INT srcStep, OMX_INT dstStep, OMX_INT
    shortVideoHeader);
```

### Description

Quantizes the DCT coefficients, implements intra block AC/DC coefficient prediction, and reconstructs the current intra block texture for prediction on the next frame. Quantized row and column coefficients are returned in the updated coefficient buffers.

### Input Arguments

- `pSrc` – pointer to the pixels of current intra block; must be aligned on an 8-byte boundary.
- `pPredBufRow` – pointer to the coefficient row buffer containing  $((\text{num\_mb\_per\_row} * 2 + 1) * 8)$  elements of type `OMX_S16`. Coefficients are organized into blocks of eight as described below (Internal Prediction Coefficient Update Procedures). The DC coefficient is first, and the remaining buffer locations contain the quantized AC coefficients. Each group of eight row buffer elements combined with one element eight elements ahead contains the coefficient predictors of the neighboring block that is spatially above or to the left of the block currently to be decoded. A negative-valued DC coefficient indicates that this neighboring block is not INTRA-coded or out of bounds, and therefore the AC and DC coefficients are invalid. Pointer must be aligned on an 8-byte boundary.
- `pPredBufCol` – pointer to the prediction coefficient column buffer containing 16 elements of type `OMX_S16`. Coefficients are organized as described in section 6.2.2.5. Pointer must be aligned on an 8-byte boundary.
- `pSumErr` – pointer to a flag indicating whether or not AC prediction is required; AC prediction is enabled if `*pSumErr >= 0`, but the value is not used for coefficient prediction, i.e., the sum of absolute differences starts from 0 for each call to this function. Otherwise AC prediction is disabled if `*pSumErr < 0`.
- `blockIndex` – block index indicating the component type and position, as defined in [ISO14496-2], subclause 6.1.3.8.
- `curQp` – quantization parameter of the macroblock to which the current block belongs
- `pQpBuf` – pointer to a 2-element quantization parameter buffer; `pQpBuf[0]` contains the quantization parameter associated with the 8x8 block left of the current block (QPa), and `pQpBuf[1]` contains the quantization parameter associated with the 8x8 block above the current block (QPC). In the event that the corresponding block is outside of the VOP bound, the Qp value will not affect the intra prediction process, as described in [ISO14496-2], sub-clause 7.4.3.3, “Adaptive AC Coefficient Prediction.”
- `srcStep` – width of the source buffer; must be a multiple of 8.
- `dstStep` – width of the reconstructed destination buffer; must be a multiple of 16.
- `shortVideoHeader` – binary flag indicating presence of `short_video_header`; `shortVideoHeader==1` selects linear intra DC mode, and `shortVideoHeader==0` selects non-linear intra DC mode.

## Output Arguments

- `pDst` – pointer to the quantized DCT coefficient buffer; `pDst[0]` contains the predicted DC coefficient; the remaining entries contain the quantized AC coefficients (without prediction). The pointer `pDst` must be aligned on a 16-byte boundary.
- `pRec` – pointer to the reconstructed texture; must be aligned on an 8-byte boundary.
- `pPredBufRow` – pointer to the updated coefficient row buffer
- `pPredBufCol` – pointer to the updated coefficient column buffer
- `pPreACPredict` – if prediction is enabled, the parameter points to the start of the buffer containing the coefficient differences for VLC encoding. The entry `pPreACPredict[0]` indicates prediction direction for the current block and takes one of the following values: `OMX_VC_NONE` (prediction disabled), `OMX_VC_HORIZONTAL`, or `OMX_VC_VERTICAL`. The entries `pPreACPredict[1]`–`pPreACPredict[7]` contain predicted AC coefficients. If prediction is disabled (`*pSumErr<0`) then the contents of this buffer are undefined upon return from the function
- `pSumErr` – pointer to the value of the accumulated AC coefficient errors, i.e., sum of the absolute differences between predicted and unpredicted AC coefficients

## Returns

- `OMX_Sts_NoErr` – no error
- `OMX_Sts_BadArgErr` – Bad arguments
  - At least one of the following pointers is NULL: `pSrc`, `pDst`, `pRec`, `pCoefBufRow`, `pCoefBufCol`, `pQpBuf`, `pPreACPredict`, `pSumErr`.
  - `BlockIndex < 0` or `blockIndex >= 10`; `curQP <= 0` or `curQP >= 32`.
  - `SrcStep`, `dstStep <= 0` or not a multiple of 8.
  - At least one of the following pointers is not 16-byte aligned: `pDst`.
  - At least one of the following pointers is not 8-byte aligned: `pSrc`, `pRec`.



*Note: The coefficient buffers must be updated in accordance with the update procedures defined in section in 6.2.2.*

---

### 6.2.4.4.5 TransRecBlockCoef\_inter

#### Prototype

```
OMXResult omxVCM4P2_TransRecBlockCoef_inter(const OMX_S16 *pSrc, OMX_S16
    *pDst, OMX_S16 *pRec, OMX_U8 QP, OMX_INT shortVideoHeader);
```

#### Description

Implements DCT, and quantizes the DCT coefficients of the inter block while reconstructing the texture residual. There is no boundary check for the bit stream buffer.

### Input Arguments

- `pSrc` – pointer to the residuals to be encoded; must be aligned on an 16-byte boundary.
- `QP` – quantization parameter.
- `shortVideoHeader` – binary flag indicating presence of `short_video_header`; `shortVideoHeader==1` selects linear intra DC mode, and `shortVideoHeader==0` selects non-linear intra DC mode.

### Output Arguments

- `pDst` – pointer to the quantized DCT coefficients buffer; must be aligned on a 16-byte boundary.
- `pRec` – pointer to the reconstructed texture residuals; must be aligned on a 16-byte boundary.

### Returns

- `OMX_Sts_NoErr` – no error
- `OMX_Sts_BadArgErr` – bad arguments
  - At least one of the following pointers is either NULL or not 16-byte aligned: `pSrc`, `pDst`, `pRec`.
  - `QP <= 0` or `QP >= 32`.

## 6.2.4.5 Motion Vector Encoding and VLC

### 6.2.4.5.1 EncodeVLCZigzag\_IntraDCVLC

### 6.2.4.5.2 EncodeVLCZigzag\_IntraACVLC

#### Prototype

```
OMXResult omxVCM4P2_EncodeVLCZigzag_IntraDCVLC(OMX_U8 **ppBitStream, OMX_INT
    *pBitOffset, const OMX_S16 *pQDctBlkCoef, OMX_U8 predDir, OMX_U8
    pattern, OMX_INT shortVideoHeader, OMXVCM4P2VideoComponent videoComp);
OMXResult omxVCM4P2_EncodeVLCZigzag_IntraACVLC(OMX_U8 **ppBitStream, OMX_INT
    *pBitOffset, const OMX_S16 *pQDctBlkCoef, OMX_U8 predDir, OMX_U8
    pattern, OMX_INT shortVideoHeader);
```

#### Description

Performs zigzag scan and VLC encoding of AC and DC coefficients for one intra block. Two versions of the function (DCVLC and ACVLC) are provided in order to support the two different methods of processing DC coefficients, as described in [ISO14496-2], subclause 7.4.1.4, “Intra DC Coefficient Decoding for the Case of Switched VLC Encoding.”

#### Input Arguments

- `ppBitStream` – double pointer to the current byte in the bitstream
- `pBitOffset` – pointer to the bit position in the byte pointed by `*ppBitStream`. Valid within 0 to 7.
- `pQDctBlkCoef` – pointer to the quantized DCT coefficient
- `predDir` – AC prediction direction, which is used to decide the zigzag scan pattern; takes one of the following values:
  - `OMX_VC_NONE` – AC prediction not used. Performs classical zigzag scan.

- OMX\_VC\_HORIZONTAL – Horizontal prediction. Performs alternate-vertical zigzag scan.
- OMX\_VC\_VERTICAL – Vertical prediction. Performs alternate-horizontal zigzag scan.
- pattern – block pattern which is used to decide whether this block is encoded
- videoComp – video component type (luminance, chrominance) of the current block
- shortVideoHeader – binary flag indicating presence of short\_video\_header; escape modes 0-3 are used if shortVideoHeader==0, and escape mode 4 is used when shortVideoHeader==1.

### Output Arguments

- ppBitStream – \*ppBitStream is updated after the block is encoded, so that it points to the current byte in the bit stream buffer.
- pBitOffset – \*pBitOffset is updated so that it points to the current bit position in the byte pointed by \*ppBitStream.

### Returns

- OMX\_Sts\_NoErr – no error
- OMX\_Sts\_BadArgErr – Bad arguments
  - At least one of the following pointers is NULL: ppBitStream, \*ppBitStream, pBitOffset, pQDctBlkCoef.
  - \*pBitOffset < 0, or \*pBitOffset > 7.
  - PredDir is not one of: OMX\_VC\_NONE, OMX\_VC\_HORIZONTAL, or OMX\_VC\_VERTICAL.
  - VideoComp is not one component of enum OMXVCM4P2VideoComponent.

### Reference

[ISO14496-2], subclause 7.4.1.4.

## 6.2.4.5.3 EncodeVLCZigzag\_Inter

### Prototype

```
OMXResult omxVCM4P2_EncodeVLCZigzag_Inter(OMX_U8 **ppBitStream, OMX_INT
    *pBitOffset, const OMX_S16 *pQDctBlkCoef, OMX_U8 pattern, OMX_INT
    shortVideoHeader);
```

### Description

Performs classical zigzag scanning and VLC encoding for one inter block.

### Input Arguments

- ppBitStream – pointer to the pointer to the current byte in the bit stream
- pBitOffset – pointer to the bit position in the byte pointed by \*ppBitStream. Valid within 0 to 7
- pQDctBlkCoef – pointer to the quantized DCT coefficient
- pattern – block pattern which is used to decide whether this block is encoded
- shortVideoHeader – binary flag indicating presence of short\_video\_header; escape modes 0-3 are used if shortVideoHeader==0, and escape mode 4 is used when shortVideoHeader==1.

## Output Arguments

- `ppBitStream` – `*ppBitStream` is updated after the block is encoded so that it points to the current byte in the bit stream buffer.
- `pBitOffset` – `*pBitOffset` is updated so that it points to the current bit position in the byte pointed by `*ppBitStream`.

## Returns

- `OMX_Sts_NoErr` – no error
- `OMX_Sts_BadArgErr` – Bad arguments
  - At least one of the pointers: is NULL: `ppBitStream`, `*ppBitStream`, `pBitOffset`, `pQDctBlkCoef`
  - `*pBitOffset < 0`, or `*pBitOffset > 7`.

### 6.2.4.5.4 EncodeMV

#### Prototype

```
OMXResult omxVCM4P2_EncodeMV(OMX_U8 **ppBitStream, OMX_INT *pBitOffset,
    const OMXVCMotionVector *pMVCurMB, const OMXVCMotionVector
    *pSrcMVLeftMB, const OMXVCMotionVector *pSrcMVUpperMB, const
    OMXVCMotionVector *pSrcMVUpperRightMB, OMX_INT fcodeForward,
    OMXVCM4P2MacroblockType MBType);
```

#### Description

Predicts a motion vector for the current macroblock, encodes the difference, and writes the output to the stream buffer. The input MVs `pMVCurMB`, `pSrcMVLeftMB`, `pSrcMVUpperMB`, and `pSrcMVUpperRightMB` should lie within the ranges associated with the input parameter `fcodeForward`, as described in [ISO14496-2], subclause 7.6.3. This function provides a superset of the functionality associated with the function `omxVCM4P2_FindMVPred`.

#### Input Arguments

- `ppBitStream` – double pointer to the current byte in the bitstream buffer
- `pBitOffset` – index of the first free (next available) bit in the stream buffer referenced by `*ppBitStream`, valid in the range 0 to 7.
- `pMVCurMB` – pointer to the current macroblock motion vector; a value of `NULL` indicates unavailability.
- `pSrcMVLeftMB` – pointer to the source left macroblock motion vector; a value of `NULL` indicates unavailability.
- `pSrcMVUpperMB` – pointer to source upper macroblock motion vector; a value of `NULL` indicates unavailability.
- `pSrcMVUpperRightMB` – pointer to source upper right MB motion vector; a value of `NULL` indicates unavailability.
- `fcodeForward` – an integer with values from 1 to 7; used in encoding motion vectors related to search range, as described in [ISO14496-2], subclause 7.6.3.
- `MBType` – macro block type, valid in the range 0 to 5

## Output Arguments

- `ppBitStream` – updated pointer to the current byte in the bit stream buffer
- `pBitOffset` – updated index of the next available bit position in stream buffer referenced by `*ppBitStream`

## Returns

- `OMX_Sts_NoErr` – no error
- `OMX_Sts_BadArgErr` – bad arguments
  - At least one of the following pointers is NULL: `ppBitStream`, `*ppBitStream`, `pBitOffset`, `pMVCurMB`
  - `*pBitOffset < 0`, or `*pBitOffset > 7`.
  - `fcodeForward <= 0`, or `fcodeForward > 7`, or `MBType < 0`.

## Reference

[ISO14496-2], subclause 7.6.3.

## 6.2.5 Decoder Functions

This section describes `omxVCM4P2` functions that can be used to construct an MPEG-4 simple profile decoder.

### 6.2.5.1 Motion Vector Decoding

#### 6.2.5.1.1 DecodePadMV\_PVOP

##### Prototype

```
OMXResult omxVCM4P2_DecodePadMV_PVOP(const OMX_U8 **ppBitStream, OMX_INT
    *pBitOffset, OMXVCMotionVector *pSrcMVLeftMB, OMXVCMotionVector
    *pSrcMVUpperMB, OMXVCMotionVector *pSrcMVUpperRightMB, OMXVCMotionVector
    *pDstMVCurMB, OMX_INT fcodeForward, OMXVCM4P2MacroblockType MBType);
```

##### Description

Decodes and pads the four motion vectors associated with a non-intra P-VOP macroblock. For macroblocks of type `OMX_VC_INTER4V`, the output MV is padded as specified in [ISO14496-2], subclause 7.6.1.6. Otherwise, for macroblocks of types other than `OMX_VC_INTER4V`, the decoded MV is copied to all four output MV buffer entries.

##### Input Arguments

- `ppBitStream` – pointer to the pointer to the current byte in the bit stream buffer
- `pBitOffset` – pointer to the bit position in the byte pointed to by `*ppBitStream`. `*pBitOffset` is valid within [0-7].
- `pSrcMVLeftMB`, `pSrcMVUpperMB`, and `pSrcMVUpperRightMB` – pointers to the motion vector buffers of the macroblocks specially at the left, upper, and upper-right side of the current macroblock, respectively; a value of `NULL` indicates unavailability.



**Note:** Any neighborhood macroblock outside the current VOP or video packet or outside the current GOB (when `short_video_header` is “1”) for which `gob_header_empty` is “0” is treated as transparent, according to [ISO14496-2], subclause 7.6.5.

---

- `fcodeForward` – a code equal to `vop_fcode_forward` in MPEG-4 bit stream syntax
- `MbType` – the type of the current macroblock. If `MbType` is not equal to `OMX_VC_INTER4V`, the destination motion vector buffer is still filled with the same decoded vector.

### Output Arguments

- `ppBitStream` – `*ppBitStream` is updated after the block is decoded, so that it points to the current byte in the bit stream buffer
- `pBitOffset` – `*pBitOffset` is updated so that it points to the current bit position in the byte pointed by `*ppBitStream`
- `pDstMVCurMB` – pointer to the motion vector buffer for the current macroblock; contains four decoded motion vectors

### Returns

- `OMX_Sts_NoErr` – no error
- `OMX_Sts_BadArgErr` – bad arguments
  - At least one of the following pointers is NULL: `ppBitStream`, `*ppBitStream`, `pBitOffset`, `pDstMVCurMB`  
or
  - At least one of following cases is true: `*pBitOffset` exceeds [0,7], `fcodeForward` exceeds (0,7], `MbType` less than zero, motion vector buffer is not 4-byte aligned.
- `OMX_Sts_Err` – status error

## 6.2.5.2 VLC Decoding/Inverse Zig-Zag Scan

### 6.2.5.2.1 DecodeVLCZigzag\_IntraDCVLC

### 6.2.5.2.2 DecodeVLCZigzag\_IntraACVLC

#### Prototype

```
OMXResult omxVCM4P2_DecodeVLCZigzag_IntraDCVLC(const OMX_U8 **ppBitStream,  
        OMX_INT *pBitOffset, OMX_S16 *pDst, OMX_U8 predDir, OMX_INT  
        shortVideoHeader, OMXVCM4P2VideoComponent videoComp);
```

```
OMXResult omxVCM4P2_DecodeVLCZigzag_IntraACVLC(const OMX_U8 **ppBitStream,  
        OMX_INT *pBitOffset, OMX_S16 *pDst, OMX_U8 predDir, OMX_INT  
        shortVideoHeader);
```

#### Description

Performs VLC decoding and inverse zigzag scan of AC and DC coefficients for one intra block. Two versions of the function (DCVLC and ACVLC) are provided in order to support the two different methods



of processing DC coefficients, as described in [ISO14496-2], subclause 7.4.1.4, “Intra DC Coefficient Decoding for the Case of Switched VLC Encoding.”

## Input Arguments

- `ppBitStream` – pointer to the pointer to the current byte in the bitstream buffer
- `pBitOffset` – pointer to the bit position in the current byte referenced by `*ppBitStream`. The parameter `*pBitOffset` is valid in the range [0-7].  
Bit Position in one byte:                   |Most   Least|  
                  `*pBitOffset`                   |0   1   2   3   4   5   6   7|
- `predDir` – AC prediction direction; used to select the zigzag scan pattern; takes one of the following values:
  - `OMX_VC_NONE` – AC prediction not used; performs classical zigzag scan.
  - `OMX_VC_HORIZONTAL` – Horizontal prediction; performs alternate-vertical zigzag scan;
  - `OMX_VC_VERTICAL` – Vertical prediction; performs alternate-horizontal zigzag scan.
- `shortVideoHeader` – binary flag indicating presence of `short_video_header`; escape modes 0-3 are used if `shortVideoHeader==0`, and escape mode 4 is used when `shortVideoHeader==1`.
- `videoComp` – video component type (luminance or chrominance) of the current block

## Output Arguments

- `ppBitStream` – `*ppBitStream` is updated after the block is decoded such that it points to the current byte in the bit stream buffer
- `pBitOffset` – `*pBitOffset` is updated such that it points to the current bit position in the byte pointed by `*ppBitStream`
- `pDst` – pointer to the coefficient buffer of current block; must be 4-byte aligned.

## Returns

- `OMX_Sts_NoErr` – no error
- `OMX_Sts_BadArgErr` – bad arguments
  - At least one of the following pointers is NULL: `ppBitStream`, `*ppBitStream`, `pBitOffset`, `pDst`, or
  - At least one of the following conditions is true: `*pBitOffset` exceeds [0,7], `predDir` exceeds [0,2], or
  - `pDst` is not 4-byte aligned
- `OMX_Sts_Err`
  - In `DecodeVLCZigzag_IntraDCVLC`, `dc_size > 12`
  - At least one of mark bits equals zero
  - Illegal stream encountered; code cannot be located in VLC table
  - Forbidden code encountered in the VLC FLC table
  - The number of coefficients is greater than 64

## Reference

[ISO14496-2], subclause 7.4.1.4.

### 6.2.5.2.3 DecodeVLCZigzag\_Inter

#### Prototype

```
OMXResult omxVCM4P2_DecodeVLCZigzag_Inter(const OMX_U8 **ppBitStream,  
      OMX_INT *pBitOffset, OMX_S16 *pDst, OMX_INT shortVideoHeader);
```

#### Description

Performs VLC decoding and inverse zigzag scan for one inter-coded block.

#### Input Arguments

- `ppBitStream` – double pointer to the current byte in the stream buffer
- `pBitOffset` – pointer to the next available bit in the current stream byte referenced by `*ppBitStream`. The parameter `*pBitOffset` is valid within the range [0-7].
- `shortVideoHeader` – binary flag indicating presence of `short_video_header`; escape modes 0-3 are used if `shortVideoHeader==0`, and escape mode 4 is used when `shortVideoHeader==1`.

#### Output Arguments

- `ppBitStream` – `*ppBitStream` is updated after the block is decoded such that it points to the current byte in the stream buffer
- `pBitOffset` – `*pBitOffset` is updated after decoding such that it points to the next available bit in the stream byte referenced by `*ppBitStream`
- `pDst` – pointer to the coefficient buffer of current block; must be 4-byte aligned.

#### Returns

- `OMX_Sts_BadArgErr` – bad arguments
  - At least one of the following pointers is NULL: `ppBitStream`, `*ppBitStream`, `pBitOffset`, `pDst`, or
  - `pDst` is not 4-byte aligned, or
  - `*pBitOffset` exceeds [0,7].
- `OMX_Sts_Err` – status error
  - At least one mark bit is equal to zero
  - Encountered an illegal stream code that cannot be found in the VLC table
  - Encountered and illegal code in the VLC FLC table
  - The number of coefficients is greater than 64

## 6.2.5.3 Inverse Quantization

### 6.2.5.3.1 QuantInvIntra\_I

### 6.2.5.3.2 QuantInvInter\_I

#### Prototype

```
OMXResult omxVCM4P2_QuantInvIntra_I(OMX_S16 *pSrcDst, OMX_INT QP,  
    OMXVCM4P2VideoComponent videoComp, OMX_INT shortVideoHeader);  
OMXResult omxVCM4P2_QuantInvInter_I(OMX_S16 *pSrcDst, OMX_INT QP);
```

#### Description

Performs the second inverse quantization mode on an intra/inter coded block. Supports `bits_per_pixel = 8`. The output coefficients are clipped to the range `[-2048, 2047]`.

#### Input Arguments

- `pSrcDst` – pointer to the input (quantized) intra/inter block; must be aligned on a 16-byte boundary.
- `QP` – quantization parameter (`quantizer_scale`)
- `videoComp` – video component type of the current block. Takes one of the following flags: `OMX_VC_LUMINANCE`, `OMX_VC_CHROMINANCE` (intra version only).
- `shortVideoHeader` – binary flag indicating presence of `short_video_header` (intra version only).

#### Output Arguments

- `pSrcDst` – pointer to the output (dequantized) intra/inter block

#### Returns

- `OMX_Sts_NoErr` – no error
- `OMX_Sts_BadArgErr` – bad arguments; one or more of the following is true:
  - `pSrcDst` is `NULL`
  - `QP <= 0` or `QP >= 31`
  - `videoComp` is neither `OMX_VC_LUMINANCE` nor `OMX_VC_CHROMINANCE`.

## 6.2.5.4 Inverse Quantization/Zig-Zag Scan/DCT

### 6.2.5.4.1 DecodeBlockCoef\_Intra

#### Prototype

```
OMXResult omxVCM4P2_DecomposeBlockCoef_Intra(const OMX_U8 **ppBitStream,  
    OMX_INT *pBitOffset, OMX_U8 *pDst, OMX_INT step, OMX_S16 *pCoefBufRow,  
    OMX_S16 *pCoefBufCol, OMX_U8 curQP, const OMX_U8 *pQPBuf, OMX_INT  
    blockIndex, OMX_INT intraDCVLC, OMX_INT ACPredFlag, OMX_INT  
    shortVideoHeader);
```

## Description

Decodes the INTRA block coefficients. Inverse quantization, inversely zigzag positioning, and IDCT, with appropriate clipping on each step, are performed on the coefficients. The results are then placed in the output frame/plane on a pixel basis.



**Note:** This function will be used only when at least one non-zero AC coefficient of current block exists in the bit stream. The DC only condition will be handled in another function.

---

## Input Arguments

- `ppBitStream` – pointer to the pointer to the current byte in the bit stream buffer. There is no boundary check for the bit stream buffer.
- `pBitOffset` – pointer to the bit position in the byte pointed to by `*ppBitStream`. `*pBitOffset` is valid within [0-7].
- `step` – width of the destination plane
- `pCoefBufRow` – pointer to the coefficient row buffer; must be aligned on an 8-byte boundary.
- `pCoefBufCol` – pointer to the coefficient column buffer; must be aligned on an 8-byte boundary.
- `curQP` – quantization parameter of the macroblock which the current block belongs to
- `pQPBuf` – pointer to the quantization parameter buffer
- `blockIndex` – block index indicating the component type and position as defined in [ISO14496-2], subclause 6.1.3.8, Figure 6-5.
- `intraDCVLC` – a code determined by `intra_dc_vlc_thr` and `QP`. This allows a mechanism to switch between two VLC for coding of Intra DC coefficients as per [ISO14496-2], Table 6-21.
- `ACPredFlag` – a flag equal to `ac_pred_flag` (of luminance) indicating if the ac coefficients of the first row or first column are differentially coded for intra coded macroblock.
- `shortVideoHeader` – binary flag indicating presence of `short_video_header`; `shortVideoHeader==1` selects linear intra DC mode, and `shortVideoHeader==0` selects non-linear intra DC mode.

## Output Arguments

- `ppBitStream` – `*ppBitStream` is updated after the block is decoded, so that it points to the current byte in the bit stream buffer
- `pBitOffset` – `*pBitOffset` is updated so that it points to the current bit position in the byte pointed by `*ppBitStream`
- `pDst` – pointer to the block in the destination plane; must be aligned on an 8-byte boundary.
- `pCoefBufRow` – pointer to the updated coefficient row buffer.
- `pCoefBufCol` – pointer to the updated coefficient column buffer



**Note:** The coefficient buffers must be updated in accordance with the update procedure defined in section 6.2.2.

---

## Returns

- `OMX_Sts_NoErr` – no error
- `OMX_Sts_BadArgErr` – bad arguments
  - At least one of the following pointers is NULL: `ppBitStream`, `*ppBitStream`, `pBitOffset`, `pCoefBufRow`, `pCoefBufCol`, `pQPBuf`, `pDst`.  
or
  - At least one of the below case: `*pBitOffset` exceeds [0,7], `curQP` exceeds (1, 31), `blockIndex` exceeds [0,5], `step` is not the multiple of 8.  
or
  - At least one of the pointer alignment requirements was violated.
- `OMX_Sts_Err` – status error

Refer to “DecodeVLCZigzag\_Intra”.

### 6.2.5.4.2 DecodeBlockCoef\_Inter

#### Prototype

```
OMXResult omxVCM4P2_DecomposeBlockCoef_Inter(const OMX_U8 **ppBitStream,
      OMX_INT *pBitOffset, OMX_S16 *pDst, OMX_INT QP, OMX_INT
      shortVideoHeader);
```

#### Description

Decodes the INTER block coefficients. This function performs inverse quantization, inverse zigzag positioning, and IDCT (with appropriate clipping on each step) on the coefficients. The results (residuals) are placed in a contiguous array of 64 elements.

For INTER block, the output buffer holds the residuals for further reconstruction.

#### Input Arguments

- `ppBitStream` – pointer to the pointer to the current byte in the bit stream buffer. There is no boundary check for the bit stream buffer.
- `pBitOffset` – pointer to the bit position in the byte pointed to by `*ppBitStream`. `*pBitOffset` is valid within [0-7]
- `QP` – quantization parameter
- `shortVideoHeader` – binary flag indicating presence of `short_video_header`; `shortVideoHeader==1` selects linear intra DC mode, and `shortVideoHeader==0` selects non-linear intra DC mode.

#### Output Arguments

- `ppBitStream` – `*ppBitStream` is updated after the block is decoded, so that it points to the current byte in the bit stream buffer
- `pBitOffset` – `*pBitOffset` is updated so that it points to the current bit position in the byte pointed by `*ppBitStream`
- `pDst` – pointer to the decoded residual buffer (a contiguous array of 64 elements of `OMX_S16` data type); must be aligned on a 16-byte boundary.

## Returns

- `OMX_Sts_NoErr` – no error
- `OMX_Sts_BadArgErr` – bad arguments
  - At least one of the following pointers is Null: `ppBitStream`, `*ppBitStream`, `pBitOffset`, `pDst`
  - At least one of the following is true:
    - `*pBitOffset` exceeds `[0,7]`, `QP <= 0`.
    - `pDst` is not 16-byte aligned
- `OMX_Sts_Err` – status error.

Refer to `OMX_Sts_Err` of “DecodeVLCZigzag\_Inter”.

### 6.2.5.4.3 PredictReconCoefIntra

#### Prototype

```
OMXResult omxVCM4P2_PredictReconCoefIntra(OMX_S16 *pSrcDst, OMX_S16
    *pPredBufRow, OMX_S16 *pPredBufCol, OMX_INT curQP, OMX_INT predQP,
    OMX_INT predDir, OMX_INT ACPredFlag, OMXVCM4P2VideoComponent videoComp);
```

#### Description

Performs adaptive DC/AC coefficient prediction for an intra block. Prior to the function call, prediction direction (`predDir`) should be selected as specified in [ISO14496-2], subclause 7.4.3.1.

#### Input Arguments

- `pSrcDst` – pointer to the coefficient buffer which contains the quantized coefficient residuals (PQF) of the current block; must be aligned on a 4-byte boundary. The output coefficients are saturated to the range `[-2048, 2047]`.
- `pPredBufRow` – pointer to the coefficient row buffer; must be aligned on a 4-byte boundary.
- `pPredBufCol` – pointer to the coefficient column buffer; must be aligned on a 4-byte boundary.
- `curQP` – quantization parameter of the current block. `curQP` may equal to `predQP` especially when the current block and the predictor block are in the same macroblock.
- `predQP` – quantization parameter of the predictor block
- `predDir` – indicates the prediction direction which takes one of the following values:
  - `OMX_VC_HORIZONTAL` – predict horizontally
  - `OMX_VC_VERTICAL` – predict vertically
- `ACPredFlag` – a flag indicating if AC prediction should be performed. It is equal to `ac_pred_flag` in the bit stream syntax of MPEG-4
- `videoComp` – video component type (luminance or chrominance) of the current block

#### Output Arguments

- `pSrcDst` – pointer to the coefficient buffer which contains the quantized coefficients (QF) of the current block
- `pPredBufRow` – pointer to the updated coefficient row buffer
- `pPredBufCol` – pointer to the updated coefficient column buffer



**Note:** Buffer update: Update the AC prediction buffer (both row and column buffer).

---

## Returns

- OMX\_Sts\_NoErr – no error
- OMX\_Sts\_BadArgErr – bad arguments
  - At least one of the pointers is NULL: pSrcDst, pPredBufRow, or pPredBufCol.  
or  
At least one the following cases: curQP <= 0, predQP <= 0, curQP >31, predQP > 31, preDir exceeds [1,2].  
or
  - At least one of the pointers pSrcDst, pPredBufRow, or pPredBufCol is not 4-byte aligned.

## 6.2.5.5 Motion Compensation

### 6.2.5.5.1 MCRConBlock

#### Prototype

```
OMXResult omxVCM4P2_MCRConBlock (const OMX_U8 *pSrc, OMX_INT srcStep,  
    const OMX_S16 *pSrcResidue, OMX_U8 *pDst, OMX_INT dstStep, OMX_INT  
    predictType, OMX_INT rndVal);
```

#### Description

Performs motion compensation prediction for an 8x8 block using interpolation described in [ISO14496-2], subclause 7.6.2.

#### Input Arguments

- pSrc – pointer to the block in the reference plane.
- srcStep – distance between the start of consecutive lines in the reference plane, in bytes; must be a multiple of 8.
- dstStep – distance between the start of consecutive lines in the destination plane, in bytes; must be a multiple of 8.
- pSrcResidue – pointer to a buffer containing the 16-bit prediction residuals; must be 16-byte aligned. If the pointer is NULL, then no prediction is done, only motion compensation, i.e., the block is moved with interpolation.
- predictType – bilinear interpolation type, as defined in section 6.2.1.2.
- rndVal – rounding control parameter: 0 – disabled; 1 - enabled.

#### Output Arguments

- pDst – pointer to the destination buffer; must be 8-byte aligned. If prediction residuals are added then output intensities are clipped to the range [0,255].

## Returns

- `OMX_Sts_NoErr` – no error
- `OMX_Sts_BadArgErr` – bad arguments; returned under any of the following conditions:
  - `pDst` is not 8-byte aligned.
  - `pSrcResidue` is not 16-byte aligned.
  - one or more of the following pointers is `NULL`: `pSrc` or `pDst`.
  - either `srcStep` or `dstStep` is not a multiple of 8.
  - invalid type specified for the parameter `predictType`.
  - the parameter `rndVal` is not equal either to 0 or 1.

## Reference

[ISO14496-2], subclause 7.6.2.

## 6.2.6 Limitations

The encoder and decoder APIs defined on the `omxVCM4P2` sub-domain in the foregoing sections (6.2.1-6.2.5) are compatible with data partitioning, but `omxVCM4P2` does not currently provide primitives that support RVLC.

## 6.3 MPEG-4 Part 10 (H.264) Sub-Domain (omxVCM4P10)

This section defines the `omxVCM4P10` sub-domain, which includes data structures and functions that could be used to construct an H.264 baseline profile encoder or decoder.

### 6.3.1 Data Structures and Enumerators

#### 6.3.1.1 Intra 16x16 Prediction Modes

A data type that enumerates `intra_16x16` macroblock prediction modes is defined as follows:

```
typedef enum {
    OMX_VC_16X16_VERT = 0,          /** Intra_16x16_Vertical */
    OMX_VC_16X16_HOR = 1,          /** Intra_16x16_Horizontal */
    OMX_VC_16X16_DC = 2,           /** Intra_16x16_DC */
    OMX_VC_16X16_PLANE = 3         /** Intra_16x16_Plane */
} OMXVCM4P10Intra16x16PredMode;
```

#### 6.3.1.2 Intra 4x4 Prediction Modes

A data type that enumerates `intra_4x4` macroblock prediction modes is defined as follows:

```
typedef enum
{
    OMX_VC_4X4_VERT = 0,           /** Intra_4x4_Vertical */
```



```

    OMX_VC_4X4_HOR   = 1,          /** Intra_4x4_Horizontal */
    OMX_VC_4X4_DC    = 2,          /** Intra_4x4_DC */
    OMX_VC_4X4_DIAG_DL = 3,       /** Intra_4x4_Diagonal_Down_Left */
    OMX_VC_4X4_DIAG_DR = 4,       /** Intra_4x4_Diagonal_Down_Right */
    OMX_VC_4X4_VR    = 5,          /** Intra_4x4_Vertical_Right */
    OMX_VC_4X4_HD    = 6,          /** Intra_4x4_Horizontal_Down */
    OMX_VC_4X4_VL    = 7,          /** Intra_4x4_Vertical_Left */
    OMX_VC_4X4_HU    = 8           /** Intra_4x4_Horizontal_Up */
} OMXVCM4P10Intra4x4PredMode;

```

### 6.3.1.3 Chroma Prediction Modes

A data type that enumerates intra chroma prediction modes is defined as follows:

```

typedef enum
{
    OMX_VC_CHROMA_DC = 0,          /** Intra_Chroma_DC */
    OMX_VC_CHROMA_HOR = 1,        /** Intra_Chroma_Horizontal */
    OMX_VC_CHROMA_VERT = 2,       /** Intra_Chroma_Vertical */
    OMX_VC_CHROMA_PLANE = 3       /** Intra_Chroma_Plane */
} OMXVCM4P10IntraChromaPredMode;

```

### 6.3.1.4 Motion Estimation Modes

A data type that enumerates H.264 motion estimation modes is defined as follows:

```

typedef enum {
    OMX_VC_M4P10_FAST_SEARCH = 0,    /** Fast motion search */
    OMX_VC_M4P10_FULL_SEARCH = 1     /** Full motion search */
} OMXVCM4P10MEMode;

```

### 6.3.1.5 Macroblock Types

A data type that enumerates H.264 macroblock types is defined as follows:

```

typedef enum {
    OMX_VC_P_16x16      = 0,        /* defined by [ISO14496-10] */
    OMX_VC_P_16x8       = 1,
    OMX_VC_P_8x16       = 2,
    OMX_VC_P_8x8        = 3,
    OMX_VC_PREF0_8x8    = 4,
    OMX_VC_INTER_SKIP   = 5,
    OMX_VC_INTRA_4x4    = 8,
    OMX_VC_INTRA_16x16  = 9,

```

```

    OMX_VC_INTRA_PCM        = 10
} OMXVCM4P10MacroblockType;

```

### 6.3.1.6 Sub-Macroblock Types

A data type that enumerates H.264 sub-macroblock types is defined as follows:

```

typedef enum {
    OMX_VC_SUB_P_8x8        = 0,    /* defined by [ISO14496-10] */
    OMX_VC_SUB_P_8x4        = 1,
    OMX_VC_SUB_P_4x8        = 2,
    OMX_VC_SUB_P_4x4        = 3
} OMXVCM4P10SubMacroblockType;

```

### 6.3.1.7 Variable Length Coding (VLC) Information

```

typedef struct {
    OMX_U8      uTrailing_Ones;      /* Trailing ones; 3 at most */
    OMX_U8      uTrailing_One_Signs; /* Trailing ones signal */
    OMX_U8      uNumCoeffs;          /* Total number of non-zero coeffs,
                                     including trailing ones */
    OMX_U8      uTotalZeros;         /* Total number of zero coeffs */
    OMX_S16     iLevels[16];         /* Levels of non-zero coeffs, in
                                     reverse zig-zag order */
    OMX_U8      uRuns[16];           /* Runs for levels and trailing
                                     ones, in reverse zig-zag order */
} OMXVCM4P10VLCInfo;

```

The field `uTrailing_One_Signs` is formatted as follows: Bit0 indicates the sign of the last trailing one, Bit1 indicates the sign of the 2<sup>nd</sup>-to-last trailing one, and so on. As specified in [ISO14496-2], up to 3 trailing ones are allowed, and trailing ones are ordered in inverse zig-zag scan order.

*Example:* `uTrailing_Ones`

*Given* 0 3 -1 0

```

    0 -1 1 0
    1 0 0 0
    0 0 0 0

```

*The trailing ones are [1, -1, -1], the signs are [+/-/-], and therefore `uTrailing_One_Signs` will contain the value 0b 0000 0011*



*Note: uNumCoeffs and uTotalZeros are not redundant because this structure covers blocks with 4, 15 and 16 possible coded coefficients.*

---

### 6.3.1.8 Macroblock Information

```
typedef struct {
    OMX_S32          sliceId;          /* slice number */
    OMXVCM4P10MacroblockType  mbType; /* MB type */
    OMXVCM4P10SubMacroblockType subMBType[4]; /* sub-block type */
    OMX_S32          qpY;              /* qp for luma */
    OMX_S32          qpC;              /* qp for chroma */
    OMX_U32          cbpY;             /* CBP Luma */
    OMX_U32          cbpC;             /* CBP Chroma */
    OMXVCMotionVector pMV0[4][4];     /* motion vector, represented
                                         using 1/4-pel units,
                                         pMV0[blocky][blockx]
                                         (blocky = 0~3, blockx = 0~3) */
    OMXVCMotionVector pMVPred[4][4]; /* motion vector prediction,
                                         Represented using 1/4-pel
                                         units, pMVPred[blocky][blockx]
                                         (blocky = 0~3, blockx = 0~3) */
    OMX_U8           pRefL0Idx[4];     /* reference picture indices */
    OMXVCM4P10Intra16x16PredMode Intra16x16PredMode; /* best intra 16x16
                                                         prediction mode */
    OMXVCM4P10Intra4x4PredMode  pIntra4x4PredMode[16]; /* best intra 4x4
                                                         prediction mode
                                                         for each block,
                                                         pMV0 indexed as
                                                         above */
} OMXVCM4P10MBInfo, *OMXVCM4P10MBInfoPtr;
```

### 6.3.1.9 Motion Estimation Parameters

```
typedef struct
{
    OMX_S32 blockSplitEnable8x8; /* enables 16x8, 8x16, 8x8 */
    OMX_S32 blockSplitEnable4x4; /* enable splitting of 8x4, 4x8,
                                   4x4 blocks */
    OMX_S32 halfSearchEnable;
```



**Figure 6-6: Coefficient-Position Pair Buffer Definition**

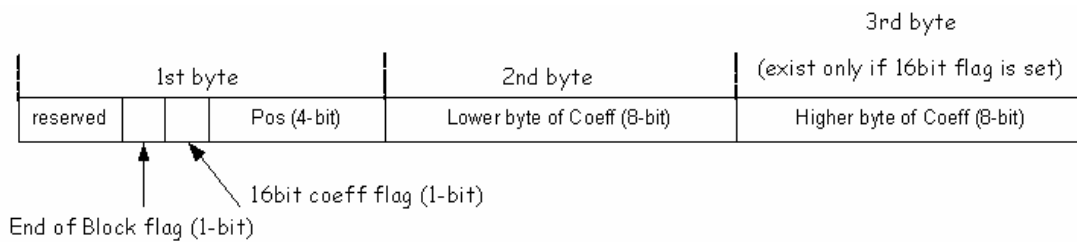

### 6.3.3 Encoder/Decoder Functions

This section defines functions that could be used to construct an H.264 baseline profile encoder or an H.264 baseline profile decoder.

#### 6.3.3.1 Intra Prediction

##### 6.3.3.1.1 PredictIntra\_4x4

###### Prototype

```
OMXResult omxVCM4P10_PredictIntra_4x4(const OMX_U8 *pSrcLeft, const OMX_U8
    *pSrcAbove, const OMX_U8 *pSrcAboveLeft, OMX_U8 *pDst, OMX_INT leftStep,
    OMX_INT dstStep, OMXVCM4P10Intra4x4PredMode predMode, OMX_S32
    availability);
```

###### Description

Perform Intra\_4x4 prediction for luma samples. If the upper-right block is not available, then duplication work should be handled inside the function. Users need not define them outside.

###### Input Arguments

- `pSrcLeft` - Pointer to the buffer of 4 left pixels:  $p[x, y]$  ( $x = -1, y = 0..3$ )
- `pSrcAbove` - Pointer to the buffer of 8 above pixels:  $p[x, y]$  ( $x = 0..7, y = -1$ ); must be aligned on a 4-byte boundary.
- `pSrcAboveLeft` - Pointer to the above left pixels:  $p[x, y]$  ( $x = -1, y = -1$ )
- `leftStep` - Step of left pixel buffer; must be a multiple of 4.
- `dstStep` - Step of the destination buffer; must be a multiple of 4.
- `predMode` - Intra\_4x4 prediction mode.
- `availability` - Neighboring 4x4 block availability flag, refer to “Neighboring Macroblock Availability”.

###### Output Arguments

- `pDst` - Pointer to the destination buffer; must be aligned on a 4-byte boundary.

## Returns

If the function runs without error, it returns `OMX_Sts_NoErr`.

If one of the following cases occurs, the function returns `OMX_Sts_BadArgErr`:

- `pDst` is NULL.
- `dstStep < 4`, or `dstStep` is not a multiple of 4.
- `leftStep` is not a multiple of 4.
- `predMode` is not in the valid range of enumeration `OMXVCM4P10Intra4x4PredMode`.
- `predMode` is `OMX_VC_4x4_VERT`, but availability doesn't set `OMX_VC_UPPER` indicating `p[x,-1]` (`x = 0..3`) is not available.
- `predMode` is `OMX_VC_4x4_HOR`, but availability doesn't set `OMX_VC_LEFT` indicating `p[-1,y]` (`y = 0..3`) is not available.
- `predMode` is `OMX_VC_4x4_DIAG_DL`, but availability doesn't set `OMX_VC_UPPER` indicating `p[x,-1]` (`x = 0..3`) is not available.
- `predMode` is `OMX_VC_4x4_DIAG_DR`, but availability doesn't set `OMX_VC_UPPER_LEFT` or `OMX_VC_UPPER` or `OMX_VC_LEFT` indicating `p[x,-1]` (`x = 0..3`), or `p[-1,y]` (`y = 0..3`) or `p[-1,-1]` is not available.
- `predMode` is `OMX_VC_4x4_VR`, but availability doesn't set `OMX_VC_UPPER_LEFT` or `OMX_VC_UPPER` or `OMX_VC_LEFT` indicating `p[x,-1]` (`x = 0..3`), or `p[-1,y]` (`y = 0..3`) or `p[-1,-1]` is not available.
- `predMode` is `OMX_VC_4x4_HD`, but availability doesn't set `OMX_VC_UPPER_LEFT` or `OMX_VC_UPPER` or `OMX_VC_LEFT` indicating `p[x,-1]` (`x = 0..3`), or `p[-1,y]` (`y = 0..3`) or `p[-1,-1]` is not available.
- `predMode` is `OMX_VC_4x4_VL`, but availability doesn't set `OMX_VC_UPPER` indicating `p[x,-1]` (`x = 0..3`) is not available.
- `predMode` is `OMX_VC_4x4_HU`, but availability doesn't set `OMX_VC_LEFT` indicating `p[-1,y]` (`y = 0..3`) is not available.
- availability sets `OMX_VC_UPPER`, but `pSrcAbove` is NULL.
- availability sets `OMX_VC_LEFT`, but `pSrcLeft` is NULL.
- availability sets `OMX_VC_UPPER_LEFT`, but `pSrcAboveLeft` is NULL.
- either `pSrcAbove` or `pDst` is not aligned on a 4-byte boundary.



*Note: `pSrcAbove`, `pSrcAbove`, `pSrcAboveLeft` may be invalid pointers if they are not used by intra prediction as implied in `predMode`.*

---

### 6.3.3.1.2 PredictIntra\_16x16

#### Prototype

```
OMXResult omxVCM4P10_PredictIntra_16x16(const OMX_U8 *pSrcLeft, const OMX_U8
    *pSrcAbove, const OMX_U8 *pSrcAboveLeft, OMX_U8 *pDst, OMX_INT leftStep,
    OMX_INT dstStep, OMXVCM4P10Intra16x16PredMode predMode, OMX_S32
    availability);
```

## Description

Perform Intra\_16x16 prediction for luma samples. If the upper-right block is not available, then duplication work should be handled inside the function. Users need not define them outside.

## Input Arguments

- `pSrcLeft` - Pointer to the buffer of 16 left pixels:  $p[x, y]$  ( $x = -1, y = 0..15$ )
- `pSrcAbove` - Pointer to the buffer of 16 above pixels:  $p[x, y]$  ( $x = 0..15, y = -1$ ); must be aligned on a 16-byte boundary.
- `pSrcAboveLeft` - Pointer to the above left pixels:  $p[x, y]$  ( $x = -1, y = -1$ )
- `leftStep` - Step of left pixel buffer; must be a multiple of 16.
- `dstStep` - Step of the destination buffer; must be a multiple of 16.
- `predMode` - Intra\_16x16 prediction mode, please refer to section 3.4.1.
- `availability` - Neighboring 16x16 MB availability flag. Refer to section 3.4.4.

## Output Arguments

- `pDst` - Pointer to the destination buffer; must be aligned on a 16-byte boundary.

## Returns

If the function runs without error, it returns `OMX_Sts_NoErr`.

If one of the following cases occurs, the function returns `OMX_Sts_BadArgErr`:

- `pDst` is NULL.
- `dstStep < 16`. or `dstStep` is not a multiple of 16.
- `leftStep` is not a multiple of 16.
- `predMode` is not in the valid range of enumeration `OMXVC4P10Intra16x16PredMode`
- `predMode` is `OMX_VC_16X16_VERT`, but `availability` doesn't set `OMX_VC_UPPER` indicating  $p[x, -1]$  ( $x = 0..15$ ) is not available.
- `predMode` is `OMX_VC_16X16_HOR`, but `availability` doesn't set `OMX_VC_LEFT` indicating  $p[-1, y]$  ( $y = 0..15$ ) is not available.
- `predMode` is `OMX_VC_16X16_PLANE`, but `availability` doesn't set `OMX_VC_UPPER_LEFT` or `OMX_VC_UPPER` or `OMX_VC_LEFT` indicating  $p[x, -1]$  ( $x = 0..15$ ), or  $p[-1, y]$  ( $y = 0..15$ ), or  $p[-1, -1]$  is not available.
- `availability` sets `OMX_VC_UPPER`, but `pSrcAbove` is NULL.
- `availability` sets `OMX_VC_LEFT`, but `pSrcLeft` is NULL.
- `availability` sets `OMX_VC_UPPER_LEFT`, but `pSrcAboveLeft` is NULL.
- either `pSrcAbove` or `pDst` is not aligned on a 16-byte boundary.



**Note:** *`pSrcAbove`, `pSrcAbove`, `pSrcAboveLeft` may be invalid pointers if they are not used by intra prediction implied in `predMode`.*

---



**Note:** *OMX\_VC\_UPPER\_RIGHT* is not used in *intra\_16x16* luma prediction.

---

### 6.3.3.1.3 PredictIntraChroma\_8x8

#### Prototype

```
OMXResult omxVCM4P10_PredictIntraChroma_8x8(const OMX_U8 *pSrcLeft, const
      OMX_U8 *pSrcAbove, const OMX_U8 *pSrcAboveLeft, OMX_U8 *pDst, OMX_INT
      leftStep, OMX_INT dstStep, OMXVCM4P10IntraChromaPredMode predMode,
      OMX_S32 availability);
```

#### Description

Performs intra prediction for chroma samples.

#### Input Arguments

- `pSrcLeft` - Pointer to the buffer of 8 left pixels:  $p[x, y]$  ( $x = -1, y = 0..7$ ).
- `pSrcAbove` - Pointer to the buffer of 8 above pixels:  $p[x, y]$  ( $x = 0..7, y = -1$ ); must be aligned on an 8-byte boundary.
- `pSrcAboveLeft` - Pointer to the above left pixels:  $p[x, y]$  ( $x = -1, y = -1$ )
- `leftStep` - Step of left pixel buffer; must be a multiple of 8.
- `dstStep` - Step of the destination buffer; must be a multiple of 8.
- `predMode` - Intra chroma prediction mode, please refer to section 3.4.3.
- `availability` - Neighboring chroma block availability flag, please refer to “Neighboring Macroblock Availability”.

#### Output Arguments

- `pDst` - Pointer to the destination buffer; must be aligned on an 8-byte boundary.

#### Returns

If the function runs without error, it returns `OMX_Sts_NoErr`.

If any of the following cases occurs, the function returns `OMX_Sts_BadArgErr`:

- `pDst` is NULL.
- `dstStep` < 8 or `dstStep` is not a multiple of 8.
- `leftStep` is not a multiple of 8.
- `predMode` is not in the valid range of enumeration `OMXVCM4P10IntraChromaPredMode`.
- `predMode` is `OMX_VC_CHROMA_VERT`, but availability doesn't set `OMX_VC_UPPER` indicating  $p[x, -1]$  ( $x = 0..7$ ) is not available.
- `predMode` is `OMX_VC_CHROMA_HOR`, but availability doesn't set `OMX_VC_LEFT` indicating  $p[-1, y]$  ( $y = 0..7$ ) is not available.
- `predMode` is `OMX_VC_CHROMA_PLANE`, but availability doesn't set `OMX_VC_UPPER_LEFT` or `OMX_VC_UPPER` or `OMX_VC_LEFT` indicating  $p[x, -1]$  ( $x = 0..7$ ), or  $p[-1, y]$  ( $y = 0..7$ ), or  $p[-1, -1]$  is not available.



- availability sets `OMX_VC_UPPER`, but `pSrcAbove` is `NULL`.
- availability sets `OMX_VC_LEFT`, but `pSrcLeft` is `NULL`.
- availability sets `OMX_VC_UPPER_LEFT`, but `pSrcAboveLeft` is `NULL`.
- either `pSrcAbove` or `pDst` is not aligned on a 8-byte boundary.



*Note: `pSrcAbove`, `pSrcAbove`, `pSrcAboveLeft` may be invalid pointer if they are not used by intra prediction implied in `predMode`.*

---



*Note: `OMX_VC_UPPER_RIGHT` is not used in intra chroma prediction.*

---

## 6.3.3.2 Interpolation

### 6.3.3.2.1 InterpolateLuma

#### Prototype

```
OMXResult omxVCM4P10_InterpolateLuma(const OMX_U8 *pSrc, OMX_S32 srcStep,
    OMX_U8 *pDst, OMX_S32 dstStep, OMX_S32 dx, OMX_S32 dy, OMXSize roi);
```

#### Description

Performs quarter-pixel interpolation for inter luma MB. It is assumed that the frame is already padded when calling this function.

#### Input Arguments

- `pSrc` - Pointer to the source reference frame buffer
- `srcStep` - reference frame step, in bytes; must be a multiple of `roi.width`
- `dstStep` - destination frame step, in bytes; must be a multiple of `roi.width`
- `dx` - Fractional part of horizontal motion vector component in 1/4 pixel unit; valid in the range [0,3]
- `dy` - Fractional part of vertical motion vector y component in 1/4 pixel unit; valid in the range [0,3]
- `roi` - Dimension of the interpolation region; the parameters `roi.width` and `roi.height` must be equal to either 4, 8, or 16.

#### Output Arguments

- `pDst` - Pointer to the destination frame buffer
  - if `roi.width==4`, 4-byte alignment required
  - if `roi.width==8`, 8-byte alignment required
  - if `roi.width==16`, 16-byte alignment required

## Returns

If the function runs without error, it returns `OMX_Sts_NoErr`.

If one of the following cases occurs, the function returns `OMX_Sts_BadArgErr`:

- `pSrc` or `pDst` is NULL.
- `srcStep` or `dstStep` < `roi.width`.
- `dx` or `dy` is out of range [0,3].
- `roi.width` or `roi.height` is out of range {4, 8, 16}.
- `roi.width` is equal to 4, but `pDst` is not 4 byte aligned.
- `roi.width` is equal to 8 or 16, but `pDst` is not 8 byte aligned.
- `srcStep` or `dstStep` is not a multiple of 8.

### 6.3.3.2.2 InterpolateChroma

#### Prototype

```
OMXResult omxVCM4P10_InterpolateChroma (const OMX_U8 *pSrc, OMX_S32 srcStep,  
    OMX_U8 *pDst, OMX_S32 dstStep, OMX_S32 dx, OMX_S32 dy, OMXSize roi);
```

#### Description

Performs 1/8-pixel interpolation for inter chroma MB.

#### Input Arguments

- `pSrc` - Pointer to the source reference frame buffer
- `srcStep` - Reference frame step in bytes
- `dstStep` - Destination frame step in bytes; must be a multiple of `roi.width`.
- `dx` - Fractional part of horizontal motion vector component in 1/8 pixel unit; valid in the range [0,7]
- `dy` - Fractional part of vertical motion vector component in 1/8 pixel unit; valid in the range [0,7]
- `roi` - Dimension of the interpolation region; the parameters `roi.width` and `roi.height` must be equal to either 2, 4, or 8.

#### Output Arguments

- `pDst` - Pointer to the destination frame buffer
  - if `roi.width==2`, 2-byte alignment required
  - if `roi.width==4`, 4-byte alignment required
  - if `roi.width==8`, 8-byte alignment required

## Returns

If the function runs without error, it returns `OMX_Sts_NoErr`.

If one of the following cases occurs, the function returns `OMX_Sts_BadArgErr`:

- `pSrc` or `pDst` is NULL.
- `srcStep` or `dstStep` < 8.
- `dx` or `dy` is out of range [0-7].

- `roi.width` or `roi.height` is out of range {2,4,8}.
- `roi.width` is equal to 2, but `pDst` is not 2-byte aligned.
- `roi.width` is equal to 4, but `pDst` is not 4-byte aligned.
- `roi.width` is equal to 8, but `pDst` is not 8 byte aligned.
- `srcStep` or `dstStep` is not a multiple of 8.

### 6.3.3.3 Deblocking

#### 6.3.3.3.1 FilterDeblockingLuma\_VerEdge\_I

##### Prototype

```
OMXResult omxVCM4P10_FilterDeblockingLuma_VerEdge_I(OMX_U8 *pSrcDst, OMX_S32
    srcdstStep, const OMX_U8 *pAlpha, const OMX_U8 *pBeta, const OMX_U8
    *pThresholds, const OMX_U8 *pBS);
```

##### Description

Performs in-place deblock filtering on four vertical edges of the luma macroblock (16x16).

##### Input Arguments

- `pSrcDst` - Pointer to the input macroblock; must be 16-byte aligned.
- `srcdstStep` - Step of the arrays; must be a multiple of 16.
- `pAlpha` - Array of size 2 of alpha thresholds (the first item is the alpha threshold for the external vertical edge, and the second item is for the internal vertical edge); per [ISO14496-10] alpha values must be in the range [0,255].
- `pBeta` - Array of size 2 of beta thresholds (the first item is the beta threshold for the external vertical edge, and the second item is for the internal vertical edge); per [ISO14496-10] beta values must be in the range [0,18].
- `pThresholds` - Array of size 16 of Thresholds (TC0) (values for the left edge of each 4x4 block, arranged in vertical block order); must be aligned on a 4-byte boundary.. Per [ISO14496-10] values must be in the range [0,25].
- `pBS` - Array of size 16 of BS parameters (arranged in vertical block order); valid in the range [0,4] with the following restrictions: i) `pBS[i] == 4` may occur only for  $0 \leq i \leq 3$ , ii) `pBS[i] == 4` if and only if `pBS[i^3] == 4`. Must be 4-byte aligned.

##### Output Arguments

- `pSrcDst` - Pointer to filtered output macroblock.

##### Returns

If the function runs without error, it returns `OMX_Sts_NoErr`.

If one of the following cases occurs, the function returns `OMX_Sts_BadArgErr`:

- Either of the pointers in `pSrcDst`, `pAlpha`, `pBeta`, `pThresholds`, or `pBS` is NULL.
- Either `pThresholds` or `pBS` is not aligned on a 4-byte boundary.
- `pSrcDst` is not 16-byte aligned.

- `srcdstStep` is not a multiple of 16.
- `pAlpha[0]` and/or `pAlpha[1]` is outside the range [0,255].
- `pBeta[0]` and/or `pBeta[1]` is outside the range [0,18].
- One or more entries in the table `pThresholds[0..15]` is outside of the range [0,25].
- `pBS` is out of range, i.e., one of the following conditions is true: `pBS[i]<0`, `pBS[i]>4`, `pBS[i]==4` for  $i>=4$ , or  $(pBS[i]==4 \ \&\& \ pBS[i^3]!=4)$  for  $0<=i<=3$ .

### 6.3.3.3.2 FilterDeblockingLuma\_HorEdge\_I

#### Prototype

```
OMXResult omxVCM4P10_FilterDeblockingLuma_HorEdge_I(OMX_U8 *pSrcDst, OMX_S32
    srcdstStep, const OMX_U8 *pAlpha, const OMX_U8 *pBeta, const OMX_U8
    *pThresholds, const OMX_U8 *pBS);
```

#### Description

Performs in-place deblock filtering on four horizontal edges of the luma macroblock (16x16).

#### Input Arguments

- `pSrcDst` - pointer to the input macroblock; must be 16-byte aligned.
- `srcdstStep` - step of the arrays; must be a multiple of 16.
- `pAlpha` - array of size 2 of alpha thresholds (the first item is the alpha threshold for the external vertical edge, and the second item is for the internal horizontal edge); per [ISO14496-10] alpha values must be in the range [0,255].
- `pBeta` - array of size 2 of beta thresholds (the first item is the beta threshold for the external horizontal edge, and the second item is for the internal horizontal edge). Per [ISO14496-10] beta values must be in the range [0,18].
- `pThresholds` - array of size 16 containing thresholds, TC0, for the top horizontal edge of each 4x4 block, arranged in horizontal block order; must be aligned on a 4-byte boundary. Per [ISO14496-10] values must be in the range [0,25].
- `pBS` - array of size 16 of BS parameters (arranged in horizontal block order); valid in the range [0,4] with the following restrictions: i) `pBS[i]==4` may occur only for  $0<=i<=3$ , ii) `pBS[i]==4` if and only if `pBS[i^3]==4`. Must be 4-byte aligned.

#### Output Arguments

- `pSrcDst` - Pointer to filtered output macroblock.

#### Returns

- If the function runs without error, it returns `OMX_Sts_NoErr`.
- If one of the following cases occurs, the function returns `OMX_Sts_BadArgErr`:
  - one or more of the following pointers is NULL: `pSrcDst`, `pAlpha`, `pBeta`, `pThresholds`, or `pBS`.
  - either `pThresholds` or `pBS` is not aligned on a 4-byte boundary.
  - `pSrcDst` is not 16-byte aligned.
  - `srcdstStep` is not a multiple of 16.

- pAlpha[0] and/or pAlpha[1] is outside the range [0,255].
- pBeta[0] and/or pBeta[1] is outside the range [0,18].
- One or more entries in the table pThresholds[0..15] is outside of the range [0,25].
- pBS is out of range, i.e., one of the following conditions is true: pBS[i]<0, pBS[i]>4, pBS[i]==4 for i>=4, or (pBS[i]==4 && pBS[i^3]!=4) for 0<=i<=3.

### 6.3.3.3.3 FilterDeblockingChroma\_VerEdge\_I

#### Prototype

```
OMXResult omxVCM4P10_FilterDeblockingChroma_VerEdge_I(OMX_U8 *pSrcDst,
    OMX_S32 srcdstStep, const OMX_U8 *pAlpha, const OMX_U8 *pBeta, const
    OMX_U8 *pThresholds, const OMX_U8 *pBS);
```

#### Description

Performs in-place deblock filtering on four vertical edges of the chroma macroblock (8x8).

#### Input Arguments

- pSrcDst - Pointer to the input macroblock; must be 8-byte aligned.
- srcdstStep - Step of the arrays; must be a multiple of 8.
- pAlpha - Array of size 2 of alpha thresholds (the first item is alpha threshold for external vertical edge, and the second item is for internal vertical edge); per [ISO14496-10] alpha values must be in the range [0,255].
- pBeta - Array of size 2 of beta thresholds (the first item is the beta threshold for the external vertical edge, and the second item is for the internal vertical edge); per [ISO14496-10] beta values must be in the range [0,18].
- pThresholds - Array of size 8 containing thresholds, TC0, for the left vertical edge of each 4x2 chroma block, arranged in vertical block order; must be aligned on a 4-byte boundary. Per [ISO14496-10] values must be in the range [0,25].
- pBS - Array of size 16 of BS parameters (values for each 2x2 chroma block, arranged in vertical block order). This parameter is the same as the pBS parameter passed into FilterDeblockLuma\_VerEdge; valid in the range [0,4] with the following restrictions: i) pBS[i]==4 may occur only for 0<=i<=3, ii) pBS[i]==4 if and only if pBS[i^3]==4. Must be 4-byte aligned.

#### Output Arguments

- pSrcDst - Pointer to filtered output macroblock.

#### Returns

- If the function runs without error, it returns OMX\_Sts\_NoErr.
- If one of the following cases occurs, the function returns OMX\_Sts\_BadArgErr:
  - one or more of the following pointers is NULL: pSrcDst, pAlpha, pBeta, pThresholds, or pBS.
  - pSrcDst is not 8-byte aligned.
  - srcdstStep is not a multiple of 8.

- pThresholds is not 4-byte aligned.
- pAlpha[0] and/or pAlpha[1] is outside the range [0,255].
- pBeta[0] and/or pBeta[1] is outside the range [0,18].
- One or more entries in the table pThresholds[0..7] is outside of the range [0,25].
- pBS is out of range, i.e., one of the following conditions is true: pBS[i]<0, pBS[i]>4, pBS[i]==4 for i>=4, or (pBS[i]==4 && pBS[i^3]!=4) for 0<=i<=3.
- pBS is not 4-byte aligned.

### 6.3.3.3.4 FilterDeblockingChroma\_HorEdge\_I

#### Prototype

```
OMXResult omxVCM4P10_FilterDeblockingChroma_HorEdge_I(OMX_U8 *pSrcDst,
    OMX_S32 srcdstStep, const OMX_U8 *pAlpha, const OMX_U8 *pBeta, const
    OMX_U8 *pThresholds, const OMX_U8 *pBS);
```

#### Description

Performs in-place deblock filtering on the horizontal edges of the chroma macroblock (8x8).

#### Input Arguments

- pSrcDst - pointer to the input macroblock; must be 8-byte aligned.
- srcdstStep - array step; must be a multiple of 8.
- pAlpha - array of size 2 containing alpha thresholds; the first element contains the threshold for the external horizontal edge, and the second element contains the threshold for internal horizontal edge. Per [ISO14496-10] alpha values must be in the range [0,255].
- pBeta - array of size 2 containing beta thresholds; the first element contains the threshold for the external horizontal edge, and the second element contains the threshold for the internal horizontal edge. Per [ISO14496-10] beta values must be in the range [0,18].
- pThresholds - array of size 8 containing thresholds, TC0, for the top horizontal edge of each 2x4 chroma block, arranged in horizontal block order; must be aligned on a 4-byte boundary. Per [ISO14496-10] values must be in the range [0,25].
- pBS - array of size 16 containing BS parameters for each 2x2 chroma block, arranged in horizontal block order; valid in the range [0,4] with the following restrictions: i) pBS[i]==4 may occur only for 0<=i<=3, ii) pBS[i]==4 if and only if pBS[i^3]==4. Must be 4-byte aligned.

#### Output Arguments

- pSrcDst - Pointer to filtered output macroblock.

#### Returns

- If the function runs without error, it returns OMX\_Sts\_NoErr.
- If one or more of the following conditions occurs, the function returns OMX\_Sts\_BadArgErr:
  - any of the following pointers is NULL: pSrcDst, pAlpha, pBeta, pThresholds, or pBS.
  - pSrcDst is not 8-byte aligned.
  - srcdstStep is not a multiple of 8.

- pThresholds is not 4-byte aligned.
- pAlpha[0] and/or pAlpha[1] is outside the range [0,255].
- pBeta[0] and/or pBeta[1] is outside the range [0,18].
- One or more entries in the table pThresholds[0..7] is outside of the range [0,25].
- pBS is out of range, i.e., one of the following conditions is true: pBS[i]<0, pBS[i]>4, pBS[i]==4 for i>=4, or (pBS[i]==4 && pBS[i^3]!=4) for 0<=i<=3.
- pBS is not 4-byte aligned.

### 6.3.3.3.5 DeblockLuma\_I

#### Prototype

```
OMXResult omxVCM4P10_DeblockLuma_I (OMX_U8 *pSrcDst, OMX_S32 srcdstStep,
    const OMX_U8 *pAlpha, const OMX_U8 *pBeta, const OMX_U8 *pThresholds,
    const OMX_U8 *pBS);
```

#### Description

This function performs in-place deblock filtering the horizontal and vertical edges of a luma macroblock (16x16).

#### Input Arguments

- pSrcDst - pointer to the input macroblock; must be 16-byte aligned.
- srcdstStep - image width; must be a multiple of 16.
- pAlpha - pointer to a 2x2 table of alpha thresholds, organized as follows: {external vertical edge, internal vertical edge, external horizontal edge, internal horizontal edge }. Per [ISO14496-10] alpha values must be in the range [0,255].
- pBeta - pointer to a 2x2 table of beta thresholds, organized as follows: {external vertical edge, internal vertical edge, external horizontal edge, internal horizontal edge }. Per [ISO14496-10] beta values must be in the range [0,18].
- pThresholds - pointer to a 16x2 table of threshold (TC0), organized as follows: {values for the left or above edge of each 4x4 block, arranged in vertical block order and then in horizontal block order}; must be aligned on a 4-byte boundary. Per [ISO14496-10] values must be in the range [0,25].
- pBS - pointer to a 16x2 table of BS parameters arranged in scan block order for vertical edges and then horizontal edges; valid in the range [0,4] with the following restrictions: i) pBS[i]==4 may occur only for 0<=i<=3, ii) pBS[i]==4 if and only if pBS[i^3]==4. Must be 4-byte aligned.

#### Output Arguments

- pSrcDst - pointer to filtered output macroblock.

#### Returns

- OMX\_Sts\_NoErr - no error
- OMX\_Sts\_BadArgErr - bad arguments
  - one or more of the following pointers is NULL: pSrcDst, pAlpha, pBeta, pThresholds or pBS.
  - pSrcDst is not 16-byte aligned.

- either `pThresholds` or `pBS` is not aligned on a 4-byte boundary.
- one or more entries in the table `pAlpha[0..3]` is outside the range [0,255].
- one or more entries in the table `pBeta[0..3]` is outside the range [0,18].
- one or more entries in the table `pThresholds[0..31]` is outside of the range [0,25].
- `pBS` is out of range, i.e., one of the following conditions is true: `pBS[i]<0`, `pBS[i]>4`, `pBS[i]==4` for `i>=4`, or `(pBS[i]==4 && pBS[i^3]!=4)` for `0<=i<=3`.
- `srcdstStep` is not a multiple of 16.

### 6.3.3.3.6 DeblockChroma\_I

#### Prototype

```
OMXResult omxVCM4P10_DeblockChroma_I(OMX_U8 *pSrcDst, OMX_S32 srcdstStep,
    const OMX_U8 *pAlpha, const OMX_U8 *pBeta, const OMX_U8 *pThresholds,
    const OMX_U8 *pBS);
```

#### Description

Performs in-place deblocking filtering on all edges of the chroma macroblock (16x16).

#### Input Arguments

- `pSrcDst` - pointer to the input macroblock; must be 8-byte aligned.
- `srcdstStep` - step of the arrays; must be a multiple of 8.
- `pAlpha` - pointer to a 2x2 array of alpha thresholds, organized as follows: {external vertical edge, internal vertical edge, external horizontal edge, internal horizontal edge }. Per [ISO14496-10] alpha values must be in the range [0,255].
- `pBeta` - pointer to a 2x2 array of Beta Thresholds, organized as follows: { external vertical edge, internal vertical edge, external horizontal edge, internal horizontal edge }. Per [ISO14496-10] beta values must be in the range [0,18].
- `pThresholds` - array of size 8x2 of Thresholds (TC0) (values for the left or above edge of each 4x2 or 2x4 block, arranged in vertical block order and then in horizontal block order); must be aligned on a 4-byte boundary. Per [ISO14496-10] values must be in the range [0,25].
- `pBS` - array of size 16x2 of BS parameters (arranged in scan block order for vertical edges and then horizontal edges); valid in the range [0,4] with the following restrictions: i) `pBS[i]==4` may occur only for `0<=i<=3`, ii) `pBS[i]==4` if and only if `pBS[i^3]==4`. Must be 4-byte aligned.

#### Output Arguments

- `pSrcDst` - pointer to filtered output macroblock.

#### Returns

- `OMX_Sts_NoErr` - no error
- `OMX_Sts_BadArgErr` - bad arguments
  - one or more of the following pointers is NULL: `pSrcDst`, `pAlpha`, `pBeta`, `pThresholds`, or `pBS`.
  - `pSrcDst` is not 8-byte aligned.



- either `pThresholds` or `pBS` is not 4-byte aligned.
- one or more entries in the table `pAlpha[0..3]` is outside the range `[0,255]`.
- one or more entries in the table `pBeta[0..3]` is outside the range `[0,18]`.
- one or more entries in the table `pThresholds[0..15]` is outside of the range `[0,25]`.
- `pBS` is out of range, i.e., one of the following conditions is true: `pBS[i]<0`, `pBS[i]>4`, `pBS[i]==4` for `i>=4`, or `(pBS[i]==4 && pBS[i^3]!=4)` for `0<=i<=3`.
- `srcdstStep` is not a multiple of 8.

## 6.3.4 Decoder Functions

This section describes functions that could be used to construct a baseline profile H.264 decoder.

### 6.3.4.1 CAVLC Decoding

#### 6.3.4.1.1 DecodeChromaDcCoeffsToPairCAVLC

##### Prototype

```
OMXResult omxVCM4P10_DecodeChromaDcCoeffsToPairCAVLC(const OMX_U8
**ppBitStream, OMX_S32*pOffset, OMX_U8 *pNumCoeff, OMX_U8
**ppPosCoefbuf);
```

##### Description

Performs CAVLC decoding and inverse raster scan for a 2x2 block of ChromaDCLevel. The decoded coefficients in the packed position-coefficient buffer are stored in reverse zig-zag order, i.e., the first buffer element contains the last non-zero position-coefficient pair of the block. Within each position-coefficient pair, the position entry indicates the raster-scan position of the coefficient, while the coefficient entry contains the coefficient value.

*Example:*

*A CAVLC Chroma buffer containing the following entries*

*24 -1*

*3 1*

*would be represented as follows*

*(3,1), (2,3), (1,-1), (0,24)*

##### Input Arguments

- `ppBitStream` - Double pointer to current byte in bit stream buffer
- `pOffset` - Pointer to current bit position in the byte pointed to by `*ppBitStream`; valid in the range `[0,7]`.

## Output Arguments

- `ppBitStream` - `*ppBitStream` is updated after each block is decoded
- `pOffset` - `*pOffset` is updated after each block is decoded
- `pNumCoeff` - Pointer to the number of nonzero coefficients in this block
- `ppPosCoefBuf` - Double pointer to destination residual coefficient-position pair buffer. Buffer position (`*ppPosCoefBuf`) is updated upon return, unless there are only zero coefficients in the currently decoded block. In this case the caller is expected to bypass the transform/dequantization of the empty blocks.

## Returns

The function returns `OMX_Sts_NoErr` if it runs without error.

The function returns `OMX_Sts_BadArgErr` if one or more of the following is true:

- `ppBitStream` or `pOffset` is NULL.
- `ppPosCoefBuf` or `pNumCoeff` is NULL.

The function returns `OMX_Sts_Err` if one of the following is true:

- an illegal code is encountered in the bitstream

### 6.3.4.1.2 DecodeCoeffsToPairCAVLC

#### Prototype

```
OMXResult omxVCM4P10_DecodeCoeffsToPairCAVLC(const OMX_U8 **ppBitStream,  
      OMX_S32 *pOffset, OMX_U8 *pNumCoeff, OMX_U8 **ppPosCoefbuf, OMX_INT  
      sVLCSelect, OMX_INT sMaxNumCoeff);
```

#### Description

Performs CAVLC decoding and inverse zigzag scan for 4x4 block of `Intra16x16DCLevel`, `Intra16x16ACLevel`, `LumaLevel`, and `ChromaACLevel`. Inverse field scan is not supported. The decoded coefficients in the packed position-coefficient buffer are stored in reverse zig-zag order, i.e., the first buffer element contains the last non-zero position-coefficient pair of the block. Within each position-coefficient pair, the position entry indicates the raster-scan position of the coefficient, while the coefficient entry contains the coefficient value.

*Example:*

*A CAVLC buffer containing the following entries*

```
24 -1 - -  
- - - -  
- - - -  
- 3 1 -
```

*would be represented as follows*

```
(14,1), (13,3), (1,-1), (0,24)
```

### Input arguments

- `ppBitStream` - Double pointer to current byte in bit stream buffer
- `pOffset` - Pointer to current bit position in the byte pointed to by `*ppBitStream`; valid in the range [0,7].
- `sMaxNumCoeff` - Maximum the number of non-zero coefficients in current block
- `sVLCSelect` - VLC table selector, obtained from the number of non-zero coefficients contained in the above and left 4x4 blocks. It is equivalent to the variable `nC` described in H.264 standard table 9-5, except its value can't be less than zero.

### Output Arguments

- `ppBitStream` - `*ppBitStream` is updated after each block is decoded. Buffer position (`*ppPosCoefBuf`) is updated upon return, unless there are only zero coefficients in the currently decoded block. In this case the caller is expected to bypass the transform/dequantization of the empty blocks.
- `pOffset` - `*pOffset` is updated after each block is decoded
- `pNumCoeff` - Pointer to the number of nonzero coefficients in this block
- `ppPosCoefBuf` - Double pointer to destination residual coefficient-position pair buffer

### Returns

The function returns `OMX_Sts_NoErr` if it runs without error.

The function returns `OMX_Sts_BadArgErr` if one or more of the following is true:

- `ppBitStream` or `pOffset` is NULL.
- `ppPosCoefBuf` or `pNumCoeff` is NULL.
- `sMaxNumCoeff` is not equal to either 15 or 16.
- `sVLCSelect` is less than 0.

The function returns `OMX_Sts_Err` if one of the following is true:

- an illegal code is encountered in the bitstream

## 6.3.4.2 Inverse Quantization/Transform/Add Residual

### 6.3.4.2.1 TransformDequantLumaDCFromPair

#### Prototype

```
OMXResult omxVCM4P10_TransformDequantLumaDCFromPair(const OMX_U8 **ppSrc,  
    OMX_S16 *pDst, OMX_INT QP);
```

#### Description

Reconstructs the 4x4 LumaDC block from the coefficient-position pair buffer, performs integer inverse, and dequantization for 4x4 LumaDC coefficients, and updates the pair buffer pointer to the next non-empty block.

#### Input Arguments

- `ppSrc` - Double pointer to residual coefficient-position pair buffer output by CALVC decoding

- QP - Quantization parameter QpY

### Output Arguments

- ppSrc - \*ppSrc is updated to the start of next non empty block
- pDst - Pointer to the reconstructed 4x4 LumaDC coefficients buffer; must be aligned on a 8-byte boundary.

### Returns

If the function runs without error, it returns OMX\_Sts\_NoErr.

If one of the following cases occurs, the function returns OMX\_Sts\_BadArgErr:

- ppSrc or pDst is NULL.
- pDst is not 8 byte aligned.
- QP is not in the range of [0-51].

## 6.3.4.2.2 TransformDequantChromaDCFromPair

### Prototype

```
OMXResult omxVCM4P10_TransformDequantChromaDCFromPair(const OMX_U8 **ppSrc,
    OMX_S16 *pDst, OMX_INT QP);
```

### Description

Reconstruct the 2x2 ChromaDC block from coefficient-position pair buffer, perform integer inverse transformation, and dequantization for 2x2 chroma DC coefficients, and update the pair buffer pointer to next non-empty block.

### Input arguments

- ppSrc - Double pointer to residual coefficient-position pair buffer output by CALVC decoding
- QP - Quantization parameter QpC

### Output Arguments

- ppSrc - \*ppSrc is updated to the start of next non empty block
- pDst - Pointer to the reconstructed 2x2 ChromaDC coefficients buffer; must be aligned on a 4-byte boundary.

### Returns

If the function runs without error, it returns OMX\_Sts\_NoErr.

If any of the following cases occurs, the function returns OMX\_Sts\_BadArgErr:

- ppSrc or pDst is NULL.
- pDst is not 4-byte aligned.
- QP is not in the range of [0-51].

### 6.3.4.2.3 DequantTransformResidualFromPairAndAdd

#### Prototype

```
OMXResult omxVCM4P10_DequantTransformResidualFromPairAndAdd(const OMX_U8
    **ppSrc, const OMX_U8 *pPred, const OMX_S16 *pDC, OMX_U8 *pDst, OMX_INT
    predStep, OMX_INT dstStep, OMX_INT QP, OMX_INT AC);
```

#### Description

Reconstruct the 4x4 residual block from coefficient-position pair buffer, perform dequantization and integer inverse transformation for 4x4 block of residuals with previous intra prediction or motion compensation data, and update the pair buffer pointer to next non-empty block. If pDC == NULL, there're 16 non-zero AC coefficients at most in the packed buffer starting from 4x4 block position 0; If pDC != NULL, there're 15 non-zero AC coefficients at most in the packet buffer starting from 4x4 block position 1.

#### Input Arguments

- ppSrc - Double pointer to residual coefficient-position pair buffer output by CALVC decoding
- pPred - Pointer to the predicted 4x4 block; must be aligned on a 4-byte boundary
- predStep - Predicted frame step size in bytes; must be a multiple of 4
- dstStep - Destination frame step in bytes; must be a multiple of 4
- pDC - Pointer to the DC coefficient of this block, NULL if it doesn't exist
- QP - QP Quantization parameter. It should be QpC in chroma 4x4 block decoding, otherwise it should be QpY.
- AC - Flag indicating if at least one non-zero AC coefficient exists

#### Output Arguments

- pDst - pointer to the reconstructed 4x4 block data; must be aligned on a 4-byte boundary

#### Returns

If the function runs without error, it returns OMX\_Sts\_NoErr.

If one of the following cases occurs, the function returns OMX\_Sts\_BadArgErr:

- pPred or pDst is NULL.
- pPred or pDst is not 4-byte aligned.
- predStep or dstStep is not a multiple of 4.
- AC !=0 and QP is not in the range of [0-51] or ppSrc == NULL.
- AC ==0 && pDC ==NULL.

### 6.3.5 Encoder Functions

This section describes functions that could be used to construct a baseline profile H.264 encoder. Both high-level and low-level motion estimation functions are defined. Helper functions are defined to support initialization of vendor-specific motion estimation specification structures.

## 6.3.5.1 Motion Estimation Helper

### 6.3.5.1.1 MEGetBufSize

#### Prototype

```
OMXResult omxVCM4P10_MEGetBufSize(OMXVCM4P10MEMode MEMode, const  
    OMXVCM4P10MEParams *pMEParams, OMX_U32 *pSize)
```

#### Description

Computes the size, in bytes, of the vendor-specific specification structure for the omxVCM4P10 motion estimation functions `BlockMatch_Integer` and `MotionEstimationMB`.

#### Input Arguments

- `MEMode` – motion estimation mode; available modes are defined by the enumerated type `OMXVCM4P10MEMode`
- `pMEParams` – motion estimation parameters

#### Output Arguments

- `pSize` – pointer to the number of bytes required for the motion estimation specification structure

#### Returns

If the function runs without error, it returns `OMX_Sts_NoErr`.

If one of the following cases occurs, the function returns `OMX_Sts_BadArgErr`:

- `pMEParams` or `pSize` is NULL.
- an invalid `MEMode` is specified.

### 6.3.5.1.2 MEInit

#### Prototype

```
OMXResult omxVCM4P10_MEInit (OMXVCM4P10MEMode MEMode, const  
    OMXVCM4P10MEParams *pMEParams, void *pMESpec);
```

#### Description

Initializes the vendor-specific specification structure required for the omxVCM4P10 motion estimation functions: `BlockMatch_Integer` and `MotionEstimationMB`. Memory for the specification structure `*pMESpec` must be allocated prior to calling the function, and should be aligned on a 4-byte boundary. The number of bytes required for the specification structure can be determined using the function `omxVCM4P10_MEGetBufSize`. Following initialization by this function, the vendor-specific structure `*pMESpec` should contain an implementation-specific representation of all motion estimation parameters received via the structure `pMEParams`, for example `searchRange16x16`, `searchRange8x8`, etc.

## Input Arguments

- `MEMode` – motion estimation mode; available modes are defined by the enumerated type `OMXVCM4P10MEMode`
- `pMEParams` – motion estimation parameters
- `pMESpec` – pointer to the uninitialized ME specification structure

## Output Arguments

- `pMESpec` – pointer to the initialized ME specification structure

## Returns

`OMX_Sts_NoErr` – no error

`OMX_Sts_BadArgErr` – one or more of the following is true:

- `pMEParams` or `pSize` is `NULL`.
- an invalid value was specified for the parameter `MEMode`
- a negative or zero value was specified for one of the search ranges (e.g., `pMBParams->searchRange8x8`, `pMEParams->searchRange16x16`, etc.)
- either in isolation or in combination, one or more of the enables or search ranges in the structure `*pMEParams` were configured such that the requested behavior fails to comply with [ISO14496-10].

## 6.3.5.2 Motion Estimation , Low-Level

### 6.3.5.2.1 BlockMatch\_Integer

#### Prototype

```
OMXResult omxVCM4P10_BlockMatch_Integer (const OMX_U8 *pSrcOrgY, OMX_S32
    nSrcOrgStep, const OMX_U8 *pSrcRefY, OMX_S32 nSrcRefStep, const OMXRect
    *pRefRect, const OMXVCM4P2Coordinate *pCurrPointPos, OMX_U8 iBlockWidth,
    OMX_U8 iBlockHeight, OMX_U32 nLamda, const OMXVCMotionVector *pMVPred,
    const OMXVCMotionVector *pMVCandidate, OMXVCMotionVector *pBestMV, OMX_S32
    *pBestCost, void *pMESpec)
```

#### Description

Performs integer block match. Returns best MV and associated cost.

#### Input Arguments

- `pSrcOrgY` – Pointer to the top-left corner of the current block.
  - If `iBlockWidth==4`, 4-byte alignment required.
  - If `iBlockWidth==8`, 8-byte alignment required.
  - If `iBlockWidth==16`, 16-byte alignment required.
- `pSrcRefY` – Pointer to the top-left corner of the co-located block in the reference picture.
  - If `iBlockWidth==4`, 4-byte alignment required.
  - If `iBlockWidth==8`, 8-byte alignment required.
  - If `iBlockWidth==16`, 16-byte alignment required.

- `nSrcOrgStep` – Stride of the original picture plane, expressed in terms of integer pixels; must be a multiple of `iBlockWidth`.
- `nSrcRefStep` – Stride of the reference picture plane, expressed in terms of integer pixels
- `pRefRect` – pointer to the valid reference rectangle inside the reference picture plane
- `nCurrPointPos` – position of the current block in the current plane
- `iBlockWidth` – Width of the current block, expressed in terms of integer pixels; must be equal to either 4, 8, or 16.
- `iBlockHeight` – Height of the current block, expressed in terms of integer pixels; must be equal to either 4, 8, or 16.
- `nLamda` – Lamda factor; used to compute motion cost
- `pMVPred` – Predicted MV; used to compute motion cost, expressed in terms of 1/4-pel units
- `pMVCandidate` – Candidate MV; used to initialize the motion search, expressed in terms of integer pixels
- `pMESpec` – pointer to the ME specification structure

### Output Arguments

- `pDstBestMV` – Best MV resulting from integer search, expressed in terms of 1/4-pel units
- `pBestCost` – Motion cost associated with the best MV; computed as  $SAD + \text{Lamda} * \text{BitsUsedByMV}$

### Returns

If the function runs without error, it returns `OMX_Sts_NoErr`.

If one of the following cases occurs, the function returns `OMX_Sts_BadArgErr`:

- `pSrcOrgY`, `pSrcRefY`, `pRefRect`, `pMVPred`, `pMVCandidate`, or `pMESpec` is NULL.
- Either `iBlockWidth` or `iBlockHeight` are equal to values other than 4, 8, or 16.
- Any alignment restrictions are violated



### 6.3.5.2.2 BlockMatch\_Half

#### Prototype

```
OMXResult omxVCM4P10_BlockMatch_Half(const OMX_U8 *pSrcOrgY, OMX_S32
    nSrcOrgStep, const OMX_U8 *pSrcRefY, OMX_S32 nSrcRefStep, OMX_U8
    iBlockWidth, OMX_U8 iBlockHeight, OMX_U32 nLamda, const
    OMXVCMotionVector *pMVPred, OMXVCMotionVector *pSrcDstBestMV, OMX_S32
    *pBestCost)
```

#### Description

Performs a half-pel block match using results from a prior integer search. Returns the best MV and associated cost. This function estimates the half-pixel motion vector by interpolating the integer resolution motion vector referenced by the input parameter `pSrcDstBestMV`, i.e., the initial integer MV is generated externally. The function `omxVCM4P10_BlockMatch_Integer` may be used for integer motion estimation.

#### Input Arguments

- `pSrcOrgY` – Pointer to the current position in original picture plane.
  - If `iBlockWidth==4`, 4-byte alignment required.
  - If `iBlockWidth==8`, 8-byte alignment required.
  - If `iBlockWidth==16`, 16-byte alignment required.
- `pSrcRefY` – Pointer to the top-left corner of the co-located block in the reference picture
  - If `iBlockWidth==4`, 4-byte alignment required.
  - If `iBlockWidth==8`, 8-byte alignment required.
  - If `iBlockWidth==16`, 16-byte alignment required.
- `nSrcOrgStep` – Stride of the original picture plane in terms of full pixels; must be a multiple of `iBlockWidth`.
- `nSrcRefStep` – Stride of the reference picture plane in terms of full pixels
- `iBlockWidth` – Width of the current block in terms of full pixels; must be equal to either 4, 8, or 16.
- `iBlockHeight` – Height of the current block in terms of full pixels; must be equal to either 4, 8, or 16.
- `nLamda` – Lamda factor, used to compute motion cost
- `pMVPred` – Predicted MV, represented in terms of 1/4-pel units; used to compute motion cost
- `pSrcDstBestMV` – The best MV resulting from a prior integer search, represented in terms of 1/4-pel units

#### Output Arguments

- `pSrcDstBestMV` – Best MV resulting from the half-pel search, expressed in terms of 1/4-pel units
- `pBestCost` – Motion cost associated with the best MV; computed as  $SAD + Lamda * BitsUsedByMV$

#### Returns

If the function runs without error, it returns `OMX_Sts_NoErr`.

If one of the following cases occurs, the function returns `OMX_Sts_BadArgErr`:

- One of more of the following pointers is NULL: `pSrcOrgY`, `pSrcRefY`, `pSrcDstBestMV`, `pMVPred`, `pBestCost`
- Either `iBlockWidth` or `iBlockHeight` are equal to values other than 4, 8, or 16.
- Any alignment restrictions are violated

### 6.3.5.2.3 BlockMatch\_Quarter

#### Prototype

```
OMXResult omxVCM4P10_BlockMatch_Quarter(const OMX_U8 *pSrcOrgY, OMX_S32
    nSrcOrgStep, const OMX_U8 *pSrcRefY, OMX_S32 nSrcRefStep, OMX_U8
    iBlockWidth, OMX_U8 iBlockHeight, OMX_U32 nLamda, const
    OMXVCMotionVector *pMVPred, OMXVCMotionVector *pSrcDstBestMV, OMX_S32
    *pBestCost)
```

#### Description

Performs a quarter-pel block match using results from a prior half-pel search. Returns the best MV and associated cost. This function estimates the quarter-pixel motion vector by interpolating the half-pel resolution motion vector referenced by the input parameter `pSrcDstBestMV`, i.e., the initial half-pel MV is generated externally. The function `omxVCM4P10_BlockMatch_Half` may be used for half-pel motion estimation.

#### Input Arguments

- `pSrcOrgY` – Pointer to the current position in original picture plane.
  - If `iBlockWidth==4`, 4-byte alignment required.
  - If `iBlockWidth==8`, 8-byte alignment required.
  - If `iBlockWidth==16`, 16-byte alignment required.
- `pSrcRefY` – Pointer to the top-left corner of the co-located block in the reference picture
  - If `iBlockWidth==4`, 4-byte alignment required.
  - If `iBlockWidth==8`, 8-byte alignment required.
  - If `iBlockWidth==16`, 16-byte alignment required.
- `nSrcOrgStep` – Stride of the original picture plane in terms of full pixels; must be a multiple of `iBlockWidth`.
- `nSrcRefStep` – Stride of the reference picture plane in terms of full pixels
- `iBlockWidth` – Width of the current block in terms of full pixels; must be equal to either 4, 8, or 16.
- `iBlockHeight` – Height of the current block in terms of full pixels; must be equal to either 4, 8, or 16.
- `nLamda` – Lamda factor, used to compute motion cost
- `pMVPred` – Predicted MV, represented in terms of 1/4-pel units; used to compute motion cost
- `pSrcDstBestMV` – The best MV resulting from a prior half-pel search, represented in terms of 1/4-pel units

#### Output Arguments

- `pSrcDstBestMV` – Best MV resulting from the quarter-pel search, expressed in terms of 1/4-pel units
- `pBestCost` – Motion cost associated with the best MV; computed as  $SAD + Lamda * BitsUsedByMV$

#### Returns

If the function runs without error, it returns `OMX_Sts_NoErr`.

If one of the following cases occurs, the function returns `OMX_Sts_BadArgErr`:

- One of more of the following pointers is NULL: `pSrcOrgY`, `pSrcRefY`, `pSrcDstBestMV`, `pMVPred`, `pBestCost`
- Either `iBlockWidth` or `iBlockHeight` are equal to values other than 4, 8, or 16.
- Any alignment restrictions are violated

### 6.3.5.3 Motion Estimation , High-Level

#### 6.3.5.3.1 MotionEstimationMB

##### Prototype

```
OMXResult omxVCM4P10_MotionEstimationMB(const OMX_U8 *pSrcCurrBuf, OMX_S32
    SrcCurrStep, const OMX_U8 *pSrcRefBufList[15], OMX_S32 SrcRefStep, const
    OMX_U8 *pSrcRecBuf, OMX_S32 SrcRecStep, const OMXRect *pRefRect, const
    OMXVCM4P2Coordinate *pCurrPointPos, OMX_U32 Lambda, void *pMESpec, const
    OMXVCM4P10MBInfoPtr *pMBInter, const OMXVCM4P10MBInfoPtr *pMBIntra,
    OMXVCM4P10MBInfoPtr pSrcDstMBCurr, OMX_INT *pDstCost, OMX_U16
    *pDstBlockSAD)
```

##### Description

Performs MB-level motion estimation and selects best motion estimation strategy from the set of modes supported in baseline profile [ISO14496-10].

##### Input Arguments

- `pSrcCurrBuf` – Pointer to the current position in original picture plane; 16-byte alignment required
- `pSrcRefBufList` – Pointer to an array with 16 entries. Each entry points to the top-left corner of the co-located MB in a reference picture. The array is filled from low-to-high with valid reference frame pointers; the unused high entries should be set to NULL. Ordering of the reference frames should follow [ISO14496-10] subclause 8.2.4 “Decoding Process for Reference Picture Lists.” The entries must be 16-byte aligned.
- `pSrcRecBuf` – Pointer to the top-left corner of the co-located MB in the reconstructed picture; must be 16-byte aligned.
- `SrcCurrStep` – Width of the original picture plane in terms of full pixels; must be a multiple of 16.
- `SrcRefStep` – Width of the reference picture plane in terms of full pixels; must be a multiple of 16.
- `SrcRecStep` – Width of the reconstructed picture plane in terms of full pixels; must be a multiple of 16.
- `pRefRect` – Pointer to the valid reference rectangle; relative to the image origin.
- `pCurrPointPos` – Position of the current macroblock in the current plane.
- `Lambda` – Lagrange factor for computing the cost function
- `pMESpec` – Pointer to the motion estimation specification structure; must have been allocated and initialized prior to calling this function.
- `pMBInter` – Array, of dimension four, containing pointers to information associated with four adjacent type INTER MBs (Left, Top, Top-Left, Top-Right). Any pointer in the array may be set equal to NULL if the corresponding MB doesn’t exist or is not of type INTER.
  - `pMBInter[0]` – Pointer to left MB information

- `pMBInter[1]` – Pointer to top MB information
- `pMBInter[2]` – Pointer to top-left MB information
- `pMBInter[3]` – Pointer to top-right MB information
- `pMBIntra` – Array, of dimension four, containing pointers to information associated with four adjacent type INTRA MBs (Left, Top, Top-Left, Top-Right). Any pointer in the array may be set equal to NULL if the corresponding MB doesn't exist or is not of type INTRA.
  - `pMBIntra[0]` – Pointer to left MB information
  - `pMBIntra[1]` – Pointer to top MB information
  - `pMBIntra[2]` – Pointer to top-left MB information
  - `pMBIntra[3]` – Pointer to top-right MB information
- `pSrcDstMBCurr` – Pointer to information structure for the current MB. The following entries should be set prior to calling the function: `sliceID` – the number of the slice the to which the current MB belongs.

### Output Arguments

- `pDstCost` – Pointer to the minimum motion cost for the current MB.
- `pDstBlockSAD` – Pointer to the array of SADs for each of the sixteen luma 4x4 blocks in each MB. The block SADs are in scan order for each MB. For implementations that cannot compute the SAD values individually, the maximum possible value (0xffff) is returned for each of the 16 block SAD entries.
- `pSrcDstMBCurr` – Pointer to updated information structure for the current MB after MB-level motion estimation has been completed. The following fields are updated by the ME function. The following parameter set quantifies the MB-level ME search results:
  - `MbType`
  - `subMbType[4]`
  - `pMV0[4][4]`
  - `pMVPred[4][4]`
  - `pRefL0Idx[4]`
  - `Intra16x16PredMode`
  - `pIntra4x4PredMode[4][4]`

### Returns

If the function runs without error, it returns `OMX_Sts_NoErr`.

If one of the following cases occurs, the function returns `OMX_Sts_BadArgErr`:

- One of more of the following pointers is NULL: `pSrcCurrBuf`, `pSrcRefBufList`, `pSrcRecBuf`, `pRefRect`, `pCurrPointPos`, `pMESpec`, `pMBInter`, `pMBIntra`, `pSrcDstMBCurr`, `pDstCost`, `pSrcRefBufList[0]`
- `SrcRefStep`, `SrcRecStep` are not multiples of 16
- Either `iBlockWidth` or `iBlockHeight` are equal to values other than 4, 8, or 16.
- Any alignment restrictions are violated

## 6.3.5.4 SAD/SATD

### 6.3.5.4.1 SAD\_4x

#### Prototype

```
OMXResult omxVCM4P10_SAD_4x (const OMX_U8 *pSrcOrg, OMX_U32 iStepOrg, const  
    OMX_U8 *pSrcRef, OMX_U32 iStepRef, OMX_S32 *pDstSAD, OMX_U32 iHeight);
```

#### Description

This function calculates the SAD for 4x8 and 4x4 blocks.

#### Input Arguments

- `pSrcOrg` - Pointer to the original block; must be aligned on a 4-byte boundary.
- `iStepOrg` - Step of the original block buffer; must be a multiple of 4.
- `pSrcRef` - Pointer to the reference block
- `iStepRef` - Step of the reference block buffer
- `iHeight` - Height of the block; must be equal to either 4 or 8.

#### Output Parameters

- `pDstSAD` - Pointer of result SAD

#### Returns

The function returns `OMX_Sts_NoErr` if it runs without error.

The function returns `OMX_Sts_BadArgErr` if one or more of the following is true:

- One of more of the following pointers is NULL: `pSrcOrg`, `pSrcRef`, or `pDstSAD`
- `iHeight` is not equal to either 4 or 8.
- `iStepOrg` is not a multiple of 4
- Any alignment restrictions are violated

### 6.3.5.4.2 SADQuar\_4x

#### Prototype

```
OMXResult omxVCM4P10_SADQuar_4x (const OMX_U8 *pSrc, const OMX_U8 *pSrcRef0,  
    const OMX_U8 *pSrcRef1, OMX_U32 iSrcStep, OMX_U32 iRefStep0, OMX_U32  
    iRefStep1, OMX_U32 *pDstSAD, OMX_U32 iHeight);
```

#### Description

This function calculates the SAD between one block (`pSrc`) and the average of the other two (`pSrcRef0` and `pSrcRef1`) for 4x8 or 4x4 blocks. Rounding is applied according to the convention  $(a+b+1)>>1$ .

#### Input Arguments

- `pSrc` - Pointer to the original block; must be aligned on a 4-byte boundary.

- `pSrcRef0` - Pointer to reference block 0
- `pSrcRef1` - Pointer to reference block 1
- `iSrcStep` - Step of the original block buffer; must be a multiple of 4.
- `iRefStep0` - Step of reference block 0
- `iRefStep1` - Step of reference block 1
- `iHeight` - Height of the block; must be equal to either 4 or 8.

### Output Parameters

- `pDstSAD` - Pointer of result SAD

### Returns

The function returns `OMX_Sts_NoErr` if it runs without error.

The function returns `OMX_Sts_BadArgErr` if one or more of the following is true:

- `iHeight` is not equal to either 4 or 8.
- One or more of the following pointers is NULL: `pSrc`, `pSrcRef0`, `pSrcRef1`, `pDstSAD`.
- `iSrcStep` is not a multiple of 4
- Any alignment restrictions are violated

## 6.3.5.4.3 SADQuar\_8x

### Prototype

```
OMXResult omxVCM4P10_SADQuar_8x (const OMX_U8 *pSrc, const OMX_U8 *pSrcRef0,
    const OMX_U8 *pSrcRef1, OMX_U32 iSrcStep, OMX_U32 iRefStep0, OMX_U32
    iRefStep1, OMX_U32 *pDstSAD, OMX_U32 iHeight);
```

### Description

This function calculates the SAD between one block (`pSrc`) and the average of the other two (`pSrcRef0` and `pSrcRef1`) for 8x16, 8x8, or 8x4 blocks. Rounding is applied according to the convention  $(a+b+1)>>1$ .

### Input Arguments

- `pSrc` - Pointer to the original block; must be aligned on an 8-byte boundary.
- `pSrcRef0` - Pointer to reference block 0
- `pSrcRef1` - Pointer to reference block 1
- `iSrcStep` - Step of the original block buffer; must be a multiple of 8.
- `iRefStep0` - Step of reference block 0
- `iRefStep1` - Step of reference block 1
- `iHeight` - Height of the block; must be equal either 4, 8, or 16.

### Output Parameters

- `pDstSAD` - Pointer of result SAD

## Returns

The function returns `OMX_Sts_NoErr` if it runs without error.

The function returns `OMX_Sts_BadArgErr` if one or more of the following is true:

- `iHeight` is not equal to either 4, 8, or 16.
- One of more of the following pointers is NULL: `pSrc`, `pSrcRef0`, `pSrcRef1`, `pDstSAD`.
- `iSrcStep` is not a multiple of 8
- Any alignment restrictions are violated

### 6.3.5.4.4 SADQuar\_16x

## Prototype

```
OMXResult omxVCM4P10_SADQuar_16x (const OMX_U8 *pSrc, const OMX_U8
    *pSrcRef0, const OMX_U8 *pSrcRef1, OMX_U32 iSrcStep, OMX_U32 iRefStep0,
    OMX_U32 iRefStep1, OMX_U32 *pDstSAD, OMX_U32 iHeight);
```

## Description

This function calculates the SAD between one block (`pSrc`) and the average of the other two (`pSrcRef0` and `pSrcRef1`) for 16x16 or 16x8 blocks. Rounding is applied according to the convention  $(a+b+1)>>1$ .

## Input Arguments

- `pSrc` - Pointer to the original block; must be aligned on a 16-byte boundary.
- `pSrcRef0` - Pointer to reference block 0
- `pSrcRef1` - Pointer to reference block 1
- `iSrcStep` - Step of the original block buffer; must be a multiple of 16
- `iRefStep0` - Step of reference block 0
- `iRefStep1` - Step of reference block 1
- `iHeight` - Height of the block; must be equal to either 8 or 16

## Output Parameters

- `pDstSAD` - Pointer of result SAD

## Returns

The function returns `OMX_Sts_NoErr` if it runs without error.

The function returns `OMX_Sts_BadArgErr` if one or more of the following is true:

- `iHeight` is not equal to either 8 or 16.
- One of more of the following pointers is NULL: `pSrc`, `pSrcRef0`, `pSrcRef1`, `pDstSAD`.
- `iSrcStep` is not a multiple of 16
- Any alignment restrictions are violated



### 6.3.5.4.5 SATD\_4x4

#### Prototype

```
OMXResult omxVCM4P10_SATD_4x4 (const OMX_U8 *pSrcOrg, OMX_U32 iStepOrg,  
    const OMX_U8 *pSrcRef, OMX_U32 iStepRef, OMX_U32 *pDstSAD);
```

#### Description

This function calculates the sum of absolute transform differences (SATD) for a 4x4 block by applying a Hadamard transform to the difference block and then calculating the sum of absolute coefficient values.

#### Input Arguments

- `pSrcOrg` - Pointer to the original block; must be aligned on a 4-byte boundary
- `iStepOrg` - Step of the original block buffer; must be a multiple of 4
- `pSrcRef` - Pointer to the reference block; must be aligned on a 4-byte boundary
- `iStepRef` - Step of the reference block buffer; must be a multiple of 4

#### Output Parameters

- `pDstSAD` - pointer to the resulting SAD

#### Returns

- `OMX_Sts_NoErr` - no error
- `OMX_Sts_BadArgErr` - bad arguments; returned if any of the following conditions are true:
  - at least one of the following pointers is NULL: `pSrcOrg`, `pSrcRef`, or `pDstSAD`
  - either `pSrcOrg` or `pSrcRef` is not aligned on a 4-byte boundary
  - `iStepOrg <= 0` or `iStepOrg` is not a multiple of 4
  - `iStepRef <= 0` or `iStepRef` is not a multiple of 4

### 6.3.5.5 Interpolation

#### 6.3.5.5.1 InterpolateHalfHor\_Luma

#### Prototype

```
OMXResult omxVCM4P10_InterpolateHalfHor_Luma( const OMX_U8 *pSrc, OMX_U32  
    iSrcStep, OMX_U8 *pDstLeft, OMX_U8 *pDstRight, OMX_U32 iDstStep, OMX_U32  
    iWidth, OMX_U32 iHeight);
```

#### Description

This function performs interpolation for two horizontal 1/2-pel positions  $(-1/2, 0)$  and  $(1/2, 0)$  - around a full-pel position.

#### Input Arguments

- `pSrc` - Pointer to the top-left corner of the block used to interpolate in the reconstruction frame plane.

- `iSrcStep` - Step of the source buffer.
- `iDstStep` - Step of the destination(interpolation) buffer; must be a multiple of `iWidth`.
- `iWidth`- Width of the current block; must be equal to either 4, 8, or 16
- `iHeight` - Height of the current block; must be equal to either 4, 8, or 16

### Output Parameters

- `pDstLeft` - Pointer to the interpolation buffer of the left -pel position (-1/2, 0)  
If `iWidth==4`, 4-byte alignment required.  
If `iWidth==8`, 8-byte alignment required.  
If `iWidth==16`, 16-byte alignment required.
- `pDstRight` - Pointer to the interpolation buffer of the right -pel position (1/2, 0)  
If `iWidth==4`, 4-byte alignment required.  
If `iWidth==8`, 8-byte alignment required.  
If `iWidth==16`, 16-byte alignment required.

### Returns

- `OMX_Sts_NoErr` - no error
- `OMX_Sts_BadArgErr` - bad arguments; returned if any of the following conditions are true:
  - at least one of the following pointers is NULL: `pSrc`, `pDstLeft`, or `pDstRight`
  - `iWidth` or `iHeight` have values other than 4, 8, or 16
  - `iWidth==4` but `pDstLeft` and/or `pDstRight` is/are not aligned on a 4-byte boundary
  - `iWidth==8` but `pDstLeft` and/or `pDstRight` is/are not aligned on a 8-byte boundary
  - `iWidth==16` but `pDstLeft` and/or `pDstRight` is/are not aligned on a 16-byte boundary
  - any alignment restrictions are violated

## 6.3.5.5.2 InterpolateHalfVer\_Luma

### Prototype

```
OMXResult omxVCM4P10_InterpolateHalfVer_Luma(const OMX_U8 *pSrc, OMX_U32
    iSrcStep, OMX_U8 *pDstUp, OMX_U8 *pDstDown, OMX_U32 iDstStep, OMX_U32
    iWidth, OMX_U32 iHeight);
```

### Description

This function performs interpolation for two vertical 1/2-pel positions - (0, -1/2) and (0, 1/2) - around a full-pel position.

### Input Arguments

- `pSrc` - Pointer to top-left corner of block used to interpolate in the reconstructed frame plane
- `iSrcStep` - Step of the source buffer.
- `iDstStep` - Step of the destination (interpolation) buffer; must be a multiple of `iwidth`.
- `iWidth` - Width of the current block; must be equal to either 4, 8, or 16
- `iHeight` - Height of the current block; must be equal to either 4, 8, or 16

## Output Parameters

- `pDstUp` - Pointer to the interpolation buffer of the -pel position above the current full-pel position (0, -1/2)
  - If `iWidth==4`, 4-byte alignment required.
  - If `iWidth==8`, 8-byte alignment required.
  - If `iWidth==16`, 16-byte alignment required.
- `pDstDown` - Pointer to the interpolation buffer of the -pel position below the current full-pel position (0, 1/2)
  - If `iWidth==4`, 4-byte alignment required.
  - If `iWidth==8`, 8-byte alignment required.
  - If `iWidth==16`, 16-byte alignment required.

## Returns

- `OMX_Sts_NoErr` - no error
- `OMX_Sts_BadArgErr` - bad arguments; returned if any of the following conditions are true:
  - at least one of the following pointers is NULL: `pSrc`, `pDstUp`, or `pDstDown`
  - `iWidth` or `iHeight` have values other than 4, 8, or 16
  - `iWidth==4` but `pDstUp` and/or `pDstDown` is/are not aligned on a 4-byte boundary
  - `iWidth==8` but `pDstUp` and/or `pDstDown` is/are not aligned on a 8-byte boundary
  - `iWidth==16` but `pDstUp` and/or `pDstDown` is/are not aligned on a 16-byte boundary

### 6.3.5.5.3 Average\_4x

#### Prototype

```
OMXResult omxVCM4P10_Average_4x (const OMX_U8 *pPred0, const OMX_U8 *pPred1,  
    OMX_U32 iPredStep0, OMX_U32 iPredStep1, OMX_U8 *pDstPred, OMX_U32  
    iDstStep, OMX_U32 iHeight);
```

#### Description

This function calculates the average of two 4x4, 4x8 blocks. The result is rounded according to  $(a+b+1)/2$ .

#### Input Arguments

- `pPred0` - Pointer to the top-left corner of reference block 0
- `pPred1` - Pointer to the top-left corner of reference block 1
- `iPredStep0` - Step of reference block 0; must be a multiple of 4.
- `iPredStep1` - Step of reference block 1; must be a multiple of 4.
- `iDstStep` - Step of the destination buffer; must be a multiple of 4.
- `iHeight` - Height of the blocks; must be either 4 or 8.

#### Output Parameters

- `pDstPred` - Pointer to the destination buffer. 4-byte alignment required.

## Returns

- `OMX_Sts_NoErr` – no error
- `OMX_Sts_BadArgErr` – bad arguments; returned if any of the following conditions are true:
  - at least one of the following pointers is NULL: `pPred0`, `pPred1`, or `pDstPred`
  - `pDstPred` is not aligned on a 4-byte boundary
  - `iPredStep0`  $\leq 0$  or `iPredStep0` is not a multiple of 4
  - `iPredStep1`  $\leq 0$  or `iPredStep1` is not a multiple of 4
  - `iDstStep`  $\leq 0$  or `iDstStep` is not a multiple of 4
  - `iHeight` is not equal to either 4 or 8

## 6.3.5.6 Transform and Quantization

### 6.3.5.6.1 TransformQuant\_ChromaDC

#### Prototype

```
OMXResult omxVCM4P10_TransformQuant_ChromaDC(OMX_S16 *pSrcDst, OMX_U32 iQP,  
    OMX_U8 bIntra);
```

#### Description

This function performs 2x2 Hadamard transform of chroma DC coefficients and then quantizes the coefficients.

#### Input Arguments

- `pSrcDst` – Pointer to the 2x2 array of chroma DC coefficients. 8-byte alignment required.
- `iQP` – Quantization parameter; must be in the range [0,51].
- `bIntra` – Indicate whether this is an INTRA block. 1-INTRA, 0-INTER

#### Output Parameters

- `pSrcDst` – Pointer to transformed and quantized coefficients. 8-byte alignment required.

#### Returns

- `OMX_Sts_NoErr` – no error
- `OMX_Sts_BadArgErr` – bad arguments; returned if any of the following conditions are true:
  - at least one of the following pointers is NULL: `pSrcDst`
  - `pSrcDst` is not aligned on an 8-byte boundary

### 6.3.5.6.2 TransformQuant\_LumaDC

#### Prototype

```
OMXResult omxVCM4P10_TransformQuant_LumaDC(OMX_S16 *pSrcDst, OMX_U32 iQP);
```

## Description

This function performs a 4x4 Hadamard transform of luma DC coefficients and then quantizes the coefficients.

## Input Arguments

- `pSrcDst` - Pointer to the 4x4 array of luma DC coefficients. 16-byte alignment required.
- `iQP` - Quantization parameter; must be in the range [0,51].

## Output Parameters

- `pSrcDst` - Pointer to transformed and quantized coefficients. 16-byte alignment required.

## Returns

- `OMX_Sts_NoErr` - no error
- `OMX_Sts_BadArgErr` - bad arguments; returned if any of the following conditions are true:
  - at least one of the following pointers is NULL: `pSrcDst`
  - `pSrcDst` is not aligned on an 16-byte boundary

### 6.3.5.6.3 InvTransformDequant\_LumaDC

## Prototype

```
OMXResult omxVCM4P10_InvTransformDequant_LumaDC(const OMX_S16 *pSrc, OMX_S16 *pDst, OMX_U32 iQP);
```

## Description

This function performs inverse 4x4 Hadamard transform and then dequantizes the coefficients.

## Input Arguments

- `pSrc` - Pointer to the 4x4 array of the 4x4 Hadamard-transformed and quantized coefficients. 16-byte alignment required.
- `iQP` - Quantization parameter; must be in the range [0,51].

## Output Parameters

- `pDst` - Pointer to inverse-transformed and dequantized coefficients. 16-byte alignment required.

## Returns

- `OMX_Sts_NoErr` - no error
- `OMX_Sts_BadArgErr` - bad arguments; returned if any of the following conditions are true:
  - at least one of the following pointers is NULL: `pSrc`
  - `pSrc` or `pDst` is not aligned on a 16-byte boundary

### 6.3.5.6.4 InvTransformDequant\_ChromaDC

#### Prototype

```
OMXResult omxVCM4P10_InvTransformDequant_ChromaDC(const OMX_S16 *pSrc,  
    OMX_S16 *pDst, OMX_U32 iQP);
```

#### Description

This function performs inverse 2x2 Hadamard transform and then dequantizes the coefficients.

#### Input Arguments

- `pSrc` - Pointer to the 2x2 array of the 2x2 Hadamard-transformed and quantized coefficients. 8-byte alignment required.
- `iQP` - Quantization parameter; must be in the range [0,51].

#### Output Parameters

- `pDst` - Pointer to inverse-transformed and dequantized coefficients. 8-byte alignment required.

#### Returns

- `OMX_Sts_NoErr` - no error
- `OMX_Sts_BadArgErr` - bad arguments; returned if any of the following conditions are true:
  - at least one of the following pointers is NULL: `pSrc`
  - `pSrc` or `pDst` is not aligned on an 8-byte boundary

### 6.3.5.7 Transform and Compensation

#### 6.3.5.7.1 InvTransformResidualAndAdd

#### Prototype

```
OMXResult omxVCM4P10_InvTransformResidualAndAdd (const OMX_U8 *pSrcPred,  
    const OMX_S16 *pDequantCoeff, OMX_U8 *pDstRecon, OMX_U32 iSrcPredStep,  
    OMX_U32 iDstReconStep, OMX_U8 bAC);
```

#### Description

This function performs inverse an 4x4 integer transformation to produce the difference signal and then adds the difference to the prediction to get the reconstructed signal.

#### Input Arguments

- `pSrcPred` - Pointer to prediction signal. 4-byte alignment required.
- `pDequantCoeff` - Pointer to the transformed coefficients. 8-byte alignment required.
- `iSrcPredStep` - Step of the prediction buffer; must be a multiple of 4.
- `iDstReconStep` - Step of the destination reconstruction buffer; must be a multiple of 4.
- `bAC` - Indicate whether there is AC coefficients in the coefficients matrix.

## Output Parameters

- `pDstRecon` - Pointer to the destination reconstruction buffer. 4-byte alignment required.

## Returns

- `OMX_Sts_NoErr` - no error
- `OMX_Sts_BadArgErr` - bad arguments; returned if any of the following conditions are true:
  - at least one of the following pointers is NULL: `pSrcPred`, `pDequantCoeff`, `pDstRecon`
  - `pSrcPred` is not aligned on a 4-byte boundary
  - `iSrcPredStep` or `iDstReconStep` is not a multiple of 4.
  - `pDequantCoeff` is not aligned on an 8-byte boundary

## 6.3.5.8 Compensation, Transform, and Quantization

### 6.3.5.8.1 SubAndTransformQDQResidual

#### Prototype

```
OMXResult omxVCM4P10_SubAndTransformQDQResidual (const OMX_U8 *pSrcOrg,  
    const OMX_U8 *pSrcPred, OMX_U32 iSrcOrgStep, OMX_U32 iSrcPredStep,  
    OMX_S16 *pDstQuantCoeff, OMX_S16 *pDstDeQuantCoeff, OMX_S16 *pDCCoeff,  
    OMX_S8 *pNumCoeff, OMX_U32 nThreshSAD, OMX_U32 iQP, OMX_U8 bIntra);
```

#### Description

This function subtracts the prediction signal from the original signal to produce the difference signal and then performs a 4x4 integer transform and quantization. The quantized transformed coefficients are stored as `pDstQuantCoeff`. This function can also output dequantized coefficients or unquantized DC coefficients optionally by setting the pointers `pDstDeQuantCoeff`, `pDCCoeff`.

#### Input Arguments

- `pSrcOrg` - Pointer to original signal. 4-byte alignment required.
- `pSrcPred` - Pointer to prediction signal. 4-byte alignment required.
- `iSrcOrgStep` - Step of the original signal buffer; must be a multiple of 4.
- `iSrcPredStep` - Step of the prediction signal buffer; must be a multiple of 4.
- `pNumCoeff` - Number of non-zero coefficients after quantization. If this parameter is not required, it is set to NULL.
- `nThreshSAD` - Zero-block early detection threshold. If this parameter is not required, it is set to 0.
- `iQP` - Quantization parameter; must be in the range [0,51].
- `bIntra` - Indicates whether this is an INTRA block, either 1-INTRA or 0-INTER

#### Output Parameters

- `pDstQuantCoeff` - Pointer to the quantized transformed coefficients. 8-byte alignment required.
- `pDstDeQuantCoeff` - Pointer to the dequantized transformed coefficients if this parameter is not equal to NULL. 8-byte alignment required.
- `pDCCoeff` - Pointer to the unquantized DC coefficient if this parameter is not equal to NULL.

## Returns

- `OMX_Sts_NoErr` – no error
- `OMX_Sts_BadArgErr` – bad arguments; returned if any of the following conditions are true:
  - at least one of the following pointers is NULL: `pSrcOrg`, `pSrcPred`, `pNumCoeff`, `pDstQuantCoeff`, `pDstDeQuantCoeff`, `pDCCoeff`
  - `pSrcOrg` is not aligned on a 4-byte boundary
  - `pSrcPred` is not aligned on a 4-byte boundary
  - `iSrcOrgStep` is not a multiple of 4
  - `iSrcPredStep` is not a multiple of 4
  - `pDstQuantCoeff` or `pDstDeQuantCoeff` is not aligned on an 8-byte boundary

## 6.3.5.9 VLC

### 6.3.5.9.1 GetVLCInfo

#### Prototype

```
OMXResult omxVCM4P10_GetVLCInfo (const OMX_S16 *pSrcCoeff, const OMX_U8
    *pScanMatrix, OMX_U8 bAC, OMX_U32 MaxNumCoef, OMXVCM4P10VLCInfo
    *pDstVLCInfo);
```

#### Description

This function extracts run-length encoding (RLE) information from the coefficient matrix. The results are returned in an `OMXVCM4P10VLCInfo` structure.

#### Input Arguments

- `pSrcCoeff` - pointer to the transform coefficient matrix. 8-byte alignment required.
- `pScanMatrix` - pointer to the scan order definition matrix. For a luma block the scan matrix should follow [ISO14496-10] section 8.5.4, and should contain the values 0, 1, 4, 8, 5, 2, 3, 6, 9, 12, 13, 10, 7, 11, 14, 15. For a chroma block, the scan matrix should contain the values 0, 1, 2, 3.
- `bAC` - indicates presence of a DC coefficient; 0 = DC coefficient present, 1 = DC coefficient absent.
- `MaxNumCoef` – specifies the number of coefficients contained in the transform coefficient matrix, `pSrcCoeff`. The value should be 16 for blocks of type LUMADC, LUMAAC, LUMALEVEL, and CHROMAAC. The value should be 4 for blocks of type CHROMADC.

#### Output Parameters

- `pDstVLCInfo` - pointer to structure that stores information for run-length coding.

#### Returns

- `OMX_Sts_NoErr` – no error
- `OMX_Sts_BadArgErr` – bad arguments; returned if any of the following conditions are true:
  - at least one of the following pointers is NULL: `pSrcCoeff`, `pScanMatrix`, `pDstVLCInfo`
  - `pSrcCoeff` is not aligned on an 8-byte boundary





# 7.0 Concurrency Mechanisms

## 7

The OpenMAX DL API allows portability over a large range of hardware architectures. Enabled hardware architectures vary from single processor MCUs or DSPs to cabled targeted hardware accelerators. It is recognized that this form of API will not provide the most efficient code on all these architectures. With this in mind, the OpenMAX standard supports two asynchronous concurrent execution methodologies. The first methodology is called the Asynchronous Development Layer (aDL), which focuses on augmenting existing DL APIs with additional concurrent execution and primitive grouping interfaces. The second methodology is the Integrated Development Layer (iDL), that maps the Integration Layer interface and behavior onto groupings of DL primitives. Both of these methodologies are defined in header files separate from the standard Development Layer interface.

## 7.1 Asynchronous DL (aDL)

### 7.1.1 Overview

The Asynchronous Development Layer (aDL) API augments the existing DL interfaces to provide a clear path of migration from purely static execution environments to platforms that are enabled by asynchronous and parallel capabilities while remaining backward compatible and fully portable (with regards to source code). The aDL defines a common set of changes to DL APIs that allow the user to signify which primitives are grouped together for execution and how data flows between them. In addition, a set of functions and state are defined to enable control of the group execution.

Generally, developers will use aDL as a tool to target asynchronous behavior within existing DL based codecs. The API is designed to allow existing code to be ported with minimum effort to take advantage of asynchronous facilities presented by new ISAs, co-processors, tightly coupled hardware accelerators, and separate processing elements.

### 7.1.2 Upgrading DL API to aDL API

The following changes are applied to all DL APIs for inclusion into the aDL library.

1. The DL APIs name remains mostly unchanged
  - a. This maintains an obvious and evident link to the DL API
  - b. The 'omx' prefix is changed to 'omxa' to distinguish between DLs and aDLs
2. One parameter is added to the end of the parameter list and one to the beginning
  - a. The return type is added to the beginning of the list to allow it to be used in the aDL chain.
  - b. A handle is added to the end of the list to distinguish between chains
3. All parameters are replaced with their aDL type counterparts.
4. Calls to aDL functions associate themselves with the command buffer referenced by the handle.
  - a. Calls to individual aDL primitives do not signify an execution of that primitive.

- b. Calls to aDL primitives add their arguments to the command buffer. The behavior of the primitives in execution is sensitive to order in which primitives are added.
- c. Each handle refers to a separate command buffer.

**Example:**

```
/* DL API */
OMXResult omxVCM4P2_QuantInter_I(
    OMX_S16 *pSrcDst,
    OMX_U8 QP );

/* aDL API */
void omxaVCM4P2_QuantInter_I(
    const OMX_ADRESULTP pResult,
    OMX_ADLS16 *pSrcDst,
    OMX_ADLU8 QP, ;
    const OMX_PTR handle );
```

### 7.1.3 aDL Control APIs

The primitives in the aDL API can be linked together to form chains of increased functionality. The length of this chain can be from 1 aDL API to many aDL APIs. The sequencing of the chain of APIs is based on the order of insertion into the command buffer and the flow of data between the primitives (defined by function parameters and aDL control interfaces). In order to provide a full featured concurrent execution interface, the aDL must utilize a state machine to manage the execution of the command buffer. The APIs used to control and monitor this machine are explained below.

### 7.1.3.1 omxaDL\_Control

#### Name

omxaDL\_Control                      Send a command to the aDL machine (via an asynchronous handle) that references a set of non-blocking DL primitive calls.

#### C Prototype

```
OMXResult omxaDL_Control( OMX_PTR *pHandle, OMX_INT Control );
```

#### Parameters

pHandle                                  Void double pointer identifier for asynchronous context.

Control                                  Command identifier for the asynchronous primitives. See possible values below.

#### Description

Handles that point to a variable set to NULL are implicitly initialized (as per OMX\_ADL\_CMD\_CREATE) to new state unless otherwise specified.

**Table 1 - aDL Control Values**

| <i>Control Value</i>           | <i>Effect</i>   |
|--------------------------------|---|
| <i>OMX_ADL_CMD_BLOCK</i>       | <i>Blocks program flow until the data from all primitives associated with the handle is valid. This command does not change the aDL state. This command will return errors encountered while executing the command buffer.</i>  |
| <i>OMX_ADL_STATE_CAUSAL</i>    | <i>Tells the asynchronous state machine that the primitives associated with the handle have a strongly causal relationship. All primitives are assumed to be executed in the order they were added to the command buffer. The function will return an error (OMX_StsAdlInvalidCmdErr) if the state is in Executing.</i><br><br><i>Explicitly setting the state to OMX_ADL_STATE_CAUSAL will also lock the command buffer as per OMX ADL STATE LOCK.</i> |
| <i>OMX_ADL_STATE_NONCAUSAL</i> | <i>Tells the asynchronous state machine that the primitives associated with the handle have a noncausal relationship defined only by their data dependencies. The primitives are NOT assumed to be executed in order.</i>   |

|                              |   |
|------------------------------|---|
|                              | <p><i>This is the default operation.</i></p> <p><i>The function will return an error (OMX_StsAdlInvalidCmdErr) if the state is in OMX_ADL_STATE_EXECUTE.</i></p> <p><i>Explicitly setting the state to OMX_ADL_STATE_NONCAUSAL will also lock the command buffer as per OMX_ADL_STATE_LOCK.</i></p>   |
| <i>OMX_ADL_STATE_DEBUG</i>   | <p><i>Enables the debug mode of the aDL engine. When in this mode, the engine will do extra error checking as detailed in the errors section. An aDL state machine may fail to enter the DEBUG state if it is not supported. Such a failure must be reported via the OMXResult of the omxaDL_CONTROL API (OMX_StsAdlNoDebugErr).</i></p>  |
| <i>OMX_ADL_STATE_NODEBUG</i> | <p><i>Disables the debug state</i></p>  |
| <i>OMX_ADL_CMD_CREATE</i>    | <p><i>Initializes a new handle. Depending on the implementation, this may allocate memory to associate with the handle pointer. The state associated with a new handle is implicitly OMX_ADL_STATE_STOP and OMX_ADL_STATE_UNLOCK.</i></p>   |
| <i>OMX_ADL_CMD_FREE</i>      | <p><i>Frees all data associated with a handle and set the handle value to NULL. Freeing the handle implies a machine stop (OMX_ADL_STATE_STOP) and implies that all currently executing aDL function outputs are not valid.</i></p>   |
| <i>OMX_ADL_STATE_STOP</i>    | <p><i>This attempts to stop the execution of an aDL group. STOP is not guaranteed to end execution and data is not guaranteed to be valid when STOP is called.</i></p>  |
| <i>OMX_ADL_CMD_STATUS</i>    | <p><i>Returns a value of '1' if the data represented is valid (e.g. NOT in OMX_ADL_STATE_EXECUTE). This command does not change the aDL state. This command will return a '1' if the state machine is stopped and does guarantee the validity of the function outputs if the machine was stopped during execution. If errors are encountered while executing the command buffer the error will be</i></p> |

|                              |   |
|------------------------------|---|
|                              | <i>returned once execution has stopped instead of '1'.</i>  |
| <i>OMX_ADL_STATE_EXECUTE</i> | <i>This initiates the execution of the asynchronous state machine. All state set during execution will NOT effect currently running primitives and will generate an OMX_StsAdlInvalidCmdErr error.<br/>Explicitly setting the state to OMX_ADL_STATE_EXECUTE will also lock the command buffer as per OMX_ADL_STATE_LOCK.<br/><br/>NOTE: Some synchronous (i.e. non-threaded) implementations may choose to block until execution is complete when this state is set.</i> |
| <i>OMX_CMD_RESET_BUFFERS</i> | <i>All auto-incrementing buffers (as designated in omxaDL_RegisterIndex) are set to their original address values.</i>  |
| <i>OMX_ADL_STATE_LOCK</i>    | <i>Explicitly locks the command buffer. Attempting to add additional primitives to a locked buffer will result in a OMX_StsAdlLockErr error and no modification to the state or command buffer.</i>   |
| <i>OMX_ADL_STATE_UNLOCK</i>  | <i>Unlocks the command buffer so that more commands may be added. Attempting to unlock while in OMX_ADL_STATE_EXECUTE will return an error (OMX_StsAdlInvalidCmdErr).</i>   |

## Return Value

OMXRESULT - Conveys error values if less than '1' and if the state machine is in a non-executing state. '1' represents a non-execution state if the STATUS command is used. The value is '0' otherwise.

### 7.1.3.2 omxaDL\_RegisterIndex

#### Name

omxaDL\_RegisterIndex

Associate a data buffer and configuration options with a parameter index with an aDL context.

#### C Prototype

```
OMXResult omxaDL_RegisterIndex( OMX_PTR pHandle, OMX_PTR pBuffer,
                                OMX_INT index, OMX_PTR pIncrement ,OMX_U32 flags );
```

## Parameters

|            |   |
|------------|---|
| pHandle    | Void pointer identifier for asynchronous context.   |
| pBuffer    | Data buffer associated with the aDL parameter index.  |
| index      | Parameter index for exchanging data between primitives.   |
| pIncrement | Address offset that is added to the pBuffer address after each aDL execution.   |
| flags      | Configurable options associated with a parameter index. These options (see Table 2) are signified by binary switches in the flags variable. The value of the flags variable can be generated by ORing desired option macros together. |

## Description

This function controls the association of parameter indices and buffers for aDL chain inputs and outputs.

**Table 2 - RegisterIndex Flag Settings**

| Flag                          | Description   |
|-------------------------------|---|
| <i>OMX_ADL_FLAG_INPUT</i>     | <i>'1' Signifies the data in the buffer is valid for input into an aDL chain parameter. Subsequent calls to register an Input buffer with the same index are ignored unless set as Immediate.</i>             |
| <i>OMX_ADL_FLAG_OUTPUT</i>    | <i>'1' Signifies the buffer must be valid at the end of an aDL chain execution. '0' Signifies do not care. All buffers set as the Output for an index will contain the same data unless set as Immediate.</i> |
| <i>OMX_ADL_FLAG_IMMEDIATE</i> | <i>'1' Signifies that buffer is directly relevant to its position in the chain. When calling with respect to an input on an existing index (signified via the input flag), the new buffer overrides the</i>   |

|                               |   |
|-------------------------------|---|
|                               | <p><i>existing buffer associated with that index from that point on in the chain. When calling with respect to an output on an existing index (signified via the output flag), the position relative data should be copied from the existing buffer associated with the index into the new buffer in the omxaDL_RegisterIndex call.</i></p> |
| <i>OMX_ADL_FLAG_VOLATILE</i>  | <p><i>'1' Signifies the buffer value may change during aDL chain executions. '0' Signifies it will never change. Implementations will only access volatile buffers once (in order) per input per execution.</i></p>   |
| <i>OMX_ADL_FLAG_FIXEDDATA</i> | <p><i>'1' Signifies the data in a buffer will never change.</i></p>   |
| <i>OMX_ADL_FLAG_READONLY</i>  | <p><i>'1' Signifies the buffer may not be written into. Setting a buffer as both an output and read only will cause RegisterIndex to fail with an OMX_StsAdlInvalidCmd Err error.</i></p>   |

## Return Value

OMXRESULT - Values less than '0' signify an error.

### 7.1.3.3 Parameter Controls

The structures of the aDL data types contain additional information that allows the user to control the flow of data between the primitives. All DL types are converted to aDL types as follows:

```
typedef struct OMX_ADL<DL_TYPE_NAME><P if a pointer>
{
  <DL_TYPE > <* if pointer>data or pData;
```



```

    OMX_S32index;
} OMX_ADL<DL_TYPE_NAME><P if a pointer>;

```

If the name does not start with “OMX\_”:

```

typedef struct OMXADL <DL_TYPE_NAME><P if a pointer>
{
    <DL_TYPE > <* if pointer>data or pData;
    OMX_S32index;
} OMXADL <DL_TYPE_NAME><P if a pointer>;

```

### Example:

```

typedef struct OMX_ADLS16P
{
    OMX_S16 *pData;
    OMX_S32 index;
} OMX_ADLS16;

typedef struct OMX_ADLRESULTP
{
    OMXRESULT *pData;
    OMX_S32 index;
} OMX_ADLS16;

typedef struct OMX_ADLINT
{
    OMX_INT data;
    OMX_S32 index;
} OMX_ADLS16;

typedef struct OMXADLRect
{
    OMXRect data;
    OMX_S32 index;
} OMXADLRect;

```

The data/pData field is defined as the data normally associated with a parameter. If the data is a pointer and is set to NULL, the implementation assumes the data is not needed by the user (in the case of an output), provided by an earlier primitive in the chain (in the case of an input), or provided by means of omxaDL\_RegisterIndex(). If not provided earlier in the chain, it is assumed that the NULL value is the intended value for the primitive’s argument.

The ‘index’ field designates which other parameter in the chain that the variable is linked to. Providing the same index to an output parameter of one aDL primitive and to an input parameter of a subsequent aDL primitive, will notify the implementation that the data should be passed between the two. Two parameters in the same function call must not have the same index, unless the index is of value ‘0’. If ‘0’, the implementation assumes the value is singular and not needed by the rest of the chain. All function output arguments with an index of ‘0’ are not guaranteed to be valid after execution (data/pData may not be used to store the results and pData can be set to NULL to explicitly signify the output data is not needed). For all other values, the data/pData field is ignored if the index is

present earlier in the chain. Index values used once and only once on an output argument of a function are implicitly outputs of the chain (as if flagged as an output by a `omxaDL_RegisterIndex()` call). Lastly, any linked set of variables must be of the same type with the exception of dereferenced variables. If a '`<TYPE_NAME>P`' variable is used before a '`<TYPE_NAME>`' variable with the same index, the second variable is implicitly dereferenced.

## 7.1.4 Errors

All implementations are required to return the following errors regardless of debugging state.

| <i>Error</i>                   | <i>Description</i>   |
|--------------------------------|--|
| <i>OMX_StsAdlLockErr</i>       | <i>Failed command insertion due to the command buffer being locked.</i>  |
| <i>OMX_StsAdlFailedLockErr</i> | <i>Failed state transition due to the inability of the implementation to lock the command buffer. This could be from a failed compilation, invalid chain, invalid data, etc.</i> |
| <i>OMX_StsAdlInvalidCmdErr</i> | <i>Failed command due to incompatibility with the current state.</i>   |
| <i>OMX_StsAdlResourceErr</i>   | <i>Failed state transition due to the inability of the implementation to secure appropriate resources or because the resources were lost while executing.</i>                    |
| <i>OMX_StsAdlNoDebugErr</i>    | <i>Returned when setting the state to debug mode if the implementation does not support it.</i>  |
| <i>OMX_StsAdlExecErr</i>       | <i>A fatal error was encountered while executing.</i>  |
| <i>OMX_StsAdlInvalidHandle</i> | <i>The handle passed into the call is invalid or corrupt.</i>  |
| <i>OMX_StsAdlErr</i>           | <i>Fatal error catchall</i>  |

Implementations that support the debug state must return the following errors when in that state. These errors may be optionally returned in the 'nodebug' state.

| <i>Debug Message</i>            | <i>Description</i>   |
|---------------------------------|--|
| <i>OMX_StsAdlInvalidDataErr</i> | <i>Data passed into a primitive is not in the correct format</i> |

|                                    |  |
|------------------------------------|--|
| <i>OMX_StsAdlInvalidPathErr</i>    | <i>Reported in I/O mismatches and recursive paths</i>  |
| <i>OMX_StsAdlInvalidParamErr</i>   | <i>Catch all error for other parameter related issues.</i>   |
| <i>OMX_StsAdlMemResourceErr</i>    | <i>Unable to secure memory resources or lost during execution.</i>   |
| <i>OMX_StsAdlExecResourceErr</i>   | <i>Unable to secure execution resources or lost during execution.</i>  |
| <i>OMX_StsAdlLostConnectionErr</i> | <i>Special loss of resources or state due to losing connection to those resources (possibly caused by loss power).</i> |

## 7.1.5 Example of Utilization

The aDL is a context based API that processes DL primitives in a user defined order. Once initialized, a handle references an empty group of primitives and their associated state. By calling an aDL function with the handle as an argument, the user pushes the associated primitive into the handle's command buffer. The order of execution is defined by the order of insertion and data dependencies. The data paths themselves are established by use of the `omxaDL_RegisterIndex()` function or implicit use of indices in function parameters. The following pieces of example code strive to illustrate these concepts for the user.

### aDL Code Examples

#### 7.1.5.1 Simple Example

```

OMX_PTR pHandle_chain1 = NULL;
OMX_BOOL bDoneRunning = FALSE;

/* Build a new chain */
if( omxaDL_Control( &pHandle_chain1, OMX_ADL_STATE_CREATE) >=0)
{
    omxaXYZ_API_A(.., pHandle_chain1); /* Push API_A into the
command buffer*/
    omxaXYZ_API_B(.., pHandle_chain1); /* Push API_B into the
command buffer*/
    omxaXYZ_API_C(.., pHandle_chain1); /* Push API_C into the
command buffer*/
    omxaXYZ_API_D(.., pHandle_chain1); /* Push API_D into the
command buffer*/
}

```

```

}
else
{
    /* ERROR */
    exit();
}

/* This line explicitly locks the FIFO */
/* This is not absolutely necessary as it is inferred in the
execution, but an explicit call allows the implementation to
optimize the command buffer before execution. */
omxaDL_Control( &pHandle_chain1, OMX_ADL_STATE_LOCK);

/* Run the chain */
omxaDL_Control( &pHandle_chain1, OMX_ADL_STATE_EXECUTE);

/* Run other code until the data is ready */
do
{
    /* Other Code*/

    if( omxaDL_status( pHandle_chain1, &bDoneRunning) < 0)
    {
        /* ERROR */
        exit();
    }
} while(!bDoneRunning);

/* Or just block until the data is ready */
if( omxaDL_Control( &pHandle_chain1, OMX_ADL_STATE_BLOCK) < 0)
{
    /* ERROR */
    exit();
}

/* When done with the primitive block ... free the aDL state
resources*/
omxaDL_control( &pHandle_chain1, OMX_ADL_STATE_FREE);
pHandle_chain1 = NULL;

```

### 7.1.5.2 RegisterIndex Setup Example

```
omxaVCM4P2_DCT8x8blk(  
    OMX_ADRESULTP pResult,  
    OMX_ADLS16P *pSrc,  
    OMX_ADLS16P *pDst  
    OMX_PTR handle);  
  
omxaVCM4P2_QuantInter_I(  
    OMX_ADRESULTP pResult,  
    OMX_ADLS16P *pSrcDst,  
    OMX_ADLU8 QP,  
    OMX_PTR handle);  
  
#define INTDONTCARE(x) (OMX_ADLINT){ x, 0}  
#define U8DONTCARE(x) (OMX_ADLU8){ x, 0}  
#define U8PDONTCARE(x) (OMX_ADLU8P){ x, 0}  
#define RESULTDONTCARE (OMX_ADRESULTP){NULL,0}  
#define S16PINDEX(x) (OMX_ADLS16P){NULL,x}  
  
{  
    /* Setup the source buffer for the first function in the chain  
    (DCT) and increment the buffer address with each execution. */  
    omxaDL_RegisterIndex(pHandle_chain1, (OMX_PTR)pDCTSrcBuf, 1,  
    0x000000FF , OMX_ADL_FLAG_INPUT );  
  
    /* Setup the destination buffer for the last function in the  
    chain (Quant) and increment the buffer address with each  
    execution. */  
    omxaDL_RegisterIndex(pHandle_chain1, (OMX_PTR)pQuantDstBuf, 2,  
    0x000000FF , OMX_ADL_FLAG_OUTPUT );  
  
    /* Add DCT to the command buffer with two data streams (one  
    input and one output) */  
    omxaVCM4P2_DCT8x8blk( RESULTDONTCARE, S16PINDEX( 1 ), S16PINDEX( 2  
    ), pHandle_chain1);  
  
    /* Copy the DCT result out into a separate buffer before it is  
    utilized by the inplace quant function. */  
    omxaDL_RegisterIndex(pHandle_chain1,  
    (OMX_PTR)pDCTOutputCopyBuf, 2, 0x000000FF , OMX_ADL_FLAG_OUTPUT  
    | OMX_ADL_FLAG_IMMEDIATE );  
  
    /* Add Quant to the command buffer with one inplace stream*/  
    omxaVCM4P2_QuantInter_I( RESULTDONTCARE, S16PINDEX( 2 ),  
    U8DONTCARE(QP), pHandle_chain1);  
  
    /* Perform execution and codec work */  
}
```

### 7.1.5.3 Concurrent Chains Example

```
/* aDL sample code for running ME in parallel with quantization,
   transform, inverse transform and inverse quantisation */

OMX_PTR pHandle_chain_ME = NULL;
OMX_PTR pHandle_chain_TQIQIT = NULL;
OMX_BOOL bDoneRunning = FALSE;

OMX_ADLU8P MESrc = U8PDONTCARE(pSrcRefBuf);
OMXADLRectP MERefRect = RECTPDONTCARE(pRefRect);
OMX_ADLU8P MESrcCurrBuf = U8PDONTCARE(pSrcCurrBuf);
OMXADLVCM4P2CoordinateP MECurrPointPos =
COORDPDONTCARE(pCurrPointPos);
OMXADLVCMotionVectorP MESrcPreMV = MVPDONTCARE(pSrcPreMV);
OMX_ADLINT MESrcPreSAD = INTPDONTCARE(pSrcPreSAD);
OMX_ADLPTR MEState = PTRDONTCARE(pState);
OMXADLVCM4P2MacroblockType MEDstMBType = {pDstMBType , 1};
OMXADLVCMotionVector MEDstMV = {pDstMV , 2};
OMX_ADLINT MEDstSAD = {pDstSAD , 3};
OMX_ADLRESULTP ResultDontCare = {NULL , 0};

/* Set up of ME chain in parallel */
if( omxaDL_control( &pHandle_chain_ME, OMX_ADL_STATE_CREATE)
>=0)
{
    omxaVCM4P2_MotionEstimationMB (ResultDontCare, &MESrc,
INTDONTCARE(RefWidth), &MERefRect, &MESrcCurrBuf,
&MECurrPointPos, &MESrcPreMV, &MESrcPreSAD, INTDONTCARE(rndVal),
INTDONTCARE(searchRange), &MEState, &MEDstMBType, &MEDstMV,
MEDstSAD, pHandle_chain_ME);
}
else
{
    /* Error */
}

/* Set up of Transform and Quantisation, Inverse Transform
   and Inverse Quantisation chain */
OMX_ADLS16P TRBSrc = S16PDONTCARE(pSrc);
OMX_ADLS16P TRBDst = {pDst, 1};
OMX_ADLS16P TRBRec = {pRec, 5};

OMX_ADLS16P QISrc = {NULL, 1};

OMX_ADLS16P IDCTSrc = {NULL , 1};
OMX_ADLS16P IDCTDst = {pEndDst , 2};
```

```

if( omxaDL_control( &pHandle_chain_TQIQIT,
OMX_ADL_STATE_INITIALIZE) >=0)
{
    omxaVCM4P2_TransRecBlockCeof_inter(ResultDontCare, &TRBSrc,
&TRBDst, &TRBRec), U8DONTCARE(QP), &TRBMatrix,
pHandle_chain_TQIQIT);
    omxaVCM4P2_QuantInvInter(ResultDontCare, &QISrc,
INTDONTCARE(QP), &QIMatrix, pHandle_chain_TQIQIT);
    omxaVCM4P2_IDCT8x8blk(ResultDontCare, &IDCTSrc, &IDCTDst,
pHandle_chain_TQIQIT);
}
else
{
    /* ERROR */
}

/* Run the two chains */
omxaDL_control( &pHandle_chain_ME, OMX_ADL_STATE_EXECUTE);
omxaDL_control( &pHandle_chain_TQIQIT, OMX_ADL_STATE_EXECUTE);

/* Wait for the two chain to finish */
omxaDL_control( &pHandle_chain_ME, OMX_ADL_STATE_BLOCK);
omxaDL_control( &pHandle_chain_TQIQIT, OMX_ADL_STATE_BLOCK);

/* Free up the aDL resources*/
omxaDL_control( &pHandle_chain_ME, OMX_ADL_STATE_FREE);
omxaDL_control( &pHandle_chain_TQIQIT, OMX_ADL_STATE_FREE);
pHandle_chain_ME = NULL;
pHandle_chain_TQIQIT = NULL;

```

## 7.2 Integrated DL (iDL)

### 7.2.1 Overview

The Integrated Development Layer (iDL) API enables DL functionality in a concurrent execution environment by merging the DL API with the higher level Integration Layer (IL) API. This enables users to take advantage of a wider range of architectures while using the known asynchronous interface of the IL state machine. The iDL API defines a set of rules for converting the DL primitives into IL interface structures. Those structures are then added to the existing set of IL structures and controlled via the existing IL APIs.

Generally, developers will use iDL as a tool to target specific asynchronous behavior provided by a platform vendor. This may be used to benefit existing codecs, but is most optimally used when considered in the codec design. The behavior and ordering of DL functionality is specific to an iDL component for better resource utilization and performance optimizations within the system (coupled hardware, etc.) Developers will need to determine how the

optimization and portability trade-offs inherent in the platform's iDL based components will impact their codec.

## 7.2.2 Upgrading a DL codec to an iDL codec

5. The DL APIs name is used only in connection with an IL port configuration structure.
  - a. This maintains an obvious and evident link to the DL API
  - b. The DL configuration structure maintains the same parameter set as the DL API although data input and output is not used in iDL based components. Data for the primitives are passed through other component ports as defined by the component documentation.
6. All DL function parameters are replaced with their iDL type counterparts.
7. Multiple iDL calls can be externally configured through a single IL input port. The internal iDL chaining topology is described in the associated component documentation.
  - a. Data buffers fed into the first iDL in an IL component may be structured as specified by standard IL configuration structures but may be internally broken down and processed with DL specified granularities.
  - b. Codecs may be broken into one or multiple iDL based IL components.

### Example:

```
/* DL API */
OMXResult omxVCM4P2_QuantInter_I(
    OMX_S16 *pSrcDst,
    OMX_U8 QP);

/* iDL Configuration Structure */
typedef struct OMX_iDL_PARAM_VCM4P2_QuantInter_I {
    OMX_S16 *pSrcDst,
    OMX_U8 QP)
}OMX_iDL_PARAM_VCM4P2_QuantInter_I;
```

## 7.2.3 iDL Concurrent Execution

The iDL functions can be linked together within an IL component to form a chain of iDL configurable functions. The length of this chain can be from 1 iDL function to many iDL functions. The sequencing of the chain of functions is based on IL component documentation. Concurrency can be enabled within an IL component or by splitting a codec into multiple IL components based on concurrency requirements and connecting them. iDL relies on the IL API for execution control. If pre-buffering is required for a group of iDLs, this group can be split into a separate IL component.

## 7.2.4 Errors

iDL based components utilize IL error codes.



## 7.2.5 Example of Utilization

The iDL port configuration structures enable DL based codec configurations to be ported to IL based codecs where the use of IL configuration structures and codecs is clearly described in the OpenMAX IL 1.0 specification. The following code exemplifies how an IL component containing a single DL function would be initialized and operated. For a component containing multiple DL functions, the connectivity between DL functions must also be specified with the component documentation. Dynamic reconfiguration of DL functions is not specified for 1.0.

```
/*
This Sample code does the following:
1. Loads the component
2. Initializes a new port configuration structure on the
component's input port
3. Sets the quantization parameter for the internal DL function
and ignores the other data pointers
4. Puts the component into the IDLE state
5. Puts the component in to the Execute state
6. Send the component a normal data buffer using Empty This
buffer

It should be noted that for this example, the following would be
included with the component documentation:

This component comprises a single DL function
(VCM4P2_QuantInter_I) the pSrcDst data for this function is
excracted from data received from the IL input port and the
reluting data is written to the IL data output port.

*/

/* assuming we have the following struct
typedef struct OMX_iDL_PARAM_VCM4P2_QuantInter_I {
    OMX_S16 *pSrcDst,
    OMX_U8 QP,
}OMX_iDL_PARAM_ VCM4P2_QuantInter_I;

defined as following struct in OMX_Video.h
OMX_VIDEO_PARAM_VCM4P2

and following index in OMX_Index.h
OMX_IndexParamVideoVCM4P2

*/

sample_client_code(){

    OMX_VIDEO_PARAM_VCM4P2 sVCM;
    OMX_BUFFERHEADERTYPE *pBufferHdr = NULL;

    /* load component */
```

```

    OMX_Init();
    OMX_GetHandle(&hComp, cComponentName, pWrappedAppData,
pWrappedCallbacks);

    /* get all video ports */
    OMX_GetParameter(hComp, OMX_IndexParamVideoInit,
(OMX_PTR)&sPortParam);

    /* set the image width */
    OMX_GetParameter(hComp, OMX_IndexParamVideoVCM4P2,
(OMX_PTR)&sVCM);
    sVCM.QP = QPvalue;
    OMX_SetParameter(hComp, OMX_IndexParamVideoVCM4P2,
(OMX_PTR)&sVCM);

    /* command to idle state */
    OMX_SendCommand(hComp, OMX_CommandStateSet, OMX_StateIdle,
0);

    /* allocate buffers */
    for(i = sPortParam.nStartPortNumber; i <
sPortParam.nStartPortNumber + sPortParam.nPorts; i++)
    {
        sPortDef.nPortIndex = i;
        OMX_GetParameter(hComp, OMX_IndexParamPortDefinition,
(OMX_PTR)&sPortDef);

        for (j = 0x0; j < sPortDef.nBufferCountActual; j++)
        {
            OMX_AllocateBuffer(hComp, &pBufferHdr,
sPortDef.nPortIndex, 0, sPortDef.nBufferSize);
            PSEUDO_Add_Buffer_To_Internal_List(pBufferHdr);
        }
    }

    PSEUDO_Wait_For_Transition_Event();

    /* command to executing state */
    OMX_SendCommand(hComp, OMX_CommandStateSet,
OMX_StateExecuting, 0);
    PSEUDO_Wait_For_Transition_Event();

    /* process buffers */
    PSEUDO_Do_For_All_Output_Buffers{
        PSEUDO_Read_Buffer_From_Internal_List(pBufferHdr);
        OMX_FillThisBuffer(hComp, pBufferHdr);
    }

    PSEUDO_Do_For_All_Input_Buffers{
        PSEUDO_Read_Buffer_From_Internal_List(pBufferHdr);
        OMX_EmptyThisBuffer(hComp, pBufferHdr);
    }

```

```
    }  
    PSEUDO_Cleanup();  
}
```

# *A Optional Extensions (DLx)*



---

## **A.1 Overview**

This appendix defines the function set that comprises the DL extension API ("DLx").

### **A.1.1 Purpose**

The information contained in this appendix is provided for reference only. In certain cases it may provide a preview of functions that may appear in an unspecified future revision of the DL specification.

### **A.1.2 Scope**

The information contained in this appendix is outside the scope of the DL specification. All definitions associated with the DLx API are subject to change at any time without notice.

### **A.1.3 Compliance**

The DLx API defines an optional set of functions. Implementation of the DLx API is neither required nor recommended in the context of OpenMAX DL compliance.

## **A.2 Image Processing, Pre-Processing/Post-Processing Sub-Domain (omxIPPP) and Color Space Conversion Sub-Domain (omxIPCS)**

### **A.2.1 Data Structures**

#### **A.2.1.1 OMXIPCSGammaTableType**

An enumerator that defines gamma table types for the raw pixel processing function is defined as follows:

```
typedef enum
{
    OMX_IPCS_GAMMA_TABLE_COMBINED_DEFAULT = 0, /* Combined R+G+B table,
                                                default */

```

```

    OMX_IPCS_GAMMA_TABLE_COMBINED_EXTERN = 1,    /* Combined R+G+B table,
                                                    external */
    OMX_IPCS_GAMMA_TABLE_DISCRETE_DEFAULT = 2,   /* Discrete R/G/B table,
                                                    default */
    OMX_IPCS_GAMMA_TABLE_DISCRETE_EXTERN = 3,   /* Discrete R/G/B table,
                                                    external */
} OMXIPCSGammaTableType;

```

### A.2.1.2 OMXIPCSRawPixProcCfg\_P3R

Application-specific information used to configure the raw pixel processing function, including source and destination image plane dimensions, color synthesis interpolation methodology, rotation control, and target color space control parameters are stored in a structure defined as follows:

```

typedef struct
{
    OMX_INT srcStep;           /** Distance, in bytes, between the start of lines
                                in the source image */
    OMXSize srcSize;          /** Dimensions, in pixels, of the source regions of
                                interest */
    OMX_INT dstStep[3];       /** A 3-element vector containing the distance, in
                                bytes, between the start of lines in each of the
                                output image planes */
    OMXSize dstSize;          /** Dimensions, in pixels, of the output source
                                regions of interest */
    OMXIPInterpolation interpolation; /** Interpolation method used for CFA
                                interpolation and resizing */
    OMXIPRotation rotation;   /** Rotation control parameter */
    OMXIPColorSpace colorConversion; /** Color conversion control parameter */
} OMXIPCSRawPixProcCfg_P3R;

```

### A.2.1.3 OMXIPCSRGBBSensorCfg

Image sensor-related information used to configure the raw pixel processing function, including sensor bit depth, gamma tables, dead pixel map, dead pixel interpolation methodology, and a color correction matrix, are stored in a structure defined as follows:

```

typedef struct
{
    OMX_INT BitDepth; /** Bit depth of the input raw data
                        * Typically 8, 9, or 10 bits */
    OMXIPCSGammaTableType GammaFlag; /** Indicates the type of gamma table
    OMX_INT GammaIndex[3]; /** Indicates the index of predefined gamma tables

```

```

        * when GammaFlag set to predefined options*/
    OMX_U8 *pGammaTable[3]; /** A 3-element vector containing the pointer to the
gamma tables for R/G/B respectively when GammaFlag set to application-specific
option */

    OMX_U32 *pDeadPixMap; /** Pointer to the start of the absolute Dead
        * Pixel Map of the sensor array */

    OMX_INT DPMLen; /** Length, in pixels, of the Dead Pixel Map */
    OMXPoint DPMOffset; /** Offset of start position of the cropping
        * window, from the (0,0), DPMOffset.x is the row
offset
        * and DPMOffset.y is the column offset */
    OMXIPInterpolation DPInterp; /** Interpolation method used for dead pixel
        *substitution */
    OMX_S16 *pCCMatrix; /** Color correction Matrix */
} OMXIPCSRGGBSensorCfg;

```

#### A.2.1.4 OMXIPCSRawPixProcSpec\_P3R

A vendor-specific data type used to maintain the raw pixel processing function state is defined as follows:

```
typedef void OMXIPCSRawPixProcSpec_P3R;
```

### A.2.2 Functions, omxIPCS Sub-Domain

#### A.2.2.1 Raw Pixel Processing

##### A.2.2.1.1 RGGbtoYCbCrGetBufSize

##### A.2.2.1.2 RGGbtoYCbCrInit

##### A.2.2.1.3 RGGbtoYCbCr\_RotRsz\_8u\_P3R

#### Prototype

```

OMXResult omxIPCS_RGGbtoYCbCrGetBufSize_DLx(const OMXIPCSRGGBSensorCfg
    *pCAMCfg, const OMXIPCSRawPixProcCfg_P3R *pRPPCfg, OMX_INT *pSize);
OMXResult omxIPCS_RGGbtoYCbCrInit_DLx(const OMXIPCSRGGBSensorCfg *pCAMCfg,
    const OMXIPCSRawPixProcCfg_P3R *pRPPCfg, OMXIPCSRawPixProcSpec_P3R
    *pRPPSpec);

```

```
OMXResult omxIPCS_RGGBtoYCbCr_RotRsz_U8_P3R_DLx(OMX_U8 *pSrc, OMX_U8
*pDst[3], OMXIPCSRawPixProcSpec_P3R *pRPPSpec);
```

## Description

The raw pixel processing functions convert raw RGGB pixel data to YCbCr422/420 planar data using the following sequence of operations: optional dead pixel correction, companding and gamma correction, optional scale reduction, color synthesis, color correction, color conversion, and optional rotation.

The color synthesis methodology is a function of the specified resize ratio. Three cases are possible: a) no scale reduction, b) 2:1 scale reduction, or c) 4:1 scale reduction

### a. No scale reduction

Bilinear interpolation is applied. Missing colors are synthesized by averaging the nearest neighbor pixel intensities of the same color, possibly as shown in the figure below.

|   | 0 | 1 | 2 | 3 | 4 | 5 |
|---|---|---|---|---|---|---|
| 0 | R | G | R | G | R | G |
| 1 | G | B | G | B | G | B |
| 2 | R | G | R | G | R | G |
| 3 | G | B | G | B | G | B |
| 4 | R | G | R | G | R | G |
| 5 | G | B | G | B | G | B |

$$G_{2,2} = \frac{G_{1,2} + G_{2,1} + G_{2,3} + G_{3,2}}{4}$$

$$B_{2,2} = \frac{B_{1,1} + B_{1,3} + B_{3,1} + B_{3,3}}{4}$$

$$R_{2,3} = \frac{R_{2,2} + R_{2,4}}{2}$$

$$B_{2,3} = \frac{B_{1,3} + B_{3,3}}{2}$$

$$R_{3,2} = \frac{R_{2,2} + R_{4,2}}{2}$$

$$B_{3,2} = \frac{B_{3,1} + B_{3,3}}{2}$$

### b. 2:1 scale reduction

R, G and B values for one output pixel are calculated from values of four adjacent source pixels (2\*2 block of RGGB). R and B values are set equal to the values of the nearest red and blue pixels, while G is set equal to the average of the two nearest green pixels, possibly as shown in the figure below.

|  |   |
|--|---|
| $\begin{matrix} R_x & G_1 & R_x & G_1 \\ G_2 & B & G_2 & B \\ R_x & G_1 & R_x & G_1 \\ G_2 & B & G_2 & B \end{matrix}$ | $\begin{matrix} R_x = R \\ G_x = \frac{G_1 + G_2}{2} \\ B_x = B \end{matrix}$ |
|--|---|

2:1 downscale

### c. 4:1 scale reduction

A possible approach is shown in the figure below.

|  |   |
|--|---|
| $\begin{matrix} R & G & R & G \\ G & B & G_1 & B \\ R & G_2 & R & G \\ G & B & G & B \end{matrix}$ | $\begin{matrix} R_x = R \\ G_x = \frac{G_1 + G_2}{2} \\ B_x = B \end{matrix}$ |
|--|---|

4:1 downscale

The color space conversion is computed as follows:

$$Y = 0.29900 * R + 0.58700 * G + 0.11400 * B$$

$$Cb = -0.16874 * R - 0.33126 * G + 0.50000 * B + 128$$

$$Cr = 0.50000 * R - 0.41869 * G - 0.08131 * B + 128$$

The initialization function `<omxIPCS_RGGBtoYCbCrInit>` should be called prior to `<omxIPCS_RGGBtoYCbCr_RotRsz_U8_P3R>` in order to initialize the raw data processing state structure.

## Input Arguments

- `pSrc` – pointer to the start of the buffer containing the pixel-oriented RGGB input image. The input image buffer referenced by `pSrc` must contain one pixel of padding on all four edges; ie the buffer size should be equal to the image height+2 by the image width+2. `pSrc` should point to the start to the ROI but not the start of the padding region.
- `pCAMCfg` – pointer to the sensor-specific configuration structure
- `pRPCCfg` – pointer to the application-specific configuration structure
- `pRPPSpec` – pointer to the implementation-specific state structure

## Output Arguments

- `pDst` – a 3-element vector containing pointers to the start of the YCbCr422/YCbCr420 output planes
- `pSize` – pointer to the variable to hold the structure size.

## Returns

- If the function runs without error, it returns `OMX_Sts_NoErr`
- If one of the following cases occurs, the function returns `OMX_Sts_BadArgErr`:
  - Any of the below pointer is NULL:  
`pSrc`, `pDst[0]`, `pDst[1]`, `pDst[2]`, `pCAMCfg`, `pRPCCfg`, `pRPPSpec` `pCAMCfg` or `pRPCCfg` contains invalid values.  
`pDst[0]`, `pDst[1]` or `pDst[2]` does not match the corresponding alignment requirement. Refer to the following table for alignment requirement details.
  - For `pCAMCfg`, following cases are invalid:
    - `BitDepth != 10`.
    - Invalid values for enumerated parameter `GammaFlag`
    - When `GammaFlag` is specified as `OMXGamPreOneTable`, `GammaIndex[0]` is not between 0~1
    - When `GammaFlag` is specified as `OMXGamCusOneTable`, `pGammaTable[0]` is NULL
    - `GammaFlag` is specified as `OMXGamPreThreeTable` or `OMXGamCusThreeTable`
    - When `pDeadPixMap` is not NULL, `DPMLen<=0` or `DPMOffset.x<0` or `DPMOffset.y<0`.
    - `DPIinterp != omxCameraInterpNearest`
    - `pCCMatrix` is NULL.
  - For `pRPCCfg`, the following cases are invalid:
    - For no-resizing cases, `srcSize.width` or `srcSize.height` is less than 2
    - For 2:1 and 4:1 scale down cases, `srcSize.width` is less than 4 or `srcSize.height` is less than 2
    - `srcStep` is less than `srcSize.width`, `dstStep[0]` is less than `dstSize.width`,



`dstStep[1]` is less than `dstSize.width/2` or `dstStep[2]` is less than `dstSize.width/2`.

"`dstSize.width` or `dstSize.height` is not even.

- For no resizing cases, `dstStep[0]` is not multiple of 8, `dstStep[1]` is not multiple of 4 or `dstStep[2]` is not multiple of 4.
- `srcSize` is not `dstSize` multiply 1, 2 or 4
- Sizes of the input image and the output image are incompatible with the rotation configuration.
- Invalid values for enumerated parameters: `interpolation`, `rotation`, `colorConversion`.
- For no scale reduction, `interpolation` is not `omxCameraInterpMedian`. For 2:1 and 4:1 scale reduction, `interpolation` is not `omxCameraInterpNearLinear`
- `rotation` is not set to one of the following values: `OMX_IP_DISABLE`, `OMX_IP_ROTATE90L`, `OMX_IP_ROTATE90R`, `OMX_IP_ROTATE180`.
- `colorConversion` is not set to either `OMX_IP_YCBCR422` or `OMX_IP_YCBCR420`.



**Note:** Image buffer requirement: Input RGGG raw data should be arranged as follows: ":R-G-G-B," i.e., the `pSrc(0,0)` should be 'R', `pSrc(0,1)` should be 'G', `pSrc(1,0)` should be 'G', `pSrc(1,1)` should be 'B'.

## Image Size Requirements

The `srcSize.width` and `srcSize.height` must be even. When resizing is applied, the `dstSize.width` should be multiple of 4 and `dstSize.height` should be multiple of 2.

## Alignment Requirements

Alignment requirements are shown in the table. Pointers must meet the alignment requirements, and in addition the corresponding image steps must be a multiple of the pointer alignment.

### Alignment requirements

| Scale Reduction | pDst[0]          |               | pDst[1]          |               | pDst[2]          |               |
|-----------------|------------------|---------------|------------------|---------------|------------------|---------------|
|                 | Alignment (byte) | Offset (byte) | Alignment (byte) | Offset (byte) | Alignment (byte) | Offset (byte) |
| 1:1             | 8                | 0             | 4                | 0             | 4                | 0             |
| 2:1             | 4                | 0             | 2                | 0             | 2                | 0             |
| 4:1             | 4                | 0             | 2                | 0             | 2                | 0             |

## Gamma Correction Requirements

Either predefined or application-specific gamma correction tables can be applied. Moreover, either a single gamma table or three different gamma tables can be applied independently to the R, G and B components.

## Gamma Table Usage

---

| GammaFlag           | Remarks  |
|---------------------|--|
| OMXGamPreOneTable   | GammaIndex[0] must set to a valid predefined gamma table index.                                  |
| OMXGamPreThreeTable | GammaIndex[0], GammaIndex[1] and GammaIndex[2] must set to valid predefined gamma table indices. |
| OMXGamCusOneTable   | pGammaTable[0] must point to a valid table address.  |
| OMXGamCusThreeTable | pGammaTable[0], pGammaTable[1] and pGammaTable[2] must point to valid table addresses.           |

The following table provides the indices of predefined gamma tables.

## Gamma Tables and Indexes

---

| Index | Gamma Correction Formula   | Remarks                       |
|-------|--|-------------------------------|
| 0     | $\gamma = x$   | For linear display.           |
| 1     | $= \begin{cases} 4.5x, & 0 \leq 0.018(x) \\ 1.099x^{0.45} - (0.99, 018 \leq x \leq 1) \end{cases}$ | Rec. 709's transfer function. |

## A.2.3 Functions, omxIPPP Sub-Domain

### A.2.3.1 Dering

#### A.2.3.1.1 Dering\_Luma

##### Prototype

```
OMXResult omxIPPP_Dering_Luma_DLx (const OMX_U8 *pSrc, const OMXSize
    *roiSize, const OMX_U32 srcStep, const OMX_U32 dstStep, const OMX_S16
    *pQuant, OMX_U8 *pDst);
```

##### Description

This filter de-rings a region within the luminance plane of an image. The input and output buffers represent

the luminance color plane of an image, 8-bits per pixel. The output buffer region is required to have the same size as that of the input region, although the width of the overall images may differ.

### Input Arguments

- `pSrc` – pointer to the input buffer
- `roiSize` – the dimensions of the input region in pixels
- `srcStep` – step in bytes through the source image
- `dstStep` – step in bytes through the destination image
- `pQuant` – buffer specifying the quantization factor of each 16x16 block (not used if NULL)

### Output Arguments

- `pDst` – pointer to the output buffer (a single image plane, 8bpp)

### Returns

- Standard OMXResult result. See enumeration for possible result codes.

## A.2.3.1.2 Dering\_Chroma

### Prototype

```
OMXResult omxIPPP_Dering_Chroma_DLx (const OMX_U8 *pSrc, const OMXSize
    *roiSize, const OMX_INT srcStep, const OMX_INT dstStep, const OMX_S16
    *pQuant, OMX_U8 *pDst);
```

### Description

This filter de-rings a region within a chrominance plane of an image. The input and output buffers represent a single chroma color plane of an image, 8-bits per pixel. The output buffer region is required to have the same size as that of the input region, although the width of the overall images may differ.

### Input Arguments

- `pSrc` – pointer to the input buffer (a single image plane, 8bpp)
- `roiSize` – the dimensions of the input region in pixels
- `srcStep` – step in bytes through the source image
- `dstStep` – step in bytes through the destination image
- `pQuant` – buffer specifying the quantization factor of each 16x16 block (not used if NULL)

### Output Arguments

- `pDst` – pointer to the output buffer (a single image plane, 8bpp)

### Returns

- Standard OMXResult result. See enumeration for possible result codes.

## A.3 Image Coding, JPEG Sub-Domain (omxICJP)

### A.3.1 Encoder Functions

#### A.3.1.1 Integrated Forward DCT + Quantization

##### A.3.1.1.1 DCTQuantFwd\_Multiple\_S16\_I

###### Prototype

```
OMXResult omxICJP_DCTQuantFwd_Multiple_S16_I_DLx (OMX_S16 *pSrcDst, OMX_INT  
nBlocks, const OMX_U16 *pQuantFwdTable);
```

###### Description

This function implements forward DCT with quantization for the 8-bit image data. It processes multiple adjacent blocks (8x8). The blocks are assumed to be part of a planarized buffer. This function needs to be called separately for luma and chroma buffers with the respective quantization table. The output matrix is the transpose of the explicit result. As a result, the Huffman coding functions in this library handle transpose as well.

###### Input Arguments

- `nBlocks` – the number of 8x8 blocks to be processed.
- `pQuantFwdTable` – identifies the quantization table that was generated from "DCTQuantFwdTableInit". The table length is 64. This start address must be 8-byte aligned.

###### In-Out Arguments

- `pSrcDst` – Identifies coefficient block(8x8) buffer for in-place processing. This start address must be 8-byte aligned. The input components are bounded on the interval [-128, 127] within a signed 16-bit container. To achieve better performance, the output 8x8 matrix is the transpose of the explicit result. This transpose will be handled in Huffman encoding. Each 8x8 block in the buffer is stored as 64 entries (16-bit) linearly in a buffer, and the multiple blocks to be processed must be adjacent.

###### Returns

- Standard OMXResult result. See enumeration for possible result codes.

## A.3.2 Decoder Functions

### A.3.2.1 Integrated Inverse Quantization + Inverse DCT

#### A.3.2.1.1 DCTQuantInv\_Multiple\_S16\_I

##### Prototype

```
OMXResult omxICJP_DCTQuantInv_Multiple_S16_I_DLx (OMX_S16 *pSrcDst, OMX_INT  
    nBlocks, const OMX_U16 *pQuantInvTable);
```

##### Description

This function implements inverse DCT with dequantization for 8-bit image data. It processes multiple blocks (each 8x8). The blocks are assumed to be part of a planarized buffer. This function needs to be called separately for luma and chroma buffers with the respective quantization table. The start address of `pQuantRawTable` and `pQuantInvTable` must be 8-byte aligned.

##### Input Arguments

- `nBlocks` – the number of 8x8 blocks to be processed.
- `pQuantInvTable` – identifies the quantization table which was generated from "DCTQuantInvTableInit\_JPEG\_U8\_U16". The table length is 64 entries by 16-bit. The start address must be 8-byte aligned.

##### In-Out Arguments

- `pSrcDst` – identifies input coefficient block(8x8) buffer for in-place processing. The start address must be 8-byte aligned.

##### Returns

- Standard OMXResult result. See enumeration for possible result codes.

## A.4 Image Coding, JPEG2K Sub-Domain (omxICJP2K)

### A.4.1 Encoder/Decoder Functions

#### A.4.1.1 Discrete Wavelet Transform Helper

##### A.4.1.1.1 WTGetBufSize\_B53\_S16\_C1IR

##### Prototype

```
OMXResult omxICJP2K_WTGetBufSize_B53_S16_C1IR_DLx (const OMXRect *pTileRect,  
    OMX_INT *pSize);
```

## Description

Get the buffer size (in bytes) for one-level 2D forward and inverse wavelet transformation on an image tile of 16-bit data using 5-3 reversible filter.

## Input Arguments

- `pTileRect` – pointer to an OMXRect data structure, which indicates the position and size of the image tile.

## Output Arguments

- `pSize` – pointer to an integer of size of the internal buffer used by 2D 5-3 wavelet transformation.

## Returns

Standard OMXResult result. See enumeration for possible result codes.

### A.4.1.1.2 WTGetBufSize\_B53\_S32\_C1IR

## Prototype

```
OMXResult omxICJP2K_WTGetBufSize_B53_S32_C1IR_DLx (const OMXRect *pTileRect,  
    OMX_INT *pSize);
```

## Description

Get the buffer size (in bytes) for both one-level 2D forward and inverse wavelet transformation on an image tile (of 32-bit data) using 5-3 reversible filter.

## Input Arguments

- `pTileRect` – pointer to an OMXRect data structure, which indicates the position and size of the image tile.

## Output Arguments

- `pSize` – pointer to an integer of size of the internal buffer used by 2D 5-3 wavelet transformation.

## Returns

- Standard OMXResult result. See enumeration for possible result codes.

### A.4.1.1.3 WTGetBufSize\_D97\_S16\_C1IR

## Prototype

```
OMXResult omxICJP2K_WTGetBufSize_D97_S16_C1IR_DLx (const OMXRect *pTileRect,  
    OMX_INT *pSize);
```

## Description

Get the buffer size (in bytes) for one-level 2D forward and inverse wavelet transformation on an image tile of 16-bit data using a 9-7 reversible filter.

### Input Arguments

- `pTileRect` – pointer to an OMXRect data structure, which indicates the position and size of the image tile.

### Output Arguments

- `pSize` – pointer to an integer of size of the internal buffer used by a 2D 9-7 wavelet transformation.

### Returns

- Standard OMXResult result. See enumeration for possible result codes.

## A.4.1.1.4 WTGetBufSize\_D97\_S32\_C1IR

### Prototype

```
OMXResult omxICJP2K_WTGetBufSize_D97_S32_C1IR_DLx (const OMXRect *pTileRect,
    OMX_INT *pSize);
```

### Description

Get the buffer size (in bytes) for both one-level 2D forward and inverse wavelet transformation on an image tile of 32-bit data using a 9-7 reversible filter.

### Input Arguments

- `pTileRect` – pointer to an OMXRect data structure, which indicates the position and size of the image tile.

### Output Arguments

- `pSize` – pointer to an integer of size of the internal buffer used by 2D 9-7 wavelet transformation.

### Returns

- Standard OMXResult result. See enumeration for possible result codes.

## A.4.2 Encoder Functions

### A.4.2.1 Forward DWT

#### A.4.2.1.1 WTFwd\_B53\_S16\_C1IR

### Prototype

```
OMXResult omxICJP2K_WTFwd_B53_S16_C1IR_DLx (OMX_S16 *pSrcDstTile, OMX_INT
    step, const OMXRect *pTileRect, OMX_U8 *pBuffer);
```

### Description

This function makes a one-level forward 2D wavelet transformation on one image tile using the 5-3 reversible filter. The DWT coefficients are de-interleaved into LL, HL, LH and HH subbands and written

back to the buffer of input data. The image tile data are in 16-bit data type.

### Input Arguments

- `pSrcDstTile` – pointer to the buffer of input image tile. The start address of `pSrcDstTile` must be 8-byte aligned. It is better to make it 32-byte aligned.
- `step` – specifies the number of bytes in a line of the input data buffer. `step` is in bytes, and must be an integer multiple of 8.
- `pTileRect` – pointer to an `OMXRect` data structure, which indicates the position and size of the image tile.
- `pBuffer` – pointer to the work buffer for transform. The start address of `pBuffer` must be 8-byte aligned. It is better to make it 32-byte aligned. The work buffer pointed by `pBuffer` must be allocated before the function is called. Its size can be retrieved by calling `ICJP2K_WTGetBufSize_B53_S16_C1IR`.

### Output Arguments

- `pSrcDstTile` – pointer to the buffer of output DWT coefficients.

### Returns

- Standard `OMXResult` result. See enumeration for possible result codes.

## A.4.2.1.2 WTFwd\_B53\_S32\_C1IR

### Prototype

```
OMXResult omxICJP2K_WTFwd_B53_S32_C1IR_DLx (OMX_S32 *pSrcDstTile, OMX_INT
    step, const OMXRect *pTileRect, OMX_U8 *pBuffer);
```

### Description

This function makes a one-level forward 2D wavelet transformation on one image tile using the 5-3 reversible filter. The DWT coefficients are de-interleaved into LL, HL, LH and HH subbands and written back to the buffer of input data. The image tile data are in 32-bit data type.



**Note:** *The input image tile may be either a one tile-component of the image or the LL subband of the higher levels DWT coefficients. The DWT results are de-interleaved into four subbands, which are written to the buffer pointed to by `*pSrcDstTile`.*

---

### Input Arguments

- `pSrcDstTile` – pointer to the buffer of input image tile. The start address of `pSrcDstTile` must be 8-byte aligned.



**Note:** *Although the start address of `pSrcDstTile` must be 8-byte aligned, it is better to make it 32-byte aligned.*

---



- `step` – specifies the number of bytes in a line of the input data buffer. `step` is in bytes, and must be an integer multiple of 8.
- `pTileRect` – pointer to an OMXRect data structure, which indicates the position and size of the image tile.
- `pBuffer` – pointer to the work buffer for transform. The start address of `pBuffer` must be 8-byte aligned. It is better to make it 32-byte aligned. The work buffer pointed by `pBuffer` must be allocated before the function is called, and its size may be determined by calling `ICJP2K_WTGetBufSize_B53_S32_C1IR`.



*Note: Although the start address of `pSrcDstTile` must be 8-byte aligned, it is better to make it 32-byte aligned.*

---

### Output Arguments

- `pSrcDstTile` – pointer to the buffer of output DWT coefficients.

### Returns

- Standard OMXResult result. See enumeration for possible result codes.

## A.4.2.1.3 WTFwd\_D97\_S16\_C1IR

### Prototype

```
OMXResult omxICJP2K_WTFwd_D97_S16_C1IR_DLx (OMX_S16 *pSrcDstTile, OMX_INT
    step, const OMXRect *pTileRect, OMX_U8 *pBuffer);
```

### Description

This function makes a fix-point implementation of one-level forward 2D wavelet transformation on one image tile using the 9-7 irreversible filter. The DWT coefficients are de-interleaved into LL, HL, LH and HH subbands and written back to the buffer of input data. The image tile data are in 16-bit data type.

### Input Arguments

- `pSrcDstTile` – pointer to the buffer of input image tile. The start address of `pSrcDstTile` must be 8-byte aligned.



*Note: Although the start address of `pSrcDstTile` must be 8-byte aligned, it is better to make it 32-byte aligned.*

---

- `step` – specifies the number of bytes in a line of the input data buffer. `step` is in bytes, and must be an integer multiple of 8.
- `pTileRect` – pointer to an OMXRect data structure, which indicates the position and size of the image tile.

- `pBuffer` – pointer to the work buffer for transform. The start address of `pBuffer` must be 8-byte aligned. The work buffer pointed by `pBuffer` must be allocated before the function is called. Its size can be retrieved by calling `ICJP2K_WTGetBufSize_D97_S16_C1IR`.



*Note: Although the start address of `pBuffer` must be 8-byte aligned, it is better to make it 32-byte aligned.*

---

### Output Arguments

- `pSrcDstTile` – pointer to the buffer of output DWT coefficients.

### Returns

- Standard OMXResult result. See enumeration for possible result codes.

## A.4.2.1.4 WTFwd\_D97\_S32\_C1IR

### Prototype

```
OMXResult omxICJP2K_WTFwd_D97_S32_C1IR_DLx (OMX_S32 *pSrcDstTile, OMX_INT step, const OMXRect *pTileRect, OMX_U8 *pBuffer);
```

### Description

This function makes a fix-point implementation of one-level forward 2D wavelet transformation on one image tile using the 9-7 irreversible filter. The DWT coefficients are de-interleaved into LL, HL, LH and HH subbands and written back to the buffer of input data. The image tile data are in 32-bit data type.

### Input Arguments

- `pSrcDstTile` – pointer to the buffer of input image tile. The start address of `pSrcDstTile` must be 8-byte aligned.



*Note: Although the start address of `pSrcDstTile` must be 8-byte aligned, it is better to make it 32-byte aligned.*

---

- `step` – specifies the number of bytes in a line of the input data buffer. `step` is in bytes, and must be an integer multiple of 8.
- `pTileRect` – pointer to an OMXRect data structure, which indicates the position and size of the image tile.
- `pBuffer` – pointer to the work buffer for transform. The start address of `pBuffer` must be 8-byte aligned. The work buffer pointed by `pBuffer` must be allocated before the function is called. Its size can be gotten by calling `ICJP2K_WTGetBufSize_D97_S32_C1IR`.



*Note: Although the start address of `pBuffer` must be 8-byte aligned, it is better to make it 32-byte aligned.*

---

### Output Arguments

- `pSrcDstTile` – pointer to the buffer of output DWT coefficients.

### Returns

- Standard OMXResult result. See enumeration for possible result codes.

## A.4.3 Decoder Functions

### A.4.3.1 Inverse DWT

#### A.4.3.1.1 WTInv\_B53\_S16\_C1IR

#### Prototype

```
OMXResult omxICJP2K_WTInv_B53_S16_C1IR_DLx (OMX_S16 *pSrcDstTile, OMX_INT
    step, const OMXRect *pTileRect, OMX_U8 *pBuffer);
```

#### Description

This function interleaves the LL, HL, LH and HH subbands of DWT coefficients and then makes a one-level inverse 2D wavelet transformation on them using the 5-3 reversible filter. The results are written back to the buffer of input data. The image tile data are in 16-bit data type.

#### Input Arguments

- `pSrcDstTile` – pointer to the buffer of input LL, HL, LH and HH subbands of DWT coefficients. The start address of `pSrcDstTile` must be 8-byte aligned.



*Note: Although the start address of `pSrcDstTile` must be 8-byte aligned, it is better to make it 32-byte aligned.*

---

- `step` – specifies the number of bytes in a line of the input data buffer. `step` is in bytes, and must be an integer multiple of 8.
- `pTileRect` – pointer to an OMXRect data structure, which indicates the position and size of the image tile.
- `pBuffer` – pointer to the work buffer for transform. The start address of `pBuffer` must be 8-byte aligned. The work buffer pointed by `pBuffer` must be allocated before the function is called, and its size can be retrieved by calling `ICJP2K_WTGetBufSize_B53_S16_C1IR`.



*Note: Although the start address of `pBuffer` must be 8-byte aligned, it is better to make it 32-byte aligned.*

---

### Output Arguments

- `pSrcDstTile` – pointer to the buffer of output image tile.

### Returns

- Standard OMXResult result. See enumeration for possible result codes.

## A.4.3.1.2 WTInv\_B53\_S32\_C1IR

### Prototype

```
OMXResult omxICJP2K_WTInv_B53_S32_C1IR_DLx (OMX_S32 *pSrcDstTile, OMX_INT
    step, const OMXRect *pTileRect, OMX_U8 *pBuffer);
```

### Description

This function interleaves the LL, HL, LH and HH subbands of DWT coefficients and then makes a one-level inverse 2D wavelet transformation on them using the 5-3 reversible filter. The results are written back to the buffer of input data. The image tile data are in 32-bit data type.

### Input Arguments

- `pSrcDstTile` – pointer to the buffer of input LL, HL, LH and HH subbands of DWT coefficients. The start address of `pSrcDstTile` must be 8-byte aligned.



*Note: Although the start address of `pBuffer` must be 8-byte aligned, it is better to make it 32-byte aligned.*

---

- `step` – specifies the number of bytes in a line of the input data buffer. `step` is in bytes, and must be an integer multiple of 8.
- `pTileRect` – pointer to an OMXRect data structure which indicates the position and size of the image tile.
- `pBuffer` – pointer to the work buffer for transform. The start address of `pBuffer` must be 8-byte aligned. The work buffer pointed by `pBuffer` must be allocated before the function is called, and its size may be determined by calling `ICJP2K_WTGetBufSize_B53_S32_C1IR`.



*Note: Although the start address of `pBuffer` must be 8-byte aligned, it is better to make it 32-byte aligned.*

---

### Output Arguments

- `pSrcDstTile` – pointer to the buffer of output image tile.

### Returns

- Standard OMXResult result. See enumeration for possible result codes.

## A.4.3.1.3 WTInv\_D97\_S16\_C1IR

### Prototype

```
OMXResult omxICJP2K_WTInv_D97_S16_C1IR_DLx(OMX_S16 *pSrcDstTile, OMX_INT  
step, const OMXRect *pTileRect, OMX_U8 *pBuffer);
```

### Description

This function interleaves the LL, HL, LH and HH subbands of DWT coefficients and then makes a fix-point implementation of one-level inverse 2D wavelet transformation on them using the 9-7 irreversible filter. The results are written back to the buffer of input data. The image tile data are in 16-bit data type.

### Input Arguments

- `pSrcDstTile` – pointer to the buffer of input LL, HL, LH and HH subbands of DWT coefficients. The start address of `pSrcDstTile` must be 8-byte aligned. It is better to make it 32-byte aligned.



*Note: Although the start address of `pBuffer` must be 8-byte aligned, it is better to make it 32-byte aligned.*

---

- `step` – specifies the number of bytes in a line of the input data buffer. `step` is in bytes, and must be an integer multiple of 8.
- `pTileRect` – pointer to an OMXRect data structure which indicates the position and size of the image tile.
- `pBuffer` – pointer to the work buffer for transform. The start address of `pBuffer` must be 8-byte aligned. The work buffer pointed by `pBuffer` must be allocated before the function is called. Its size can be gotten by calling `ICJP2K_WTGetBufSize_D97_S16_C1IR`.

### Output Arguments

- `pSrcDstTile` – pointer to the buffer of output image tile.

### Returns

- Standard OMXResult result. See enumeration for possible result codes.

## A.4.3.1.4 WTInv\_D97\_S32\_C1IR

### Prototype

```
OMXResult omxICJP2K_WTInv_D97_S32_C1IR_DLx (OMX_S32 *pSrcDstTile, OMX_INT  
step, const OMXRect *pTileRect, OMX_U8 *pBuffer);
```

## Description

This function interleaves the LL, HL, LH and HH subbands of DWT coefficients and then makes a fix-point implementation of one-level inverse 2D wavelet transformation on them using the 9-7 irreversible filter. The results are written back to the buffer of input data. The image tile data are in 32-bit data type.

## Input Arguments

- `pSrcDstTile` – pointer to the buffer of input LL, HL, LH and HH subbands of DWT coefficients. The start address of `pSrcDstTile` must be 8-byte aligned. It is better to make it 32-byte aligned.



*Note: Although the start address of `pBuffer` must be 8-byte aligned, it is better to make it 32-byte aligned.*

---

- `step` – specifies the number of bytes in a line of the input data buffer. `step` is in bytes, and must be an integer multiple of 8.
- `pTileRect` – pointer to an `OMXRect` data structure which indicates the position and size of the image tile.
- `pBuffer` – pointer to the work buffer for transform. The start address of `pBuffer` must be 8-byte aligned. The work buffer pointed by `pBuffer` must be allocated before the function is called. Its size can be retrieved by calling `ICJP2K_WTGetBufSize_D97_S32_C1IR`.

## Output Arguments

- `pSrcDstTile` – pointer to the buffer of output image tile.

## Returns

- Standard `OMXResult` result. See enumeration for possible result codes.

## A.5 Video Coding, Common (omxVCCOMM) and MPEG-4 (omxVCM4P2) Sub-Domains

This section contains functions for video coding, including both the VCCOMM and VCM4P2 sub-domains.

### A.5.1 Data Structures and Enumerators

#### A.5.1.1 Transparent Status

```
enum {
    OMX_VC_TRANSPARENT    = 0,        /** Wholly transparent */
    OMX_VC_PARTIAL        = 1,        /** Partially transparent */
    OMX_VC_OPAQUE          = 2        /** Opaque */
};
```

### A.5.1.2 OMXSadmultipleParam

```
typedef struct OMXSadmultipleParam
{
    OMX_S16 Block_width;
    OMX_S16 Block_height;
    OMX_S16 Target_width;
    OMX_S16 ref_width;
    OMX_S16 step_horz;
    OMX_S16 step_vert;
    OMX_S16 nsteps_horz;
    OMX_S16 nsteps_vert;
    OMX_S16 minmax_clear;
    OMX_S16 Minmax;
    OMX_S16 id_mode;
    OMX_S16 id_value;
    OMX_S16 Thresh;
    OMX_S16 center_block;
    OMX_S16 skip_field;
} OMXSadmultipleParam;
```

### A.5.1.3 OMXSadmultipleInterpParam

```
typedef struct OMXSadmultipleInterpParam
{
    OMX_S16 block_width;
    OMX_S16 block_height;
    OMX_S16 target_width;
} OMXSadmultipleInterpParam;
```

### A.5.1.4 OMXSoSmultipleInterpParam

```
typedef struct OMXSoSmultipleInterpParam
{
    OMX_S16 block_width;
    OMX_S16 block_height;
    OMX_S16 target_width;
} OMXSoSmultipleInterpParam;
```

## A.5.2 Encoder/Decoder Functions

### A.5.2.1 Inverse DCT

#### A.5.2.1.1 IDCT8x8blks

##### Prototype

```
OMXResult omxVCM4P2_IDCT8x8blks_DLx (OMX_S16 *pBlkIn, OMX_S16 *pBlkOut,  
    OMX_INT knum_blks);
```

##### Description

This function performs the 2D IDCT on 8x8 data blocks.

##### Input Arguments

- pBlkIn – starting address of input matrix, 16-byte aligned.
- knum\_blks – number of 8x8 blocks.

##### Output Arguments

- pBlkOut – starting address of output matrix, 16-byte aligned.

##### Returns

- OMXResult

#### A.5.2.1.2 IDCTMBIntra

##### Prototype

```
OMXResult omxVCM4P2_IDCTMBIntra_DLx (OMX_S16 *pSrcBufY, OMX_INT width,  
    OMX_U8 *pResBufY, OMX_U8 *pResBufCb, OMX_U8 *pResBufCr);
```

##### Description

This is a middle level function call that performs inverse DCT for all the six blocks (YCcbCr) in the current macroblock. The function can also be considered as the reconstruction step for an intra macroblock in a P-VOP.



**Note:** This is a super-block function. The coefficients in the input buffer are arranged in linear block-wise form; for example, coefficients of one block (8x8) of data are succeeded by the coefficients of the next block. This function can also be used in H.263 video coding.

---

##### Input Arguments

- pSrcBufY – Pointer to the inverse transformed data. This is a linear array containing all the 384 coefficients of the macroblock, whose coefficients are arranged in a serial fashion.



- `width` – Width of the output Y frame component.

### Output Arguments

- `pResBufY` – Pointer to the location of IDCT data for Y component.
- `pResBufCb` – Pointer to the location of IDCT data for Cb component.
- `pResBufCr` – Pointer to the location of IDCT data for Cr component.

### Returns

- `OMXResult`

## A.5.3 Encoder Functions

### A.5.3.1 Forward DCT

#### A.5.3.1.1 DCT8x8blks

##### Prototype

```
OMXResult omxVCM4P2_DCT8x8blks_DLx (OMX_S16 *pBlkIn, OMX_S16 *pBlkOut,
    OMX_INT knum_blks);
```

##### Description

Performs the 2D forward DCT on multiple 8x8 data blocks.

##### Input Arguments

- `pBlkIn` – starting address of input matrix, 16-byte aligned.
- `knum_blks` – number of 8x8 blocks.

##### Output Arguments

- `pBlkOut` – starting address of output matrix, 16-byte aligned.

##### Returns

- `OMXResult`

### A.5.3.2 Motion Estimation

#### A.5.3.2.1 hpDiffMBY

##### Prototype

```
OMXResult omxVCM4P2_hpDiffMBY_DLx (OMX_U8 *pSrcBuf, OMX_U8 *pRefBuf,
    OMXMotVect *pSrcMV, OMX_INT rndCtrl, OMX_INT width, OMX_INT fourMVmode,
    OMX_S16 *pResBuf, OMXMotVect **pDstMV);
```

## Description

This is a middle level function call that performs half-pixel motion estimation and difference computation for a frame with no picture extension.

## Input Arguments

- `pSrcBuf` – Pointer to the current macroblock in the current frame buffer.
- `pRefBuf` – Pointer to the best-matched macroblock in the reference frame buffer.
- `pSrcMV` – Pointer to the best motion vector in full pixel units for the luminance vector from integer motion estimation.
- `rndCtrl` – Round control parameter used for half-pixel interpolation.
- `width` – Width of the luminance component of the frame.
- `fourMVmode` – Enable bit to indicate that there can be four MVs for the 16x16 macroblock.

## Output Arguments

- `pResBuf` – Pointer to the residual/error values as result of mismatch between the best-matched pixels in the reference macroblock and the current macroblock. This is a linear array of 256 elements.
- `pDstMV` – Pointer to the best-matched motion vectors for all the four blocks in the luminance macroblock. This is an array of four elements, with each element representing a motion vector (in half-pixel units) for one block. If the macroblock has only one best matched motion vector, then the best-matched motion vector is replicated to all the members of the array.

## Returns

- `OMXResult`

### A.5.3.2.2 hpDiffBlkC

## Prototype

```
OMXResult omxVCM4P2_hpDiffBlkC_DLx (OMX_U8 *pSrcBuf, OMX_U8 *pRefBuf,  
    OMX_INT rndCtrl, OMXMotVect *pSrcMV, OMX_INT width, OMX_S16 *pResBuf);
```

## Description

Performs half-pixel interpolation chrominance pixels (Cb) and calculates difference data. This is a middle level function call that computes the half-pixel refinement and the difference between the current block (Cb) and the computed half/integer pixels for a frame



*Note: This is a super-block function. The luminance motion vector is used to determine the type of interpolation pixel (horizontal, vertical, horizontal-vertical, or integer) to be calculated. The same function call can also be used for H.263 encoding.*

---

## Input Arguments

- `pSrcBuf` – Pointer to the current macroblock in the current frame buffer.
- `pRefBuf` – Pointer to the best-matched macroblock in the reference frame buffer.

- `rndCtrl` – Round control parameter used for half-pixel interpolation.
- `width` – Width of the chrominance component of the frame.
- `pSrcMV` – Pointer to the best-matched motion vector (in half pixel units).

### Output Arguments

- `pResBuf` – Pointer to the residual/error values as result of mismatch between the best-matched pixels in the reference macroblock and the current macroblock. This is a linear array of 64 elements.

### Returns

- `OMXResult`

## A.5.3.2.3 hpDiffBlkDCTY

### Prototype

```
OMXResult omxVCM4P2_hpDiffBlkDCTY_DLx (OMX_U8 *pSrcBuf, OMX_U8 *pRefBuf,
    OMXMotVect *pSrcMV, OMX_INT rndCtrl, OMX_INT width, OMX_INT fourMVmode,
    OMX_S16 *pResBuf, OMXMotVect **pDstMV);
```

### Description

Performs half-pixel interpolation, calculates difference data and DCT for the luminance macroblock in a frame with no picture extension.

This is a super-block function. This is a middle level function call that performs half-pixel motion estimation, computes difference values and performs DCT on each of the four luminance blocks.



*Note: This function may also be used for H.263 encode.*

---

### Input Arguments

- `pSrcBuf` – Pointer to the current macroblock in the current frame buffer.
- `pRefBuf` – Pointer to the best-matched macroblock in the reference frame buffer.
- `pSrcMV` – Pointer to the best motion vector in full pixel units for the luminance vector from integer motion estimation.
- `rndCtrl` – Round control parameter used for half-pixel interpolation.
- `width` – Width of the chrominance component of the frame.
- `fourMVmode` – Enable bit to indicate that there can be four MVs for the 16x16 macroblock.

### Output Arguments

- `pResBuf` – Pointer to the DCT macroblock array. This is a linear array of 256 elements.
- `pDstMV` – Pointer to the best-matched motion vectors for all four blocks in the luminance macroblock. This is an array of four elements, with each element representing a motion vector (in half-pixel units) of one block. If the macroblock has only one best-matched motion vector then the best-matched motion vector is replicated to all the members of the array.

## Returns

- OMXResult

### A.5.3.2.4 hpDiffBlkDCTC

#### Prototype

```
OMXResult omxVCM4P2_hpDiffBlkDCTC_DLx (OMX_U8 *pSrcBuf, OMX_U8 *pRefBuf,
    OMX_INT rndCtrl, OMX_INT width, OMX_INT fourMVmode, OMXMotVect *pSrcMV,
    OMX_S16 *pResBuf);
```

#### Description

Perform half-pixel interpolation, calculate difference and apply DCT on the resultant block data. This is a super-block function. This is a middle-level function call that performs half-pixel interpolation as required on the best matched chrominance (Cb/Cr), computes the difference between the current block and the computed half/integer pixels and applies DCT on the resultant for a frame.



*Note: The same function call can also be used for H.263 encoding.*

---

#### Input Arguments

- pSrcBuf – Pointer to the current macroblock in the current frame buffer.
- pRefBuf – Pointer to the best matched block in the chrominance reference frame buffer.
- rndCtrl – Round control parameter used for half-pixel interpolation.
- width – Width of the chrominance component of the frame.
- fourMVmode – Enable bit to indicate that there can be four MVs for the 16x16 macroblock.
- pSrcMV – Pointer to the best-matched motion vector (in half pixel units).

#### Output Arguments

- pResBuf – Pointer to the residual/error values as result of mismatch between the best-matched pixels in the reference macroblock and the current macroblock. This is a linear array of 64 elements.

#### Returns

- OMXResult

### A.5.3.2.5 Sadmultiple

#### Prototype

```
OMXResult omxVCM4P2_Sadmultiple_DLx(OMX_U8 *pTargetBlk, OMX_U8 *pRefBlk,
    OMX_S16 *pOutput, OMXSadmultipleParam *sParams);
```

#### Description

Computes absolute differences between target block and blocks in reference array. The reference data and

target data are each assumed to be a luminance-only block.

### Input Arguments

- pTargetBlk – Pointer to target array (linear), 8-byte aligned.
- pRefBlk – Pointer to reference array. 1-byte aligned.
- sParams – Pointer to Parameters for Sadmultiple.

OMXSadmultipleParam elements:

- Block\_width – width of matching block.
- Block\_height – height of matching block.
- Target\_width – width of target array.
- ref\_width – width of reference array.
- step\_horz – Horizontal offset between matchings.
- step\_vert – vertical offset between matchings.
- nsteps\_horz – number of steps horizontally.
- nsteps\_vert – number of steps vertically.
- minmax\_clear.
  - 0: retain previous min/max value.
  - 1: clear previous min/max value.
- Minmax
  - 0: Minimum SAD is calculated.
  - 1: Maximum SAD is calculated.
- id\_mode – This selects the type of id output.
  - 0: block\_count.
  - 1: address
- d\_value – This selects whether id or min/max value is output.
  - 0: ID
  - 1: min/max value
- Thresh – Threshold. When SAD is strictly below 2\*threshold, command stops running, outputs current min/max or corresponding id/address.
- center\_block – Indicates which block should have bias towards if there is a tie.
- skip\_field – The bit value indicates which block to skip.

### Output Arguments

- pOutput – Pointer to output array.

### Returns

- OMXResult

### A.5.3.2.6 BlockMatchSOS\_Integer\_16x16

#### Prototype

```
OMXResult omxVCM4P2_BlockMatchSOS_Integer_16x16_DLx(const OMX_U8
    *pSrcRefBuf, OMX_INT refWidth, const OMXRect *pRefRect, const OMX_U8
    *pSrcCurrBuf, const OMXVCM4P2Coordinate *pCurrPointPos, const
    OMXVCMotionVector *pSrcPreMV, const OMX_INT *pSrcPreSOS, void *pMESpec,
    OMXVCMotionVector *pDstMV, OMX_INT *pDstSOS);
```

#### Description

Performs a 16x16 block search; estimates motion vector and associated minimum SOS. Both the input and output motion vectors are represented using half-pixel units, and therefore a shift left or right by 1 bit may be required, respectively, to match the input or output MVs with other functions that either generate output MVs or expect input MVs represented using integer pixel units.

#### Input Arguments

- `pSrcRefBuf` – pointer to the reference Y plane; points to the reference MB that corresponds to the location of the current macroblock in the current plane.
- `refWidth` – width of the reference plane
- `pRefRect` – pointer to the valid reference plane rectangle; coordinates are specified relative to the image origin. Rectangle boundaries may extend beyond image boundaries if the image has been padded. For example, if padding extends 4 pixels beyond frame border, then the value for the left border could be set to -4.
- `pSrcCurrBuf` – pointer to the current block in the current macroblock buffer extracted from the original plane (linear array, 256 entries); must be aligned on a 16-byte boundary. The number of bytes between lines (step) is 16.
- `pCurrPointPos` – position of the current macroblock in the current plane
- `pSrcPreMV` – pointer to predicted motion vector; NULL indicates no predicted MV
- `pSrcPreSOS` – pointer to SOS associated with the predicted MV (referenced by `pSrcPreMV`); may be set to NULL if unavailable.
- `pMESpec` – vendor-specific motion estimation specification structure; must have been allocated and then initialized using `omxVCM4P2_MEInit` prior to calling the block matching function.

#### Output Arguments

- `pDstMV` – pointer to estimated MV
- `pDstSOS` – pointer to minimum SOS

#### Returns

- `OMX_Sts_NoErr` – no error
- `OMX_Sts_BadArgErr` – bad arguments. Returned if one of the following conditions is true:
  - at least one of the following pointers is NULL: `pSrcRefBuf`, `pRefRect`, `pSrcCurrBuf`, `pCurrPointPos`, `pSrcPreSOS`, `pDstSOS`, or `pMESpec`, or
  - `pSrcCurrBuf` is not 16-byte aligned

### A.5.3.2.7 BlockMatchSOS\_Integer\_8x8

#### Prototype

```
OMXResult omxVCM4P2_BlockMatchSOS_Integer_8x8_DLx(const OMX_U8 *pSrcRefBuf,
    OMX_INT refWidth, const OMXRect *pRefRect, const OMX_U8 *pSrcCurrBuf,
    const OMXVCM4P2Coordinate *pCurrPointPos, const OMXVCMotionVector
    *pSrcPreMV, const OMX_INT *pSrcPreSOS, void *pMESpec, OMXVCMotionVector
    *pDstMV, OMX_INT *pDstSOS);
```

#### Description

Performs an 8x8 block search; estimates motion vector and associated minimum SOS. Both the input and output motion vectors are represented using half-pixel units, and therefore a shift left or right by 1 bit may be required, respectively, to match the input or output MVs with other functions that either generate output MVs or expect input MVs represented using integer pixel units.

#### Input Arguments

- `pSrcRefBuf` – pointer to the reference Y plane; points to the reference block that corresponds to the location of the current 8x8 block in the current plane.
- `refWidth` – width of the reference plane
- `pRefRect` – pointer to the valid reference plane rectangle; coordinates are specified relative to the image origin. Rectangle boundaries may extend beyond image boundaries if the image has been padded.
- `pSrcCurrBuf` – pointer to the current block in the current macroblock buffer extracted from the original plane (linear array, 128 entries); must be aligned on an 8-byte boundary. The number of bytes between lines (step) is 16 bytes.
- `pCurrPointPos` – position of the current block in the current plane
- `pSrcPreMV` – pointer to predicted motion vector; NULL indicates no predicted MV
- `pSrcPreSOS` – pointer to SOS associated with the predicted MV (referenced by `pSrcPreMV`); may be set to NULL if unavailable.
- `pMESpec` – vendor-specific motion estimation specification structure; must have been allocated and then initialized using `omxVCM4P2_MEInit` prior to calling the block matching function.

#### Output Arguments

- `pDstMV` – pointer to estimated MV
- `pDstSOS` – pointer to minimum SOS

#### Returns

- `OMX_Sts_NoErr` – no error
- `OMX_Sts_BadArgErr` – bad arguments. Returned if one of the following conditions is true:
  - at least one of the following pointers is NULL: `pSrcRefBuf`, `pRefRect`, `pSrcCurrBuf`, `pCurrPointPos`, `pSrcPreSOS`, `pDstSOS`, or `pMESpec`, or
  - `pSrcCurrBuf` is not 8-byte aligned

### A.5.3.2.8 BlockMatchSOS\_Half\_16x16

#### Prototype

```
OMXResult omxVCM4P2_BlockMatchSOS_Half_16x16_DLx(const OMX_U8 *pSrcRefBuf,
    OMX_INT refWidth, const OMXRect *pRefRect, const OMX_U8 *pSrcCurrBuf,
    const OMXVCM4P2Coordinate *pSearchPointRefPos, OMXVCMotionVector
    *pSrcDstMV, OMX_INT *pDstSOS);
```

#### Description

Performs a 16x16 block match with half-pixel resolution. Returns the estimated motion vector and associated minimum SOS. This function estimates the half-pixel motion vector by interpolating the integer resolution motion vector referenced by the input parameter `pSrcDstMV`, i.e., the initial integer MV is generated externally. The input parameters `pSrcRefBuf` and `pSearchPointRefPos` should be shifted by the winning MV of 16x16 integer search prior to calling `BlockMatchSOS_Half_16x16`. The function `BlockMatchSOS_Integer_16x16` may be used for integer motion estimation.

#### Input Arguments

- `pSrcRefBuf` – pointer to the reference Y plane; points to the reference macroblock that corresponds to the location of the current macroblock in the current plane.
- `refWidth` – width of the reference plane
- `pRefRect` – reference plane valid region rectangle
- `pSrcCurrBuf` – pointer to the current block in the current macroblock buffer extracted from the original plane (linear array, 256 entries); must be aligned on a 16-byte boundary. The number of bytes between lines (step) is 16.
- `pSearchPointRefPos` – position of the starting point for half pixel search (specified in terms of integer pixel units) in the reference plane, i.e., the reference position pointed to by the predicted motion vector.
- `pSrcDstMV` – pointer to the initial MV estimate; typically generated during a prior 16X16 integer search; specified in terms of half-pixel units.

#### Output Arguments

- `pSrcDstMV` – pointer to estimated MV
- `pDstSOS` – pointer to minimum SOS

#### Returns

- `OMX_Sts_NoErr` – no error
- `OMX_Sts_BadArgErr` – bad arguments. Returned if one of the following conditions is true:
  - at least one of the following pointers is NULL: `pSrcRefBuf`, `pRefRect`, `pSrcCurrBuf`, `pSearchPointRefPos`, `pSrcDstMV`, or `pDstSOS`.
  - `pSrcCurrBuf` is not 16-byte aligned, or



### A.5.3.2.9 BlockMatchSOS\_Half\_8x8

#### Prototype

```
OMXResult omxVCM4P2_BlockMatchSOS_Half_8x8_DLx(const OMX_U8 *pSrcRefBuf,  
        OMX_INT refWidth, const OMXRect *pRefRect, const OMX_U8 *pSrcCurrBuf,  
        const OMXVCM4P2Coordinate *pSearchPointRefPos, OMXVCMotionVector  
        *pSrcDstMV, OMX_INT *pDstSOS);
```

#### Description

Performs an 8x8 block match with half-pixel resolution. Returns the estimated motion vector and associated minimum SOS. This function estimates the half-pixel motion vector by interpolating the integer resolution motion vector referenced by the input parameter `pSrcDstMV`, i.e., the initial integer MV is generated externally. The input parameters `pSrcRefBuf` and `pSearchPointRefPos` should be shifted by the winning MV of 8x8 integer search prior to calling `BlockMatchSOS_Half_8x8`. The function `BlockMatchSOS_Integer_8x8` may be used for integer motion estimation.

#### Input Arguments

- `pSrcRefBuf` – pointer to the reference Y plane; points to the reference block that corresponds to the location of the current 8x8 block in the current plane.
- `refWidth` – width of the reference plane
- `pRefRect` – reference plane valid region rectangle
- `pSrcCurrBuf` – pointer to the current block in the current macroblock buffer extracted from the original plane (linear array, 128 entries); must be aligned on a 8-byte boundary. The number of bytes between lines (step) is 16.
- `pSearchPointRefPos` – position of the starting point for half pixel search (specified in terms of integer pixel units) in the reference plane.
- `pSrcDstMV` – pointer to the initial MV estimate; typically generated during a prior 8x8 integer search, specified in terms of half-pixel units.

#### Output Arguments

- `pSrcDstMV` – pointer to estimated MV
- `pDstSOS` – pointer to minimum SOS

#### Returns

- `OMX_Sts_NoErr` – no error
- `OMX_Sts_BadArgErr` – bad arguments. Returned if one of the following conditions is true:
  - at least one of the following pointers is NULL: `pSrcRefBuf`, `pRefRect`, `pSrcCurrBuf`, `pDstSOS`, `pSearchPointRefPos`, `pSrcDstMV`, or
  - `pSrcCurrBuf` is not 8-byte aligned

## A.5.3.3 Quantization

### A.5.3.3.1 QuantACDCScanBlkIntra

#### Prototype

```
OMXResult omxVCM4P2_QuantACDCScanBlkIntra_DLx (OMX_S16 *pSrcBuf, OMX_INT
    dcScaler, OMX_INT quant, OMX_INT acFlag, OMX_S16 *pACDCArray, OMX_U8
    *numCoef, OMX_U8 *scanDirection, OMX_S16 *pResBuf);
```

#### Description

This is a middle level function call that performs quantization, AC/DC prediction, and scanning of one intra block of coefficients of data.



**Note:** This is a super-block function. The same function call can also be used for H.263 encoding. In this case, the user should set the `dcScaler` and `quant` to the same value.

---

#### Input Arguments

- `pSrcBuf` – Pointer to the block.
- `dcScaler` – Quantization parameter for DC coefficient.
- `quant` – Quantization parameter for AC coefficients.
- `acFlag` – Flag indication whether AC prediction is switched on.
- `pACDCArray` – Pointer to array containing AC/DC (I/O) coefficients of previous blocks.

#### Output Arguments

- `numCoef` – Pointer to the number of valid coefficients in the block.
- `scanDirection` – Pointer to the scan lookup table.
- `pResBuf` – Pointer to the linear array of scanned coefficients, where `numCoef` points to the number of valid elements.

#### Returns

- `OMXResult`

### A.5.3.3.2 QuantScanBlkInter

#### Prototype

```
OMXResult omxVCM4P2_QuantScanBlkInter_DLx (OMX_S16 *pSrcBuf, OMX_INT
    quant, OMX_S16 *pResBuf);
```

#### Description

Perform quantization, AC/DC prediction and scan for a block of data. This is a middle-level function call that performs quantization, AC/DC prediction and scanning of an inter-block of coefficients.



*Note: This is a super-block function. This function may also be used in H.263 video coding.*

---

### Input Arguments

- pSrcBuf – Pointer to the input block.
- quant – Quantization parameter for the block coefficients.

### Output Arguments

- pResBuf – Pointer to the linear array of scanned coefficients, where numCoef points the number of valid elements.

### Returns

- The number of valid coefficients in a block.

## A.5.4 Decoder Functions

### A.5.4.1 Inverse Quantization

#### A.5.4.1.1 IQMBIntra

#### Prototype

```
OMXResult omxVCM4P2_IQMBIntra_DLx (OMX_S16 *pSrcBuf, OMX_INT dcScaler,  
    OMX_INT quant, OMX_U8 *numCoef, OMX_U8 *pResBuf);
```

#### Description

This is a middle-level function call that performs inverse quantization for all six blocks (YcbCr) in the current macroblock.



*Note: This function can also be used in H.263 video coding. To use the function for H.263 baseline, set dcScaler to 8.*

---

### Input Arguments

- pSrcBuf – Pointer to the inverse transformed data. This is a linear array containing all the 384 coefficients of the macroblock, whose coefficients are arranged in a serial fashion.
- dcScaler – Quantization parameter for DC coefficient.
- quant – Quantization parameter for AC coefficients.
- numCoef – Pointer to the number of valid coefficients of the blocks (6) in a macroblock.

### Output Arguments

- `pResBuf` – Pointer to the location of resultant data.

### Returns

- `OMXResult`

## A.5.4.1.2 IQMBInter

### Prototype

```
OMXResult OMX_INT omxVCM4P2_IQMBInter_DLx (OMX_S16 *pSrcBuf, OMX_INT quant,
      OMX_U8 *numCoef, OMX_S16 *pResBuf);
```

### Description

Performs inverse quantization of the current luminance macroblock. This is a middle-level function call that performs inverse quantization of the current luminance macroblock.



*Note: This is a super-block function. This function can also be used in H.263 video coding.*

---

### Input Arguments

- `pSrcBuf` – Pointer to IDCT block data. This is a linear array containing all the 256 coefficients of the macroblock, whose coefficients are arranged in a serial fashion.
- `quant` – Quantization parameter for AC coefficients.

### Output Arguments

- `pResBuf` – Pointer to the location of the quantized data.

### Returns

- `numCoef` – Number of valid coefficients of the blocks (6) in a macroblock.

## A.5.4.2 Integrated IDCT + Inverse Quantization

### A.5.4.2.1 IQIDCTMBIntra

### Prototype

```
OMXResult omxVCM4P2_IQIDCTMBIntra_DLx (OMX_S16 *pSrcBuf, OMX_INT dcScaler,
      OMX_INT width, OMX_U8 *pResBufY, OMX_U8 *pResBufCb, OMX_U8
      *pResBufCr);
```

### Description

This is a middle level function call that performs inverse discrete cosine transform and inverse quantization for all six blocks (YCbCr) in the current macroblock. This is a super-block function.



*Note: In the input buffer (pSrcBuf), the coefficients of each block are assumed to be pre-processed. For example, every block is assumed to have 64 coefficients arranged in the normal order with the invalid coefficients assigned to zero. This function can also be used in H.263 video coding.*

---

### Input Arguments

- pSrcBuf – Pointer to the quantized data. This is a linear array containing all the 384 coefficients of the macroblock, whose coefficients are arranged in a serial fashion.
- dcScaler – Quantization parameter for DC coefficient.
- quant – Quantization parameter for AC coefficients.
- width – Width of the Y component of the frame.

### Output Arguments

- pResBufY – Pointer to the location of the reconstructed buffer where the luminance data is to be written.
- pResBufCb – Pointer to the location of the reconstructed buffer where the chrominance data (Cb) is to be written.
- pResBufCr – Pointer to the location of the reconstructed buffer where the chrominance data (Cr) is to be written.

### Returns

- OMXResult

## A.5.4.2.2 IQIDCTMBReconYInter

### Prototype

```
OMXResult omxVCM4P2_IQIDCTMBReconYInter_DLx (OMX_S16 *pSrcBuf, OMX_INT
    quant, OMX_U8 *pRefBuf, OMXMotVect **pSrcMV, OMX_INT rndCtrl, OMX_INT
    width, OMX_U8 *pResBuf);
```

### Description

Performs inverse discrete cosine transform, inverse quantization, and reconstructs the current luminance macroblock. This is a middle level function call that performs inverse quantization for all the six blocks in the current macroblock.



*Note: This is a super-block function. This function can also be used in H.263 video coding.*

---

### Input Arguments

- pSrcBuf – Pointer to the quantized data. This is a linear array containing all the 256 coefficients of the macroblock, whose coefficients are arranged in a serial fashion.
- quant – Quantization parameter for AC coefficients.

- `pRefBuf` – Pointer to the best-matched macroblock in the reference (frame) buffer.
- `rndCtrl` – Round control parameter used for half-pixel interpolation.
- `pSrcMV` – Pointer to the half-pixel motion vector for all the four blocks.
- `width` – Width of the Y component of the frame.

### Output Arguments

- `pResBuf` – Pointer to the location of the reference buffer where the luminance data is to be written.

### Returns

- `OMXResult`

## A.5.4.2.3 IQIDCTReconYInter

### Prototype

```
OMXResult omxVCM4P2_IQIDCTReconYInter_DLx (OMX_S16 *pSrcBuf, OMX_INT quant,
      OMX_U8 *pRefBuf, OMXMotVect **pSrcMV, OMX_INT rndCtrl, OMX_INT width,
      OMX_U8 *pResBuf);
```

### Description

Perform inverse discrete cosine transform, inverse quantization and reconstruct the current luminance macroblock.



***Note:** This function performs inverse quantization for all six blocks in the current macroblock.*

---

### Input Arguments

- `pSrcBuf` – Pointer to the quantized data. This is a linear array containing all the 64 coefficients of the macroblock, whose coefficients are arranged in a serial fashion.
- `quant` – Quantization parameter for AC coefficients.
- `pRefBuf` – Pointer to the best-matched macroblock in the reference (frame) buffer.
- `rndCtrl` – Round control parameter used for half-pixel interpolation.
- `pSrcMV` – Pointer to the half-pixel motion vector for the block.
- `width` – Width of the Y component of the frame.

### Output Arguments

- `pResBuf` – Pointer to the location of the reference buffer where the luminance data is to be written.

### Returns

- `OMXResult`

#### A.5.4.2.4 IQIDCTReconCInter

##### Prototype

```
OMXResult omxVCM4P2_IQIDCTReconCInter_DLx (OMX_S16 *pSrcBuf, OMX_INT quant,  
      OMX_U8 *pRefBuf, OMXMotVect **pSrcMV, OMX_INT rndCtrl, OMX_INT width,  
      OMX_U8 *pResBuf);
```

##### Description

This is a middle level function call that performs inverse discrete cosine transform, inverse quantization, and reconstruction of the current Cb/Cr block.



*Note: This is a super-block function. Reconstruction involves computing half-pixels for each of the blocks and adding them to the corresponding inverse-quantized block data. In the input buffer (pSrcBuf), the coefficients of the block are assumed to be pre-processed, for example, to have 64 coefficients arranged in the normal order with the invalid coefficients assigned to zero. This function can also be used in H.263 video coding.*

---

##### Input Arguments

- pSrcBuf – Pointer to the quantized data. This is a linear array containing all the 64 coefficients of the current Cb/Cr block.
- quant – Quantization parameter for all the coefficients.
- pRefBuf – Pointer to the best-matched macroblock in the reference (frame) buffer.
- pSrcMV – Pointer to the half-pixel motion vector for all the four blocks.
- rndCtrl – Round control parameter used for half-pixel interpolation.
- width – Width of the chrominance component of the frame.

##### Output Arguments

- pResBuf – Pointer to the location of the reference buffer where the luminance data is to be written.

##### Returns

- OMXResult

#### A.5.4.3 Motion Vector Decoding

##### A.5.4.3.1 DecodeMV\_BVOP\_Backward

##### Prototype

```
OMXResult omxVCM4P2_DecodeMV_BVOP_Backward_DLx(const OMX_U8 **ppBitStream,  
      OMX_INT *pBitOffset, OMXVCMotionVector *pSrcDstMVB, OMX_INT  
      fcodeBackward);
```

## Description

Decodes motion vectors of the macroblock in B-VOP backward mode. After decoding a backward mode only macroblock, the backward predictor is set to the decoded backward vector.

## Input Arguments

- `ppBitStream` – pointer to the pointer to the current byte in the bit stream buffer.
- `pBitOffset` – pointer to the bit position in the byte pointed to by `*ppBitStream`. `*pBitOffset` is valid within [0-7].
- `pSrcDstMVB` – pointer to the backward motion vector predictor.
- `fcodeBackward` – a code equal to `vop_fcode_backward` in MPEG-4 bit stream syntax so that it points to the current byte in the bit stream buffer.

## Output Arguments

- `ppBitStream` – `*ppBitStream` is updated after the block is decoded, so that it points to the current byte in the bit stream buffer.
- `pBitOffset` – `*pBitOffset` is updated so that it points to the current bit position in the byte pointed by `ppBitStream`.
- `pSrcDstMVB` – pointer to the backward motion vector of the current macroblock. The backward motion vector predictor should be reset to zero at the beginning of each macroblock row.

## Returns

- Standard OMXResult result. See enumeration for possible result codes.

### A.5.4.3.2 DecodeMV\_BVOP\_Forward

## Prototype

```
OMXResult omxVCM4P2_DecodeMV_BVOP_Forward_DLx(const OMX_U8 **ppBitStream,  
        OMX_INT *pBitOffset, OMXVCMotionVector *pSrcDstMVF, OMX_INT  
        fcodeForward);
```

## Description

Decodes motion vectors of the macroblock in B-VOP forward mode. After decoding a macroblock of forward mode only, the forward predictor is set to the decoded forward vector.

## Input Arguments

- `ppBitStream` – pointer to the pointer to the current byte in the bit stream buffer.
- `pBitOffset` – pointer to the bit position in the byte pointed to by `*ppBitStream`. `*pBitOffset` is valid within [0-7].
- `pSrcDstMVF` – pointer to the forward motion vector predictor.
- `fcodeForward` – a code equal to `vop_fcode_forward` in MPEG-4 bit stream syntax so that it points to the current byte in the bit stream buffer.

## Output Arguments

- `ppBitStream` – `ppBitStream` is updated after the block is decoded, so that it points to the current byte in the bit stream buffer.



- `pBitOffset` – `*pBitOffset` is updated so that it points to the current bit position in the byte pointed by `ppBitStream`.
- `pSrcDstMVF` – pointer to the forward motion vector of the current macroblock. The forward motion vector predictor should be reset to zero at the beginning of each macroblock row.

### Returns

- Standard OMXResult result. See enumeration for possible result codes.

## A.5.4.3.3 DecodeMV\_BVOP\_Interpolate

### Prototype

```
OMXResult omxVCM4P2_DecodeMV_BVOP_Interpolate_DLx(const OMX_U8
    **ppBitStream, OMX_INT *pBitOffset, OMXVCMotionVector *pSrcDstMVF,
    OMXVCMotionVector *pSrcDstMVB, OMX_INT fcodeForward, OMX_INT
    fcodeBackward);
```

### Description

Decodes motion vectors of the macroblock in B-VOP interpolate mode. After decoding a macroblock of interpolate mode, both the forward and backward predictor are updated separately with the decoded vectors of the same type (forward/backward).

### Input Arguments

- `ppBitStream` – pointer to the pointer to the current byte in the bit stream buffer.
- `pBitOffset` – pointer to the bit position in the byte pointed to by `*ppBitStream`. `*pBitOffset` is valid within [0-7].
- `pSrcDstMVF` – pointer to the forward motion vector predictor. The forward motion vector predictor should be reset to zero at the beginning of each macroblock row.
- `pSrcDstMVB` – pointer to the backward motion vector predictor. The backward motion vector predictor should be reset to zero at the beginning of each macroblock row.
- `fcodeForward` – a code equal to `vop_fcode_forward` in MPEG-4 bit stream syntax.
- `fcodeBackward` – a code equal to `vop_fcode_backward` in MPEG-4 bit stream syntax.

### Output Arguments

- `ppBitStream` – `*ppBitStream` is updated after the block is decoded, so that it points to the current byte in the bit stream buffer.
- `pBitOffset` – `*pBitOffset` is updated so that it points to the current bit position in the byte pointed by `*ppBitStream`.
- `pSrcDstMVF` – pointer to the forward motion vector of the current macroblock.
- `pSrcDstMVB` – pointer to the backward motion vector of the current macroblock.

### Returns

- Standard OMXResult. See enumeration for possible result codes.

#### A.5.4.3.4 DecodeMV\_BVOP\_Direct

##### Prototype

```
OMXResult omxVCM4P2_DecodeMV_BVOP_Direct_DLx(const OMX_U8 ** ppBitStream,
    OMX_INT *pBitOffset, const OMXVCMotionVector *pSrcMV,
    OMXVCMotionVector *pDstMVF, OMXVCMotionVector *pDstMVB, OMX_U8
    *pTranspSrcMB, OMX_INT TRB, OMX_INT TRD);
```

##### Description

Decodes motion vector(s) of the macroblock in B-VOP using direct mode.

##### Input Arguments

- ppBitStream – pointer to the pointer to the current byte in the bit stream buffer.
- pBitOffset – pointer to the bit position in the byte pointed to by \*ppBitStream. \*pBitOffset is valid within [0-7].
- pSrcMV – pointer to the motion vector buffer of the co-located macroblock in the most recently decoded I- or P-VOP.
- pTranspSrcMB – pointer to the transparent status buffer of the co-located macroblock.
- TRB – the difference in temporal reference of the B-VOP and the previous reference VOP.
- TRD – the difference in temporal reference of the temporally next reference VOP with temporally previous reference VOP.

##### Output Arguments

- ppBitStream – \*ppBitStream is updated after the block is decoded, so that it points to the current byte in the bit stream buffer.
- pBitOffset – \*pBitOffset is updated so that it points to the current bit position in the byte pointed to by \*ppBitStream.
- pDstMVF – pointer to the forward motion vector buffer of the current macroblock that contains decoded forward motion vector.
- pDstMVB – pointer to the backward motion vector buffer of the current macroblock which contains decoded backward motion vector.

##### Returns

Standard OMXResult. See enumeration for possible result codes.

#### A.5.4.3.5 DecodeMV\_BVOP\_DirectSkip

##### Prototype

```
OMXResult omxVCM4P2_DecodeMV_BVOP_DirectSkip_DLx(const OMXVCMotionVector
    *pSrcMV, OMXVCMotionVector *pDstMVF, OMXVCMotionVector *pDstMVB, OMX_U8
    *pTranspSrcMB, OMX_INT TRB, OMX_INT TRD);
```

##### Description

Decodes motion vector(s) of the macroblock in B-VOP using direct mode when the current macroblock is skipped.

### Input Arguments

- pSrcMV – pointer to the motion vector buffer of the co-located macroblock in the most recently decoded I- or P-VOP.
- pTranspSrcMB – pointer to the transparent status buffer of the co-located macroblock.
- TRB – the difference in temporal reference of the B-VOP and the previous reference VOP.
- TRD – the difference in temporal reference of the temporally next reference VOP with temporally previous reference VOP.

### Output Arguments

- pDstMVF – pointer to the forward motion vector buffer of the current macroblock which contains decoded forward motion vector.
- out ]pDstMVB – pointer to the backward motion vector buffer of the current macroblock which contains decoded backward motion vector.

### Returns

- Standard OMXResult result. See enumeration for possible result codes.

## A.5.4.3.6 DecodeMVS

### Prototype

```
OMXResult omxVCM4P2_DecodeMVS_DLx(const OMX_U8 **ppBitStream, OMX_INT
    *pBitOffset, OMXVCMotionVector *pSrcDstMVS, const OMX_U8 *pSrcBABMode,
    OMX_INT stepBABMode, const OMXVCMotionVector *pSrcMVLeftMB, const
    OMXVCMotionVector *pSrcMVUpperMB, const OMXVCMotionVector
    *pSrcMVUpperRightMB, const OMX_U8 *pTranspLeftMB, const OMX_U8
    *pTranspUpperMB, const OMX_U8 *pTranspUpperRightMB, OMX_INT predFlag);
```

### Description

Decode MVs (Motion Vector of shape) according to the spec.

### Input Arguments

- ppBitStream – Pointer to the pointer to the current byte in the bit stream buffer.
- pBitOffset – Pointer to the bit position in the byte pointed by \*ppBitStream. Valid within 0 to 7.
- pSrcDstMVS – Pointer to the shape motion vector buffer of the current BAB.
- pSrcBABMode – Pointer to the BAB mode buffer of current BAB, which stored in the BAB mode plane.
- stepBABMode – The width of the BAB mode plane.
- pSrcMVLeftMB – Pointers to the motion vector buffers of the macroblocks spacially at the left, upper and upper-right side of the current macroblock respectively.
- pSrcMVUpperMB – Pointers to the motion vector buffers of the macroblocks spacially at the left, upper and upper-right side of the current macroblock respectively.
- pSrcMVUpperRightMB – Pointers to the motion vector buffers of the macroblocks spacially at the left, upper and upper-right side of the current macroblock respectively.
- pTranspLeftMB – Pointers to the transparent status buffers of the macroblocks, spacially at the left, upper, and upper-right side of, and the current macroblock respectively.

- `pTranspUpperMB` – Pointers to the transparent status buffers of the macroblocks, spacially at the left, upper, and upper-right side of, and the current macroblock respectively.
- `pTranspUpperRightMB` – Pointers to the transparent status buffers of the macroblocks, spacially at the left, upper, and upper-right side of, and the current macroblock respectively.
- `predFlag` – The flag will be set zero, while the current VOP is BVOP or the current VOL is shape only mode; else, the flag is nonzero.

### Output Arguments

- `pSrcDstMVS` – Pointer to the decoded motion vector of shape.

### Returns

- Standard OMXResult result. See enumeration for possible result codes.

## A.5.4.5 Context-Based Arithmetic Decoding

### A.5.4.5.1 DecodeCAEIntraH\_U8

### A.5.4.5.2 DecodeCAEIntraV\_U8

#### Prototype

```
OMXResult omxVCM4P2_DecodeCAEIntraH_U8_DLx(const OMX_U8 **ppBitStream,
      OMX_INT *pBitOffset, OMX_U8 *pBinarySrcDst, OMX_INT step, OMX_INT
      blocksize);
```

```
OMXResult omxVCM4P2_DecodeCAEIntraV_U8_DLx(const OMX_U8 **ppBitStream,
      OMX_INT *pBitOffset, OMX_U8 *pBinarySrcDst, OMX_INT step, OMX_INT
      blocksize);
```

#### Description

Performs Context Arithmetic Code decoding in intra macroblock. H indicates scan type is horizontal. V indicates scan type is vertical. Convert ratio is supported in these functions.

#### Input Arguments

- `ppBitStream` – pointer to the pointer to the current byte from which the intra block starts.
- `pBitOffset` – pointer to the bit position in the byte pointed to by `*ppBitStream`. `*pBitOffset` is valid within [0-7].
- `pBinarySrcDst` – pointer to the Source-Dest Binary macroblock the left and top border should be loaded before.
- `step` – width of source-dest binary plane, in bytes.
- `blocksize` – macroblock size, if convert ratio take effects, it means subsampled macro block size.

#### Output Arguments

- `ppBitStream` – pointer to the pointer to the current byte from which the intra block starts.
- `pBitOffset` – pointer to the bit position in the byte pointed to by `*ppBitStream`. `*pBitOffset` is valid within [0-7].

- `pBinarySrcDst` – pointer to the Source-Dest Binary macroblock the left and top border should be loaded before.

## Returns

Standard OMXResult result. See enumeration for possible result codes.

### A.5.4.5.3 DecodeCAEInterH\_U8

### A.5.4.5.4 DecodeCAEInterV\_U8

## Prototype

```
OMXResult omxVCM4P2_DecomposeCAEInterH_U8_DLx(const OMX_U8 **ppBitStream,
        OMX_INT *pBitOffset, const OMX_U8 *pBinarySrcPred, OMX_INT offsetPred,
        OMX_U8 *pBinarySrcDst, OMX_INT step, OMX_INT blocksize);
OMXResult omxVCM4P2_DecomposeCAEInterV_U8_DLx(const OMX_U8 **ppBitStream,
        OMX_INT *pBitOffset, const OMX_U8 *pBinarySrcPred, OMX_INT offsetPred,
        OMX_U8 *pBinarySrcDst, OMX_INT step, OMX_INT blocksize);
```

## Description

Performs Context Arithmetic Code decoding in inter macroblock. H indicates scan type is horizontal. V indicates scan type is vertical. Convert ratio is supported in these functions.



**Note:** This function multiplies the elements of one vector to the corresponding elements of a second vector.

---

## Input Arguments

- `ppBitStream` – pointer to the pointer to the current byte from which the intra block starts.
- `pBitOffset` – pointer to the bit position in the byte pointed to by `*ppBitStream`. `*pBitOffset` is valid within [0-7].
- `pBinarySrcPred` – pointer to the related macroblock in the reference binary plane. The left and top border should be loaded before. Pointer points to the top-left corner of this macro block, not the extended zone.
- `pBinarySrcDst` – pointer to the Source-Dest Binary macroblock. The left and top border should be loaded before.
- `offsetPred` – the bit position of first pixel in reference macroblock, valid within Bits 0 to 7. Where:
  - MSB=zero (0)
  - LSB=seven (7)
- `step` – width of source-dest binary plane and reference plane, in byte. If blocksize not equals to 16, it indicates binary buffer step.
- `blocksize` – macroblock size, if convert ratio take effects, it means subsampled macro block size.

## Output Arguments

- `ppBitStream` – pointer to the pointer to the current byte from which the intra block starts
- `pBitOffset` – pointer to the bit position in the byte pointed to by `*ppBitStream`. `*pBitOffset` is valid within [0-7].
- `pBinarySrcDst` – pointer to the Source-Dest Binary macroblock the left and top border should be loaded before.

## Returns

- Standard OMXResult result. See enumeration for possible result codes.

## A.5.4.6 Padding

### A.5.4.6.1 PadCurrent\_16x16\_U8\_I

### A.5.4.6.2 PadCurrent\_8x8\_U8\_I

## Prototype

```
OMXResult omxVCM4P2_PadCurrent_16x16_U8_I_DLx (const OMX_U8 *pSrcBAB,  
        OMX_INT stepBinary, OMX_U8 *pSrcDst, OMX_INT stepTexture);  
OMXResult omxVCM4P2_PadCurrent_8x8_U8_I_DLx (const OMX_U8 *pSrcBAB, OMX_INT  
        stepTexture, OMX_U8 *pSrcDst);
```

## Description

Performs horizontal and vertical repetitive padding process on luminance/alpha macroblock or chrominance block. The horizontal and vertical repetitive padding processes are specified in [ISO14496-2], subclauses 7.6.1.1 and 7.6.1.2, respectively.

## Input Arguments

- `pSrcDst` – pointer to the block to be padded
- `stepTexture` – width of the source texture (Luminance, Chrominance or Grayscale alpha) plane (numbered with pixel)
- `stepBinary` – width of the source binary alpha plane (for 16X16 version) or source binary alpha buffer (for 8X8 version) (numbered with byte)
- `pSrcBAB` – pointer to the binary alpha plane (for 16X16 version) or binary alpha block buffer (for 8X8 version). In 8X8 version, the buffer contains 32 bytes (256 bits) for 16 by 16 luminance or alpha block, or 8 bytes (64 bits) for 8 by 8 chrominance block



**Note:** For chrominance components, the BAB is generated by subsampling the shape block of the corresponding luminance component.

---

## Output Arguments

`pSrcDst` – pointer to the padded block

## Returns

- OMX\_Sts\_NoErr – no error
- OMX\_Sts\_BadArgErr – bad arguments
  - At least one of the pointers is NULL: pSrcDst or pSrcBAB.  
or
  - In 16 by 16 case, at least one of below case: stepTexture < 16, stepBinary < 2, stepTexture is not 4 multiple.  
or
  - In 8 by 8 case, at least one of below case: stepTexture < 8, stepTexture is not 4 multiple.  
or
  - pSrcDst is not 4-byte aligned.  
or
  - All the elements of current BAB are zero.

### A.5.4.6.3 PadMBHorizontal\_U8

#### Prototype

```
OMXResult omxVCM4P2_PadMBHorizontal_U8_DLx (const OMX_U8 *pSrcY, const
      OMX_U8 *pSrcCb, const OMX_U8 *pSrcCr, const OMX_U8 *pSrcA, OMX_U8
      *pDstY, OMX_U8 *pDstCb, OMX_U8 *pDstCr, OMX_U8 *pDstA, OMX_INT stepYA,
      OMX_INT stepCbCr);
```

#### Description

Performs horizontal extended padding process on exterior macroblock, which includes luminance, chrominance and alpha (if available) blocks, immediately next to the boundary macroblock.



**Note:** The MB version pads all blocks of luminance, chrominance, and alpha (if it exists) in one MB, while the 16x16 version is used to pad only four luminance or alpha blocks, and 8x8 version to pad one chrominance (Cb or Cr) block.

---

#### Input Arguments

- stepYA – width of the luminance or alpha planes. (numbered with pixel)
- stepCbCr – width of the Chrominance planes. (numbered with pixel)
- pSrcY – pointer to one of the vertical border of the boundary luminance blocks that are chosen to pad the exterior macroblock
- pSrcCb – pointer to one of the vertical border of the boundary Cb block that is chosen to pad the exterior macroblock
- pSrcCr – pointer to one of the vertical border of the boundary Cr block that is chosen to pad the exterior macroblock

- `pSrcA` – pointer to one of the horizontal border of the boundary alpha blocks that are chosen to pad the exterior macroblock. If `pSrcA` equals to `NULL`, then no alpha plane is available. Otherwise, the alpha plane should be padded.

### Output Arguments

- `pDstY` – pointer to the padded exterior luminance blocks
- `pDstCb` – pointer to the padded exterior Cb block
- `pDstCr` – pointer to the padded exterior Cr block
- `pDstA` – pointer to the padded exterior alpha blocks

### Returns

- `OMX_Sts_NoErr` – no error
- `OMX_Sts_BadArgErr` – bad arguments
  - At least one of the following pointers is `NULL`: `pSrcY`, `pSrcCb`, `pSrcCr`, `pDstY`, `pDstCb`, `pDstCr`.  
or
  - If `pSrcA != NULL`, `pDstA = NULL` or `pDstA` is not 4-byte aligned.  
or
  - At least one of `pDstY`, `pDstCb`, or `pDstCr` is not 4-byte aligned.  
or
  - At least one of the following conditions is true:
    - `stepYA < 16`
    - `stepCbCr < 8`
    - `stepYA` or `stepCbCr` is not a multiple of 4

#### A.5.4.6.4 PadMBVertical\_U8

### Prototype

```
OMXResult omxVCM4P2_PadMBVertical_U8_DLx (const OMX_U8 *pSrcY, const OMX_U8
    *pSrcCb, const OMX_U8 *pSrcCr, const OMX_U8 *pSrcA, OMX_U8 *pDstY,
    OMX_U8 *pDstCb, OMX_U8 *pDstCr, OMX_U8 *pDstA, OMX_INT stepYA, OMX_INT
    stepCbCr);
```

### Description

Performs vertical extended padding process on exterior macroblock, which includes luminance, chrominance and alpha (if available) blocks, immediately next to the boundary macroblock.



**Note:** The MB version pads all blocks of luminance, chrominance, and alpha (if the exist) in one MB, while the 16X16 version could be used to pad only four luminance or alpha blocks, and 8X8 version to pad one chrominance (Cb or Cr) block.

---



## Input Arguments

- `stepYA` – width of the Luminance and/or alpha planes
- `stepCbCr` – width of the Chrominance planes
- `pSrcY` – pointer to one of the horizontal border of the boundary luminance blocks that are chosen to pad the exterior macroblock
- `pSrcCb` – pointer to one of the horizontal border of the boundary Cb block that is chosen to pad the exterior macroblock
- `pSrcCr` – pointer to one of the horizontal border of the boundary Cr block that is chosen to pad the exterior macroblock
- `pSrcA` – pointer to one of the horizontal border of the boundary alpha blocks that are chosen to pad the exterior macroblock. If `pSrcA` equals to NULL, then no alpha plane is available. Otherwise, the alpha plane should be padded in MB version.

## Output Arguments

- `pDstY` – pointer to the padded exterior luminance blocks
- `pDstCb` – pointer to the padded exterior Cb block
- `pDstCr` – pointer to the padded exterior Cr block
- `pDstA` – pointer to the padded exterior alpha blocks

## Returns

- `OMX_Sts_NoErr` – no error
- `OMX_Sts_BadArgErr` – bad arguments
  - At least one of the following pointers is NULL:
- 1. `pSrcY`, `pSrcCb`, `pSrcCr`, `pDstY`, `pDstCb`, `pDstCr`
  - At least one of below case: `stepYA < 16`, `stepCbCr < 8`, `stepYA` or `stepCbCr` is not a multiple of 4.
  - At least one of the following is not 4-byte aligned:
- 2. `pSrcY`, `pSrcCb`, `pSrcCr`, `pDstY`, `pDstCb`, `pDstCr`
  - If `pSrcA` is not NULL, `pSrcA` is not 4-byte aligned, `pDstA` is NULL or `pDstA` is not 4-byte aligned.

### A.5.4.6.5 PadMBGray\_U8

#### Prototype

```
OMXResult omxVCM4P2_PadMBGray_U8_DLx (OMX_U8 grayVal, OMX_U8 *pDstY, OMX_U8 *pDstCb, OMX_U8 *pDstCr, OMX_U8 *pDstA, OMX_INT stepYA, OMX_INT stepCbCr);
```



**Note:** The MB version pads all blocks of luminance, chrominance and alpha (if exist) in one MB, while 16X16 version could be used to pad only 4 luminance or alpha blocks, and 8X8 version to pad one chrominance (Cb or Cr) block.

---

## Description

Fills gray value in exterior macroblock (includes luminance, chrominance and alpha (if available) blocks) that is not located next to any boundary macroblock.

## Input Arguments

- `grayVal` – the gray value to fill the exterior macroblock/block. It should be set to  $2^{\text{bits\_per\_pixel} - 1}$ , where `bits_per_pixel = 8` here.
- `stepYA` – width of the Luminance and/or alpha planes.(numbered with pixel)
- `stepCbCr` – width of the Chrominance planes.

## Output Arguments

- `pDstY` – pointer to the padded exterior luminance blocks. `pDstY` should be 32-bit aligned.
- `pDstCb` – pointer to the padded exterior Kb block. `DstCb` should be 32-bit aligned.
- `pDstCr` – pointer to the padded exterior Cr block. `pDstCr` should be 32-bit aligned.
- `pDstA` – pointer to the padded exterior alpha blocks. If `pDstA` equals to NULL, then no alpha plane is available. Otherwise, the alpha plane should be padded in MB version. `pDstA` should be 32-bit aligned.

## Returns

- `OMX_Sts_NoErr` – no error
- `OMX_Sts_BadArgErr` – bad arguments
  - At least one of the following pointers is NULL: `pDstY`, `pDstCb`, `pDstCr`.  
or
  - At least one of below case: `stepYA < 16`, `stepCbCr < 8`, `grayvalue <= 0`, `stepYA` or `stepCbCr` is not a multiple of 4.  
or
- At least one of `pDstY`, `pDstCb`, `pDstCr` not 32-bit aligned, If `pDstA != NULL`, `pDstA` not 32-bit aligned.

## A.6 Video Coding, H.264 Sub-Domain (omxVCM4P10)

### A.6.1 Decoder Functions

#### A.6.1.1 Inverse Quantization + Inverse Integer Transform

##### A.6.1.1.1 DequantTransformResidualFromPair\_C1

### Prototype

```
OMXResult omxVCM4P10_DequantTransformResidualFromPair_C1_DLx(OMX_U8 **ppSrc,  
    OMX_S16 *pDst,OMX_INT QP,OMX_S16*pDC,int AC );
```

## Description

Reconstruct the 4x4 residual block from coefficient-position pair buffer, perform dequantisation and integer inverse transformation for 4x4 block of residuals and update the pair buffer pointer to next non-empty block.

## Input Arguments

- `ppSrc` – double pointer to residual coefficient-position pair buffer output by CALVC decoding
- `pDC` – pointer to the DC coefficient of this block; `NULL` if it doesn't exist
- `QP` – quantization parameter
- `AC` – flag indicating if at least one non-zero coefficient exists

## Output Arguments

- `pDst` – pointer to the reconstructed 4x4 block

## Returns

- `OMX_Sts_NoErr` – no error
- `OMX_Sts_BadArgErr` – bad arguments
  - one or more of the following pointers is `NULL`: `ppSrc`.

## A.6.1.2 Deblocking

### A.6.1.2.1 DeblockingFilterMB

#### Prototype

```
OMXVCM4P10_DeblockingFilterMB_DLx (OMX_U8 **ppSrcDst, const OMX_INT *pStep,
    const OMXVCM4P10MBInfo *pCurrMB, const OMXVCM4P10MBInfo *pLeftMB, const
    OMXVCM4P10MBInfo *pAboveMB, const OMX_U16 *pCbp4x4, OMX_S8 AlphaOffset,
    OMX_S8 BetaOffset, const OMX_U8 *pBS);
```

#### Description

Applies deblocking filter to a complete macroblock, including both luminance and chrominance components.

#### Input Arguments

- `ppSrcDst` – pointers to the unfiltered Y, U, and V buffers for the current macroblock.
  - `ppSrcDst[0]` – pointer to the Y component, must be 16-byte aligned.
  - `ppSrcDst[1]` – pointer to the U component, must be 8-byte aligned.
  - `ppSrcDst[2]` – pointer to the V component, must be 8-byte aligned.
- `pStep` – 3-element array of steps for the Y, U, and V planes.
  - `pStep[0]` – Y plane step, must be a multiple of 16
  - `pStep[1]` – U plane step, must be a multiple of 8
  - `pStep[2]` – V plane step, must be a multiple of 8
- `pCurrMB` – pointer to the `OMXVCM4P10MBInfo` structure for the current macroblock

- `pLeftMB` – pointer to the `OMXVCM4P10MBInfo` structure for the left neighboring macroblock; must be set equal to `NULL` if the left neighboring block is unavailable.
- `pAboveMB` – pointer to the `OMXVCM4P10MBInfo` structure for the above neighboring macroblock; must be set equal to `NULL` if the above neighboring block is unavailable.
- `pCbp4x4` – pointer to an array containing 4x4 CBP for current, top, and left MBs.
  - `pCbp4x4[0]` – current
  - `pCbp4x4[1]` – top
  - `pCbp4x4[2]` – left
- `AlphaOffset` – specifies the offset used in accessing the alpha deblocking filter table; refer to [ISO14496-10], subclause 7.4.3.
- `BetaOffset` – specifies the offset used in accessing the beta deblocking filter table; refer to [ISO14496-10], subclause 7.4.3.
- `pBS` – pointer to a 16x2 table of BS parameters arranged in scan block order for vertical edges and then horizontal edges; valid in the range [0,4] with the following restrictions: i) `pBS[i]==4` may occur only for  $0 \leq i \leq 3$ , ii) `pBS[i]==4` if and only if `pBS[i^1]==4`. Must be 4-byte aligned

### Output Arguments

- `ppSrcDst` – pointers to the filtered Y, U, and V buffers for the current macroblock
  - `ppSrcDst[0]` – pointer to the Y component, must be 16-byte aligned.
  - `ppSrcDst[1]` – pointer to the U component, must be 8-byte aligned.
  - `ppSrcDst[2]` – pointer to the V component, must be 8-byte aligned.

### Returns

- `OMX_Sts_NoErr` – no error
- `OMX_Sts_BadArgErr` – bad arguments
  - one or more of the following pointers is `NULL`: `ppSrcDst`, `pCbp4x4`, `pStep`, `pCurrMB`, `pLeftMB`, `pAboveMB`, or `pBS`.
  - one or more of the alignment restrictions is violated.
  - one or more of the `pStep` size restrictions is violated.
  - `pBS` is out of range, i.e., one of the following conditions is true: `pBS[i]<0`, `pBS[i]>4`, `pBS[i]==4` for  $i \geq 4$ , or  $(pBS[i]==4 \ \&\& \ pBS[i^1] \neq 4)$  for  $0 \leq i \leq 3$ .

# B References

## B

- [Dough94] Dougherty, E., Editor, *Digital Image Processing Methods*, Marcel Dekker, 1994.
- [Hamil92] Hamilton, E., “JPEG File Interchange Format Version 1.02,” 1992 (“JFIF”).
- [ISO10918-1] International Standards Organization, ISO/IEC 10918-1:1994, “Information technology -- Digital compression and coding of continuous-tone still images: Requirements and guidelines,” 1994 (“JPEG”).
- [ISO11172-3] International Standards Organization, ISO/IEC 11172-3:1993, “Information Technology – Coding of moving pictures and associated audio for digital storage media at up to about 1.5 Mbit/s – Part 3: Audio,” 1993 (“MPEG-1”).
- [ISO13818-3] International Standards Organization, ISO/IEC 13818-3:1998, “Information Technology – Coding of audio-visual objects – Part 3: Audio,” 1998 (“MPEG-2”).
- [ISO14496-2] International Standards Organization, ISO/IEC 14496-3:2004, “Information Technology – Coding of audio-visual objects – Part 2: Visual,” 2004 (“MPEG-4 Video”).
- [ISO14496-3] International Standards Organization, ISO/IEC 14496-3:2005, “Information Technology – Coding of audio-visual objects – Part 3: Audio,” 2005 (“MPEG-4 AAC”).
- [ISO14496-10] International Standards Organization, ISO/IEC 14496-10:2005, “Advanced Video Coding for Generic Audiovisual Services,” 2005 (“MPEG-4 Part 10”).
- [ITUBT601-6] International Telecommunication Union, ITU-R Recommendation BT.601, “Studio Encoding parameters of digital television for standard 4:3 and wide screen 16:9 aspect ratios,” 2007.
- [ITUCCITT81] International Telecommunication Union, CCITT T.81, “Information Technology – Digital Compression and Coding of Continuous-Tone Still Images – Requirements and Guidelines,” Sep. 1992 (“JPEG”).