

An artist's impression of an Orbital Ring System (ORS) in polar orbit. Part I of a series of papers on this concept appears in this issue of *JBIS*.

ORBITAL RING SYSTEMS AND JACOB'S LADDERS — I

PAUL BIRCH

45 Brownsville Road, Heaton Moor, Stockport, England.

A method for transferring payloads into space without using rockets is presented: in this, massive rings encircle the globe in a low orbit, supporting stationary 'skyhooks' from which cables hang down to any point on the Earth's surface. Vehicles can climb up these 'ladders' into orbit, or can accelerate along the rings. The concept of such Orbital Ring Systems is examined and extended; a large family of possible configurations exists, including systems in any orientation which precess with the Earth's rotation, eccentric systems which can span any height range, and also Partial Orbital Ring Systems, with end-points on the ground, along which vehicles can be launched directly.

1. BASIC CONCEPTS

1.1 Cables Supported by Earth's Rotation

Various authors, including Artsutanov [1] and Isaacs *et al.* [2], have considered the possibility of dangling a cable from geosynchronous orbit down to the Earth's surface, and using it to hold up a 'heavenly funicular' or 'space elevator.' In geosynchronous orbit, some 36,000 km above the equator, freely orbiting bodies will go around the Earth in exactly one day, and therefore stay directly above the same spot on the equator.

As can be seen in Fig. 1 a very long cable is needed, which must be able to support both its own weight and the weight of the space elevator. Overall support comes from the counterweight, which is situated higher than the geosynchronous orbit and is moving faster than a freely orbiting body there would be. The "centrifugal force" on the counterweight holds up the system.

This scheme has certain disadvantages; for example, since a body can be in geosynchronous orbit only above the

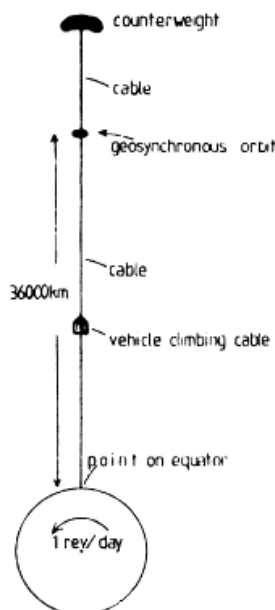

Fig. 1. The Space Elevator Concept.

* The author is now with Marconi Space & Defense Systems Ltd., Stanmore, Middx, HA7 4LY, England.

equator it has often been said that a space elevator cable must have its base on the equator also. In fact, this "disadvantage" is spurious and a geostationary cable could be let down to anywhere on the globe, apart from the polar regions (although an equatorial site would be more convenient). A more important point is that the height to geosynchronous orbit is equivalent to 4900 km in a uniform one-gravity field; this is a very great height from which to suspend a cable (indeed, a uniform cable of fine steel would only support about 25 km of its own length without snapping).

Even with the strongest materials that can be manufactured in quantity today (not including certain ultra-strong 'whiskers' that can be produced only as tiny samples) this scheme is unfortunately not yet practicable.

1.2 Cables Supported by Orbital Rings

The principles of the present design are illustrated in Fig. 2. A massive 'Orbital Ring' is placed in Low Earth Orbit (LEO); it does not need to bear large structural stresses, because it is in 'free-fall' everywhere except at the places where the 'skyhooks' deflect it. These 'skyhooks' ride upon Orbital Rings, supported electro-magnetically, and hold station above specific points on the Earth's surface.

An 'Orbital Ring System' (ORS) has massive rings in a low orbit and skyhooks which are geostationary. Cables are suspended from the skyhooks down to the ground; these form the 'Jacob's Ladders.'

A Jacob's Ladder is much shorter than a cable to geosynchronous orbit would be, and thus does not have to be made of so strong a material. It is within the reach of present-day technology.

In the rest of this study (which, I must emphasise, is only a preliminary and exploratory study of the idea of Orbital Ring Systems) I shall demonstrate the physical principles and develop some of the engineering details of several kinds of ORS. In Part I I shall be concentrating on the theoretical aspects of Orbital Ring Systems and Jacob's Ladders. In Parts II and III I shall be concerned with aspects of engineering, logistics and safety; I shall describe how such Orbital Ring Systems could be built in the very near future and how they could be used to transport large numbers of passengers and large amounts of cargo into space; I shall describe some of their potential uses, and the economic advantages of the highly efficient methods of space transport they allow, which could make conventional launch vehicles and other rocket-propelled craft outmoded.

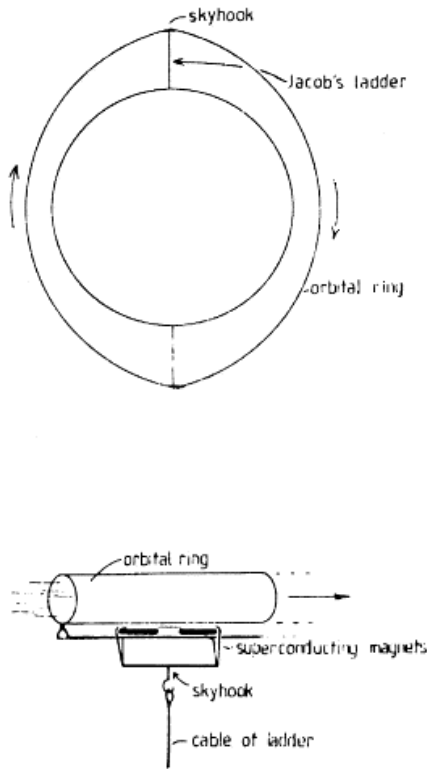

Fig. 2. The Orbital Ring Concept.

2. JACOB'S LADDERS

2.1 Payload of Ladders

The Jacob's Ladders have to carry both the payload and their own weight. The most efficient way of doing this is to use tapering cables, which are therefore thickest where the load is greatest.

Let the skyhook be at altitude H (I shall be using values of 300 km and 600 km as being representative of suitable ORS heights). Then the ladder consists of cables H in length, strong enough to carry a payload F_p . Let Y be the tensile strength and ρ the density of the cables. We need to use materials with as great a value of Y/ρ as practicable, in order to have a high 'payload fraction,' P , which is the ratio of F_p to the gross weight on the skyhook. Let the radius of the Earth be R and its surface gravity be g .

Considering a cable everywhere at its maximum working stress we see from Fig. 3 that

$$F_p = A_0 Y \quad (1)$$

$$\text{Now } \frac{dF}{dh} = \rho g A \quad (2)$$

where a is the acceleration due to gravity.

$$\text{But } \frac{dF}{dh}_{\text{max}} = Y \frac{dA}{dh} \quad (3)$$

So if $F=F_{\text{max}}$ everywhere,

$$Y \frac{dA}{dh} = \rho g A \quad (4)$$

$$\text{Now } a = g \cdot \frac{R^2}{(R+h)^2} \quad (5)$$

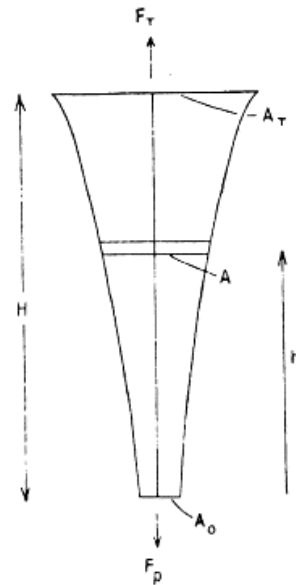

Fig. 3. The Form of a Long Cable.

$$\therefore \int_{A_0}^A \frac{dA}{A} = \int_0^h \frac{\rho g}{Y} \cdot \frac{R^2}{(R+h)^2} dh \quad (6)$$

$$\therefore \ln \frac{A}{A_0} = \frac{\rho g}{Y} \cdot \frac{Rh}{(R+h)} \quad (7)$$

$$\therefore A_T = A_0 \exp \left(\frac{\rho g}{Y} \cdot \frac{H}{(1+H/R)} \right) \quad (8)$$

In terms of forces, or weights,

$$F_T = F_0 \exp \left(\frac{\rho g}{Y} \cdot \frac{H}{(1+H/R)} \right) \quad (9)$$

So the payload fraction F_p/F_T is given by

$$P = \exp \left(\frac{-\rho g}{Y} \cdot \frac{H}{(1+H/R)} \right) \quad (10)$$

Where $H \ll R$ this may be simplified to

$$P = \exp \left(\frac{-\rho g H}{Y} \right) \quad (11)$$

which gives a conservative estimate for P since gravity decreases with height.

Table 1 gives the strength of various materials and values of $1/P$ calculated from both the equations (10) and (11).

It is obvious that the graphite and aluminium oxide 'whiskers' are by far the strongest materials in the list. However, they can not yet be manufactured on a large scale; they show what technological advances can be expected in the future. Steel is not very suitable, though just feasible in the case of $H = 300$ km. Kevlar and fibreglass give much more favourable payload fractions, and can be used with a

TABLE 1. Payload Fractions for Ladders.

Material	10^9Nm^{-2} Y	10^3kgm^{-3} ρ	km (Y/g ρ)	km H	Eq 2.11 1/P	Eq 2.10 1/P	Refs. for Y, ρ
Kevlar®	3.4	1.5	230	300	3.69	3.48	[4]
				600	13.6	10.9	
Glass fibre	3.0	2.25	136	300	9.08	8.22	[5, 6]
				600	82.4	56.5	
Steel	2.0	7.9	26	300	1.0×10^5	6.1×10^4	
				600	1.1×10^{10}	1.5×10^9	
Graphite whisker	21	2.2	980	300	1.36	1.34	[7]
				600	1.84	1.74	
				36000	-	155. *	
Al ₂ O ₃ whisker	21	4.0	535	300	1.75	1.71	[7]
				36000	-	1.0×10^3 *	

* Corrected for centripetal acceleration due to Earth's rotation at the equator - i.e. this is the correct figure for a cable up to geosynchronous orbit.

® Kevlar is a registered trade-mark of DuPont Fibres.

reasonable safety margin. Glass fibre used in the cables should have compressive surface layers and the cable should be jacketed under compression with steel, to prevent cracks and stress concentration (c.f. prestressed concrete and toughened glass). Similar protection should be provided for Kevlar ropes.

2.2 Use of Ladders

Payloads can be carried up the ladders into space by vehicles which use some form of electric motor pushing against the cable (Fig. 4).

A mass-driver is efficient at transferring energy into payloads and is probably the best choice for the ladder's drive mechanism (see Ref. 3 for a description of mass-drivers).

It is apparent that the weight on the supporting skyhook will tend to vary with the payload mass and acceleration. However, this can be countered by a ground station at the foot of the ladder, which exerts a variable tension on the ladder and holds F_T constant (the tension is F_P when no payload is attached and less when a vehicle is climbing the ladder).

2.3 System Throughput

Using the net value of the payload, $F_{PN} \lesssim F_P$, where M_P is the net payload mass and 'a' the actual acceleration (assumed constant), we have

$$F_{PN} = M_P(g+a) \quad (12)$$

Let the time spent climbing the ladder be τ

$$\tau = (2H/a)^{1/2} \quad (13)$$

The System Throughput, S_{TH} , is given by

$$S_{TH} = M_P/\tau \quad (14)$$

Substituting from (12) and (13)

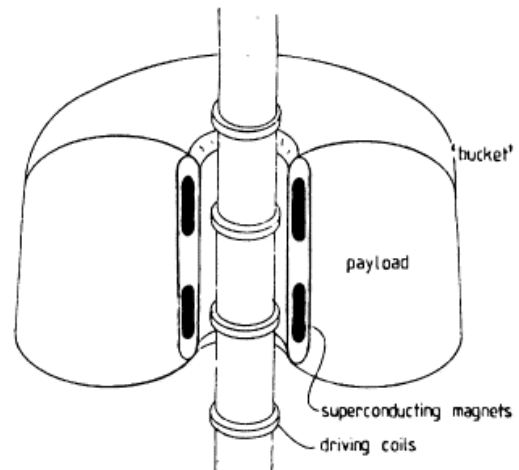

Fig. 4. A Vehicle on a Ladder.

$$S_{TH} = F_{PN}(a/2H)^{1/2}/(a+g) \quad (15)$$

which maximises at $a=g$

Consider also the 'muzzle velocity,' V_m

$$V_m^2 = 2aH \quad (16)$$

and the 'escape velocity,' V_e

$$V_e^2 = 2gR / (R+H) \quad (17)$$

Now $V_m = V_e$ when

$$a = gR^2 / (H(R+H)) \quad (18)$$

Then for $H \ll R_e$, we have the system throughput to escape velocity

$$S_{TH} \approx F_{PN}/(2g(R+H))^{1/2} \quad (19)$$

$$S_{TH} \approx 9 \times 10^{-5} F_{PN} \text{ for } 0 \lesssim H \lesssim 600 \text{ km} \quad (20)$$

For passengers we want a $\approx 1 \text{ ms}^{-2}$, a gentle ride. If necessary, the passenger vehicle can decelerate at around 20 ms^{-2} near the top, to bring it to a halt at the top of the ladder. Since $a \ll g$

$$S_{TH} \approx F_{PN} (a/2H)^{1/2} / g \quad (21)$$

This is not a very good approximation since in fact the acceleration would be increased as gravity weakened with height. However, putting $H=600 \text{ km}$ into (21) gives a reasonable lower limit to S_{TH}

$$S_{TH} \approx 9 \times 10^{-5} F_{PN} \quad (22)$$

The true value will not be much higher – notice that from (15) the maximum throughput is given by

$$\begin{aligned} S_{TH \text{ max}} &= F_{PN} / (8gH)^{1/2} = 1.5 \times 10^{-4} F_{PN}, H=600 \text{ km} \\ &= 2.0 \times 10^{-4} F_{PN}, H=300 \text{ km} \end{aligned} \quad (23)$$

A reasonable overall figure is therefore

$$S_{TH} \approx 10^{-4} F_{PN} \quad (24)$$

Consider the energy cost to escape velocity.

$$\text{Specific energy} = \frac{1}{2} V_e^2 = gR \quad (25)$$

$$\text{Specific energy} \approx 62 \text{ MJ kg}^{-1} \approx 17 \text{ kW hr/kg} \quad (26)$$

$$\therefore \text{Power required to maintain throughput} \approx 6000 F_{PN} \quad (27)$$

Because the energy cost to orbit is only half as much, I shall use a round figure of about $5 \times 10^3 F_{PN}$ for the power requirement.

2.4 Effect of Weather on Ladders

Wind can produce a sideways force at the bottom end of the ladder, where it passes through the lower atmosphere. According to Newton's model any surface element placed in an airstream removes the component of momentum of the undisturbed airflow perpendicular to the surface.

If we assume uniform velocity and density over a scale height h_s we have

$$F = V^2 \rho_{\text{air}} r h_s \pi / 2 \quad (28)$$

Table 2 shows how this wind force is always less than F_p ; the ladder will be blown only a little way out of the vertical even in a hurricane.

Equation (28) corresponds to a drag coefficient for the cylinder

$$C_D = 1 \quad (29)$$

Measurements show that $C_D \approx 1$ over the range of Reynolds Number, $Re \sim 10^2$ to 3×10^5 , with a dip down to $C_D \sim 1/3$ at the onset of turbulent flow at $Re \sim 5 \times 10^5$. The Reynolds Number is defined by

$$Re = \rho LV/\eta \quad (30)$$

TABLE 2. Wind Force on Ladders.

Conditions	V	$\rho_{\text{air}} h_s$	r	F_{wind}
	ms^{-1}	kg m^{-2}	m	N
Maximum (1)	100	1×10^4	0.05	7.9×10^6
			0.1	1.6×10^7
			3	4.7×10^8
Jet stream (2)	60	2×10^3	0.05	5.7×10^5
			0.1	1.1×10^6
			3	3.4×10^7
Hurricane (3)	50	1×10^3	0.05	2.0×10^5
			0.1	3.9×10^5
			3	1.2×10^7

Notes:

- (1) This is equivalent to the maximum wind-speed in a tornado, uniform throughout the whole height of the atmosphere.
- (2) This is applicable where the ladder passes through the central portion of a major jet-stream. There will be a smooth and essentially constant flow.
- (3) This is about the worst 'unpredictable' wind condition the ladder is likely to have to face.
- (4) Reference for wind conditions is NASA TM 78118.

TABLE 3. Oscillations of Ladders.

Transverse Waves				
Material	V_t (1)	τ_{atmos} (2)	H	τ_1 (3)
-	kms^{-1}	s	km	s
Kevlar	1.5	6.6	300	400
			600	800
Fibreglass	1.2	8.3	300	500
			600	1000

Vibration of Tubular Ladders (4)

r_0 (4)	d/r_0 (4)	ρ_L (5)	V_s (6)	ν_1 (7)
m	-	kg m^{-3}	ms^{-1}	Hz
0.1	0.02	8.3×10^4	15	49
3	0.03	5.8×10^4	27	2.9

Notes:

- (1) $V_t = (T/\mu)^{1/2} = (Y/\rho)^{1/2}$
- (2) Time for waves to pass through atmosphere (nominally 10 km high).
- (3) Longest eigenperiod of standing waves ($\lambda = 2H$)
- (4) Tubular ladders as in Appendix 1. r_0 is the radius, d the thickness of the hoops which withstand atmospheric pressure on the tube.
- (5) This density is high because it includes the mass of the Kevlar support cables which 'load' the vibration of the hoops.
- (6) $V_s = 0.493 (d/r_0) (E/\rho_L)^{1/2}$ Young's Modulus for steel, $E = 2 \times 10^{11} \text{ Nm}^{-2}$.
- (7) The frequency of the first eigenmode. $\nu_1 = 0.157 (d/r_0^2) (E/\rho_L)^{1/2}$.

where η is the viscosity, ρ the density, V the velocity and L a characteristic scale size. For a cylinder of 0.1 m radius in a 100 ms^{-1} wind $Re \approx 10^6$ at sea level, so Newton's model and Eq. (28) are good approximations here.

Wind can also cause oscillations in the ladder; it is necessary to ask whether resonance effects can cause the collapse of the ladder. Transverse waves on a stretched string have a velocity, V_t , where

$$V_t = (T/\mu)^{1/2} \tag{31}$$

Table 3 gives typical values for ladder oscillations. Since only the lowest part of the ladder can be excited directly by the wind, modes up to 500th overtone would be excited, with periods down to around a second. It would be hard to build up a resonance in these conditions. Moreover, the skyhook and Earth connections can be made resistive and matched to the line impedance – if necessary, by active displacement following. Then no standing waves can be set up and any travelling waves have to build up their amplitude in $\sim 10 \text{ km}$ of atmosphere (~ 0.7 seconds).

In tubular ladders an additional mode (or set of eigenmodes) of vibration exists – see Appendix 1.

Evidently, a Jacob's ladder can be taken safely through the atmosphere and down to sea level; wind and weather should not harm it.

3. ORBITAL RING SYSTEMS (ORS)

3.1 Orbital Rings

For stress-free operation an orbital ring must be in free-fall, except at the location of the skyhooks. Figure 5 shows the minimum system, one containing two skyhooks. The ring's "orbit" is composed of the innermost sections of two eccentric orbits. These orbits are shown as being elliptical; they could be hyperbolic. The ring "changes track" at the position of the skyhooks, altering course through an angle $\Delta\theta$.

Let the ring have line density m and orbital velocity V_0 . Then, taking $H \ll R$, we know that $\Delta\theta$ is small.

$$\therefore \text{Mass flow past skyhook} = mV_0 \tag{32}$$

$$\& \text{Velocity change at skyhook} = V_0\Delta\theta \tag{33}$$

$$\therefore \text{Rate of change of momentum} = mV_0^2 \Delta\theta \tag{34}$$

So, by NSL

$$F_T = mV_0^2 \Delta\theta \tag{35}$$

We can calculate $\Delta\theta$ (see Fig. 6) using the equation for a conic, which is the form of an orbit in a square-law field.

$$1/r = a \cos\phi + b \tag{36}$$

So, at perigee, where $r = R+H-\Delta H$ and $\phi=0$, we have

$$a+b = 1 / (R+H-\Delta H) \tag{37}$$

Likewise, at the skyhook, where $r = R+H$

$$a \cos\alpha + b = 1 / (R+H) \tag{38}$$

Note that we have included cases where there are more than two skyhooks; this analysis applies to each independently.

Now from (36) we obtain the slope relative to the local vertical,

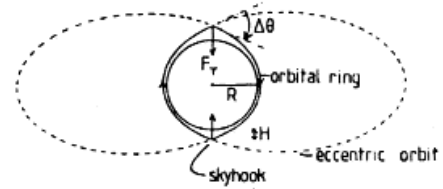

Fig. 5. An Orbital Ring System with two Skyhooks.

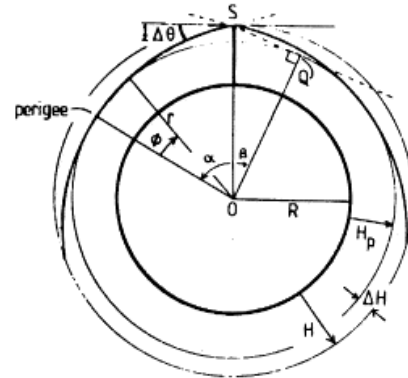

Fig. 6. Geometry of an Orbital Ring System.

$$\frac{1}{r} \cdot \frac{dr}{d\phi} = \frac{a \sin\phi}{(a \cos\phi + b)} \tag{39}$$

At the skyhook, then

$$\tan \frac{\Delta\theta}{2} = \frac{a \sin\alpha}{(a \cos\alpha + b)} \tag{40}$$

Substituting from (37) and (38) and simplifying

$$\tan \frac{\Delta\theta}{2} = \frac{\Delta H}{(R+H-\Delta H)} \cdot \frac{(1+\cos\alpha)}{\sin\alpha} \tag{41}$$

When $\Delta\theta$ is small we have

$$\Delta\theta = \frac{2\Delta H}{(R+H-\Delta H)} \frac{(1+\cos\alpha)}{\sin\alpha} \tag{42}$$

There exists an approximation for small angles,

$$\frac{2}{\alpha} \approx \frac{1+\cos\alpha}{\sin\alpha} \tag{43}$$

which is still quite reasonable at $\alpha = \pi/2$

So, assuming $\Delta H \ll R$,

$$\Delta\theta = \frac{4\Delta H}{\alpha(R+H)} \tag{44}$$

There is an upper limit on $\Delta\theta$; this is the angle 2β (Fig. 6), since $\Delta\theta = 2\beta$ when the orbit lies on the straight line SQ ($V_o \rightarrow \infty$).

$$\cos\beta = \frac{R+H-\Delta H}{R+H} \tag{45}$$

$$\therefore \beta^2 = \frac{2\Delta H}{(R+H)} \tag{46}$$

That is
$$\Delta\theta \lesssim 2 \left(\frac{2\Delta H}{(R+H)} \right)^{1/2} \tag{47}$$

We may reinterpret this, with (44), as an upper limit of ΔH and $\Delta\theta$ as functions of the perigee angle ' α '.

$$\Delta H \lesssim \frac{1}{2}\alpha^2 (R+H) \tag{48}$$

$$\therefore \Delta\theta \lesssim 2\alpha \tag{49}$$

The result (49) is also obvious by inspection of the angles of a polyhedron, which is the limiting case of an ORS with many skyhooks and high orbital velocity ($V_o \rightarrow \infty$). Notice that the maximum number of skyhooks for a given $\Delta\theta$ is $2\pi/\Delta\theta$; however $\Delta\theta$ can be decreased while maintaining constant F_T if V_o is increased to compensate.

We can show (see, e.g. Ref. 8) that

$$b = \frac{gR^2}{V_s^2 (R+H)^2} \tag{50}$$

where g is the acceleration due to gravity at the Earth's surface and V_s is the horizontal component of velocity at the skyhook. Since $\Delta\theta$ is small, $V_s \approx V_o$.

Substituting in (37) and (38) we find

$$V_o^2 = \frac{gR^2 (1 - H/(R+H))}{R+H - \Delta H/(1-\cos\alpha)} \tag{51}$$

Recalling that $\Delta H \ll R+H$ we obtain

$$V_o^2 = \frac{gR^2}{R+H+\Delta H (1-1/(1-\cos\alpha))} \tag{52}$$

Approximating $(1-\cos\alpha)$ by $\alpha^2/2$ we have

$$V_o = \frac{gH^2}{R+H+\Delta H (1-2/\alpha^2)} \tag{53}$$

Using (44) and (53) we can write (35) in terms of ΔH and α .

$$F_T = \frac{4 mgR^2 \Delta H/\alpha}{(R+H) (R+H+\Delta H (1-2/\alpha^2))} \tag{54}$$

Table 4 gives values of F_T against values of ΔH and α . It will be seen that there is little difference between $H=300$ km and $H=600$ km. Because the ring is moving faster at perigee than at the skyhook it will need to stretch slightly; let the required fractional extension be ' ϵ '. Then by Kepler's Second Law

$$1 + \epsilon = \Delta H/(R+H-\Delta H) \tag{55}$$

Since $\Delta H \ll R+H$

$$\epsilon = \Delta H/(R+H) \tag{56}$$

To avoid undue strain it is better to avoid the larger values of ΔH . However, there is no difficulty in arranging a ring which is extensible by perhaps 1% without fatigue (it need not be solid) and with a low value of Young's Modulus. The latter consideration avoids tension in the ring with consequent distortion of the orbit.

Hitherto we have tacitly assumed that all skyhooks bear the same weight, F_T . This need not be so (see Fig. 7). The perigee swings towards the lighter of a pair of skyhooks, but the previous analysis still holds for the respective values of H , ΔH , α and F_T . If at least one 'adjustable' skyhook is used as well, a given pair of skyhooks can have the required F_T and location; the position and weight of the extra skyhook is easily calculated. Notice that the perigee heights are all the same; the difference between the values of ΔH comes from differences in the height of the skyhooks.

$$H_p = H-\Delta H = (\text{constant around ORS}) \tag{57}$$

3.2 Possible Orbital Planes of an ORS

Whereas a ladder hanging from geosynchronous orbit is best situated above the equator, an ORS can be made at any

TABLE 4. Permissible Skyhook Weights.

H	300			600			km
ΔH	3	30	300	3	30	300	km
π/α	$F_T \cdot 10^{-9}$	$F_T \cdot 10^{-10}$	$F_T \cdot 10^{-11}$	$F_T \cdot 10^{-9}$	$F_T \cdot 10^{-10}$	$F_T \cdot 10^{-11}$	N
2	0.54	0.54	0.54	0.49	0.49	0.49	
4	1.08	1.09	1.19	0.99	0.99	1.09	
8	2.16	2.27	4.63	1.98	2.07	4.04	
16	4.40	5.64	-	4.02	5.03	-	
32	9.47	114.0	-	8.64	68.47	-	
64	27.33	-	-	24.42	-	-	

$m = 2.5 \pi \times 10^3 \text{ kg m}^{-1}$; $g = 9.81 \text{ ms}^{-2}$. F_T calculated by Eq. (54).

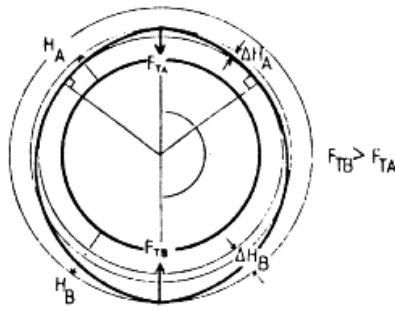

Fig. 7. An Orbital Ring System with Skyhooks of unequal weight.

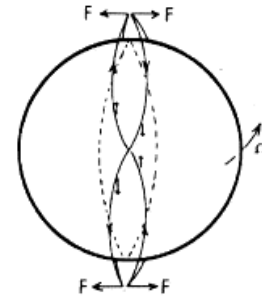
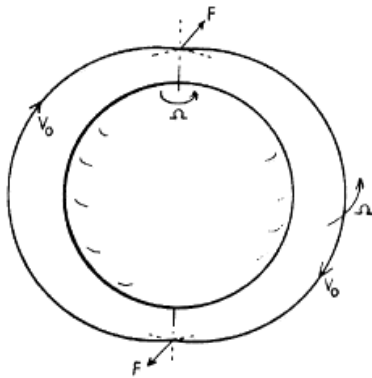
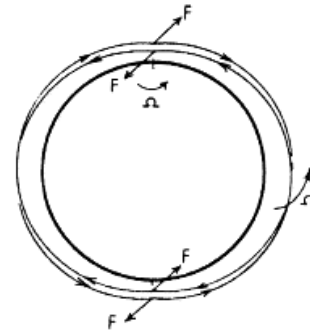

Fig. 9. Precession of counter-rotating Rings.

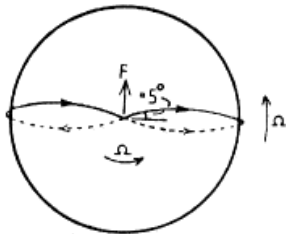

Fig. 8. Precession of an Orbital Ring.

attitude. A useful possibility is an ORS in a polar orbit.

Figure 8 shows what is needed; a force, F , applied at the poles, causes the ring to precess at a rate which can be made equal to the rotation rate of the Earth. The ring is then "geostationary."

Applying the law of precession ($\underline{G} = I \underline{\Omega} \times \underline{\omega}$) we find

$$2F(R+H) = M(R+H)^2 \Omega V_o / (R+H) \quad (58)$$

where M is the mass of the ring and Ω the precession rate (equals $2\pi/\text{day}$ for Earth polar orbit). Thus

$$F = M\Omega V_o / 2 \quad (59)$$

In Fig. 9 the ORS is shown to be composed of two counter-rotating rings, with a net angular momentum of zero. The precessing forces on the two rings are thus equal and opposite; there is no net couple and no work is done to initiate or maintain precession. The force between the rings may be mediated by a skyhook structure at each pole.

It will be seen that the rings are bent through an angle at

the point of application of the precessing force. This angle, ϕ_p , is given by

$$\phi_p = \pi\Omega (R+H) / V_o \quad (60)$$

$$\text{So } \phi_p \approx 10^\circ \quad (61)$$

Because the two rings are counter-rotating they diverge after passing through the poles. Their paths cross at the equator (see Fig. 9). Between equator and pole the rings reach a maximum separation of about 360 km at latitude 23.4° .

Because the rings come together 90° away from where the couple is applied it is obviously possible to produce the orthogonal couple in the same way and at the same time; the ORS can therefore be steered so as to align its axis in any direction. This control can be used to match to planetary rotation and to correct for perturbations; no reaction mass is used up in moving an ORS by this method.

An ORS in which the component rings move a considerable distance apart can have certain advantages: both rings can hold skyhooks which thus can "cover" a wider area. Nevertheless there are some advantages in having a skyhook suspended from two counter-rotating rings and in having the two rings follow the same path.

In order to have the rings everywhere contiguous it is necessary to apply the correct sideways force at each point. Following Fig. 10 it can be shown that the precessing force per unit length, f , is given by

$$f = m \cdot 2\Omega (r\dot{\theta} \cos\theta + \dot{r} \sin\theta) \quad (62)$$

where the shape of an orbit (in what is now a non-central field of force) follows

$$\ddot{r} - r\dot{\theta}^2 - r\Omega^2 \sin^2\theta = -gR^2/r^2 \quad (63)$$

$$\& \quad r\ddot{\theta} + 2\dot{r}\dot{\theta} - r\Omega^2 \sin\theta \cos\theta = 0 \quad (64)$$

on station.

The higher and more massive an ORS the less atmospheric drag will affect it; however, even a very thin (1 cm) ring at 300 km height will have a long enough lifetime to weather many severe solar maxima if it should lose its source of momentum. Indeed, it would be possible to fly an ORS at rather less than 300 km altitude, perhaps to 150 km (where the number density goes up to 10^{17} m^{-3}). It appears that atmospheric drag and the consequent tendency to orbital decay will not be a problem).

3.4 Electromagnetic Drag on an ORS

Skyhooks may be hung from an ORS by magnetic levitation also, precessing forces can be mediated the same way. There will also be a drag force caused by power-dissipating eddy currents.

Reitz [10] quotes, for levitation above an infinite thin sheet,

$$\frac{F_{\text{DRAG}}}{F_{\text{LIFT}}} = \frac{2}{\sigma\mu_0\delta V} \quad (72)$$

where σ is the conductivity ($\sigma_{\text{Aluminium}} = 3.54 \times 10^7 \Omega^{-1} \text{ m}^{-1}$) and δ is the thickness of the sheet.

We notice that the power loss due to electromagnetic drag is

$$P_E = F_L \cdot (2/\sigma\mu_0\delta) \quad (73)$$

The thickness δ may be limited by the skin depth

$$\delta_{\text{Skin}} = (2/\sigma\mu_0\omega)^{1/2} \quad (74)$$

If we consider a skyhook with overall coil length L , then

$$\omega \sim V_0/L \quad (75)$$

So the minimum length for which δ is effectively the actual thickness is given by

$$L_S = \delta^2 \sigma\mu_0 V_0/2 \quad (76)$$

If the true length is less than L_S it is possible to make use of the full thickness δ by weaving the material in 'Litz wire' form rather than using a solid surface; this holds its resistance down to the DC value.

Table 6 gives some typical values, using aluminium for the conducting sheet. It is evident that the drag is significant and that a good thickness of metal is important. Choosing a thickness of 5 cm, perhaps from a strip of aluminium 20 cm x 5 cm underneath an ORS, and using suitable values from Tables 1 ($1/P = 10$) and 2 ($F_P = 2 \times 10^7$) we find that $P_E = 0.2 \text{ GW}$. This power loss is about ten times the loss by atmospheric drag on a whole ring, but is still only 0.4% of the power required to maintain full throughput for the ladder.

We can see that for a typical ORS in polar orbit (two counter-rotating rings with $r = 1 \text{ m}$, $\rho = 2500 \text{ kgm}^{-3}$) the total precessing force is $\approx 5 \times 10^{11} \text{ N}$; if this is the ORS of the previous paragraph the power loss will be around 500 GW. Although this amount of power is readily available in space it is obviously worthwhile to try to reduce this power requirement.

A high power loss also mitigates against the use of skyhooks for carrying passive loads; it suggests that high payload fractions should be sought and that attention should be given to methods of reducing F_D/F_L .

It is feasible that linear induction motors, used to counter

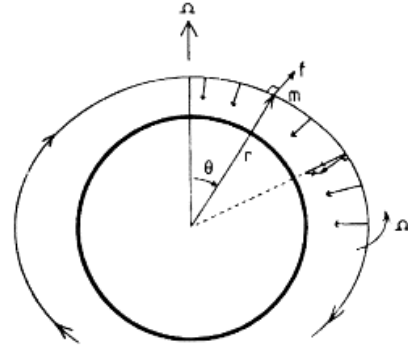

Fig. 10. Precession of a Continuous Orbital Ring System.

the drag force, could be arranged to cancel most of the eddy current, thereby reducing power dissipation.

Powell & Danby [11] have suggested a magnetic levitation scheme in which the "roadbed" consists of coils containing series inductance and a diode. They claim to have improved F_D/F_L by an order of magnitude.

A superconducting layer on the ORS would provide a surface above which a skyhook could ride without any drag force. Power dissipation would be reduced to cryogenic losses, about 100 MW for the whole ORS; the power to the cryostat therefore needs to be about 10 GW (rejecting to the 300 K of the Earth's surface), although it could be very much more efficient if the heat can be rejected to the 3 K of deep space. Neither additional skyhooks nor precessing magnets would increase this loss.

The Earth's magnetic field will also cause electromagnetic drag but since this field is so small ($B \sim 10^{-4} \text{ T}$) the loss is negligible (less than 100 kW).

3.5 Structure of Skyhooks and the ORS

The skyhook will obtain its lift by using superconducting coils to produce a persistent magnetic field; these will float above a diamagnetic surface.

If a is the length of the lift coils, and b their width, the lift force is

$$F_L = B^2 ab/\mu_0 = I^2 a\mu_0/\pi z_0 \quad (77)$$

where z_0 is the height at which the coils float above the "roadbed."

There is obviously a limit to the magnetic field we can use; in the case of Nb_3Sn superconductor a field of 3.5 T leaves a large safety margin in F_L . Also, if the current density is limited to a value of $2.5 \times 10^8 \text{ Am}^{-2}$, with an average mass density of $4.53 \times 10^3 \text{ kgm}^{-3}$ [3], then the coils will be limited to a certain maximum current at a particular effective height from the plane. Let J be the current density. Then

$$(I^2/z_0)_{\text{max}} \approx \frac{1}{2} J^2 b^3 \quad (78)$$

So there are two approximate limits on the load per unit length

$$\frac{F_L}{a} \lesssim \begin{matrix} 1 \times 10^7 b \\ 1 \times 10^{10} b^3 \end{matrix} \quad \text{for } \begin{matrix} \text{magnetic field} \\ \text{current density} \end{matrix} \quad (79)$$

The magnetic field limit dominates for $b > 3 \text{ cm}$ and this condition will usually be satisfied. Note that the value of b in the magnetic field limit is really the width of the track and not of the coil windings; thus the magnetic field limit can always be made to apply by using skyhook coils big

TABLE 5. Atmospheric Drag

CONDITIONS	H km	$\log_{10} n$ m^{-3}	$\tau_o(1)$ s	$\tau_o(1)$ yr	$P_A(1, 4)$ W
Solar maximum (2)	300	15.2	1.9×10^{11}	6.0×10^3	1.1×10^8
	600	14.1	2.4×10^{12}	7.5×10^4	9.3×10^6
Average (3)	300	14.7	6.0×10^{11}	1.9×10^4	3.5×10^7
	600	12.5	9.4×10^{13}	3.0×10^6	2.3×10^5

Notes:

- (1) Decay times and power losses are calculated using ring parameters $r = 1m$, $\rho = 2.5 \times 10^3 \text{ kg m}^{-3}$. Hence $m = 2.5 \pi \times 10^3 \text{ kg m}^{-1}$.
- (2) This is for a very severe solar maximum, with exceptionally high solar and geomagnetic activity ($F > 200$, $A_p > 30$).
- (3) This is for the '1976 Standard' conditions [9]. (4) Uses $V_o = 8 \times 10^3 \text{ ms}^{-1}$.

We shall not attempt to solve these equations quantitatively, but note that a circular orbit gains an equatorial bulge due to rotation about the precession axis. This is shown, rather exaggeratedly, in Fig. 10 where we can see that the effective force (a fictitious resultant of gravity and centrifugal force, in the precessing frame) is everywhere nearly perpendicular to the ring. It will be seen from (62) that the precessing force is equal and opposite for the counter-rotating rings.

Because ($gR^2/r^2 \gg \Omega^2 r$) we may simplify (62) to

$$f = 2m\Omega V_o \cos\theta \quad (65)$$

It is thus apparent that an ORS can be oriented at any attitude, from polar to equatorial orbit. Moreover, it follows that a skyhook can be positioned above any point on Earth; anywhere on the globe can be served by a Jacob's Ladder. A network of many ORSs crossing, for example, at the poles could cover the whole planet with an array of ladders and geosynchronous "satellites."

3.3 Atmospheric Drag on an ORS

An orbital ring will experience drag from the atmosphere. At a height ~ 300 km the mean free path is ~ 1 km; the ORS is thus in the Knudsen regime (diameter \ll mean free path).

Molecules come from a distant "sea" of zero bulk velocity to strike the ring with a relative velocity V_o , on average. Thus each molecule imparts $-\bar{m} V_o$ to the ring, on average

(where \bar{m} is the mean molecular mass).

$$\therefore \text{Rate of transfer of momentum per unit surface area} = -\bar{m} V_o \cdot \frac{n\bar{c}}{4} \quad (66)$$

where n is the number density, and the mean molecular speed \bar{c} is given by

$$\bar{c} = \frac{2}{\sqrt{\pi}} \left(\frac{2kT}{\bar{m}} \right)^{1/2} \quad (67)$$

Using $T = 300K$ as a reasonable approximation from ground level to > 1000 km height, and noting that the dominant species from 100 km to 1000 km is atomic oxygen (atmospheric data is taken from 'US Standard Atmosphere' [9]) we find, in SI units,

$$\text{Rate of transfer of momentum per unit surface area} \approx n \times 3.3 \times 10^{-20} \quad (68)$$

Let the ring have radius r and density ρ .

Then

$$\text{Momentum per unit surface area} = \pi r^2 \rho V_o / (2\pi r) \quad (69)$$

The decay constant, τ_o , is the ratio of the momentum to the rate of loss of momentum.

$$\therefore \tau_o = \frac{r\rho}{n} \left(\frac{\pi}{2mkT} \right)^{1/2} \quad (70)$$

Notice that this independent of V_o . Table 5 gives some typical values of τ_o and also of the power loss, P_A , due to atmospheric drag

$$P_A = V_o^2 nr (R+H) (2\pi)^{3/2} (\bar{m}kT)^{1/2} \quad (71)$$

It is evident that, to maintain an ORS in orbit indefinitely, momentum will have to be supplied. To counter the drag force it is easy to apply equal and opposite accelerating forces to the two counter-rotating rings of an ORS; there is no net change of angular momentum and one ring can "push against" the other. Linear induction motors on skyhooks are ideal for this, as they can also be used to spin up the ORS to higher orbital velocities and to hold the skyhooks

TABLE 6. Electromagnetic Drag.

δ m	F_D/F_L	P_E/F_L WN^{-1}	L_s m
10^0	5.6×10^{-6}	0.045	1.8×10^5
10^{-1}	5.6×10^{-5}	0.45	1.8×10^3
10^{-2}	5.6×10^{-4}	4.5	18
10^{-3}	5.6×10^{-3}	45	0.18

$$\sigma = 3.54 \times 10^7 \Omega^{-1} m^{-1} \text{ (Aluminium)}$$

$$V_o = 8 \times 10^3 \text{ ms}^{-1}$$

TABLE 7. Properties of a Typical Skyhook.

Property	Value	Units
Load, F_L	2×10^8	N
Coil width, b	0.1	m
Coil length, a	200	m
F_L/a	1×10^6	Nm^{-1}
Current, I	2.5×10^5	A
Height, Z_0	2.5×10^{-2}	m
Winding cross section(2)	1×10^{-3}	m^2
Coil mass	4×10^3	kg
Lift to weight ratio (3)	5×10^3	-
Heat leakage (4)	1×10^3	W
Cryostat (4)	1×10^5	W
Cryostat mass (5)	1×10^3	kg

Notes:

- (1) See Section 3.5; the magnetic field limit is set at 3.5T, while the superconductor is a Nb_3Sn composite with $J = 2.5 \times 10^8 \text{ Am}^{-2}$ and $\rho_{av} = 4.53 \times 10^3 \text{ kg m}^{-3}$.
- (2) Cut through one side of coil; total is four times this value.
- (3) Assumes acceleration due to gravity = 10 ms^{-2} .
- (4) A conservative estimate, assuming sink temperature = 300 K. The power requirement may be very much less.
- (5) Includes cryostat power supply mass.

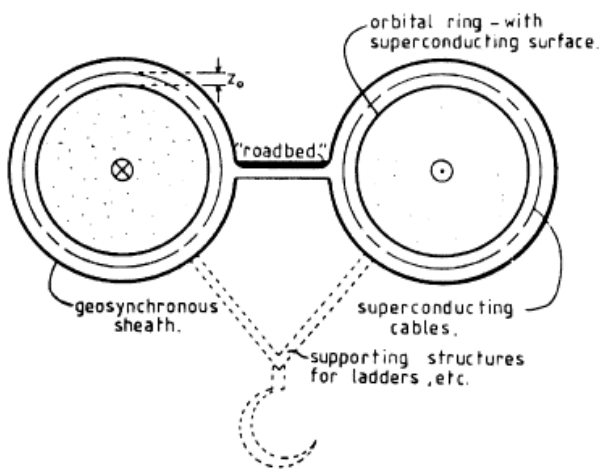

Fig. 11. A continuous Skyhook ORS.

enough to generate 3.5 T across the width of the "roadbed." An ORS consisting of 1 millimetre diameter wire would still, by (79), be able to support 10^4 Nm^{-1} , but would need levitating coils some 3 cm in diameter. Table 7 gives some typical values.

It is apparent that the load on a skyhook could be shared between the counter-rotating rings of the ORS. The drag force would then be in opposite directions and tend to cancel, making it easier to keep the skyhook on station (see Section 7. 1), though of course the drag power loss is the same.

3. 6 Continuous Skyhook ORS

Consider an ORS composed of two counter-rotating rings

and a geosynchronous sheath (Fig. 11); the sheath has to be supported by the inner rings and forms a continuous skyhook structure.

The lift forces on the "skyhook ring," as well as precessing and stabilising forces, are produced by passing current through strips of superconducting cables around the sheath; these induce opposing currents in the superconducting surface of the orbital rings. The superconductors are protected against transient magnetic fields by eddy-current shields.

For a single ring, with a current I ,

$$\text{Force/unit length} = (I^2/z_0) (\mu_0/4\pi) \quad (80)$$

The central "roadbed" is suitable for accelerating vehicles along the ORS by linear induction motors; it would probably be made of steel-jacketed aluminium. The geosynchronous ring is of quite sturdy and massive construction to facilitate its use as a continuous skyhook.

The orbital rings do not need active cryogenic equipment to maintain their superconductors, since they are enclosed in the "vacuum flask" of the fixed ring. Insulation is only needed on the outside, and the cryostats are conveniently stationary on their continuous skyhook.

Table 8 gives some typical values for this kind of ORS.

There is no need to restrict a continuous skyhook ORS to having only two orbital rings; if the system were expanded to four rings in all then it would be simple to "spin down" a ring to geosynchronous for repairs or maintenance, balanced by spinning up the spare ring to replace it. Having still more rings would increase redundancy and versatility.

4. ECCENTRIC ORBITAL RING SYSTEMS (EORS)

4. 1 Eccentric Orbital Rings

An orbital ring need not be deployed in a nearly circular orbit. It is possible to use a highly eccentric orbit, such as one reaching up to the height of a geosynchronous orbit and down to LEO. In this case the orbital speed changes drastically between apogee and perigee; for the ring to remain stress-free it must change its specific length in proportion to its speed.

Analogues are incompressible fluid flow in pipes ('velocity' inversely proportional to 'cross-sectional area') and the 'travelators' found in some airports.

The change in length can be achieved by the 'travelator' method, or by the braiding of a 'chinese finger.' However, the simplest technique uses the principle of a 'telescopic aerial' - a series of overlapping sections (Fig. 12).

The attainable ratio of specific lengths and speeds is simply the number of sections in a 'unit cell.' The telescopic sections and main mass can be arranged in various ways for ease of construction or guidance or the use of roadbeds. By making the cells small compared to the length of a skyhook the latter can be given a smooth ride; a continuous skyhook arrangement is also feasible.

By having the sections move on simple rollers or even frictionless magnetic fields, for example, wear and tear can be kept very low. Because there is no weight to cause friction between sections they will move very smoothly; power loss will be negligible.

We can calculate the total Mass, M , of such a ring as follows. Let the line density at apogee be m_{ap} . The apogee distance is r_{max} , the perigee distance is r_{min} . Let 'dl' be a distance element along the ring and define

$$e \equiv r_{max}/r_{min} \quad (81)$$

TABLE 8. Properties of a Typical Continuous-Skyhook ORS.

Property	Orbital Ring	Geosynchronous Ring	Units
Mass per unit length	7.9×10^3	2.5×10^3	kg m^{-1}
Cryogenic heat loss (2)	-	10	Wm^{-1}
– total	-	5×10^8	W
Power to cryostats (2)	-	5×10^{10}	W
Clearance, Z_0		5.0×10^{-2}	m
	Precession	Support	
Force per unit length (3)	9.2×10^3	2.5×10^4	Nm^{-1}
Current . I (3)	6.8×10^4	1.1×10^5	A
Superconductor (4) mass (3)	1.2	2.0	kg m^{-1}
– total per ring (3)	5.3×10^7	8.8×10^7	kg
– total for ORS		5.6×10^8	kg

Notes:

- (1) The ORS is as shown in Fig.11 ; the orbital rings are 1m radius, with $\rho = 2.5 \times 10^3 \text{ kg m}^{-3}$.
- (2) A conservative estimate, assuming sink temperature = 300 K. Multi-layer vacuum insulation is assumed.
- (3) These figures pertain to a single orbital ring; the overall superconductor masses are four times as much (double for the geosynchronous ring, double again for two orbital rings).
- (4) The superconductor is a Nb_3Sn composite, with $J = 2.5 \times 10^8 \text{ A m}^{-2}$ and $\rho_{av} = 4.53 \times 10^7 \text{ kg m}^{-3}$.

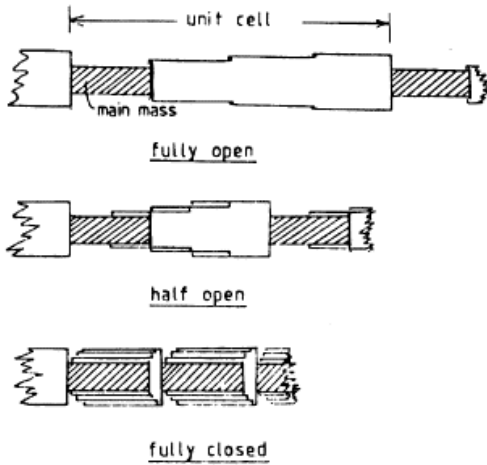

Fig. 12. Sections of an Eccentric Orbital Ring System.

Then, substituting in Eq. (36) we have

$$r = \frac{2r_{\min} \cdot e}{(e+1) + (e-1) \cos\phi} \quad (82)$$

Now

$$m \propto 1/V_0 \quad (83)$$

and, by Kepler's Second Law

$$V_0 \propto \frac{1}{r} \cdot \frac{dl}{rd\phi} \quad (84)$$

$$\therefore m = \frac{m_{ap}}{e} \frac{r^2}{r_{\min}} \cdot \frac{d\phi}{dl} \quad (85)$$

Integrating over the ring,

$$M = \oint \frac{m_{ap}}{e} \frac{r^2}{r_{\min}} \cdot \frac{d\phi}{dl} \cdot dl \quad (86)$$

Substituting from (82) we have

$$M = 8m_{ap}r_{\min}e \int_0^\pi \frac{d\phi}{[(e+1)+(e-1)\cos\phi]^2} \quad (87)$$

Solving the integral we obtain

$$M = \pi m_{ap} r_{\min} (e^{1/2} + e^{-1/2}) \quad (88)$$

 Notice that when the ellipse reduces to a circle ($e=1$) the right-hand side of Eq. (88) simplifies to $2\pi mr$.

4.2 EORS Skyhooks

It can be seen from Fig. 13 that a Skyhook on an EORS does not, in general, hang perpendicularly from the ring. That is to say, there is a component of the rate of change of momentum along the line of the ring.

Thus the speed of the ring, as shown here, increases on passing the skyhook. The skyhook must use its linear induction motor to stop itself sliding down the ring; it must also supply energy to the ring to accelerate it. However, a counter-rotating ring will have its speed decreased in the same way. Between the two rings of the EORS, then, the skyhook will do no net work.

If the orbital parameters to one side of the skyhook are

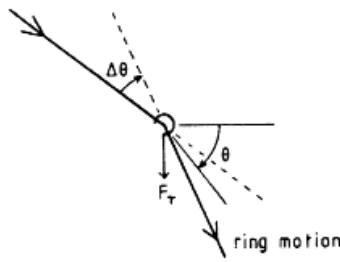

Fig. 13. Skyhook on an Eccentric Orbital Ring System.

m_a, V_a and θ_a we have the exact result

$$F_T = \frac{m_a V_a^2 \tan \Delta\theta}{(\cos \theta_a - \sin \theta_a \cdot \tan \Delta\theta)} \quad (89)$$

which, for small $\Delta\theta$, simplifies to

$$F_T = m V_a^2 \Delta\theta / \cos \theta \quad (90)$$

Inserting $(\theta_a = -\Delta\theta/2)$ into Eq. (89) we obtain the exact solution for the symmetrical "non-eccentric" case:

$$F_T = 2m V_a^2 \sin(\Delta\theta/2) \quad (91)$$

Equation (35) is the small angle approximation of this.

4.3 Possible Eccentric Orbits

In Section 3 it was more or less assumed that the minimum number of skyhooks on a ring is two; this is necessary in order to obtain a closed orbit. However, an eccentric orbit need not be closed; an EORS is possible with only one skyhook (an ORS could also be deployed without any skyhooks – but this would be rather pointless).

Figure 14 gives an indication of what happens when we try to load an ORS with a single skyhook. Left to itself, the ring would pass the skyhook position along the line AS. When the skyhook has changed its path through an angle to SS' the ring will go around its orbit and return along BS. Now let the skyhook gradually increase its weight from zero to the full value, but in less time than it takes the ring to make an orbit. At this point the ring follows the path AAS' though the skyhook. But as more of the ring completes its orbit the path of the incoming ring (PS) swings from AS towards BS. Thus the net force of the skyhook is directed downwards and to the right, tending to make the skyhook precess along the ring.

In the steady state the orbit precesses by an angle β every revolution; substituting in Eq. (40) using (36) and (81) we have

$$\tan(\Delta\theta/2) = \frac{(e-1) \sin(\beta/2)}{(e+1) + (e-1)\cos(\beta/2)} \quad (92)$$

Letting $t = \tan(\Delta\theta/2)$ and $k = (e+1)/(e-1)$, and solving for β ,

$$\cos(\beta/2) = ((1-t^2(1+k^2))^{1/2} - t^2k)/(1+t^2) \quad (93)$$

When $\Delta\theta$ is small we have

$$\beta = \Delta\theta (3e^2 - 2e + 1)^{1/2} / (e - 1) \quad (94)$$

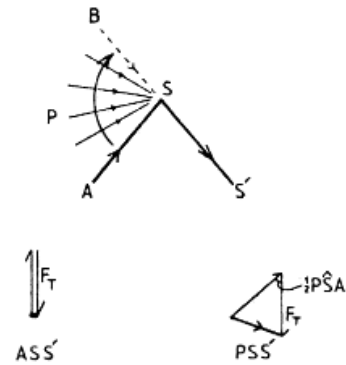

Fig. 14. Precession effect on Single-Skyhook ORS.

The same precession rate is found when $\Delta\theta$ is negative, that is, when the skyhook pushes up on the ring; the precession is of course in the opposite direction. Thus, in an ORS with two counter-rotating rings, an overall precession of the ORS can be achieved by a vertical precession force between the two rings.

Referring back to Section 3.2 we can see that, when an ORS is in polar orbit, precession is achieved by a sideways, or horizontal, force; but when the ORS is in an equatorial orbit precession is produced by a vertical force of similar magnitude. In between, the force is applied at an intermediate angle. Where only one skyhook is used the 'equatorial precession force' is given by

$$F = \frac{M\Omega V_o (e-1)}{(3e^2 - 2e + 1)} \quad (95)$$

The corresponding forces required when more than one skyhook is used are easily calculated.

In Fig. 15 some kinds of precessing EORS are shown. In (a) the rings are precessing equatorially and vertical forces between the rings are required; (b) is an EORS in polar orbit; and (c) and (d) are symmetrical versions; (c) has to be supported by 'inverse skyhooks' at the poles; (d) can support weight at the poles and can be in a single "strand" as shown or can have inner and outer ring systems separate – for clarity the precession forces are not shown for (d).

Although an EORS can easily extend out to "geosynchronous orbit" it will not be able to precess with the Earth, because "centrifugal force" would overcome the inwards gravitational force at apogee. The limitation could be removed by having a skyhook at apogee to pull the ring down again; but the skyhook would have to be loaded by pushing against another ring, say, since a simple mass would be in free-fall, in geosynchronous orbit.

5. PARTIAL ORBITAL RING SYSTEMS (PORS)

5.1 The Rationale for a PORS

A standard, full, Orbital Ring System has several potential disadvantages. The first is that of construction; a very large space operation with many rocket launches is needed, even to set up a very small bootstrap system. This may be considered too expensive for an untried technology. Secondly, an ORS, in circling the globe, will pass over many countries; a legal battle over the use of airspace may develop.

Thus it would be useful to have a smaller and cheaper system that could be built without using rockets; and it would be helpful if the system could be constrained to fly

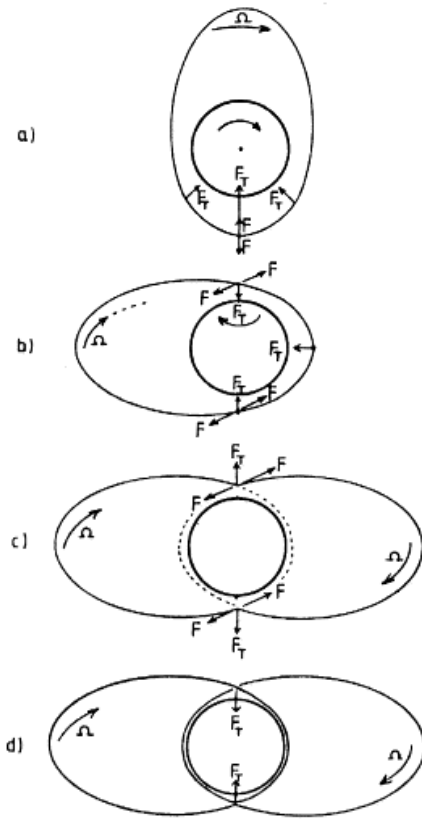

Fig. 15. Some kinds of precessing Eccentric Orbital Ring Systems.

above the ocean, or above friendly territory. The PORs concept addresses and solves these problems.

5.2 The Concept of a PORs

A partial Orbital Ring System does not pass all around the Earth; it has two ends (Fig. 16).

A stream of particles, or a continuous cable, ejected from one of the ground stations with a sub-orbital velocity, will follow a parabolic trajectory, and can be aimed to come down again at the other ground station. On reaching the ground the stream can be reversed and can be sent back to the first ground station alongside its original path. Thus two opposing mass-streams can be formed, and can consist of a single continuous cable; there is no net flow.

The mass-streams or cable are now seen to form part of an Orbital Ring System, with two counter-rotating rings, and a perigee somewhere inside the Earth. They will obey the usual ORS equations, suitably modified, and can bear loads in just the same manner. However, it will not be necessary to have skyhooks or Jacob's Ladders on this system (though they could be used); the PORs itself comes to meet the ground, becoming Bifrost, the bridge of the gods!

The mass-streams themselves might conveniently be made of a braided cable of aluminium, which could readily accommodate the changes in length that will occur between apogee and ground level; this cable can be guided and accelerated by linear induction motors, and superconducting coils used to reverse its direction of motion (Fig. 17).

Because the cable passes through the atmosphere it must be surrounded by an evacuated sheath or tube which is held motionless with respect to the ground, and which can be supported by the moving cables.

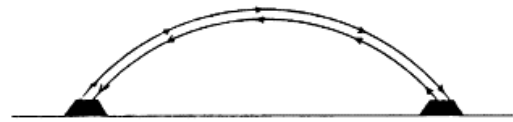

Fig. 16. A Partial Orbital Ring System.

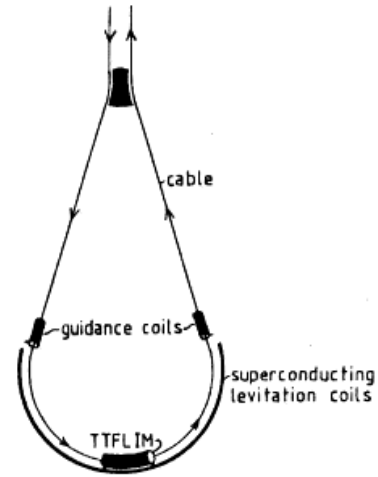

Fig. 17. Cable reversal at the ground station of a PORs.

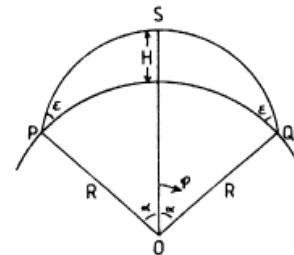

Fig. 18. Geometry of a Partial Orbital Ring System.

5.3 The Path of a PORs

The geometry of a PORs is outlined in Fig. 18; the speed of the mass-stream at S (where it is horizontal) is V_S , and at P & Q (the ground stations) it is V_p .

The partial orbit, as in (36), takes the form

$$1/r = a \cos\phi + b \tag{96}$$

We have

$$1/(H+R) = a + b \tag{97}$$

$$\& \quad b = gR^2/(V_S^2 (R+H)^2) \tag{98}$$

$$\therefore \quad a = (V_S^2 (R+H) - gR^2)/V_S^2 (R+H)^2 \tag{99}$$

This gives

$$r = \frac{(R+H)^2 V_S^2}{(((R+H)V_S^2 - gR^2)\cos\phi + gR^2)} \tag{100}$$

At P & Q then

$$R = \frac{(R+H)^2 V_S^2}{(((R+H)V_S^2 - gR^2)\cos\alpha + gR)} \quad (101)$$

Putting $Z = H/R$ and $C = 1 - \cos\alpha$ we obtain

$$C = Z/(gR/(1+Z)V_S^2 - 1) \quad (102)$$

The slope to the vertical is

$$\frac{1}{r} \cdot \frac{dr}{d\phi} = \text{arsin}\phi \quad (103)$$

So at P & Q

$$\tan E = \frac{\sin\alpha}{(1+Z)} \cdot \left(\frac{gR}{(1+Z)V_S^2} - 1 \right) \quad (104)$$

Now

$$(V_S^2/gR) = (1+Z)^{-1}(1+Z/C)^{-1} \quad (105)$$

Therefore

$$\tan E = \frac{Z}{(1+Z)} \cdot \frac{(1+\cos\alpha)}{\sin\alpha} \quad (106)$$

Now, given α (or the arc $PQ = 2\alpha R$), we may minimise V_p . By the conservation of energy

$$V_p^2 = V_S^2 + 2gH/(1+Z) \quad (107)$$

Substituting for V_S^2 from (105) we obtain

$$(V_p^2/gR) = (2Z + (1+Z/C)^{-1})(1+Z)^{-1} \quad (108)$$

Differentiating this with respect to Z , and setting equal to zero yields

$$Z = (-C + (2C - C^2)^{1/2})/2 \quad (109)$$

This simplifies to

$$Z = (\sin\alpha + \cos\alpha - 1)/2 \quad (110)$$

when

$$\tan E = (1 - \sin\alpha)/\cos\alpha \quad (111)$$

and

$$(V_p^2/gR) = 2\sin\alpha/(1 + \sin\alpha) \quad (112)$$

If the mass-streams of the PORS are loaded with evenly distributed geostationary mass, so that the ratio of the moving to the total line density is μ , the orbit can be calculated from the same equations, by replacing g by the 'effective surface gravity,' g_{eff} , where

$$g_{\text{eff}} = g/\mu \quad (113)$$

That is, the extra weight makes the cable seem heavier. The force on each ground station, applied at an angle E to the ground.

$$F_G = 2m_p V_p^2 \quad (114)$$

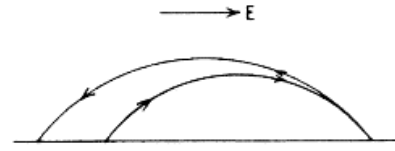

Fig. 19. The Coriolis Effect on a PORS.

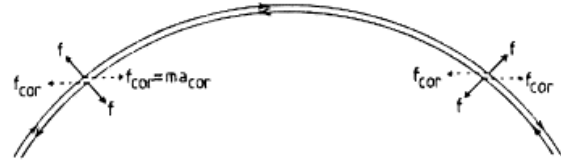

Fig. 20. Countering the Coriolis Effect on a PORS.

where m_p is the line density of the cable at the speed V_p . Using (112) we have, for the optimum case,

$$F_G = 4(m_p/\mu) gR \sin\alpha/(1+\sin\alpha) \quad (115)$$

The total mass of the cable assembly can be obtained by integrating the line density over the whole length. This yields (see Eqs. (121) to (127) for more details).

$$M\mu = 8m_s(R+H) \int_{-\alpha}^{\alpha} ((e+1) + (e-1)\cos\phi)^{-2} d\phi \quad (116)$$

$$\text{where } e = 1 + 2Z/(1+\cos\alpha) \quad (117)$$

Using (105) and (108) to give

$$m_s = m_p (2Z(1+Z/C) + 1)^{1/2} \quad (118)$$

and integrating (116) we obtain

$$M\mu = 4m_p R \frac{(2Z(1+Z/C)+1)^{1/2}}{(1+\cos\alpha+2Z)} \quad (119)$$

$$\times \left(\frac{2(1+\cos\alpha+Z)}{e^{1/2}(1+H)} \tan^{-1} \left(\frac{\tan(\alpha/2)}{e^{1/2}} \right) - Z \sin\alpha \right)$$

In the optimum case, a small angle approximation yields

$$M\mu \approx 4\sqrt{2} m_p \cdot \alpha R \quad (120)$$

5.4 The Effect of Earth's Spin on a PORS

The previous section ignored Coriolis effects, but the spin of the Earth will distort the shape of the orbits slightly, so that the eastward track will differ from the westward (Fig. 19). This effect must be counteracted if a continuous loop is to be set up.

Consider a PORS set up along a line of latitude. In order to make the eastward and westward paths the same the horizontal components of the Coriolis force must be countered (Fig. 20). Forces between the cables, perpendicular to the cables and equal and opposite, can maintain the paths; this can be seen by examining two arguments:

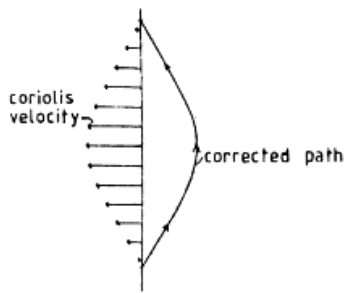

Fig. 21. Correcting for the Coriolis Effect on a PORS.

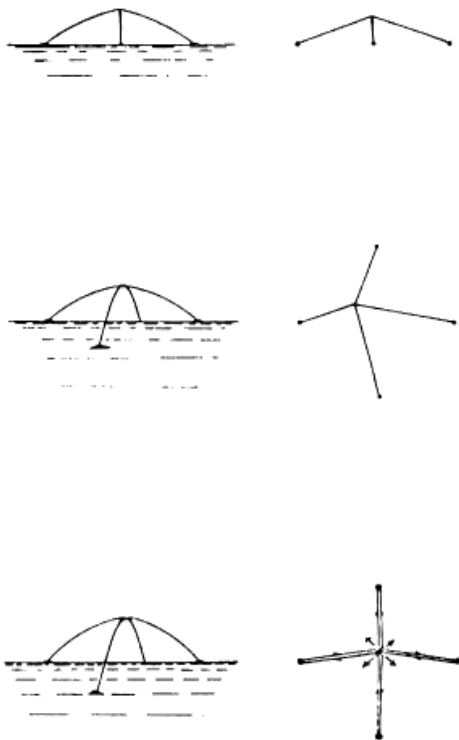

Fig. 22. Steerable versions of a PORS.

- i) Past any point, as much matter is moving up as is moving down; and therefore there is no net Coriolis force.
- ii) At any point, the net centrifugal force depends only upon the radius of curvature and the kinetic energy of the mass-streams, and not upon how the K.E. is divided between the streams.

In other words, if there are riders between the cables then the Coriolis effect will induce forces between them but will not change the overall kinetic energy; so the net centrifugal force and gravitational force will not change, and both streams will follow the same path as if the Earth had no spin.

A PORS set up along a line of longitude, however, is pushed sideways by the Coriolis force; this cannot be countered, only allowed for (Fig. 21). The cables must be aimed slightly eastwards; the Coriolis effect will make them curl back around to the opposite ground station.

A PORS set up in an intermediate direction must use a combination of both schemes; riders to counter the component of forces along the length of the PORS, and adjustment of the launch direction to allow for the sideways drift.

Note that a vehicle launched from an equatorial PORS in an easterly direction gains about 0.5 km s^{-1} from the Earth's spin (more, if $H \gtrsim R$), so that the effective orbital velocity is 7.4 km s^{-1} (corresponding to 27 MJkg^{-1}), whereas for a vehicle launched in the opposite direction it is 8.4 km s^{-1} (35 MJkg^{-1}).

5.5 PORS Improvements

Perhaps the most important limitation of the PORS as described above is that it can only launch vehicles along a single line (in either direction). However, it is likely that a whole range of orbits will ultimately be desired, and it would be a nuisance to have to build a separate PORS for each direction.

Some possible solutions to this problem are shown in Fig. 22. In each case the PORS can be bent in the middle, so that payloads can be sent off in different directions.

In the first a Jacob's Ladder is used. When the PORS is aimed to one side of the line joining the ground stations the ladder is pulled sideways; this generates the force that puts a bend into the path of the PORS. The disadvantage here lies in the additional weight or downwards force produced by the ladder; this increases the power loss considerably.

In the second an extra PORS is used. The crossover position of the two cables can be moved about, so that payloads can be launched in any direction (each of the four arms can be swung through $\sim 90^\circ$). The forces at the crossover point can be partly perpendicular to and partly along the PORSs; the perpendicular components can be applied by superconducting magnets, while the lengthwise ones will need TFLIMs. Apart from eddy-current losses, no power is used in holding a PORS arm at any angle.

In the third only perpendicular forces are used; only superconducting magnets are needed as mediators. The PORSs meet at a point which can be moved around by altering the respective speeds of the component cables. A system containing five ground stations can easily be steered to launch in any direction.

A steerable PORS would be a cheap and flexible launch system.

6. STABILITY OF ORBITAL RING SYSTEMS

6.1 Stability of Skyhook

Consider a skyhook supported by counter-rotating rings. Let the drag force to the left be F_{DL} and to the right be F_{DR} . Then in the steady state the drag forces cancel ($F_{DL} = F_{DR}$) and the skyhook remains stationary. Now let the skyhook be displaced off to the right with velocity V_S and let the orbital velocities of the rings be V_L and V_R .

From Eq. (73) we have (when δ is not limited by skin-depth)

$$F_{DL} \propto (V_L + V_S)^{-1} \quad (121)$$

$$\& \quad F_{DR} \propto (V_R - V_S)^{-1}$$

Since $F_{DL} = F_{DR}$ when $V_S = 0$ we have

$$F_{DL}/F_{DR} = (1 - V_S/V_R)/(1 + V_S/V_L) \quad (122)$$

For small velocities V_S and replacing V_L, V_R by V_O we obtain

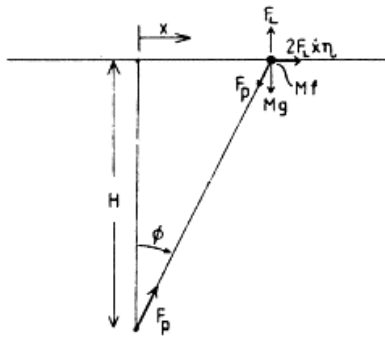

Fig. 23. Resolution of Forces for a Displaced Skyhook.

$$F_{DL}/F_{DR} = 1 - 2 V_S/V_O \tag{123}$$

That is, movement to the right produces increased drag to the right; the system is thus unstable. If δ is limited by skin-depth the effect is only half as much (since $F_D \propto V^{-1/2}$) but is in the same sense.

The onboard linear motors of the skyhook must be controlled actively to hold the forces in balance with the driving forces. Since the overall effect of electromagnetic drag and induction is to provide a small acceleration to the ring (countering atmospheric drag) this will be weakly stable as long as the driving motors are working. Active control of the centre of lift of the skyhook (and therefore the ratio F_{LL}/F_{LR}) can be used to balance the drag force if the linear induction motors should fail.

Let us examine what happens when this instability is not suppressed. Let the sideways displacement of the skyhook be x , the lift force be F_L and the mass of the ladder be M . Let the effective inertial mass of the ladder be M_f . Define

$$\eta \equiv F_D/F_L V_O \tag{124}$$

Following Fig. 23 we have, resolving vertically

$$F_L = Mg + F_p \cos \phi \tag{125}$$

When $x \ll H$, remembering that the payload fraction,

$$P = F_p/(F_p + Mg) \tag{126}$$

we obtain

$$F_L = F_p/P \tag{127}$$

Resolving horizontally

$$M \ddot{x} f = 2F_L \dot{x} \eta - F_p \sin \phi \tag{128}$$

Substitute for F_L from (127) and for M from (126)

$$F_p \cdot (2\dot{x}\eta - (xP/H) - \ddot{x}f(1-P)/g) = 0 \tag{129}$$

Re-arranging,

$$\ddot{x} - \dot{x} \cdot \frac{2g\eta}{f(1-P)} + \frac{x \cdot gP}{Hf(1-P)} = 0 \tag{130}$$

Look for solutions of the form $x = x_0 e^{i\omega t}$

$$\omega^2 + \frac{\omega 2g\eta i}{f(1-P)} - \frac{gP}{Hf(1-P)} = 0 \tag{131}$$

$$\text{Hence } \omega = -\frac{g\eta i}{f(1-P)} \pm \left(\frac{-g^2\eta^2}{f^2(1-P)^2} + \frac{gP}{Hf(1-P)} \right)^{1/2} \tag{132}$$

Now since $F_D \ll F_L$ and $gH \ll V_O^2$

$$g^2\eta^2/f^2(1-P)^2 \ll gP/(Hf(1-P)) \tag{133}$$

Thus we can simplify (132)

$$\omega = -i(g\eta/f(1-P) \pm (gP/(Hf(1-P))))^{1/2} \tag{134}$$

We now calculate f from the centre of mass of the ladder. Let the element of the ladder from height h to $h + dh$ have mass dm .

Then, from (11) $P = \exp(-\rho gh/Y)$ and

$$dm = m_0 \exp(\rho gh/Y) \cdot dh \tag{135}$$

Integrating, we have

$$M = m_0(Y/g\rho) \cdot (\exp(\rho gH/Y) - 1) \tag{136}$$

Substituting from Eq. (11) above

$$m_0 = \frac{MP}{(1-P)} \cdot \frac{g\rho}{Y} \tag{137}$$

Now

$$f = \frac{1}{HM} \int_0^H h \cdot \frac{dm}{dh} dh \tag{138}$$

$$\therefore f = \frac{Pg\rho}{(1-P)HY} \int_0^H h \exp(\rho gh/Y) dh \tag{139}$$

Evaluating the integral we find

$$f = 1/(1-P) + 1/lnP \tag{140}$$

Notice that $f \rightarrow 1/2$ as $P \rightarrow 1$ and that $f \rightarrow 1$ as $P \rightarrow 0$.

So, substituting for f in Eq. (134) we obtain the period of oscillations, τ_p , and the time constant of the exponential growth of oscillations, τ_G .

$$\tau_p = 2\pi (H/g)^{1/2} (1 + (1-P)/lnP)^{1/2} \tag{141}$$

$$\& \tau_G = (1/g\eta) (1 + (1-P)/lnP) \tag{142}$$

The oscillation period depends only upon the height of the ladder (if we consider g and P to be fixed) and the growth time upon η (which is determined principally by F_D/F_L). The dependence upon payload fraction is weak.

If the skyhook is loaded with a simple mass (no ladder) there are no oscillations and the time constant of displacement is τ_D , where $x = x_0 \exp(t/\tau_D)$

$$\tau_D = 1/(2g\eta) \tag{143}$$

Now for a roadbed 5 cm thick, made of Litz wire, $F_D/F_L \approx 10^{-4}$; I have based Table 9 upon this typical value and give values for the oscillation periods and time constants.

We can see that the oscillation period is longer than the longest eigenperiod of transverse standing waves on the ladder, albeit not by a wide margin, so the effect of having a flexible ladder will not alter this analysis greatly. However, the value of the effective mass at the skyhook will be reduced, because of the phase lag in the lower portions of

TABLE 9. Skyhook Oscillations.

F_D/F_L	1.0×10^{-4}				-
η	1.3×10^{-8}				sm ⁻¹
H	300	600			km
1/P	5	10	5	10	-
f	0.629	0.677	0.629	0.677	-
τ_p	7.8×10^2	8.6×10^2	1.1×10^3	1.2×10^3	s
τ_G	4.1×10^6	5.0×10^6	4.1×10^6	5.0×10^6	s
Δ_f	-15	-10	-20	-15	%

Notes:

- (1) Roadbed is 5 cm of aluminium (Litz wire)
- (2) $\eta \equiv F_D/F_L V_O$
- (3) $(\omega/2\pi) = 1/\tau_p - i/\tau_G$
- (4) Δ_f is due to the speed of transverse oscillations on a flexible ladder.

the ladder. Since the ladder is considerably more massive at the top end than at the base the reduction in f will be quite small (less than 30%). The magnitude of this reduction will depend upon details of the ladder structure and particularly upon the behaviour of the ground station, but approximate values are given in the table.

The time constant for growth of oscillation is long – about a month even without any attempt to improve F_D/F_L . This gives ample time for repairs to the drive system to be carried out. Meanwhile another skyhook could be brought up to control the defective one and to damp out the oscillations. It is also likely that, since $Re(\omega) \gg Im(\omega)$, the ground station could provide net damping by allowing some energy-dissipating movement at the foot of the ladder (for example, horizontal vanes dragged through a bath of oil). This damping would be provided anyway, to absorb waves excited by the wind or by an accelerated payload; the overall system of skyhook and ladder would then be stable to drag-induced oscillations.

7.2 Stability of a Continuous Skyhook ORS

Here we consider the stability of an ORS in which the orbital rings are loaded uniformly along their length. This analysis will also apply to systems where the skyhooks are very close together – with the caveat that small-scale phenomena and instabilities may need to be considered separately.

Let the line density of the tube or “skyhook ring” be m_t and the line density of each of the two orbital rings be m_s . Now the orbital rings may be considered to be fluid streams moving in opposite directions with velocity V_O .

We examine the effect of bending the tube and therefore the fluid streams by taking a small section of the tube as in Fig. 24, in which the radius of curvature of the element is r_c . The streams are allowed to rebound elastically at the ends; this is equivalent to letting each stream enter and leave the element.

Let the tension at the ends (due to the rebound) be T and let the outwards centrifugal force be F per unit length.

$$\text{Now } T = 2m_s V_O^2 \quad (144)$$

$$\text{and } F = 2m_s V_O^2 / r_c \quad (145)$$

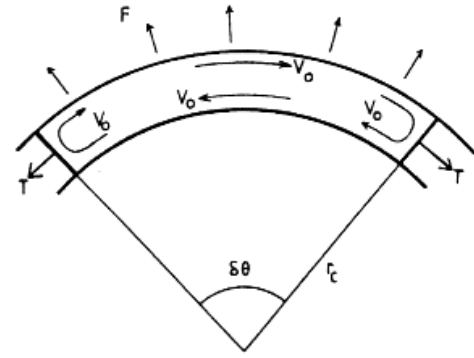

Fig. 24. Stability of a Continuous Skyhook ORS.

The net force per unit length, acting to straighten the tube, is

$$(T/r_c) - F = 0 \quad (146)$$

That is, the tube is dynamically neutral in the absence of external forces. It will not try to straighten itself or to kink. This problem is treated more fully in Ref. 3, from which this result is taken.

However, in order to understand the stability of a continuous-skyhook ORS (which may be likened to an infinitely long mass-driver with zero acceleration) it is necessary to consider the effect of working in a gravitational field.

Let the rings orbit at a distance r from the centre of the gravitating body (eg/Earth) and let the acceleration due to gravity at this level be g_r . Let the total weight per unit length be W ; F has been defined above.

Obviously

$$W = (m_t + 2m_s) g_r \quad (147)$$

and, in equilibrium,

$$W = F \quad (148)$$

Now consider a small deviation in r , so that $r \rightarrow r + dr$. Angular momentum and energy are conserved and the total mass of the rings is unaltered. From this it follows that both line density and orbital velocity decrease. We shall take it that W and F are measured over a fixed angle; that is, over unit length at radius r . This means that they concern a fixed amount of matter, a fixed fraction of the rings. Likewise, m_t and m_s are the line densities at radius r .

$$\therefore dW/dr = (m_t + 2m_s) dg_r/dr \quad (149)$$

From (145) we have

$$dF/dr = 2m_s ((2V_O/r) dV_O/dr - V_O^2/r^2) \quad (150)$$

By conservation of angular momentum the horizontal velocities obey

$$dV_O/dr = -V_O/r \quad (151)$$

$$\therefore dF/dr = 2m_s (-3V_O^2/r^2) \quad (152)$$

But, from (148)

$$2m_s V_O^2/r = (m_t + 2m_s) g_r \quad (153)$$

$$\therefore dF/dr = -3(m_t + 2m_s) g_r/r \quad (154)$$

Let the net force outwards per unit length be $P \equiv F - W$. Then

$$dP/dr = -(m_t + 2m_s) g_r/r \tag{155}$$

We can see that P acts to oppose the change in radius, since $dP \propto -dr$. The combined orbit of the ORS is therefore stable.

By NSL, for a finite displacement Z ,

$$P = (m_t + 2m_s) \ddot{Z} \tag{156}$$

Using (155) and putting $P = 0$ at $Z = 0$ we obtain

$$\ddot{Z} = -(g_r/r) Z \tag{157}$$

which has solutions of the form $Z = Z_0 e^{i\omega t}$ where

$$\omega = (g_r/r)^{1/2} \tag{158}$$

Thus the ORS will undergo radial oscillations about an equilibrium radius if it is perturbed.

In the case of a localised perturbation a shock wave will run out in both directions at velocity V_0 , diminishing as it spreads out the energy of the perturbation. Behind the front radial oscillations will occur. Since the period of an orbit of the shock wave is shorter than an oscillation period (by a factor $(1 + m_t/2m_s)^{1/2}$) there will be a beating effect between them. The effect is like that of striking a suspended metal ring to make it chime.

A simpler oscillation will take place if the whole ORS is pushed inwards and released, in a uniform fashion. The ORS will stay circular, its radius oscillating about its equilibrium value.

Oscillations, once excited by the movements of payloads and so forth, can be damped by various methods. Passive damping at the foot of the ladders has already been mentioned in Section 6.1; it is particularly well-suited to damping up-and-down motions of this kind. Active control of skyhook weights and positions and of the "flight" of the orbital rings could localise a perturbation and damp it out very near to its source. Mechanical losses in the ring materials would cause oscillations to decay slowly, but these are both unnecessary and undesirable (they would tend to cause fatigue). Of these three, the method of passive dissipation is simplest and most fool-proof.

To sum up, the combination of neutral stability for fluid streams inside a tube and the stability of the ORS "orbit" prove that the continuous-skyhook ORS is a dynamically stable structure.

6.3 Stability of a Discrete Skyhook ORS

Because a discrete-skyhook system tends towards a continuous-skyhook ORS in the limit of many skyhooks we already know (from the previous section) that the large scale structure is stable. However, we need to consider whether any instabilities arise on the scale of individual skyhooks.

Consider Fig. 25 in which skyhook A introduces a perturbation in the direction of an orbital ring. Let the small increase in $\Delta\theta$ at A be $\delta\theta_A$ and the corresponding increase in α be $\delta\alpha$ as shown; let the increase in height of the ring at B be δh . Let the radial distance of the skyhooks (R+H) be designated by r . For clarity I have used a mapping in which lines of constant radial distance are straight lines across the diagram.

Re-arranging Eq. (52) we have

$$\Delta H = (1 - gR^2/rV_0^2) \cdot r \cdot (1 - \cos\alpha)/\cos\alpha \tag{159}$$

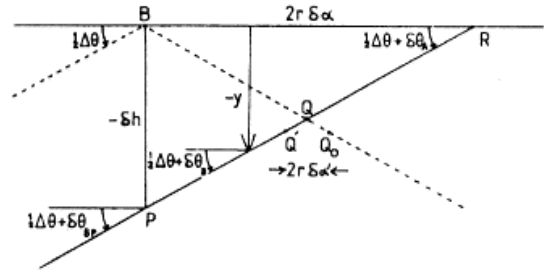
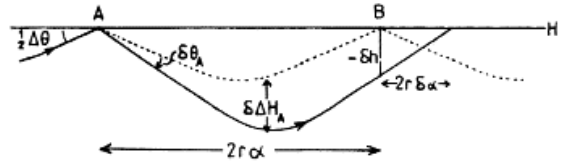

Fig. 25. Geometry of Perturbations of Discrete Skyhook ORS.

Substituting for ΔH in (42), with $\Delta H \ll r$, we obtain

$$\Delta\theta = 2 \tan\alpha \cdot (1 - gR^2/rV_0^2) \tag{160}$$

Differentiating with respect to α

$$\frac{d\Delta\theta}{d\alpha} = 2 \sec^2\alpha \cdot \left(1 - \frac{gR}{rV_0^2}\right) = \frac{\Delta\theta}{\sin\alpha\cos\alpha} \tag{161}$$

Here, where the change in $\Delta\theta$ is only on one side of the skyhook, we have

$$\delta\alpha = \sin 2\alpha \cdot \delta\theta_A/\Delta\theta \tag{162}$$

By simple trigonometry, to first order in small quantities

$$\delta h = 2r\delta\alpha \cdot \tan(\Delta\theta/2) = r \cdot \delta\alpha \cdot \Delta\theta \tag{163}$$

$$\therefore \delta h = r \sin 2\alpha \cdot \delta\theta_A \tag{164}$$

The increase in $\Delta\theta$ at A causes a decrease in the height of perigee. Let this decrease be $\delta\Delta H_A$. Differentiating (159) we obtain

$$\partial\Delta H_A/\partial\alpha = \Delta H \cdot \cos\alpha/(1-\cos\alpha) \cdot (\sin\alpha/\cos^2\alpha) \tag{165}$$

$$\therefore \delta\Delta H_A/\Delta H = \delta\alpha \cdot \tan\alpha/(1-\cos\alpha) \tag{166}$$

Let the angle of incidence of the ring near B be $(\frac{1}{2}\Delta\theta + \delta\theta_B)$ and let the corresponding angles at P, Q and R be $(\frac{1}{2}\Delta\theta + \delta\theta_{BP})$ etc. Let the height above the level of B (i.e. above height H or overall distance r) be y . Then, along PR

$$\tan(\frac{1}{2}\Delta\theta + \delta\theta_B) = \frac{(\Delta H + \delta\Delta H_A + y) (1 + \cos(\alpha + \delta\alpha(1 - 2y/\delta h)))}{(r - \Delta H) \sin(\alpha + \delta\alpha(1 - 2y/\delta h))} \tag{167}$$

Expanding to first order in small quantities and simplifying

$$\delta\theta_B = \frac{1}{2}\sin\Delta\theta \cdot (\delta\Delta H_A/\Delta H + y/\Delta H + \delta\alpha(2y/\delta h - 1)/\sin\alpha) \quad (168)$$

Now from (42) and (163)

$$y/\Delta H = -\delta\alpha(2y/\delta h)(1+\cos\alpha)/\sin\alpha \quad (169)$$

Substituting Eqs. (166) and (169) into (168) yields

$$\delta\theta_B = \frac{\sin\Delta\theta \cdot \delta\alpha}{2} \left(\frac{\tan\alpha}{1-\cos\alpha} - \frac{(2y/\delta h)(1+\cos\alpha)}{\sin\alpha} + \frac{(2y/\delta h - 1)}{\sin\alpha} \right) \quad (170)$$

We now use the small-angle approximation for $\sin\Delta\theta$ and substitute for $\delta\alpha$ using Eq. (162) to obtain

$$\delta\theta_B = \delta\theta_A (1 - (2y/\delta h) \cos^2\alpha) \quad (171)$$

By substituting for y we observe that (171) gives $\delta\theta_{BR} = \delta\theta_A$, correctly, and also that

$$\delta\theta_{BP} = \delta\theta_A (1 - 2\cos^2\alpha) \quad (172)$$

$$\& \quad \delta\theta_{BQ} = \delta\theta_A (1 - \cos^2\alpha) \quad (173)$$

Likewise, along BQ we have, for the unperturbed ring,

$$\delta\theta_O = -\delta\theta_A (2y/\delta h) \cos^2\alpha \quad (174)$$

The details of the effects of the perturbation will depend upon the construction and response of skyhook B, as well as the nature of the load on the skyhook. However, some aspects of the behaviour of the system may be noted.

Let the upward force on a skyhook be F . Let the height of the skyhook increase by the small amount y , and one or other of the incident and exit angles increase by the small amount $\delta\Delta\theta$. Let the corresponding increase in F be δF .

Then, to first and second order in the small angle $\Delta\theta$

$$(F+\delta F) = (m+\delta m) (V_O+\delta V_O)^2 (\Delta\theta+\delta\Delta\theta) \quad (175)$$

Expanding this to first order in the small quantities ' δ ' we find

$$\delta F/F = \delta m/m + 2\delta V_O/V_O + \delta\Delta\theta/\Delta\theta \quad (176)$$

Because the line density is inversely proportional to the orbital velocity

$$\delta m/m = -\delta V_O/V_O \quad (177)$$

Now, by conservation of energy

$$\delta(V_O^2) = -(2gR^2/r^2) y \quad (178)$$

Substituting from (160) and (164) and simplifying yields

$$\delta V_O/V_O = -y/r \cdot (1-\Delta\theta/2\tan\alpha) = \delta\theta_A(y/\delta h) \sin 2\alpha(1-\Delta\theta/2\tan\alpha) \quad (179)$$

$$\therefore \delta F/F = \delta\Delta\theta/\Delta\theta + \delta\theta_A(y/\delta h) \cos^2\alpha(2\tan\alpha-\Delta\theta) \quad (180)$$

It will be seen that, because $\Delta\theta$ is small, most of the change in F is due to the first term, with the second term a small correction significant only on scales of orbital angle

$\sim 1/\Delta\theta$.

Consider the forces applied at Q when the perturbed ring is diverted on to its original path, as the initial reaction of the skyhook to the perturbation. Taking only the first term of (180) we obtain, using (173) and (174)

$$\delta F/F = (\delta\theta_A/\Delta\theta) (1 - 2\cos^2\alpha) \quad (181)$$

Note that $\delta F/F$ is negative in sense, provided that $\alpha < 45^\circ$. The sideways force, δG , is given by

$$\delta G/F = (\delta\Delta_A/\Delta\theta) \sin(\Delta\theta/2) \quad (182)$$

The net force is downwards and towards P; the skyhook will tend to move that way, causing the angle $\delta\theta_O$ to increase towards zero. The skyhook can also slip down the outgoing ring system along the line BQ', bringing it into position at Q'.

Q' is the new equilibrium position: both $\delta\theta_B$ and $\delta\theta_O$ are zero. This position is a stable one; movement towards P decreases $\delta\theta_B$ while forcing $\delta\theta_O$ to increase so that the net force is back towards Q'. Movement towards Q also produces a restoring force. This follows from Eqs. (181) and (182).

At Q', Eq. (171) yields

$$y_{Q'} = \delta h/2\cos^2\alpha = -r\delta\theta_A \cdot \tan\alpha \quad (183)$$

When the skyhook is at the new equilibrium point, Q', the perturbation applied at A has the same magnitude there and at all further skyhooks downstream.

There are two caveats to be added to this statement. The first is that velocity and weight changes have been ignored; they are considered later. The second caveat is that Q' is displayed relative to the equivalent position Q₀ on the original path; let this horizontal displacement be $2r\delta\alpha'$.

$$r\delta\alpha' = r\delta\alpha (2y_{Q'}/\delta h - 1) \quad (184)$$

$$\therefore \delta\alpha'/\delta\alpha = \tan^2\alpha \quad (185)$$

Thus each successive skyhook will be moved an extra $2r\delta\alpha'$ towards skyhook A. This is another example of the phenomenon of precession which was considered in Section 4.3: this precession can be prevented by allowing a small increase in the downward force on each skyhook. Otherwise the precession effect will progress around the ORS until the ring returns to skyhook A. Let the total precession in one turn be $\delta\alpha'_T$

$$\delta\alpha'_T = \delta\alpha (2\pi/\alpha) \tan^2\alpha \quad (186)$$

Substitute for $\delta\alpha$ and $\Delta\theta$ from (162) and (160), giving

$$\delta\alpha'_T = \delta\theta_A \cdot (2\pi/\alpha) \sin^2\alpha/(1-gR^2/rV_O^2) \quad (187)$$

The precession will be stopped at skyhook A by the extra downwards force at this point (this is what produced the perturbation in the first place).

An extreme of skyhook behaviour is found when the effective height remains unaltered. In this case the "reflection" takes place at R and $\delta\theta_O = -\delta\theta_A$. Figure 26 shows how the outgoing ring will reach the next skyhook "on target." In this mode the pattern will repeat every other skyhook; it will not grow. At each skyhook there will be a sideways force tending to move it towards the local equilibrium point (which is Q' for skyhook B).

In moving the skyhook down to Q' from its original height, work is done by the skyhook on the ring; this acts to maintain large-scale orbital stability. For consideration of the short term effects on the skyhooks we may take an



Fig. 26. Reflection of Perturbation at Constant Height.

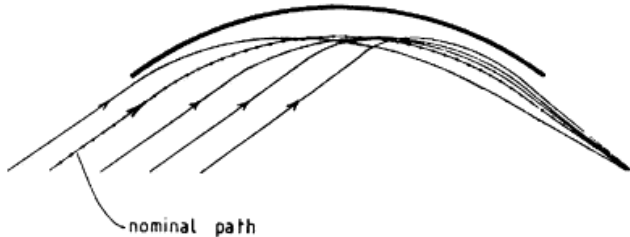

Fig. 27. Focusing requirement for Skyhooks.

infinitely long ring, with new sections of it continually passing through the skyhooks. This approximates the situation over times less than an orbital period and enabled us previously to neglect the work done on the rings, which is in fact given by

$$2\alpha m \delta (\frac{1}{2}V_0^2) = -m_p V_0^2 \Delta\theta \cdot \delta h / 2 \cos^2 \alpha \quad (188)$$

$$\therefore \delta V_0 / V_0 = \Delta\theta \cdot \delta\theta_A \cdot \tan\alpha / 2\alpha \quad (189)$$

This effect is small ($\Delta\theta$ is small) and can be added to the velocity change of (179), giving

$$\delta V_0 / V_0 = \delta\theta_A (\tan\alpha + (\tan\alpha / \alpha - 1) \Delta\theta / 2) \quad (190)$$

The decrease in height at the skyhook will also cause an increase in weight, due to the increase in the gravitational field:

$$\delta W / W = \delta\theta_A \tan\alpha \quad (191)$$

The combined effect of (190) and (191) is small, but weakly stabilising, since $(\delta W / W - \delta V_0 / V_0)$ is negative.

It is apparent that there exists an equilibrium point Q' near to Q which can be reached by each skyhook in turn. However, the skyhooks must be able to guide the outgoing ring in a suitable direction, or within a suitable range of directions.

Figure 27 is a schematic view of the rings passing through a skyhook. The focussing effect is produced by a passive arrangement of magnetic fields (the lift coils). The focusing is not critical; as long as the ring comes out more nearly on the correct path than when it went in, the chain of skyhooks will remain stable.

Several other properties of an ORS are relevant. Passive damping by ladders has already been mentioned: this will reduce oscillations. The orbital rings have been treated as if they were fluid streams; in reality they will have some strength and will therefore smooth out sudden perturbations, allowing the skyhooks time to move and adjust themselves. Furthermore, the skyhooks can use their linear induction motors for active stabilisation of position and for control of the orbital velocity of the rings.

It is apparent that a discrete-skyhook ORS which is stable to small perturbations can be built. Nevertheless, a great deal

needs to be done in working out the exact behaviour of a particular systems and in defining the limits of stability.

7. SUMMARY AND CONCLUSIONS

This paper has been concerned with the theory of Orbital Ring Systems and Jacob's Ladders, and diverse kinds have been considered.

The initial simple concept involved a massive ring in a nearly circular low orbit, supporting several ladders hung from skyhooks. It was noted that there is no particular limit to the number or weight of ladders, or to the number or mass of rings. Counter-rotating pairs of rings could be precessed to follow the rotation of the Earth (or, clearly, any other planet or massive body) and could be oriented in any direction.

The concept was developed by noting that the orbital rings could be enclosed in another ring, a geostationary continuous skyhook. Clearly, such a system could be brought down into the atmosphere, or on to the surface, or even set up underground, provided that the orbital rings themselves were held in vacuum.

The ORS could also be made non-circular, with eccentric systems to any orbital height being possible. Precession of an EORS is allowable, making available a wide range of orbits, including orbits about more than one body (Earth and Moon together, for example).

A further generalisation was made by considering incomplete rings; Partial Orbital Ring Systems would have end-points on the ground, linked by lengths of eccentric continuous skyhook ORS, enclosed for passage through the atmosphere.

The path of a PORS (or, indeed, of any kind of ORS) can be modified further by allowing it to intersect another; at the intersection the rings can be diverted in various directions, so that almost any path required could be obtained. A network of orbital rings following lines of latitude is one of the many possible arrangements.

It is clear that an ORS does not have to contain continuous cable; streams of discrete masses could be substituted (provided that the streams are not too irregular or sparse), producing reasonable approximations to the various kinds of ORS. This opens up possibilities for the transfer of momentum and energy over long distances, where a more conventional continuous ORS might be excessively massive or insufficiently flexible.

We see, then, that the theoretical family of Orbital Ring Systems is a large one; we can expect the range of applications to be correspondingly diverse. In Parts I & II I shall look at some of those applications, from the most straightforward (such as a simple ORS in Low Earth Orbit used for lifting payloads into space) to the most exotic (such as an artificial planet surrounding the Sun!). In the main I shall be concerned with how simple Orbital Ring Systems could actually be built and (very tentatively) how much they would cost. I shall also be looking into such issues as reliability and safety, and the wider implications for mankind.

APPENDIX 1. TUBULAR LADDERS

Atmospheric Pressure on Evacuated Tubes

Consider a cylinder, radius r_0 , and let the thickness of the walls be d . Let the cylinder be squashed out of shape slightly, so that the radius of curvature at some point is r . If $d \ll r_0$ then the surface of zero strain is halfway through the cylinder wall (see Fig. A1). Let x be the distance outwards from this surface.

Consider an element of length $d1$ and thickness dx at

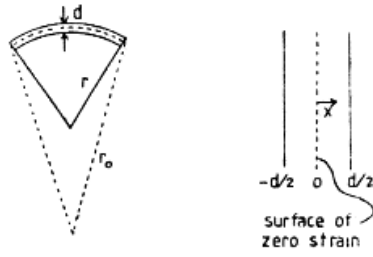

Fig. A1. Bending of Cylinder Wall.

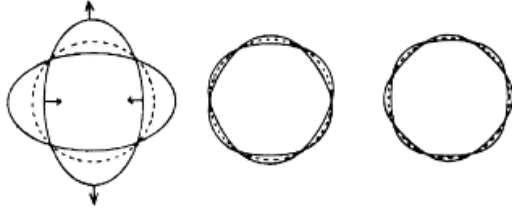

Fig. A2. Lowest Mode of Distortion of Cylinder.

distance x

$$\text{Extension of element} = \left(\frac{x}{r} - \frac{x}{r_o} \right) dl \quad (\text{A1.1})$$

Integrating over the thickness of the cylinder we have

$$\text{Mean square extension} = \int_{-d/2}^{d/2} x^2 \cdot dl^2 \cdot \left(\frac{1}{r} - \frac{1}{r_o} \right)^2 dx / \int_{-d/2}^{d/2} dx \quad (\text{A1.2})$$

$$\therefore \text{Mean square extension} = \frac{d^2}{12} \left(\frac{1}{r} - \frac{1}{r_o} \right)^2 (dl)^2 \quad (\text{A1.3})$$

The simplest (lowest energy) mode of distortion of the cylinder is shown in Fig. A2. When the displacement is small the overall shape may be approximated by four circular quadrants, alternate quadrants having radii r_1 and r_2 . One (say r_1) is less than r_o , the other greater; but the total circumference remains the same.

$$\text{i.e. } r_1 + r_2 = 2r_o \quad (\text{A1.4})$$

Let the RMS extension be ϵ and sum over all four quadrants

$$\epsilon^2 = \frac{d^2}{12} \left[\left(\frac{1}{r_1} - \frac{1}{r_o} \right)^2 \pi r_1 + \left(\frac{1}{r_2} - \frac{1}{r_o} \right)^2 \pi r_2 \right] \cdot \frac{1}{2\pi r_o} \quad (\text{A1.5})$$

Substituting from (A1.4) and simplifying, we obtain

$$\epsilon^2 = (d^2/12) (r_o - r_1) / r_1 r_2 r_o^2 \quad (\text{A1.6})$$

For small deviations, when $(1-r_1/r_o) \ll 1$,

$$\epsilon^2 = (d^2/12) (1-r_1/r_o)^2 / r_o^2 \quad (\text{A1.7})$$

Now, if the internal area be A then

$$A = \frac{1}{2}\pi r_1^2 + \frac{1}{2}\pi r_2^2 - (r_2 - r_1)^2 \quad (\text{A1.8})$$

Substituting from (A1.4) and simplifying, we obtain

$$A = \pi r_o^2 + (\pi-4) (r_o - r_1)^2 \quad (\text{A1.9})$$

So the change in internal area ($\Delta A \equiv A - A_o$) is given by

$$\Delta A = (\pi-4) (r_o - r_1)^2 \quad (\text{A1.10})$$

Let the external pressure be P and the Young's Modulus of the cylinder be E . Then for an element dh along the cylinder.

$$\text{Net Energy Change} = P \cdot \Delta A \cdot dh + \frac{1}{2} E \epsilon^2 \cdot 2\pi r_o d \cdot dh \quad (\text{A1.11})$$

$$\therefore \text{Net Energy Change} = (r_o - r_1) (P(\pi-4) + E(\pi/12)(d/r_o)^3) \quad (\text{A1.12})$$

Thus, in the limit when the cylinder is about to crumple under the external pressure (energy change is turning positive) we have

$$P(\pi-4) + E(\pi/12)(d/r_o)^3 = 0 \quad (\text{A1.13})$$

Solving for (d/r_o) when $P = P_{\max}$ we obtain

$$(d/r_o) = 1.49 \times (P_{\max}/E)^{1/3} \quad (\text{A1.14})$$

When the atmosphere is to be excluded from a cylinder $P_{\max} \gg P_{\text{atmos}}$ or, for steel ($E = 2 \times 10^{11} \text{ Nm}^{-2}$) and with $P_{\text{atmos}} = 10^5 \text{ Nm}^{-2}$ we have

$$(d/r_o)_{\min} \approx 0.012 \quad (\text{A1.15})$$

However, when a hoop is used to bear atmospheric pressure, the effective pressure is increased. Let W be the ratio of the distance between hoops to the height of each cylindrical hoop, so that $P_{\max} \gg W P_{\text{atmos}}$

$$(d/r_o)_{\min} \approx 0.012 W^{1/3} \quad (\text{A1.16})$$

Equation (A1.16) can be used in reverse to give the maximum allowable value of W for a given (d/r_o) .

Modes of Vibration of Ladder Hoops

The hoops or cylinders may vibrate in the series of eigenmodes shown in Fig. A3; the circular quadrant approximation for the first eigenmode (Fig. A2) has major and minor axis r_a and r_b at the peak displacement.

By inspection

$$r_a = r_1 + (r_2 - r_1) \sqrt{2}/2 \quad (\text{A1.17})$$

$$\& \quad r_b = r_2 - (r_2 - r_1) \sqrt{2}/2 \quad (\text{A1.18})$$

Let the amplitude of the oscillation be a_o ($a_o = \frac{1}{2}(r_a - r_b)$)

$$\therefore a_o = \frac{1}{2}(r_1 - r_2) (1 - \sqrt{2}) \quad (\text{A1.19})$$

Substituting from (A1.4) we obtain

$$a_o = (r_o - r_1) (\sqrt{2} - 1) \quad (\text{A1.20})$$

Let the RMS displacement be X

$$X^2 = \frac{1}{2} a_o^2 \quad (\text{A1.21})$$

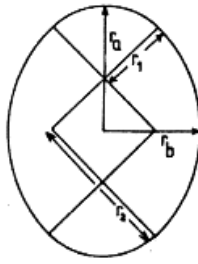

Fig. A3. Eigenmodes of Vibration of Cylinder.

Let the potential energy at maximum displacement be p per unit volume and let the loading mass per unit volume be ρ_L

$$p = \frac{1}{2}E\epsilon^2 \tag{A1.22}$$

Substituting from (A1.7), (A1.20) and (A1.21) we have

$$p = \frac{1}{2}EX^2 \cdot d^2 / (6(3 - 2\sqrt{2})r_0^4) \tag{A1.23}$$

Hence the frequency of oscillation, ν_1 is given by

$$\nu_1 = (1/2\pi) (2p/X^2 \rho_L)^{1/2} \tag{A1.24}$$

$$\begin{aligned} \therefore \nu_1 &= (\sqrt{3/6\pi}) (1 + \sqrt{2}/2) (d/r_0^2) (E/\rho_L)^{1/2} \\ &\approx 0.157(d/r_0^2) (E/\rho_L)^{1/2} \end{aligned} \tag{A1.25}$$

Let the phase velocity be V_S and the wavelength $\lambda_1 = \pi r_0$. Then

$$\begin{aligned} V_S &= (\sqrt{3/6}) (1 + \sqrt{2}/2) (d/r_0) (E/\rho_L)^{1/2} \\ &\approx 0.493 (d/r_0) (E/\rho_L)^{1/2} \end{aligned} \tag{A1.26}$$

APPENDIX 2 CORIOLIS EFFECT

Coriolis Force on Ladders

The Coriolis force is a fictitious force arising from the Earth's rotation; it only affects objects moving towards or away from the Earth's axis. Thus the ladders, being stationary, will experience no direct Coriolis force. However, the motion of payloads will cause a force to act upon them and thence upon the ladders.

Let the angular velocity of the Earth be Ω and let the horizontal component of that angular velocity be Ω' .

$$\Omega' = \Omega \cdot \cos(\text{latitude}) \tag{A2.1}$$

Let the velocity of a geosynchronous test particle at height y be V_S , relative to a particle on the Earth's surface vertically below. This velocity will be horizontal and in a West-East direction.

$$V_S = y \Omega' \tag{A2.2}$$

Now consider a particle being constrained to move vertically – a sideways force is required. By differentiating (A2.2) we may obtain the Coriolis acceleration.

$$a_{cor} = \dot{y} \Omega' \tag{A2.3}$$

TABLE A1. Coriolis Effect on Ladders.

$\ddot{y}(1)$	H	$V_s(2)$	$V_m(3)$	$a_{cor}(4)$	$a_{cor}/(\ddot{y}+g)$
ms^{-2}	km	ms^{-1}	kms^{-1}	ms^{-2}	10^{-3}
2	300	21.8	1.1	0.08	6.6
2	600	43.6	1.5	0.11	9.4
10	300	21.8	2.4	0.18	8.9
10	600	43.6	3.5	0.25	12.6
100	300	21.8	7.7	0.56	5.1
100	600	43.6	11.0	0.80	7.2
200	300	21.8	11.0	0.80	3.8
200	600	43.6	15.5	1.13	5.4

Notes:

- (1) Vertical acceleration.
- (2) Coriolis speed difference at height H above the equator.
- (3) Muzzle velocity.
- (4) Coriolis acceleration at height H; the maximum value of the coriolis acceleration for an equatorial ladder.

In Table A1 I give some typical values of the maximum Coriolis acceleration. It is apparent that, for the range of muzzle velocities that are of interest the sideways force will amount to 1% of the payload weight, F_p , or less. This force can be countered, in part, by a suitably sloping ladder.

Coriolis Displacement of Falling Object

Consider an object falling freely under gravity from a height $H \ll R$.

$$y = H - \frac{1}{2}gt^2 \tag{A2.4}$$

Let the time taken to fall be τ . Then

$$\tau = (2H/g)^{1/2} \tag{A2.5}$$

Let the sideways displacement due to the Coriolis effect be S . We have, from (A2.2),

$$V_S = \frac{1}{2}gt \cdot \Omega' \tag{A2.6}$$

Integrating, we obtain

$$S = \frac{1}{2}g\Omega' \int_0^\tau t^2 dt \tag{A2.7}$$

$$\therefore S = \frac{1}{6}g\Omega'\tau^3 \tag{A2.8}$$

Substituting for τ yields

$$S = \frac{1}{3}\Omega' \cdot (2H^3/g)^{1/2} \tag{A2.9}$$

Evaluating this for the representative ladder heights we find (at the equator)

$$S(300 \text{ km}) = 1.80 \text{ km} \tag{A2.10}$$

$$\& S(600 \text{ km}) = 5.09 \text{ km} \tag{A2.11}$$

This is the distance that the top of the ladder will move

sideways if it is dropped freely (multiply by the cosine of the latitude for non-equatorial ladders). So if anything falls off a vertical ladder it can land up to this distance to the east of the ground station.

1. Artsutanov, Y. N., *Komsomolskaya Pravda* 31 July 1960.
2. Isaacs, J. D., Bradner, H., Backus, G. E. and Vine, A. C. 'Satellite Elongation into a True "Skyhook,"' *Science*, 151, 682 (1966).
3. Arnold, W. H. *et al*, 'Mass drivers I: Electrical design; II: Structural dynamics; III: Engineering,' pp. 87-157 in *Space Resources and Space Settlements* (J. Billingham and B. O'Leary, Eds.), NASA SP-428 (1979).
4. Criswell, D. R., 'The initial Lunar supply base,' pp. 207-224 in *Ibid*.
5. Ho, D. and Sobon, L. E., 'Extraterrestrial fiberglass production using solar energy,' pp. 225-232 in *Ibid*.
6. Vajk, J. P. *et al*, 'Habitat and logistic support requirements for the initiation of a space manufacturing enterprise,' pp. 61-83 in *Ibid*.
7. Harman, C. G., 'Nonglassy inorganic fibers and composites,' NASA SP-5055 (1966).
8. Pippard, A. B., "Forces and Particles," Macmillan, 1972.
9. "U.S. Standard Atmosphere, 1976," U.S. Government Printing Office (1976).
10. J. R. Reitz, *J. Appl. Phys.*, 41, 2067 (1970).
11. Powell, J. R. and Danby, G. R., Am. Soc. of Mech. Engineers Paper 66-WA/RR-5 (1966).

* * * * *