

M1-1
INTERSTATE ROUTE

*Optically space numerals about vertical centerline.

SIGN	A	B	C	D	E	F	G	H	J	K	L	M
1,2 digits	600	600	15	192	250 D	158	125	375	375	48	62C	190
1,2 digits	900	900	20	288	375 D	237	190	562.5	562.5	70	100 C	306
1,2 digits	1200	1200	25	384	500 D	316	228	750	750	103	125 C	382.5
3 digits	750	600	15	192	250 C	158	125	600	425	48	62 E	270
3 digits	1125	900	20	288	375 C	237	190	900	650	70	100 E	436.5
3 digits	1500	1200	25	384	500 C	316	253	1200	850	103	125 E	545.5

COLORS: LEGEND – WHITE (RETROREFLECTIVE)
 TOP – RED (RETROREFLECTIVE)
 BOTTOM – BLUE (RETROREFLECTIVE)

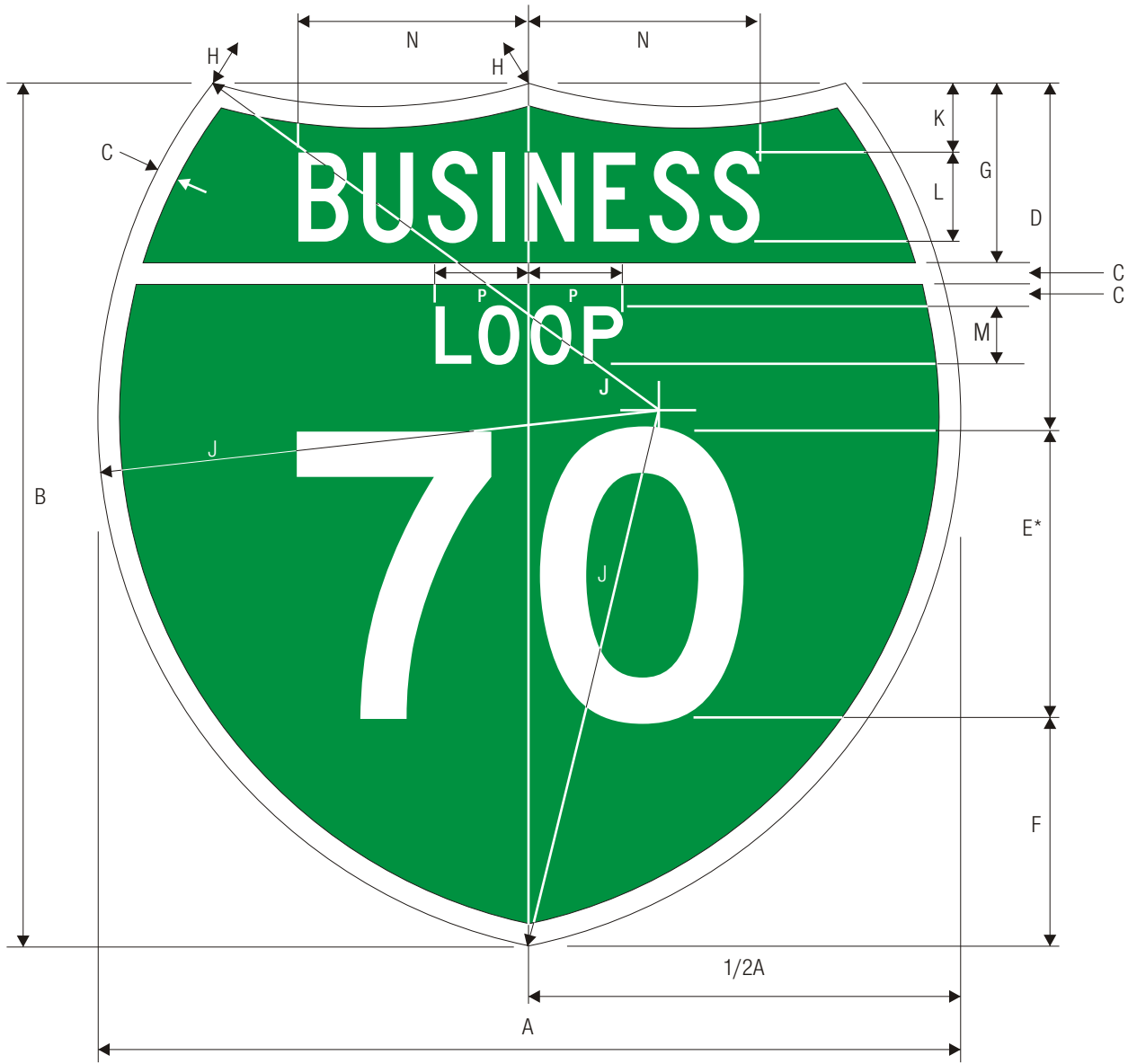

M1-2
OFF-INTERSTATE BUSINESS ROUTE (LOOP)

SIGN	A	B	C	D	E	F	G	H	J	K	L	M
1,2 digits	600	600	15	242	200 D	158	125	375	375	48	62C	40 D
1,2 digits	900	900	20	338	325 D	237	190	562.5	562.5	70	100 C	65 D
1,2 digits	1200	1200	25	434	450 D	316	228	750	750	103	125 C	80 D
3 digits	750	600	15	242	200 C	158	125	600	425	48	62 E	40 E
3 digits	1125	900	20	338	325 C	237	190	900	650	70	100 E	65 E
3 digits	1500	1200	25	434	450 C	316	253	1200	850	103	125 E	80 E

N	P
160.5	65
258.5	106
323.5	130.5
222	75.5
358	123
447.5	152.5

*Optically space numerals about vertical centerline.

COLORS: LEGEND — WHITE (RETROREFLECTIVE)
BACKGROUND — GREEN (RETROREFLECTIVE)

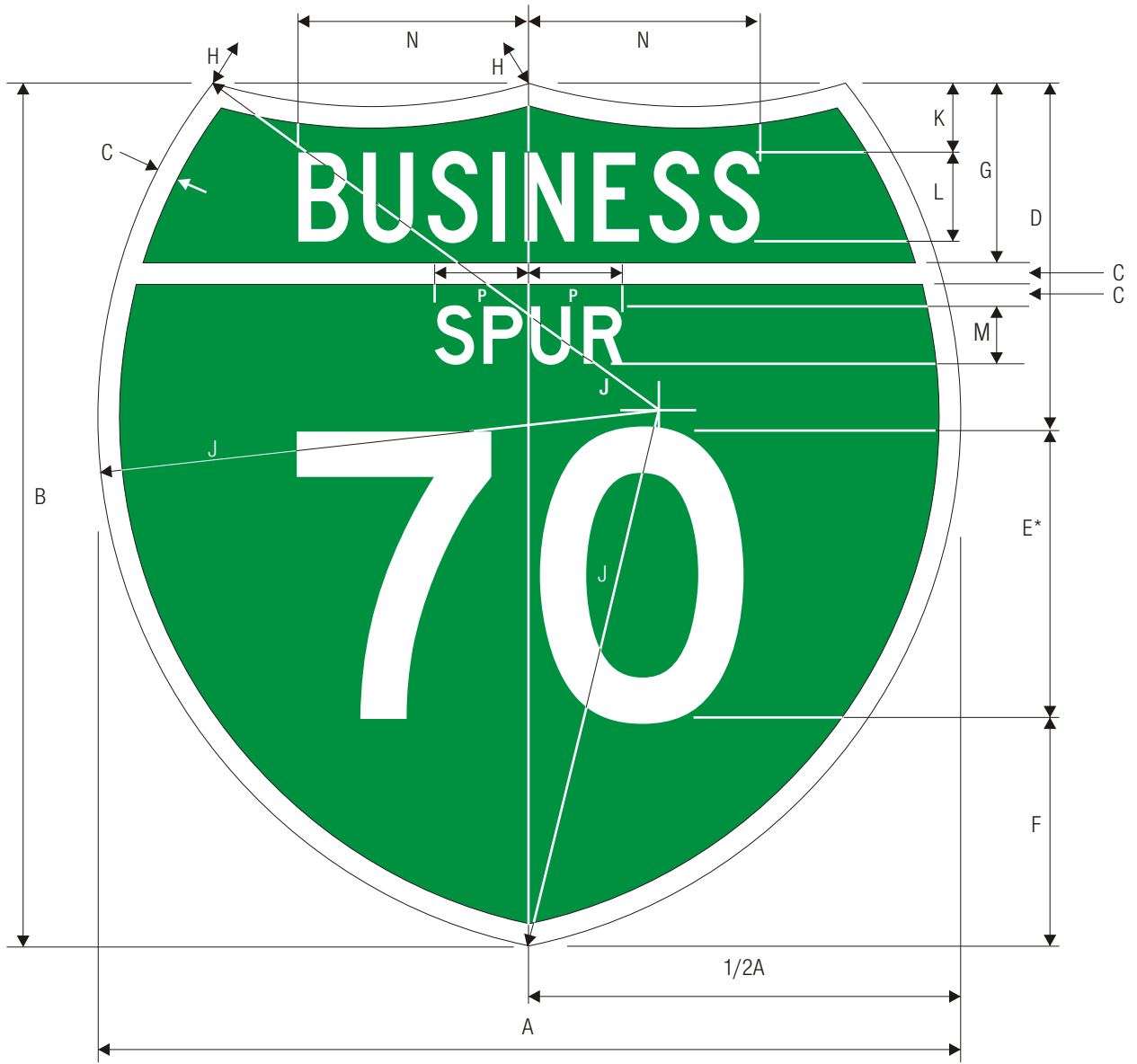

M1-3

OFF-INTERSTATE BUSINESS ROUTE (SPUR)

SIGN	A	B	C	D	E	F	G	H	J	K	L	M
1,2 digits	600	600	15	242	200 D	158	125	375	375	48	62C	40 D
1,2 digits	900	900	20	338	325 D	237	190	562.5	562.5	70	100 C	65 D
1,2 digits	1200	1200	25	434	450 D	316	228	750	750	103	125 C	80 D
3 digits	750	600	15	242	200 C	158	125	600	425	48	62 E	40 E
3 digits	1125	900	20	338	325 C	237	190	900	650	70	100 E	65 E
3 digits	1500	1200	25	434	450 C	316	253	1200	850	103	125 E	80 E

N	P
160.5	65.5
258.5	106
323.5	130.5
222	77
358	125
447.5	154.5

*Optically space numerals about vertical centerline.

COLORS: LEGEND — WHITE (RETROREFLECTIVE)
 BACKGROUND — GREEN (RETROREFLECTIVE)

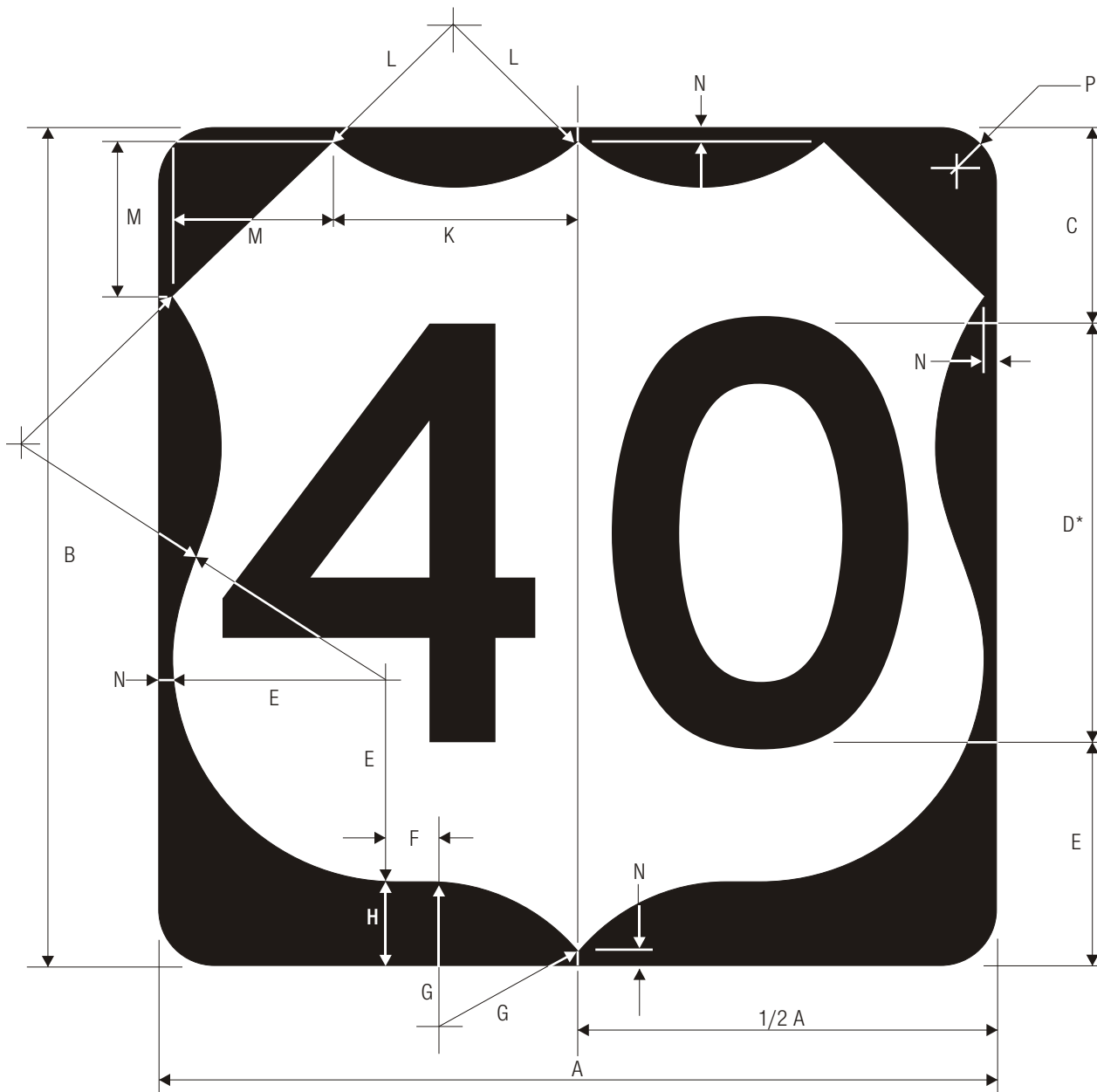

**M1-4 U.S. ROUTE MARKER
FOR INDEPENDENT USE**

*Optically space numerals about vertical centerline.

SIGN	A	B	C	D	E	F	G	H	J	K	L	M
1,2 digits	600	600	140	300 D	160	25	135	60	185	175	135	115
1,2 digits	900	900	210	450 D	240	38	203	90	278	263	203	173
1,2 digits	1200	1200	280	600 D	320	51	271	120	371	351	271	231
3 digits	750	600	140	300 C	160	100	135	60	185	250	238	115
3 digits	1125	900	210	450 C	240	150	203	90	278	375	357	173
3 digits	1500	1200	280	600 C	320	200	271	120	371	500	476	231

N	P
10	50
15	75
20	100
10	50
15	75
20	100

**COLORS: SHIELD – WHITE (RETROREFLECTIVE)
BACKGROUND – BLACK
NUMERALS – BLACK**

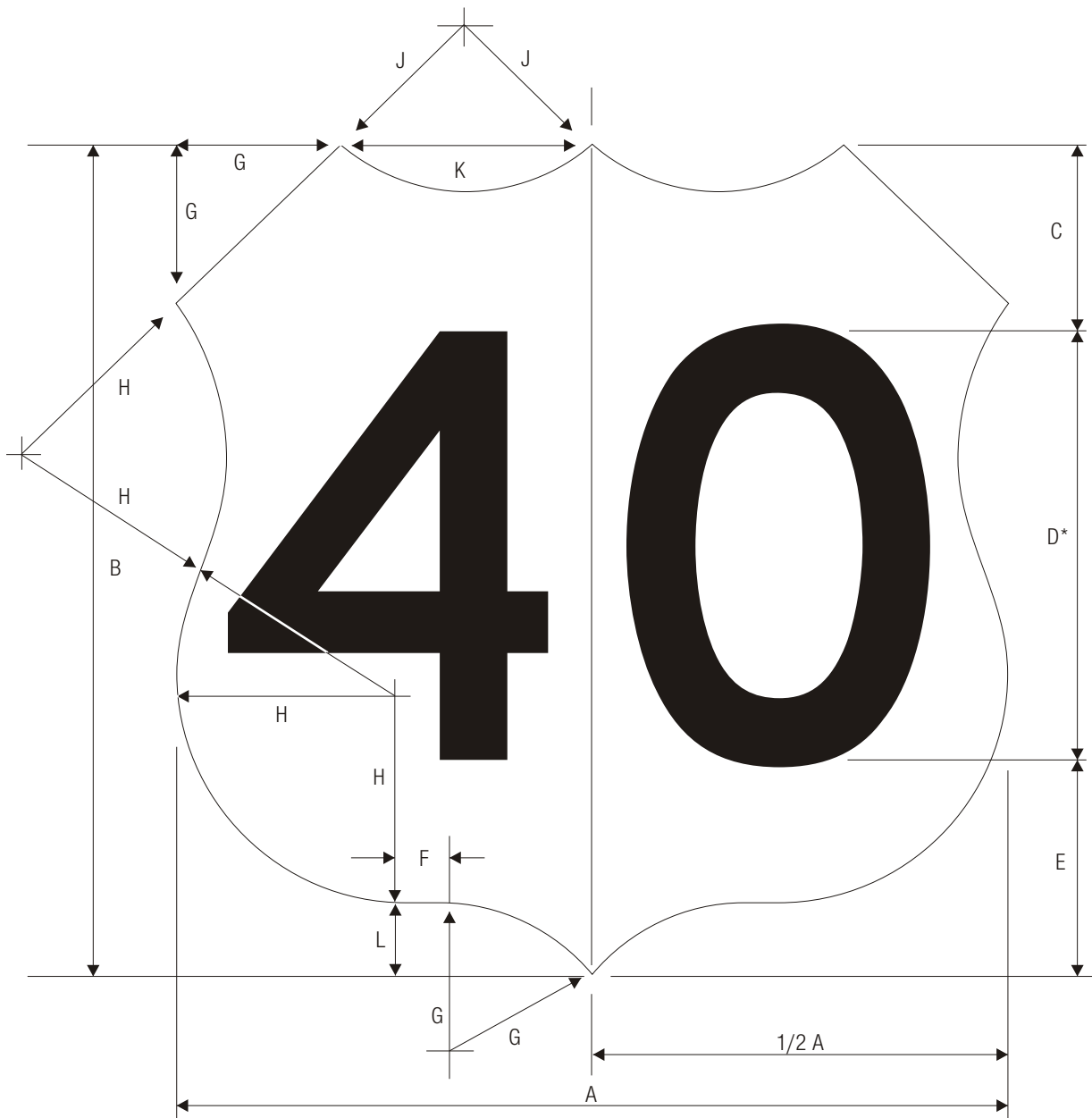

**M1-4 U.S. ROUTE MARKER
FOR GUIDE SIGN USE**

*Optically space numerals about vertical centerline.

SIGN	A	B	C	D	E	F	G	H	J	K	L
1,2 digits	600	600	140	300 D	160	25	135	160	135	175	60
1,2 digits	900	900	210	450 D	240	38	203	240	203	263	90
1,2 digits	1200	1200	280	600 D	320	51	271	320	271	351	120
3 digits	750	600	140	300 C	160	100	135	160	238	250	60
3 digits	1125	900	210	450 C	240	150	203	240	357	375	90
3 digits	1500	1200	280	600 C	320	200	271	320	476	500	120

**COLORS: NUMERALS – BLACK
BACKGROUND – WHITE (RETROREFLECTIVE)**

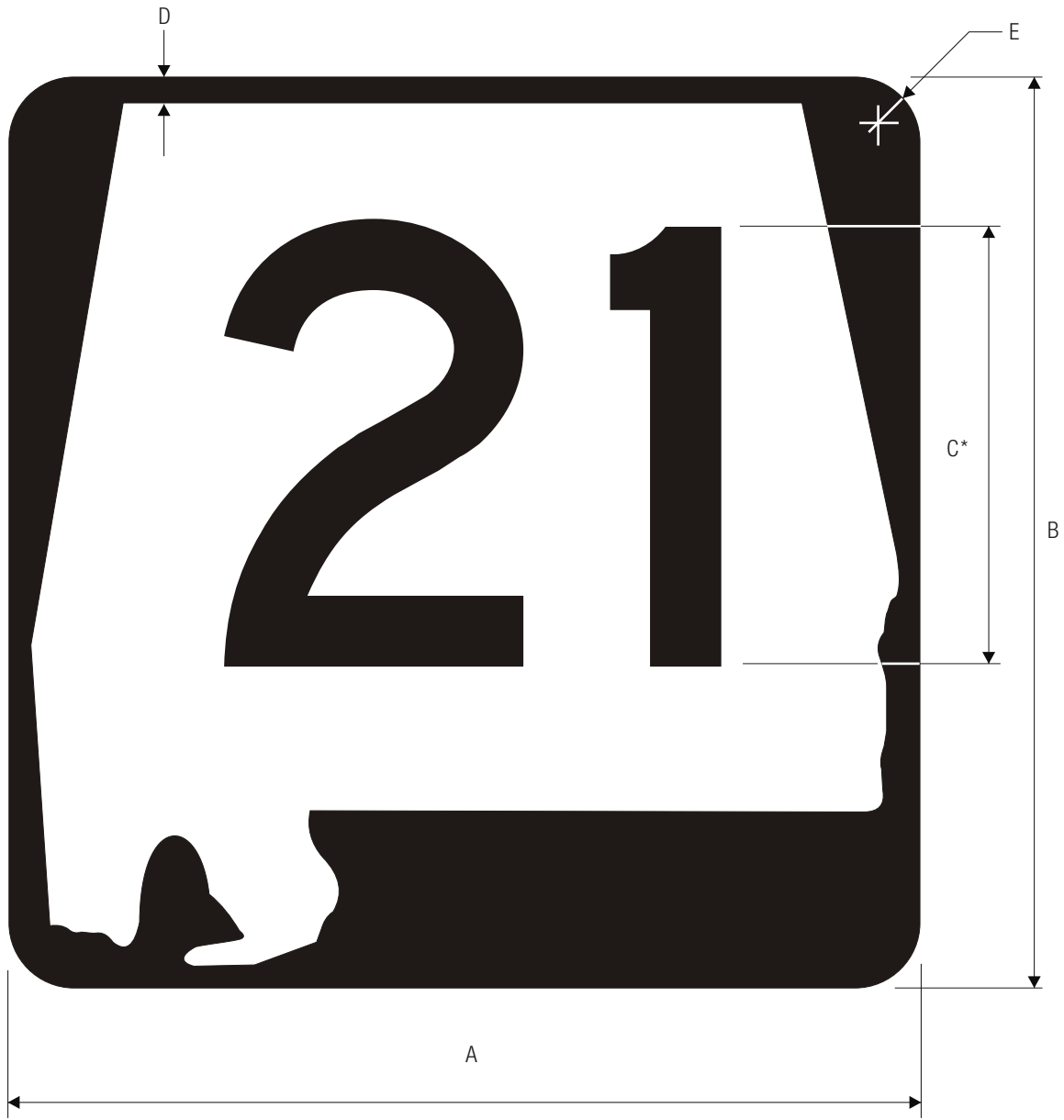

M1-5
STATE ROUTE

*Optically space numerals in shield.
**Alabama Route Marker design used for illustrative purposes.

SIGN	A	B	C	D	E
1,2 digits	600	600	300 D	15	50
1,2 digits	900	900	450 D	25	60
1,2 digits	1200	1200	600 D	30	70
3 digits	750	600	300 C	20	50
3 digits	1125	900	450 C	25	60
3 digits	1500	1200	600 C	30	70

COLORS: LEGEND – BLACK
SHIELD – WHITE (RETROREFLECTIVE)

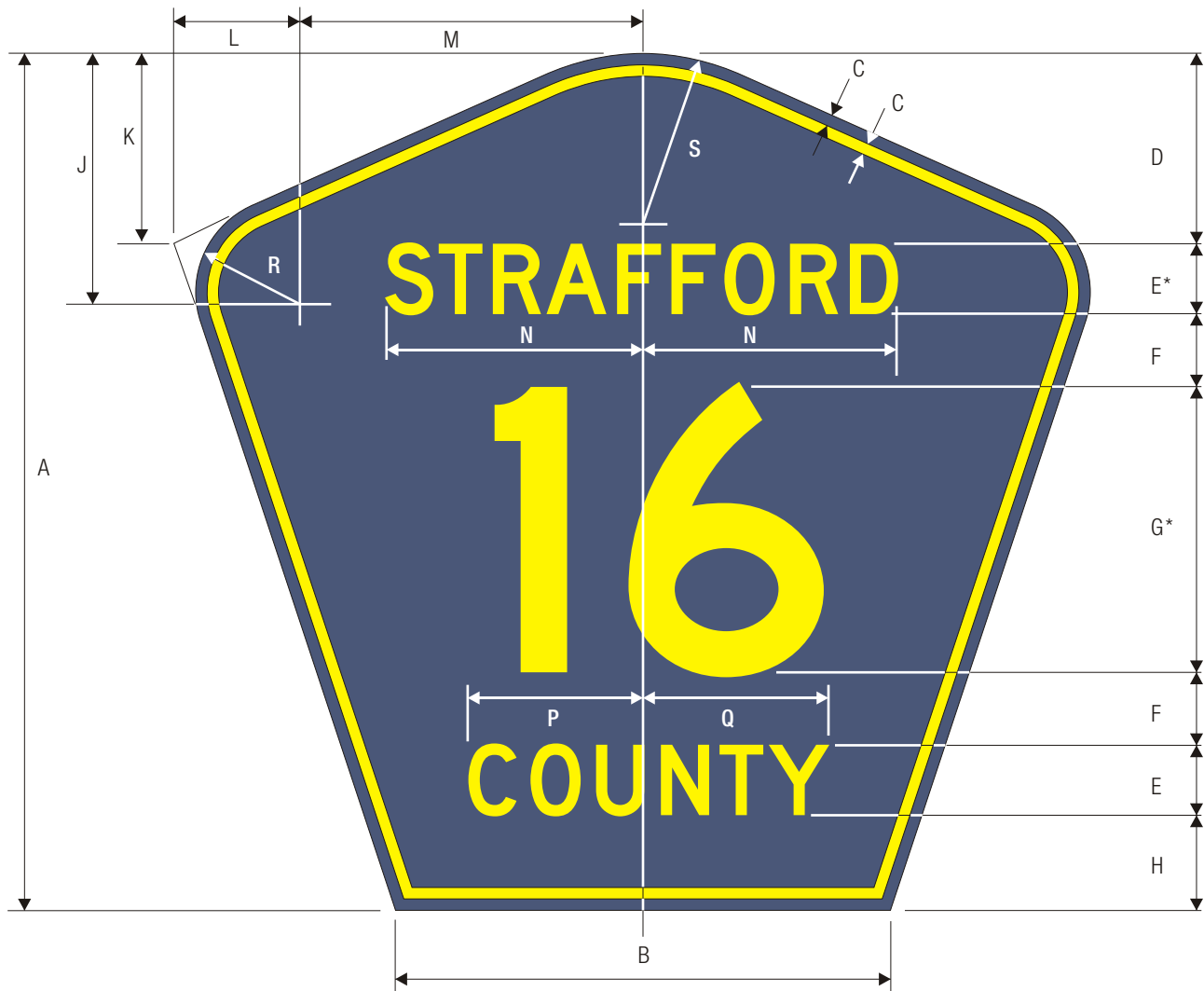

M1-6
COUNTY ROUTE

*Optically space numerals and county name about centerline.

A	B	C	D	E	F	G	H	J	K	L	M
450	260	6	100	37	38	150 D	50	125	85	60	175
600	347	8	133	50	50	200 D	67	167	113	80	233
750	434	10	166	62	63	250 D	84	209	141	100	291

N	P	Q	R	S
VAR	92	98	50	125
VAR	123	131	67	167
VAR	154	164	85	209

COLORS: LEGEND — YELLOW (RETROREFLECTIVE)
BACKGROUND — BLUE (RETROREFLECTIVE)



M1-7
FOREST ROUTE

*Optically space numerals about vertical centerline.
**See page 6-36 for design.

A	B	C	D	E	F	G	H	J
450	320	15	65	150 D	28	100	42	40
600	427	20	87	200 D	37	178	56	50

COLORS: LEGEND —WHITE (RETROREFLECTIVE)
BACKGROUND —BROWN (RETROREFLECTIVE)

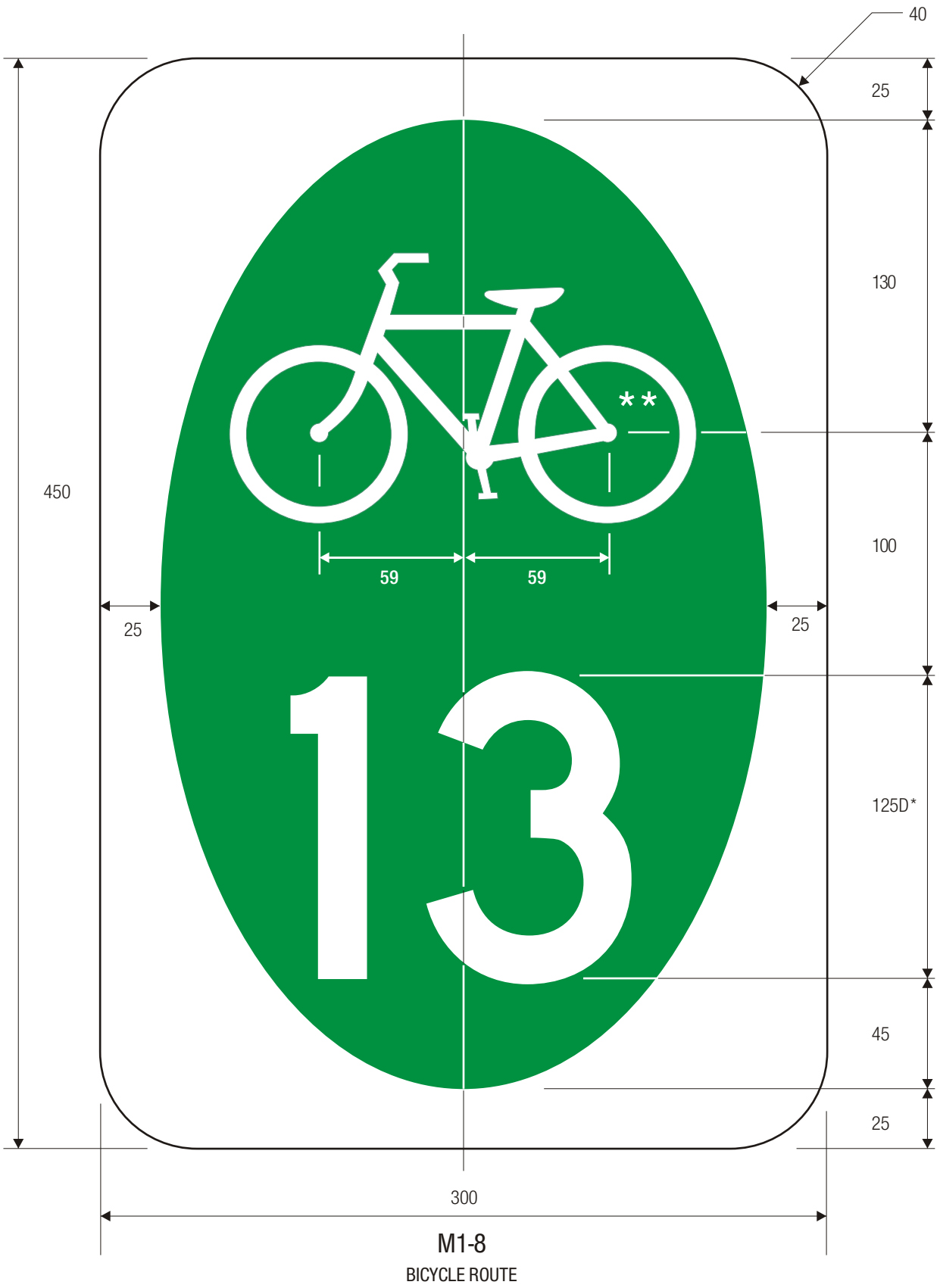

COLORS: LEGEND & SYMBOL – WHITE (RETROREFLECTIVE)
 INNER BACKGROUND – GREEN (RETROREFLECTIVE)
 OUTER BACKGROUND – WHITE (RETROREFLECTIVE)

*Optically space numerals about centerline.
 **See page 6-7 for symbol design.

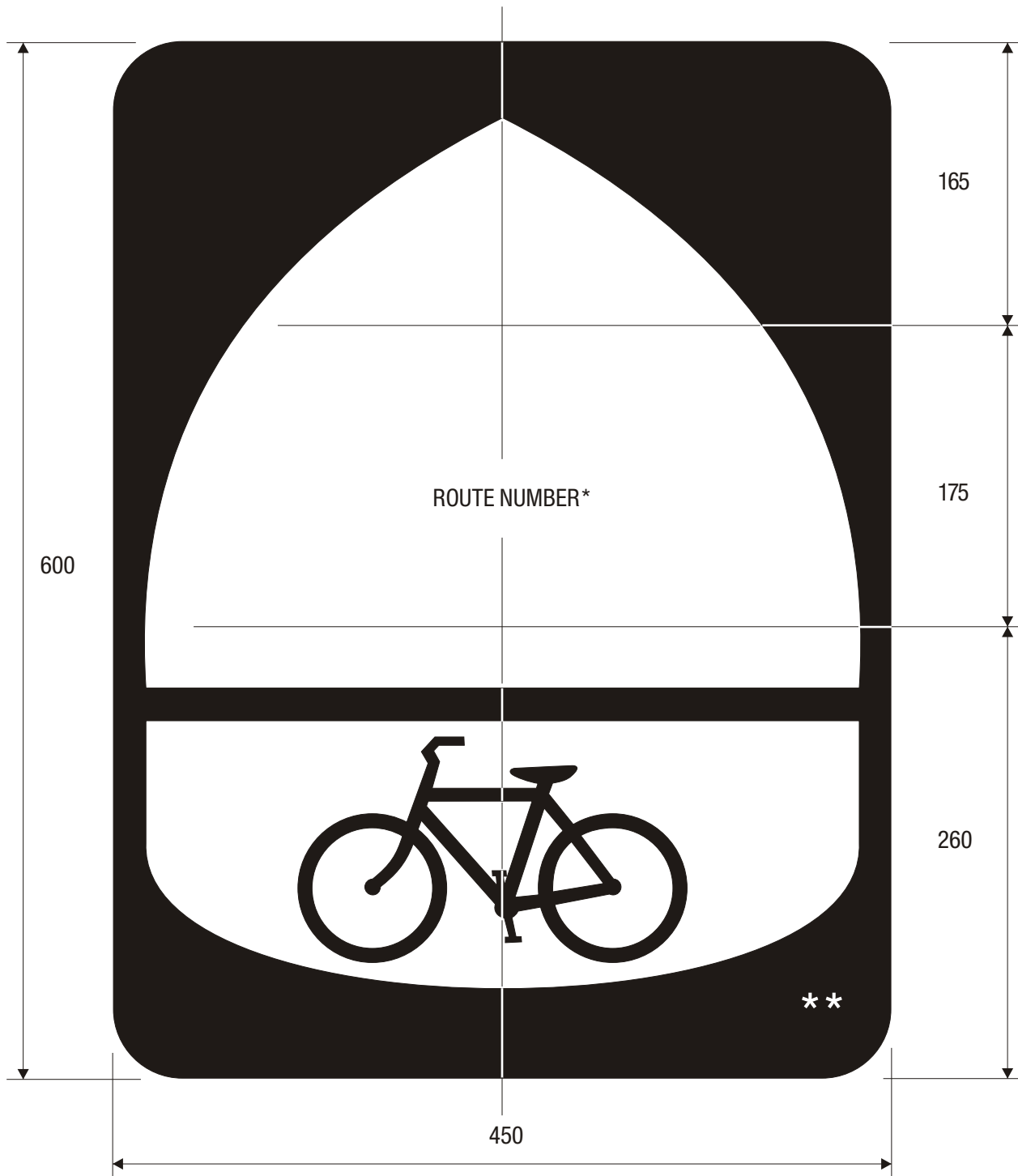

M1-9
BICYCLE ROUTE

*Optically space numerals about centerline.
** See page 6-39 for symbol design.

COLORS: LEGEND & SYMBOL — BLACK
 INNER BACKGROUND — WHITE (RETROREFLECTIVE)
 OUTER BACKGROUND — BLACK

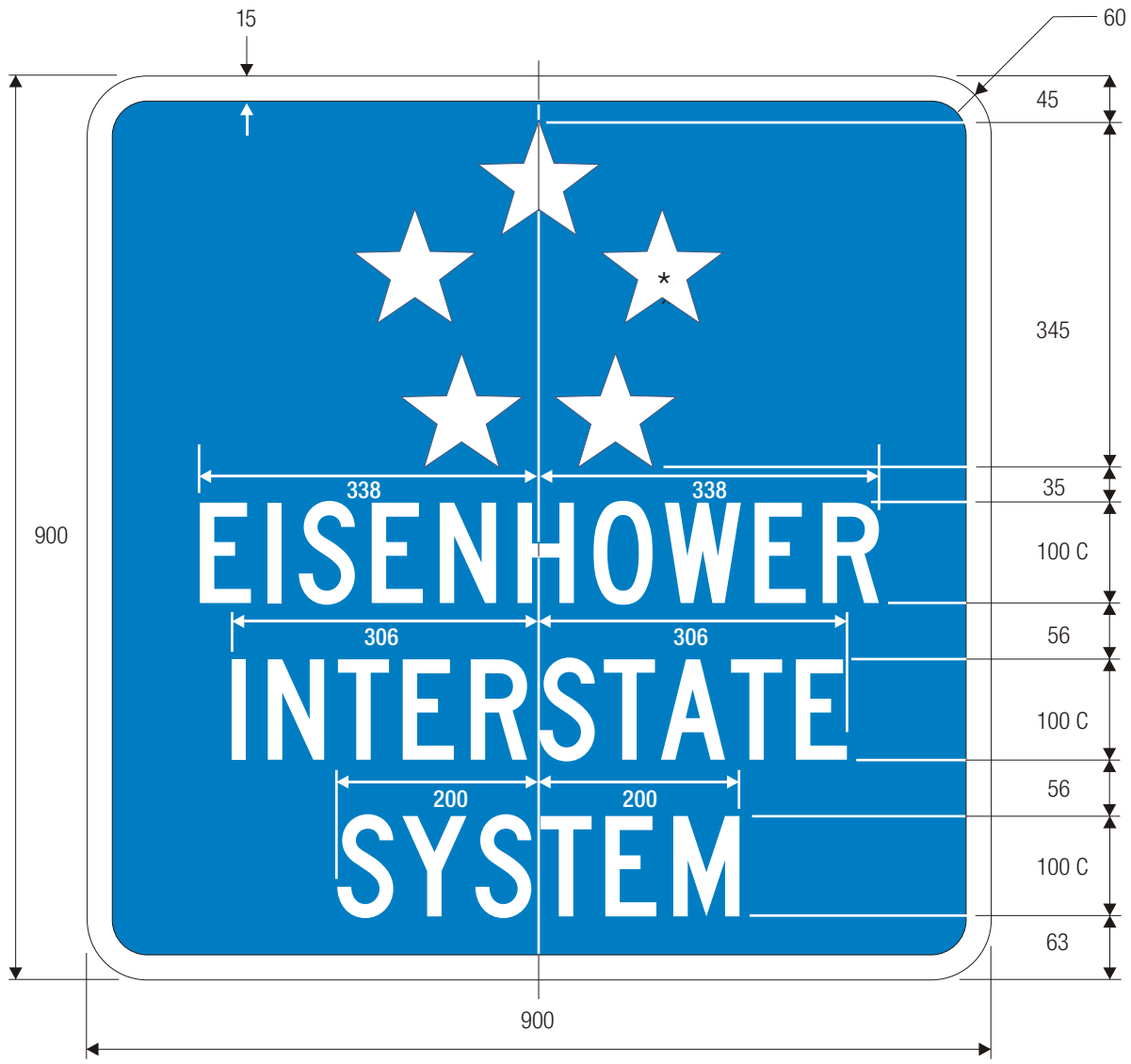

M1-10

*See page 6-40 for symbol design.

EISENHOWER INTERSTATE SYSTEM

COLORS: LEGEND — WHITE (RETROREFLECTIVE)
 BACKGROUND — BLUE (RETROREFLECTIVE)

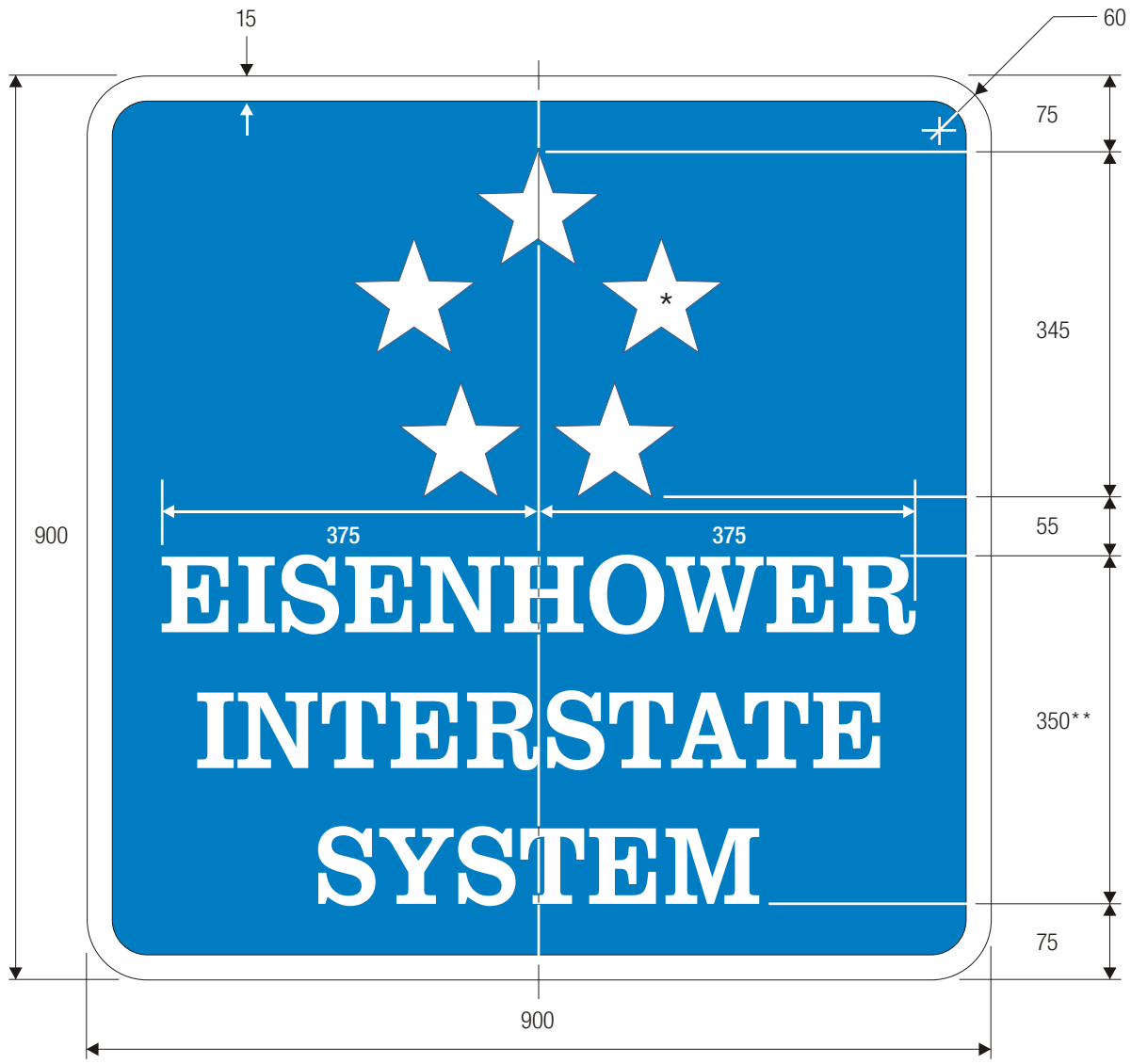

M1-10a

*See page 6-40 for symbol design.
 **See page 6-41 for lettering design.

EISENHOWER INTERSTATE SYSTEM

COLORS: LEGEND — WHITE (RETROREFLECTIVE)
 BACKGROUND — BLUE (RETROREFLECTIVE)

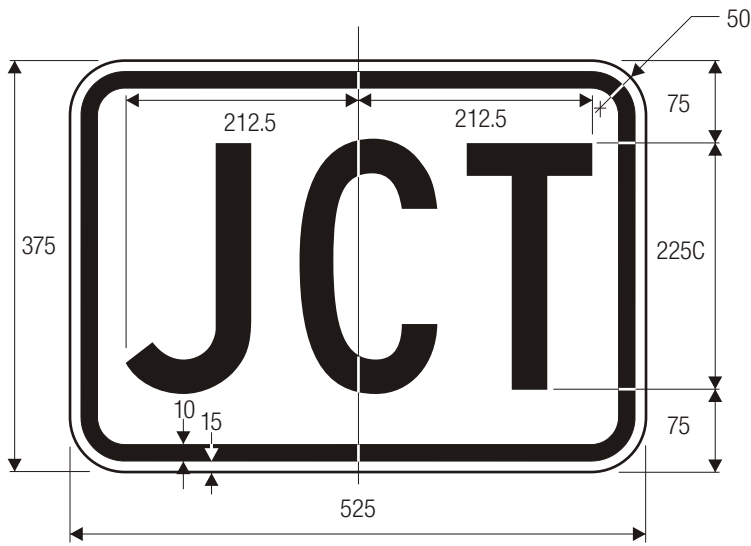

M2-1
JUNCTION AUXILIARY

COLORS: LEGEND — BLACK
BACKGROUND — WHITE (RETROREFLECTIVE)

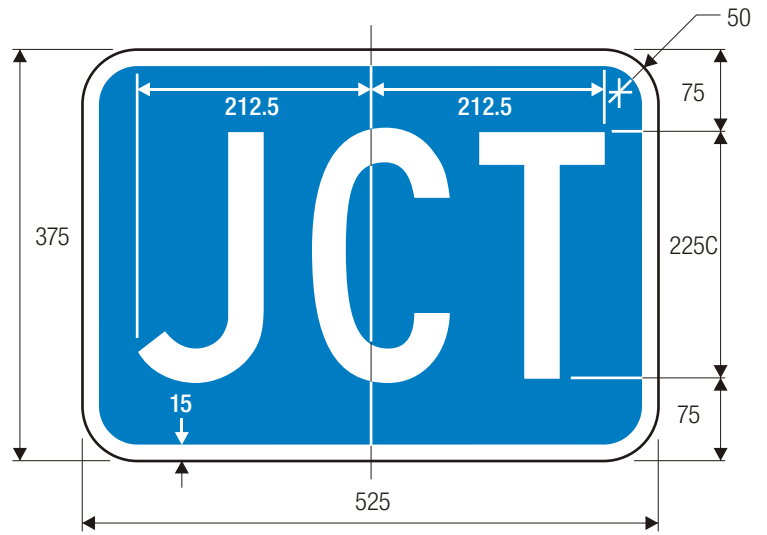

M2-1 (Interstate)
JUNCTION AUXILIARY

COLORS: LEGEND — WHITE (RETROREFLECTIVE)
BACKGROUND — BLUE (RETROREFLECTIVE)

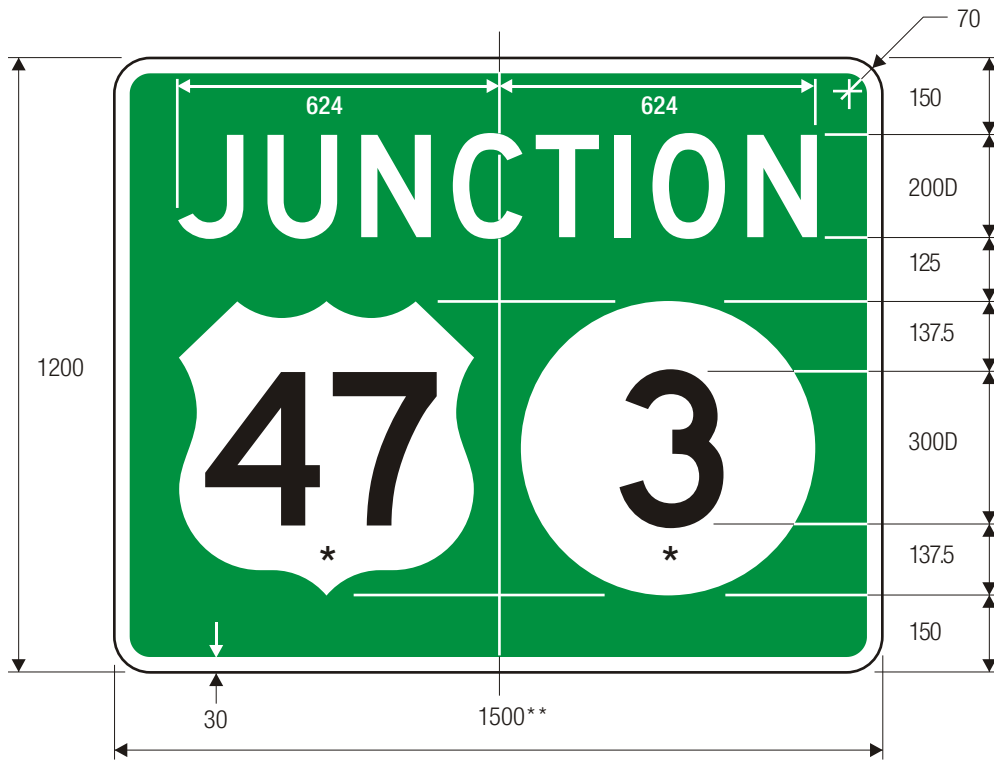

M2-2
COMBINATION JUNCTION

*Use standard shield designs.
**Increase width where more than two shields are used.

COLORS: BORDER & SHIELD — WHITE (RETROREFLECTIVE)
LEGEND LINE 1 — WHITE (RETROREFLECTIVE)
LEGEND LINE 2 — BLACK
BACKGROUND — GREEN (RETROREFLECTIVE)

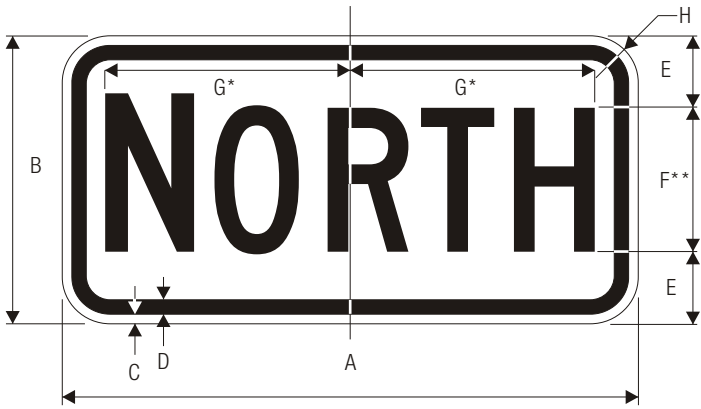

M3-1

CARDINAL DIRECTION AUXILIARY

A	B	C	D
600	300	10	15
750	375	13	20
E	F	G	H
75	150 C	255	50
87.5	200 C	309.5	50

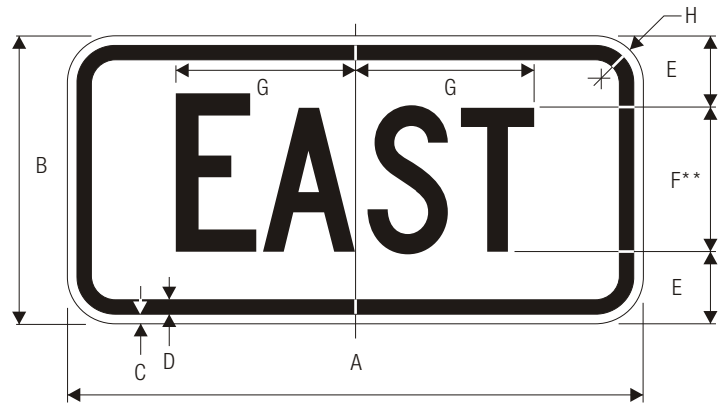

M3-2

CARDINAL DIRECTION AUXILIARY

A	B	C	D
600	300	10	15
750	375	13	20
E	F	G	H
75	150 C	186	50
87.5	200 C	248.5	50

*Reduce to fit for 750 mm size.
 **Make first letter 10% larger.

COLORS: LEGEND —BLACK
 BACKGROUND —WHITE (RETROREFLECTIVE)

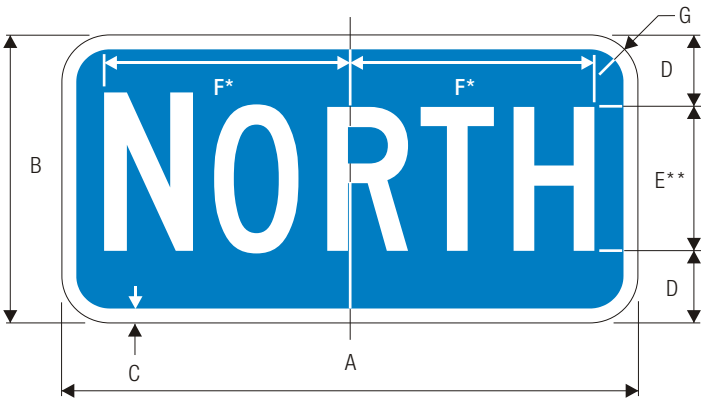

M3-1 (INTERSTATE)

CARDINAL DIRECTION AUXILIARY

A	B	C	D
600	300	15	75
750	375	20	87.5
E	F	G	
150 C	255	50	
200 C	309.5	50	

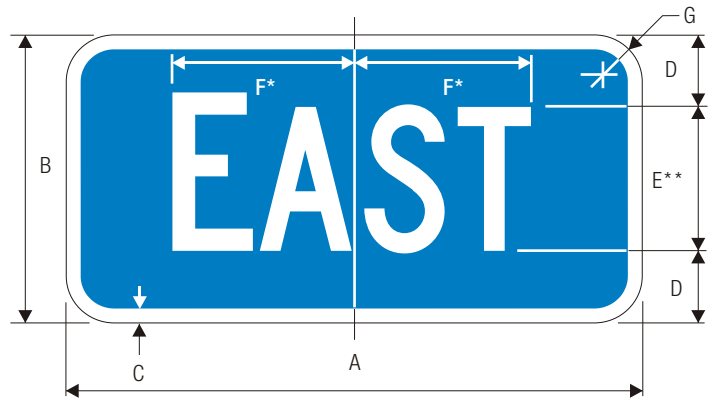

M3-2 (INTERSTATE)

CARDINAL DIRECTION AUXILIARY

A	B	C	D
600	300	15	75
750	375	20	87.5
E	F	G	
150 C	186	50	
200 C	248.5	50	

*Reduce to fit for 750 mm size.
 **Make first letter 10% larger.

COLORS: LEGEND —WHITE (RETROREFLECTIVE)
 BACKGROUND —BLUE (RETROREFLECTIVE)

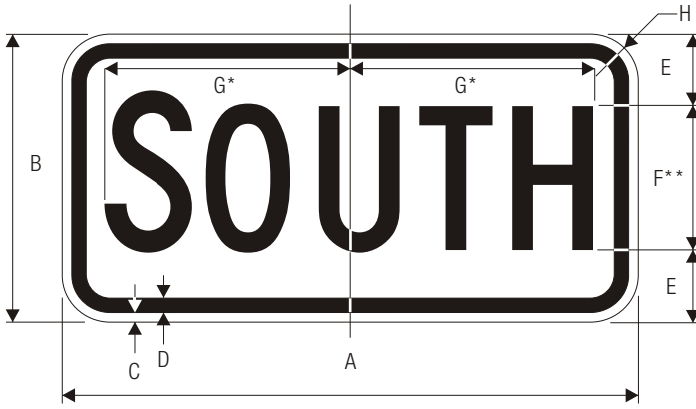

M3-3

CARDINAL DIRECTION AUXILIARY

A	B	C	D
600	300	10	15
750	375	13	20
E	F	G	H
75	150 C	255	50
87.5	200 C	318	50

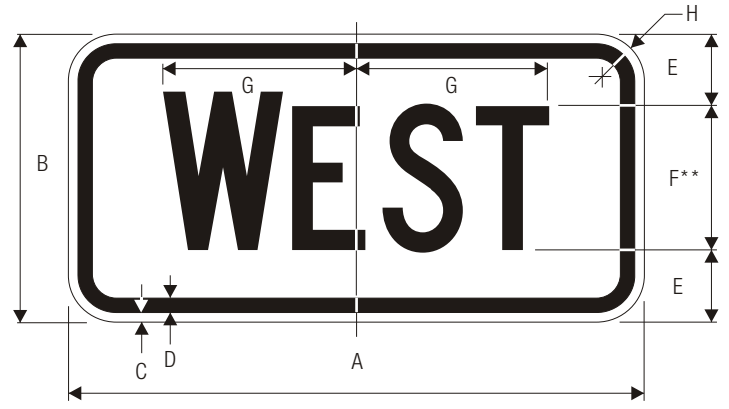

M3-4

CARDINAL DIRECTION AUXILIARY

A	B	C	D
600	300	10	15
750	375	13	20
E	F	G	H
75	150 C	201	50
87.5	200 C	268	50

*Reduce to fit for 750 mm size.
 **Make first letter 10% larger.

COLORS: LEGEND —BLACK
 BACKGROUND —WHITE (RETROREFLECTIVE)

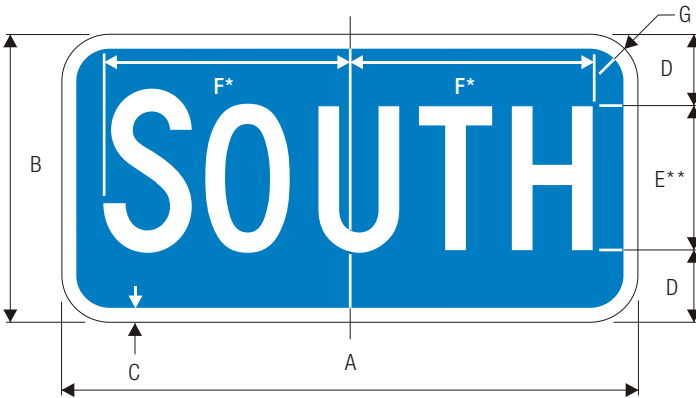

M3-3 (INTERSTATE)

CARDINAL DIRECTION AUXILIARY

A	B	C	D
600	300	15	75
750	375	20	87.5
E	F	G	
150 C	255	50	
200 C	318	50	

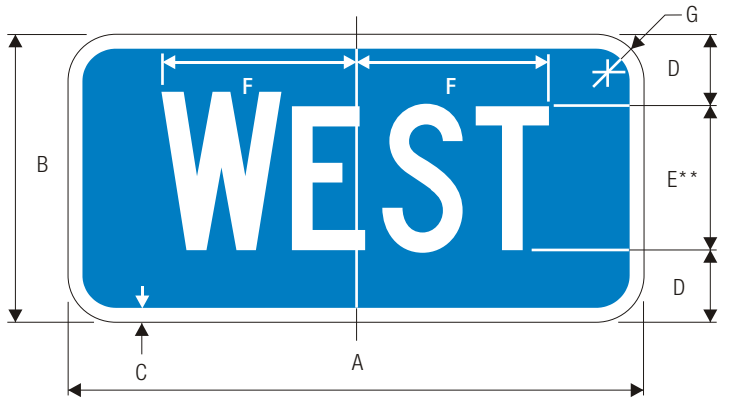

M3-4 (INTERSTATE)

CARDINAL DIRECTION AUXILIARY

A	B	C	D
600	300	15	75
750	375	20	87.5
E	F	G	
150 C	201	50	
200 C	268	50	

*Reduce to fit for 750 mm size.
 **Make first letter 10% larger.

COLORS: LEGEND —WHITE (RETROREFLECTIVE)
 BACKGROUND —BLUE (RETROREFLECTIVE)



M4-1
ALTERNATE AUXILIARY

A	B	C	D
600	300	10	14
750	375	13	20
E	F	G	H
100	100 B	241.5	50
119	137 B	323.5	50

*Reduce to fit for 750 mm size.

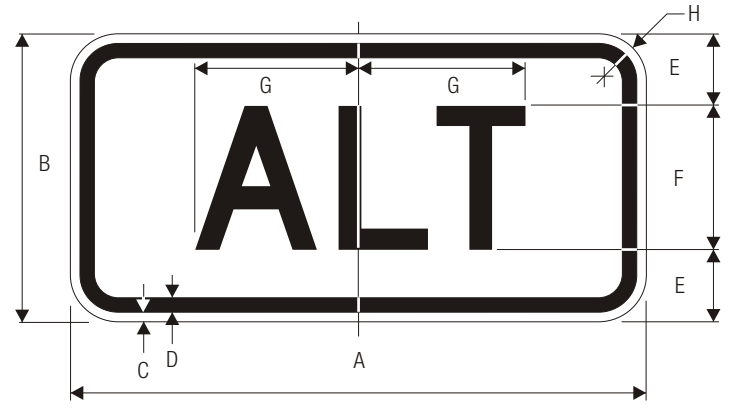

M4-1a
ALTERNATE AUXILIARY

A	B	C	D
600	300	10	15
750	375	13	20
E	F	G	H
75	150 D	172	50
87.5	200 D	229.5	50

COLORS: LEGEND —BLACK
BACKGROUND —WHITE (RETROREFLECTIVE)

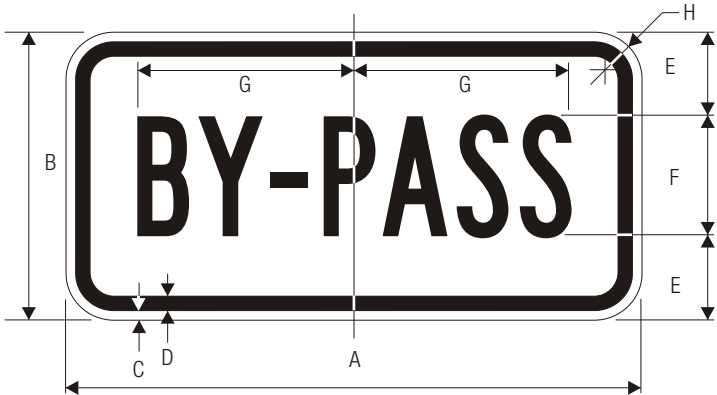

M4-2
BY-PASS AUXILIARY

A	B	C	D
600	300	10	15
750	375	13	20
E	F	G	H
87.5	125 B	226	50
100	175 B	316.5	50

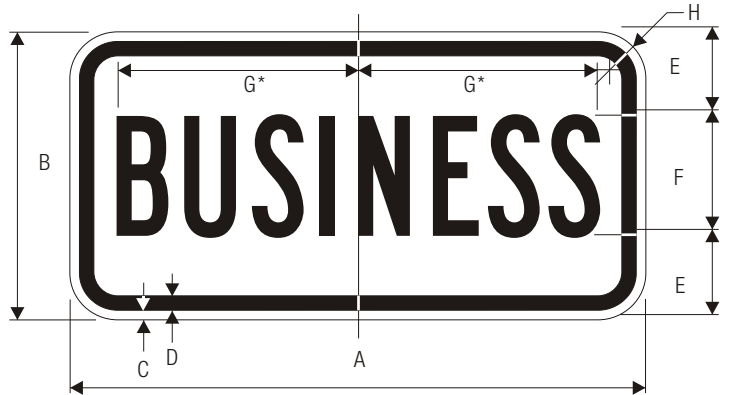

M4-3
BY-PASS AUXILIARY

A	B	C	D
600	300	10	15
750	375	13	20
E	F	G	H
87.5	125 B	252	50
100	175 B	316.5	50

*Reduce to fit for 750 mm size.

COLORS: LEGEND —BLACK
BACKGROUND —WHITE (RETROREFLECTIVE)

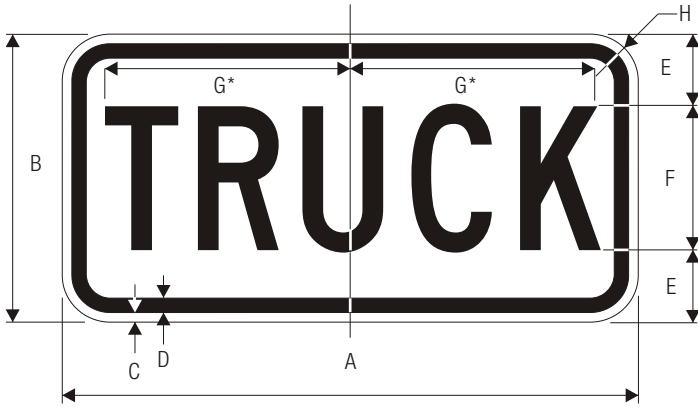

M4-4
TRUCK AUXILIARY

A	B	C	D
600	300	10	14
750	375	13	20
E	F	G	H
75	150 C	258.5	50
87.5	200 C	321.5	50

*Reduce to fit for 750 mm size.

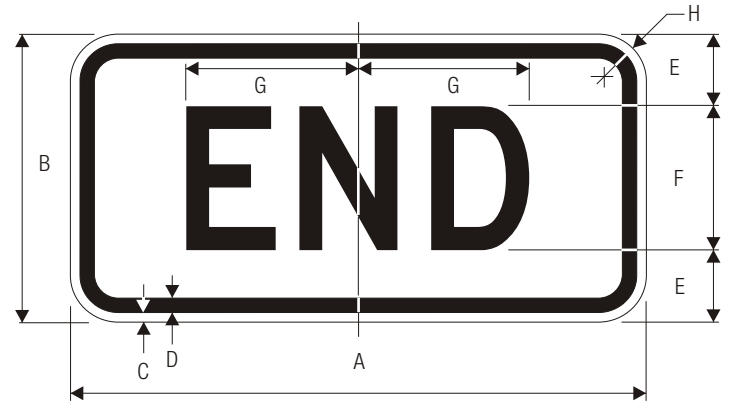

M4-6
END AUXILIARY

A	B	C	D
600	300	10	15
750	375	13	20
E	F	G	H
75	150 D	178.5	50
87.5	200 D	238	50

COLORS: LEGEND —BLACK
BACKGROUND —WHITE (RETROREFLECTIVE)

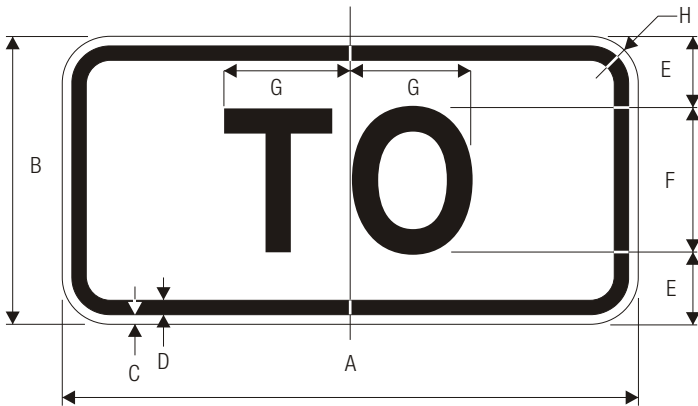

M4-5
TO AUXILIARY

A	B	C	D
600	300	10	14
750	375	13	20
E	F	G	H
75	150 E	129.5	50
87.5	200 E	172.5	50

COLORS: LEGEND —BLACK
BACKGROUND —WHITE (RETROREFLECTIVE)

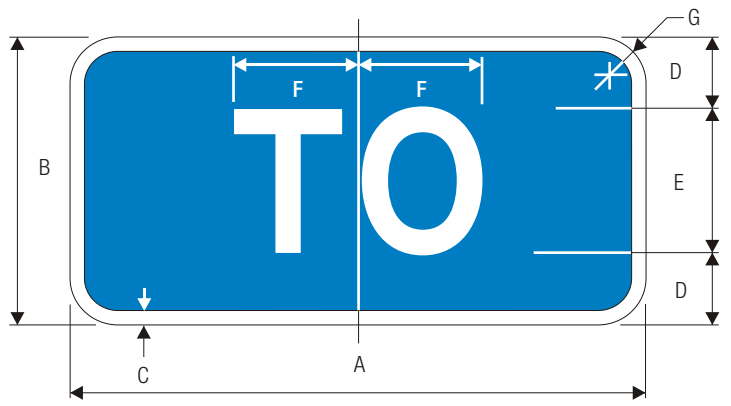

M4-5 (INTERSTATE)
TO AUXILIARY

A	B	C	D
600	300	15	75
750	375	20	87.5
E	F	G	
150 E	129.5	50	
200 E	172.5	50	

COLORS: LEGEND —WHITE (RETROREFLECTIVE)
BACKGROUND —BLUE (RETROREFLECTIVE)

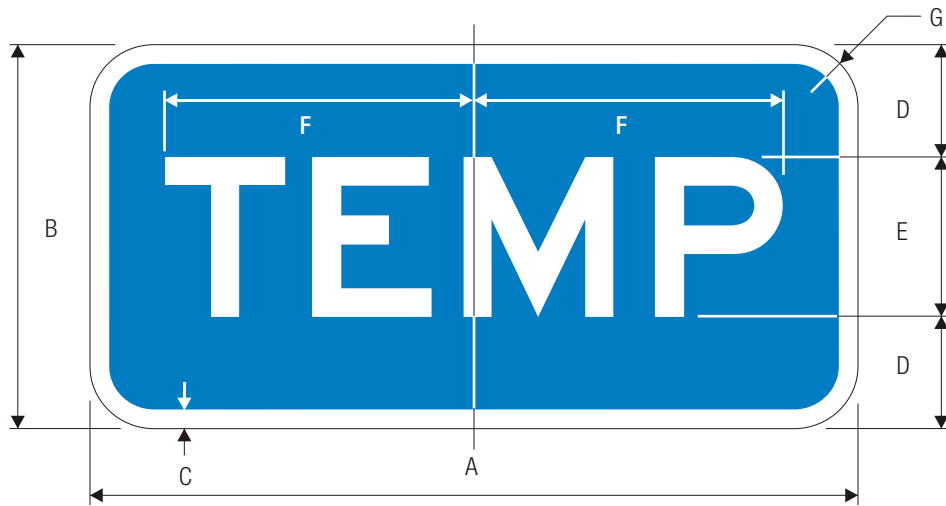

M4-7a (INTERSTATE)

TEMPORARY AUXILIARY

A	B	C	D	E	F	G
600	300	15	87.5	125 E	241.5	50
750	375	20	112.5	150 E	289.5	50

COLORS: LEGEND —WHITE (RETROREFLECTIVE)
 BACKGROUND —BLUE (RETROREFLECTIVE)

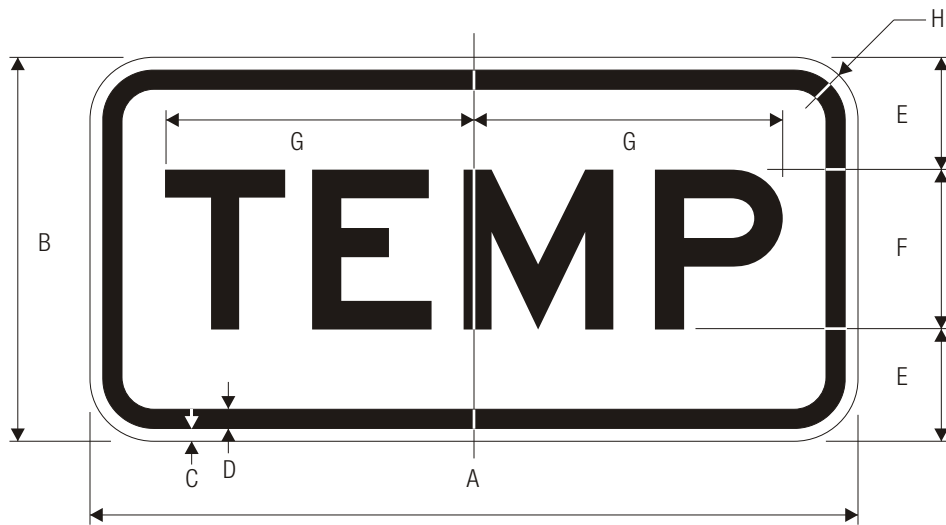

M4-7a

TEMPORARY AUXILIARY

A	B	C	D	E	F	G	H
600	300	10	14	87.5	125 E	241.5	50
750	375	13	20	112.5	150 E	289.5	50

COLORS: LEGEND —BLACK
 BACKGROUND —WHITE (RETROREFLECTIVE)

BICYCLE FACILITIES

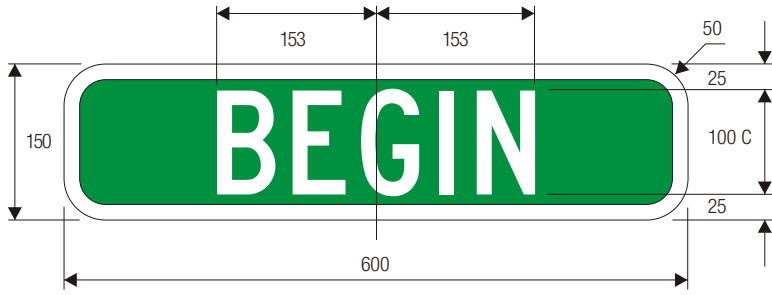

M4-11
BEGIN AUXILIARY

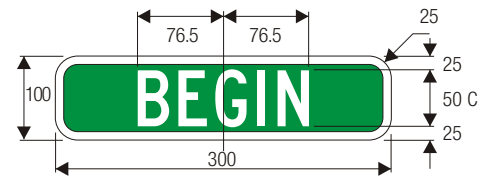

M4-11

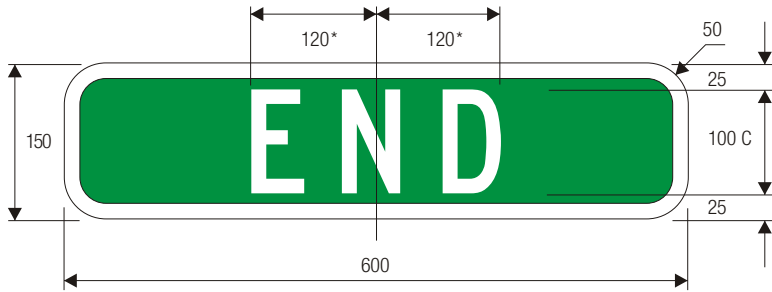

M4-12
END AUXILIARY

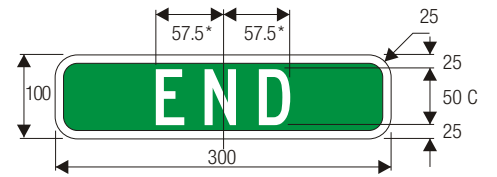

M4-12

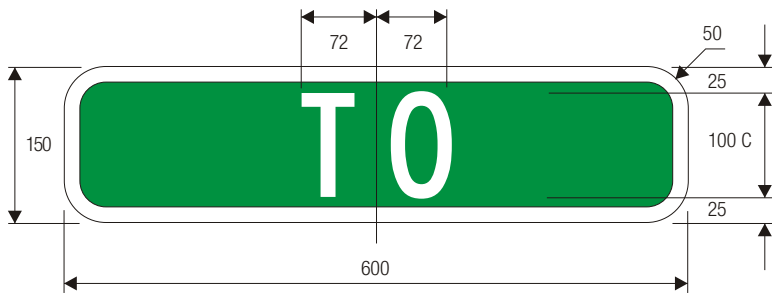

M4-13
TO AUXILIARY

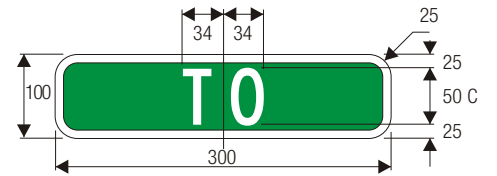

M4-13

*Increase spacing to fit.

COLORS: LEGEND —WHITE (RETROREFLECTIVE)
BACKGROUND —GREEN (RETROREFLECTIVE)

DIRECTIONAL ARROW AUXILIARY

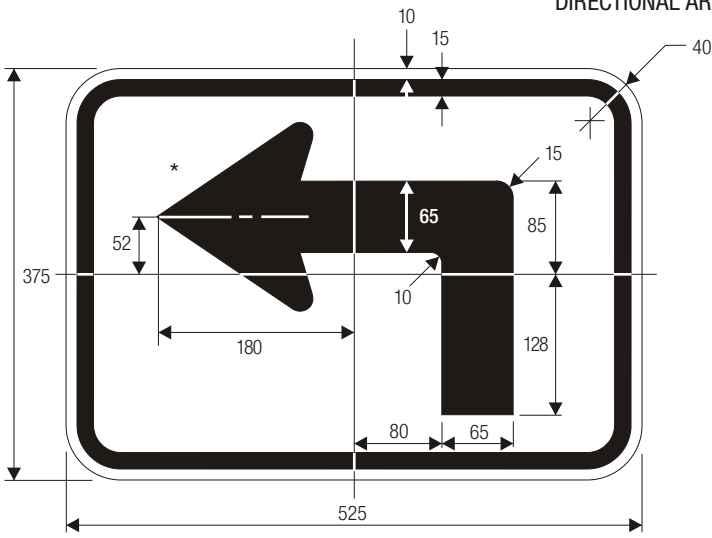

M5-1

*See page 6-2 for arrow detail.

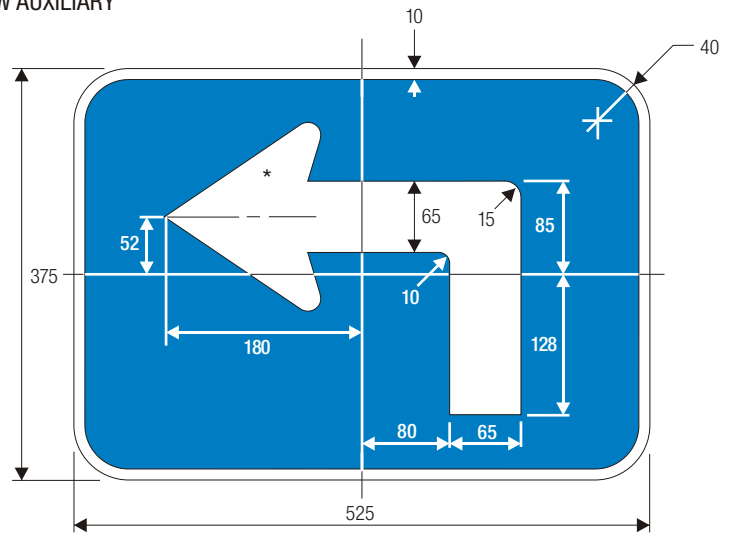

M5-1 (Interstate)

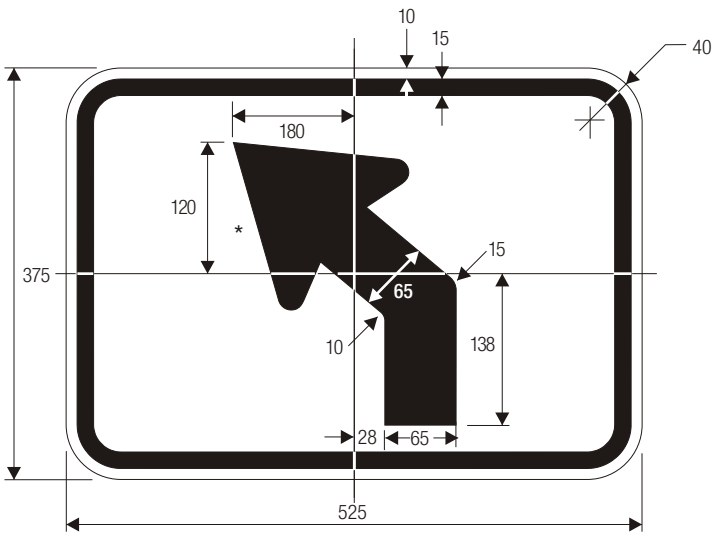

M5-2

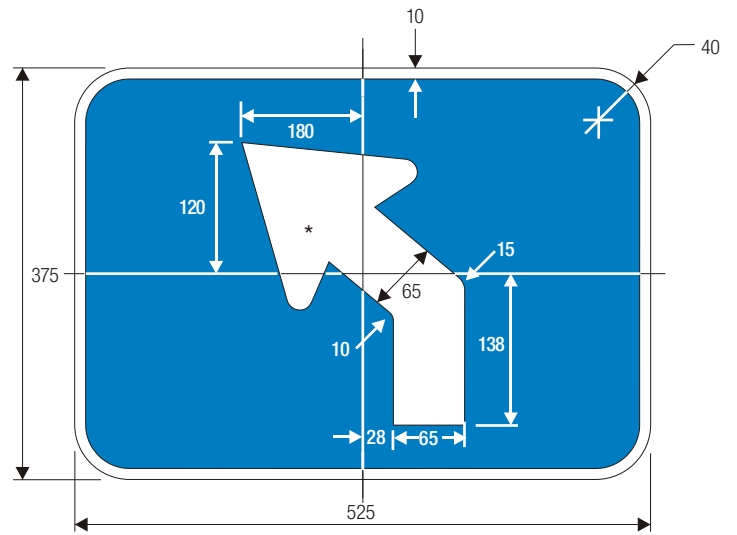

M5-2 (Interstate)

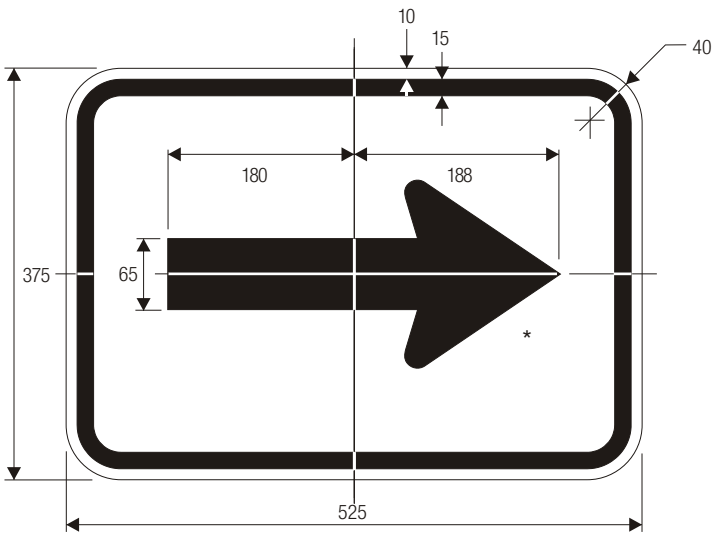

M6-1

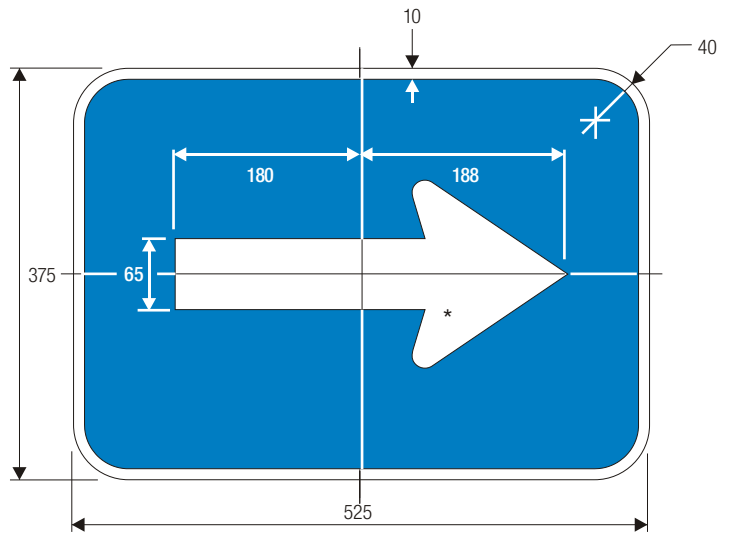

M6-1 (Interstate)

COLORS: LEGEND —BLACK
BACKGROUND —WHITE (RETROREFLECTIVE)

COLORS: LEGEND —WHITE (RETROREFLECTIVE)
BACKGROUND —BLUE (RETROREFLECTIVE)

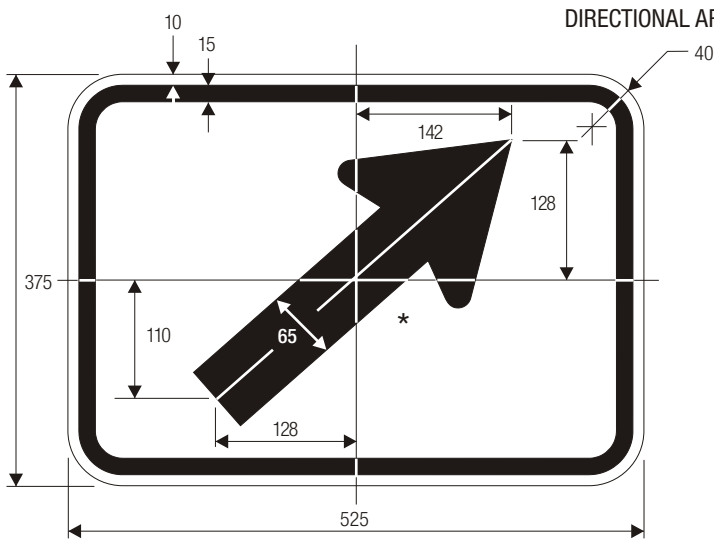

M6-2

*See page 6-2 for arrow design.

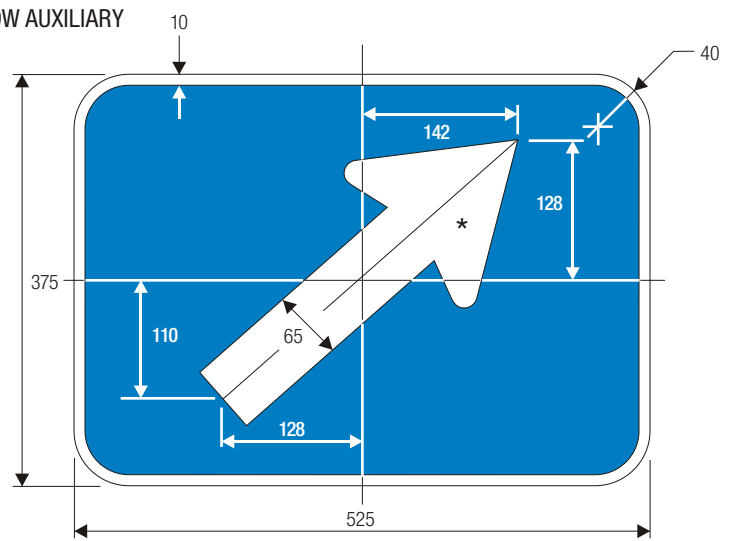

M6-2 (Interstate)

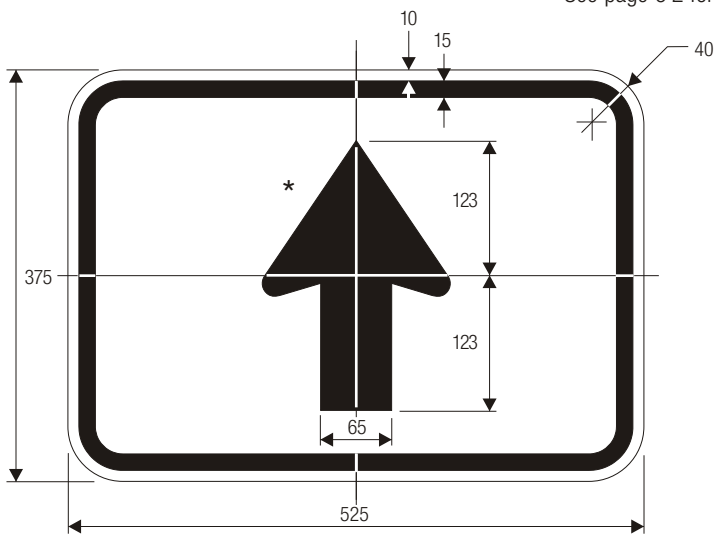

M6-3

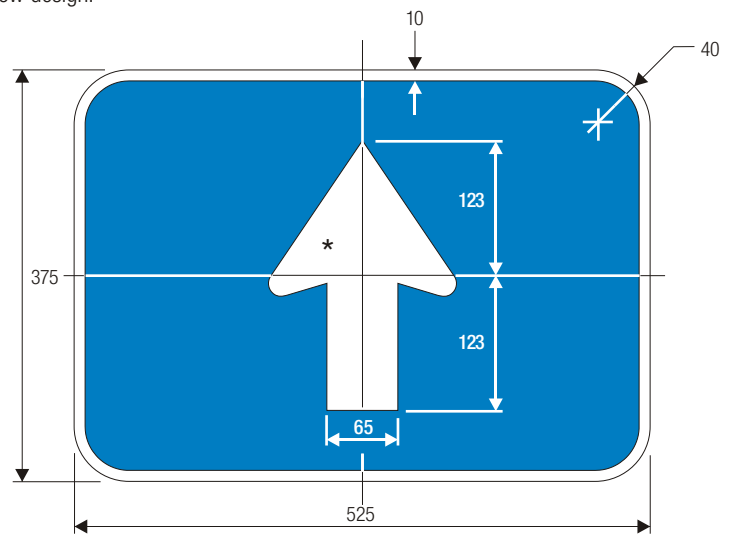

M6-3 (Interstate)

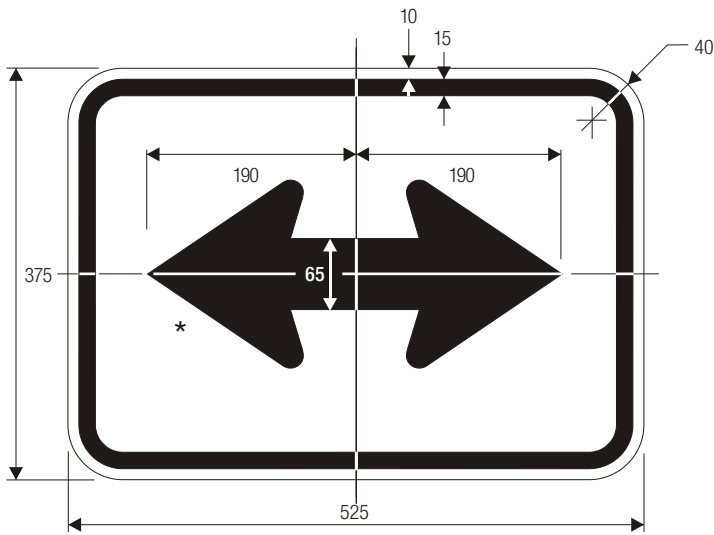

M6-4

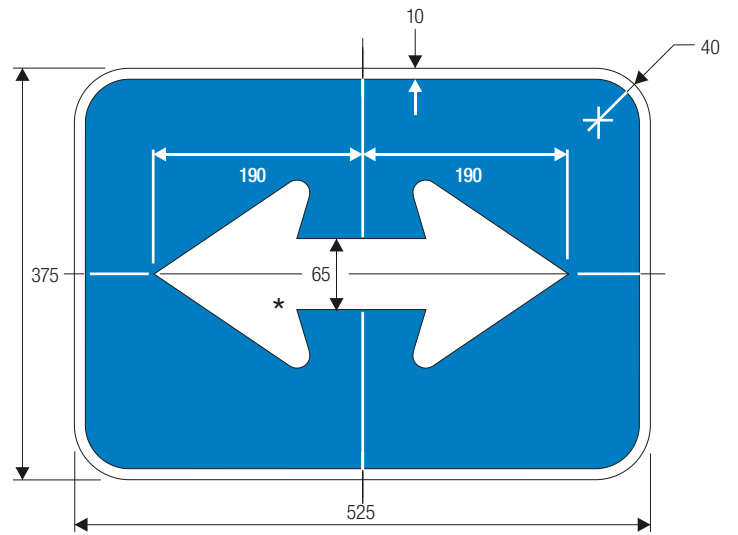

M6-4 (Interstate)

COLORS: LEGEND —BLACK
BACKGROUND —WHITE (RETROREFLECTIVE)

COLORS: LEGEND —WHITE (RETROREFLECTIVE)
BACKGROUND —BLUE (RETROREFLECTIVE)

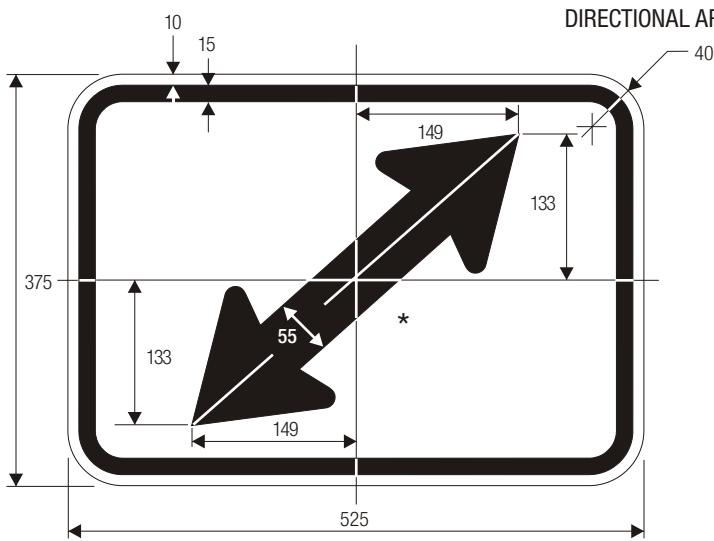

M6-5

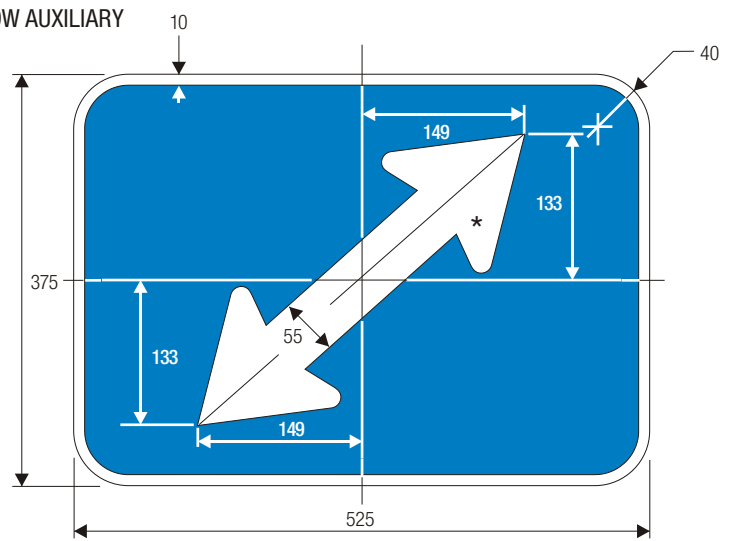

M6-5 (Interstate)

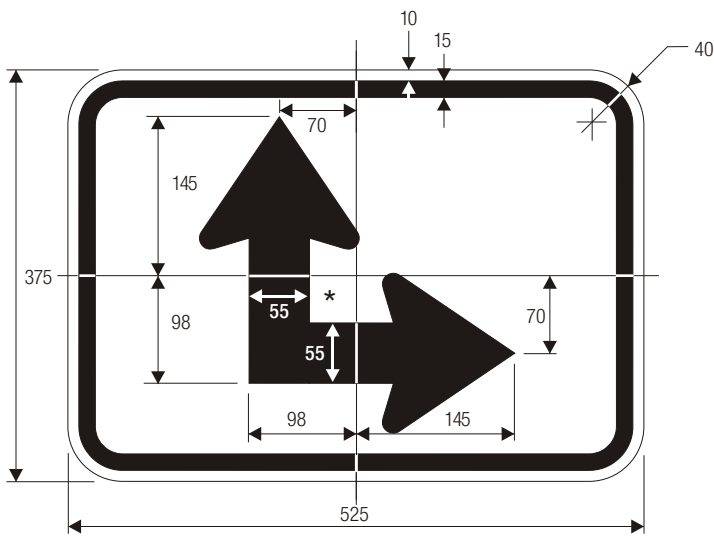

M6-6

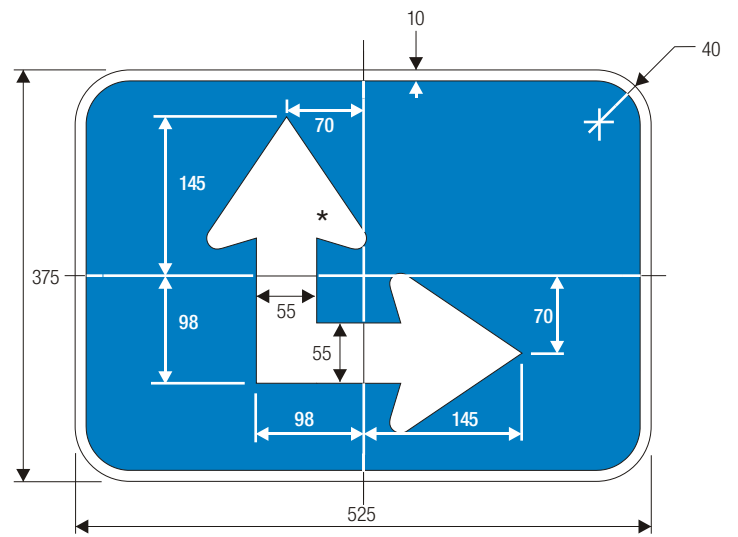

M6-6 (Interstate)

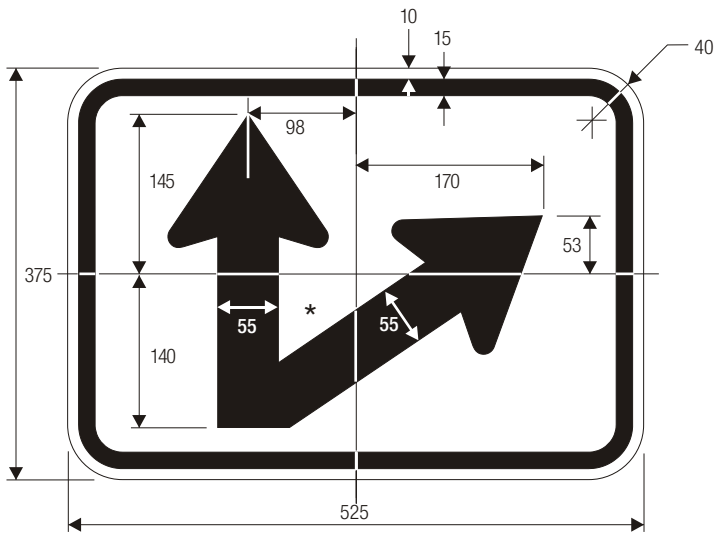

M6-7

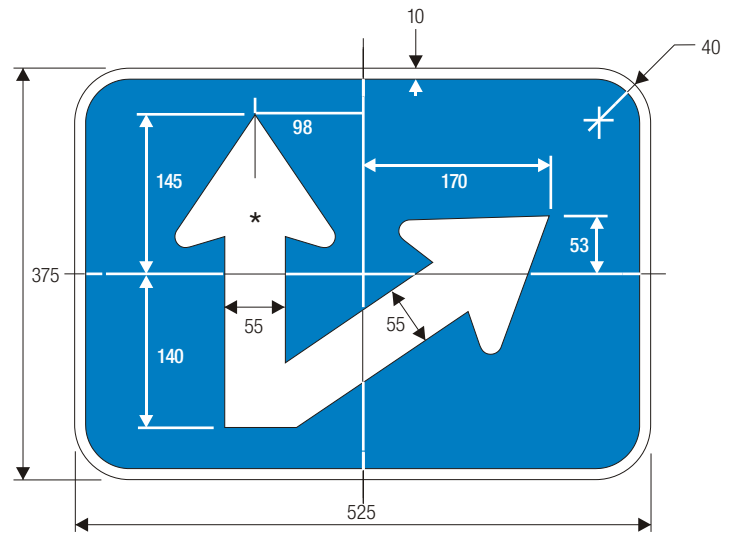

M6-7 (Interstate)

COLORS: LEGEND —BLACK
BACKGROUND —WHITE (RETROREFLECTIVE)

COLORS: LEGEND —WHITE (RETROREFLECTIVE)
BACKGROUND —BLUE (RETROREFLECTIVE)

DIRECTIONAL ARROW AUXILIARY

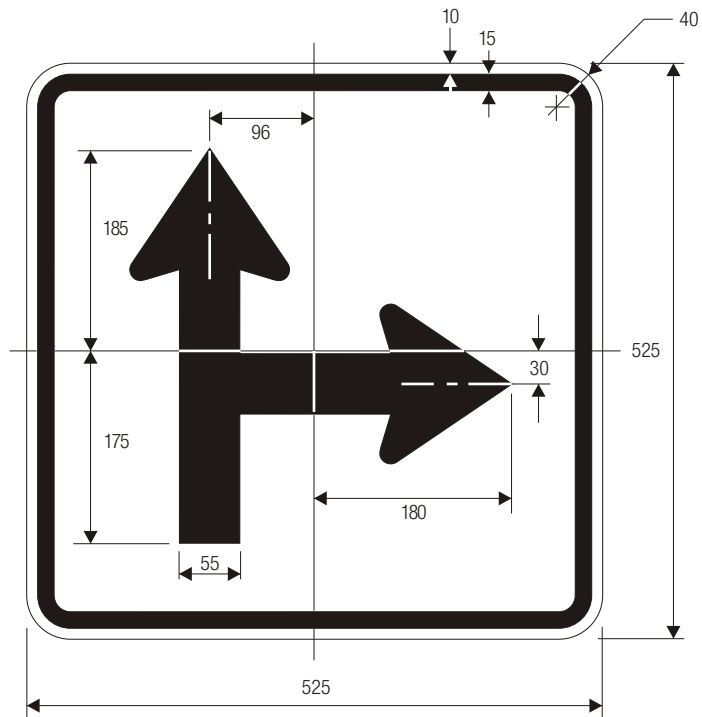

M6-8

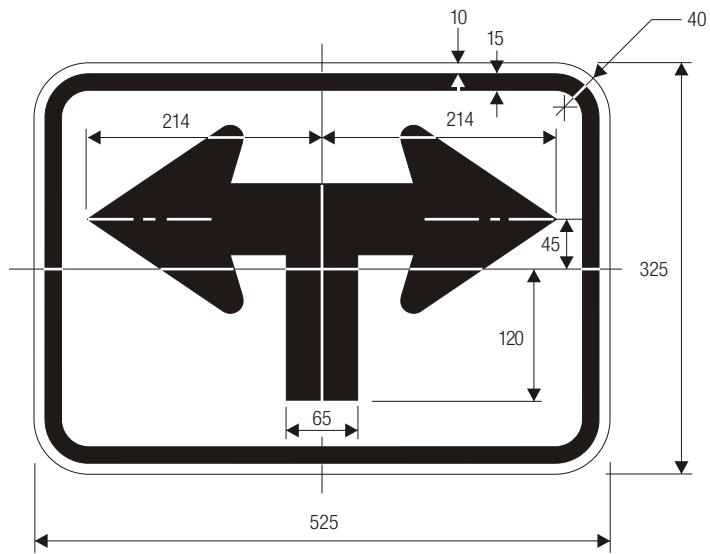

M6-9

*See page 6-2 for arrow design.

COLORS: LEGEND —BLACK
 BACKGROUND —WHITE (RETROREFLECTIVE)

DIRECTIONAL ARROW AUXILIARY
BICYCLE FACILITIES

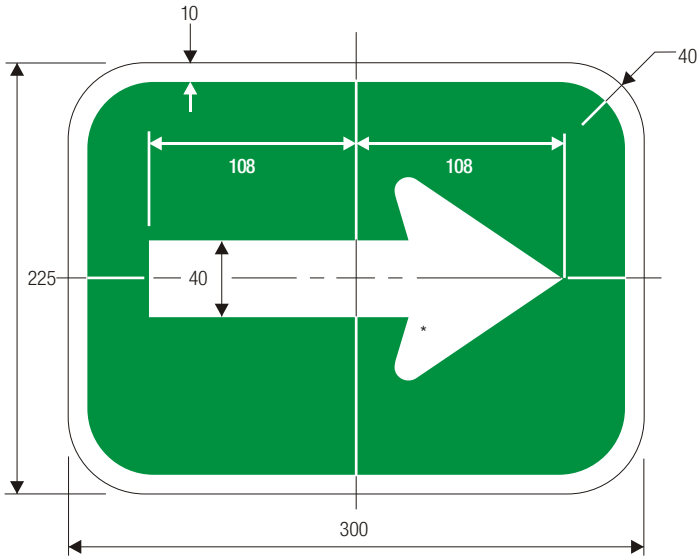

M7-1

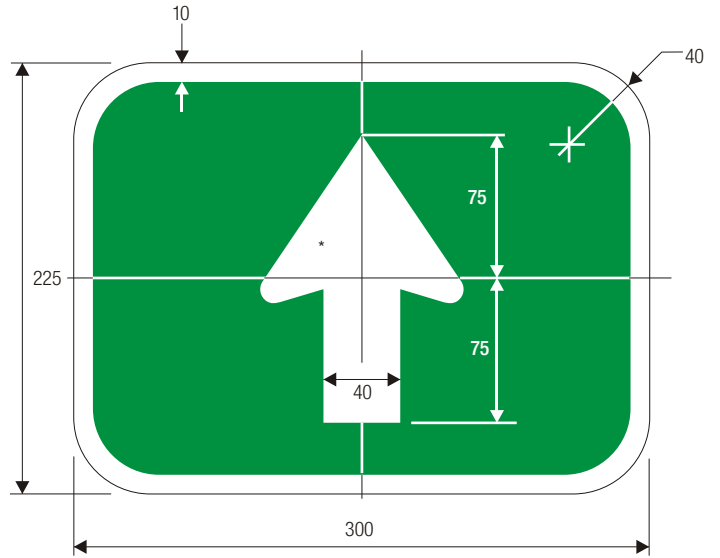

M7-2

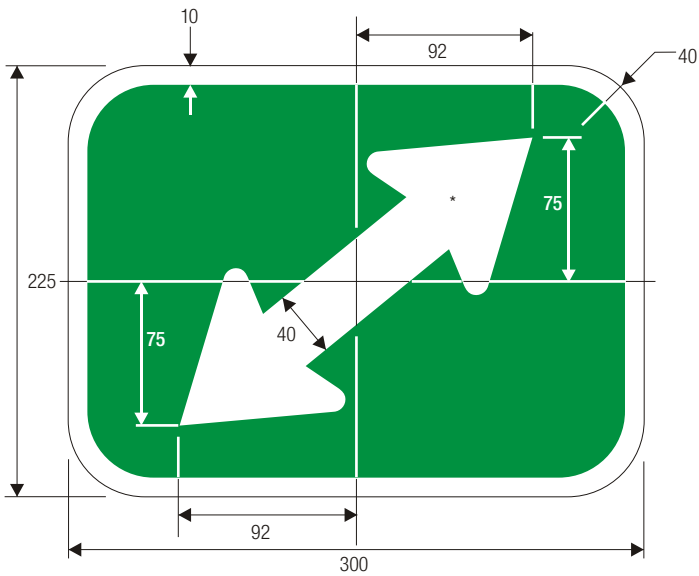

M7-3

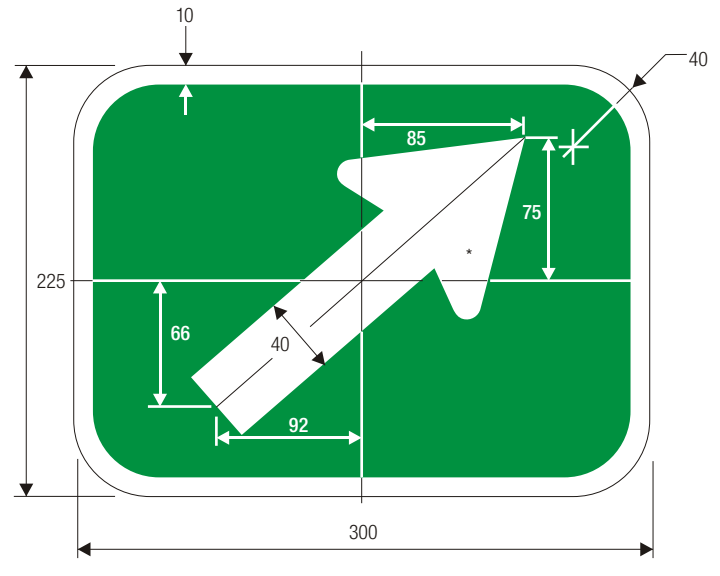

M7-4

*See page 6-2 for arrow design.

COLORS: SYMBOL —WHITE (RETROREFLECTIVE)
BACKGROUND —GREEN (RETROREFLECTIVE)

DIRECTIONAL ARROW AUXILIARY
BICYCLE FACILITIES

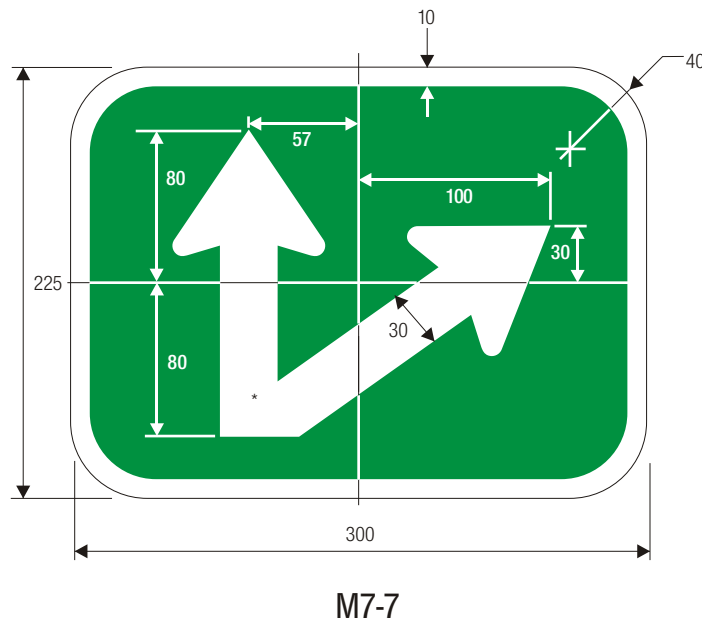
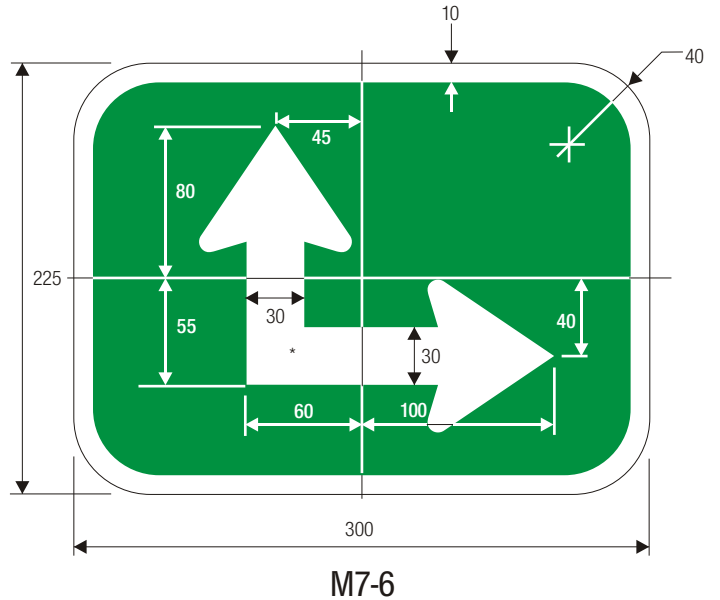
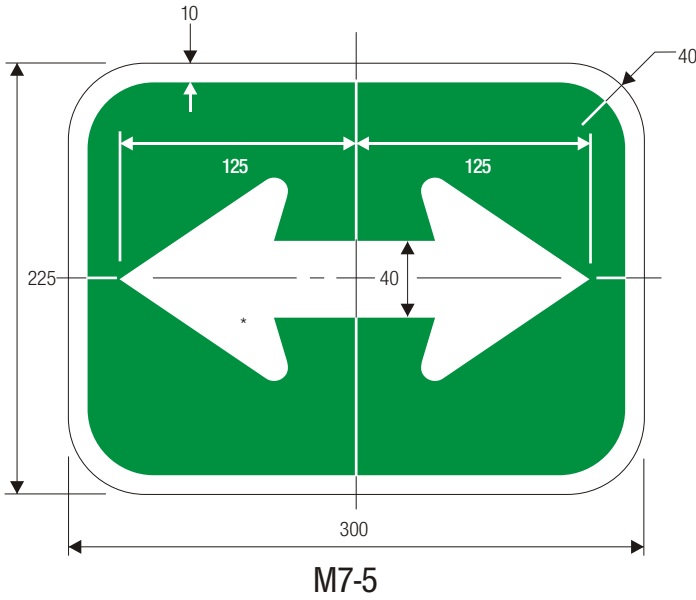

*See page 6-2 for arrow design.

COLORS: SYMBOL —WHITE (RETROREFLECTIVE)
BACKGROUND —GREEN (RETROREFLECTIVE)

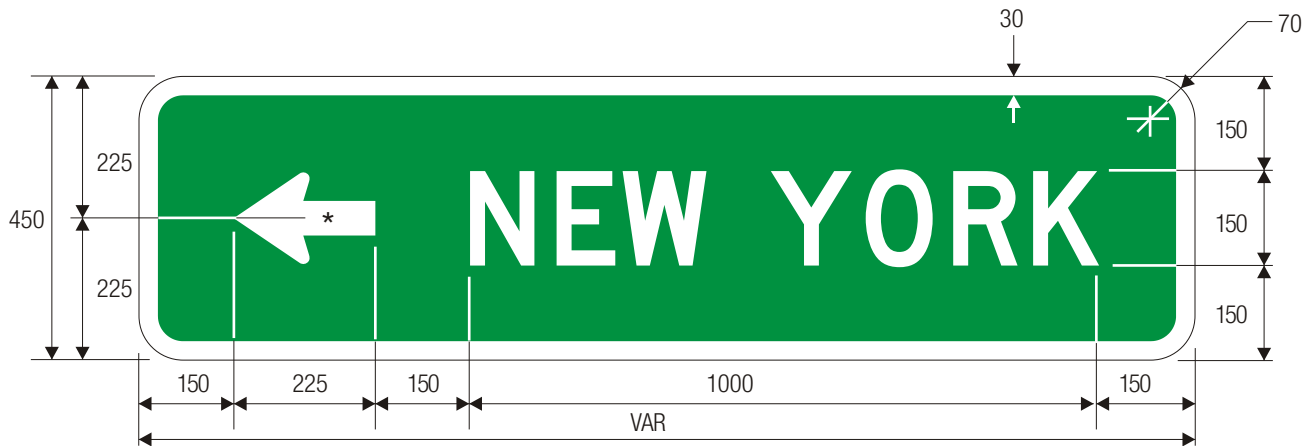

*See page 6-2 for arrow design.

COLORS: LEGEND —WHITE (RETROREFLECTIVE)
 BACKGROUND —GREEN (RETROREFLECTIVE)



D1-1bL
DESTINATION

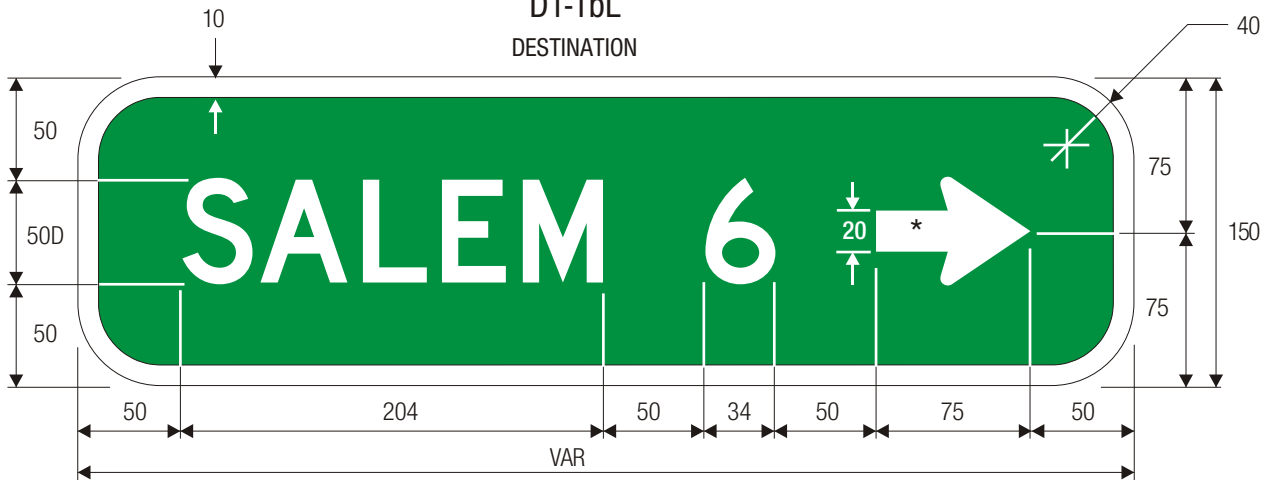

D1-1bR
DESTINATION

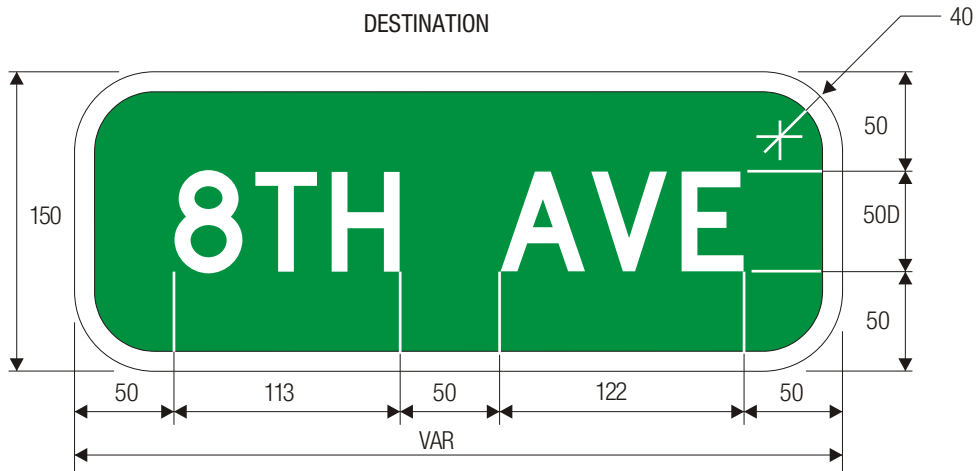

D1-1c
DESTINATION

COLORS: LEGEND -WHITE (RETROREFLECTIVE)
 BACKGROUND -GREEN (RETROREFLECTIVE)



D1-2
DESTINATION



D1-2a
DESTINATION

*See page 6-2 for arrow design

COLORS: LEGEND —WHITE (RETROREFLECTIVE)
BACKGROUND —GREEN (RETROREFLECTIVE)



D1-3

DESTINATION

*See page 6-2 for arrow design.



D1-3a

DESTINATION

COLORS: LEGEND -WHITE (RETROREFLECTIVE)
 BACKGROUND -GREEN (RETROREFLECTIVE)

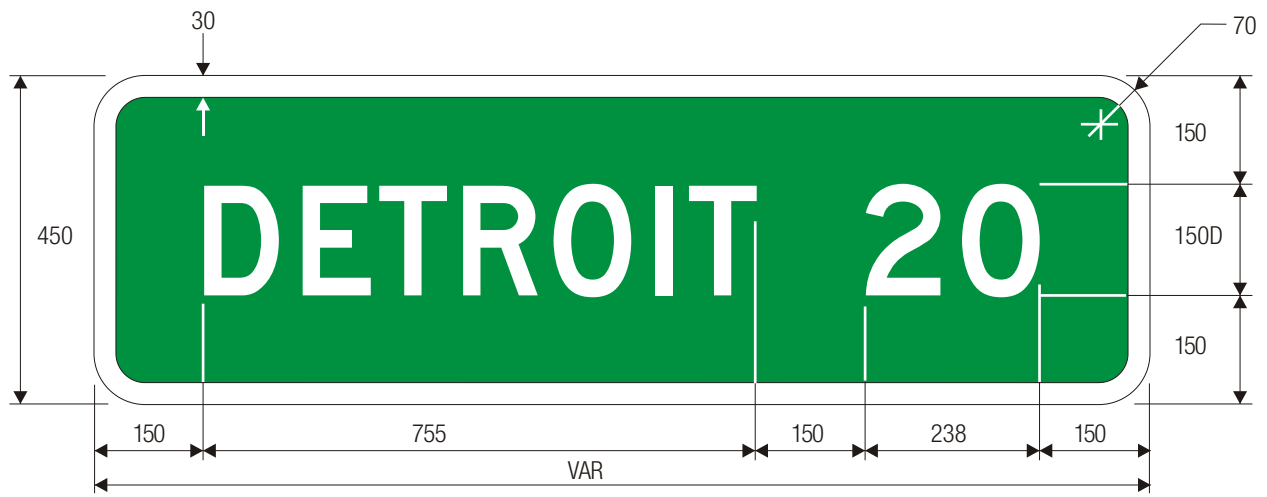

D2-1 DISTANCE

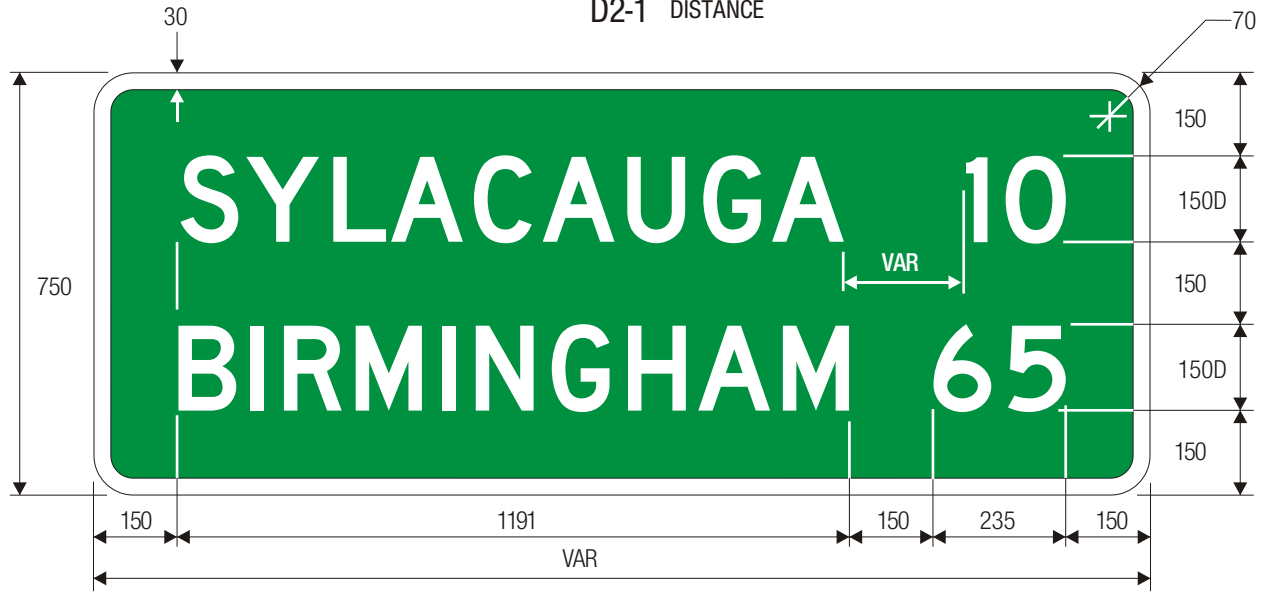

D2-2 DISTANCE



D2-3 DISTANCE

COLORS: LEGEND -WHITE (RETROREFLECTIVE)
 BACKGROUND -GREEN (RETROREFLECTIVE)



D-3
STREET NAME



D-3
STREET NAME

COLORS: LEGEND -WHITE (REFLECTIVE)
BACKGROUND -GREEN (REFLECTIVE)

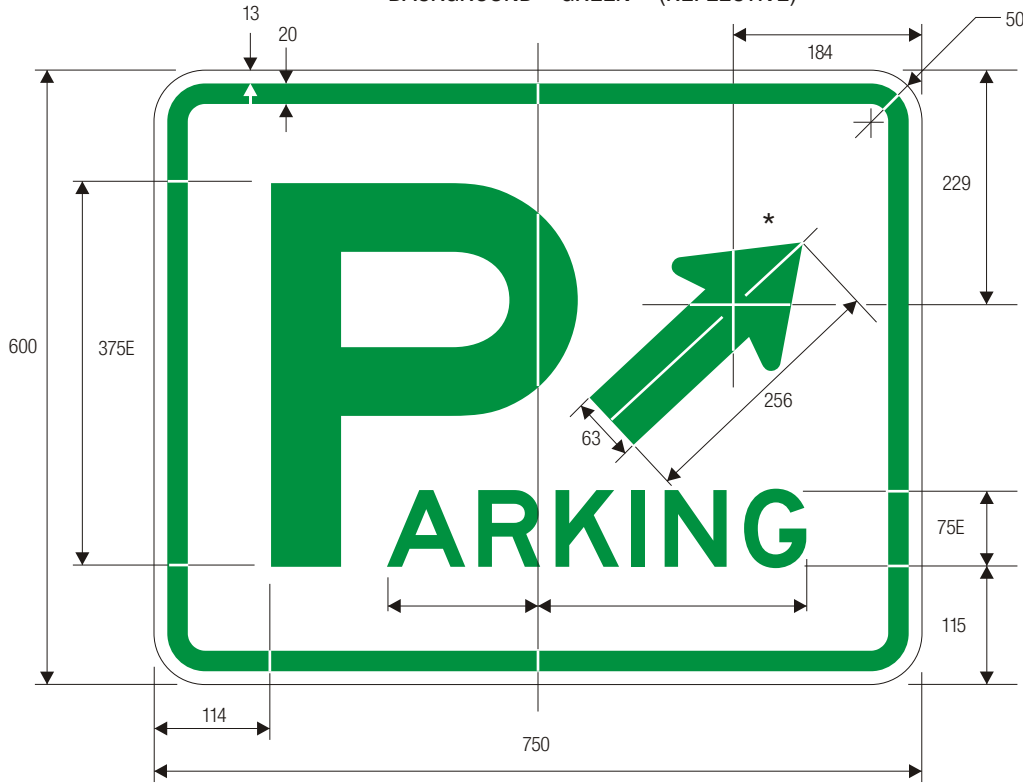

D4-1
PARKING AREA

*See page 6-2 for arrow design.

COLORS: LEGEND -WHITE (RETROREFLECTIVE)
BACKGROUND -GREEN (RETROREFLECTIVE)

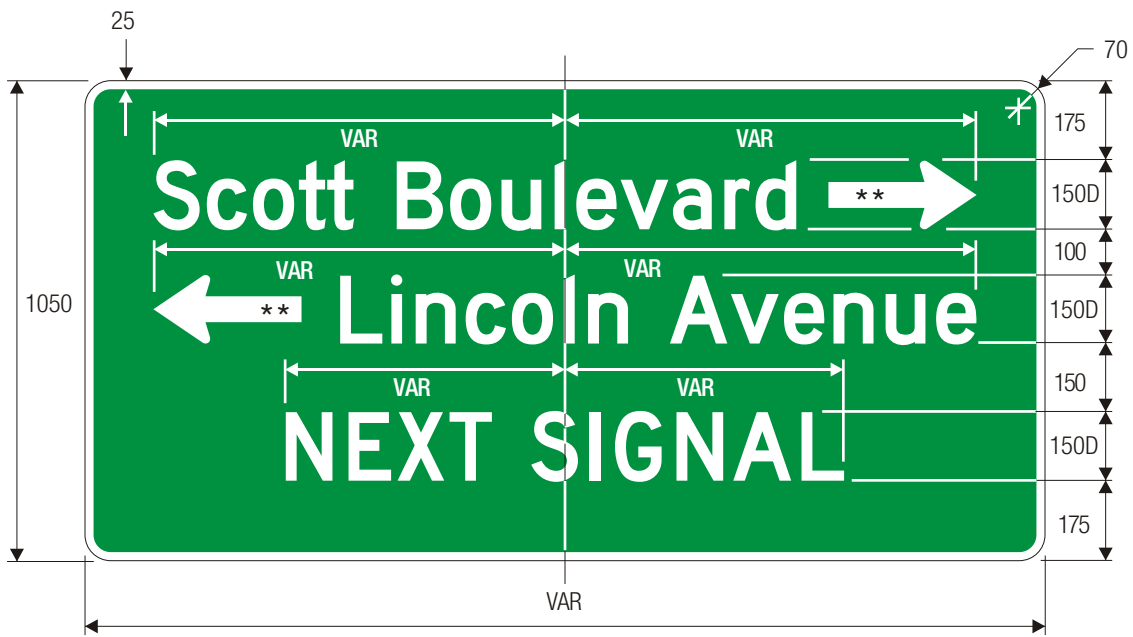

D3-2

ADVANCE STREET NAME

**See page 6-2 for arrow design.

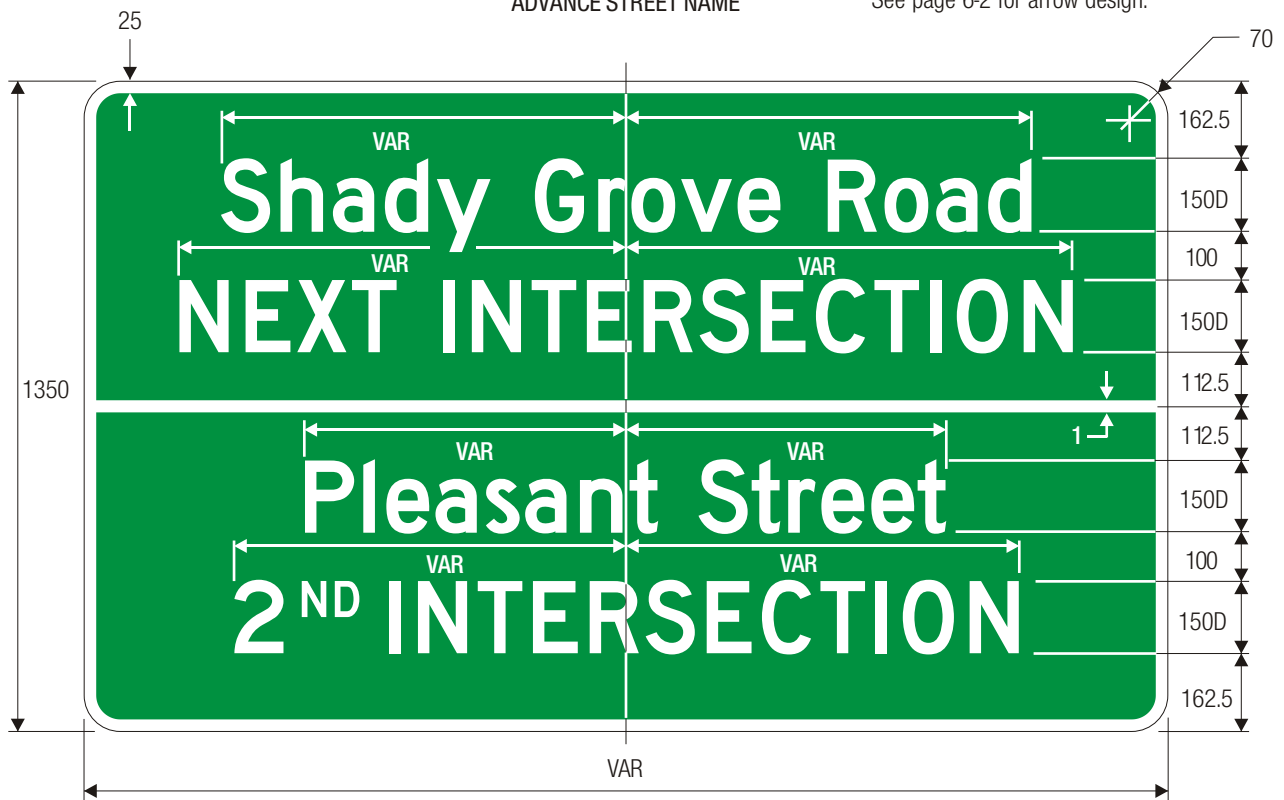

COLORS: LEGEND -WHITE (RETROREFLECTIVE)
 BACKGROUND -GREEN (RETROREFLECTIVE)

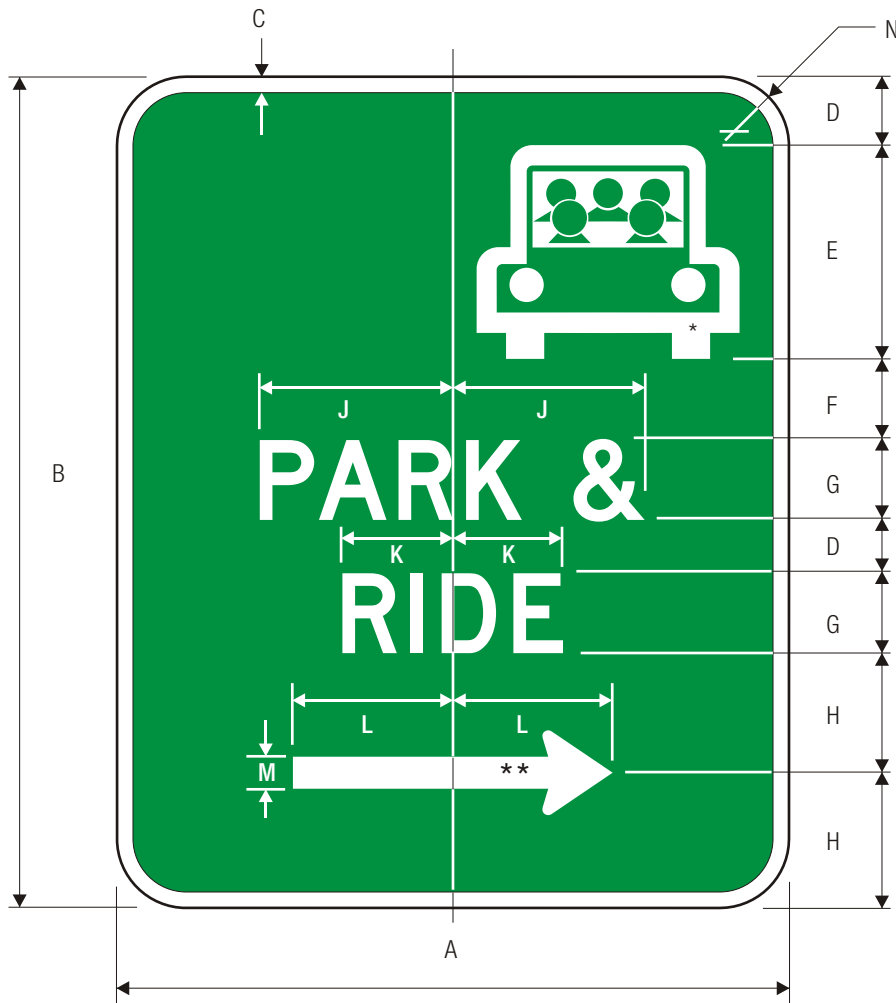

D4-2

PARK & RIDE

**See page 6-2 for arrow design.

*See symbol on page 6-42

A	B	C	D	E	F	G	H	J	K	L	M	N
600	750	15	50	200	76	75 D	112	180.5	103.5	150	30	50
750	900	20	75	225	75	100 D	125	240.5	138	175	40	50
900	1200	25	100	275	75	150 D	175	361	207	225	55	60

COLORS: LEGEND —WHITE (RETROREFLECTIVE)
 BACKGROUND —GREEN (RETROREFLECTIVE)
 SYMBOL —GREEN ON WHITE (RETROREFLECTIVE)



D4-3

BICYCLE PARKING

*See page 6-7 for symbol design.

**See page 6-2 for arrow design.

COLORS: LEGEND & SYMBOL — GREEN (RETROREFLECTIVE)
 BACKGROUND — WHITE (RETROREFLECTIVE)

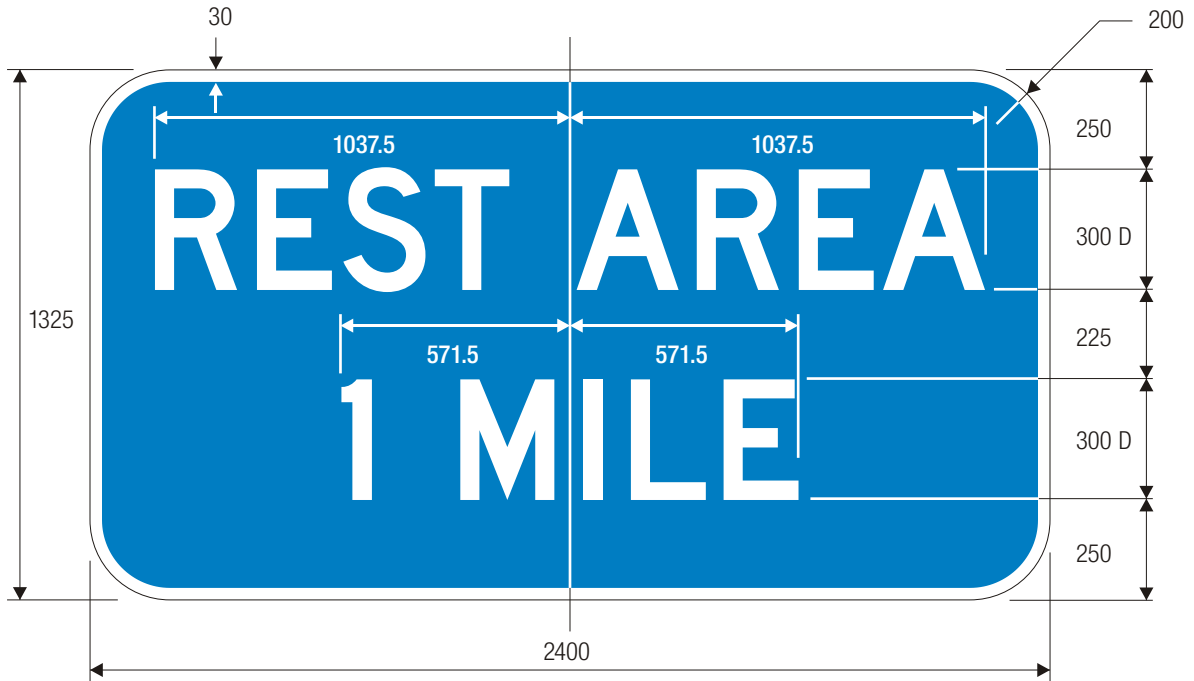

D5-1

ADVANCE REST AREA DISTANCE

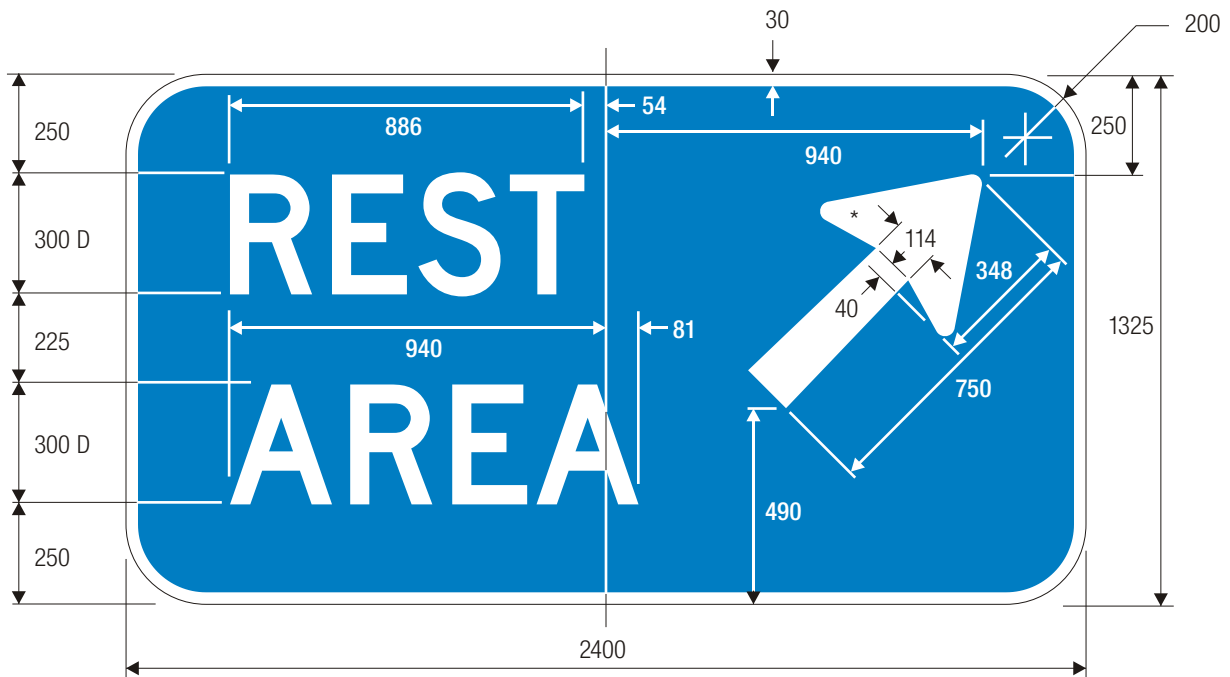

D5-2

*See page 6-3 for symbol design.

REST AREA EXIT DIRECTION

COLORS: LEGEND & ARROW – WHITE (RETROREFLECTIVE)
 BACKGROUND – BLUE (RETROREFLECTIVE)

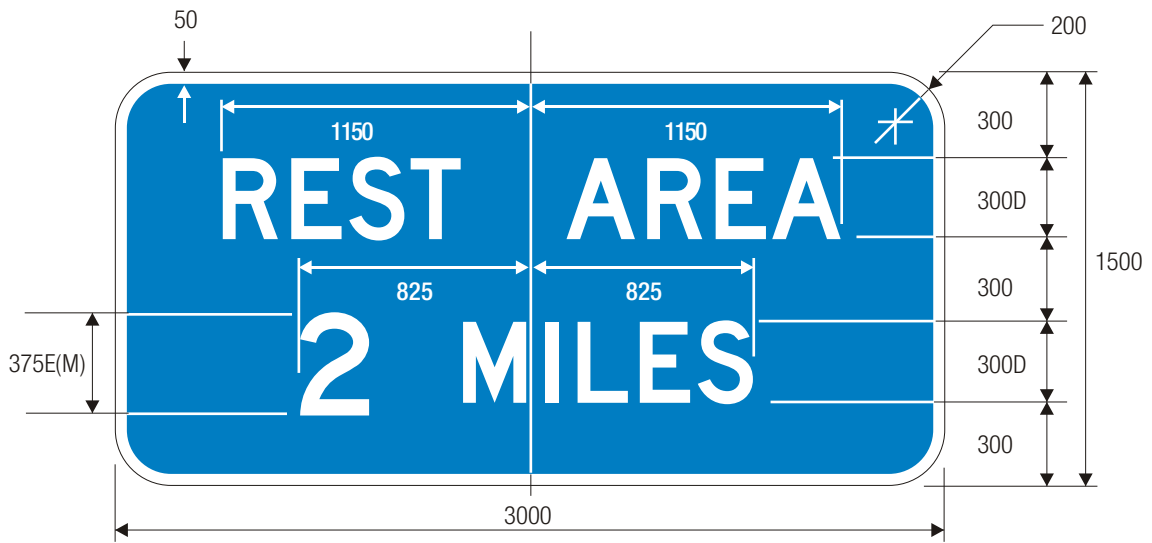

D5-1a

ADVANCE REST AREA DISTANCE

COLORS: LEGEND — WHITE (RETROREFLECTIVE)
 BACKGROUND — BLUE (RETROREFLECTIVE)

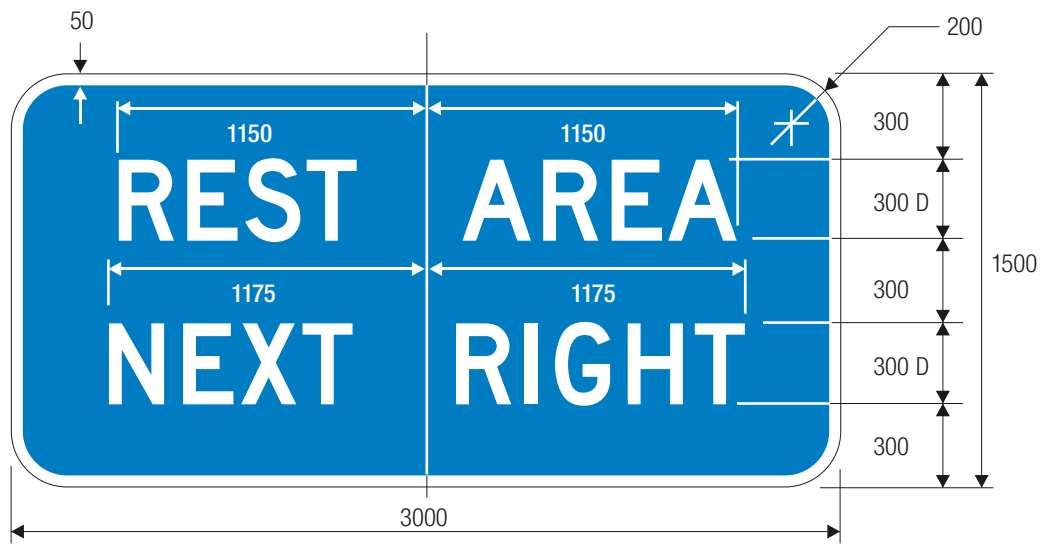

D5-1b

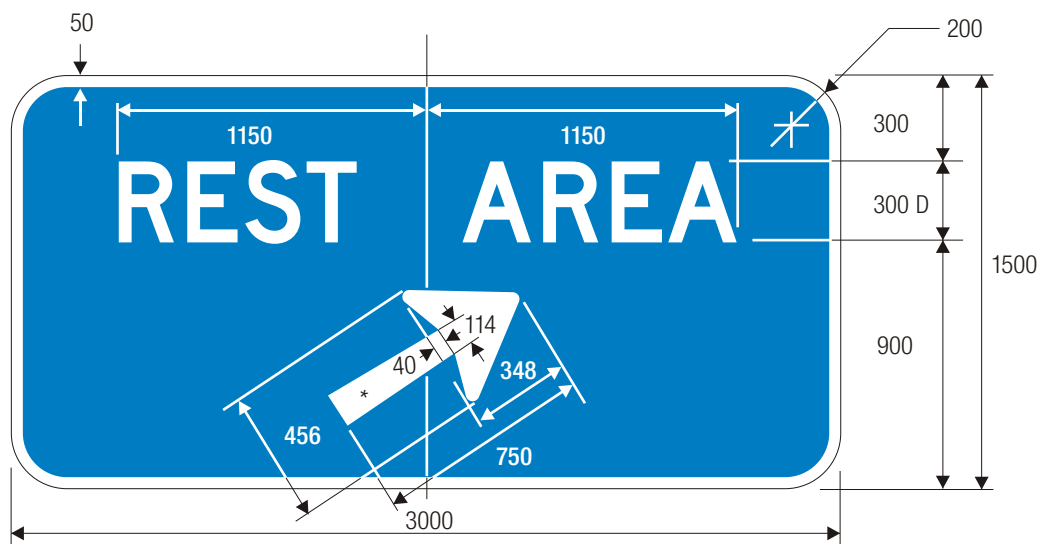

D5-2a

*See page 6-3 for arrow design details.

COLORS: LEGEND – WHITE (RETROREFLECTIVE)
 BACKGROUND – BLUE (RETROREFLECTIVE)

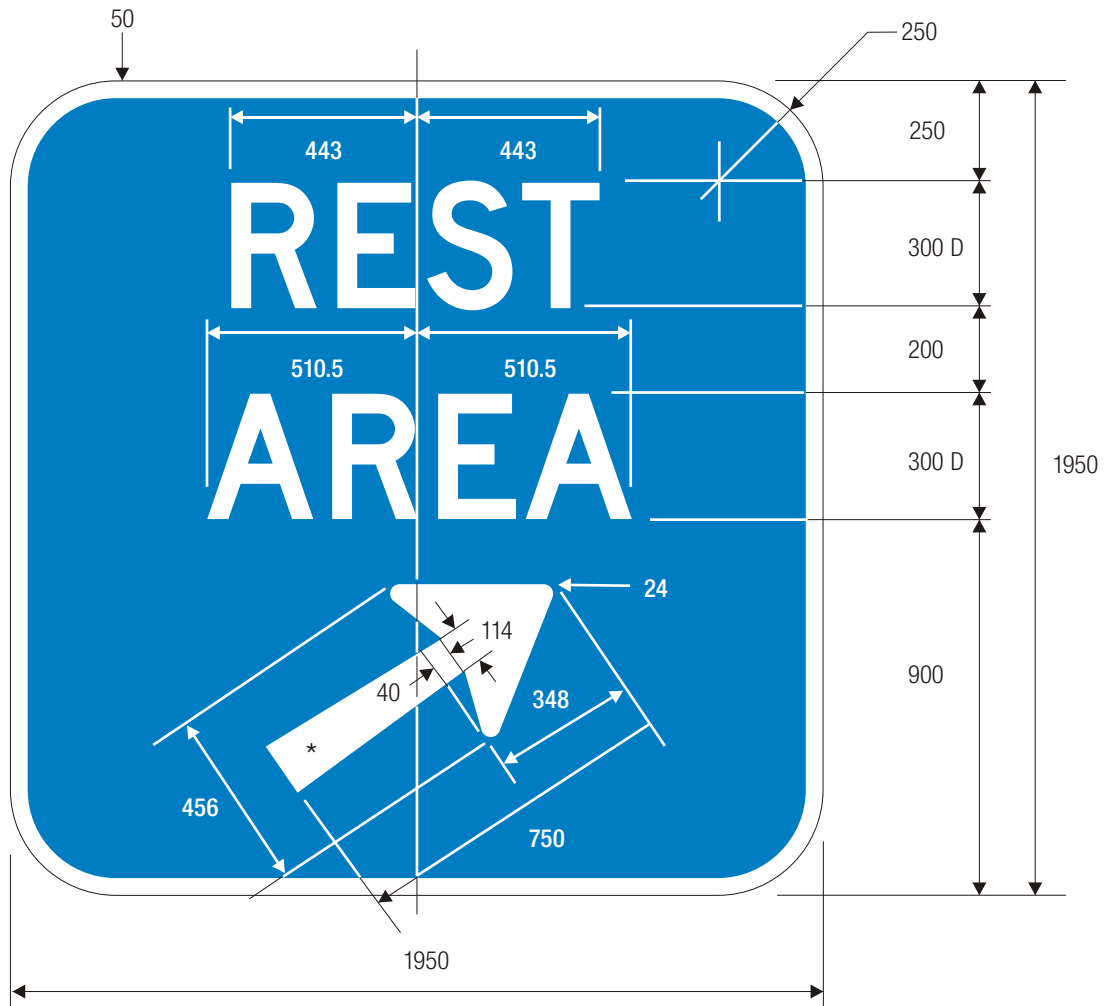

D5-2b
REST AREA GORE SIGN

*Optically center arrow
(see page 6-3 for arrow design details)

COLORS: LEGEND — WHITE (RETROREFLECTIVE)
BACKGROUND — BLUE (RETROREFLECTIVE)

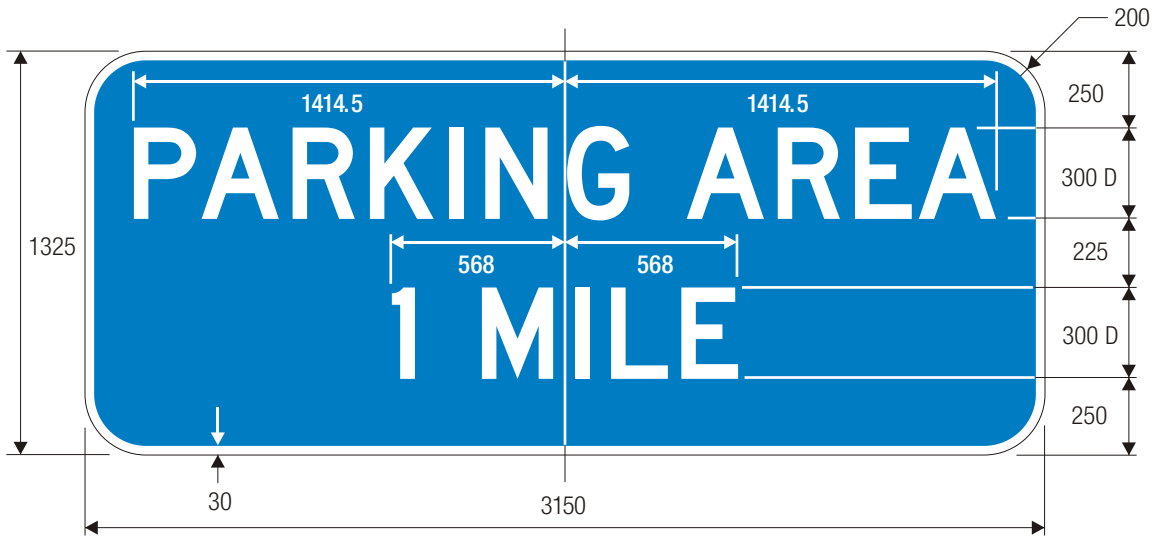

D5-3

ADVANCE PARKING AREA DISTANCE

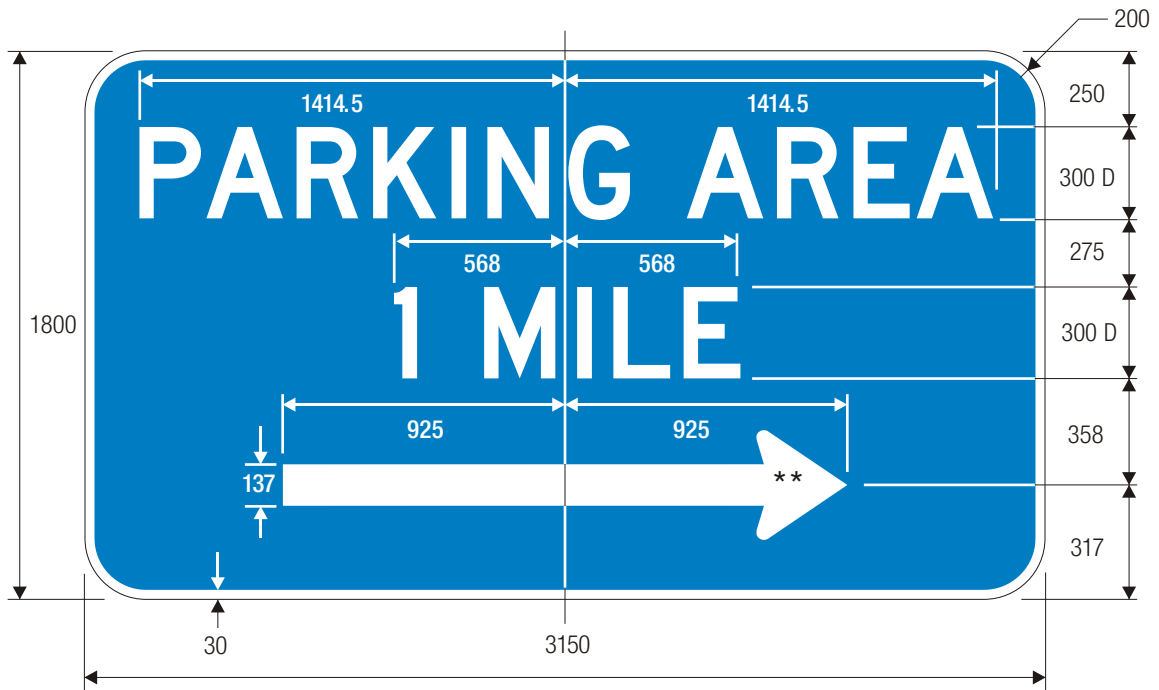

D5-3c

PARKING AREA ARROW & DISTANCE

**See page 6-2 for arrow design.

COLORS: LEGEND & ARROW – WHITE (RETROREFLECTIVE)
 BACKGROUND – BLUE (RETROREFLECTIVE)

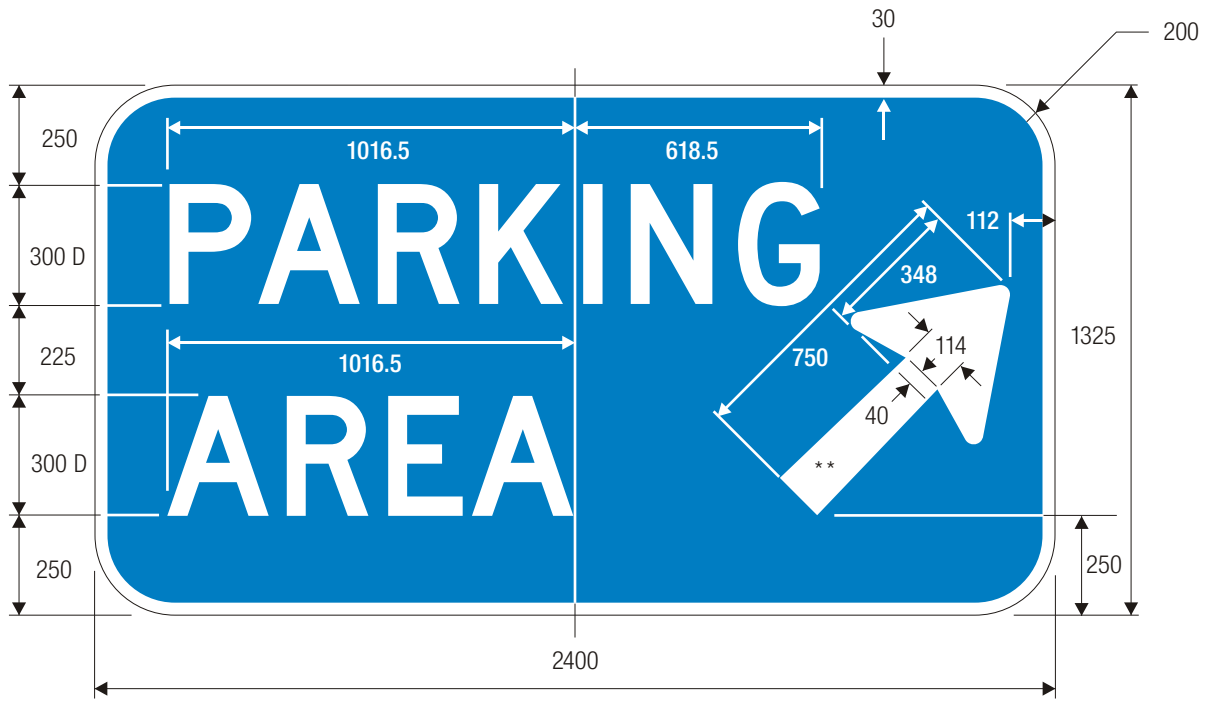

D5-4

PARKING AREA EXIT DIRECTION

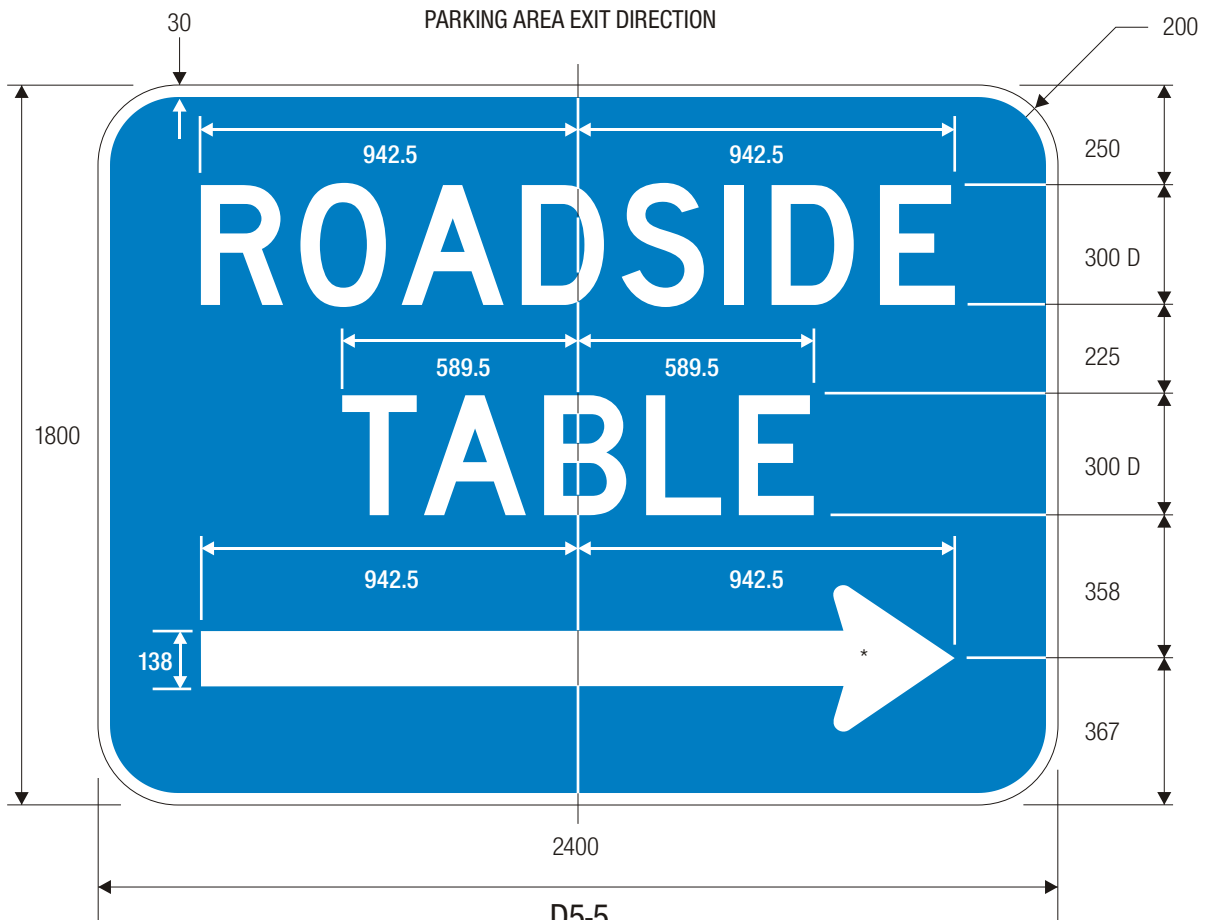

D5-5

ROADSIDE TABLE ARROW

*See page 6-2 for arrow design.
 **See page 6-3 for arrow design.

COLORS: LEGEND & ARROW – WHITE (RETROREFLECTIVE)
 BACKGROUND – BLUE (RETROREFLECTIVE)

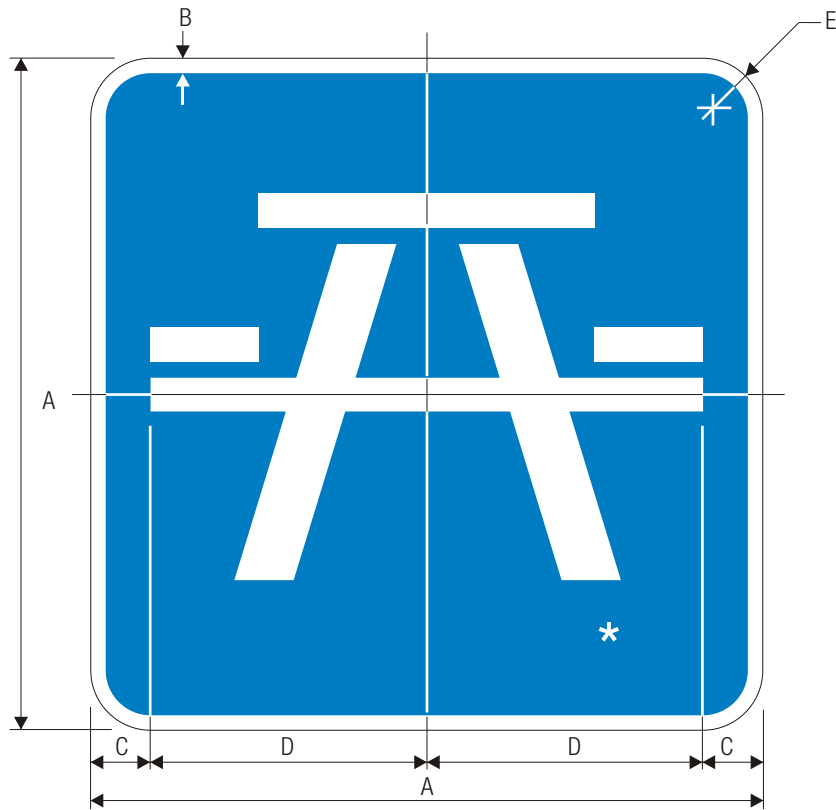

D5-5a

ROADSIDE TABLE SYMBOL

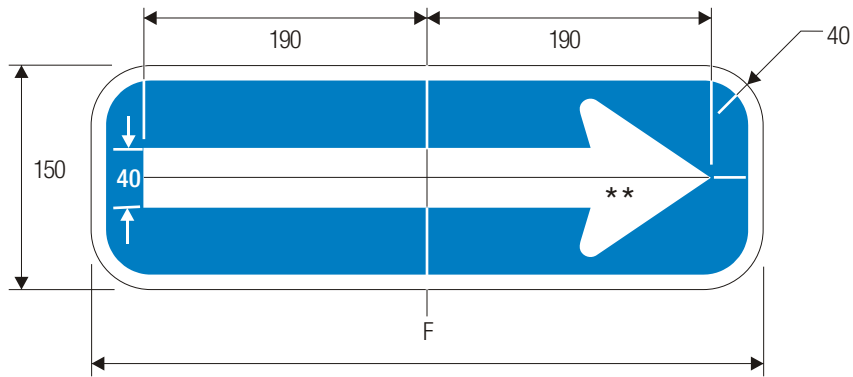

*See page 6-43 for symbol design.

**See page 6-2 for arrow design.

A	B	C	D	E	F
450	10	40	185	40	450
600	15	53	247	50	600
750	20	66	309	50	750

COLORS: SYMBOL WHITE (RETROREFLECTIVE)
 BACKGROUND BLUE (RETROREFLECTIVE)

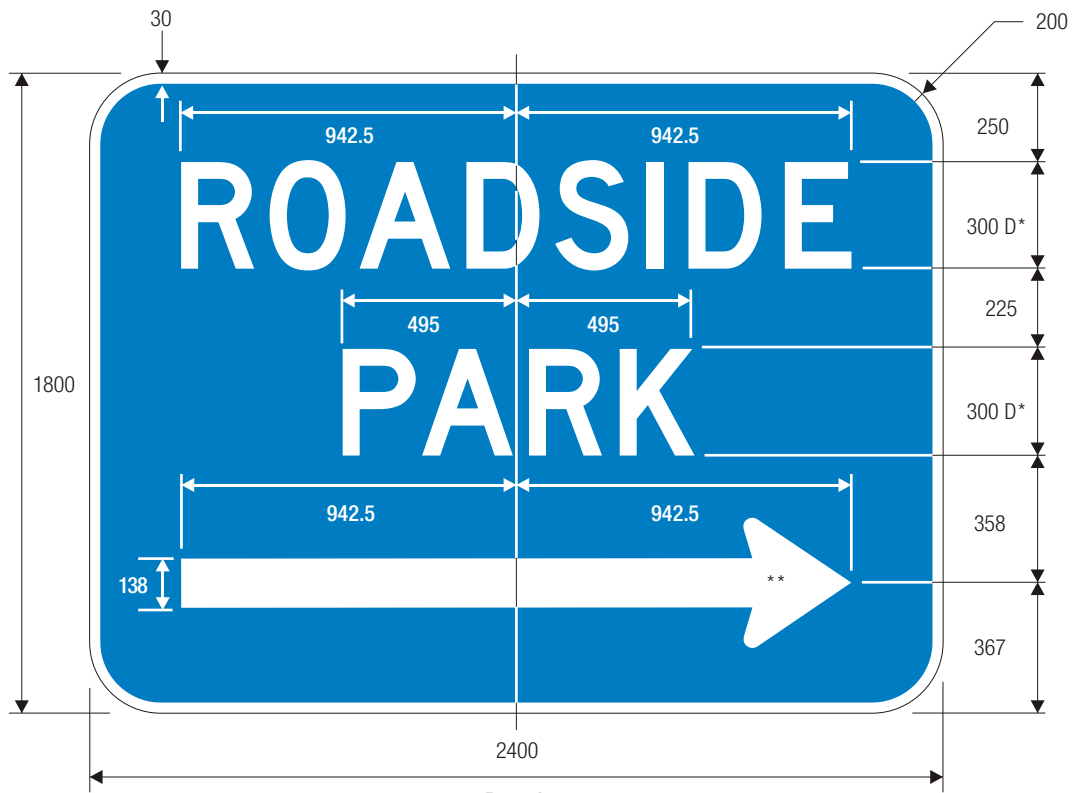

D5-5b
ROADSIDE PARK ARROW

*Series 2000 Standard Alphabets.
**See page 6-2 for symbol design.

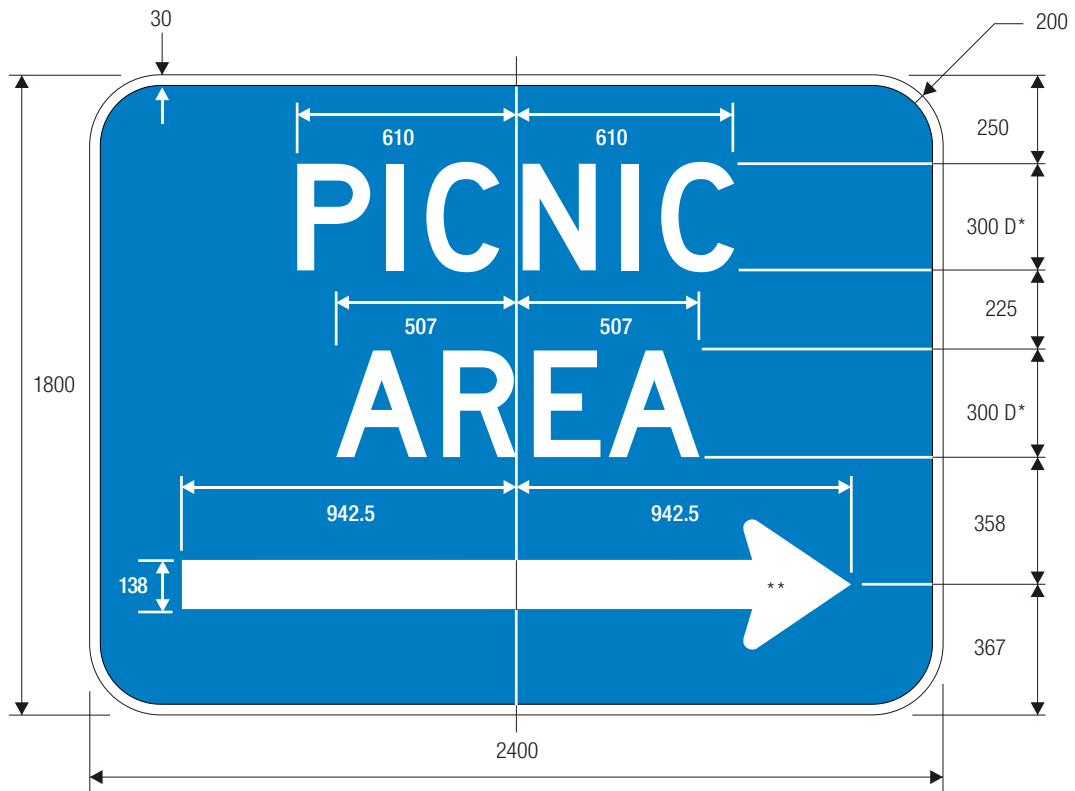

D5-5c
PICNIC AREA

COLORS: LEGEND & ARROW – WHITE (RETROREFLECTIVE)
BACKGROUND – BLUE (RETROREFLECTIVE)

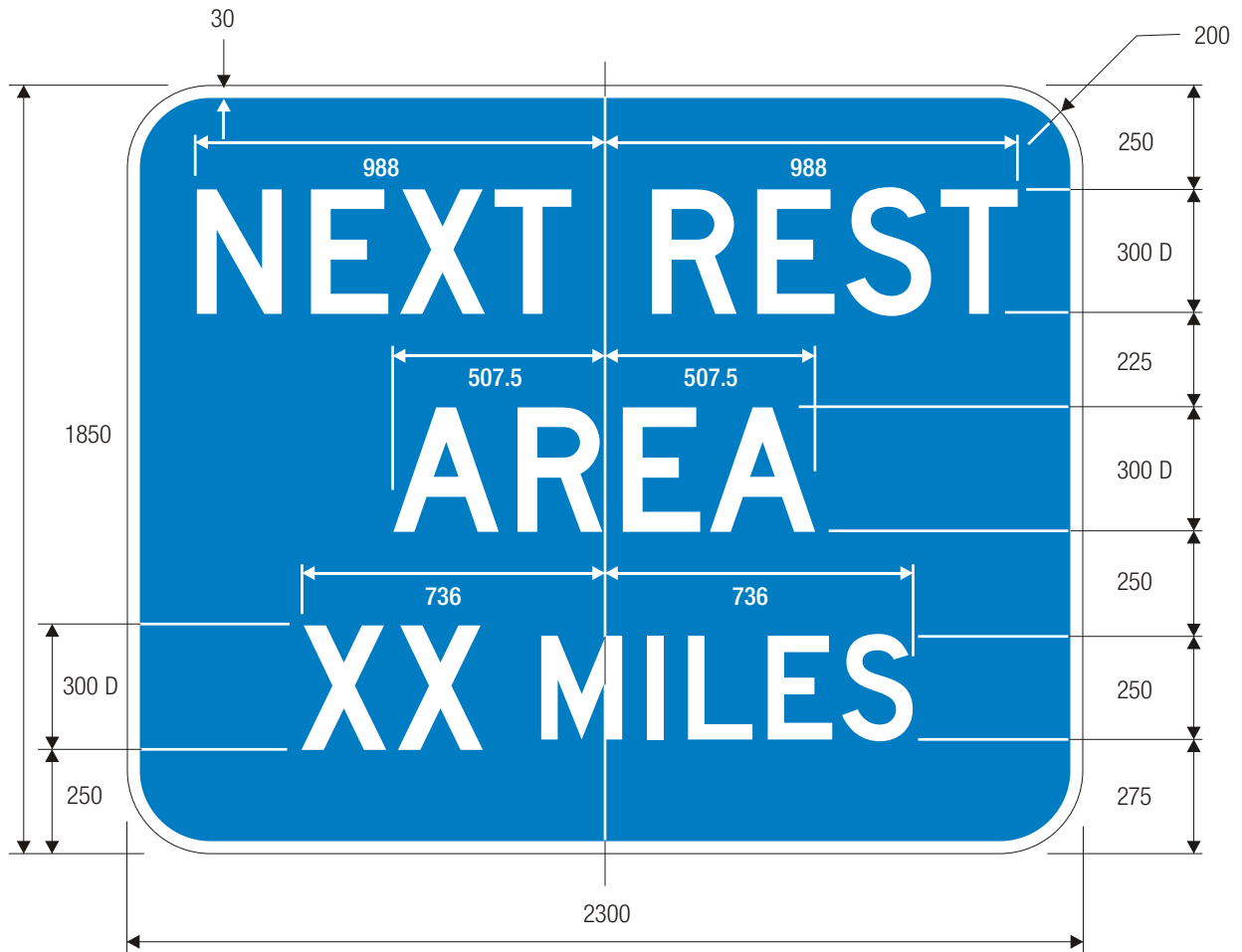

D5-6

NEXT REST AREA (XX MILES)

COLORS: LEGEND & ARROW – WHITE (RETROREFLECTIVE)
 BACKGROUND – BLUE (RETROREFLECTIVE)



*OPTICALLY CENTER OTHER DISTANCES

D5-7

ADVANCE REST AREA
TOURIST INFORMATION CENTER SIGN

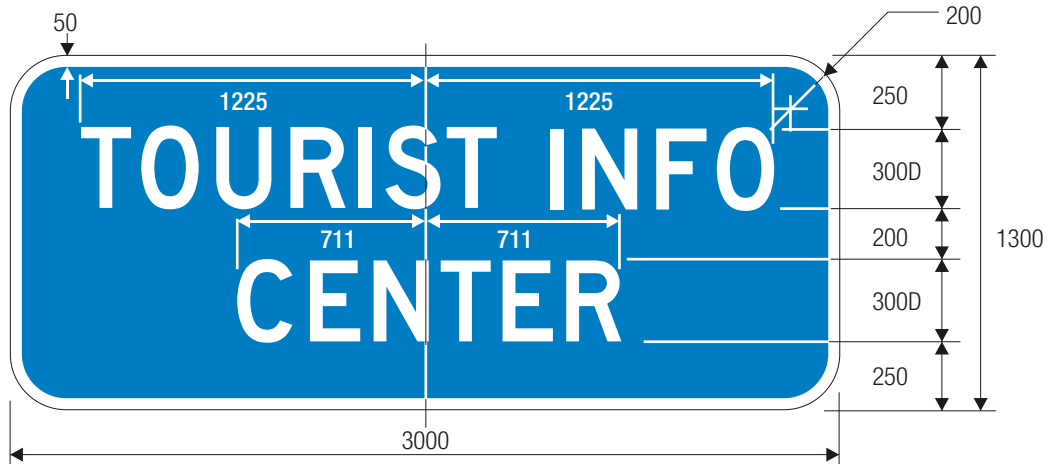

D5-7a

COLORS: LEGEND — WHITE (RETROREFLECTIVE)
BACKGROUND— BLUE (RETROREFLECTIVE)

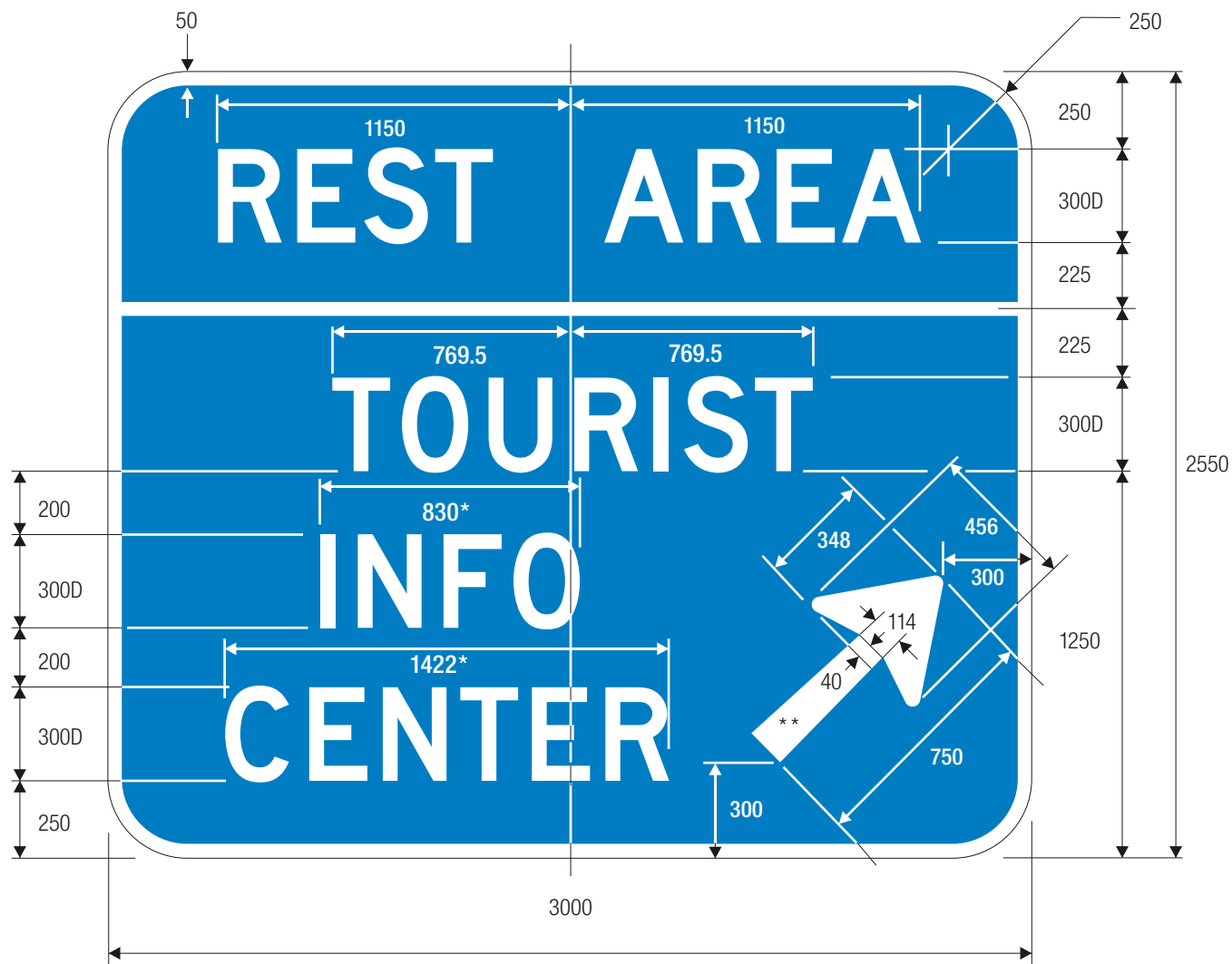

D5-8

COMBINATION REST AREA
TOURIST INFO CENTER
EXIT DIRECTION

*Optically center legend
**See page 6-3 for arrow design details

COLORS: LEGEND — WHITE (RETROREFLECTIVE)
BACKGROUND — BLUE (RETROREFLECTIVE)

Advance Rest-Welcome Sign



D5-9

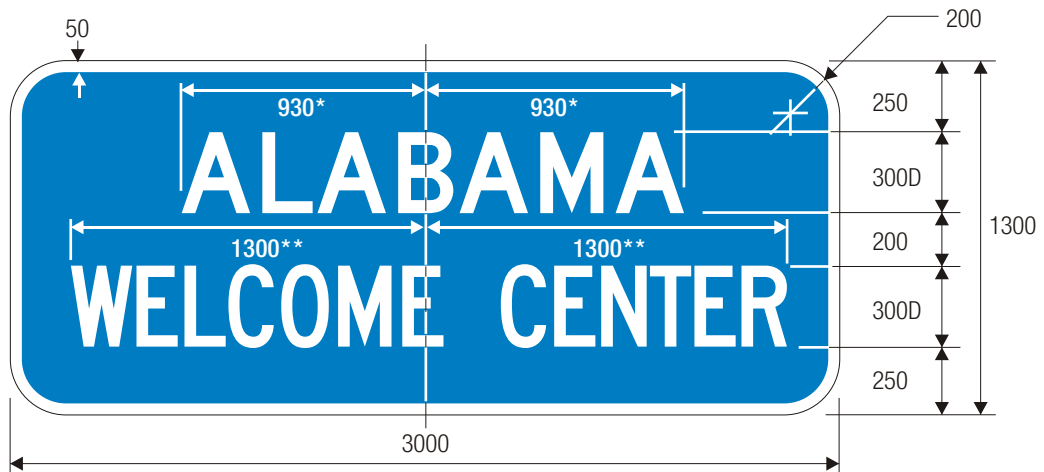

D5-9a

*Optically center other State names

**Reduce spacing to fit

COLORS: LEGEND — WHITE (RETROREFLECTIVE)
 BACKGROUND— BLUE (RETROREFLECTIVE)

EXIT DIRECTION REST
AREA-WELCOME CENTER SIGN



D5-10

COMBINATION REST AREA
STATE WELCOME CENTER
EXIT DIRECTION

*Optically center legend
**See page 6-3 for arrow design details

COLORS: LEGEND — WHITE (RETROREFLECTIVE)
BACKGROUND— BLUE (RETROREFLECTIVE)

EXIT DIRECTION REST AREA-WELCOME
CENTER SIGN (ALTERNATE)

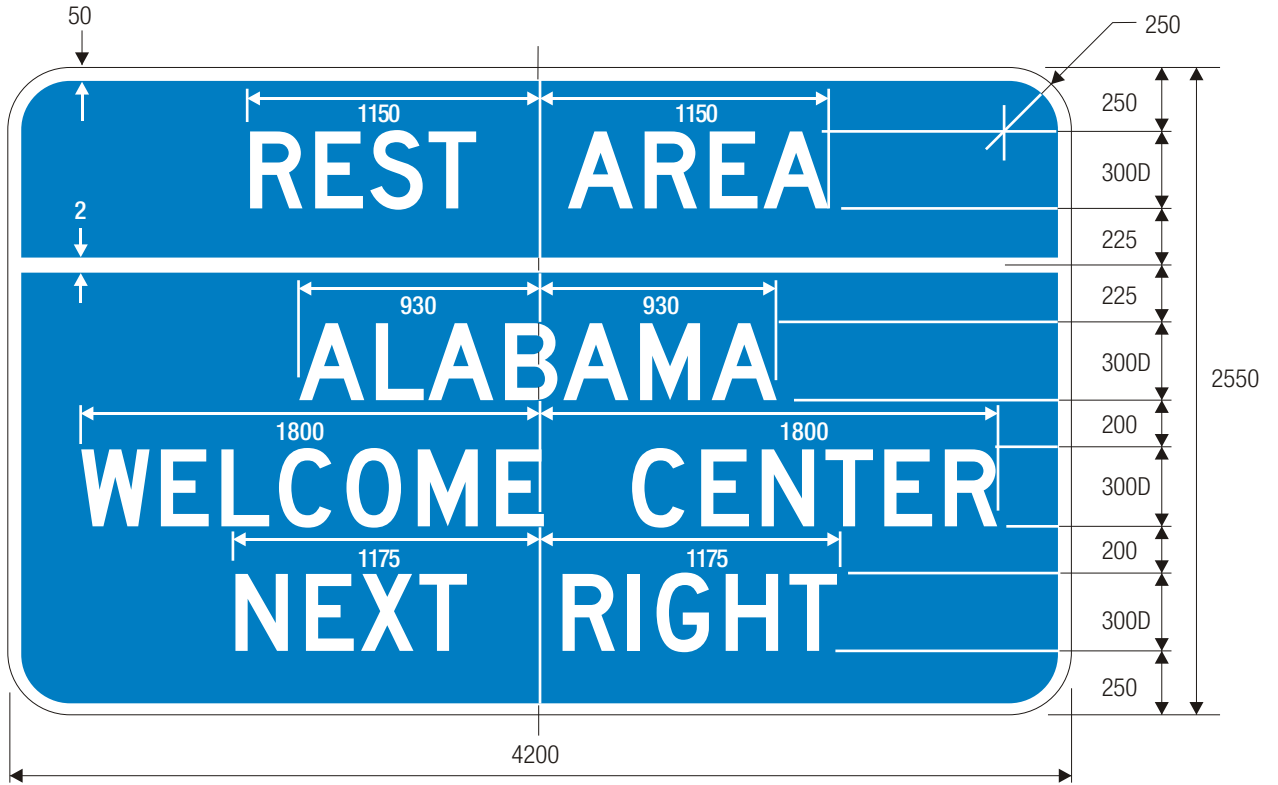

D5-11

COMBINATION REST AREA
STATE WELCOME CENTER
NEXT RIGHT

*Optically center other State names

COLORS: LEGEND — WHITE (RETROREFLECTIVE)
BACKGROUND— BLUE (RETROREFLECTIVE)

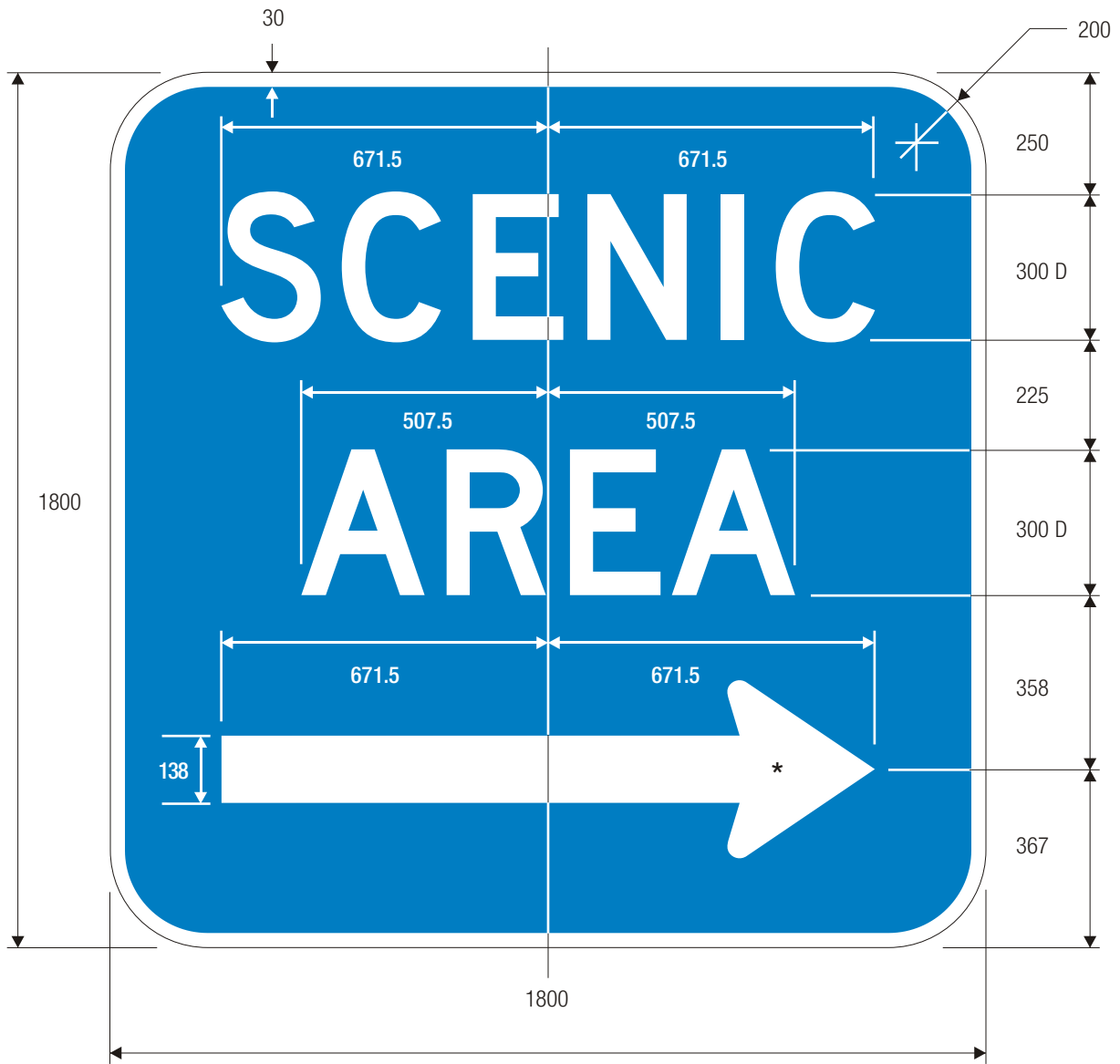

D6-1

SCENIC AREA ARROW

Option: The D6-1 thru D6-3 signs may have text "AREA", "VIEW" or "OVERLOOK".

*See page 6-2 for symbol design.

For SCENIC OVERLOOK use 84" width.

COLORS: LEGEND & ARROW – WHITE (RETROREFLECTIVE)
 BACKGROUND – BLUE (RETROREFLECTIVE)



D6-2

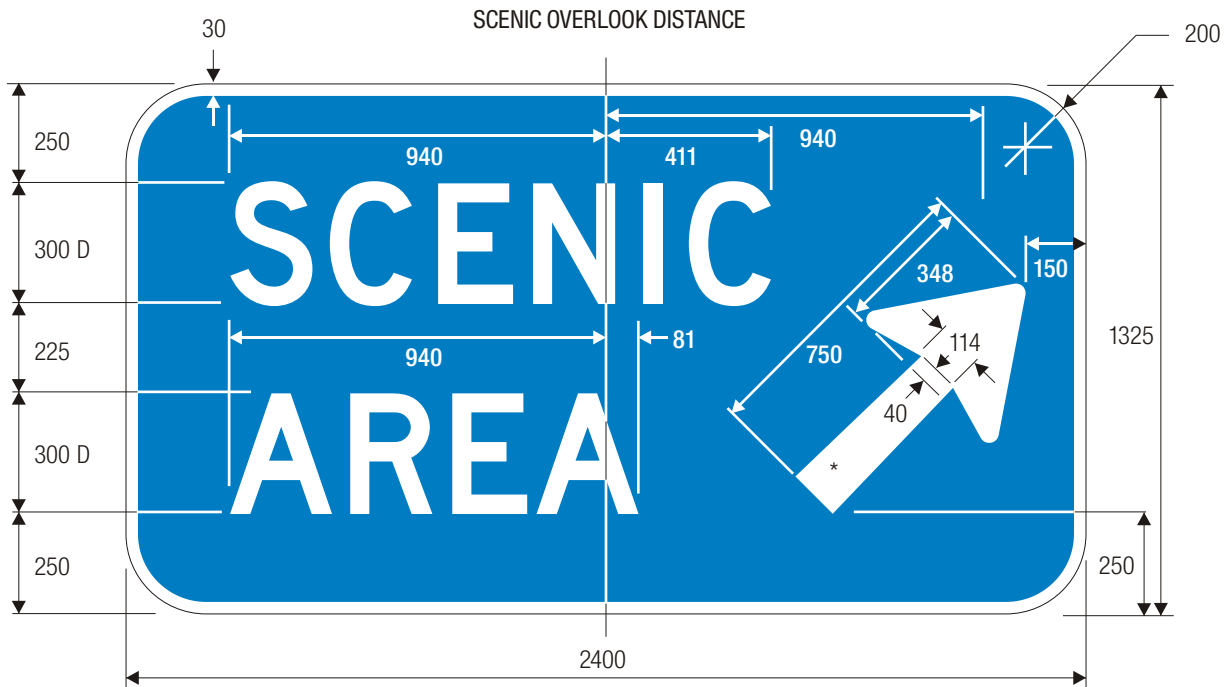

D6-3

SCENIC OVERLOOK DISTANCE

SCENIC AREA EXIT DIRECTION

Option: The D6-1 thru D6-3 signs may have text "AREA", "VIEW" or "OVERLOOK".

*See page 6-3 for symbol design.

COLORS: LEGEND & ARROW – WHITE (RETROREFLECTIVE)
 BACKGROUND – BLUE (RETROREFLECTIVE)

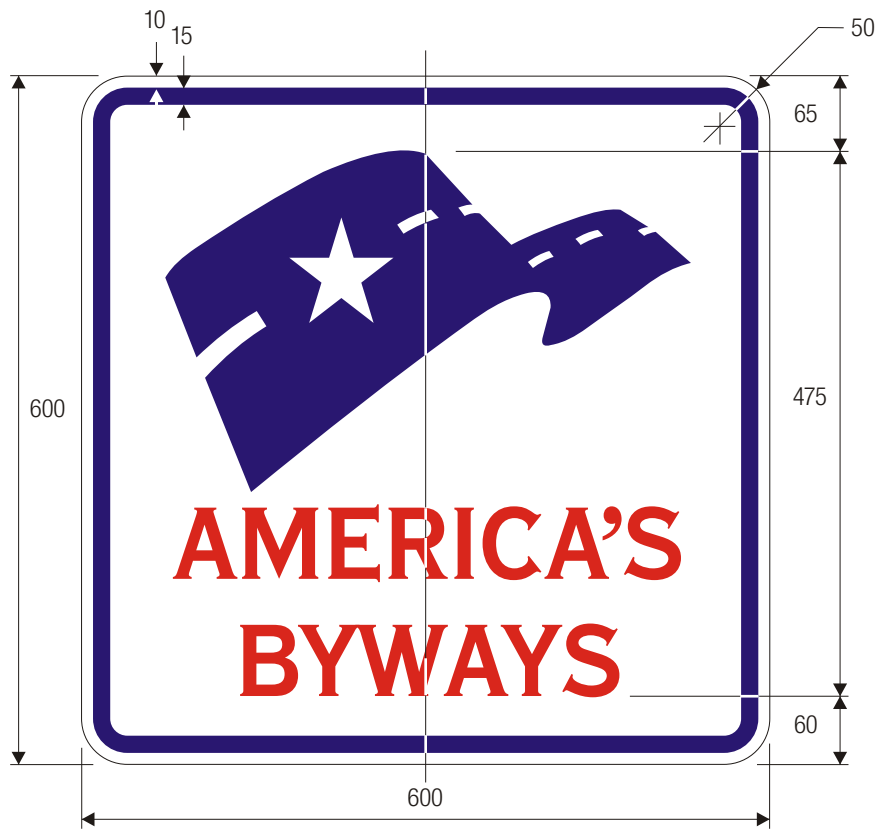

D6-4

NATIONAL SCENIC BYWAYS

*See page 6-61 for symbol design.

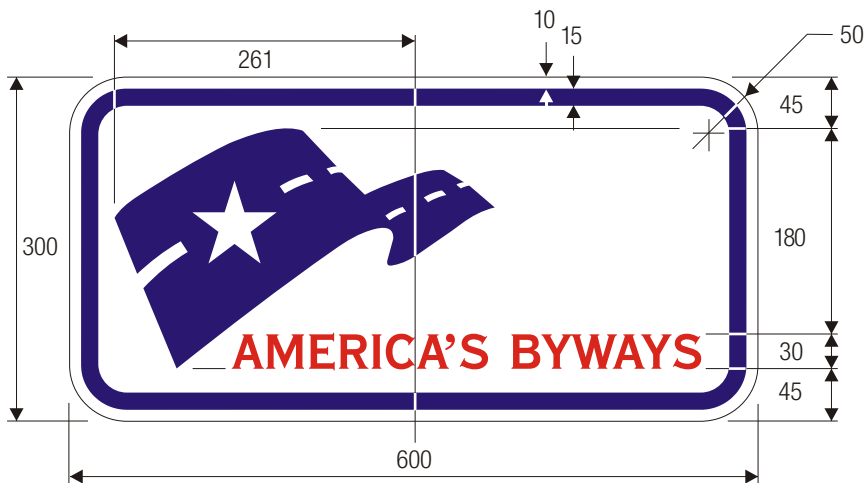

D6-4a

NATIONAL SCENIC BYWAYS

COLORS:	SYMBOL	BLUE & WHITE (RETROREFLECTIVE)
	LEGEND	RED (RETROREFLECTIVE)
	BACKGROUND	WHITE (RETROREFLECTIVE)

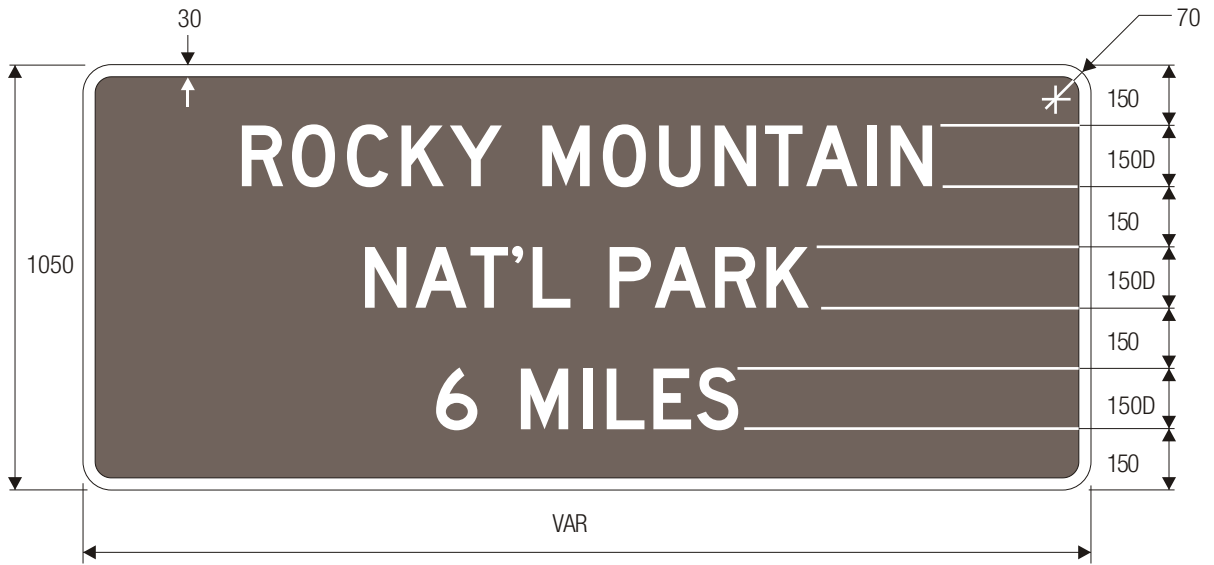

D7-1

NATIONAL PARK



D7-2

NATIONAL PARK ARROW

*See page 6-2 for arrow design.

COLORS: LEGEND —WHITE (RETROREFLECTIVE)
 BACKGROUND —BROWN

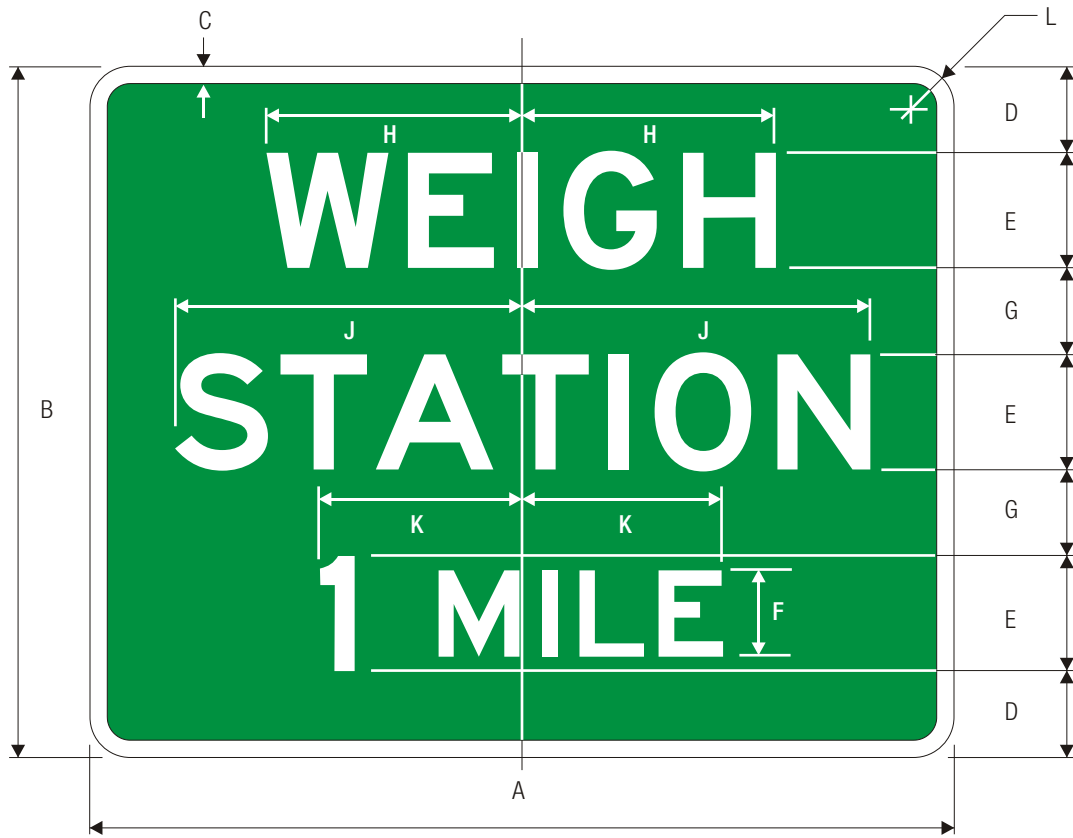

D8-1

ADVANCE WEIGH STATION DISTANCE

A	B	C	D	E	F	G	H	J	K	L
1500	1200	30	150	200 E	150 E	150	442	603.5	350	70
1950	1500	30	200	250 E	200 E	175	553	754.5	444.5	70
2400	1800	40	225	300 E	250 E	225	801	905.5	562.5	70

COLORS: LEGEND -WHITE (RETROREFLECTIVE)
 BACKGROUND -GREEN (RETROREFLECTIVE)

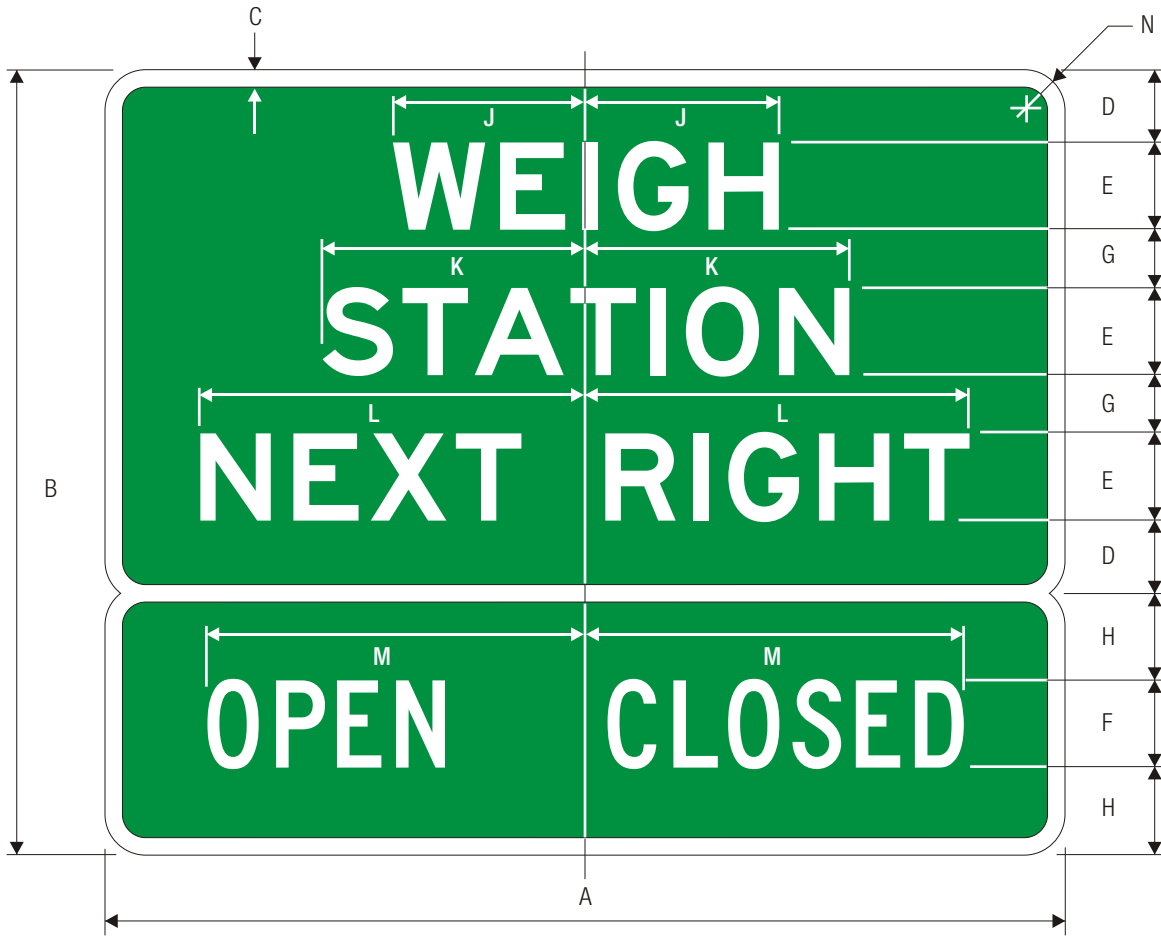

D8-2

WEIGH STATION NEXT RIGHT
(OPEN) (CLOSED)

A	B	C	D	E	F	G	H	J	K	L	M	N
1650	1350	30	125	150 E	150 C	100	150	331.5	452.5	661	650	70
2100	1800	30	150	200 E	200 C	150	200	442	603.5	900	875	70
2700	2250	30	200	250 E	250 C	175	250	552.5	754.5	1125	1100	70

COLORS: LEGEND —WHITE (RETROREFLECTIVE)
BACKGROUND —GREEN (RETROREFLECTIVE)



D8-3

WEIGH STATION EXIT DIRECTION

*See page 6-3 for arrow design.

A	B	C	D	E	F	G	H	J	K	L	M
1200	1050	30	100	150 E	350	331.5	452.5	175	300	229	70
1650	1500	30	150	200 E	500	534	603.5	249	427	325	70
2100	1950	30	200	250 E	650	552.5	754.5	324	555	423	70

COLORS: LEGEND -WHITE (RETROREFLECTIVE)
BACKGROUND -GREEN (RETROREFLECTIVE)

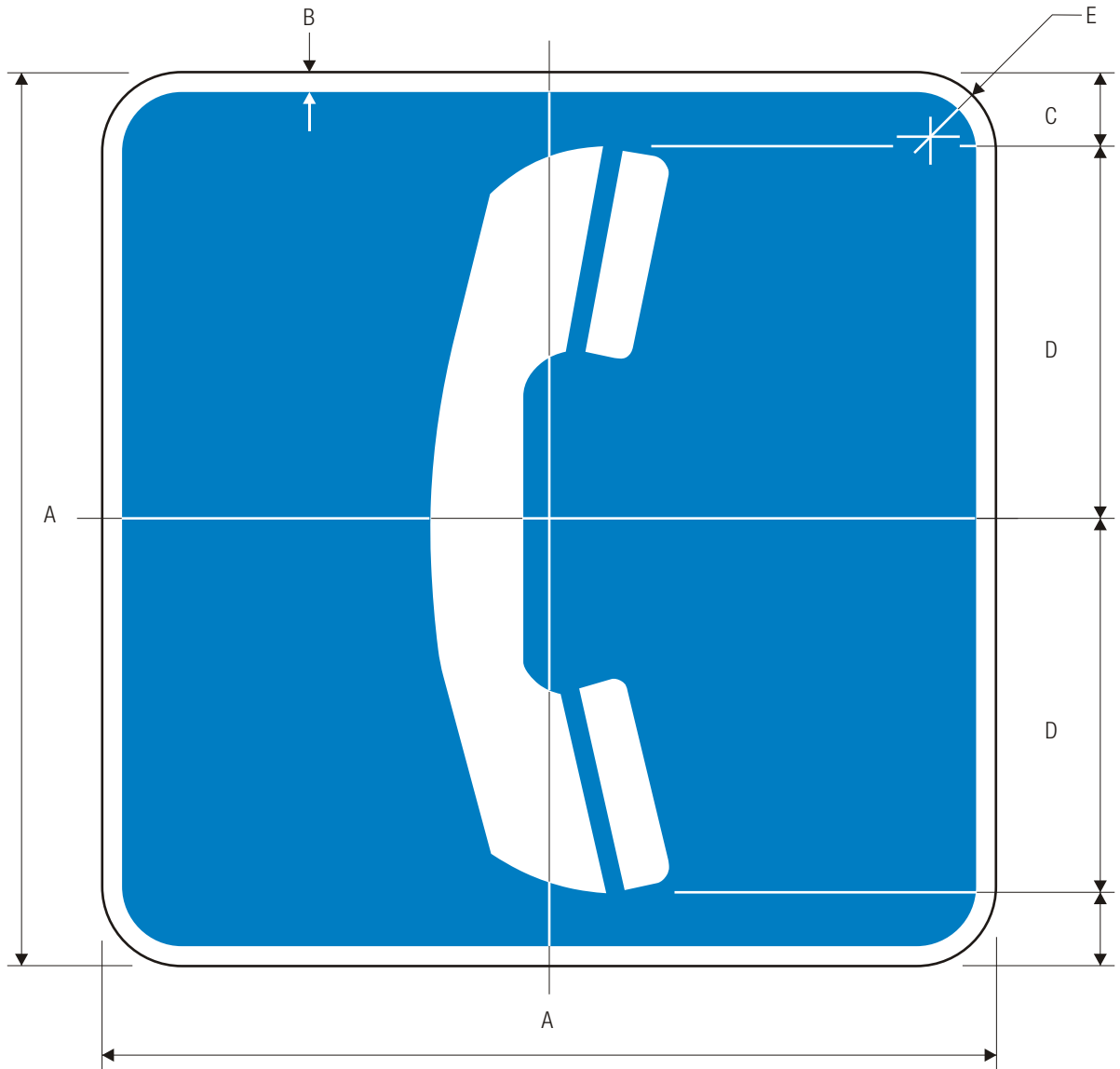

D9-1
TELEPHONE

*See page 6-44 for symbol design.

A	B	C	D	E
450	10	37	376	40
600	15	49	250	50
750	20	61	314	50

COLORS: SYMBOL WHITE (RETROREFLECTIVE)
BACKGROUND BLUE (RETROREFLECTIVE)

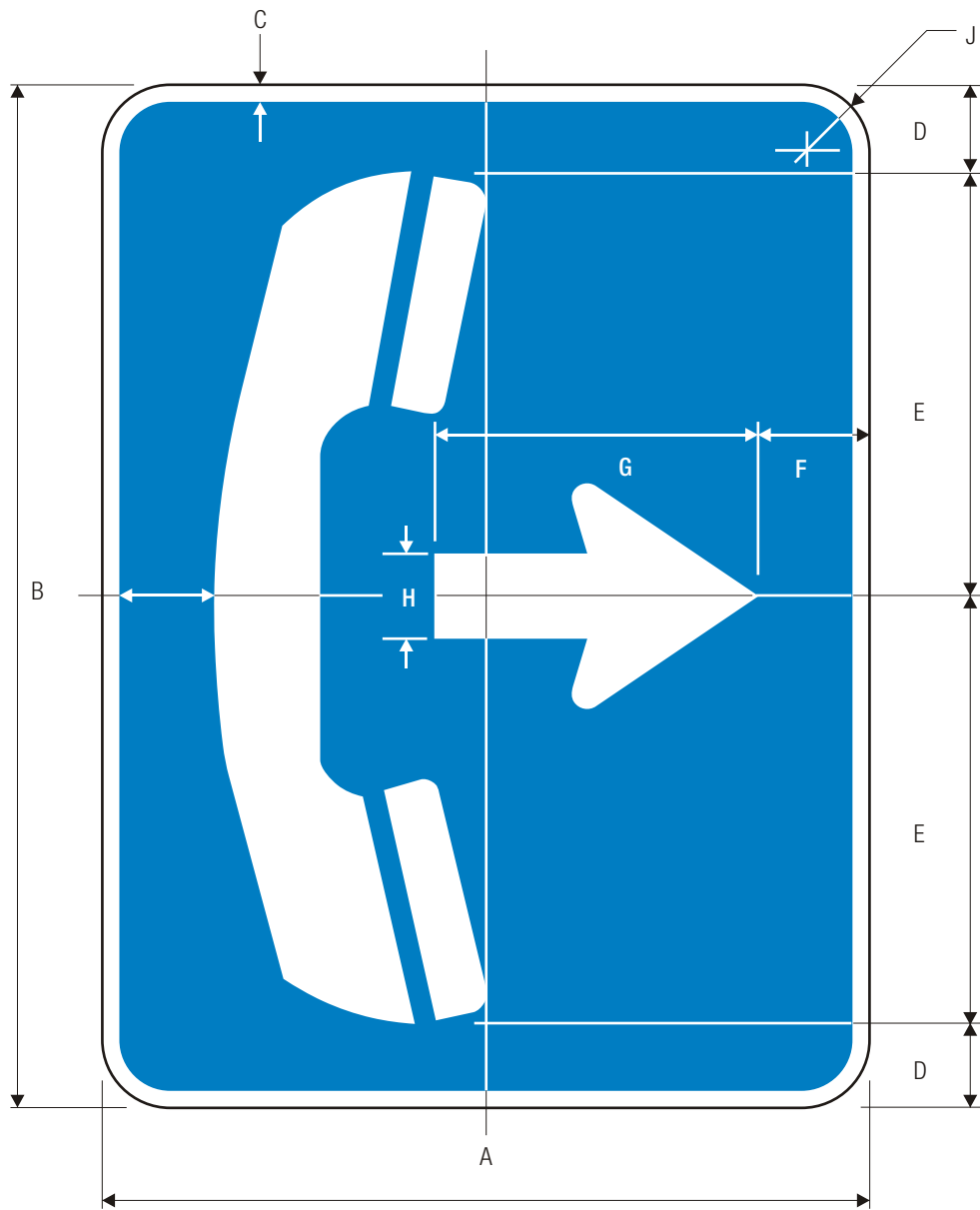

D9-1a

TELEPHONE

*See page 6-44 for symbol design.

**See page 6-2 for arrow design.

A	B	C	D	E	F	G	H	J
450	600	10	50	250	65	190	50	40
600	750	15	63	312	81	238	63	50
750	900	20	76	374	97	286	76	50

COLORS: SYMBOL WHITE (RETROREFLECTIVE)
 BACKGROUND BLUE (RETROREFLECTIVE)

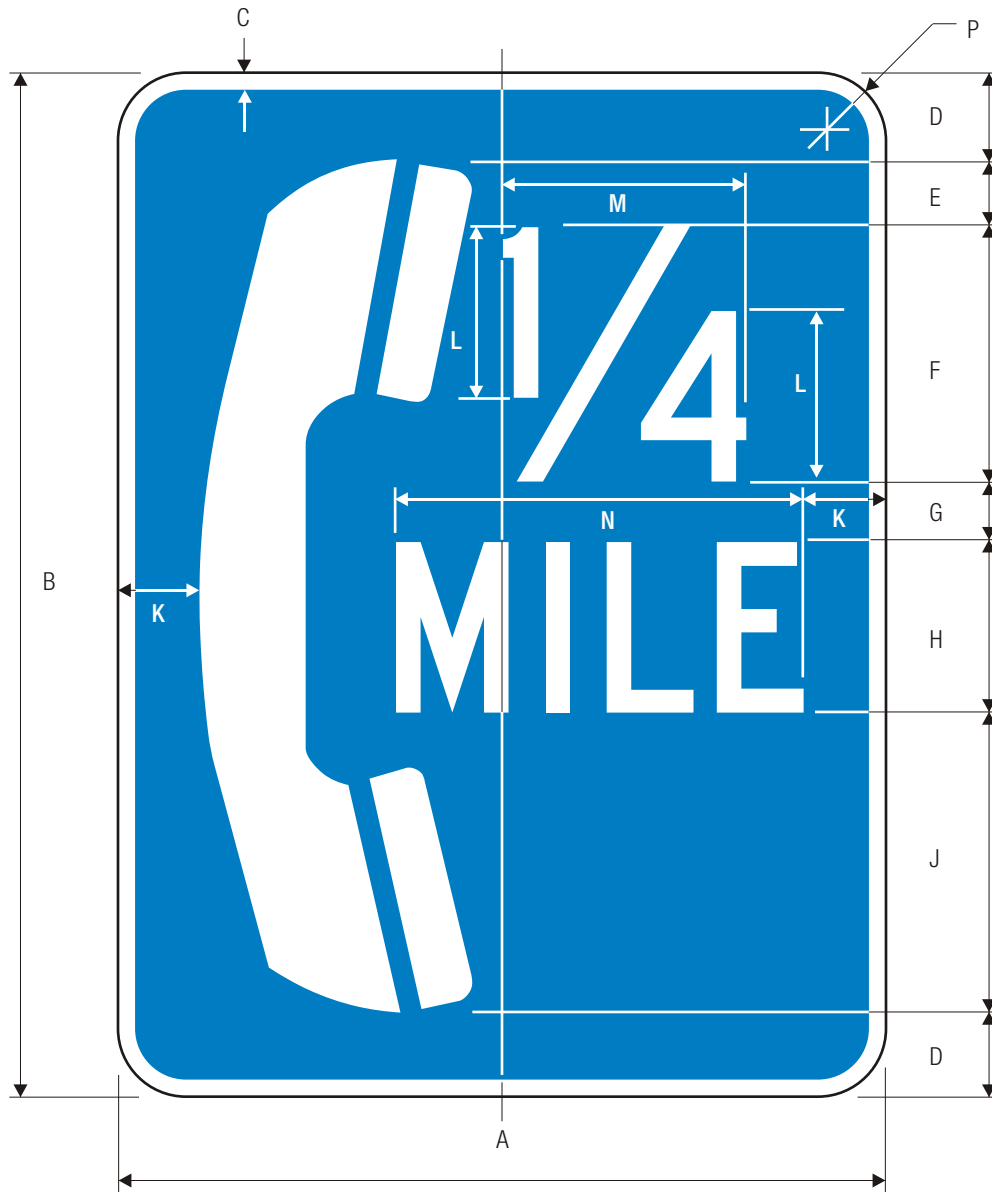

D9-1b

TELEPHONE

*See symbol on page 6-44

A	B	C	D	E	F	G	H	J	K	L	M
450	600	10	50	40	150	35	100 C	175	48	125 C	143
600	750	15	62	50	188	44	125 C	219	60	125 C	192
750	900	20	78	62	226	55	150 C	251	75	150 C	231

N	P
239	40
299	50
358	50

COLORS: LEGEND —WHITE (RETROREFLECTIVE)
 BACKGROUND —BLUE (RETROREFLECTIVE)
 SYMBOL —WHITE (RETROREFLECTIVE)

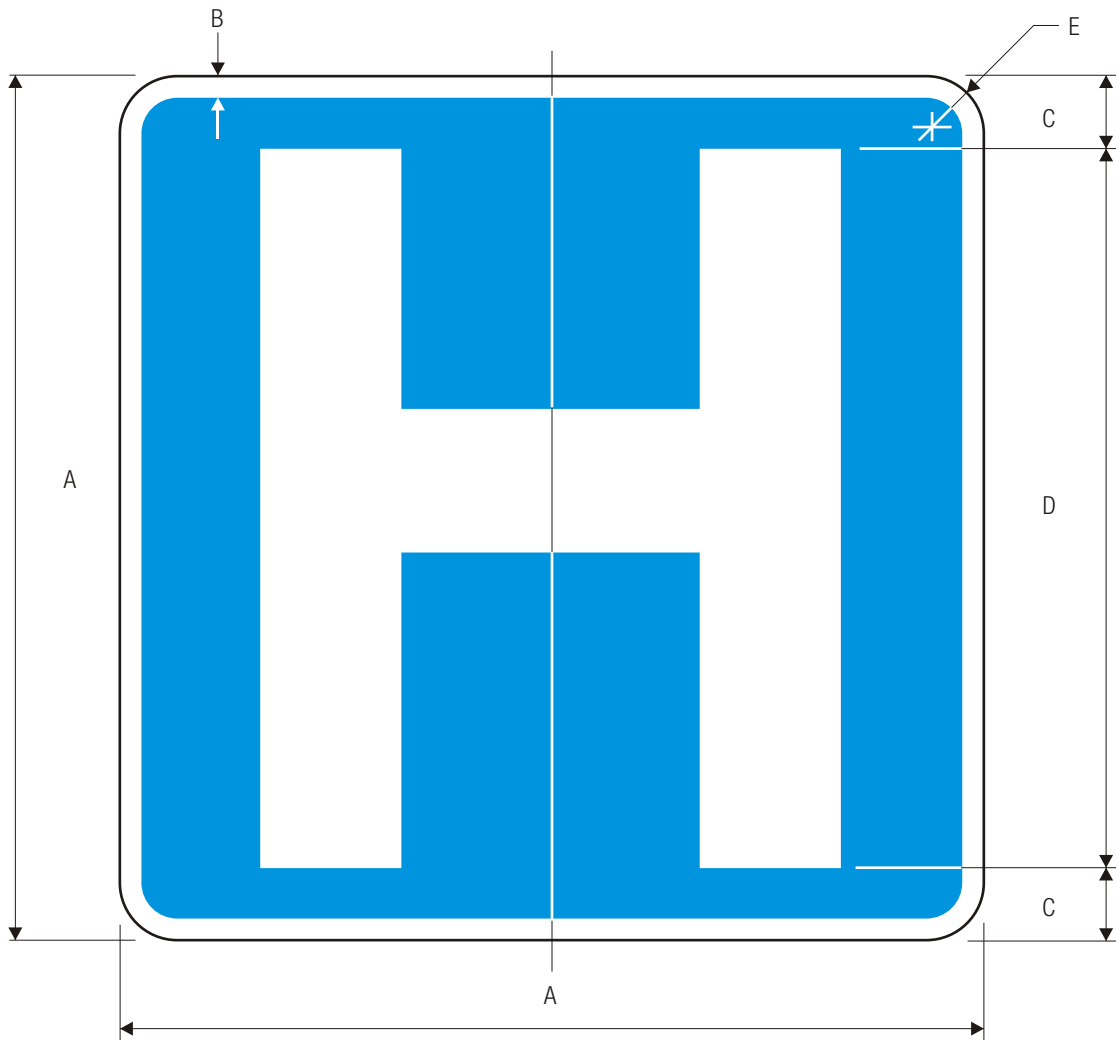

D9-2
HOSPITAL

A	B	C	D	E
450	10	37.5	375EM	40
600	15	50	500EM	50
750	20	62.5	625EM	50

COLORS: LEGEND —WHITE (RETROREFLECTIVE)
BACKGROUND —BLUE (RETROREFLECTIVE)

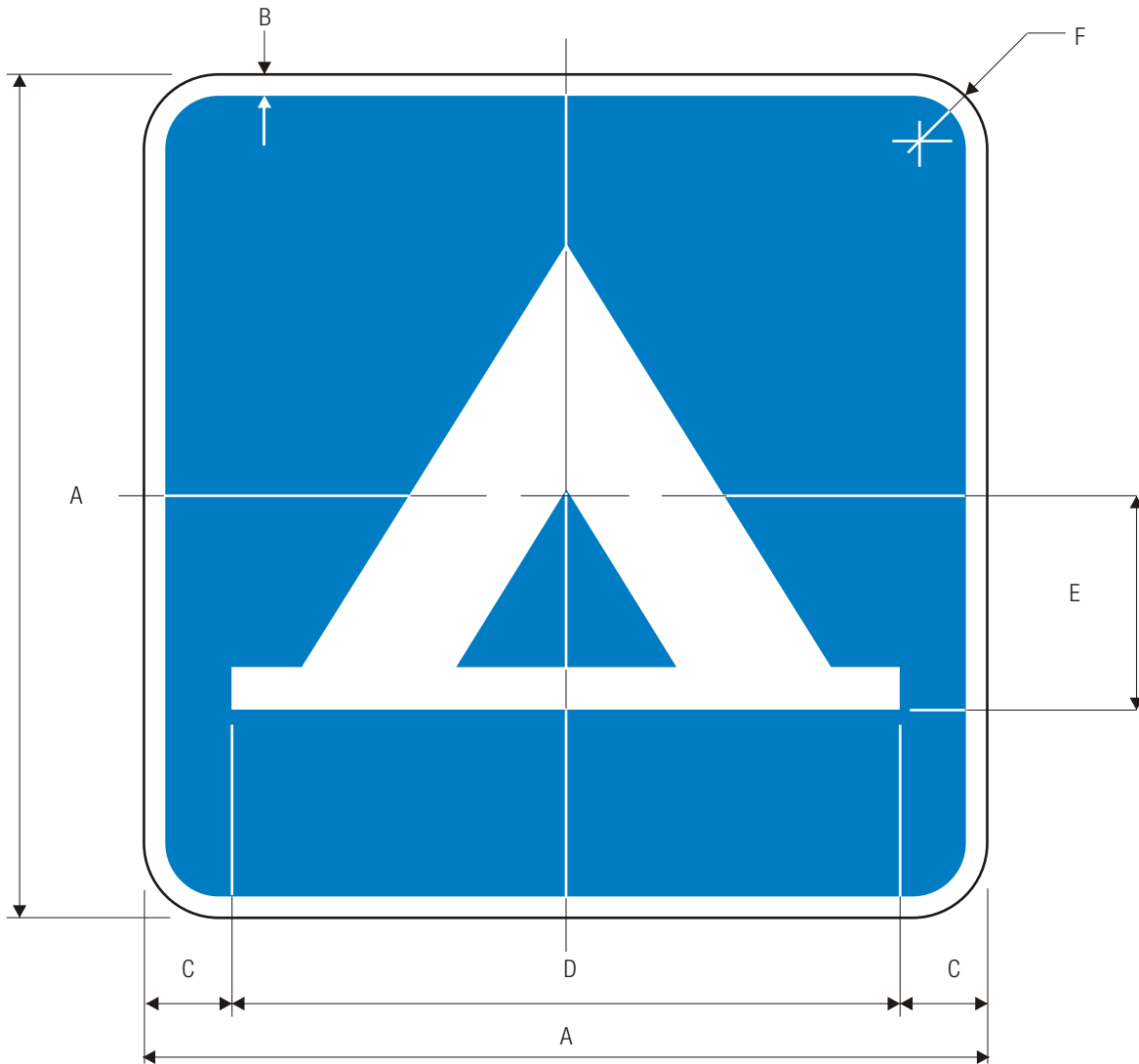

D9-3
CAMPING

*See page 6-45 for symbol design.

A	B	C	D	E	F
450	10	37	376	150	40
600	15	50	500	200	50
750	20	62	626	250	50

COLORS: SYMBOL WHITE (RETROREFLECTIVE)
BACKGROUND BLUE (RETROREFLECTIVE)

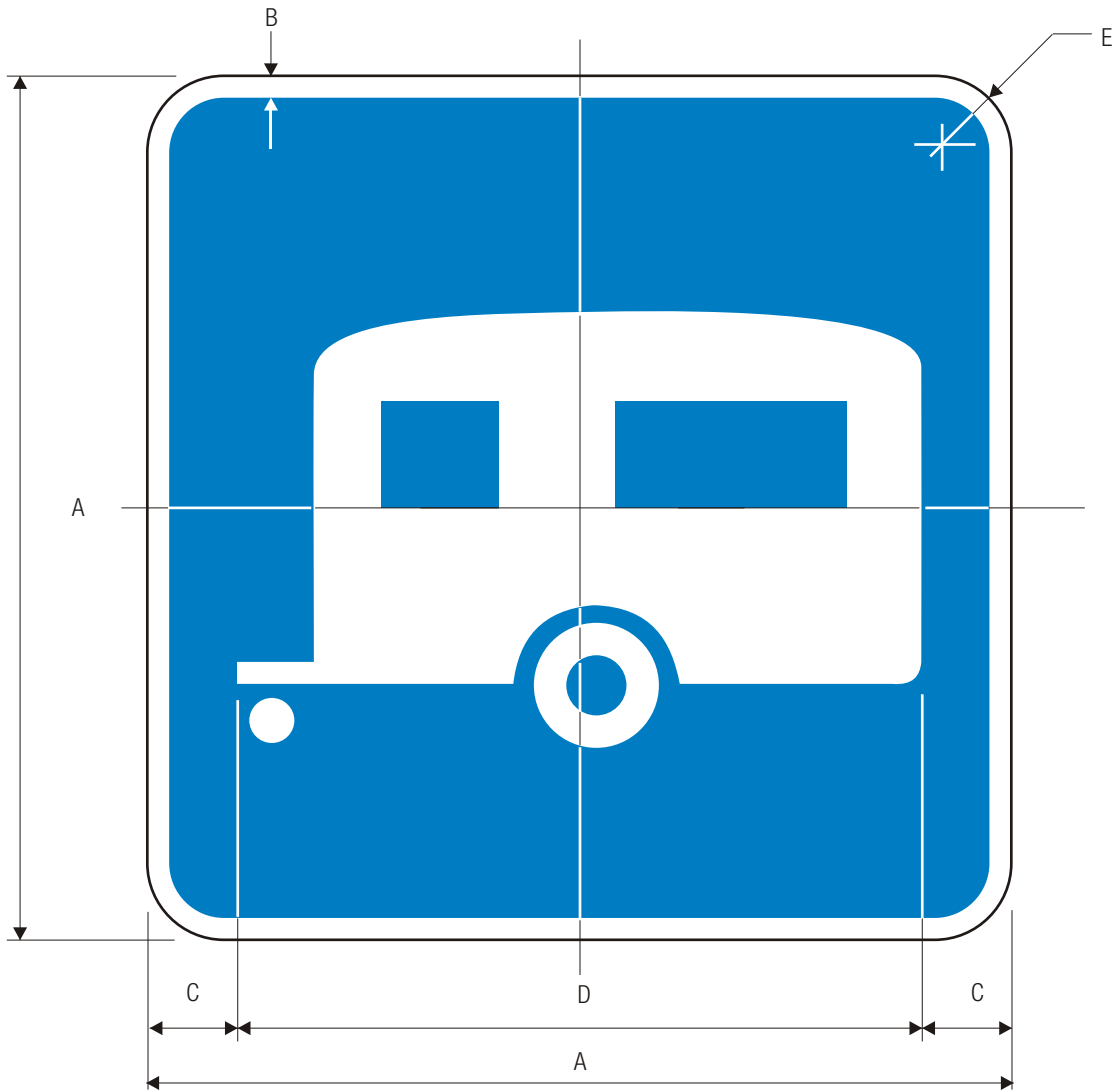

D9-3a

TRAILER CAMPING

*See page 6-46 for symbol design.

A	B	C	D	E
450	10	37	376	40
600	15	50	500	50
750	20	62	626	50

COLORS: SYMBOL WHITE (RETROREFLECTIVE)
 BACKGROUND BLUE (RETROREFLECTIVE)



D9-4

LITTER CONTAINER

*See page 6-15 for symbol design.

A	B	C	D	E	F
600	750	15	125	500	50
900	1200	25	200	800	60

COLORS: SYMBOL WHITE (RETROREFLECTIVE)
 BACKGROUND BLUE (RETROREFLECTIVE)



D9-6

HANDICAPPED ACCESSIBLE

*See page 6-31 for symbol design.

Smaller size panels may be used as applicable within terminal areas

A	B	C	D	E
450	10	37	376	40
600	15	50	500	50
750	20	62	626	50

COLORS: SYMBOL WHITE (RETROREFLECTIVE)
 BACKGROUND BLUE (RETROREFLECTIVE)

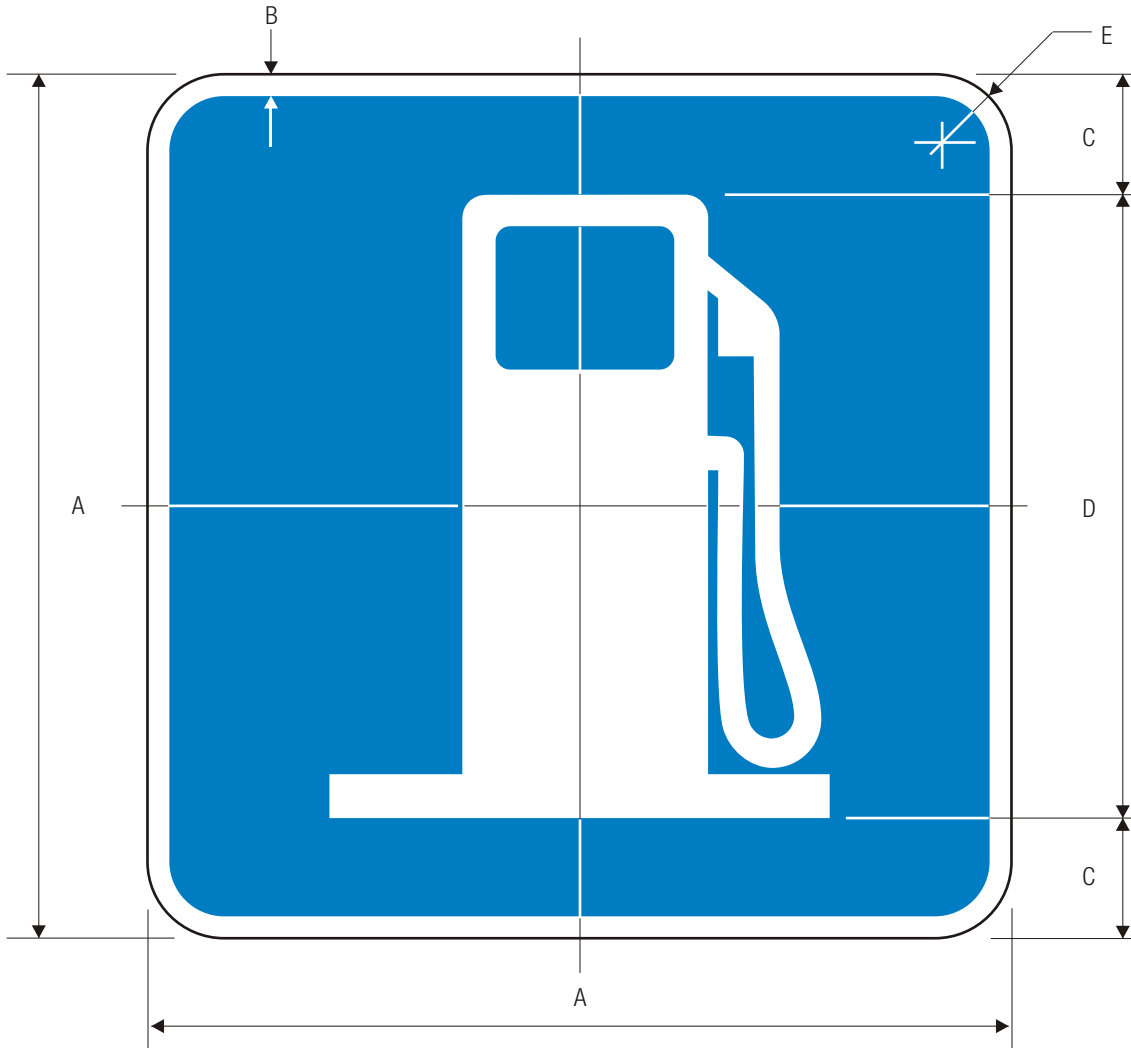

D9-7
GAS

*See page 6-12 for symbol design.

A	B	C	D	E
450	10	75	300	40
600	15	75	450	50
750	20	90	570	50

COLORS: SYMBOL WHITE (RETROREFLECTIVE)
BACKGROUND BLUE (RETROREFLECTIVE)

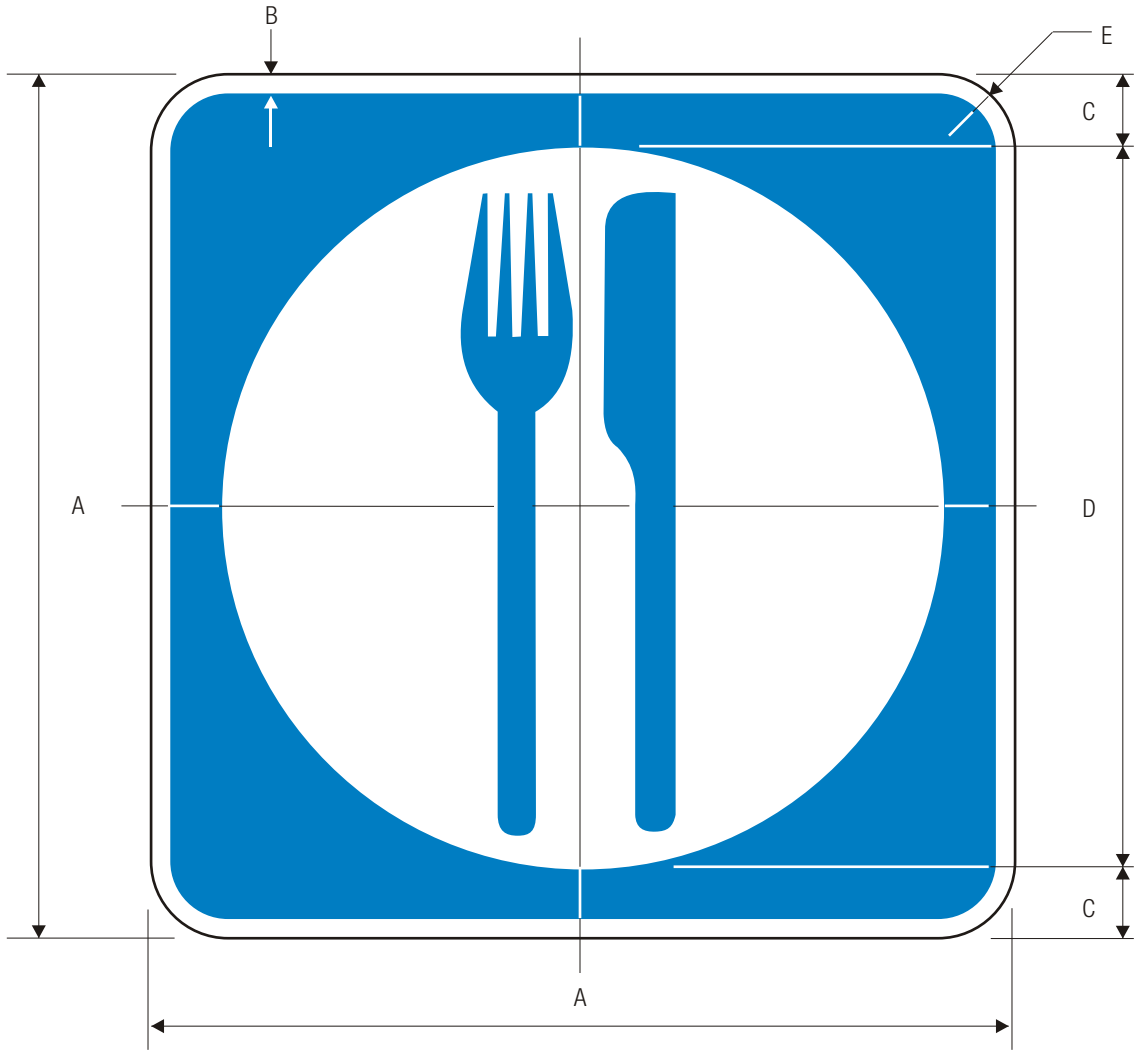

D9-8
FOOD

*See page 6-47 for symbol design.

A	B	C	D	E
450	10	37	376	40
600	15	50	500	50
750	20	62	626	50

COLORS: SYMBOL WHITE (RETROREFLECTIVE)
BACKGROUND BLUE (RETROREFLECTIVE)

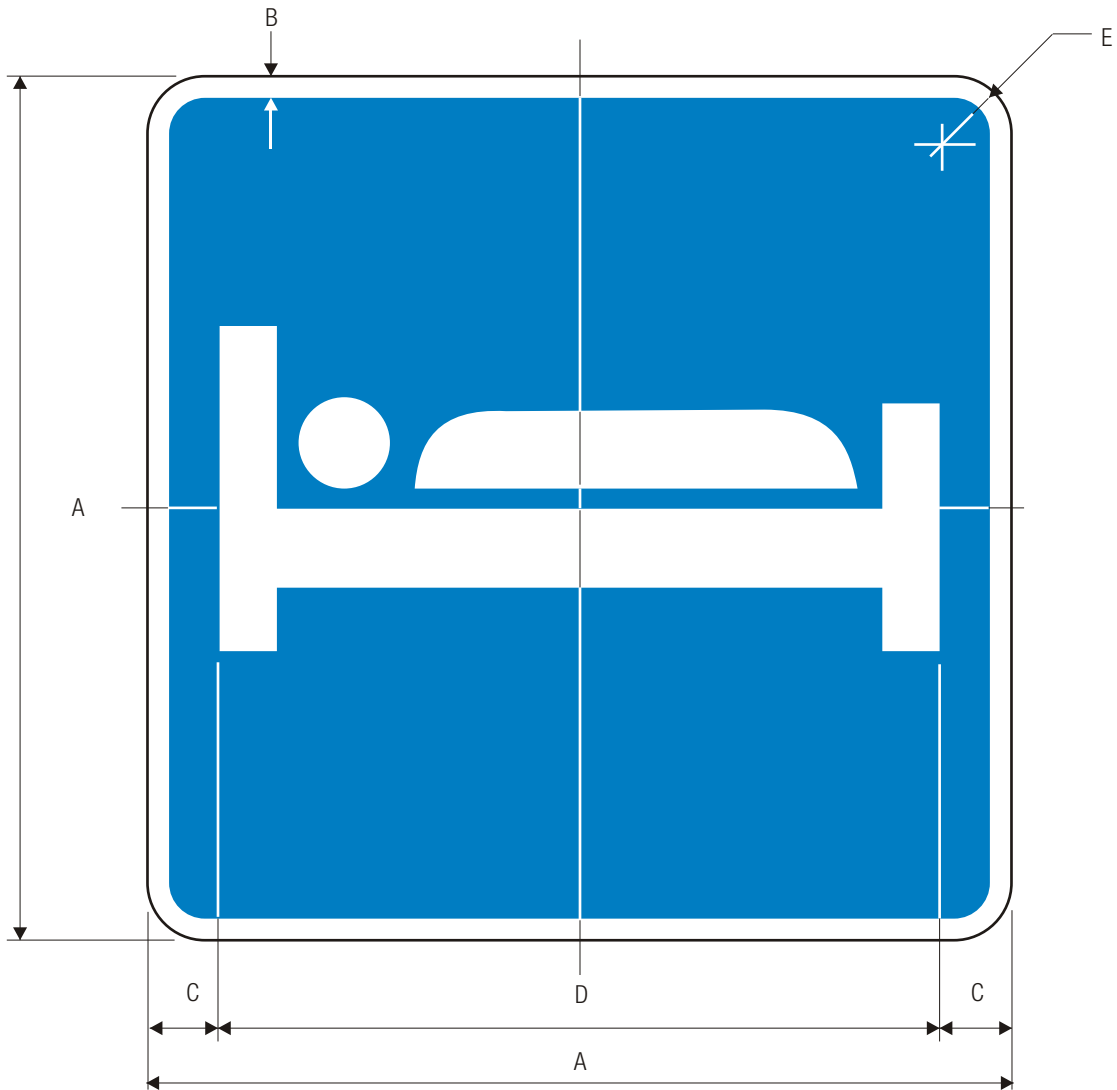

D9-9
LODGING

*See page 6-48 for symbol design.

A	B	C	D	E
450	10	37	376	40
600	15	50	500	50
750	20	62	626	50

COLORS: SYMBOL WHITE (RETROREFLECTIVE)
 BACKGROUND BLUE (RETROREFLECTIVE)

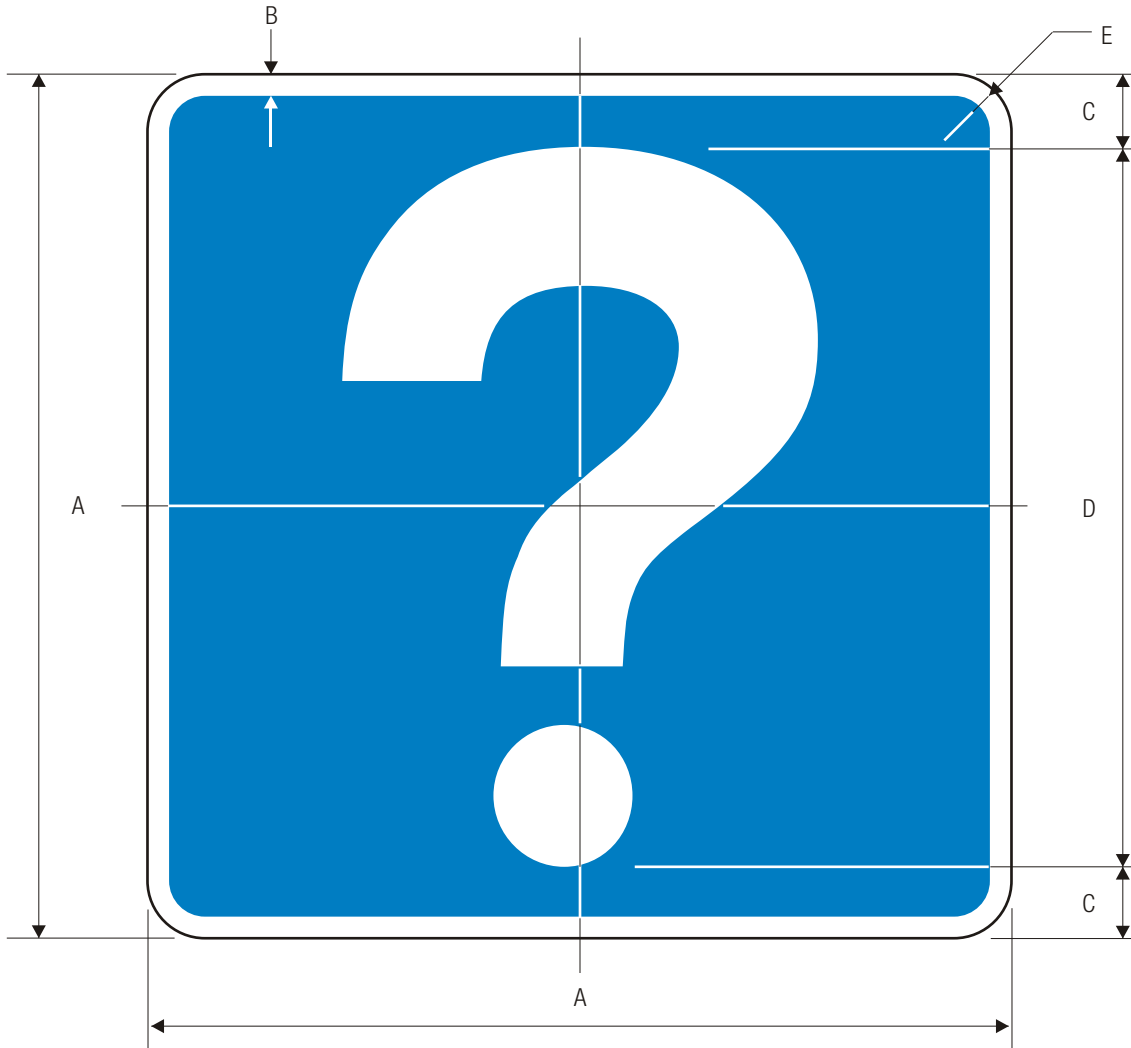

D9-10

TOURIST INFORMATION

*See page 6-49 for symbol design.

A	B	C	D	E
450	10	37	376	40
600	15	50	500	50
750	20	62	626	50

COLORS: SYMBOL WHITE (RETROREFLECTIVE)
 BACKGROUND BLUE (RETROREFLECTIVE)

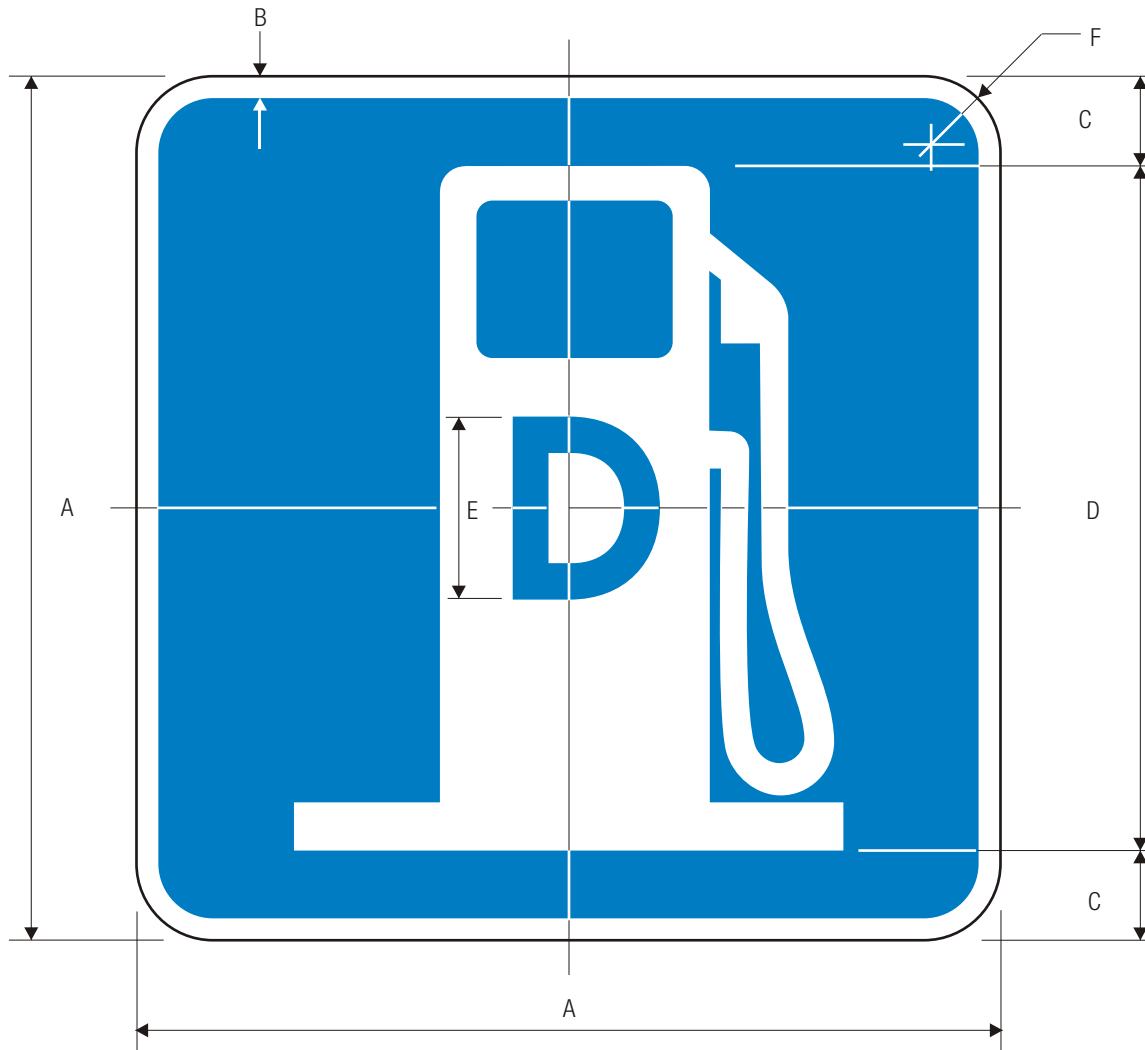

D9-11

DIESEL FUEL

*See page 6-12 for symbol design.

A	B	C	D	E	F
450	10	37	376	100 E(M)	40
600	15	50	500	150 E(M)	50
750	20	62	626	200 E(M)	50

COLORS: SYMBOL WHITE (RETROREFLECTIVE)
 BACKGROUND BLUE (RETROREFLECTIVE)

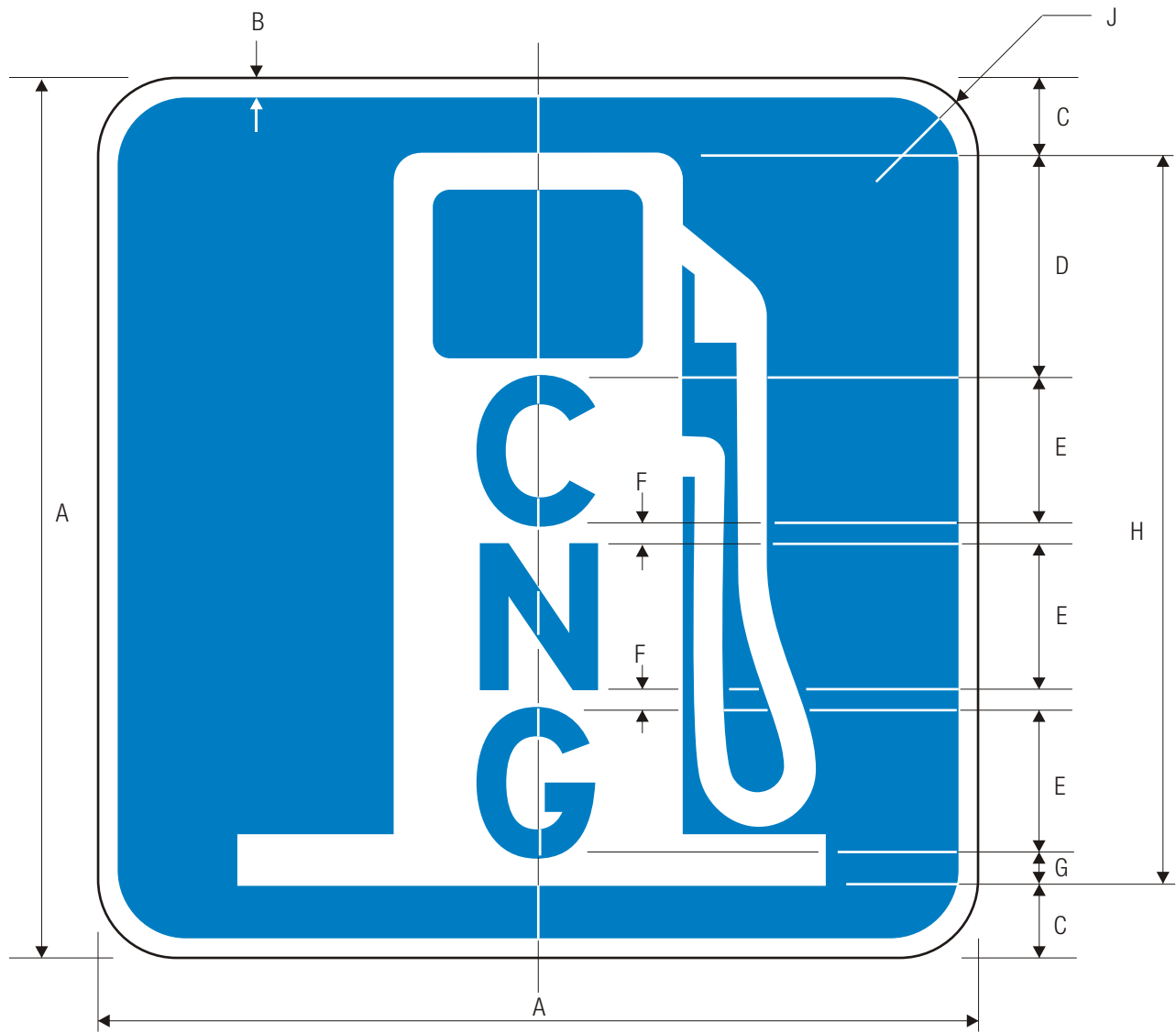

D9-11a

ALTERNATIVE FUEL

*See page 6-12 for design.

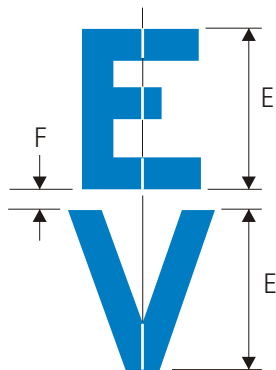

A	B	C	D	E	F	G	H	J
450	10	38	115	75 E(M)	10.5	13	375	40
600	15	50	153	100 E(M)	13	21	500	50
750	20	62.5	190	125 E(M)	17	26	625	50

COLORS: LEGEND BLUE (RETROREFLECTIVE)
 SYMBOL WHITE (RETROREFLECTIVE)
 BACKGROUND BLUE (RETROREFLECTIVE)

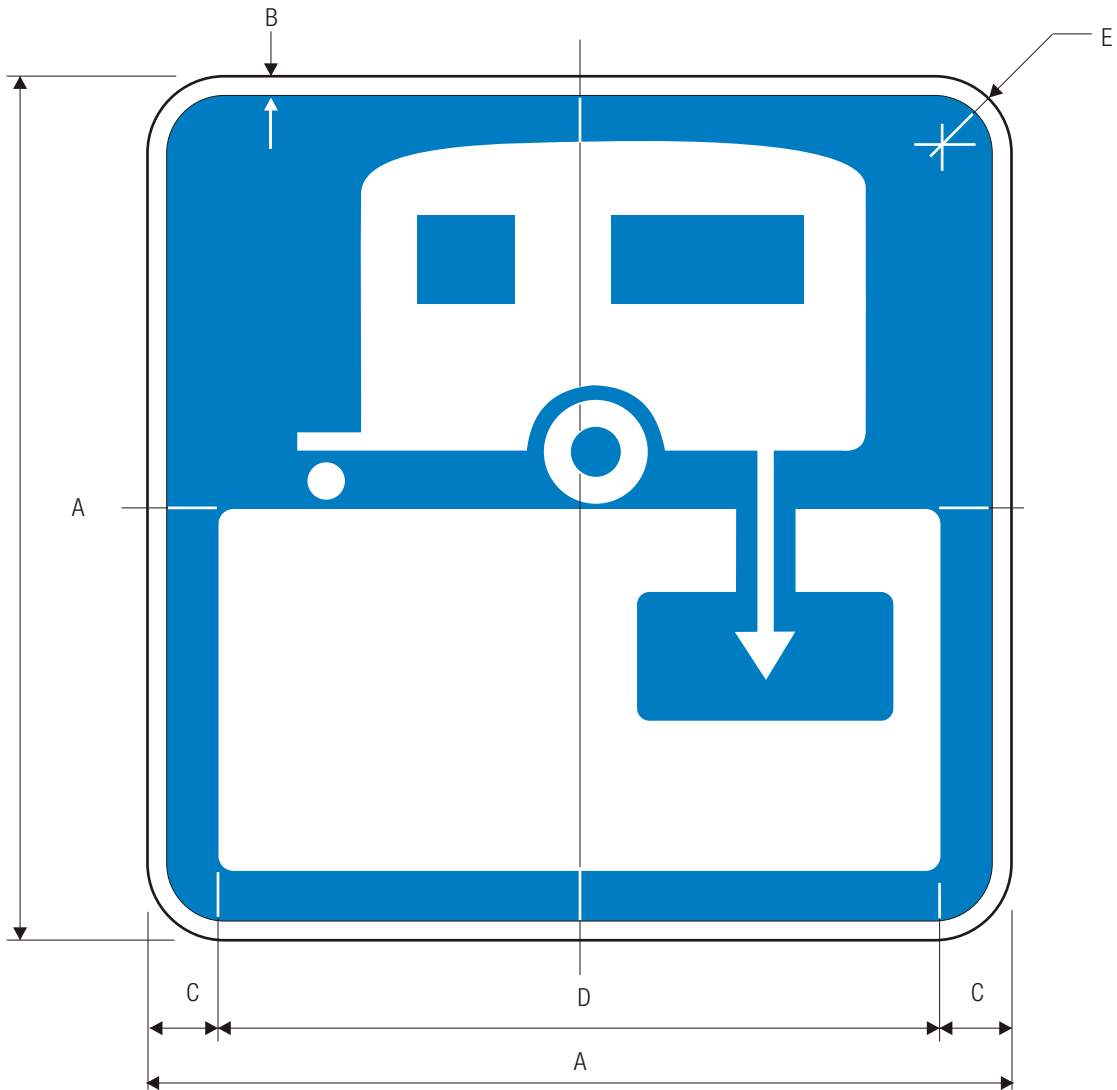

D9-12

RV SANITARY STATION

*See page 6-50 for symbol design.

A	B	C	D	E
450	10	37	376	40
600	15	50	500	50
750	20	62	626	50

COLORS: SYMBOL WHITE (RETROREFLECTIVE)
 BACKGROUND BLUE (RETROREFLECTIVE)

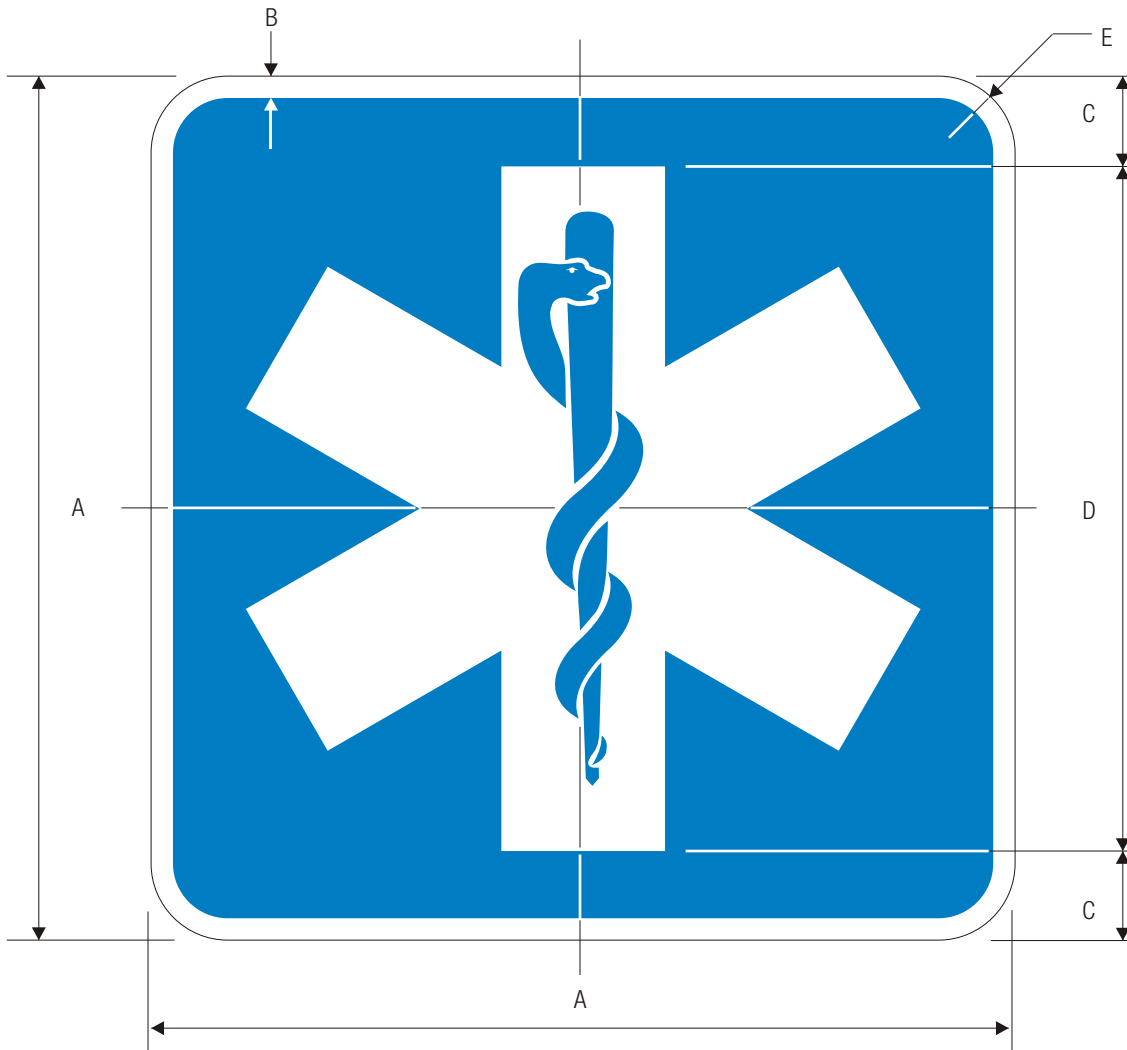

D9-13

EMERGENCY MEDICAL SERVICES

*See page 6-51 for symbol design.

A	B	C	D	E
450	10	37	376	40
600	15	50	500	50
750	20	62	626	50

COLORS: SYMBOL WHITE (RETROREFLECTIVE)
 BACKGROUND BLUE (RETROREFLECTIVE)

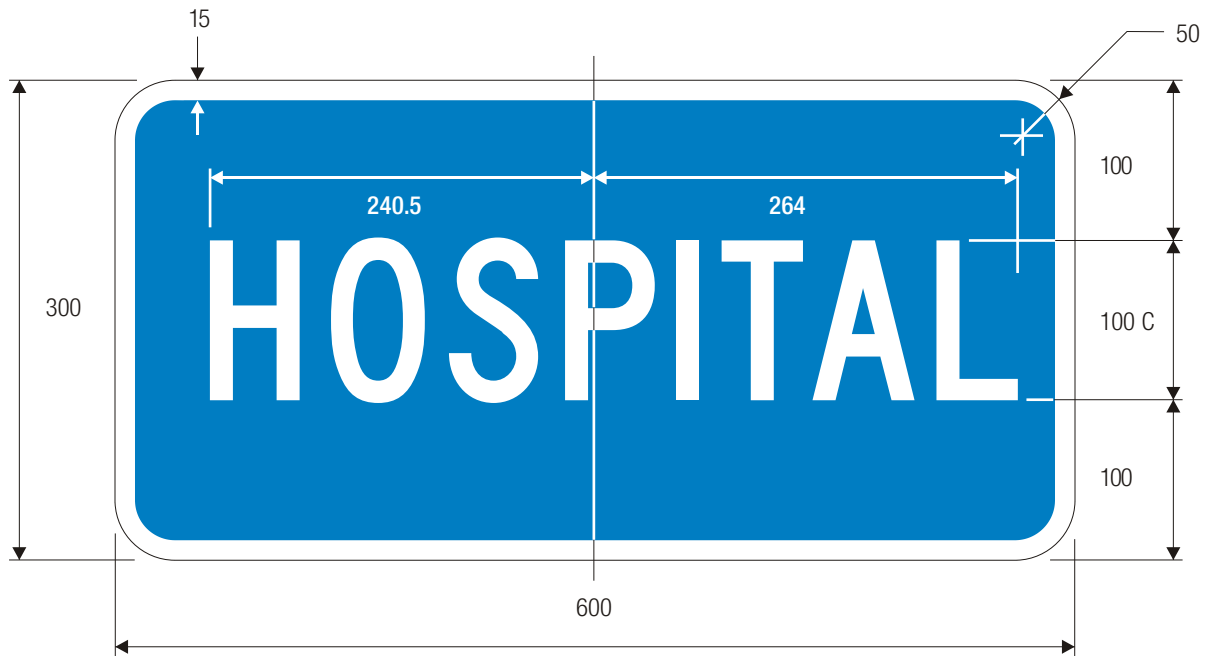

D9-13a

HOSPITAL

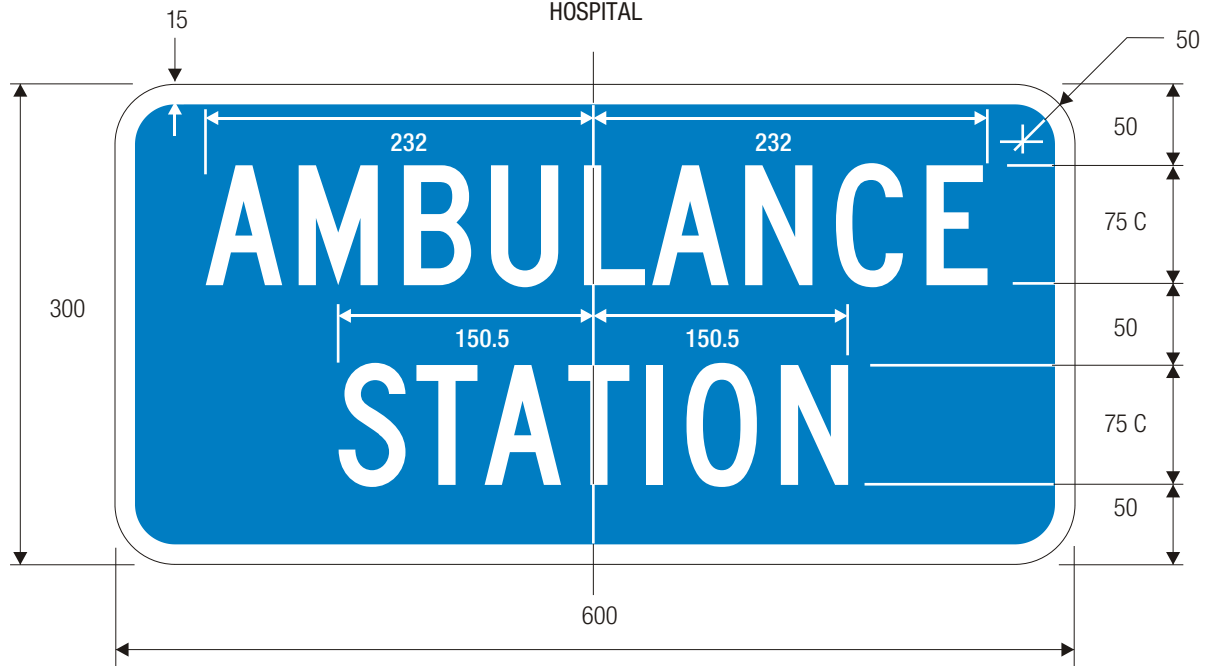

D9-13b

AMBULANCE STATION

COLORS: SYMBOL WHITE (RETROREFLECTIVE)
 BACKGROUND BLUE (RETROREFLECTIVE)

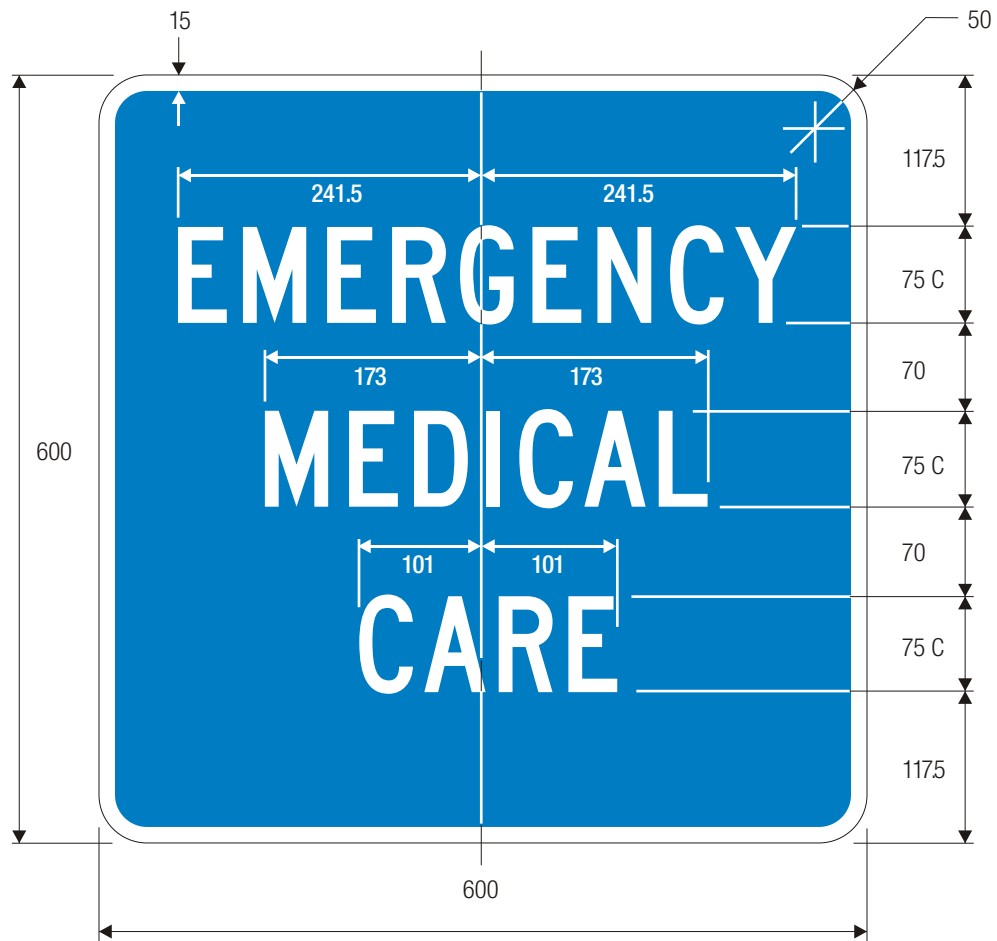

D9-13c

EMERGENCY MEDICAL CARE

COLORS: SYMBOL WHITE (RETROREFLECTIVE)
 BACKGROUND BLUE (RETROREFLECTIVE)



D9-14

POLICE

A	B	C	D	E	F	G
600	300	15	75	150 C	249.5	50
750	375	20	100	175 C	325	50

COLORS: SYMBOL WHITE (RETROREFLECTIVE)
 BACKGROUND BLUE (RETROREFLECTIVE)

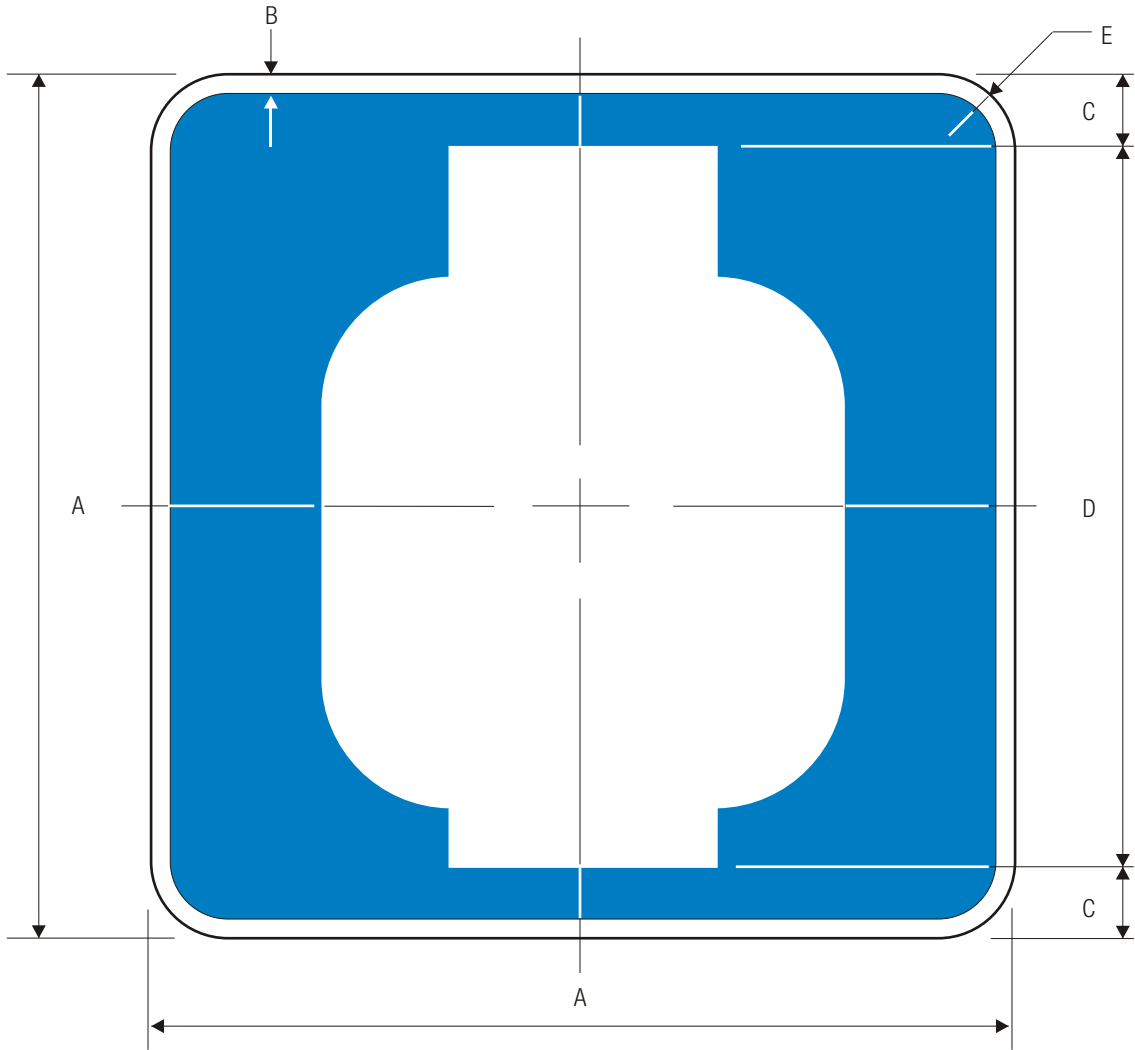

D9-15

PROPANE GAS

*See page 6-52 for symbol design.

Smaller size panels may be used as applicable within terminal areas.

A	B	C	D	E
450	10	37	376	40
600	15	50	500	50
750	20	62	626	50

COLORS: SYMBOL WHITE (RETROREFLECTIVE)
 BACKGROUND BLUE (RETROREFLECTIVE)

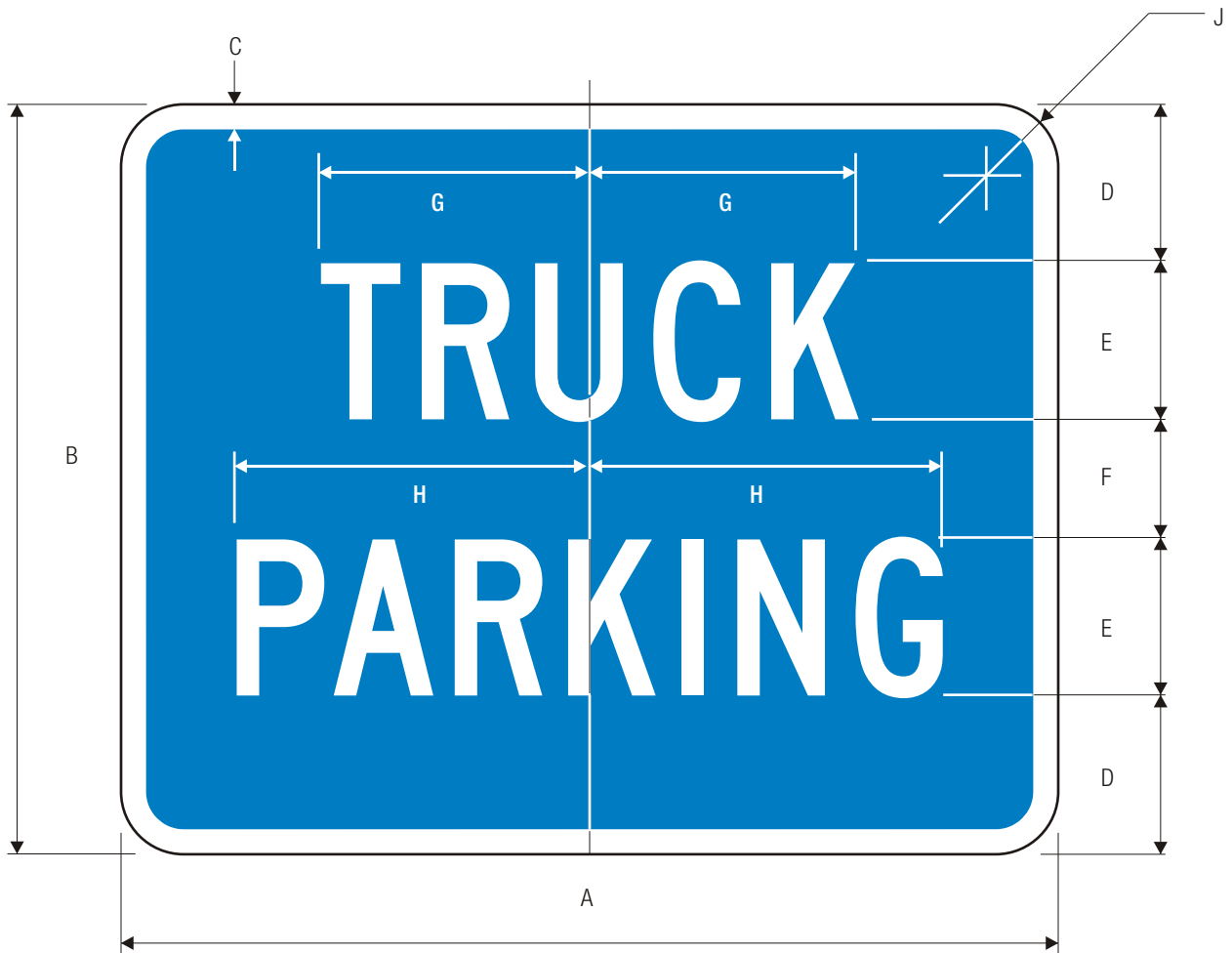

D9-16
TRUCK PARKING

A	B	C	D	E	F	G	H	J
600	450	15	87	100 C	76	172	226	50
750	600	20	127	125 C	96	215	282.5	50

COLORS: LEGEND WHITE (RETROREFLECTIVE)
 BACKGROUND BLUE (RETROREFLECTIVE)

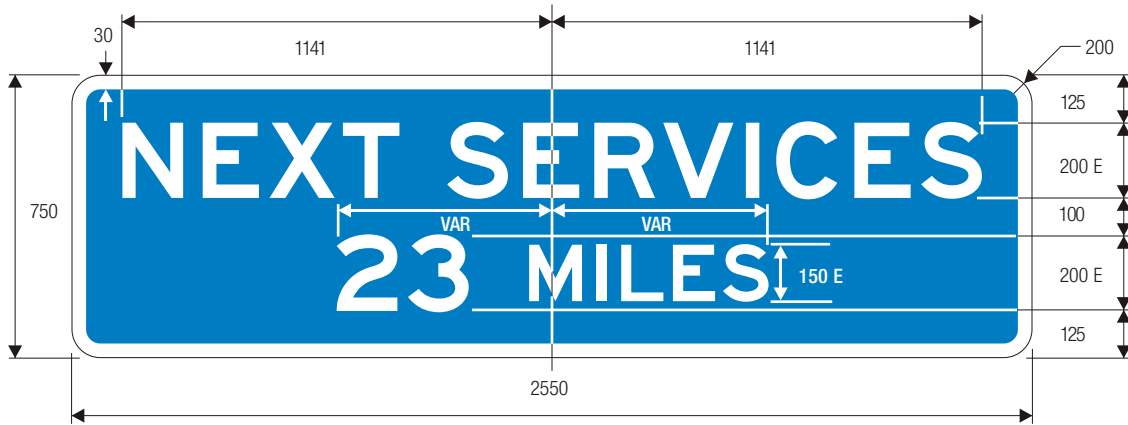

D9-17

NEXT SERVICES XX MILES (ENGLISH)

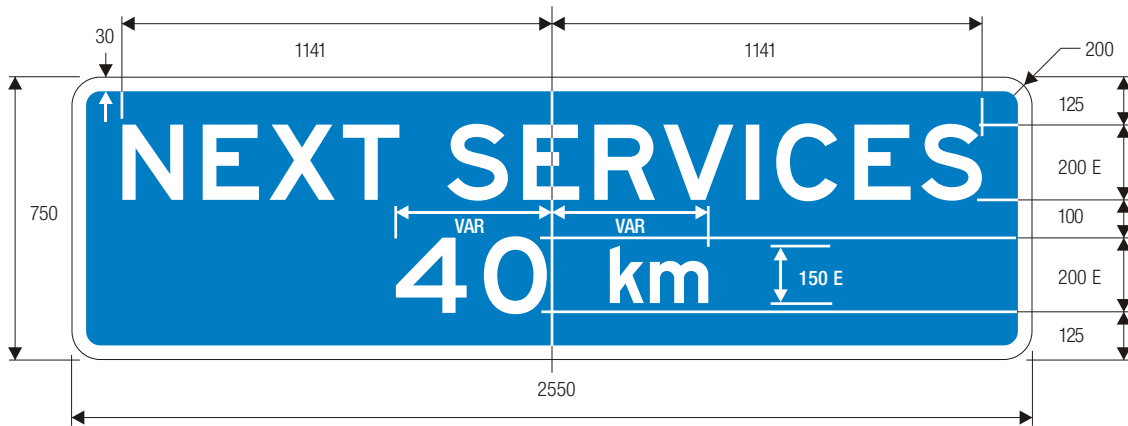

D9-17

NEXT SERVICES XX km (METRIC)

*Series 2000 Standard Alphabets.

COLORS: LEGEND WHITE (RETROREFLECTIVE)
 BACKGROUND BLUE (RETROREFLECTIVE)

MOTORIST SERVICES SIGN

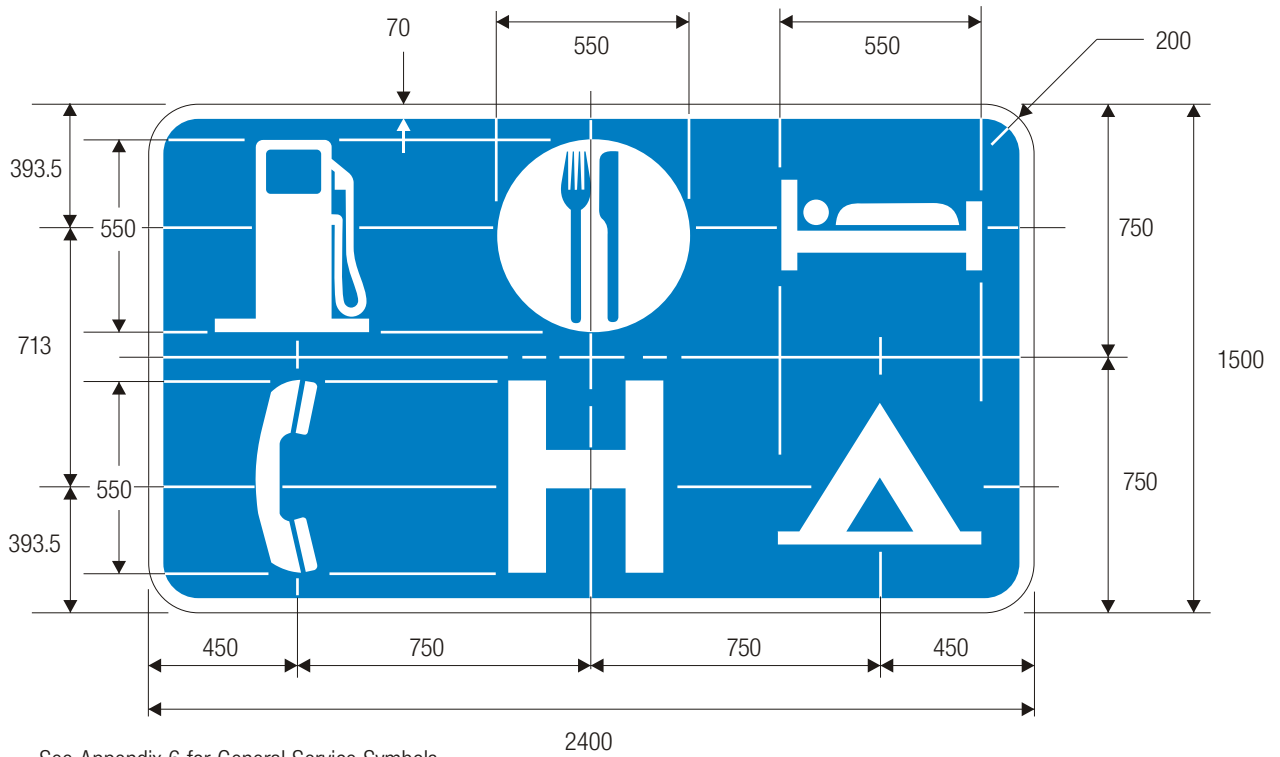

See Appendix 6 for General Service Symbols

D9-18

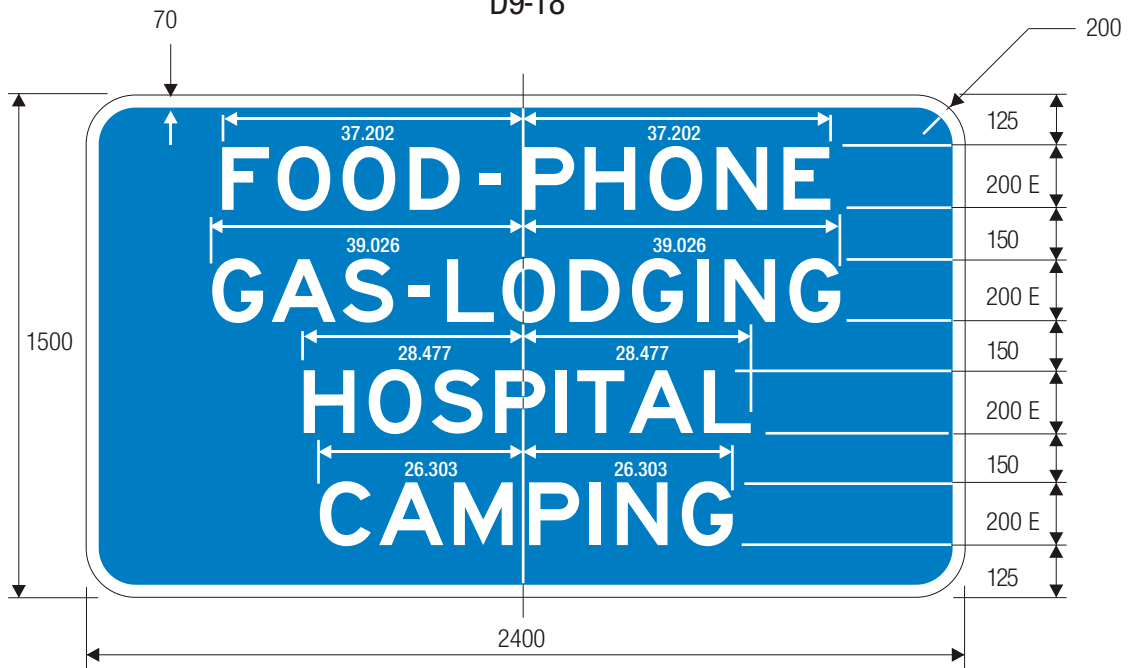

D9-18a

COLORS: LEGEND — WHITE (RETROREFLECTIVE)
 BACKGROUND— BLUE (RETROREFLECTIVE)

MOTORIST SERVICES SIGN

04/14/05

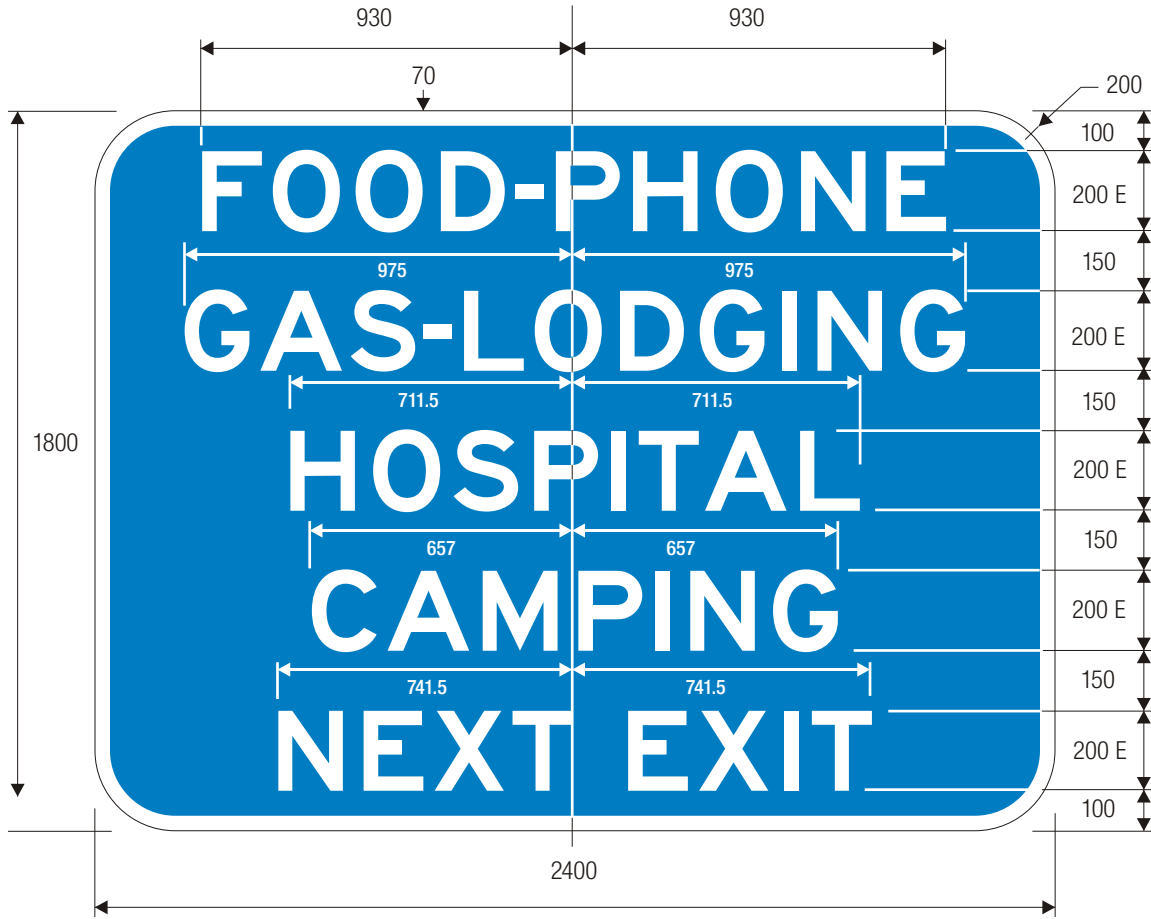

D9-18e

COLORS: LEGEND — WHITE (RETROREFLECTIVE)
BACKGROUND — BLUE (RETROREFLECTIVE)

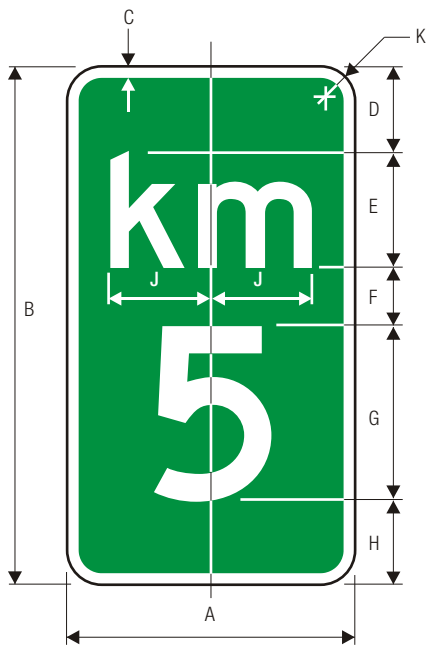

D10-1

A	B	C	D
250	450	10	75
300	600	10	88

E	F	G	H
100 D	50	150 D	75
100 D	75	250 D	87

J	K	L
87.5	30	98
87.5	40	98

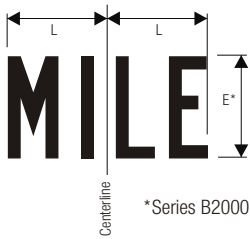

*Series B2000

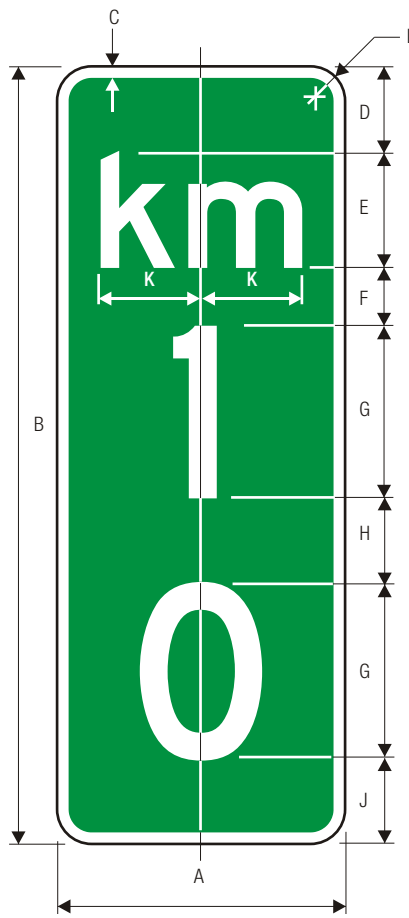

D10-2

A	B	C	D
250	675	10	75
300	900	10	75

E	F	G	H
100 D	50	150 D	75
100 D	75	250 D	75

J	K	L	M
75	87.5	30	98
75	87.5	40	98



*Series B2000

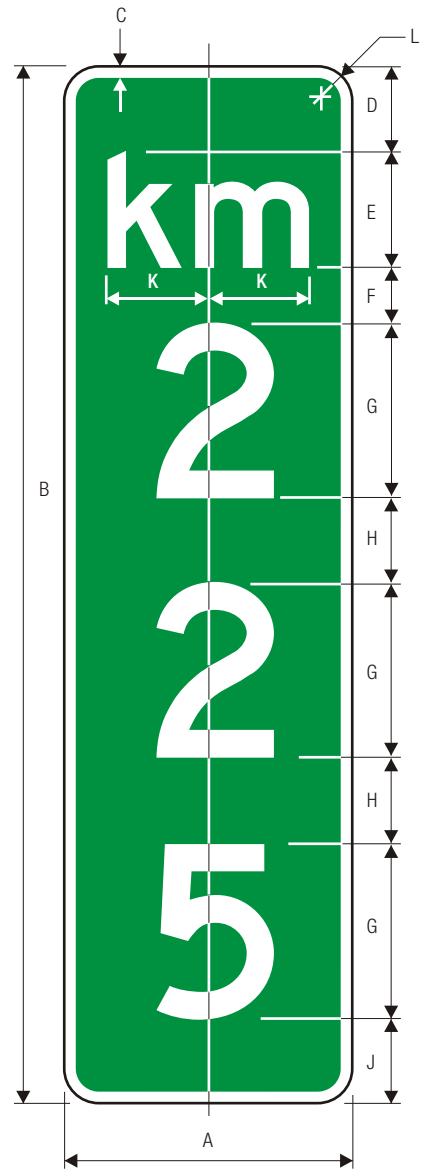

D10-3

A	B	C	D
250	900	10	75
300	1200	10	75

E	F	G	H
100 D	50	150 D	75
100 D	75	250 D	63

J	K	L	M
75	87.5	30	98
74	87.5	40	98



*Series B2000

Optically locate numerals about centerline.

REFERENCE LOCATION SIGNS

COLORS: LEGEND —WHITE (RETROREFLECTIVE)
 BACKGROUND —GREEN (RETROREFLECTIVE)

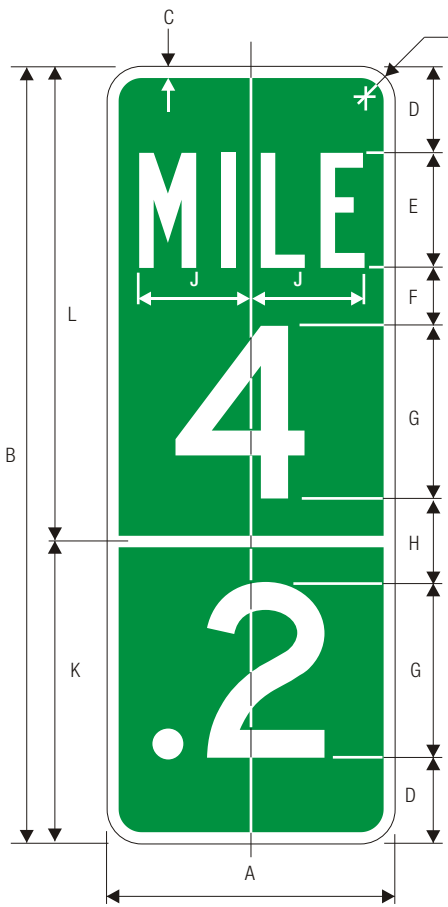

D10-1a

A	B	C	D
250	675	10	75
300	900	10	75
E	F	G	H
100 B	50	150 D	75
100 B	75	250 D	75
J	K	L	M
98	262.5	412.5	30
98	362.5	537.5	40

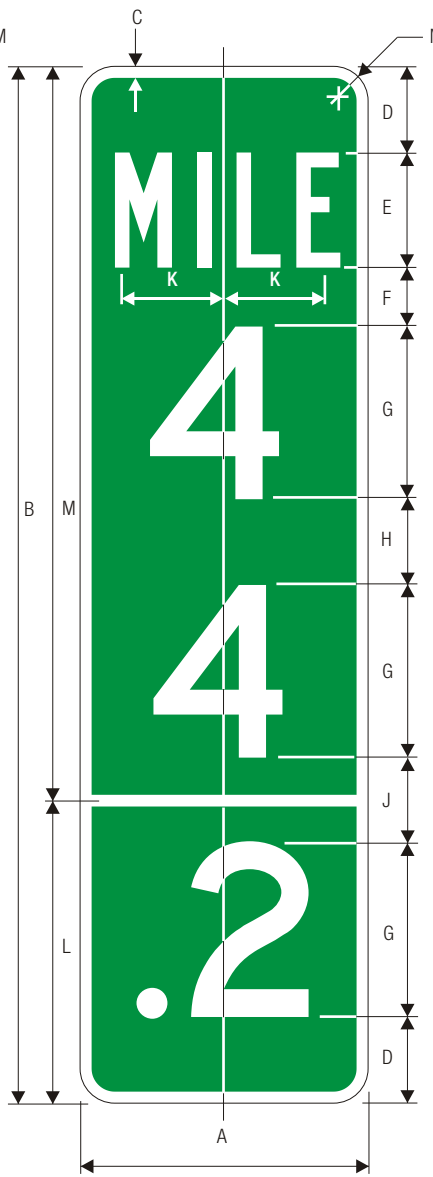

D10-2a

A	B	C	D
250	900	10	75
300	1200	10	50
E	F	G	H
100 B	50	150 D	75
100 B	75	250 D	75
J	K	L	M
75	98	262.5	637.5
100	98	350	850
N			
30			
40			

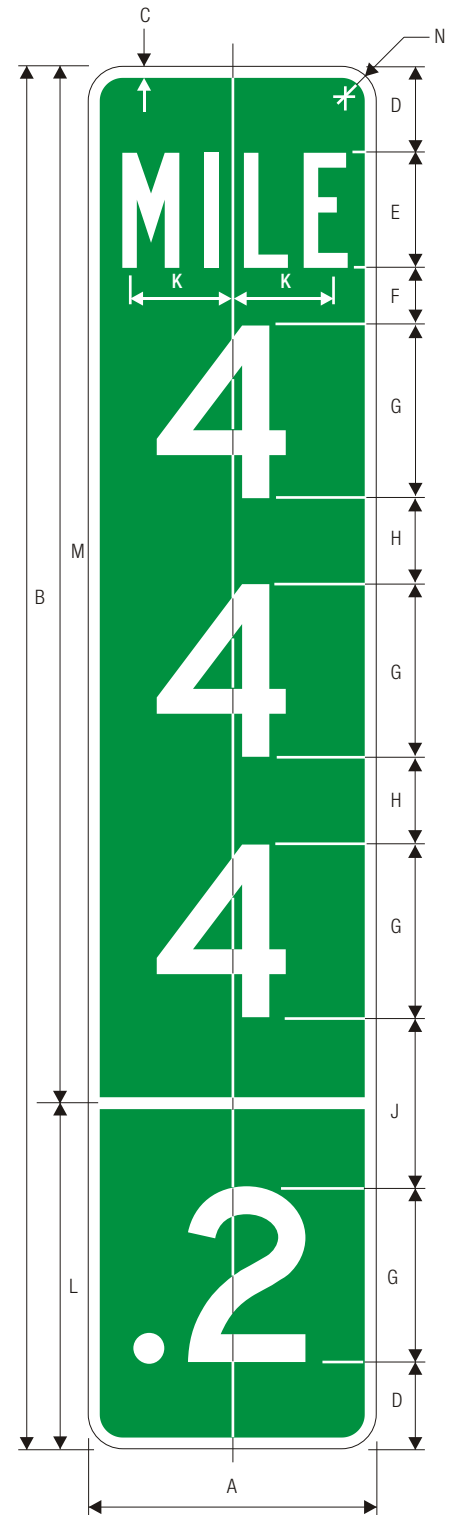

D10-3a

A	B	C	D	
250	1200	10	75	
300	1500	10	50	
E	F	G	H	
100 B	50	150 D	75	
100 B	75	250 D	50	
J	K	L	M	N
150	98	300	900	30
125	98	362.5	1137.5	40

INTERMEDIATE REFERENCE LOCATION SIGNS

Optically locate numerals about centerline.

COLORS: LEGEND —WHITE (RETROREFLECTIVE)
 BACKGROUND —GREEN (RETROREFLECTIVE)

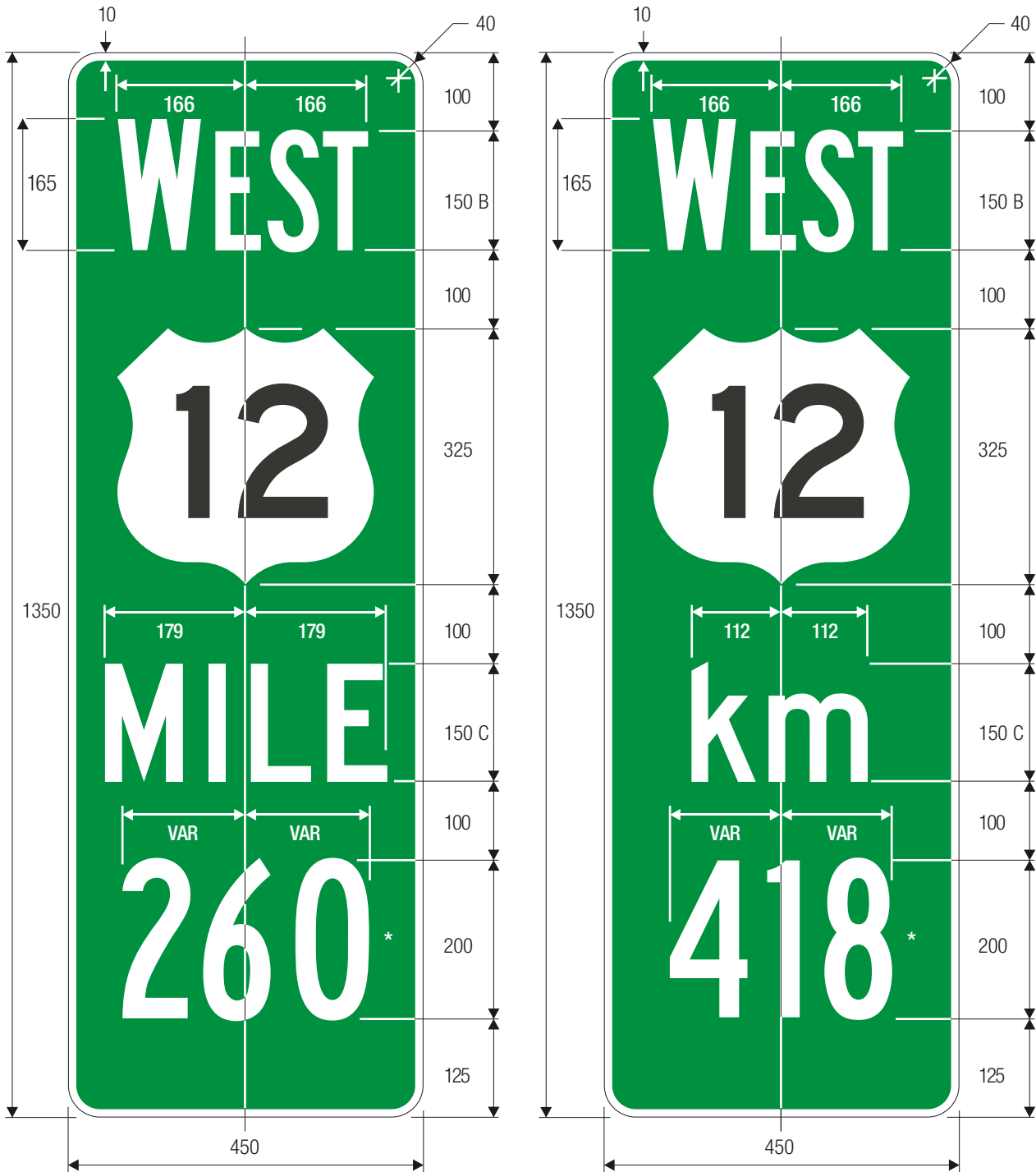

*Optically locate numerals about centerline.

D10-4

ENHANCED REFERENCE LOCATION SIGNS

COLORS: LEGEND —WHITE (RETROREFLECTIVE)
BACKGROUND —GREEN OR BLUE (RETROREFLECTIVE)

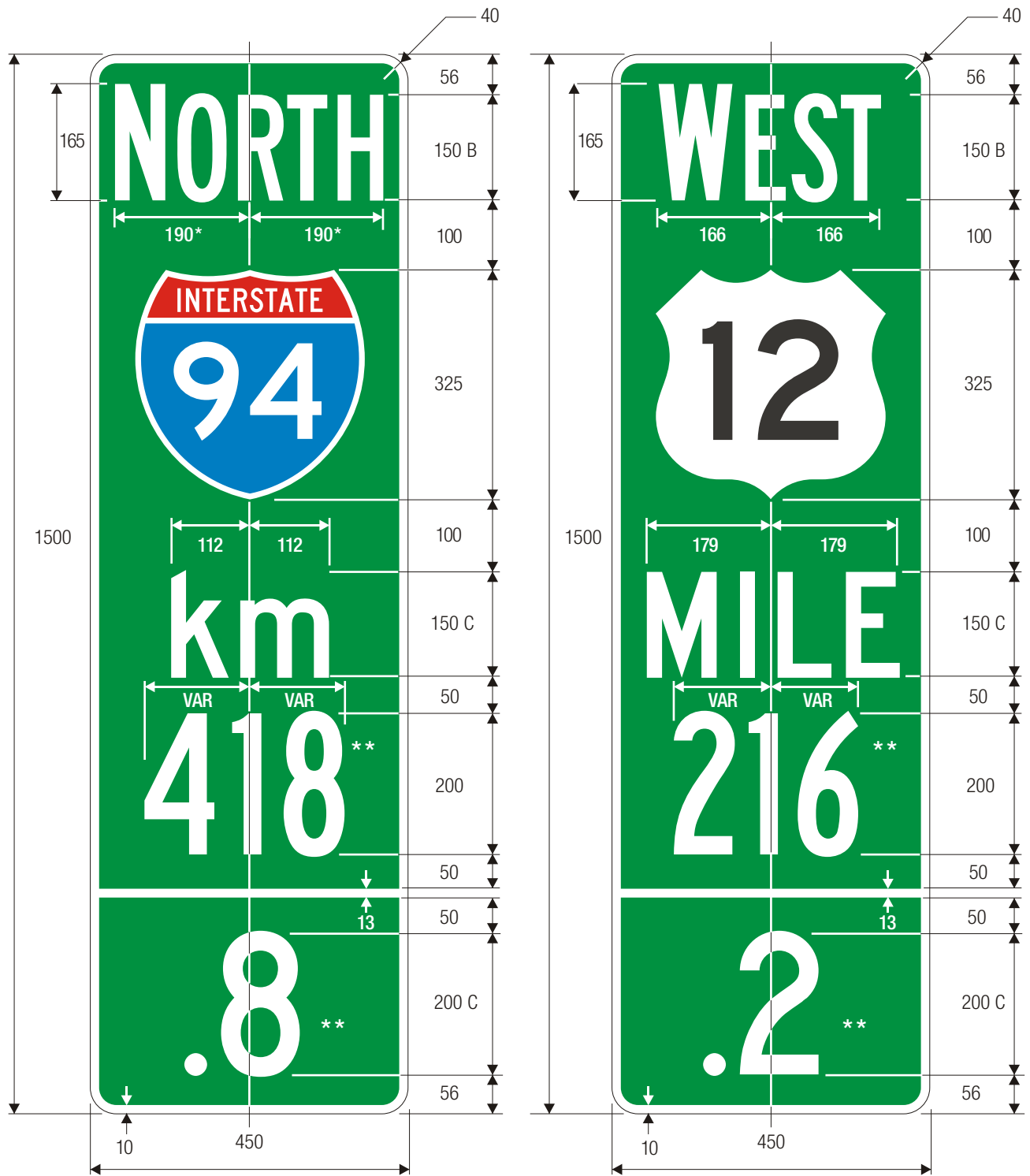

INTERMEDIATE ENHANCED REFERENCE LOCATION

D10-5

*Reduce spacing to fit.
 **Optically locate numerals about centerline.

COLORS: LEGEND —WHITE (RETROREFLECTIVE)
 BACKGROUND —GREEN OR BLUE (RETROREFLECTIVE)



D11-1

BICYCLE ROUTE

*See page 6-7 for symbol design.

A	B	C	D	E	F	G	H	J
600	450	15	40	255	75 C	220	237.5	50
750	600	20	50	350	100 C	302	316.5	50

COLORS: LEGEND WHITE (RETROREFLECTIVE)
 SYMBOL WHITE (RETROREFLECTIVE)
 BACKGROUND GREEN (RETROREFLECTIVE)

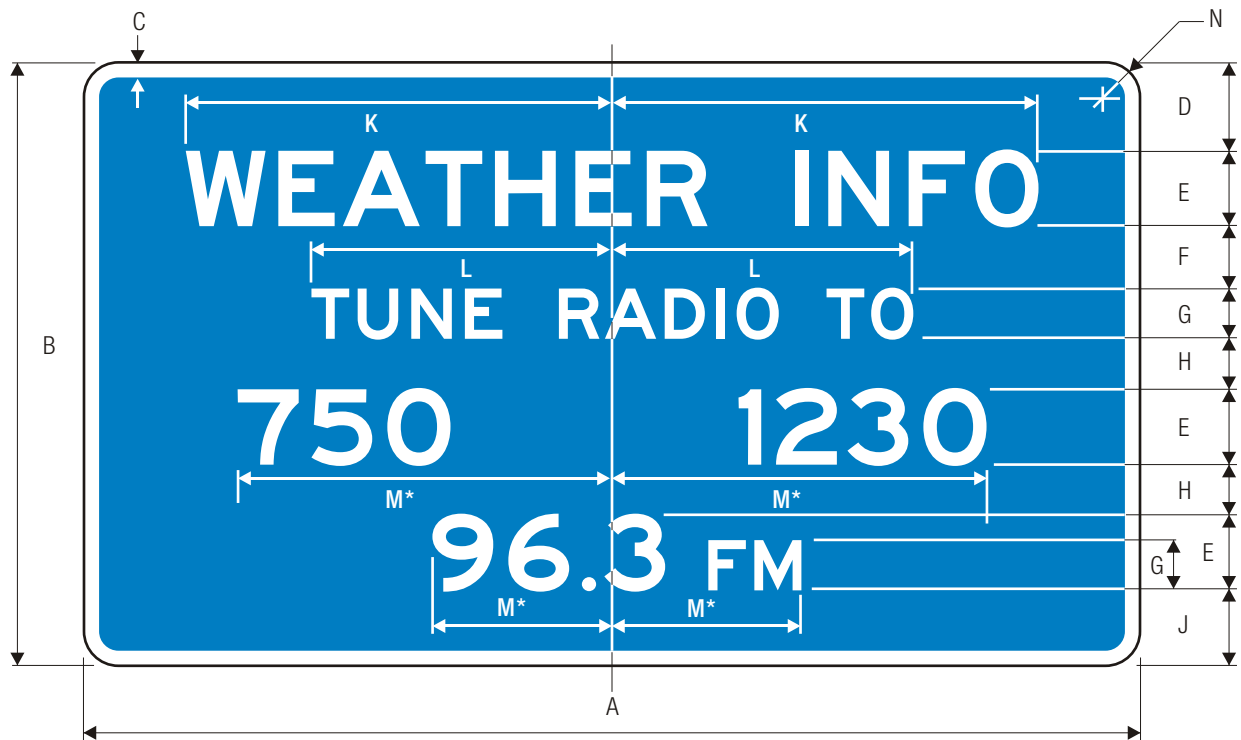

D12-1
WEATHER INFO

*Optically space characters about vertical centerline.

A	B	C	D	E	F	G	H	J	K	L	M	N
2100	1200	30	175	150 E	125	100 E	100	150	850	600	VAR	70
2700	1650	30	225	200 E	175	150 E	150	200	1130	900	VAR	70
3300	2100	30	275	250 E	225	200 E	200	250	1415	1200	VAR	70

COLORS: LEGEND —WHITE (RETROREFLECTIVE)
BACKGROUND —BLUE (RETROREFLECTIVE)

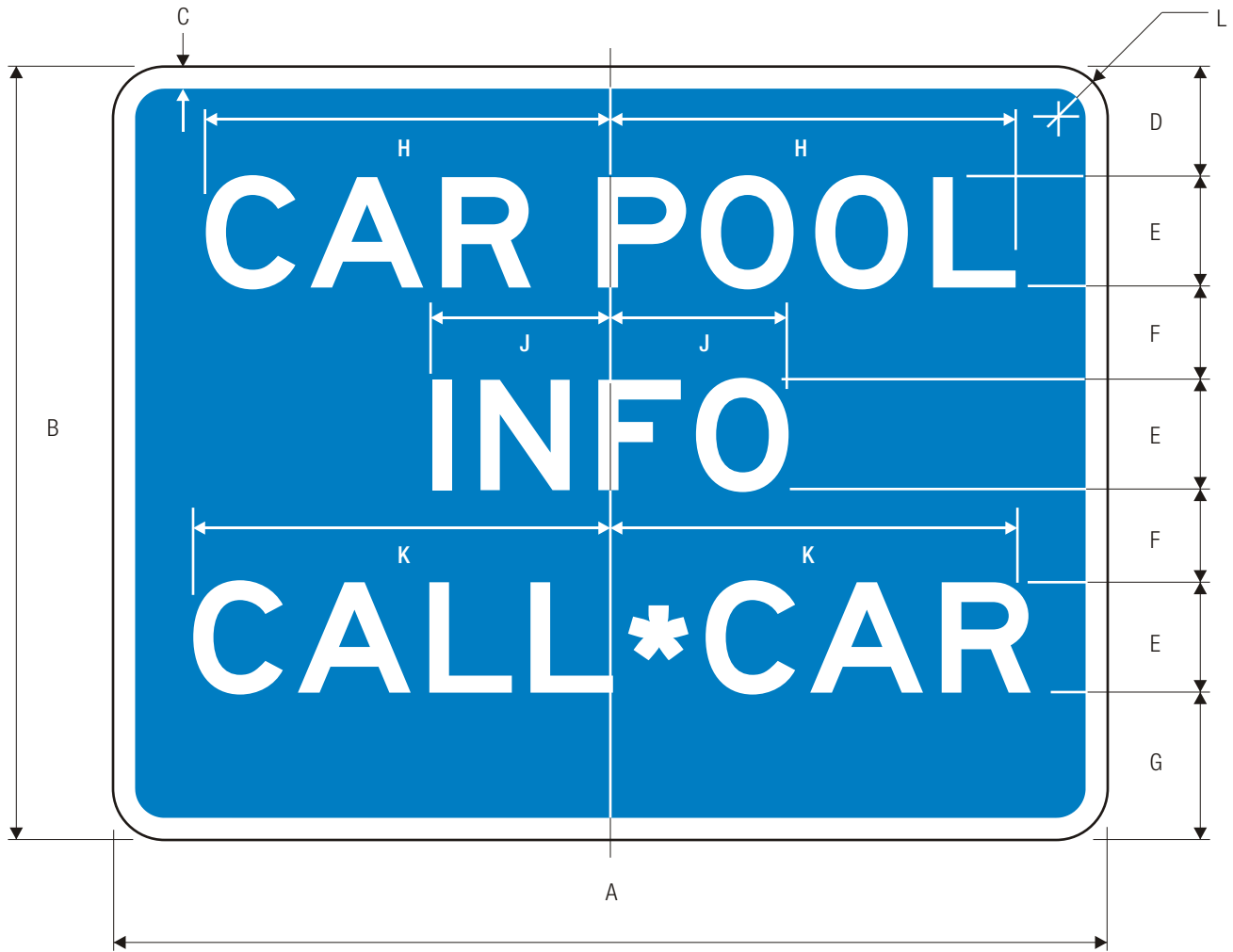

D12-2

CAR POOL INFORMATION

A	B	C	D	E	F	G	H	J	K	L
1350	1050	30	150	150 E	125	200	550	241.5	569	70
1800	1350	30	200	200 E	150	250	738	322.5	758.5	70
2400	1650	30	225	250	200	275	1007.5	403	948	70

COLORS: LEGEND —WHITE (RETROREFLECTIVE)
 BACKGROUND —BLUE (RETROREFLECTIVE)

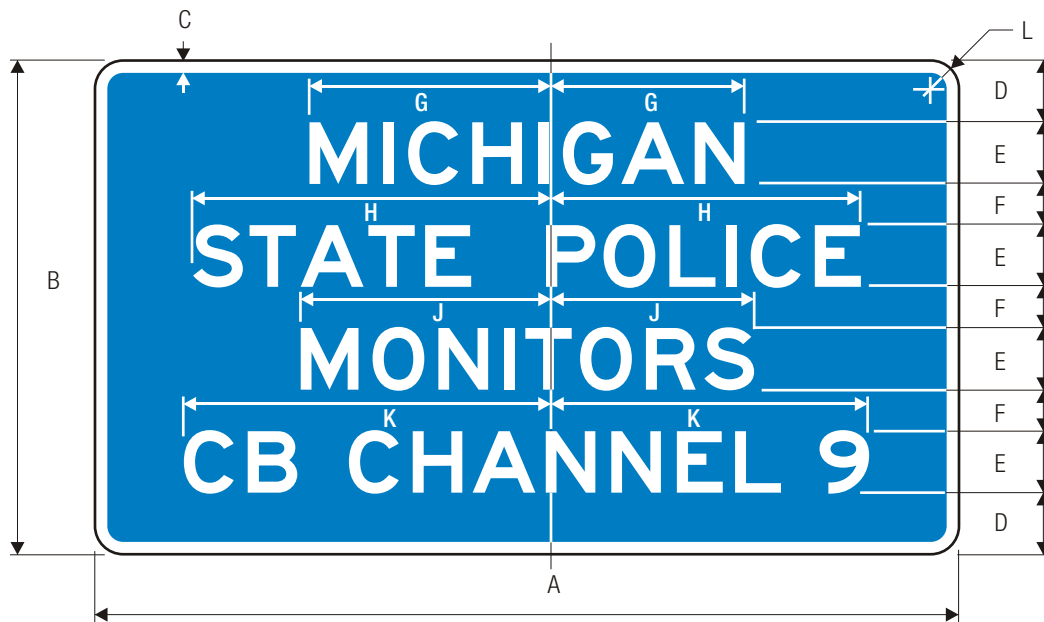

D12-3

CHANNEL 9 MONITORED

A	B	C	D	E	F	G	H	J	K	L
2100	1200	30	150	150 E	100	528.5	811.5	551	833	70
2700	1650	30	200	200 E	150	705	1083	734.5	1087	70
3300	2100	30	250	250 E	200	881	1339.5	918.5	1372	70

COLORS: LEGEND —WHITE (RETROREFLECTIVE)
 BACKGROUND —BLUE (RETROREFLECTIVE)



D12-4

EMERGENCY DIAL 911

A	B	C	D	E	F	G	H	J
1600	750	30	162.5	150 E	125	679	431	70
1800	900	30	200	175 E	150	792	502.5	100
2400	1200	50	275	225 E	200	1018	646	200

COLORS: LEGEND —WHITE (RETROREFLECTIVE)
 BACKGROUND —BLUE (RETROREFLECTIVE)

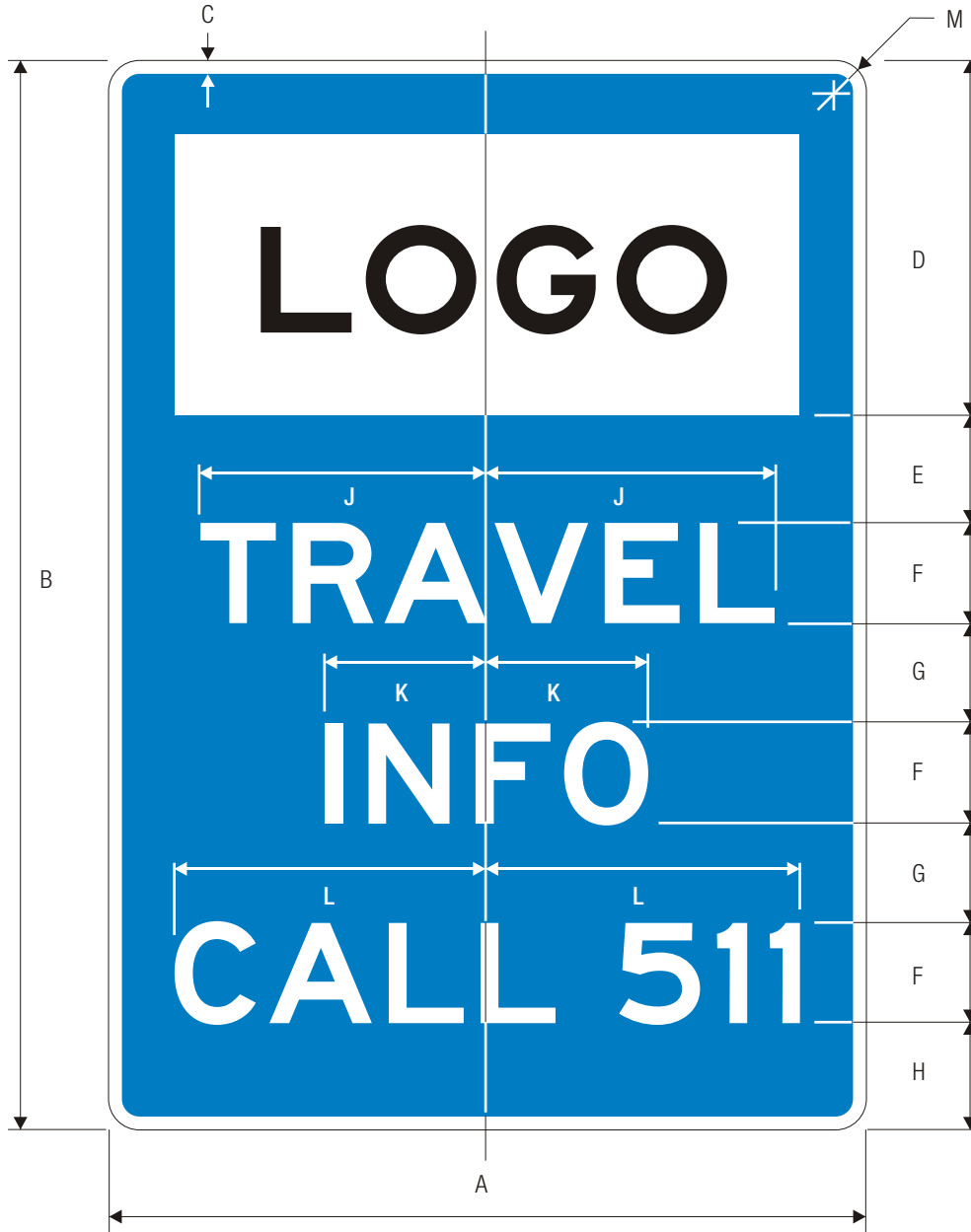

D12-5

TRAVEL INFO CALL 511

A	B	C	D	E	F	G	H	J	K	L	M
1050	1500	30	500	187	125E	125	188	357.5	201.5	389.5	70
1350	2000	30	667	229	175	175	229	501	282	545.5	70
1700	2400	30	800	237	225	225	238	644	362.5	701.5	70

COLORS: LEGEND -WHITE (RETROREFLECTIVE)
 BACKGROUND -BLUE (RETROREFLECTIVE)

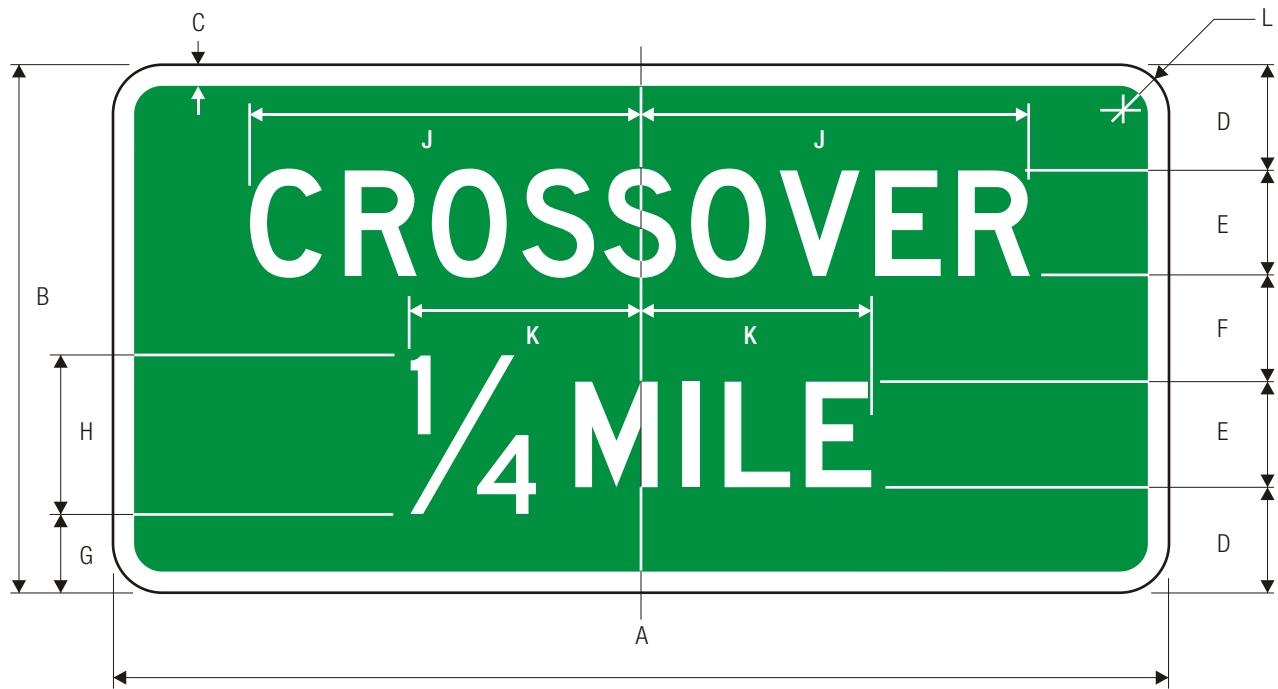

D13-2
CROSSOVER

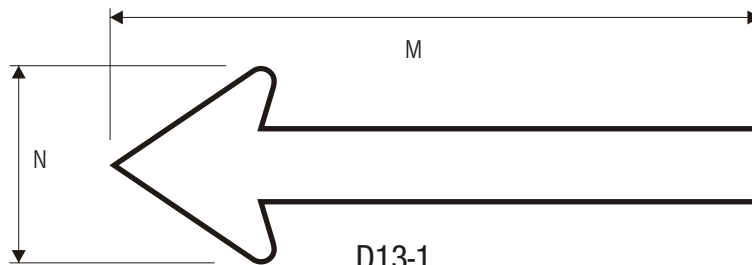

D13-1
CROSSOVER

Use arrow at crossover location.

A	B	C	D	E	F	G	H	J	K	L
1500	750	30	150	150 E	150	37.5	225	554	327	70
1800	900	30	175	200 E	150	50	300	738.5	445	70

M	N
450	150
600	200

COLORS: LEGEND —WHITE (RETROREFLECTIVE)
BACKGROUND —GREEN (RETROREFLECTIVE)

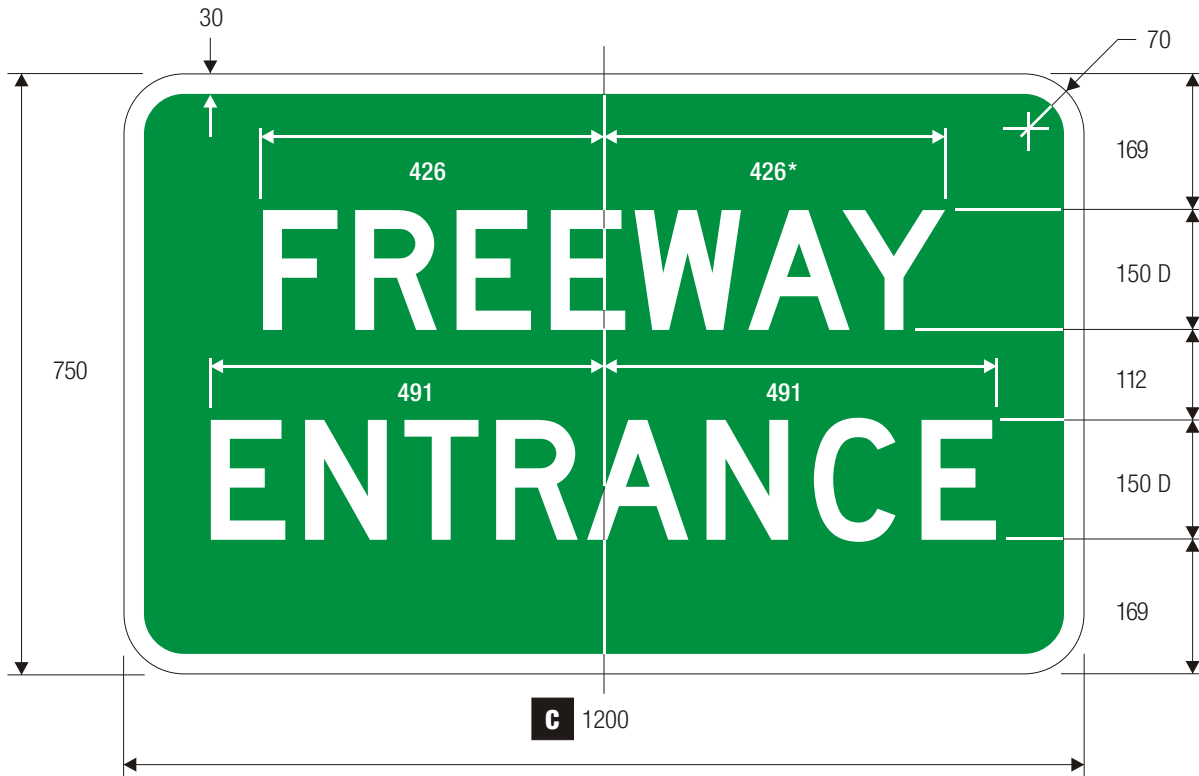

D13-3

FREEWAY ENTRANCE

*Reduce spacing to fit.

COLORS: LEGEND WHITE (RETROREFLECTIVE)
 BACKGROUND GREEN (RETROREFLECTIVE)



D13-3aR

FREEWAY ENTRANCE

*Reduce spacing to fit.

**See page 6-3 for design details.



D13-3aL

COLORS: LEGEND WHITE (RETROREFLECTIVE)
 SYMBOL WHITE (RETROREFLECTIVE)
 BACKGROUND GREEN (RETROREFLECTIVE)

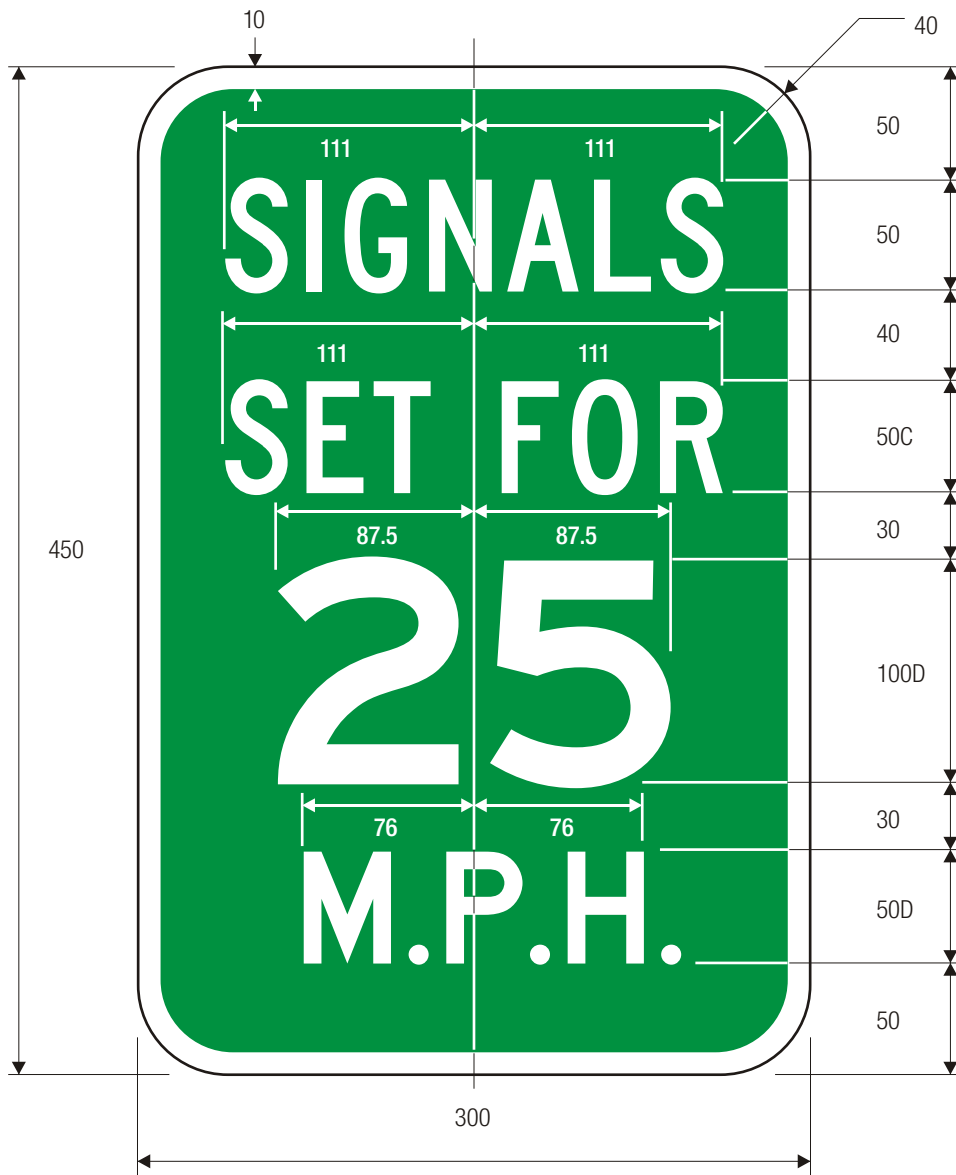

I1-1

TRAFFIC SIGNAL SPEED

COLORS: LEGEND WHITE (RETROREFLECTIVE)
 BACKGROUND GREEN (RETROREFLECTIVE)

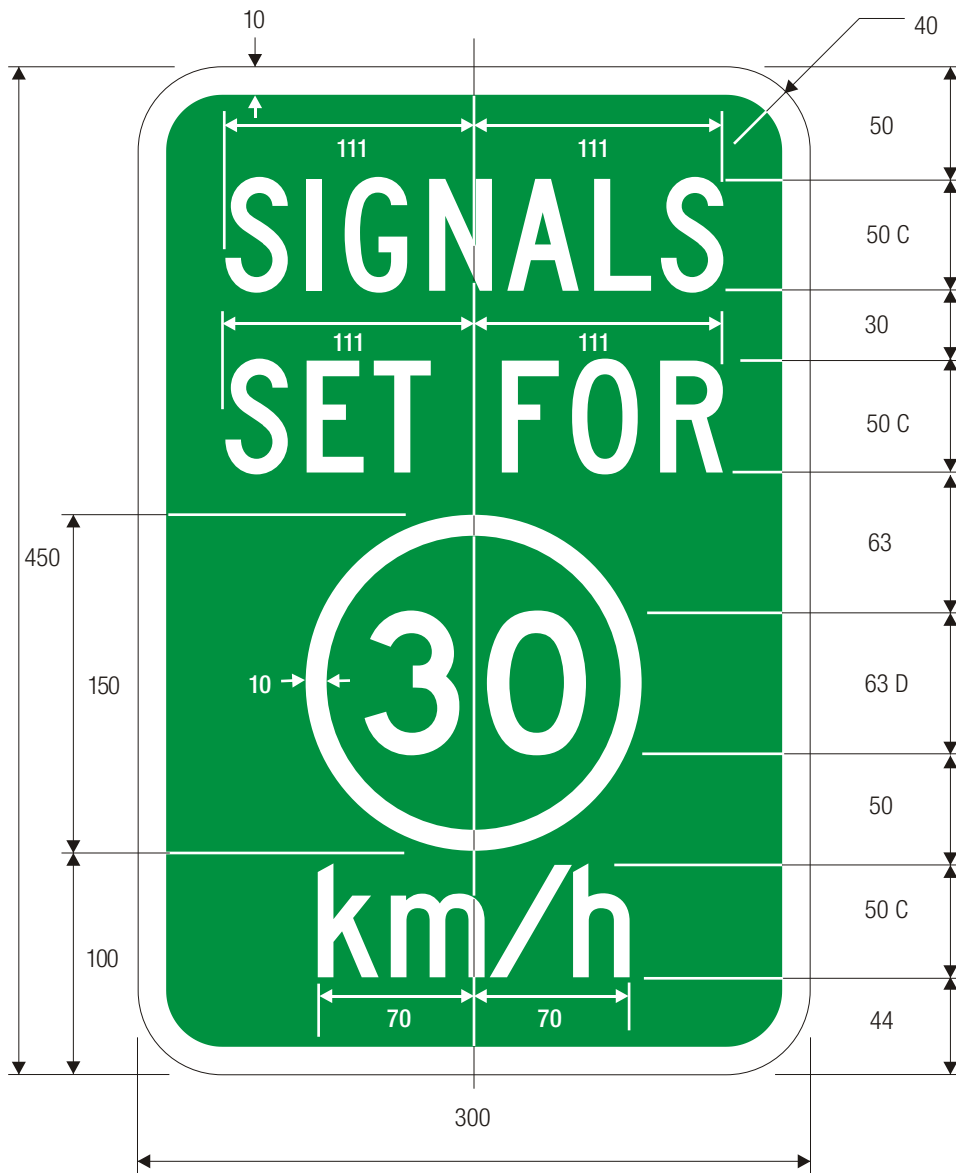

I1-1 Metric

TRAFFIC SIGNAL SPEED (METRIC)

COLORS: LEGEND WHITE (RETROREFLECTIVE)
 BACKGROUND GREEN (RETROREFLECTIVE)

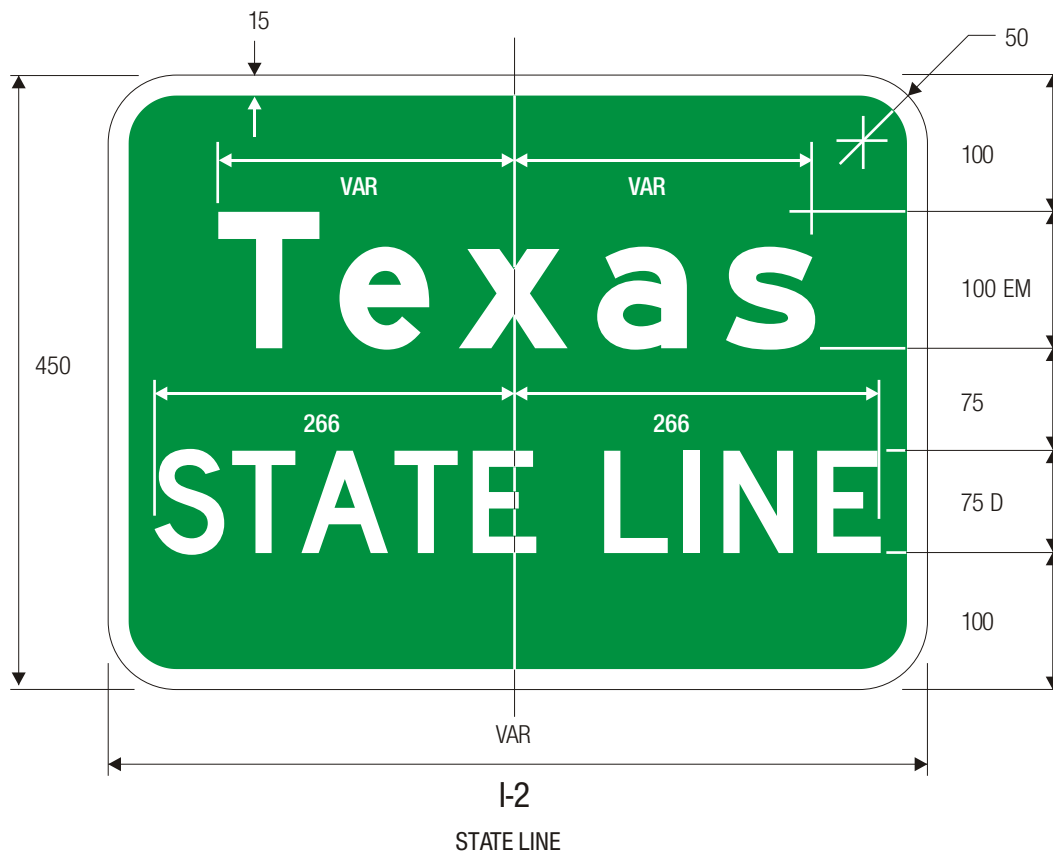

COLORS: LEGEND WHITE (RETROREFLECTIVE)
 BACKGROUND GREEN (RETROREFLECTIVE)

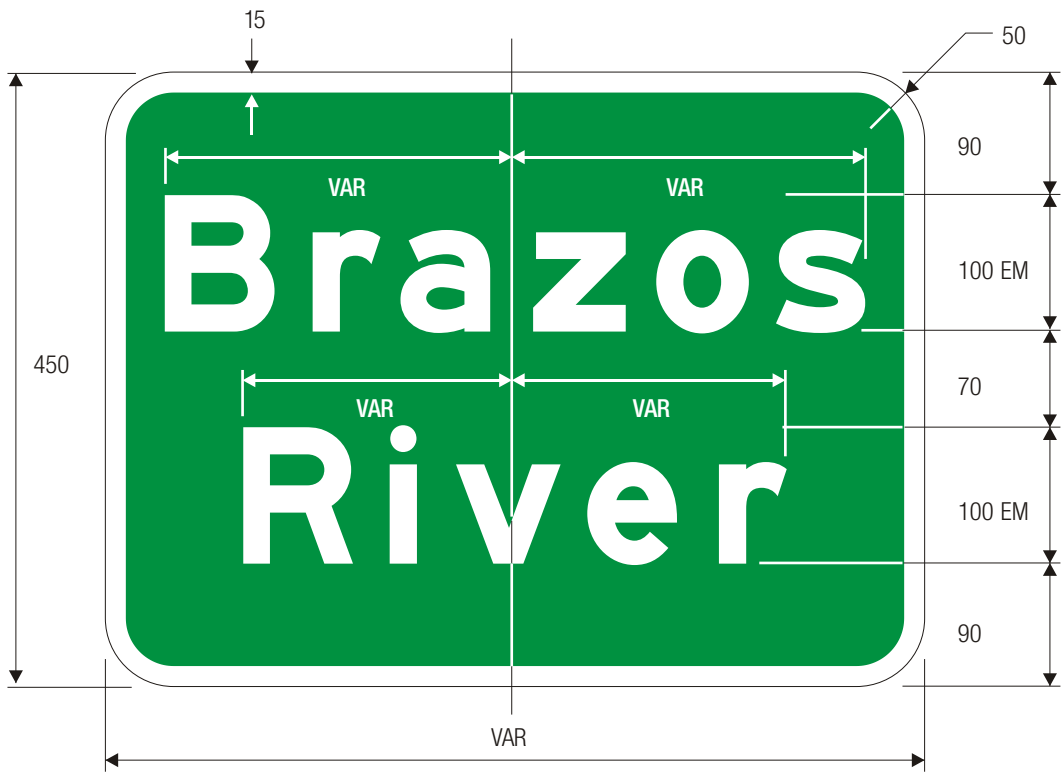

I-3
BRAZOS RIVER

COLORS: LEGEND WHITE (RETROREFLECTIVE)
 BACKGROUND GREEN (RETROREFLECTIVE)

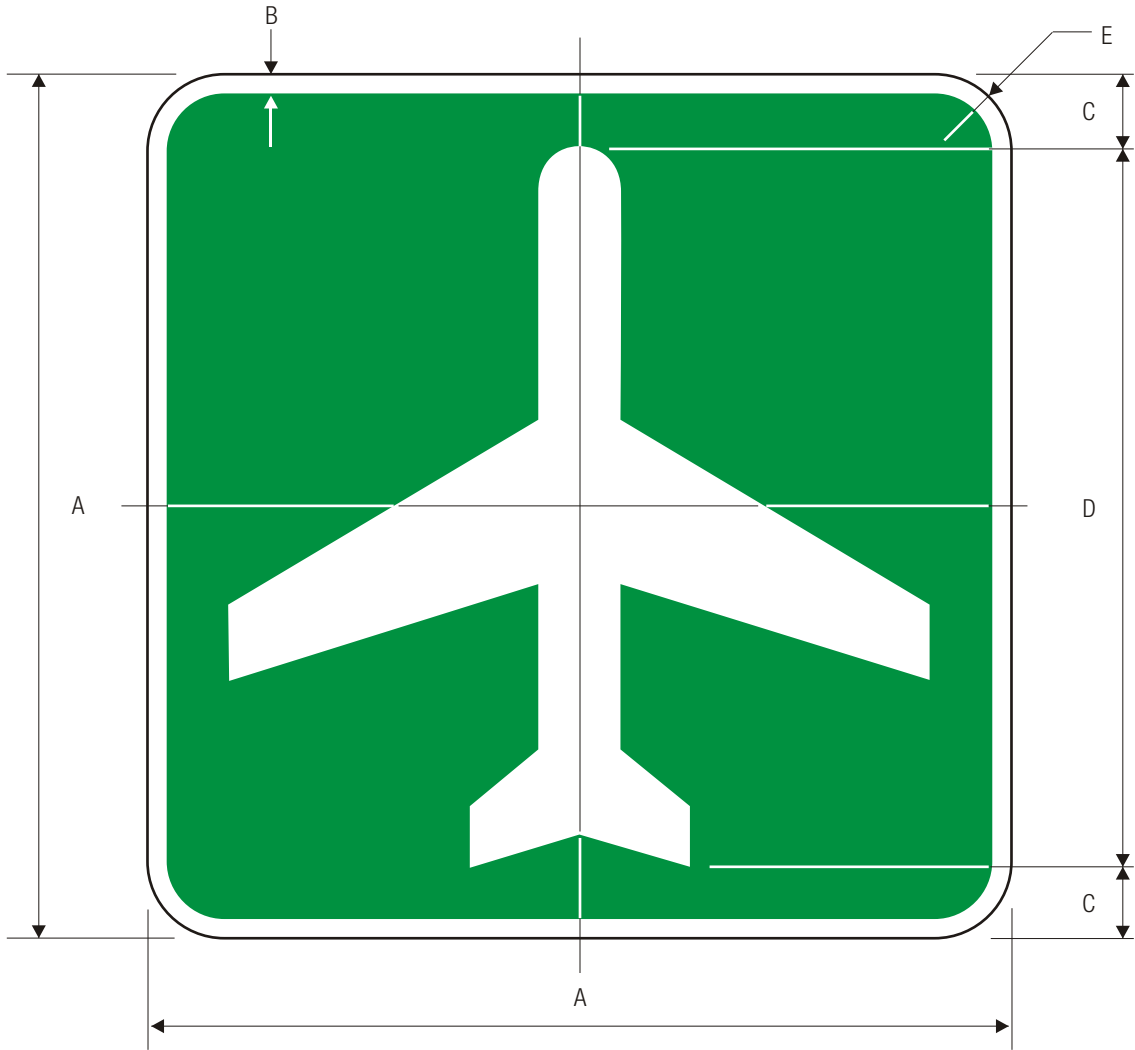

I-5
AIRPORT

*See page 6-53 for symbol design.

A	B	C	D	E
450	10	37	376	40
600	15	50	500	50
750	20	62	626	50

COLORS: SYMBOL WHITE (RETROREFLECTIVE)
BACKGROUND GREEN (RETROREFLECTIVE)

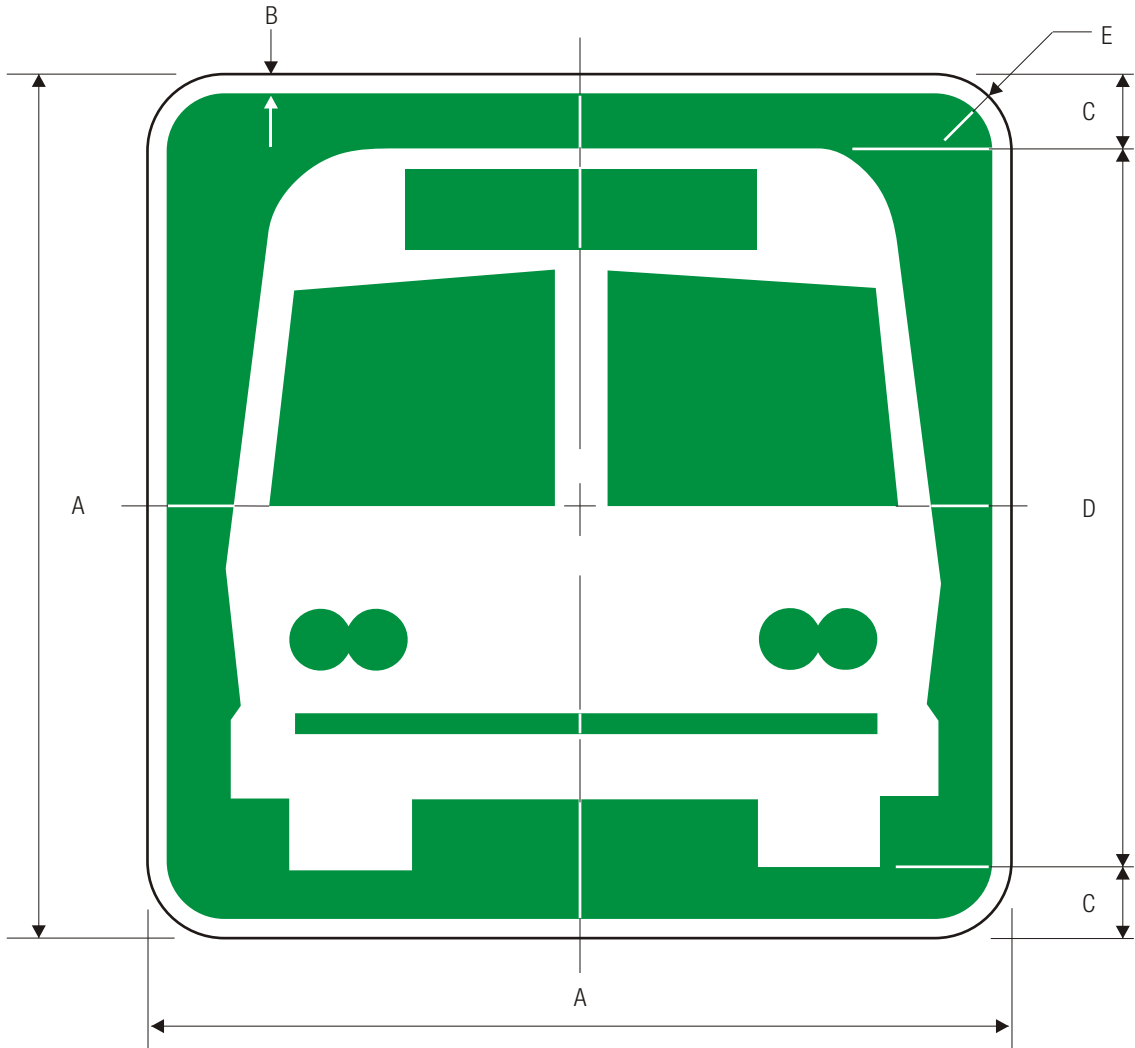

I-6
BUS STATION

*See page 6-33 for symbol design.

A	B	C	D	E
450	10	37	376	40
600	15	50	500	50
750	20	62	626	50

COLORS: SYMBOL WHITE (RETROREFLECTIVE)
BACKGROUND GREEN (RETROREFLECTIVE)

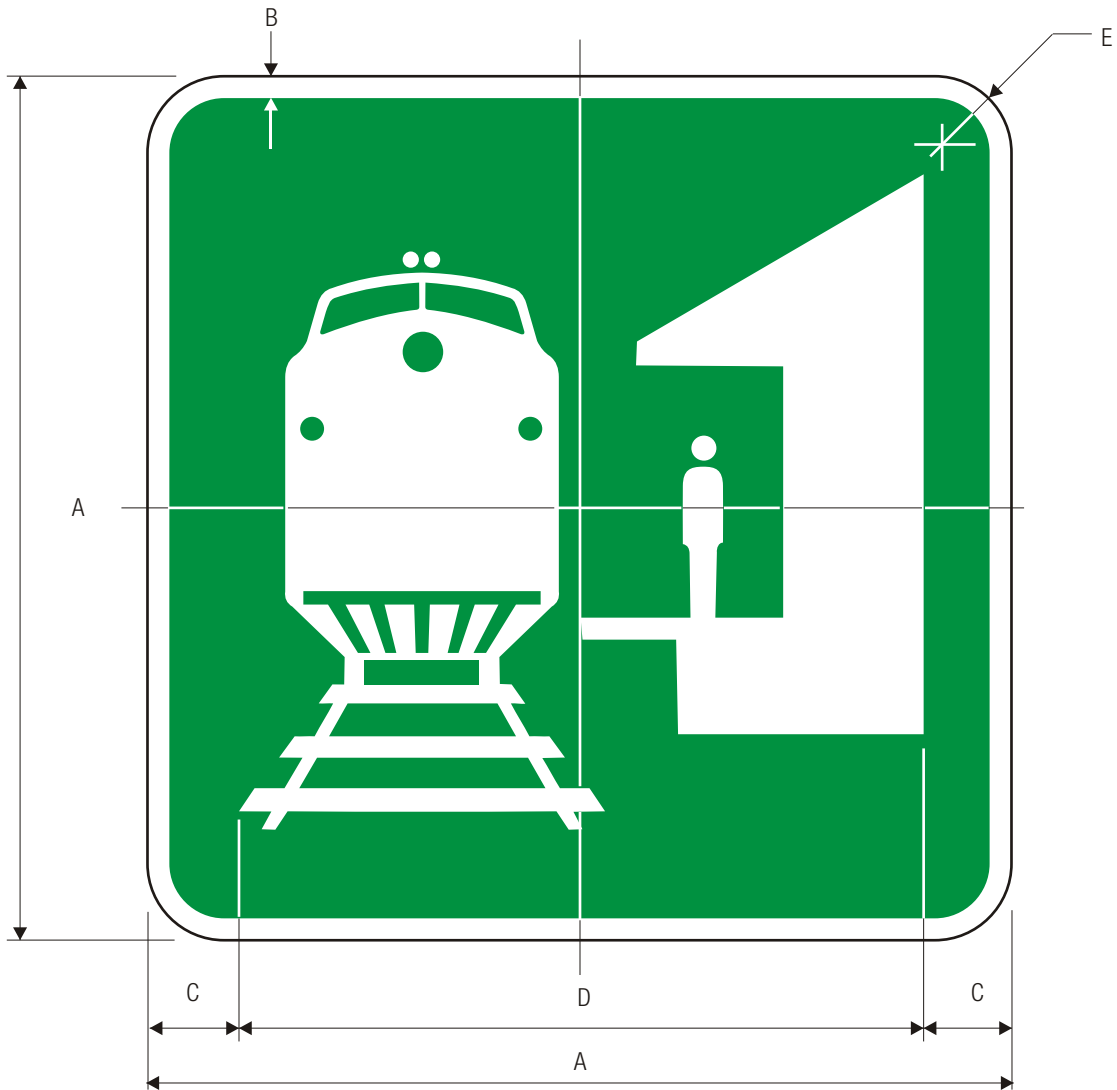

I-7
TRAIN STATION

*See page 6-54 for symbol design.

A	B	C	D	E
450	10	37	376	40
600	15	50	500	50
750	20	62	626	50

COLORS: SYMBOL WHITE (RETROREFLECTIVE)
BACKGROUND GREEN (RETROREFLECTIVE)

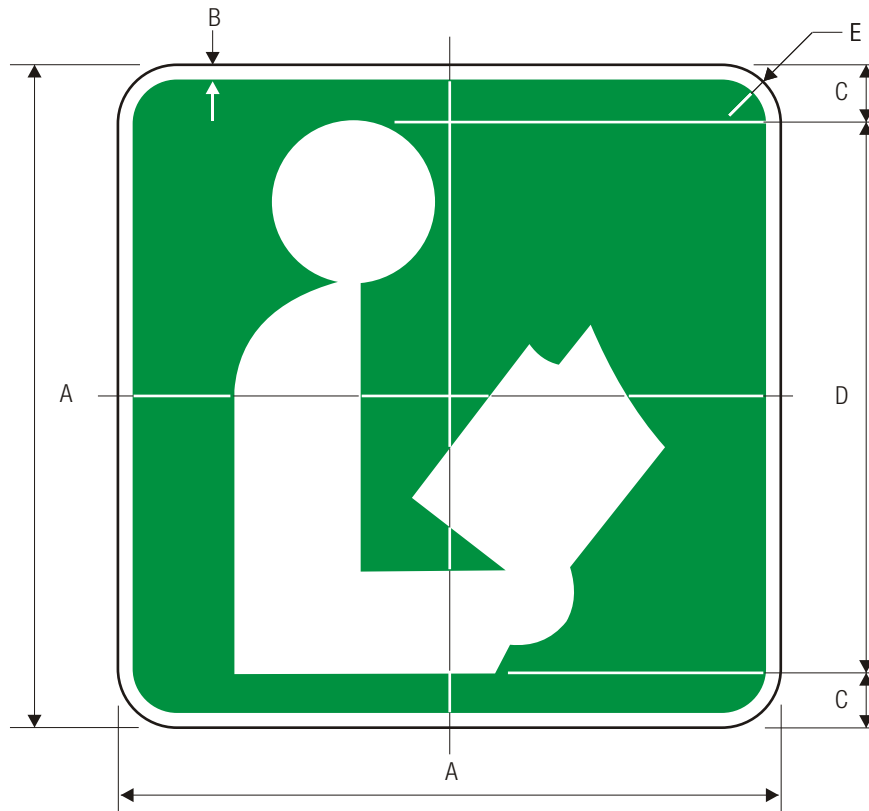

I-8

*See page 6-55 for symbol design.

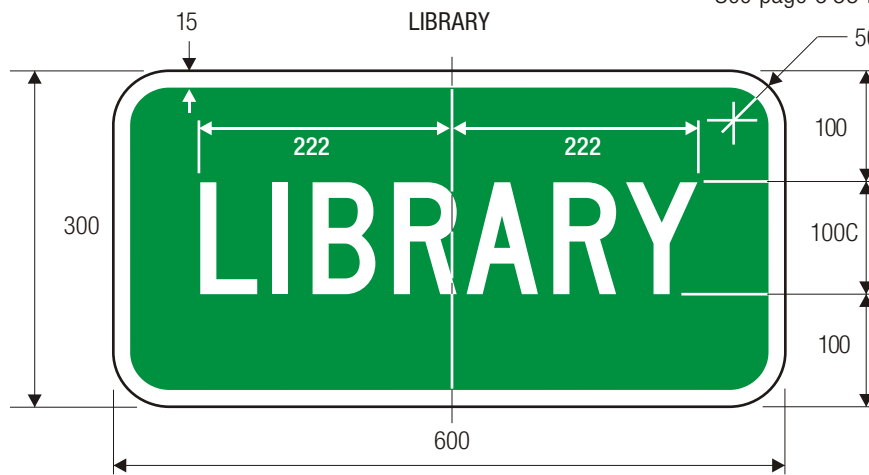

I-8p

LIBRARY

Smaller size panels may be used as applicable within terminal areas.

A	B	C	D	E
450	10	37	376	40
600	15	50	500	50
750	20	62	626	50

COLORS: SYMBOL WHITE (RETROREFLECTIVE)
 LEGEND WHITE (RETROREFLECTIVE)
 BACKGROUND GREEN (RETROREFLECTIVE)



I-11
RECYCLING

*See page 6-14 for symbol design.

COLORS: LEGEND WHITE (RETROREFLECTIVE)
 BACKGROUND GREEN (RETROREFLECTIVE)

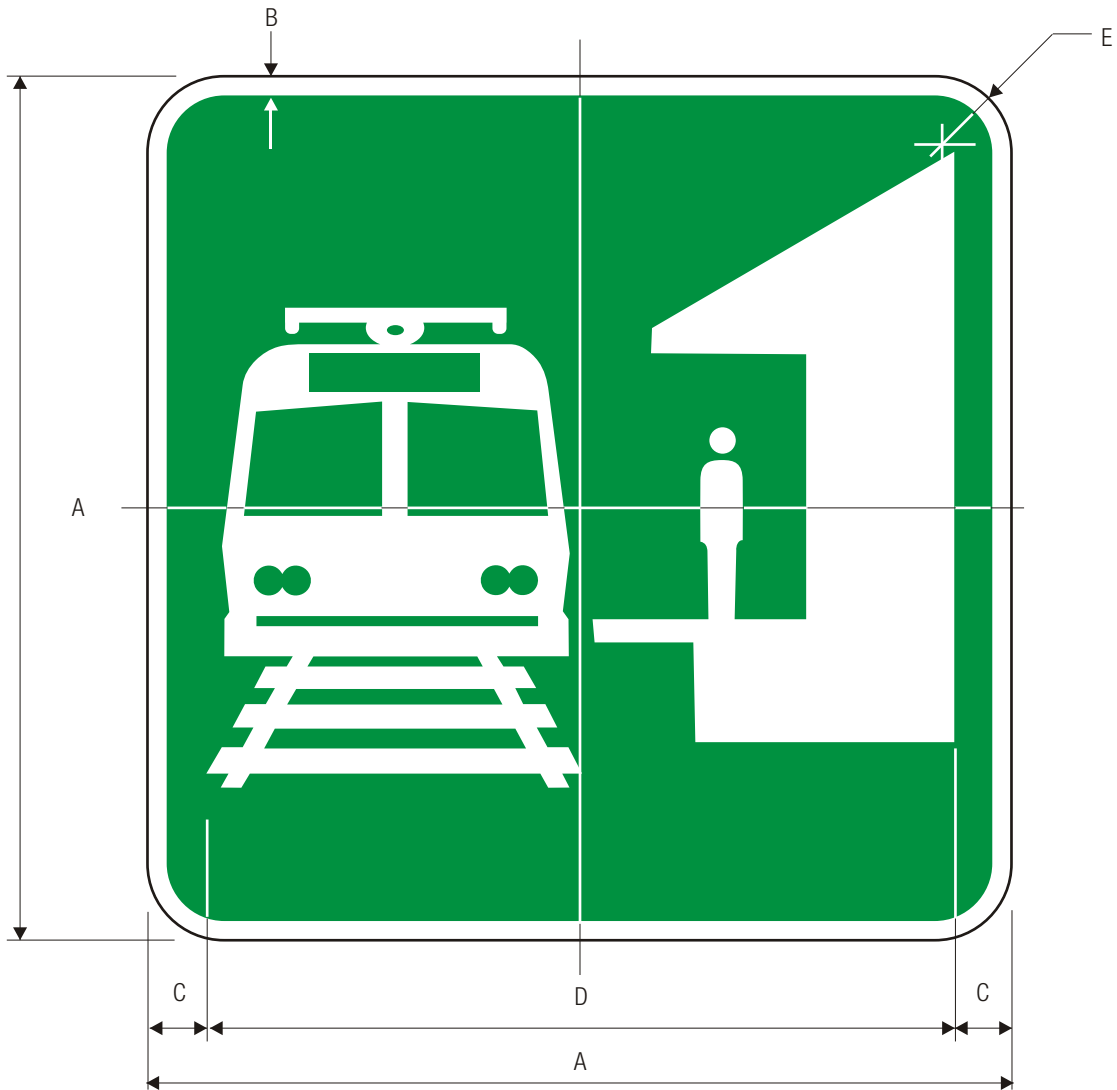

I-12
LIGHT RAIL STATION

*See page 6-18 for symbol design.

A	B	C	D	E
450	10	30	390	40
600	15	41	518	50
750	20	51	648	50

COLORS: SYMBOL WHITE (RETROREFLECTIVE)
BACKGROUND GREEN (RETROREFLECTIVE)

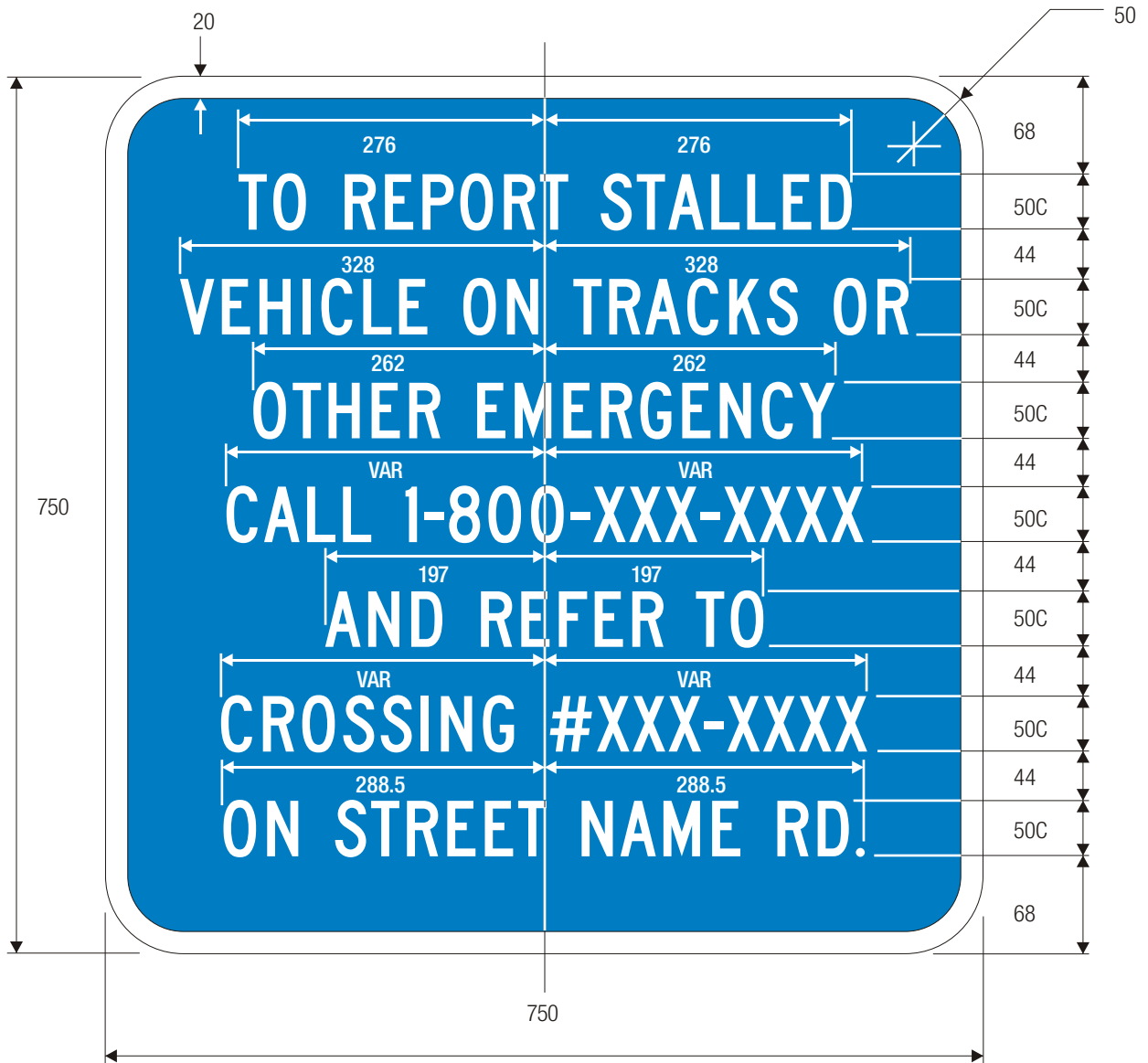

I-13

LIGHT RAIL STATION

*See page 6-18 for symbol design.

COLORS: LEGEND WHITE (RETROREFLECTIVE)
 BACKGROUND BLUE (RETROREFLECTIVE)

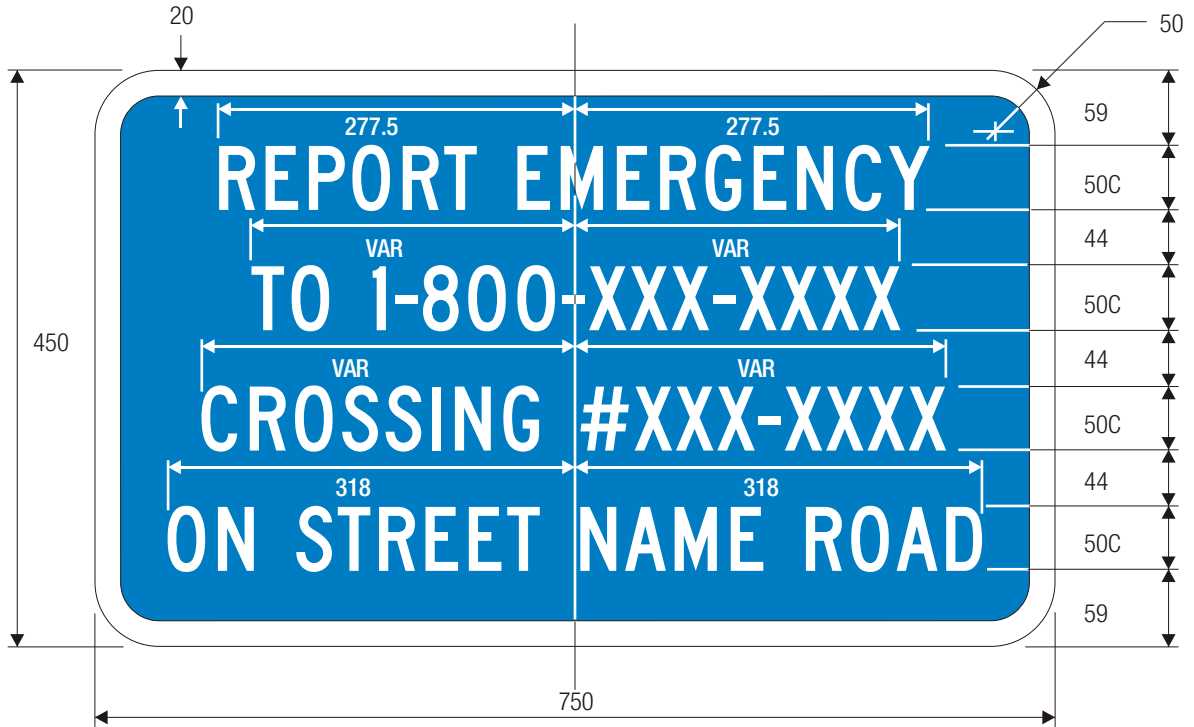

I-13a

EMERGENCY NOTIFICATION

COLORS: LEGEND WHITE (RETROREFLECTIVE)
 BACKGROUND BLUE (RETROREFLECTIVE)

MOTORIST SERVICES SYMBOL SIGN

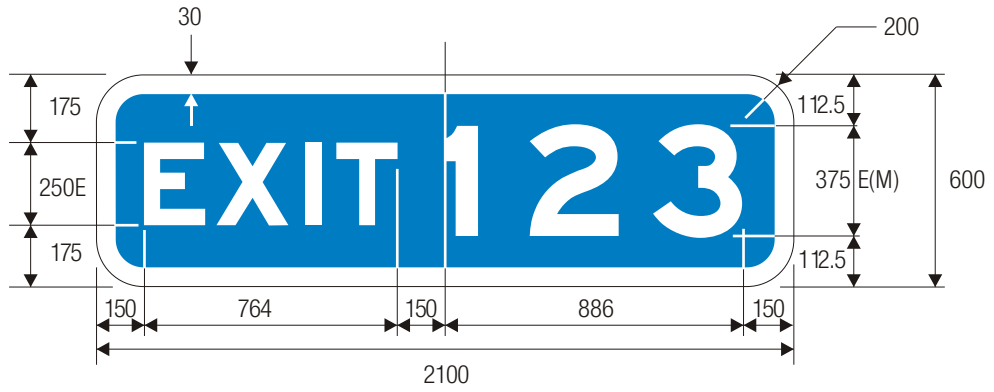

E1-5

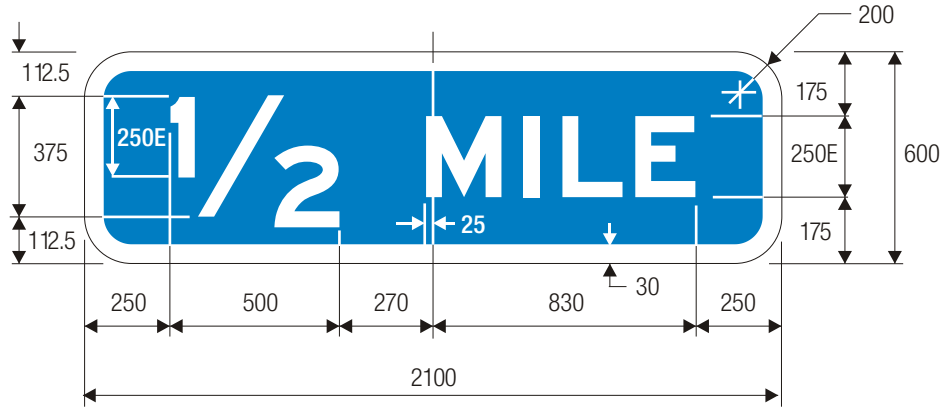

E2-3
ENGLISH

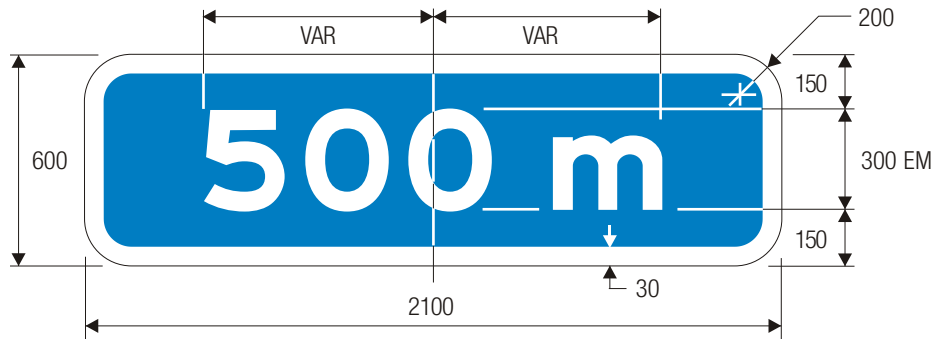

E2-3
METRIC

COLORS: LEGEND — WHITE (RETROREFLECTIVE)
BACKGROUND — BLUE (RETROREFLECTIVE)

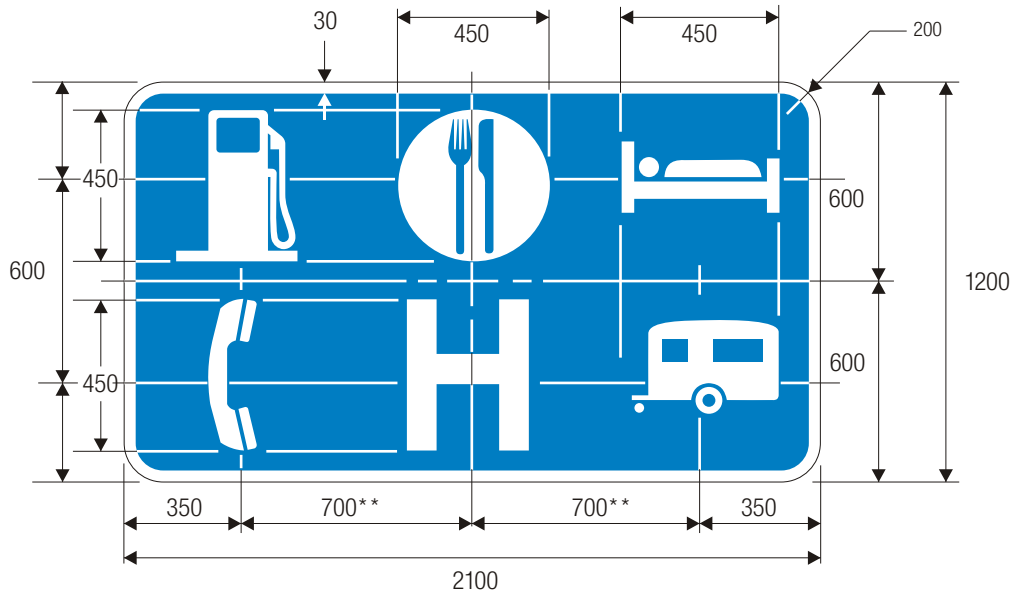

D9-18

MOTORIST SERVICES SIGNS

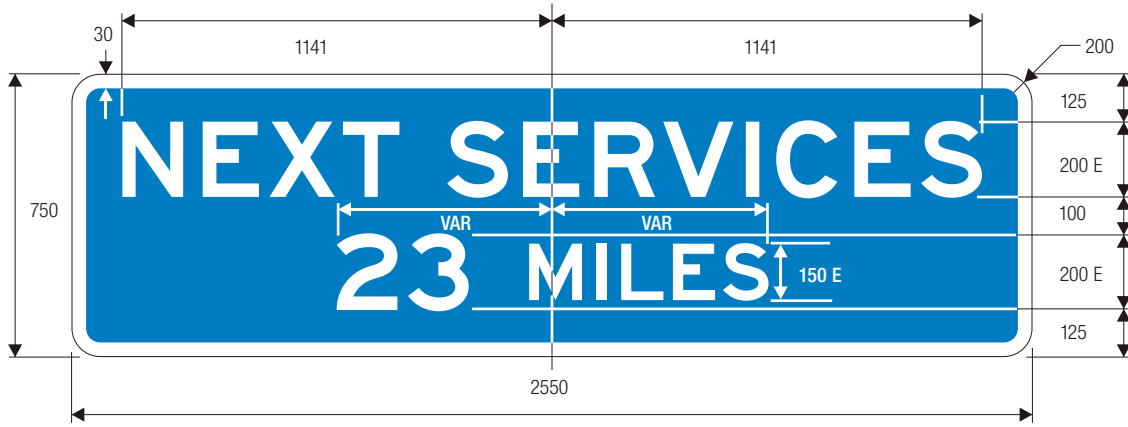

D9-17

*Series 2000 Standard Alphabets.

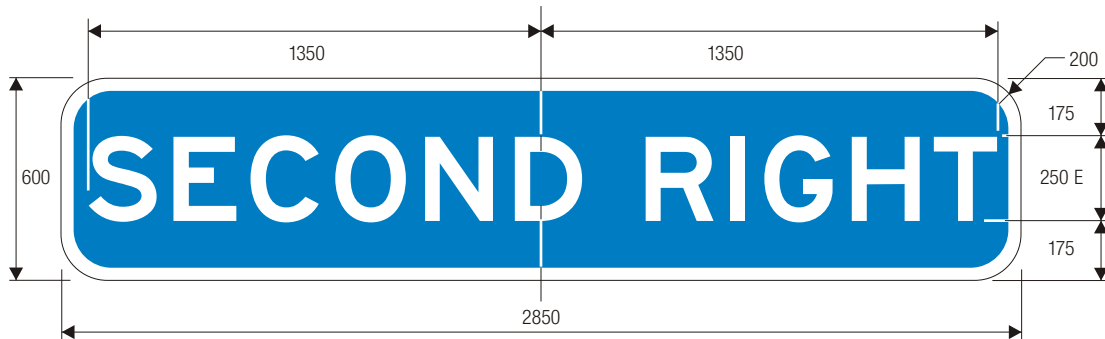

E2-2

COLORS: LEGEND — WHITE (RETROREFLECTIVE)
 BACKGROUND — BLUE (RETROREFLECTIVE)

MOTORIST SERVICES SIGNS

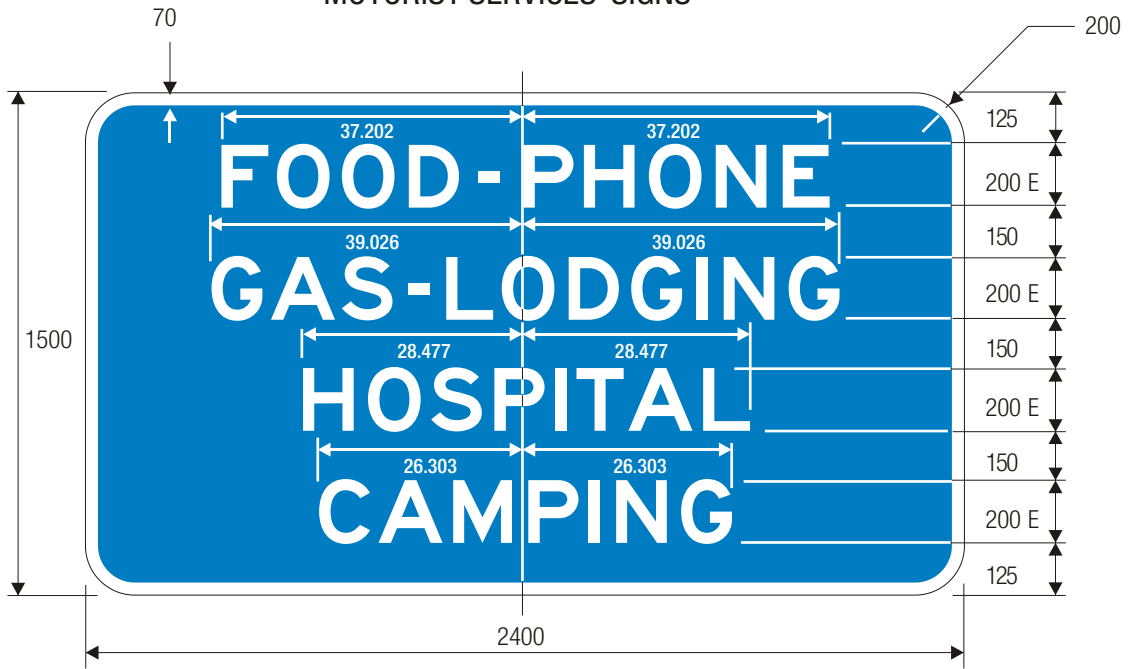

D9-18a

*Series 2000 Standard Alphabets.

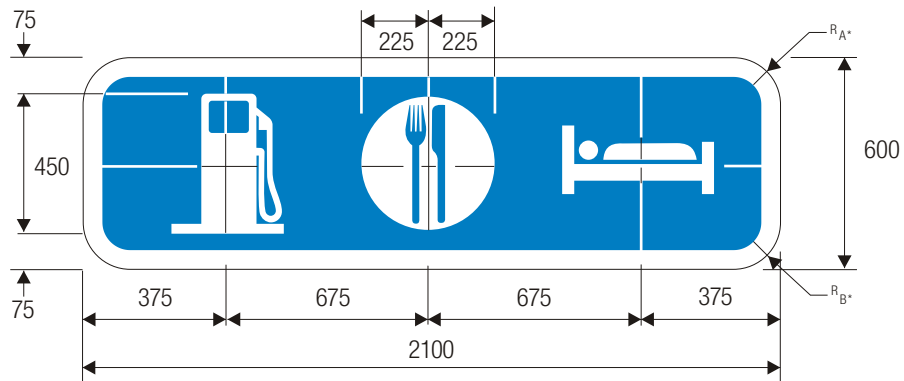

D9-18b

See Appendix 6 for Motorist Service Symbols.

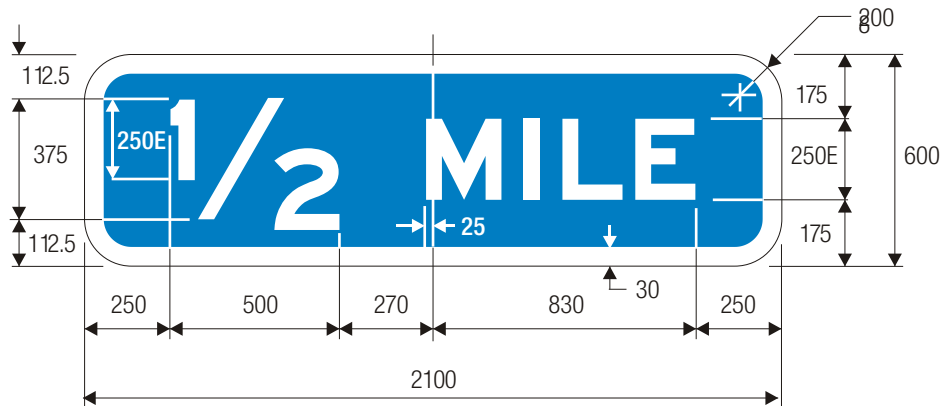

E2-3

ENGLISH

COLORS: LEGEND — WHITE (RETROREFLECTIVE)
BACKGROUND— BLUE (RETROREFLECTIVE)

MOTORIST SERVICES SIGNS

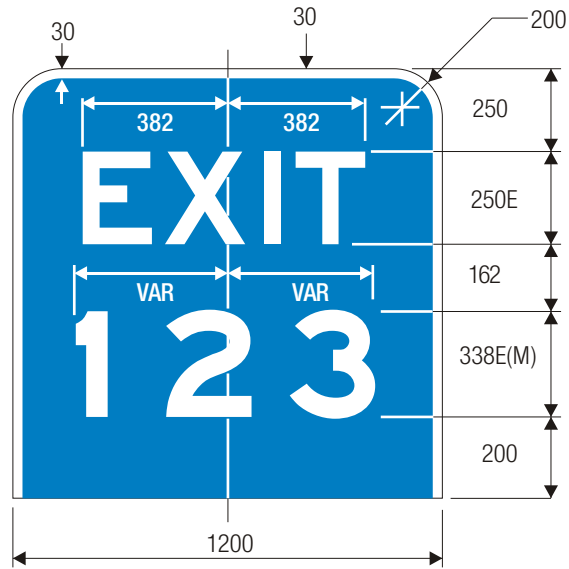

E1-5

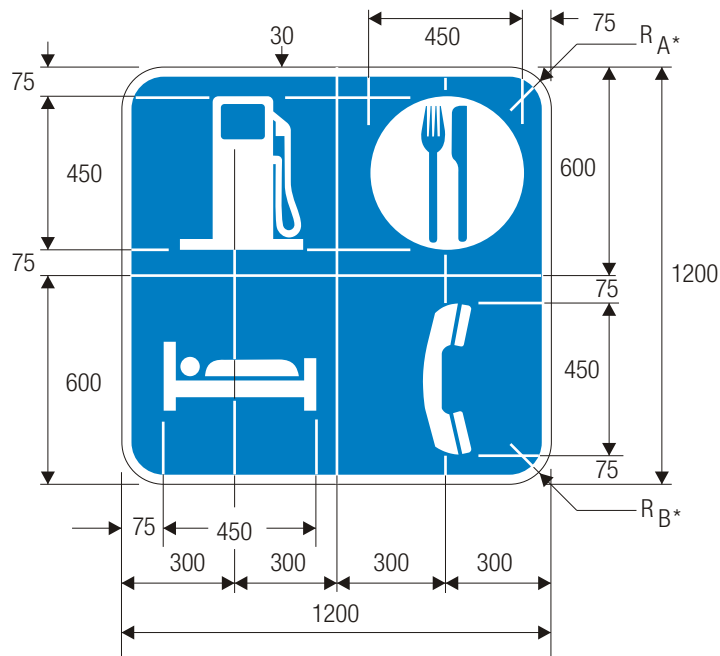

D9-18c

COLORS: LEGEND — WHITE (RETROREFLECTIVE)
 BACKGROUND— BLUE (RETROREFLECTIVE)

MOTORIST SERVICES SYMBOL SIGN



D9-18c

COLORS: LEGEND — WHITE (RETROREFLECTIVE)
BACKGROUND — BLUE (RETROREFLECTIVE)

Recreation and Cultural Interest Area Signs



RG-010
AUTOMOBILE

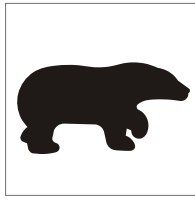

RG-020
BEAR VIEWING AREA

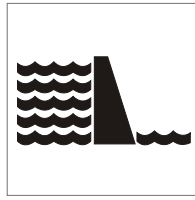

RG-030
DAM

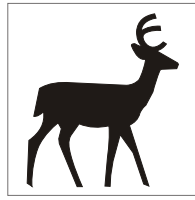

RG-040
DEER VIEWING AREA



RG-050
DRINKING WATER



RG-060
ENVIRONMENTAL STUDY



RG-070
FALLING ROCK

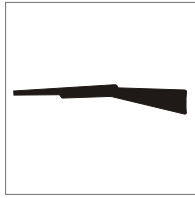

RG-080
FIREARMS

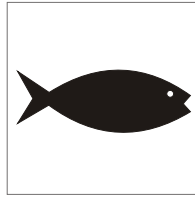

RG-090
FISH HATCHERY



RG-100
INFORMATION



RG-110
LEASHED PETS



RG-120
LIGHTHOUSE



RG-130
LITTER CONTAINER

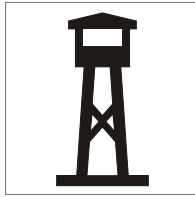

RG-140
LOOKOUT TOWER



RG-150
PEDESTRIAN CROSSING

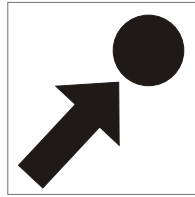

RG-160
POINT OF INTEREST



RG-170
RANGER STATION



RG-180
SMOKING



RG-190
TRUCK



RG-200
TUNNEL

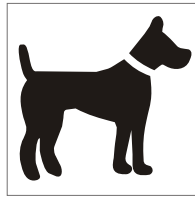

RG-240
DOG

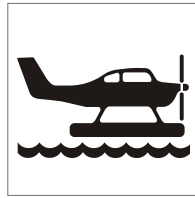

RG-260
SEAPLANE

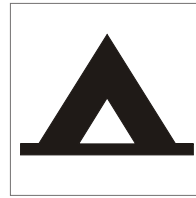

RM-010
CAMPING (TENT)



RM-020
CAMPING (TRAILER)



RM-030
FERRY

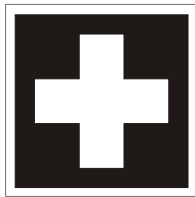

RM-040
FIRST AID

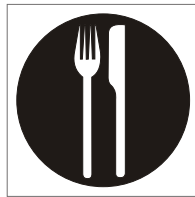

RM-050
FOOD



RM-060
GAS

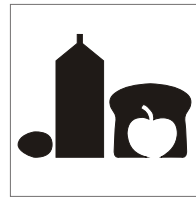

RM-070
GROCERY STORE



RM-080
HANDICAPPED



RM-090
LODGING

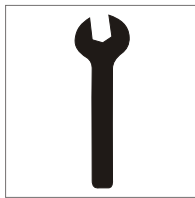

RM-100
MECHANIC

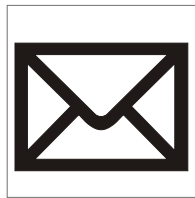

RM-110
POST OFFICE

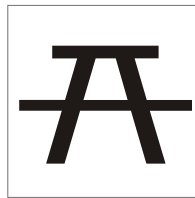

RM-120
PICNIC AREA



RM-130
PICNIC SHELTER



RM-140
REST ROOM

Recreation and Cultural Interest Area Signs



RM-150
TELEPHONE

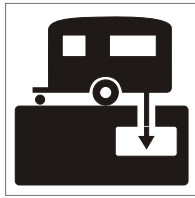

RM-160
SANITARY STATION

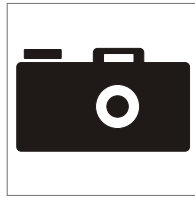

RM-170
VIEWING AREA



RM-200
MOTOR HOME

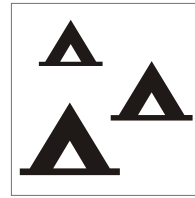

RM-210
GROUP CAMPING

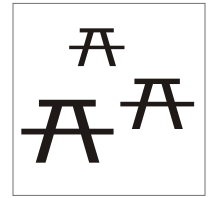

RM-220
GROUP PICNICKING



RA-010
AIRPORT



RA-020
BUS STOP



RA-030
CAMPFIRE



RA-040
ELEVATOR



RA-050
KENNEL

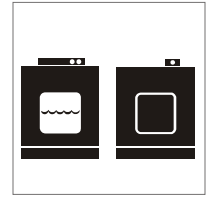

RA-060
LAUNDRY



RA-070
LOCKER

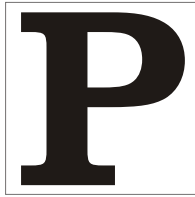

RA-080
PARKING



RA-090
REST ROOM (MEN)



RA-100
REST ROOM (WOMEN)



RA-110
SHELTER (SLEEPING)

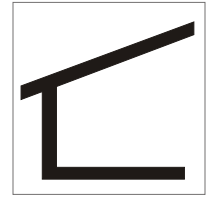

RA-120
SHELTER (TRAIL)

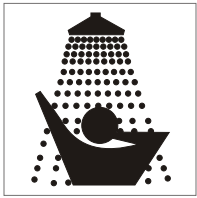

RA-130
SHOWERS

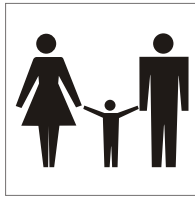

RA-150
FAMILY REST ROOM

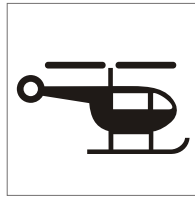

RA-160
HELICOPTER

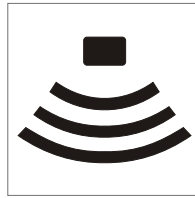

RL-010
AMPHITHEATER



RL-020
CLIMBING



RL-030
CLIMBING (ROCK)



RL-040
HUNTING

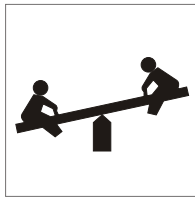

RL-050
PLAYGROUND



RL-060
ROCK COLLECTING



RL-070
SPELUNKING

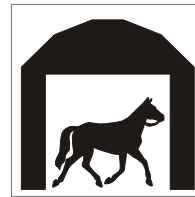

RL-080
STABLE



RL-090
TRAIL (BICYCLE)



RL-100
TRAIL (HIKING)

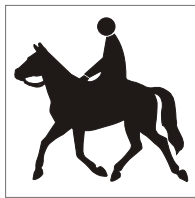

RL-110
TRAIL (HORSE)

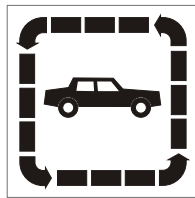

RL-120
TRAIL (AUTO)

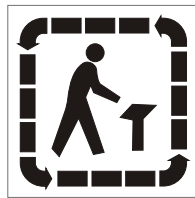

RL-130
TRAIL (PEDESTRIAN)

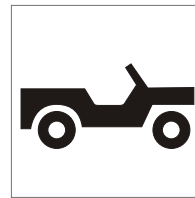

RL-140
TRAIL (4WD)



RL-150
TRAIL (BIKE)

Recreation and Cultural Interest Area Signs



RL-160
TRAMWAY



RL-170
ATV



RL-190
ARCHER



RL-210
HANG GLIDER

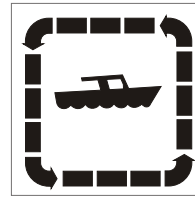

RW-010
BOAT TOURS



RW-020
CANOEING



RW-030
DIVING

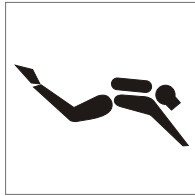

RW-040
DIVING (SCUBA)

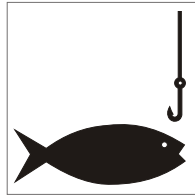

RW-050
FISHING



RW-060
MARINA

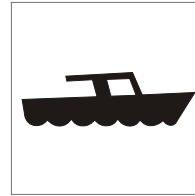

RW-070
MOTORBOATING

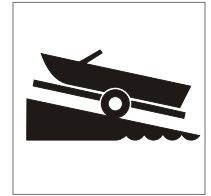

RW-080
RAMP (LAUNCH)



RW-090
ROWBOATING

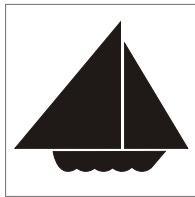

RW-100
SAILBOATING



RW-110
SKIING (WATER)



RW-120
SURFING



RW-130
SWIMMING



RW-140
WADING



RW-160
FISHING PIER



RW-170
HAND LAUNCH



RW-190
KAYAK



RW-210
WIND SURF



RS-010
SKATING (ICE)



RS-020
SKI JUMPING



RS-030
SKIING (BOBBING)



RS-040
SKI (CROSS COUNTRY)



RS-050
SKI (DOWNHILL)



RS-060
SLEDDING



RS-070
SNOWMOBILING



RS-080
SNOWSHOEING



RS-090
WINTER REC AREA



RS-100
SKI LIFT

EXAMPLES OF DESIGN APPLICATIONS
RECREATIONAL & CULTURAL INTEREST SIGNS

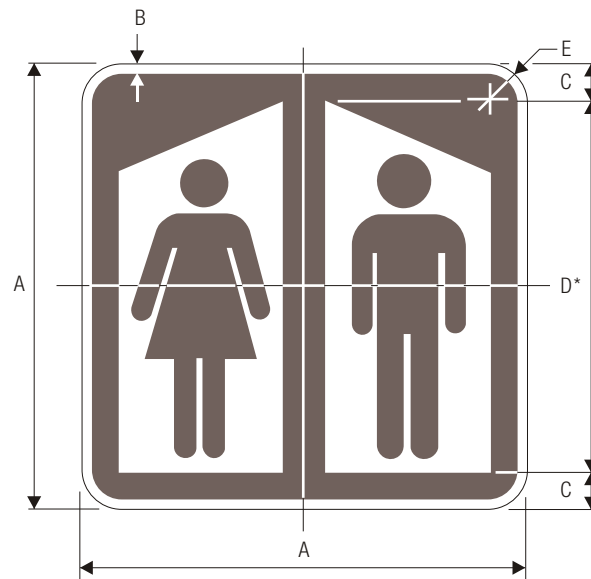

RM-140

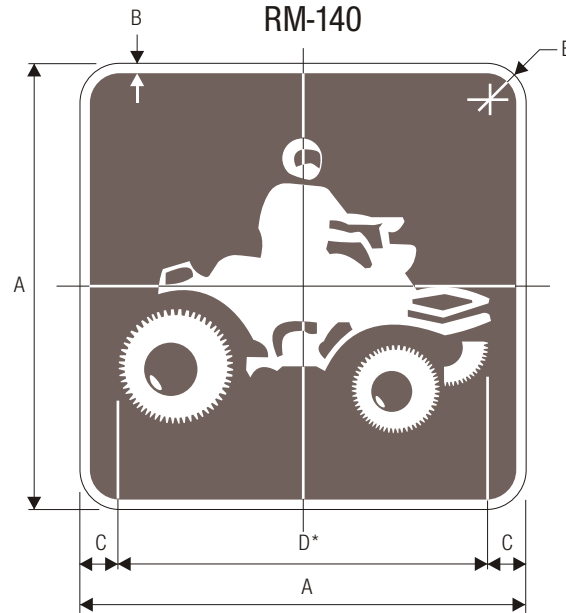

RL-170



* The largest dimension of most symbols should be about 83.5% of the total sign width. Symbols for showers, trailer sanitary stations, boat tours, interpretative trails, and climbing areas should extend near or into the sign border as shown in the grid layouts.

A	B	C	D	E	F
150	6	12	126	30	19
225	10	18	189	30	28
300	10	25	250	40	38
450	10	37	376	40	56
600	15	50	500	50	75
750	20	62	626	50	94

COLORS: SYMBOL – WHITE (RETROREFLECTIVE)
BACKGROUND – BROWN

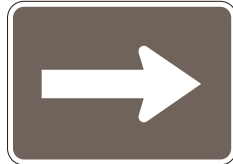

Recreational and Cultural Sign Array

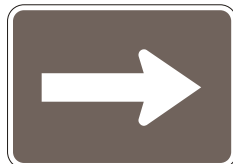
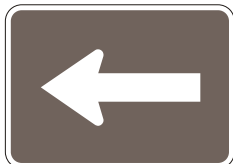

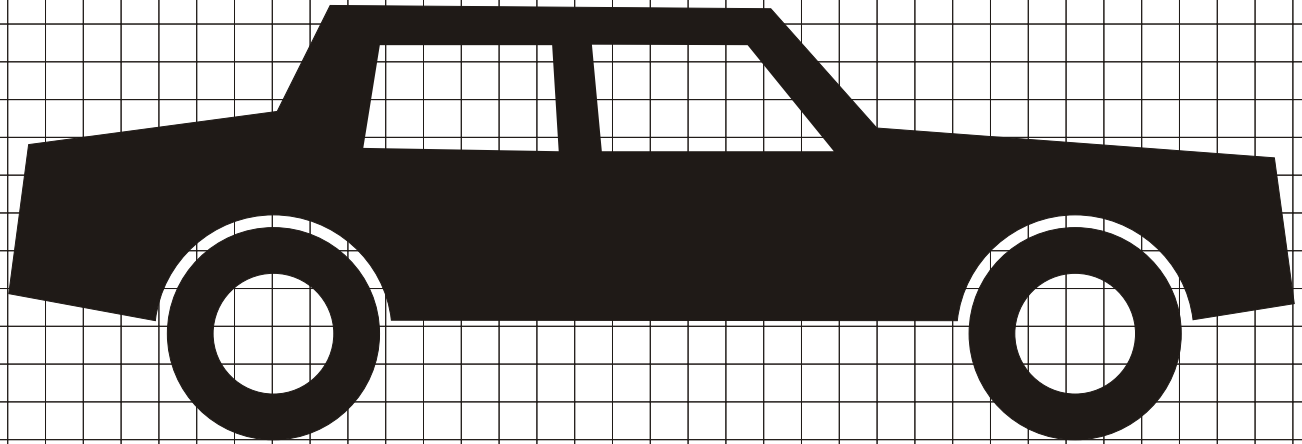

RG-010

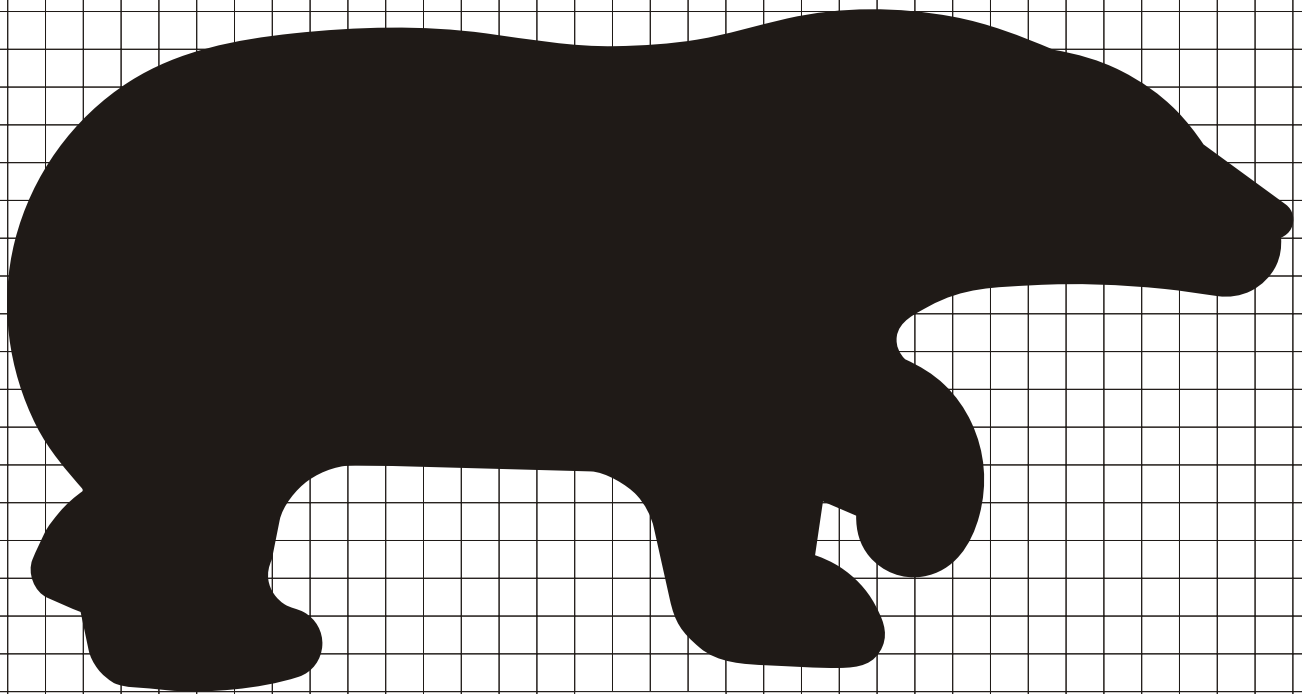

RG-020

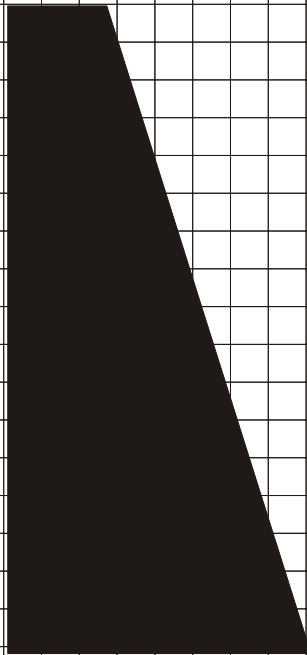
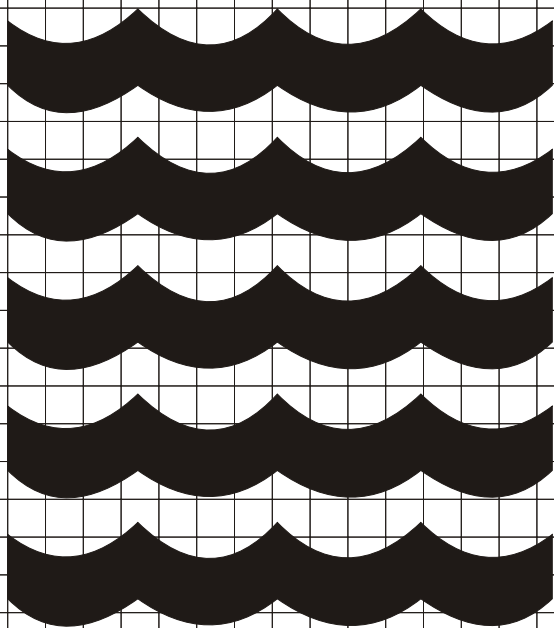

RG-030

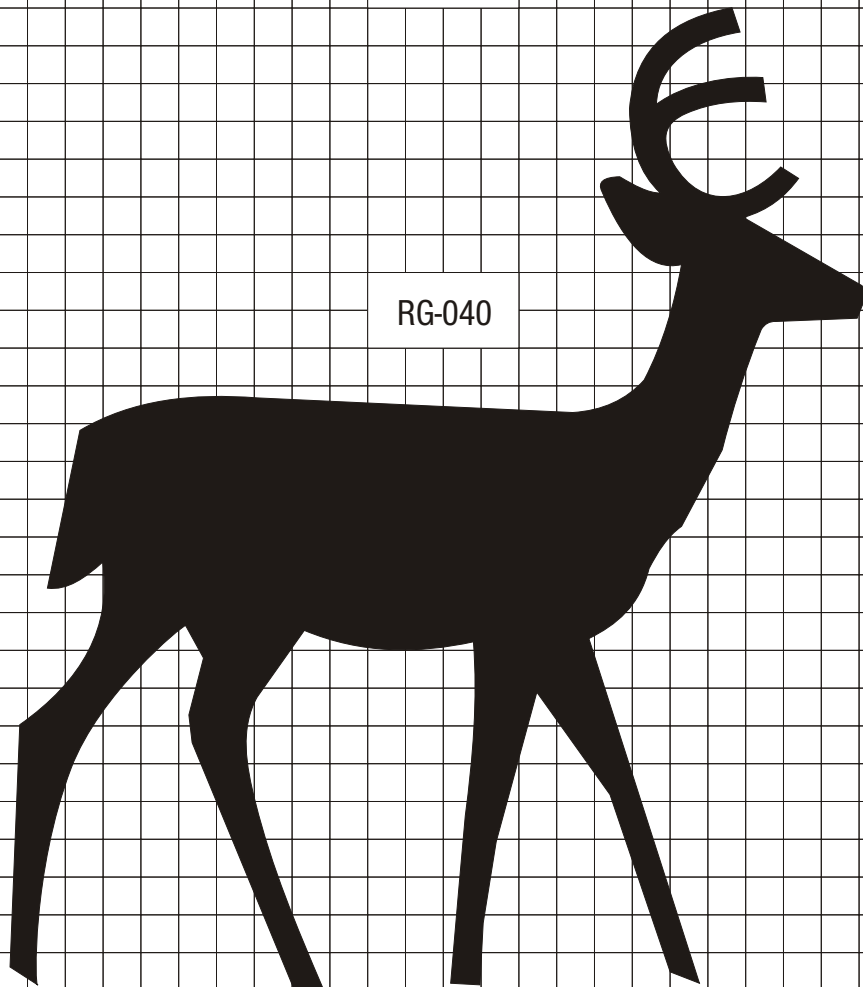

RG-040

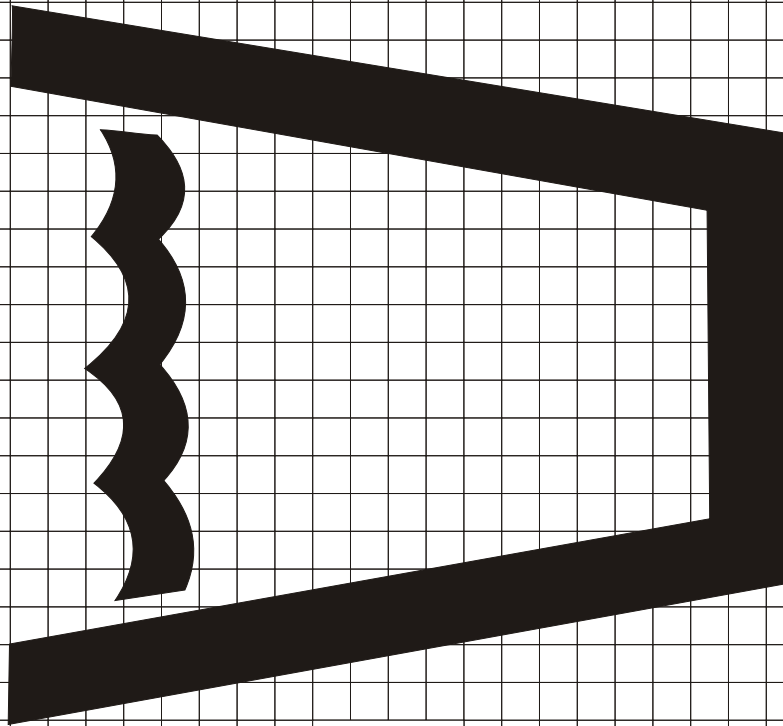

RG-050

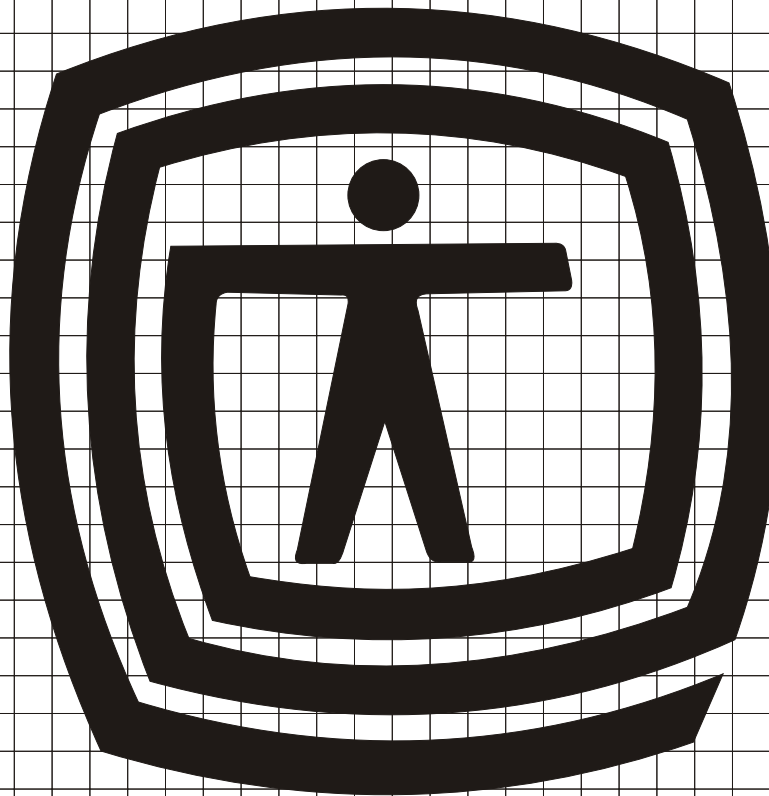

RG-060

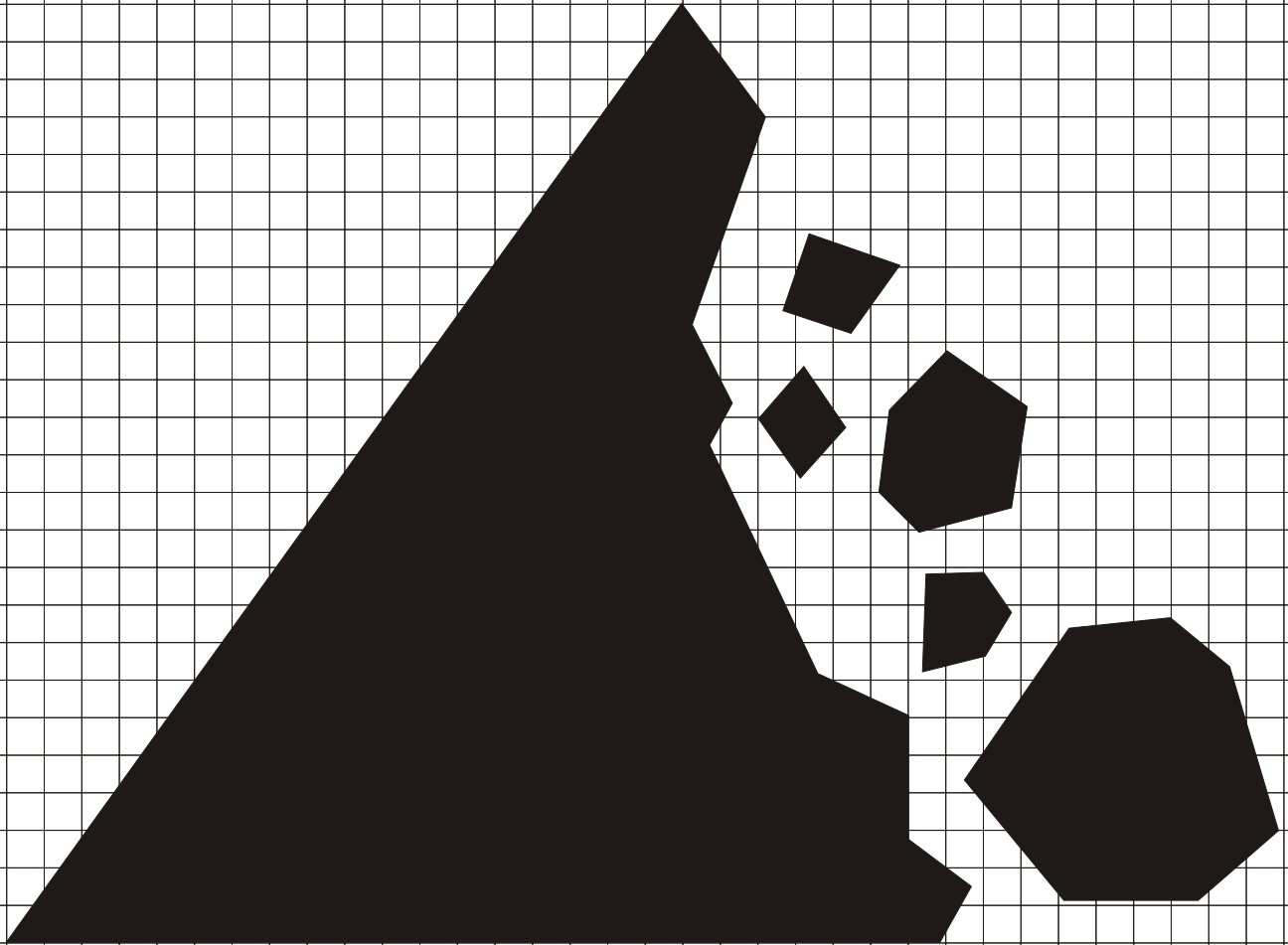

RG-070

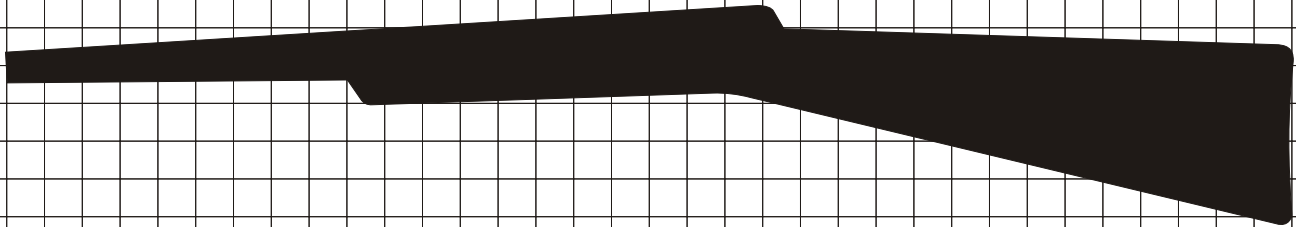

RG-080

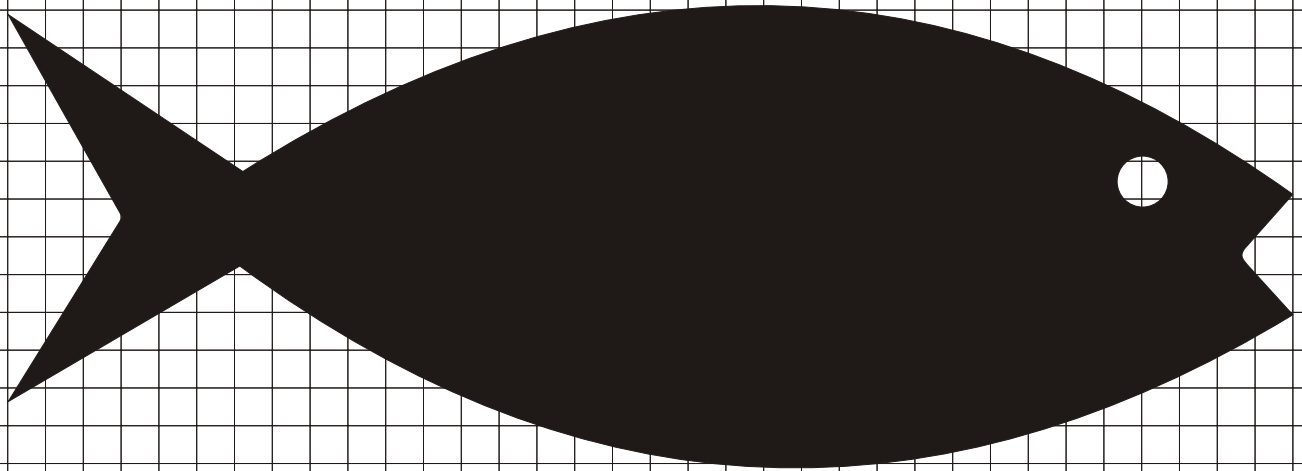

RG-090

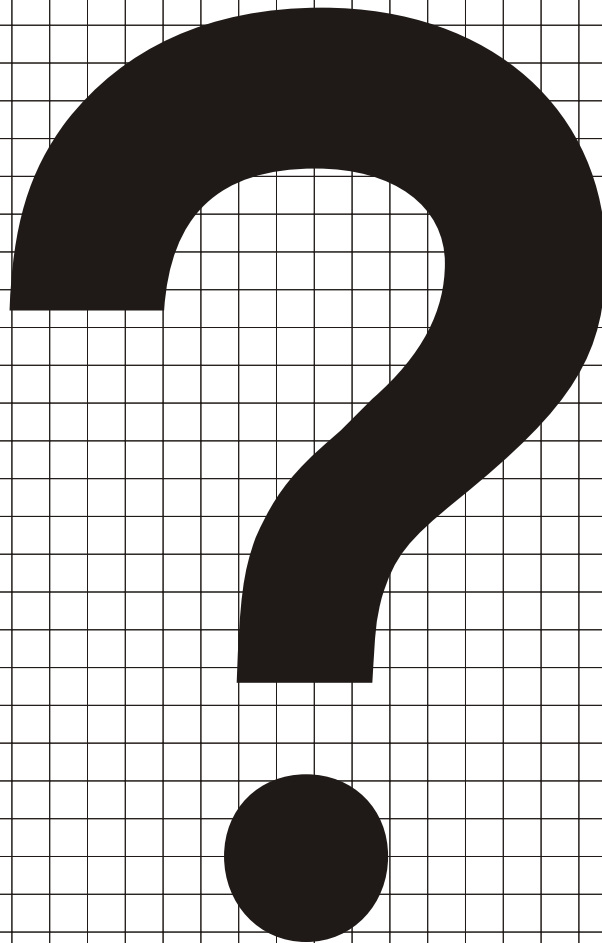

RG-100

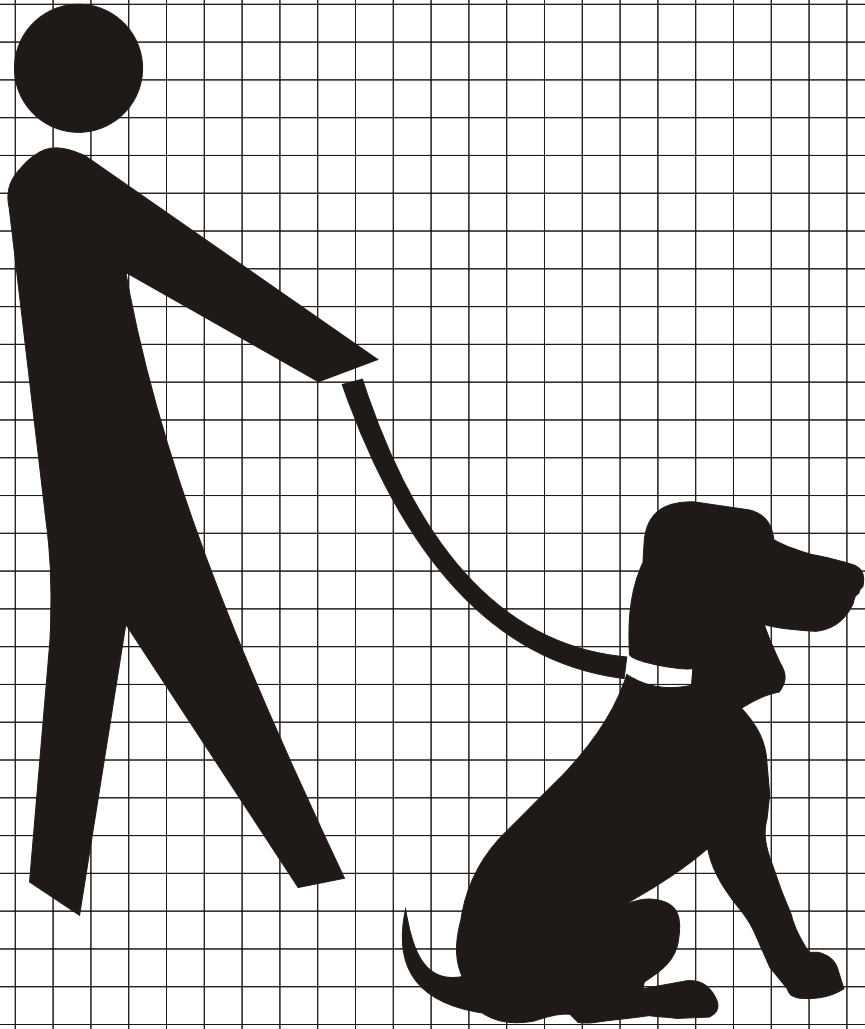

RG-110

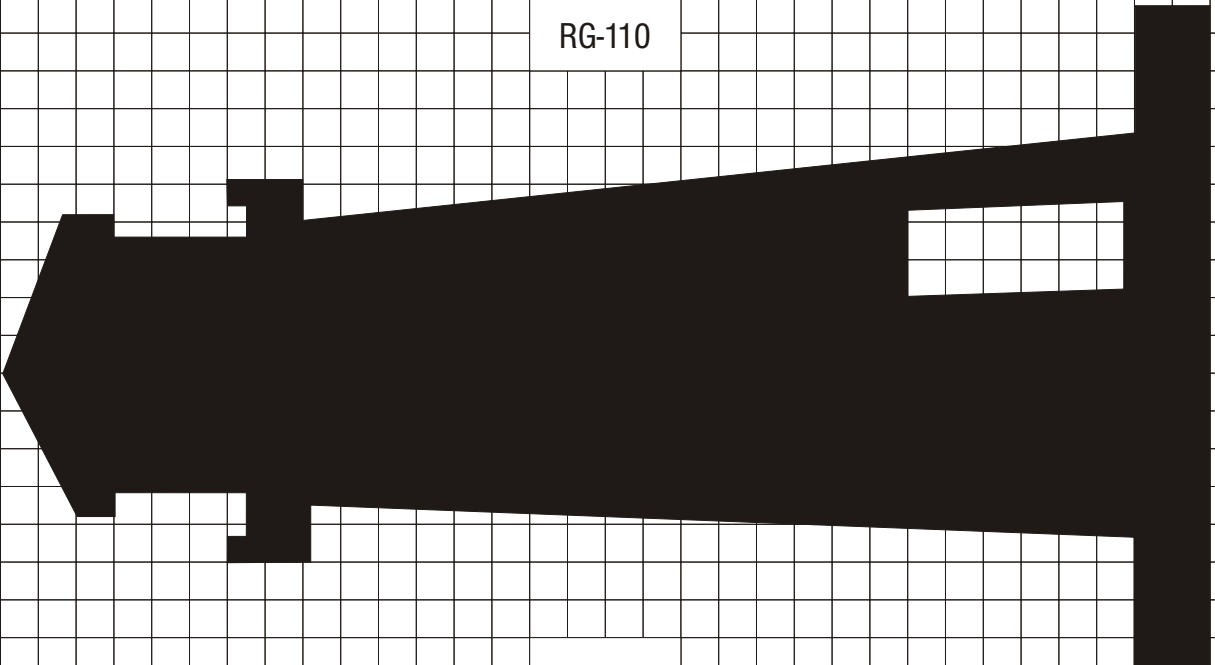

RG-120

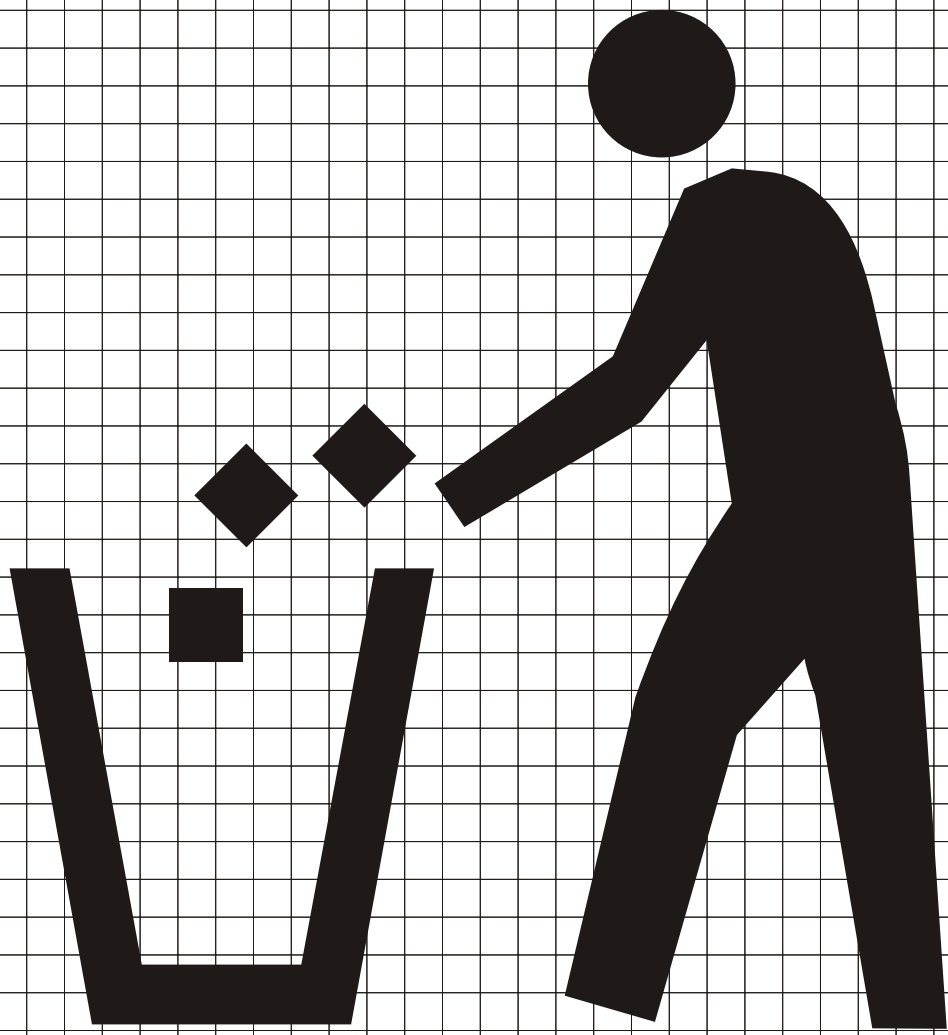

RG-130

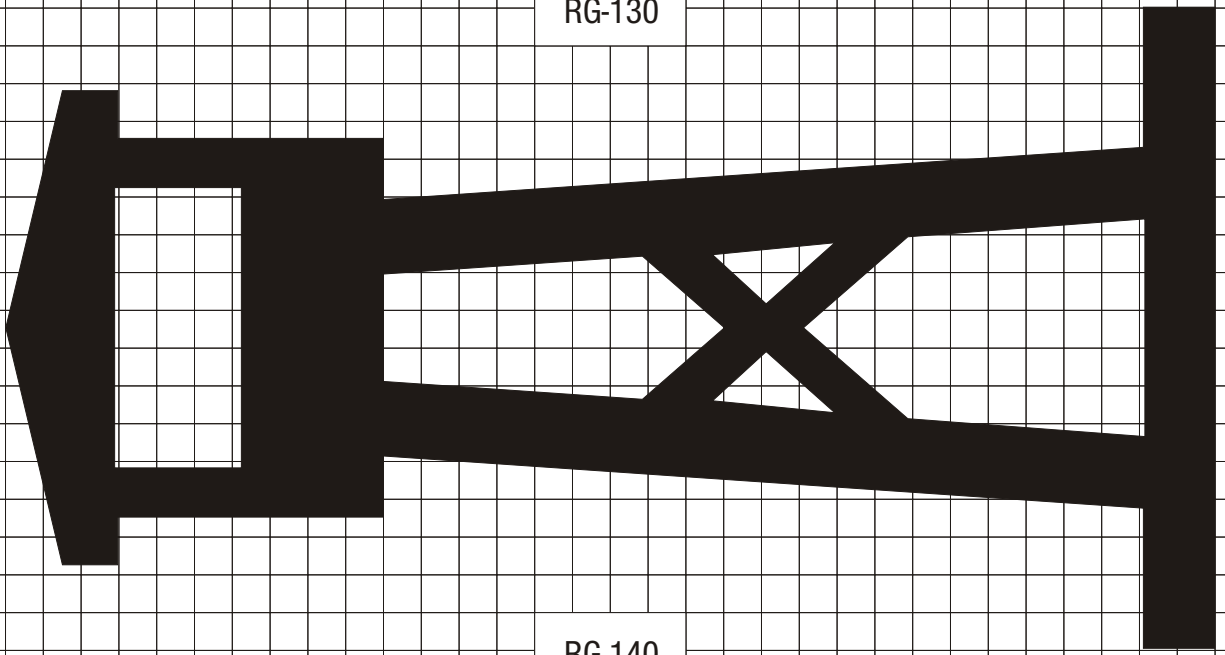

RG-140

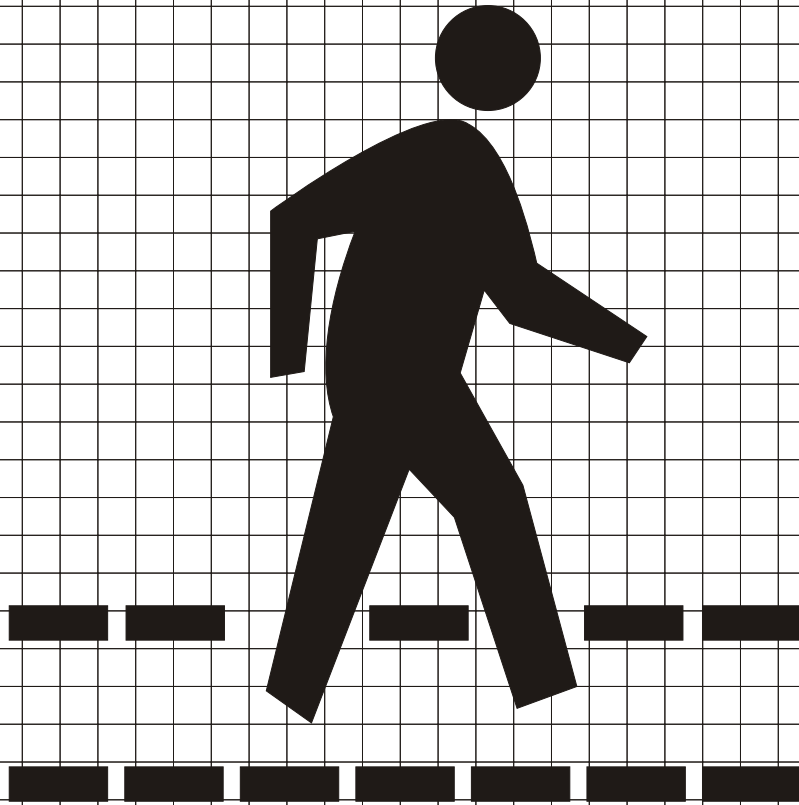

RG-150

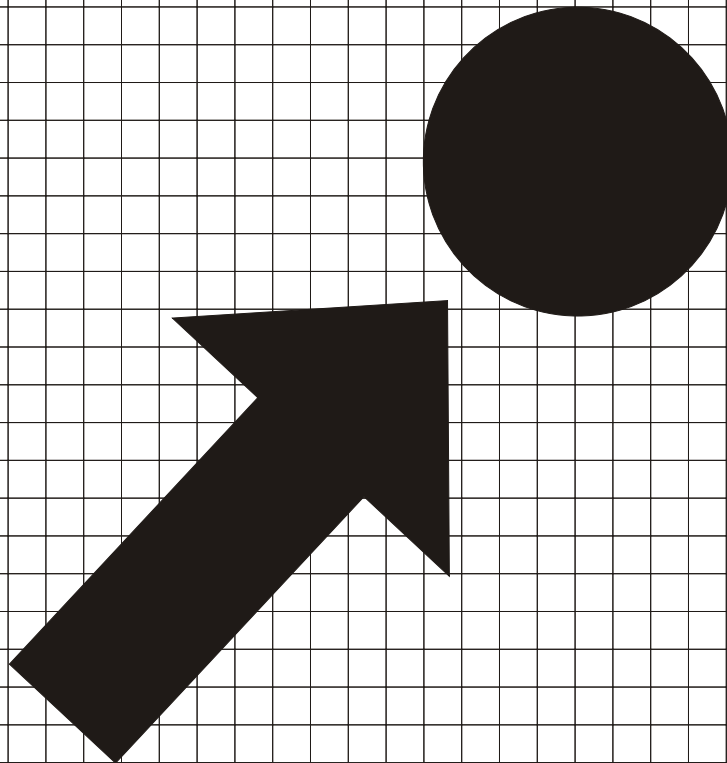

RG-160

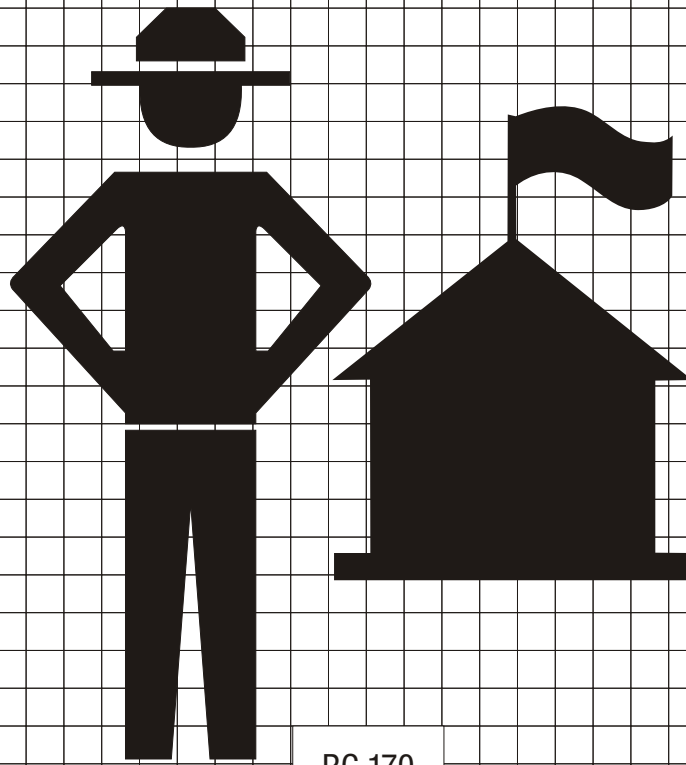

RG-170

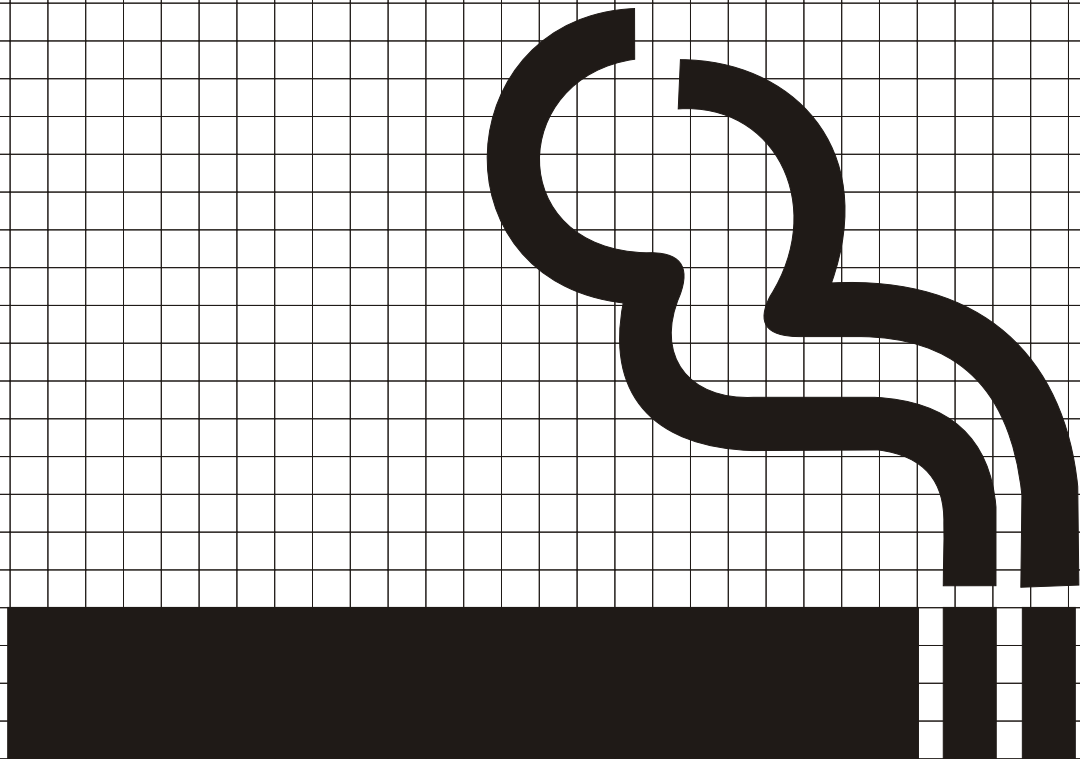

RG-180

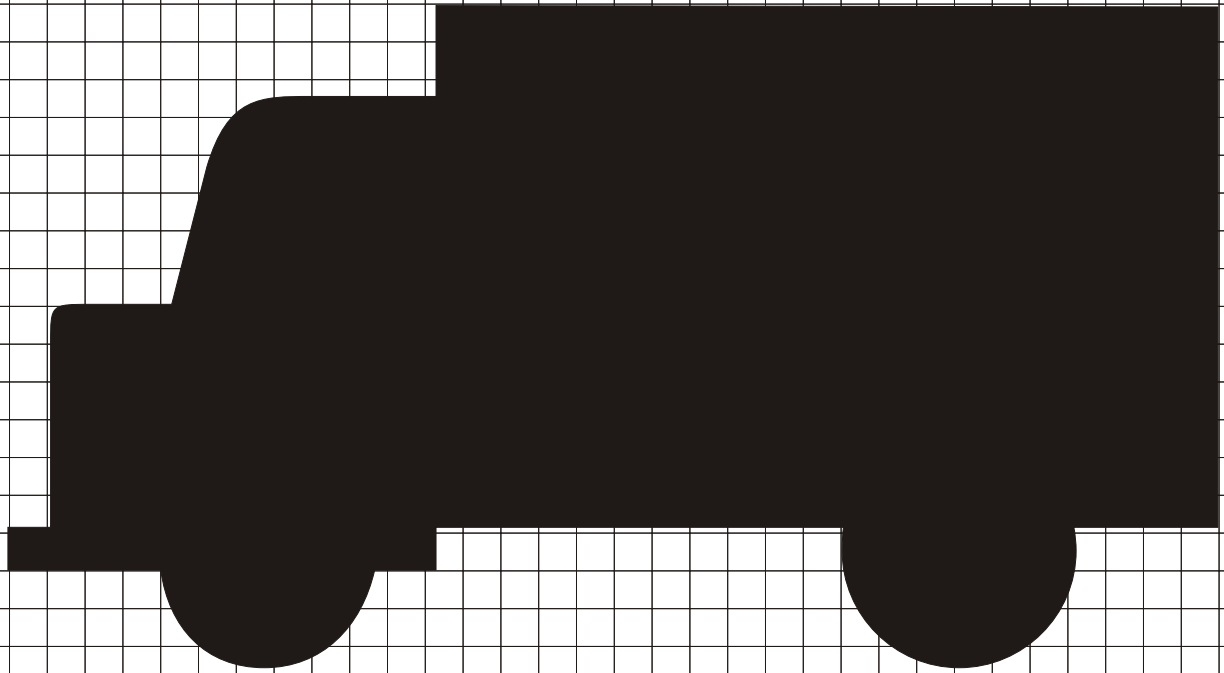

RG-190

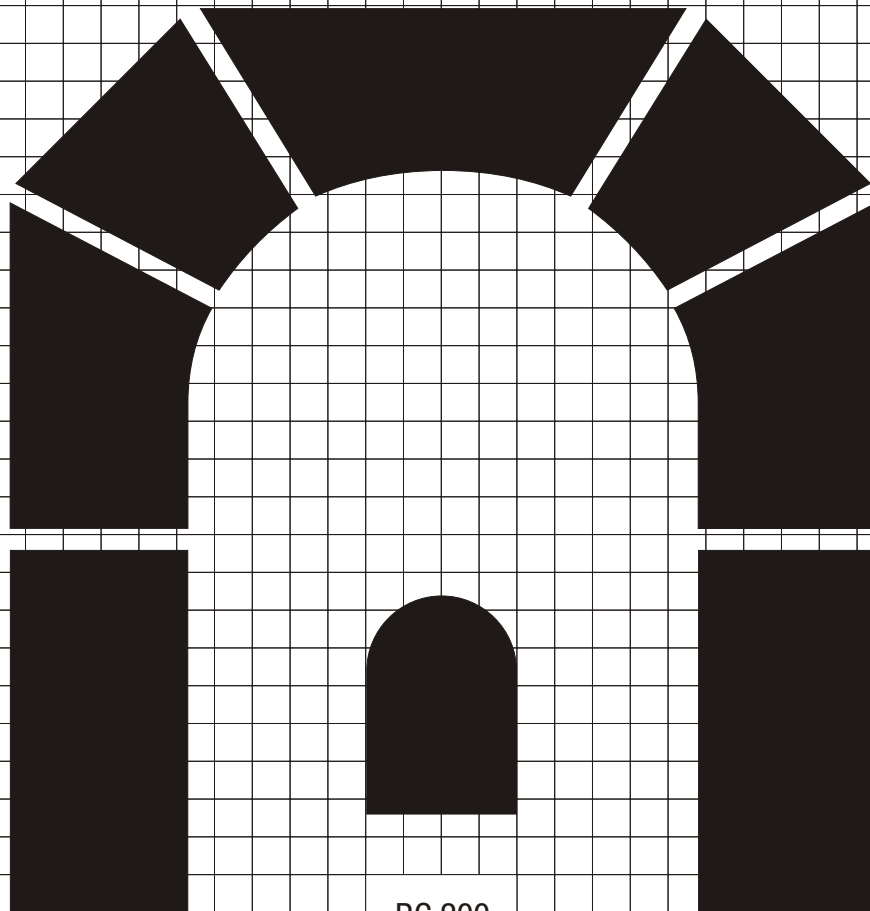

RG-200

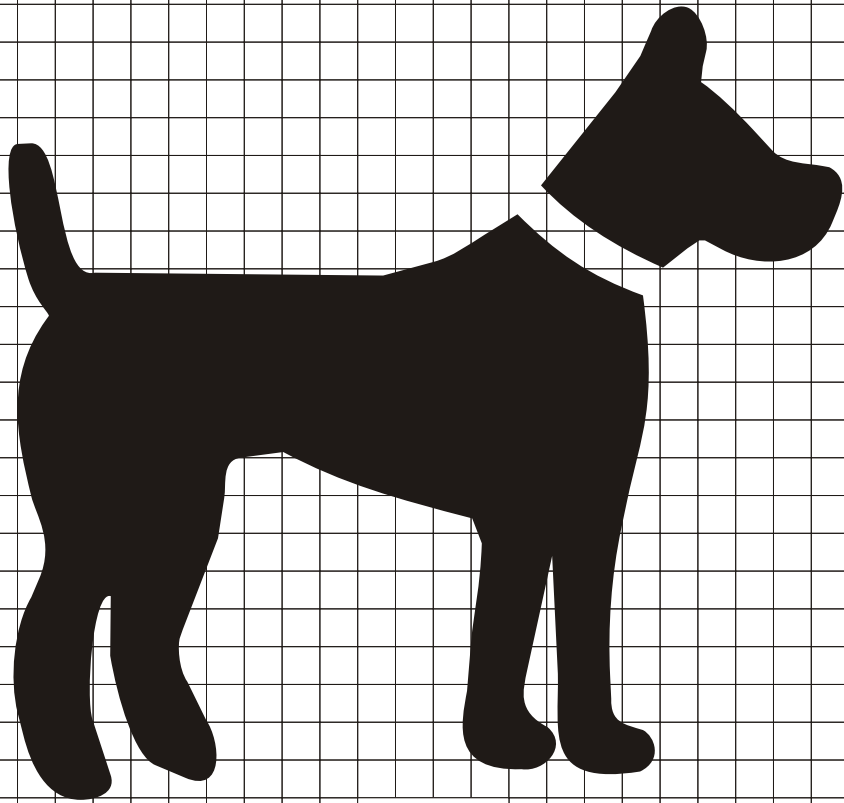

RG-240

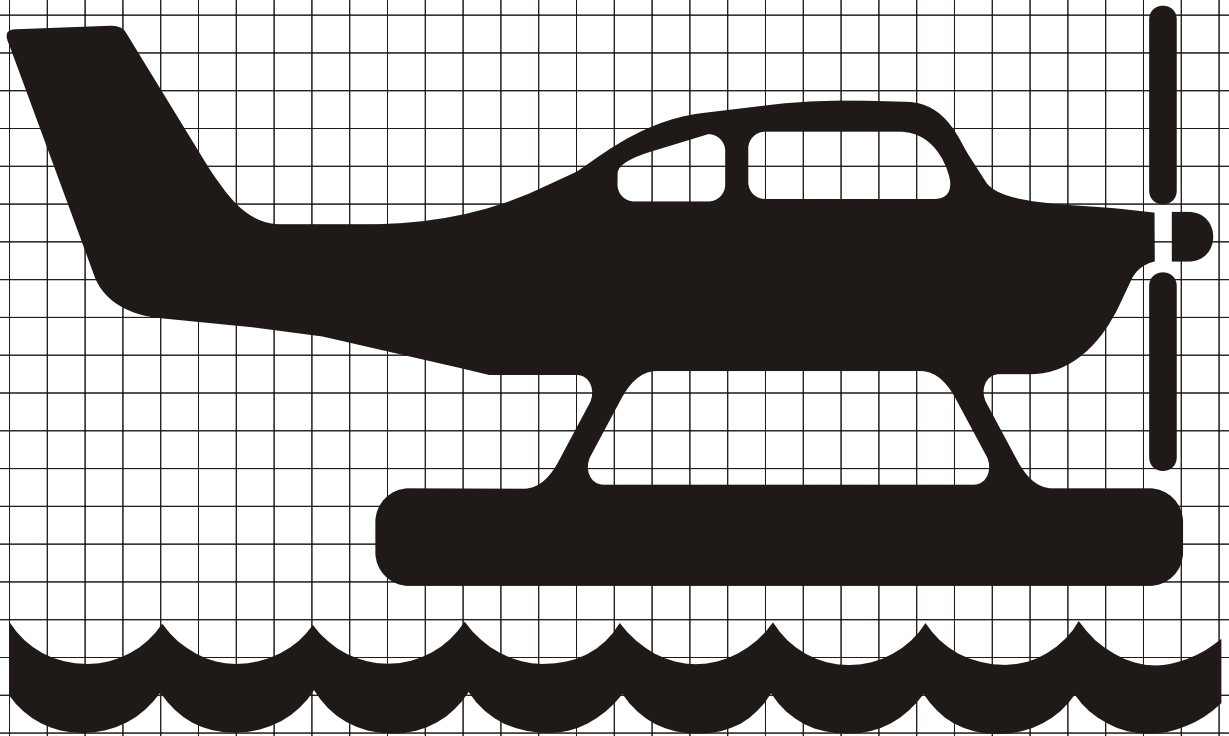

RG-260

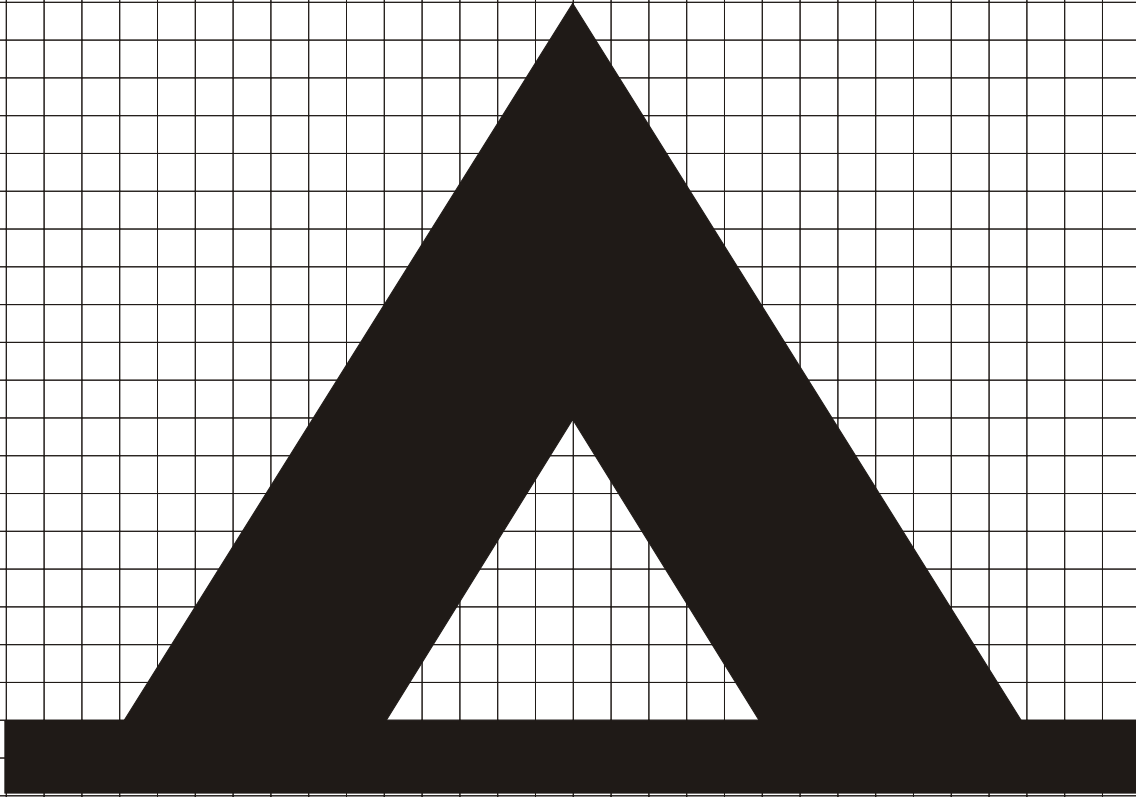

RM-010

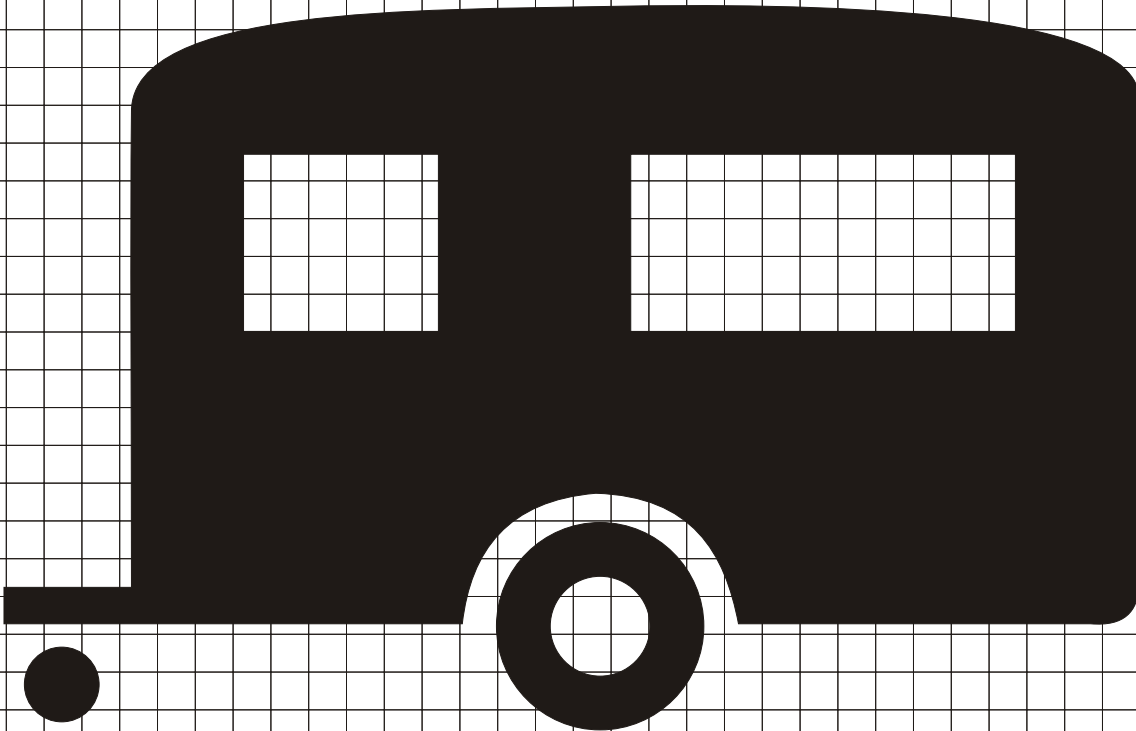

RM-020

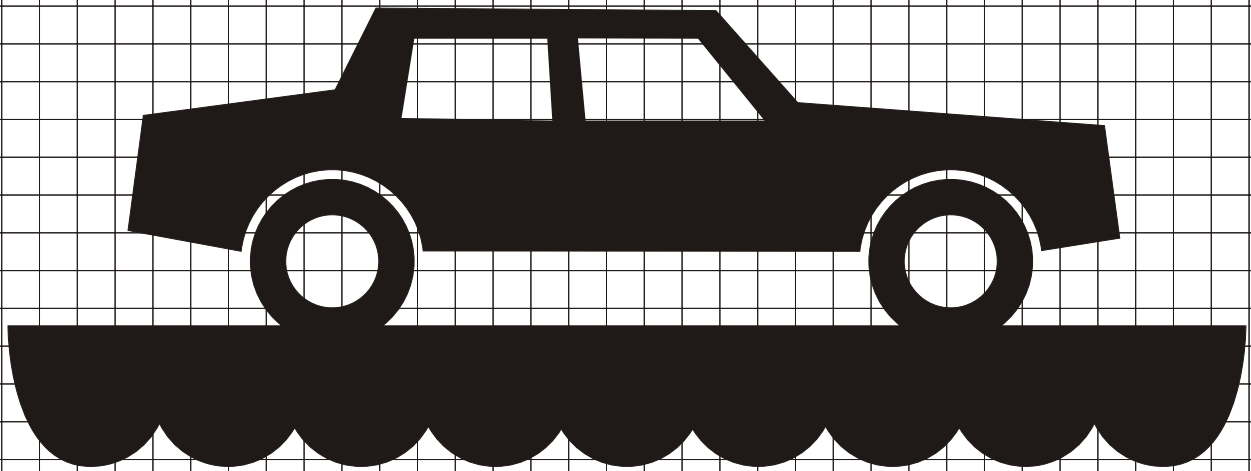

RM-030

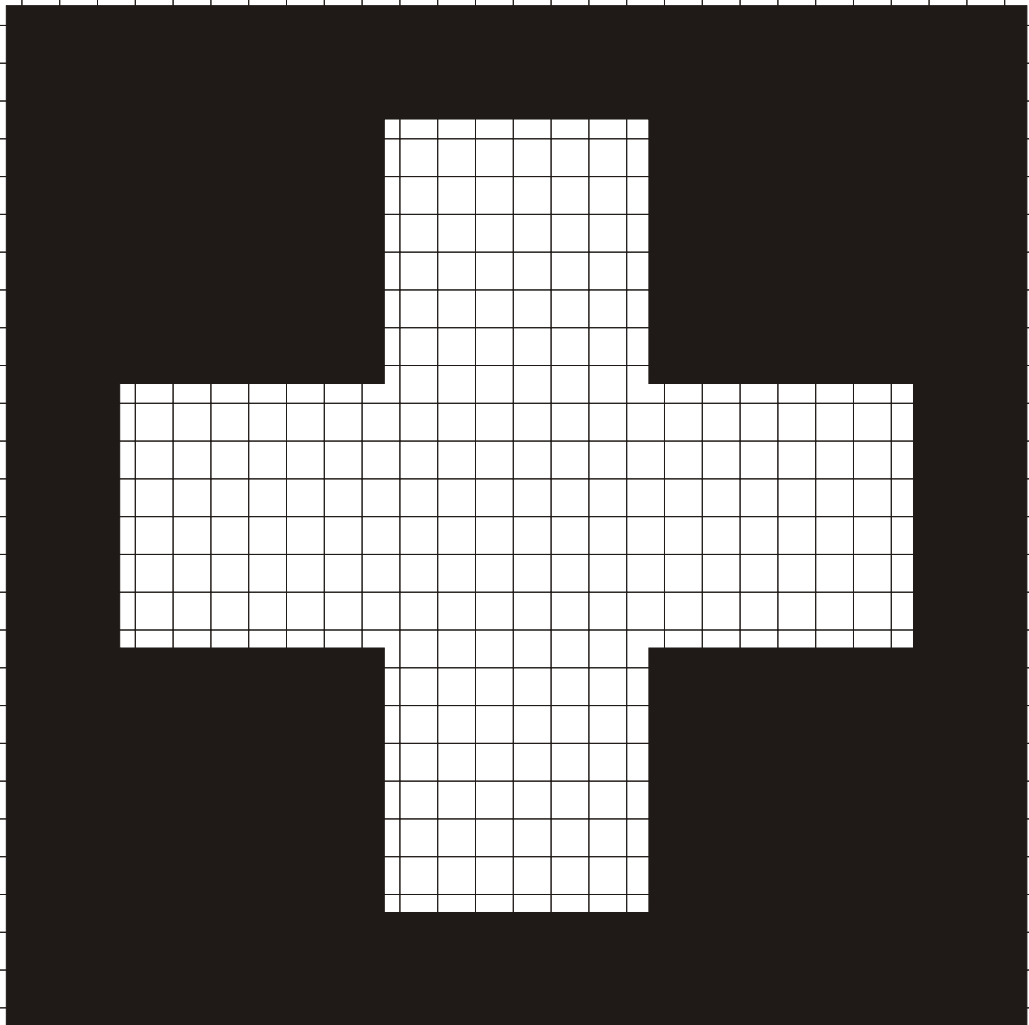

RM-040

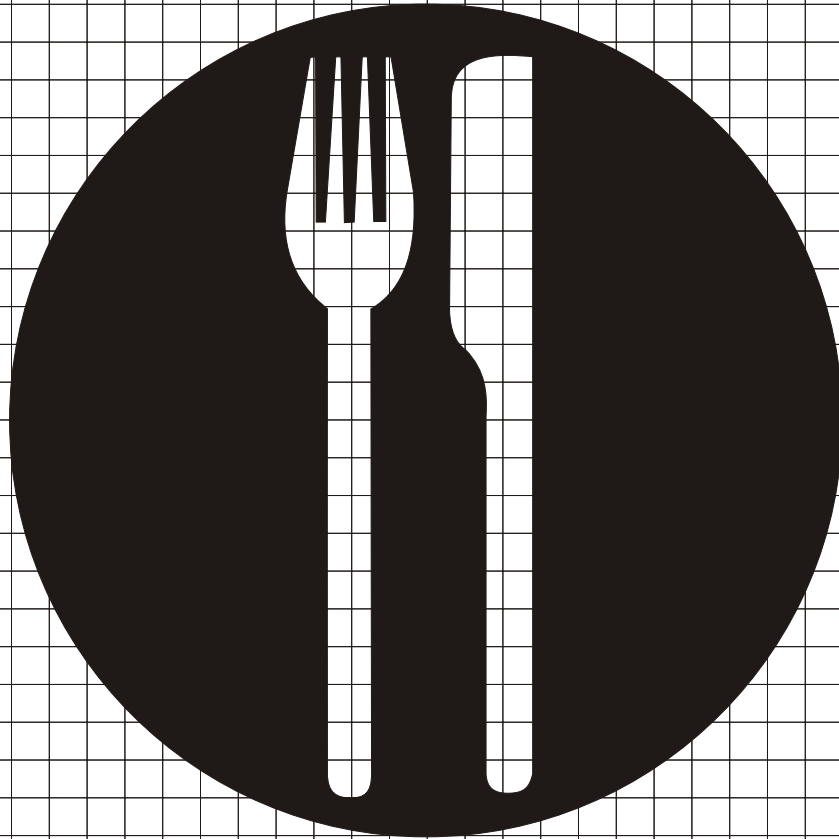

RM-050

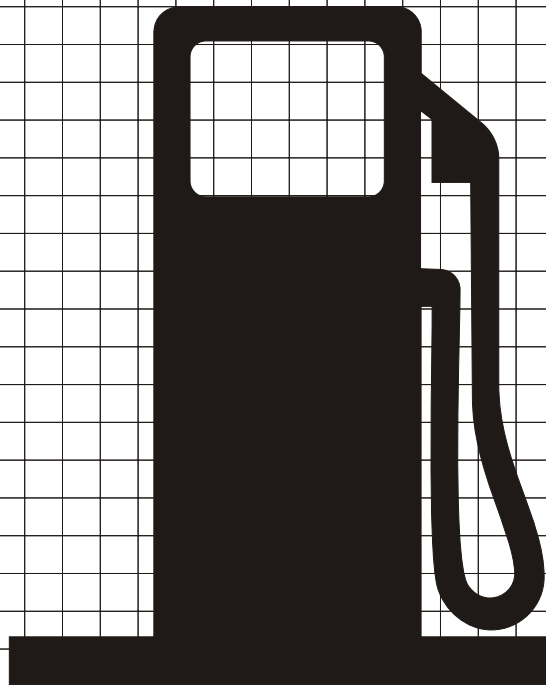

RM-060

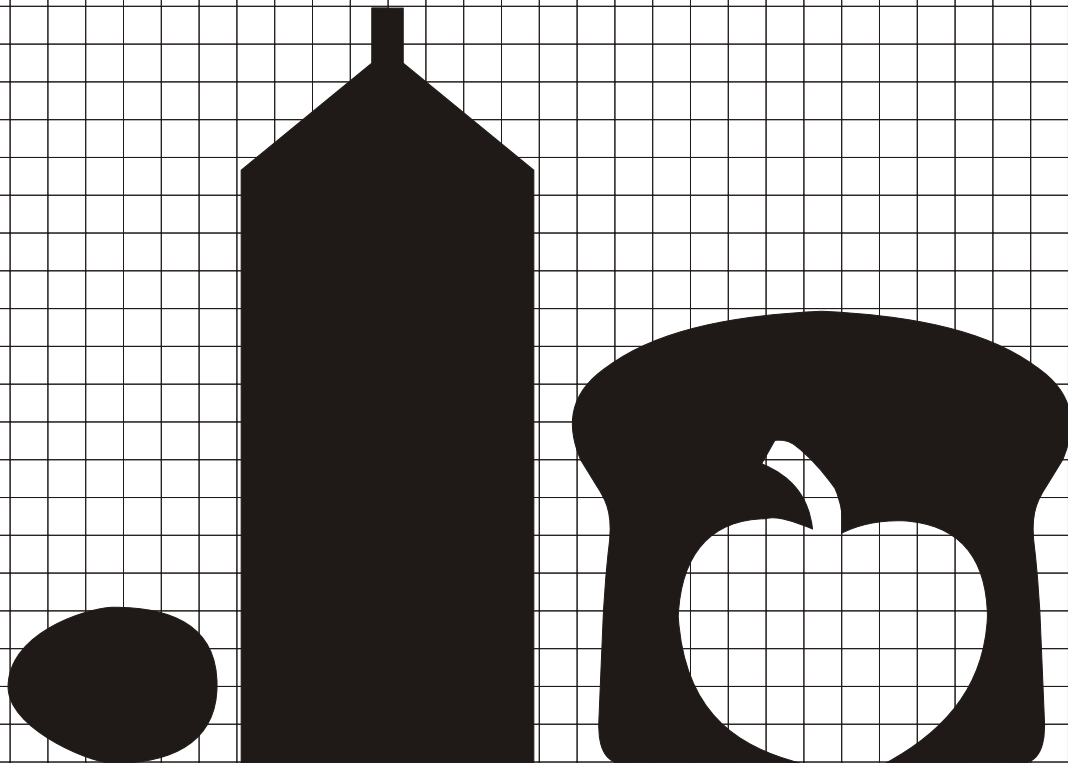

RM-070

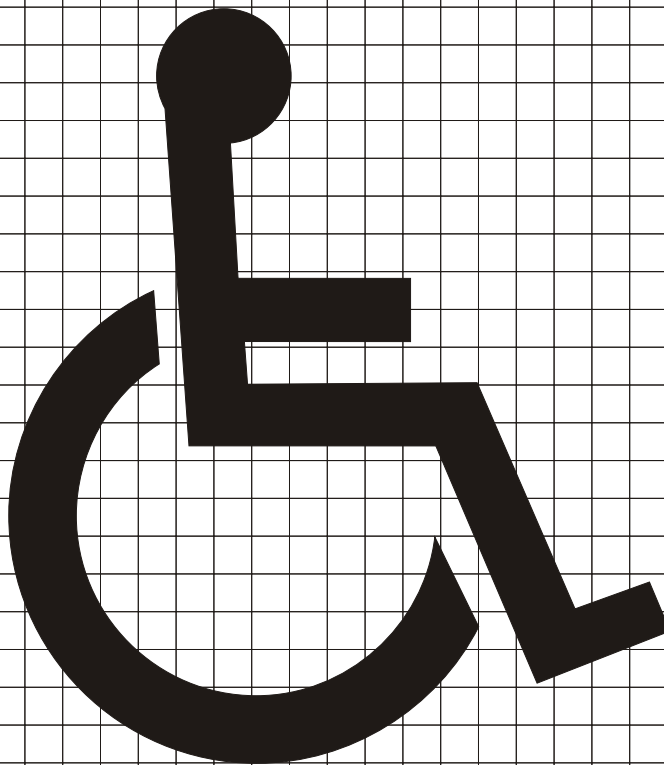

RM-080

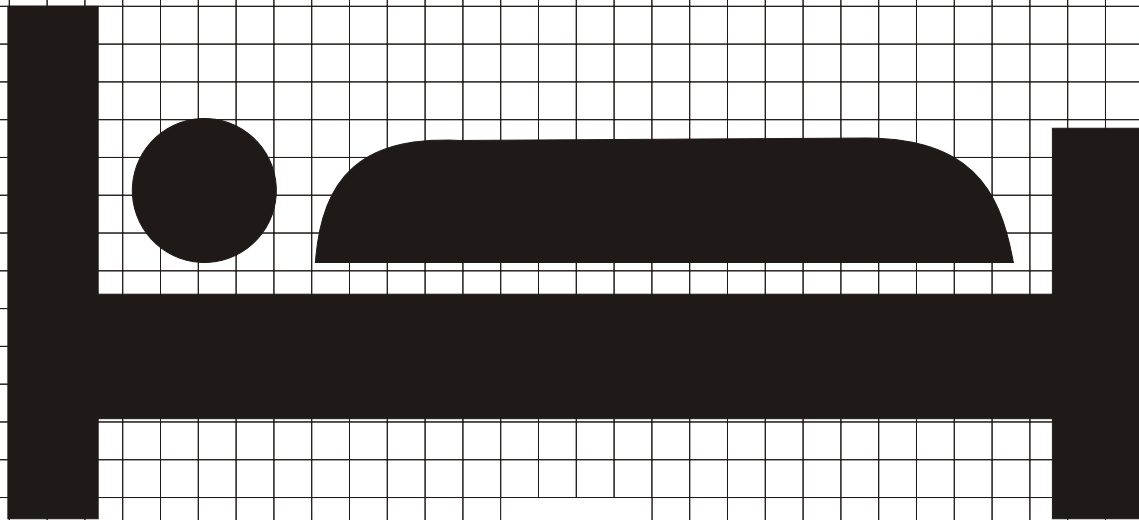

RM-090

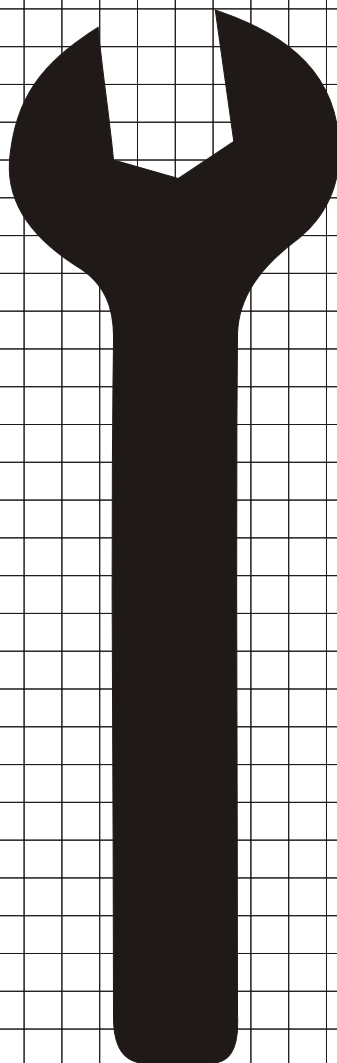

RM-100

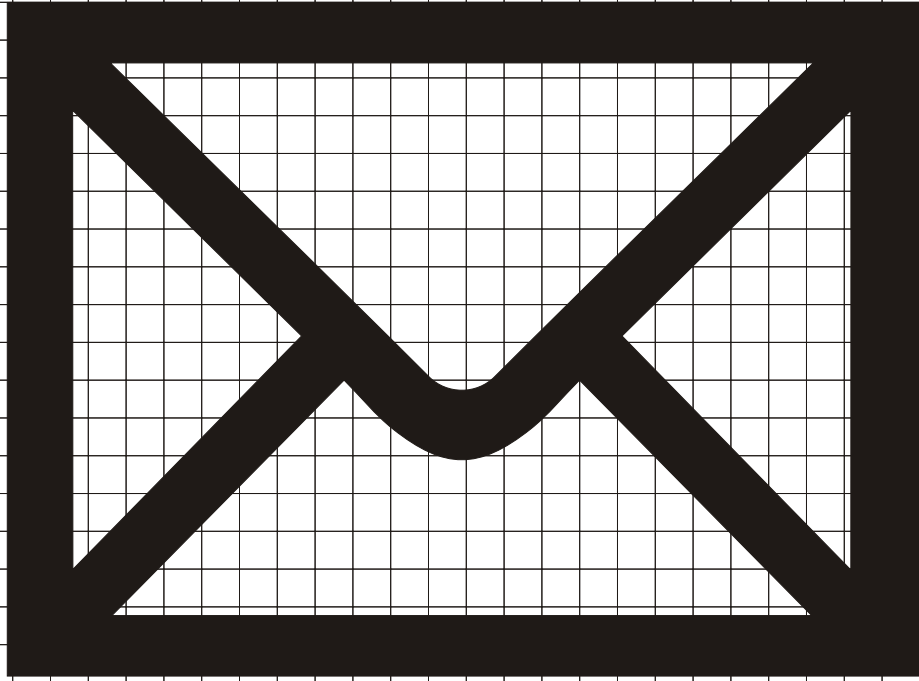

RM-110

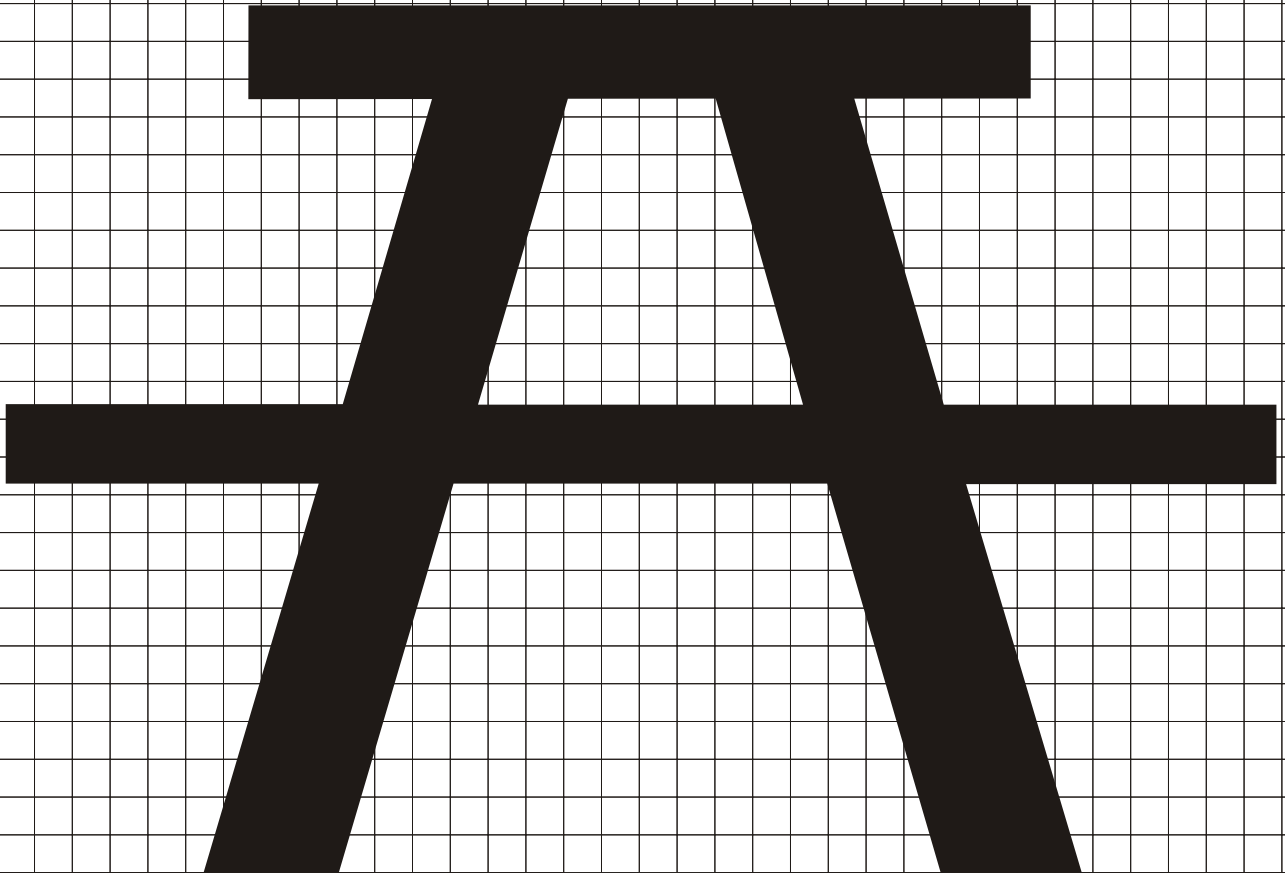

RM-120

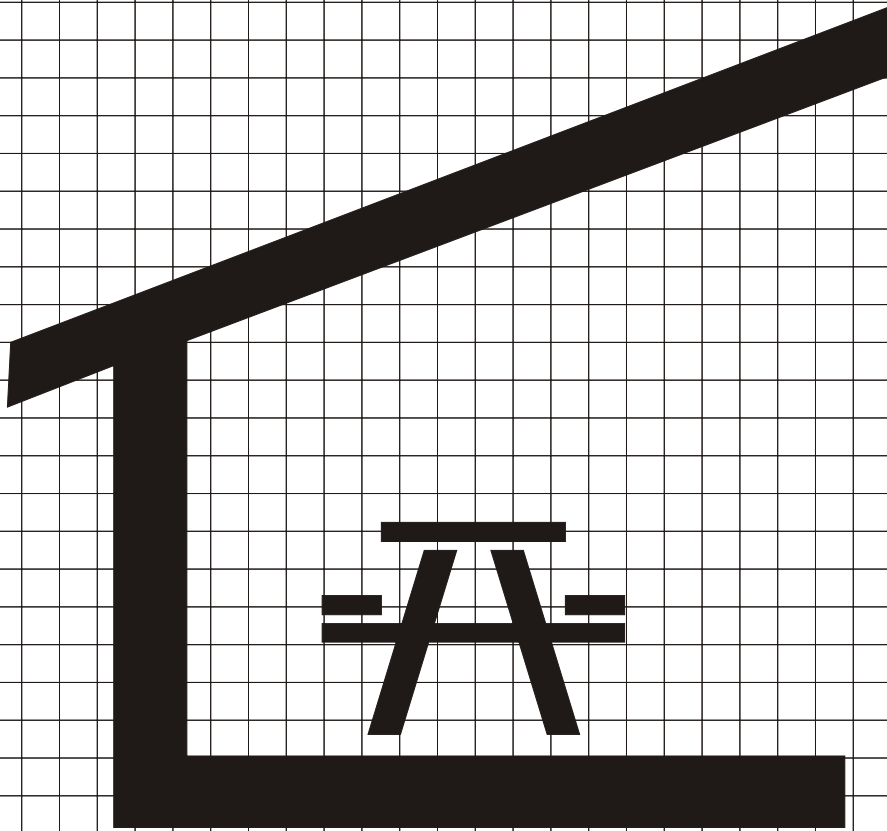

RM-130

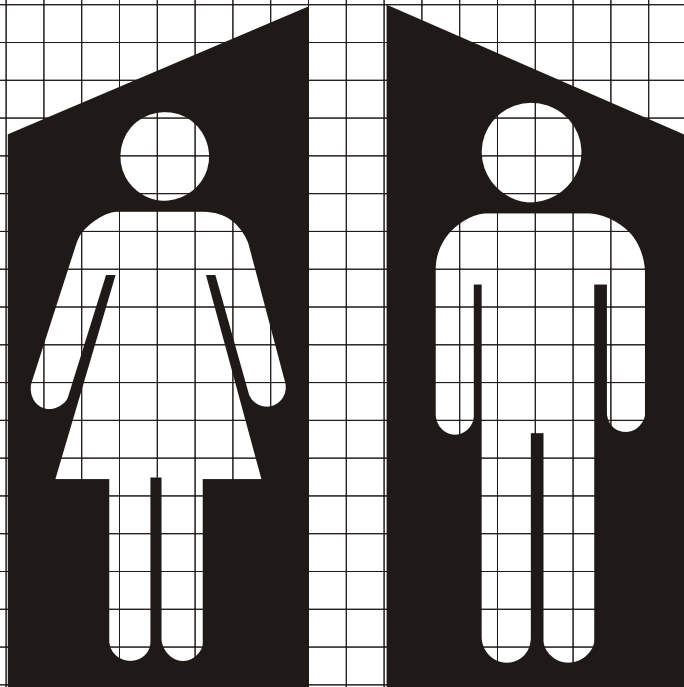

RM-140

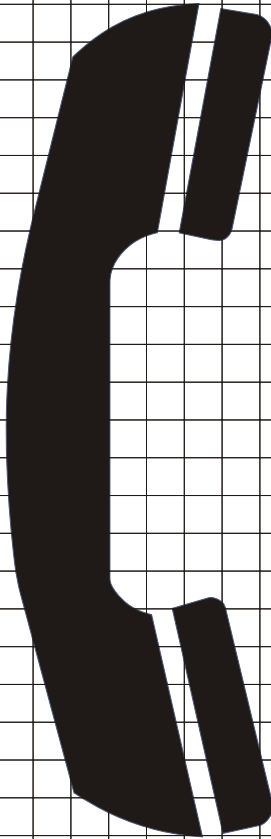

RM-150

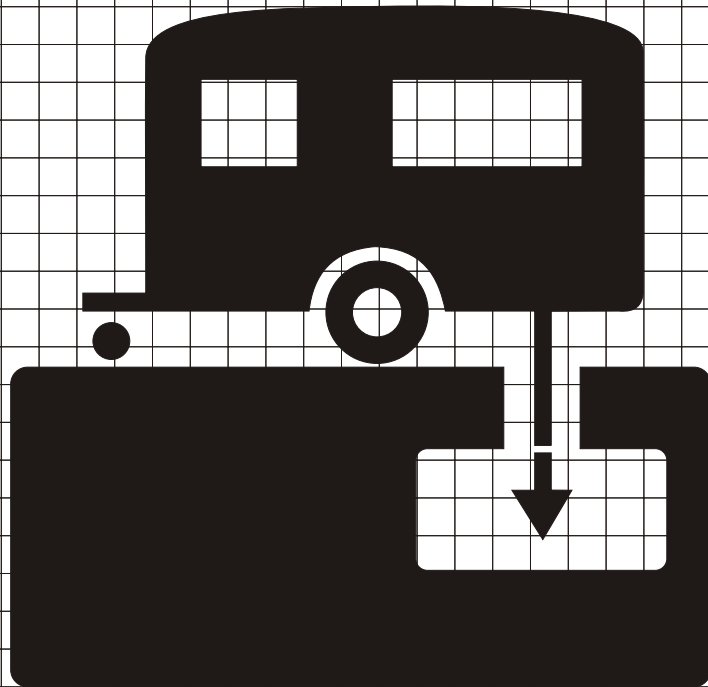

RM-160

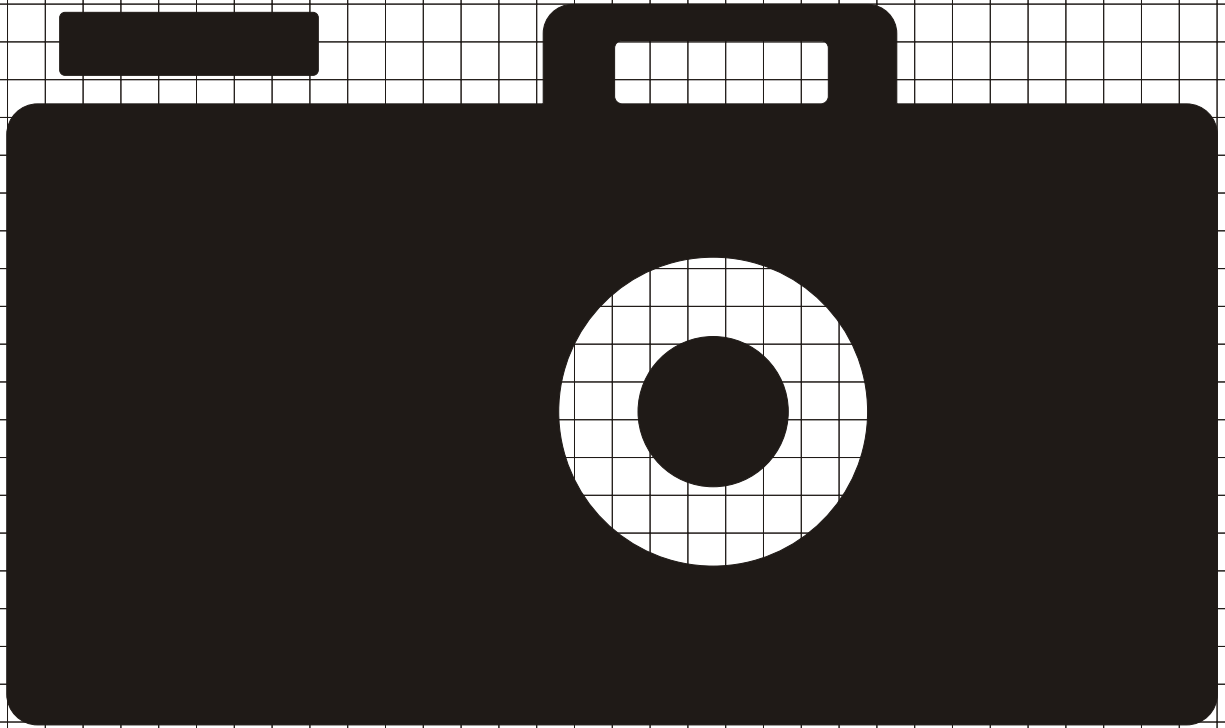

RM-170

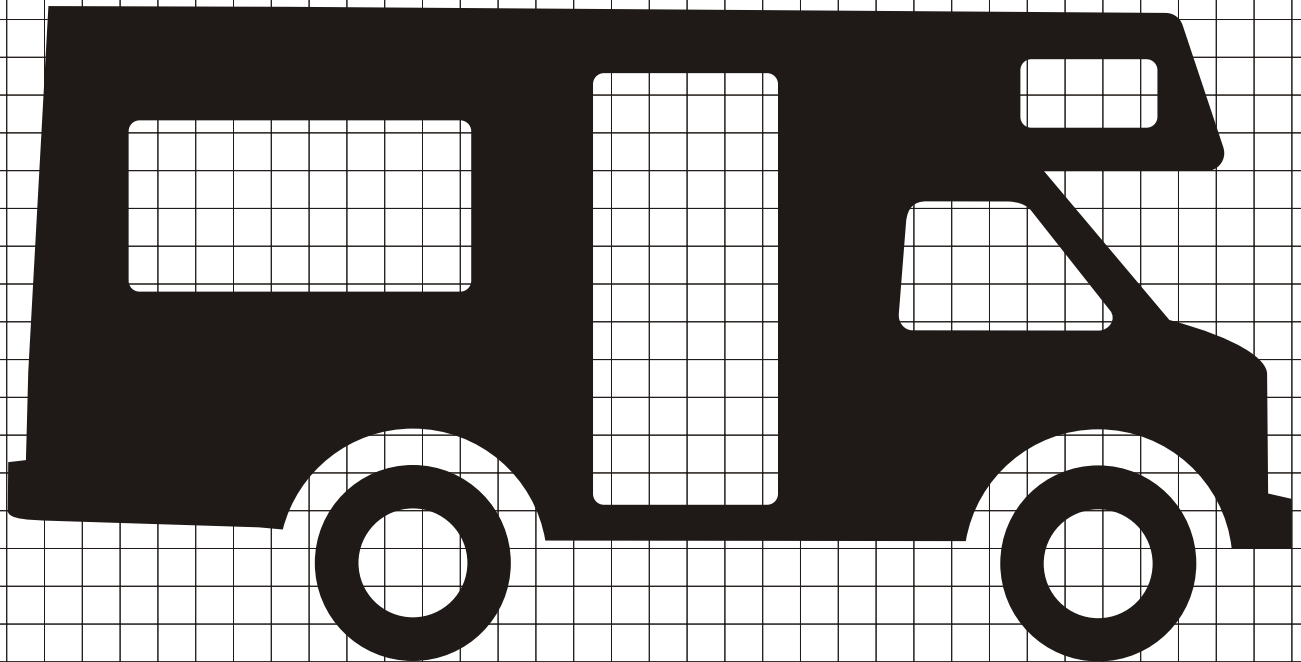

RM-200

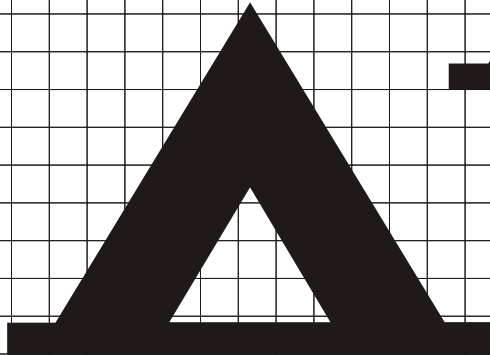
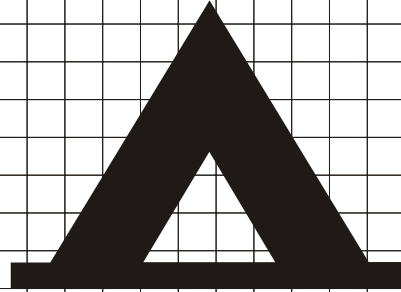
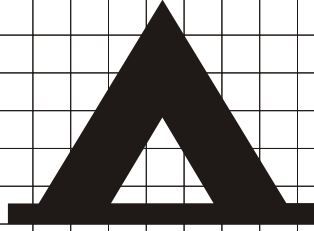

RM-210

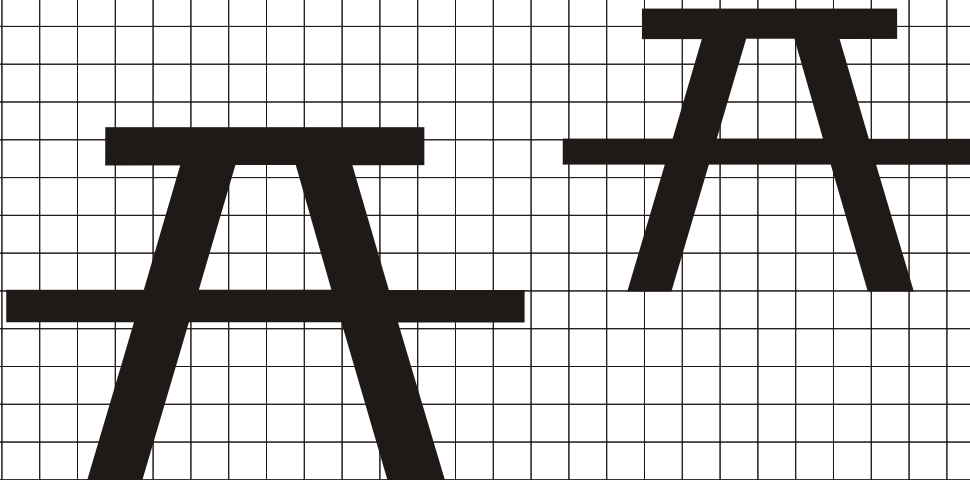
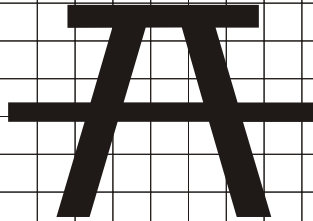

RM-220

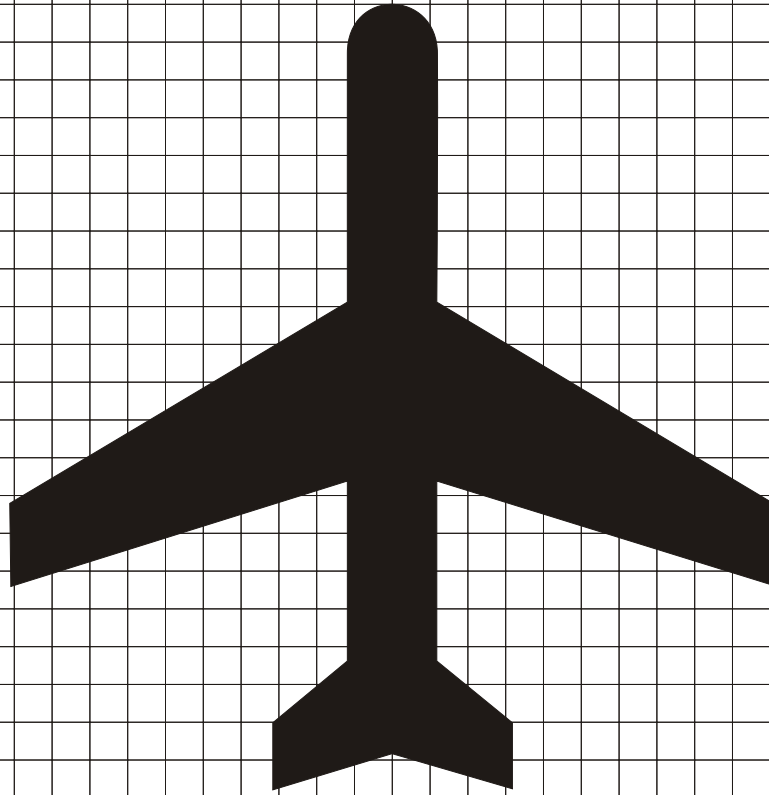

RA-010

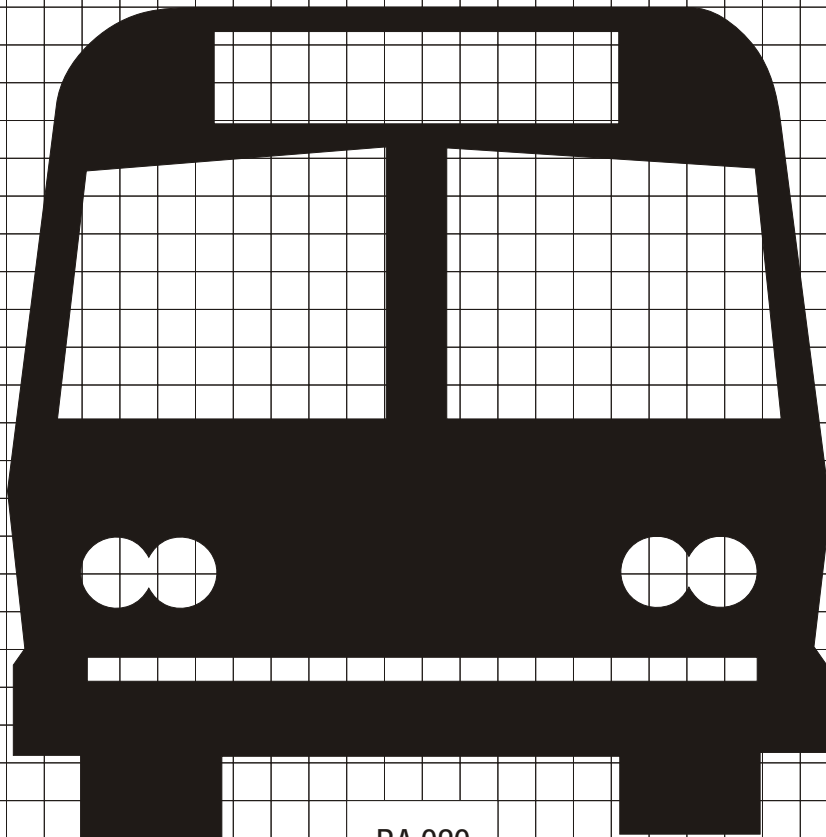

RA-020

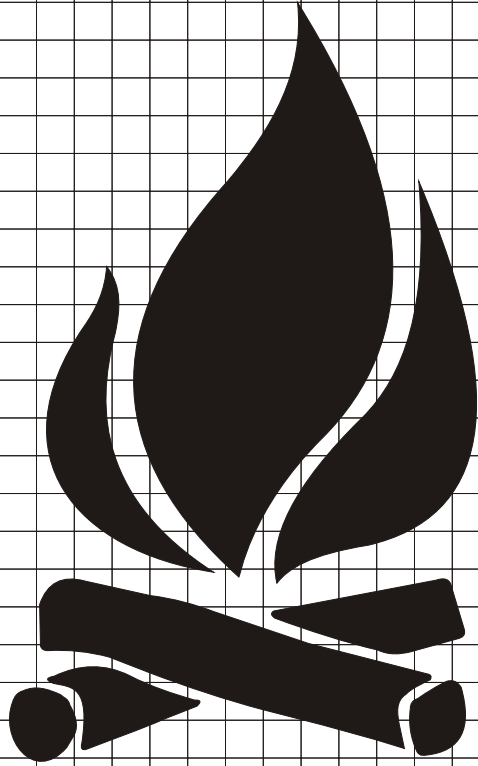

RA-030

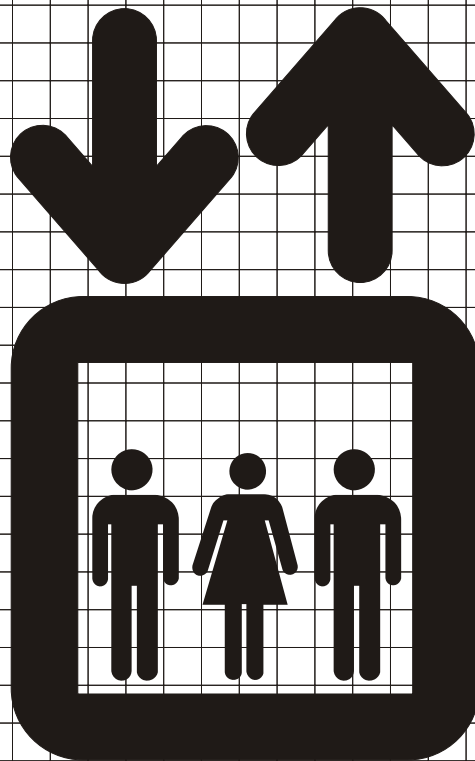

RA-040



RA-050

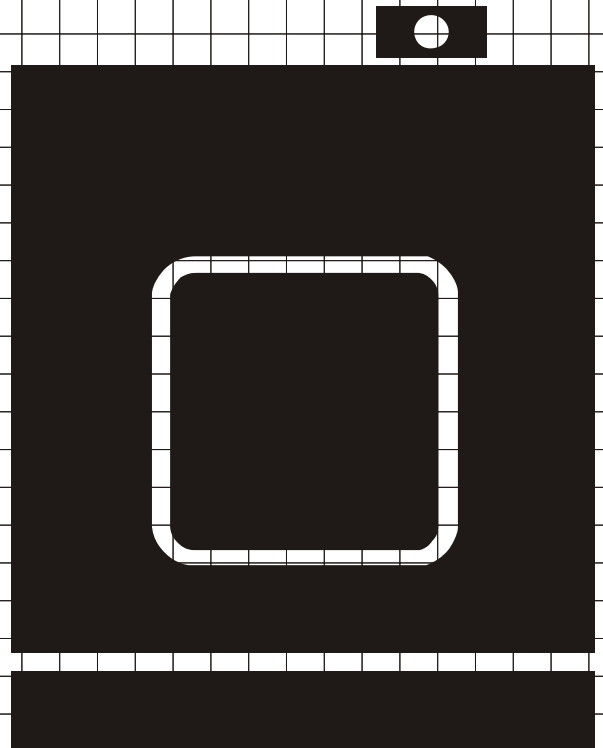
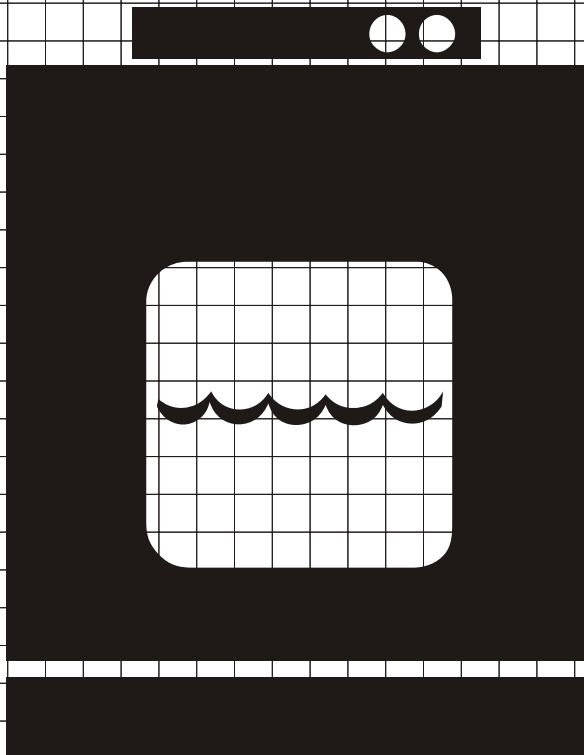

RA-060

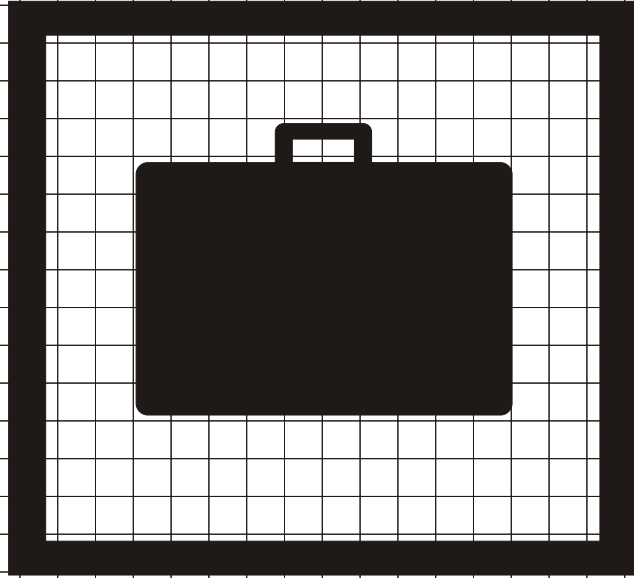
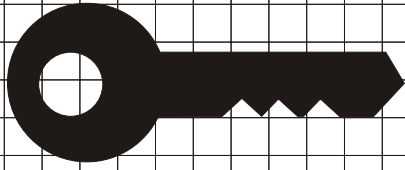

RA-070

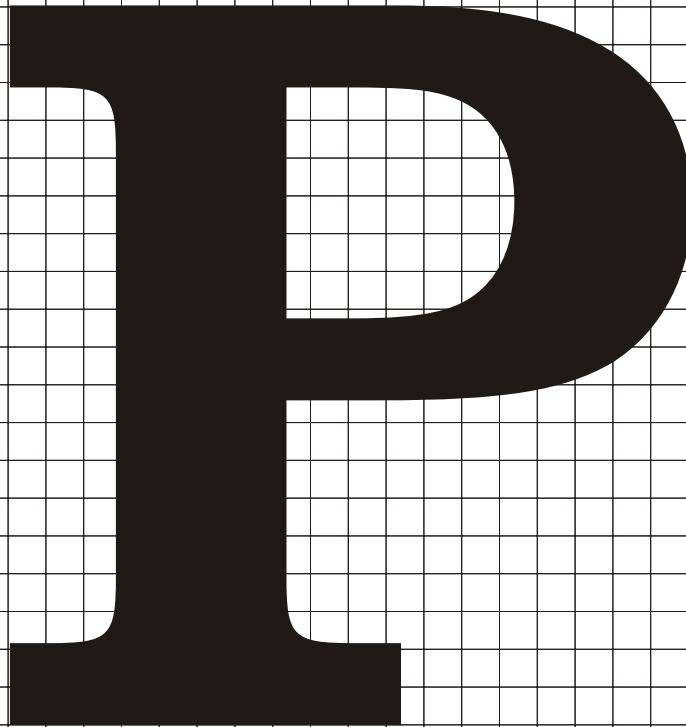

RA-080

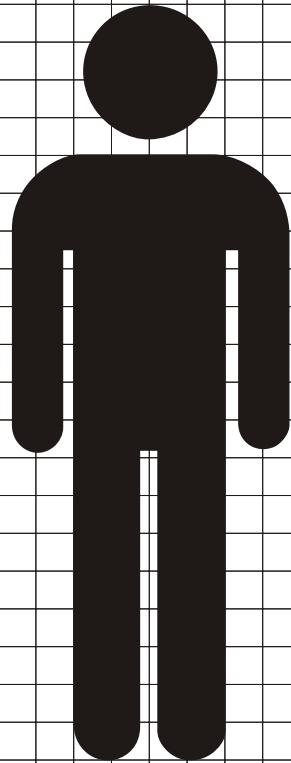

RA-090

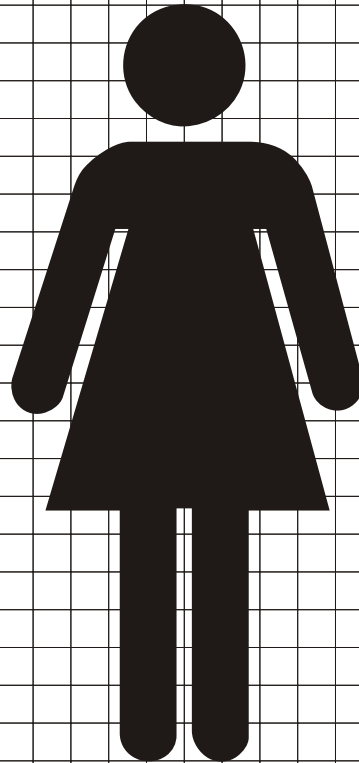

RA-100

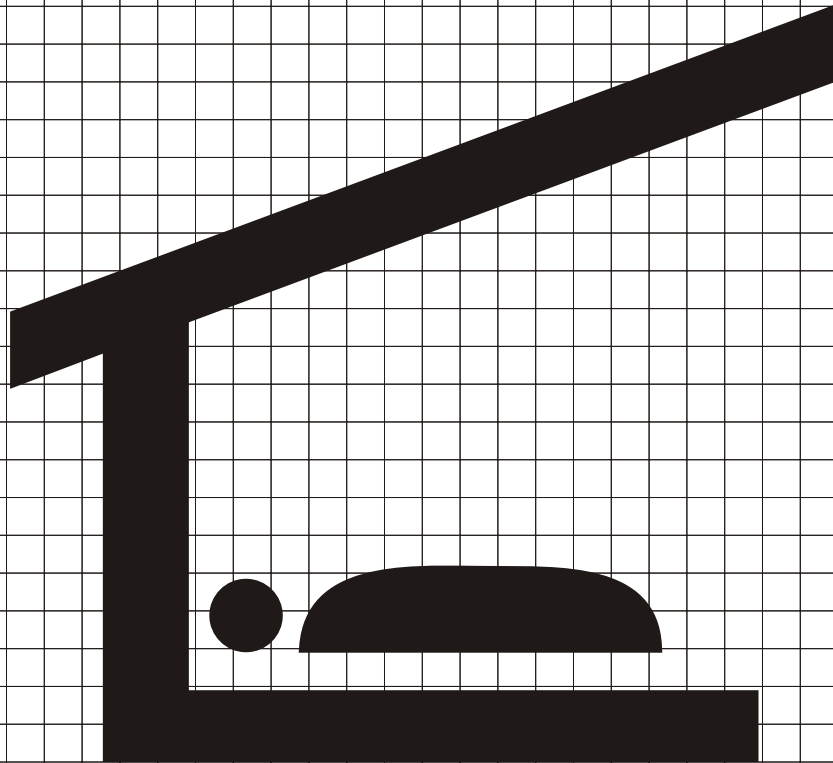

RA-110

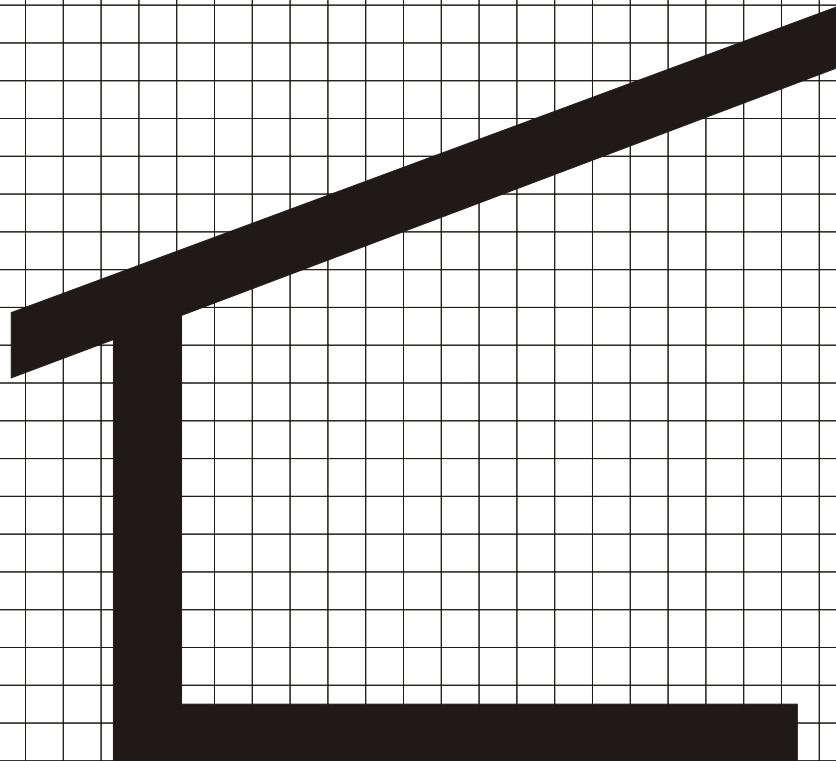

RA-120

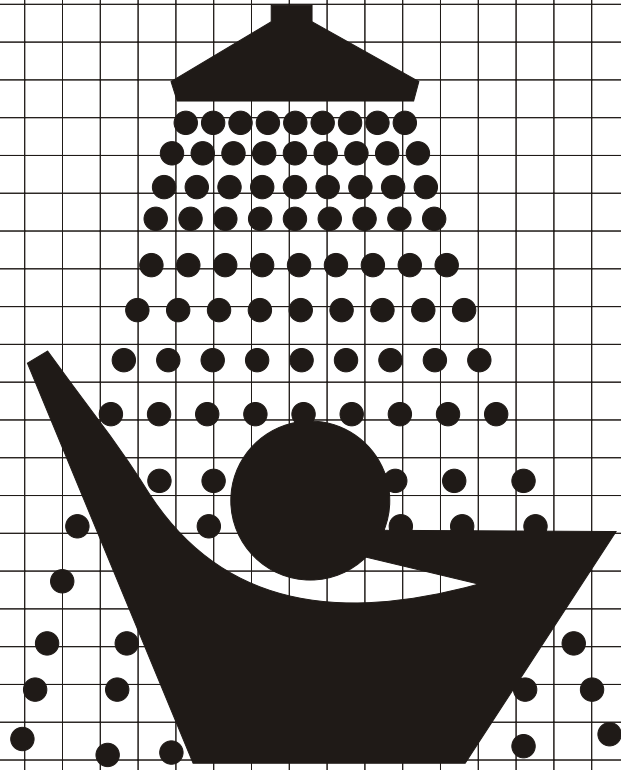

RA-130

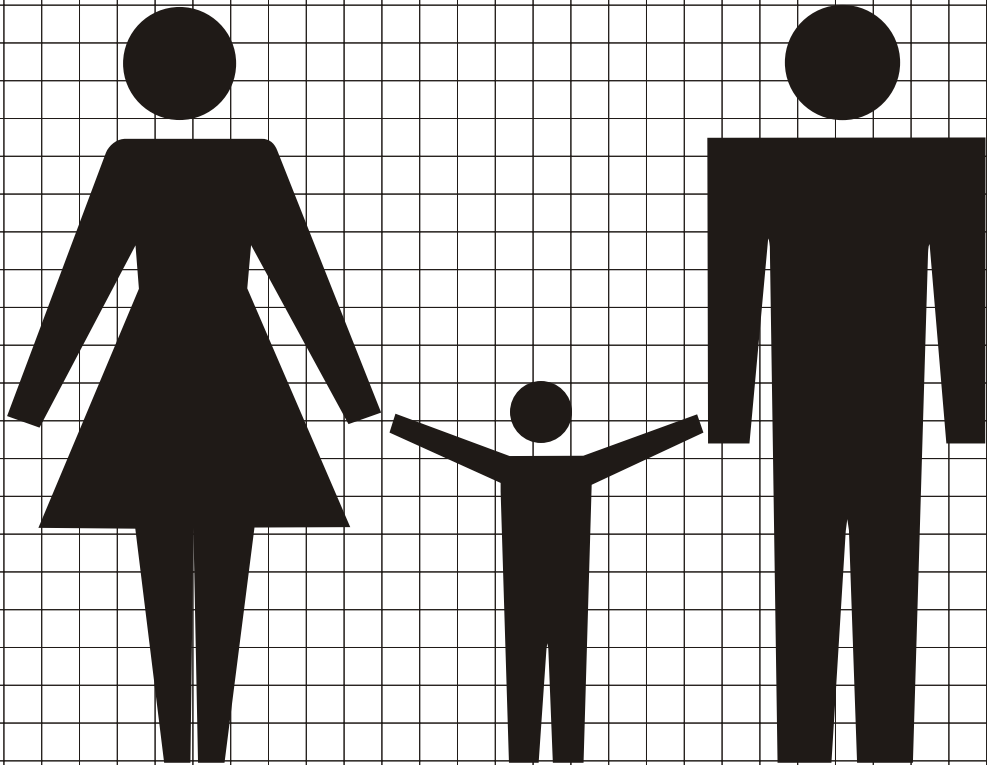

RA-150

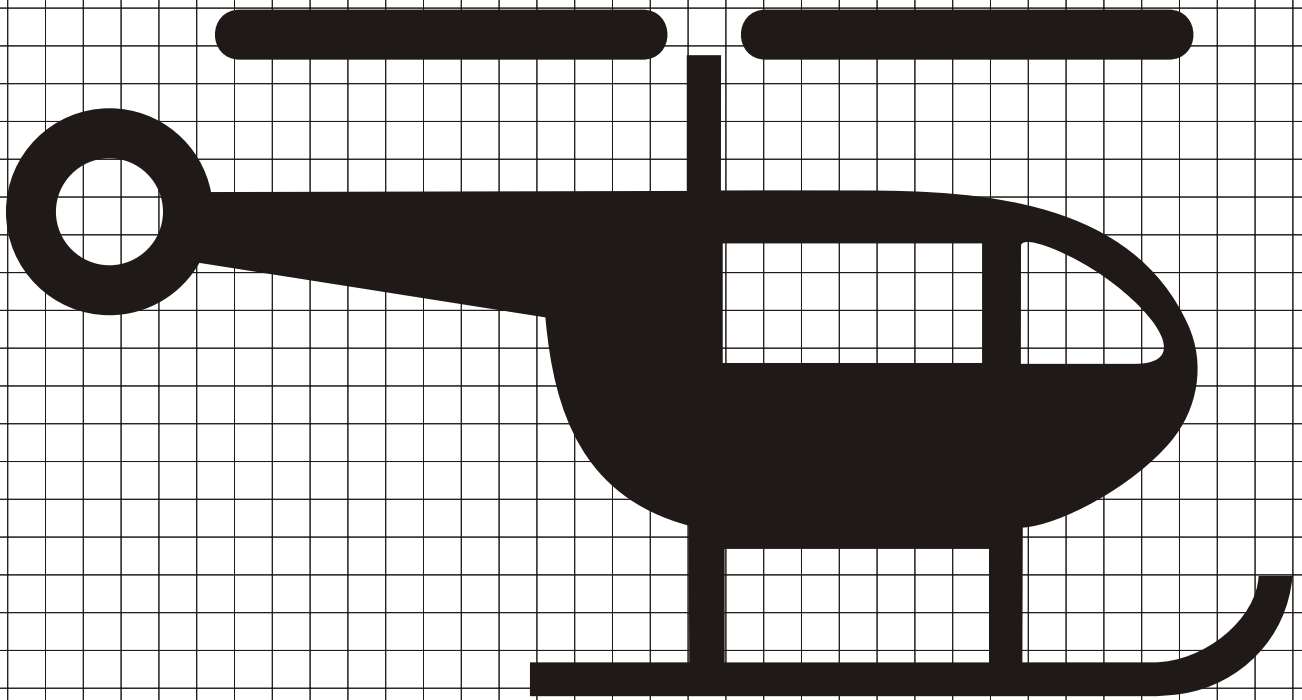

RA-160

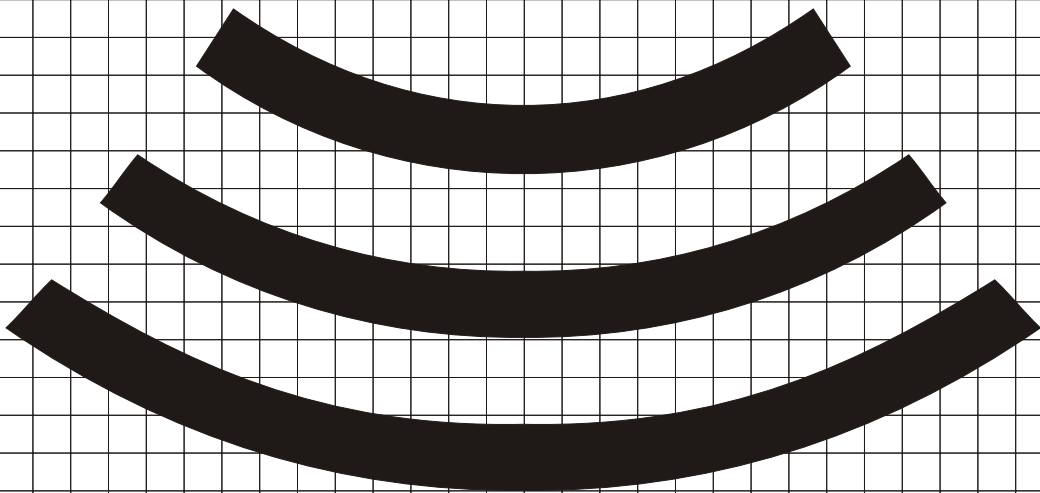

RL-010

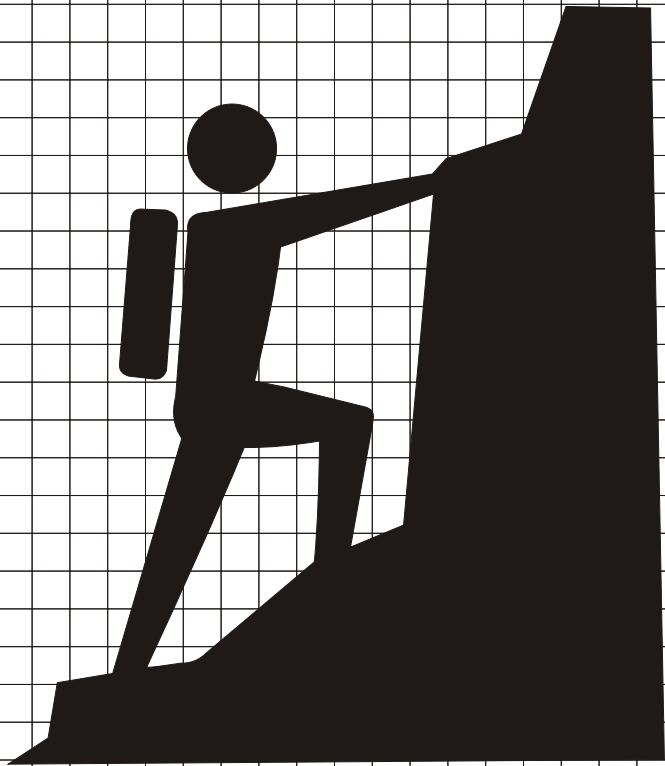

RL-020



RL-030

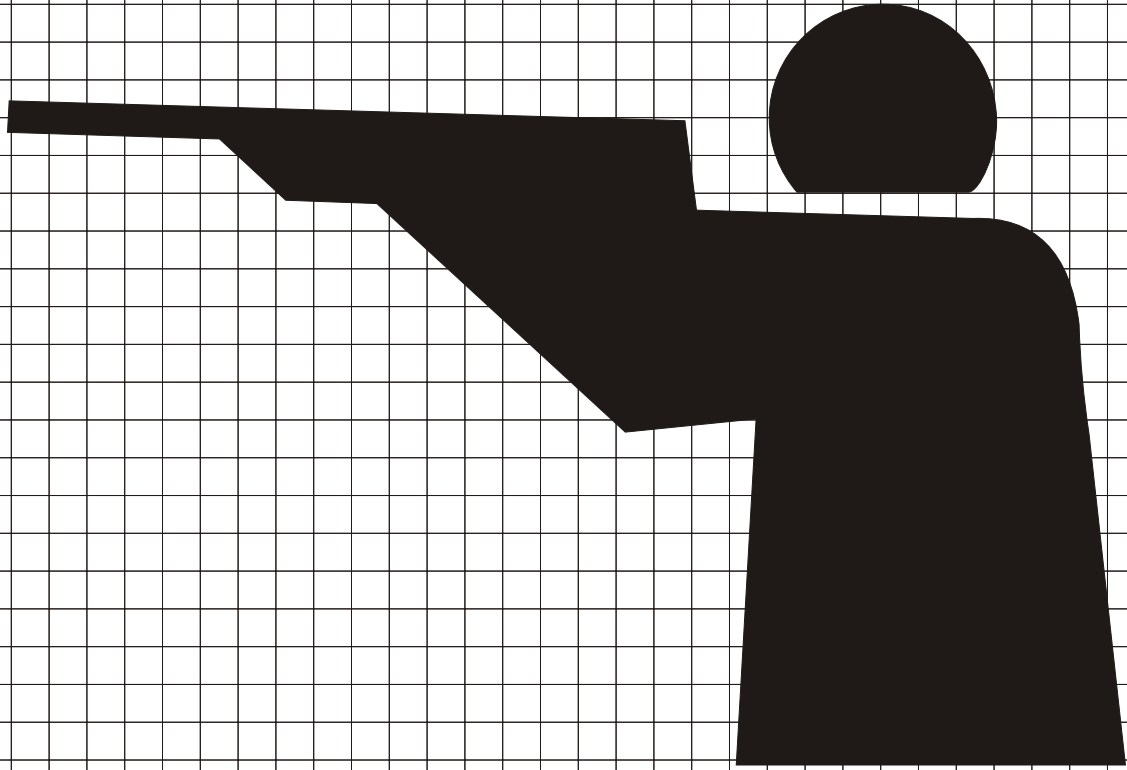

RL-040



RL-050

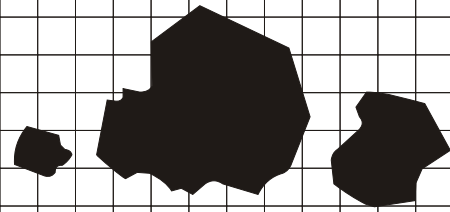
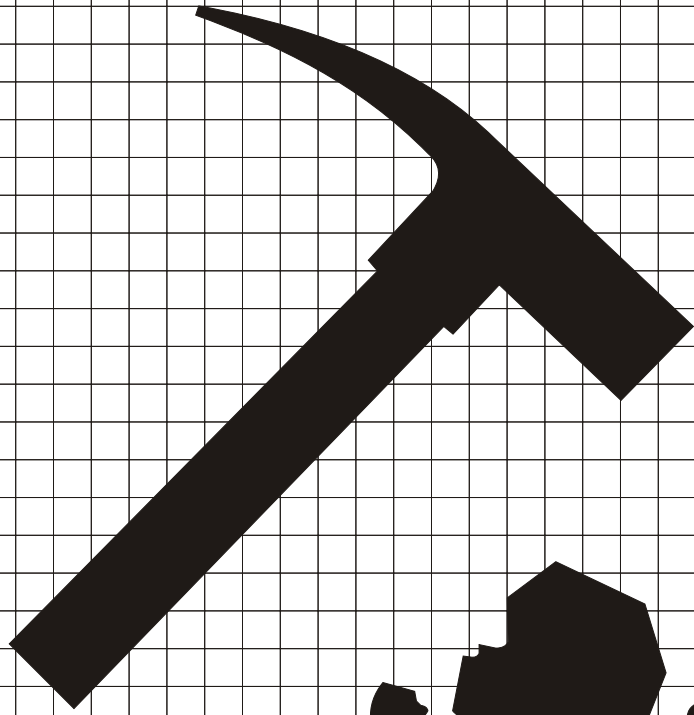

RL-060

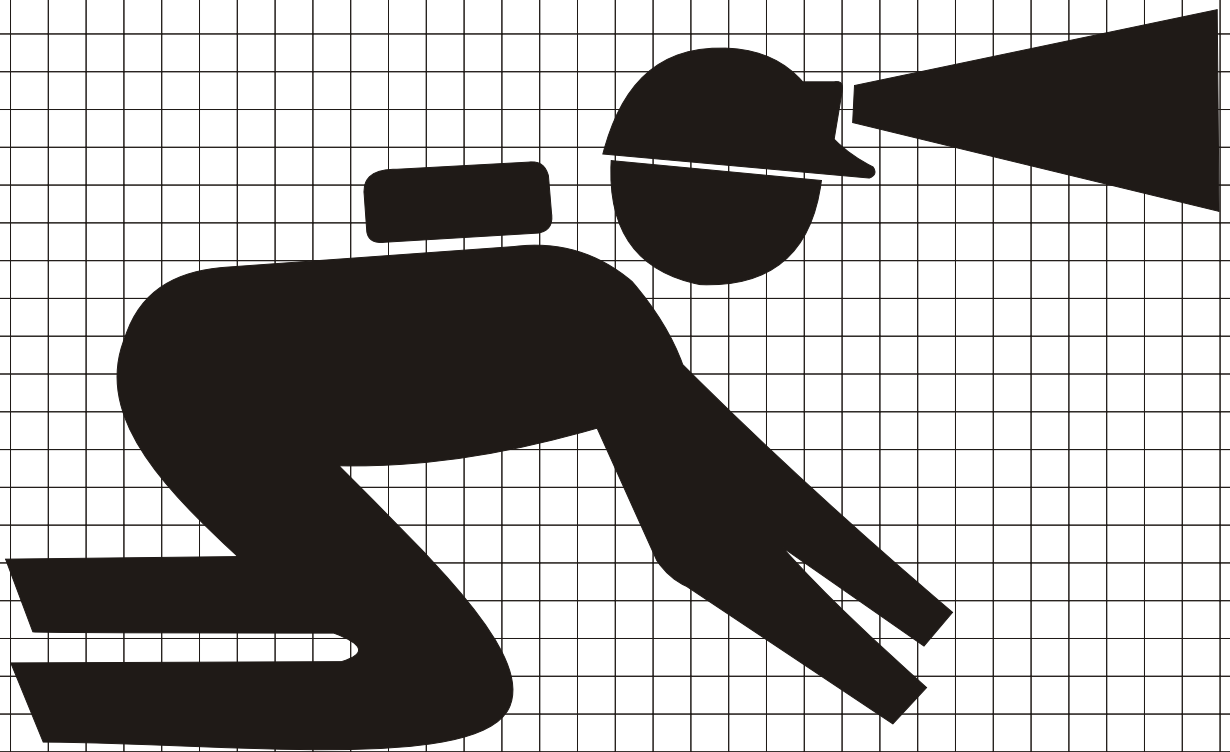

RL-070

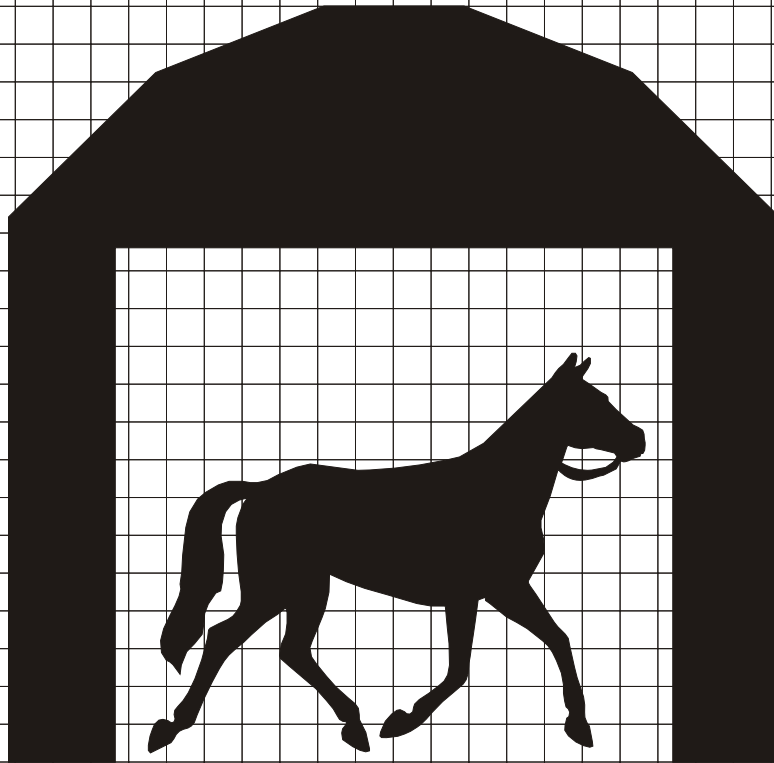

RL-080

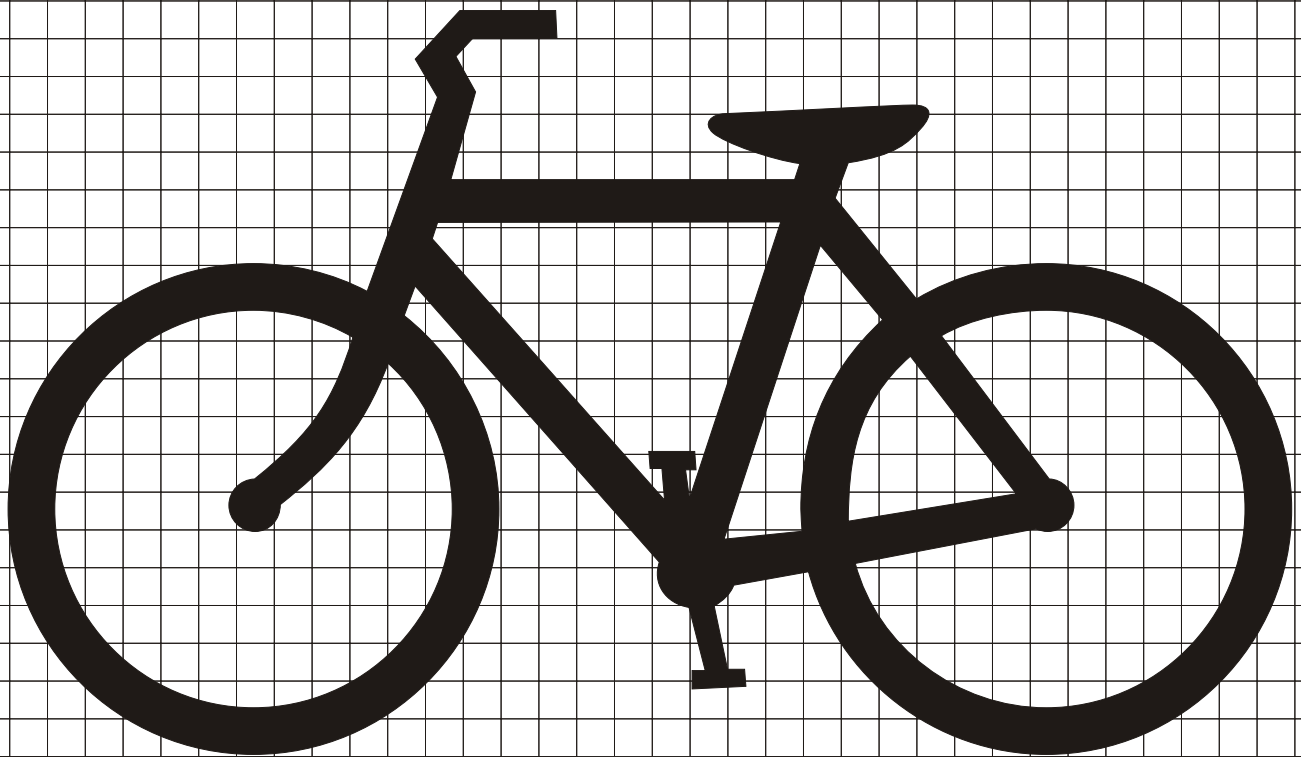

RL-090



RL-100

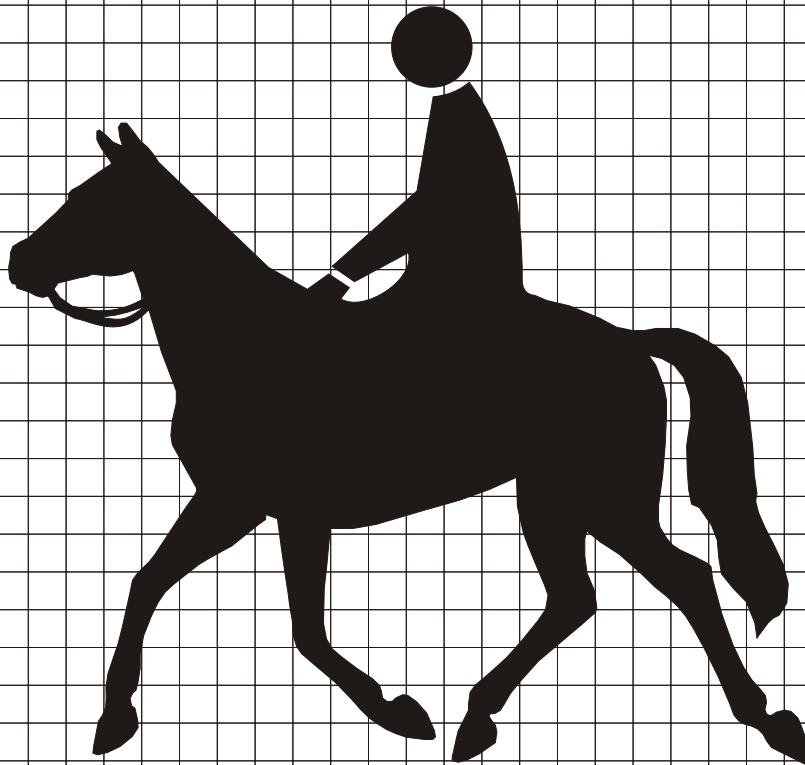

RL-110

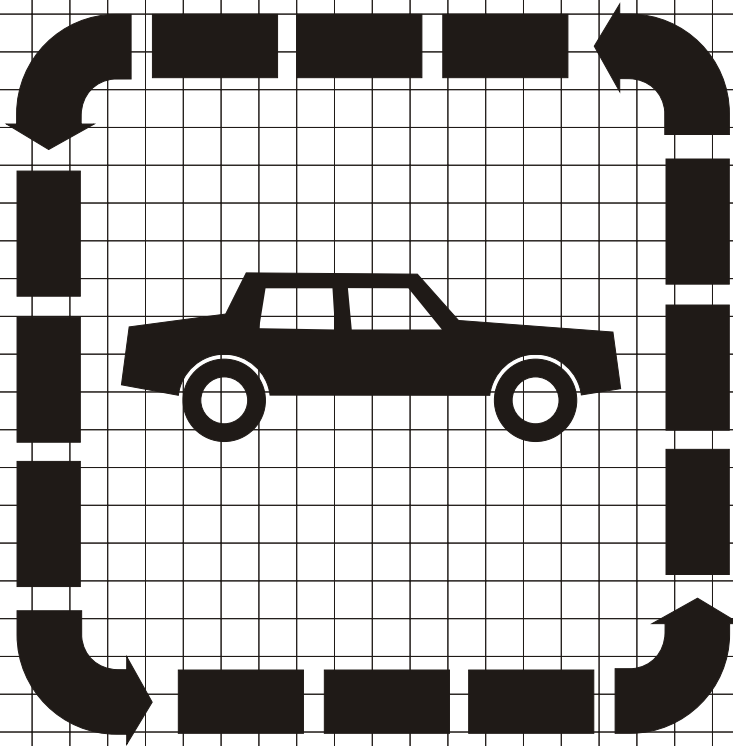

RL-120

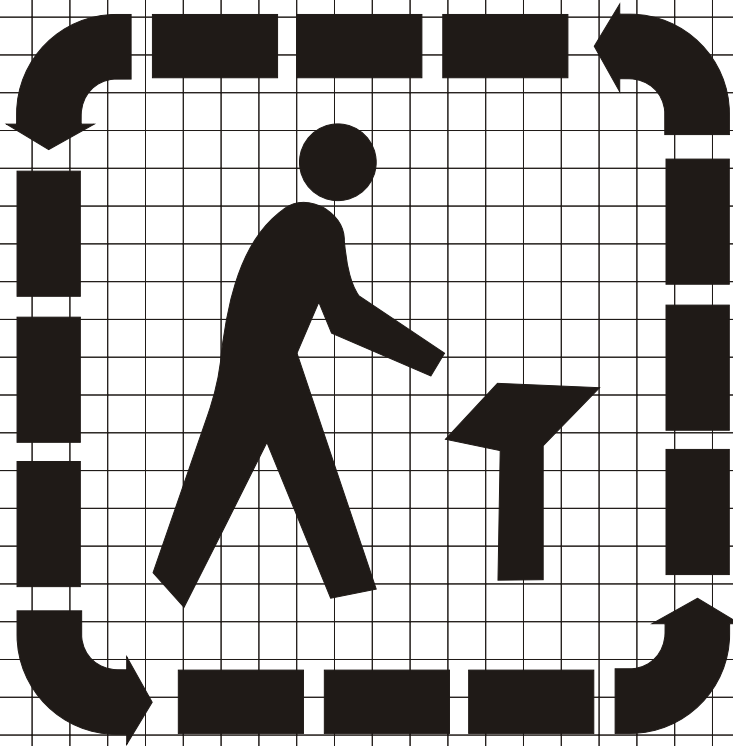

RL-130

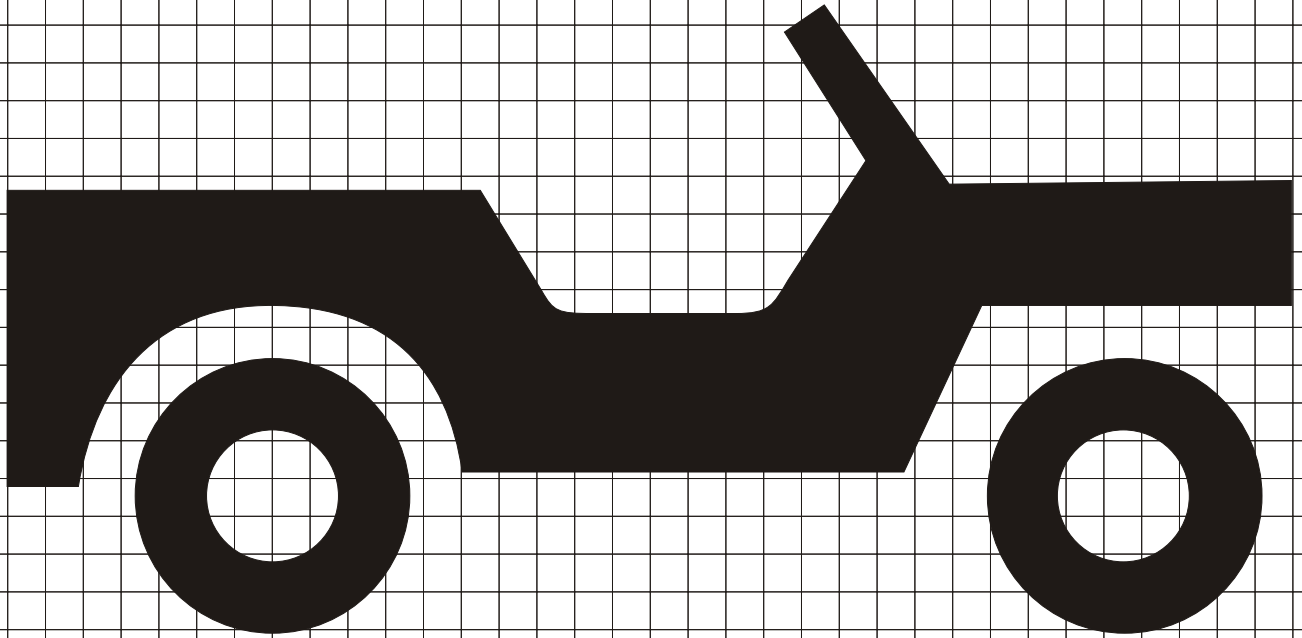

RL-140

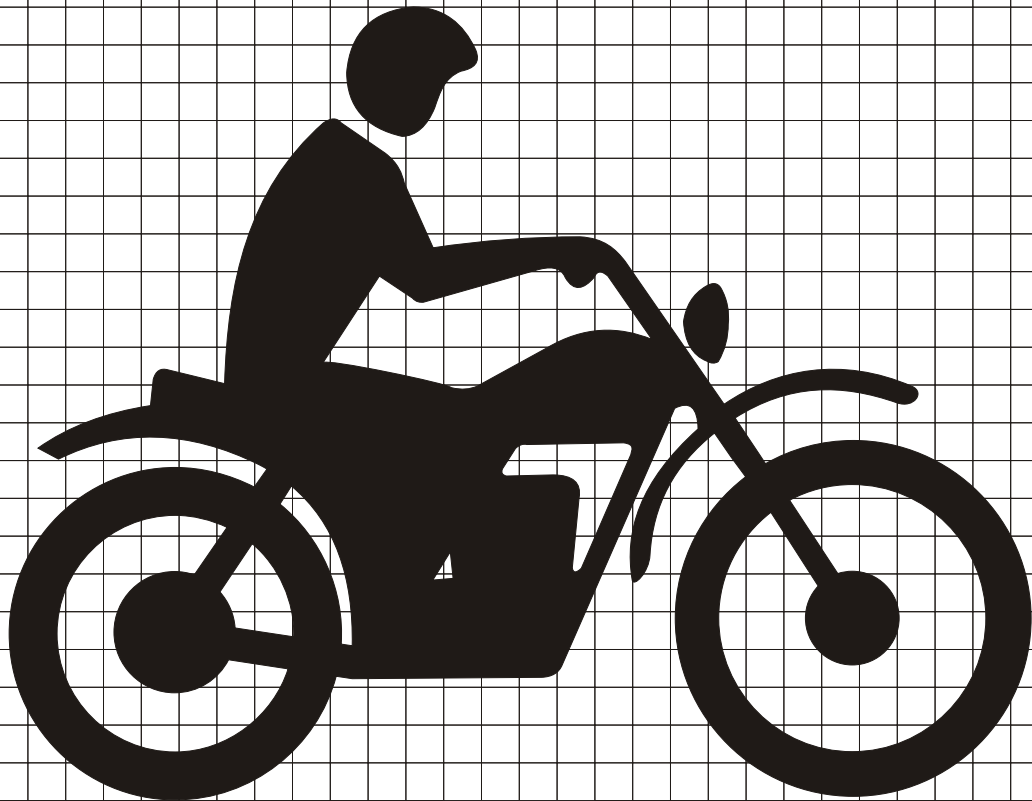

RL-150

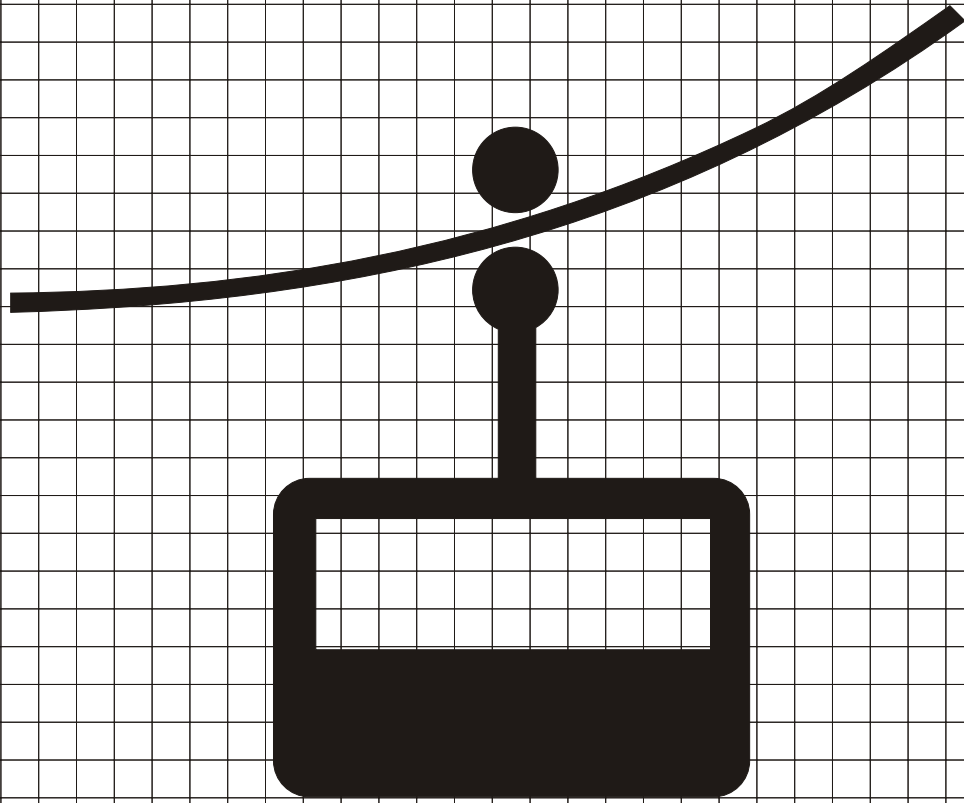

RL-160

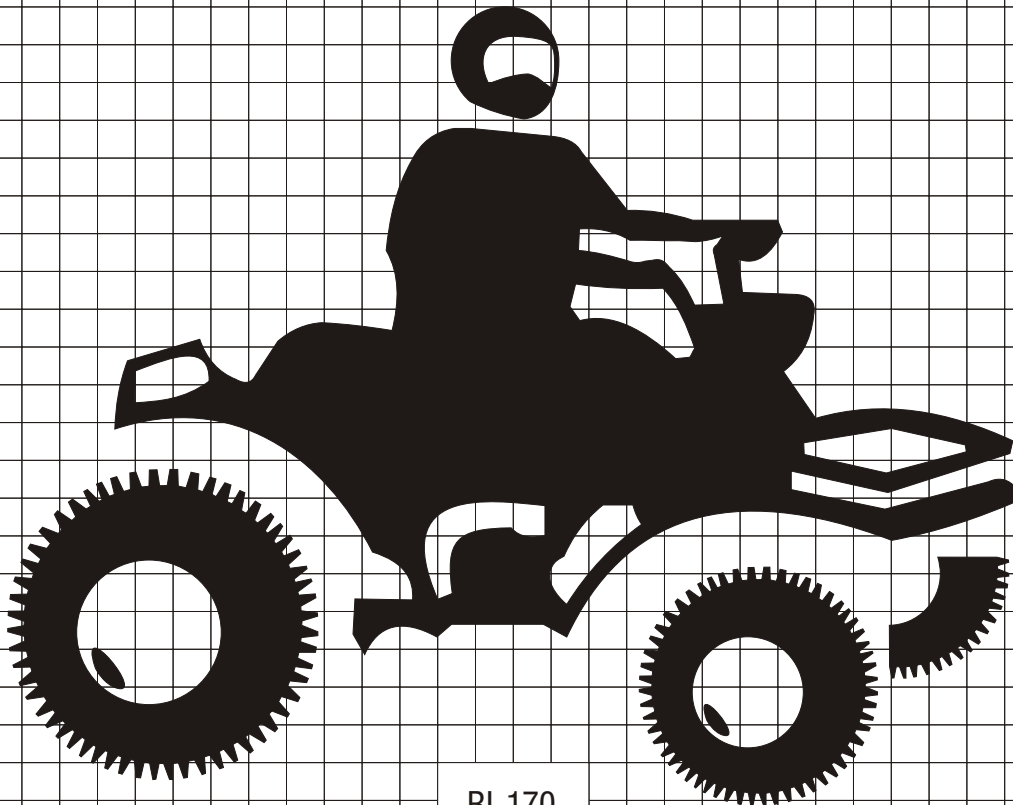

RL-170

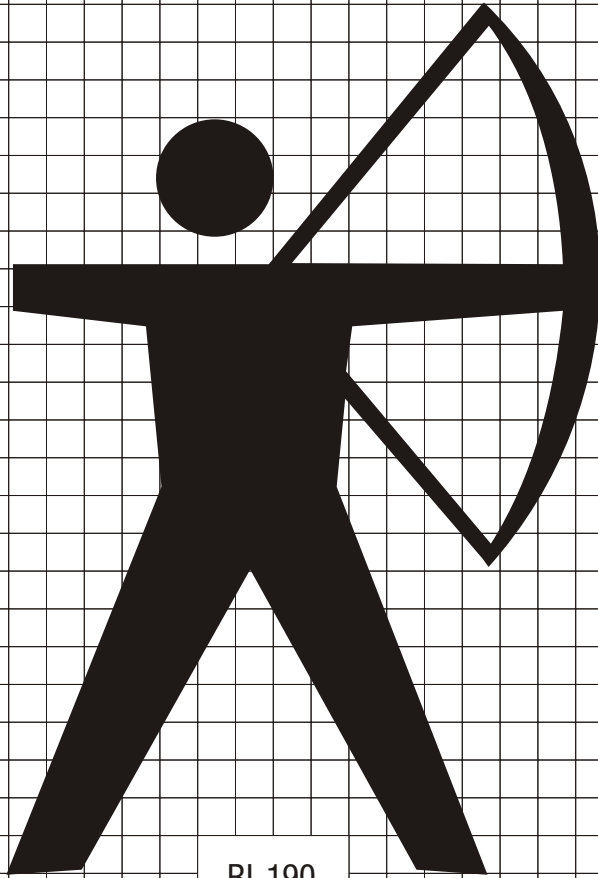

RL-190

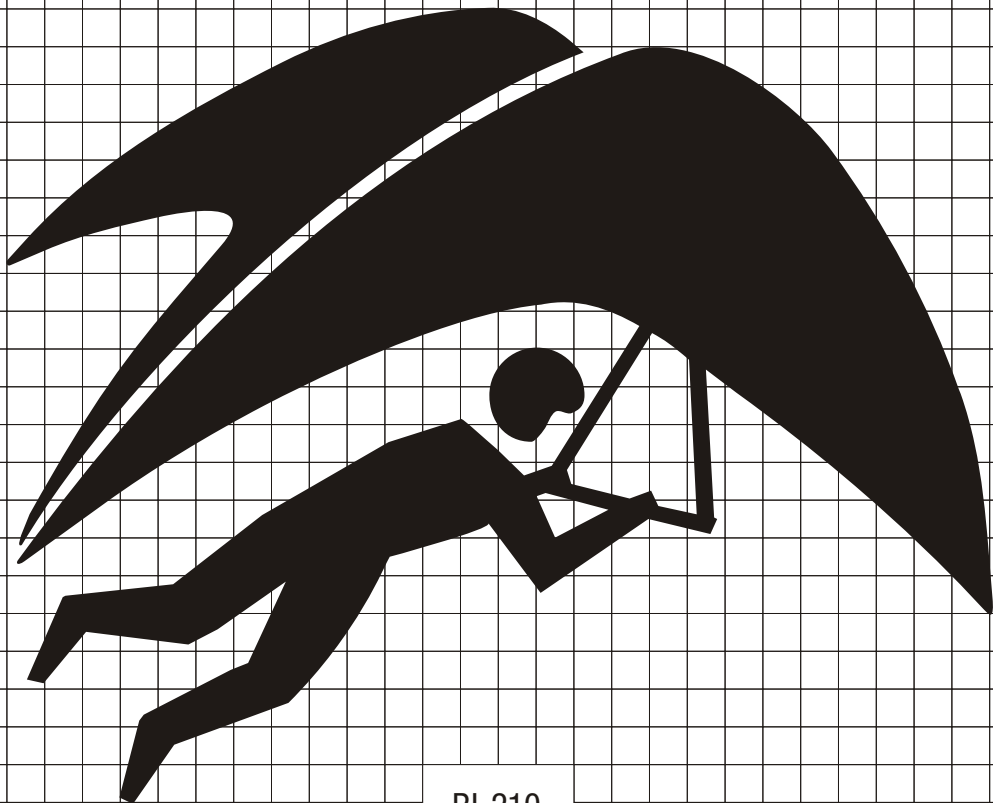

RL-210

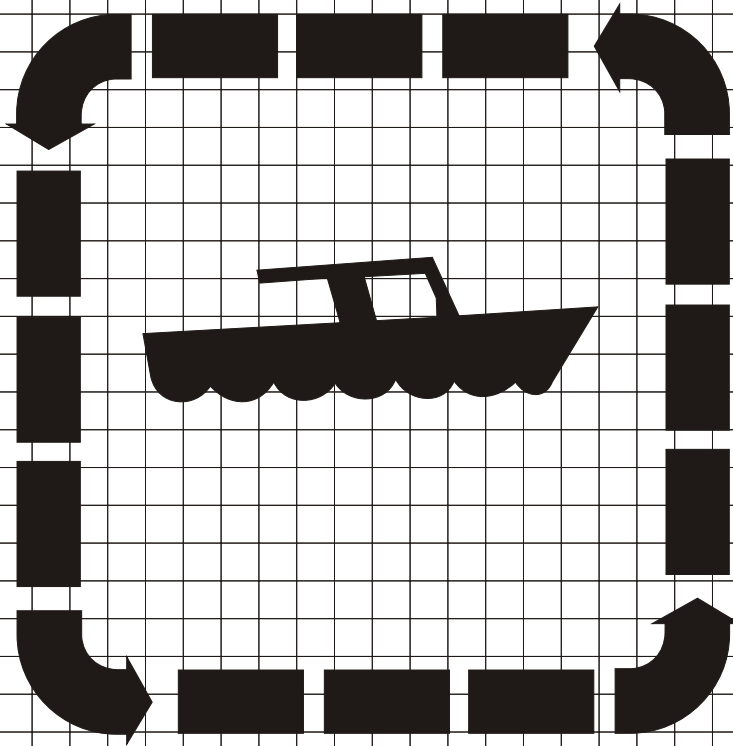

RW-010

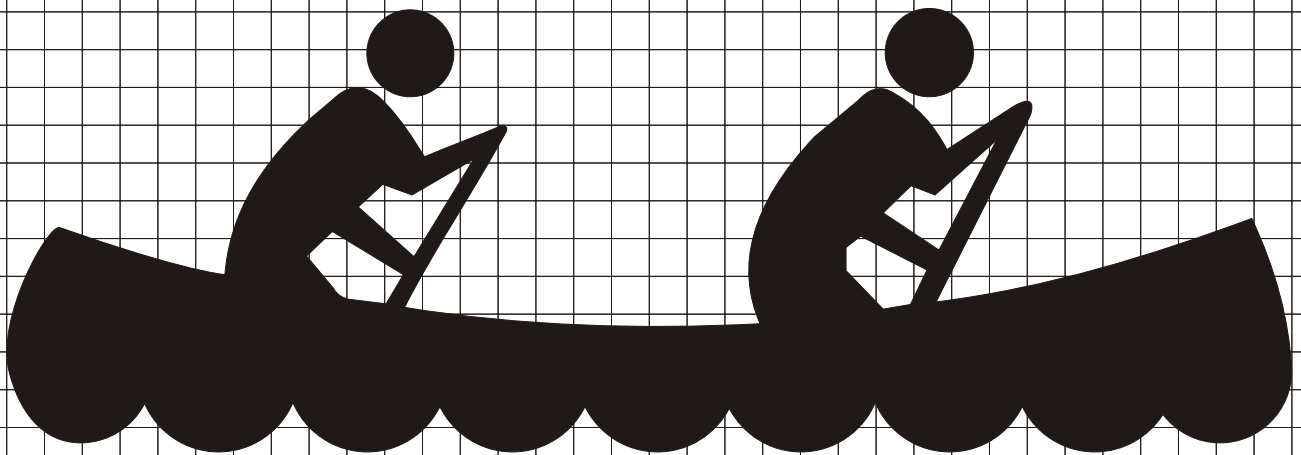

RW020

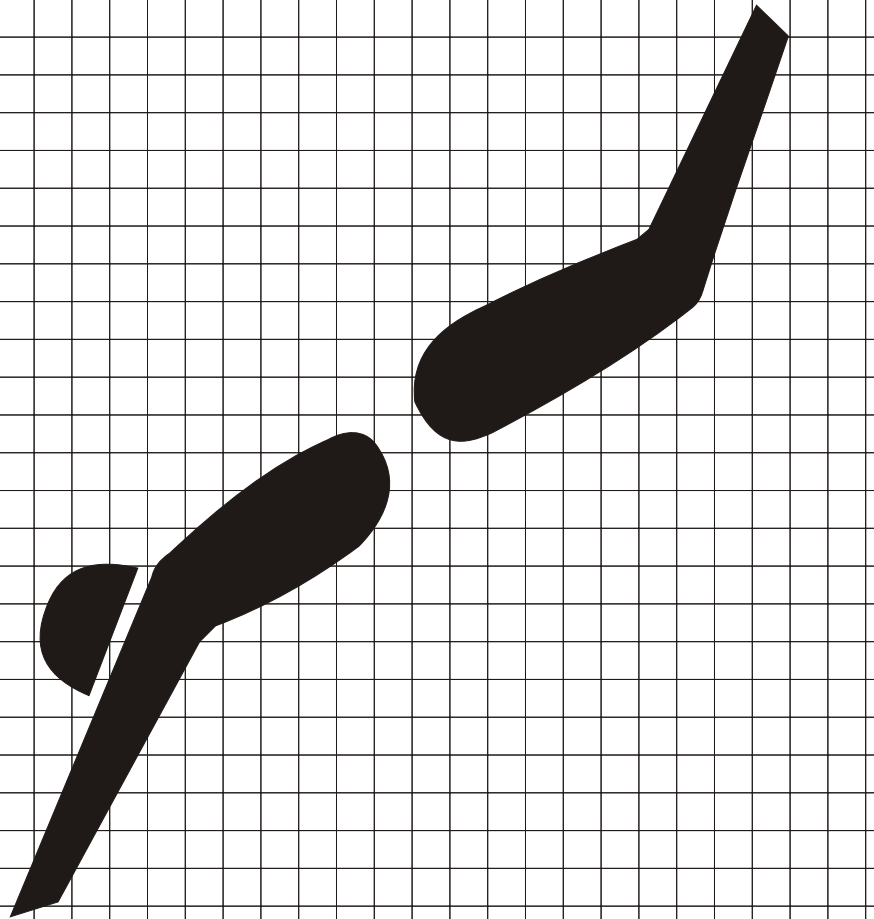

RW-030

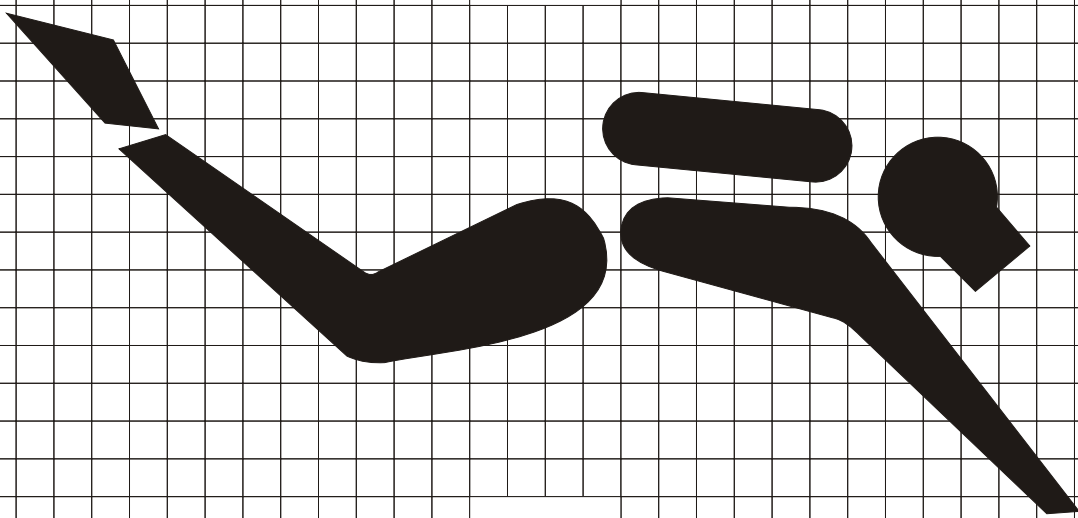

RW040

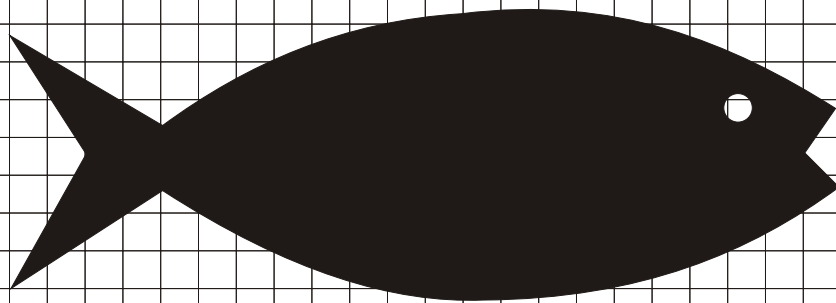

RW-050

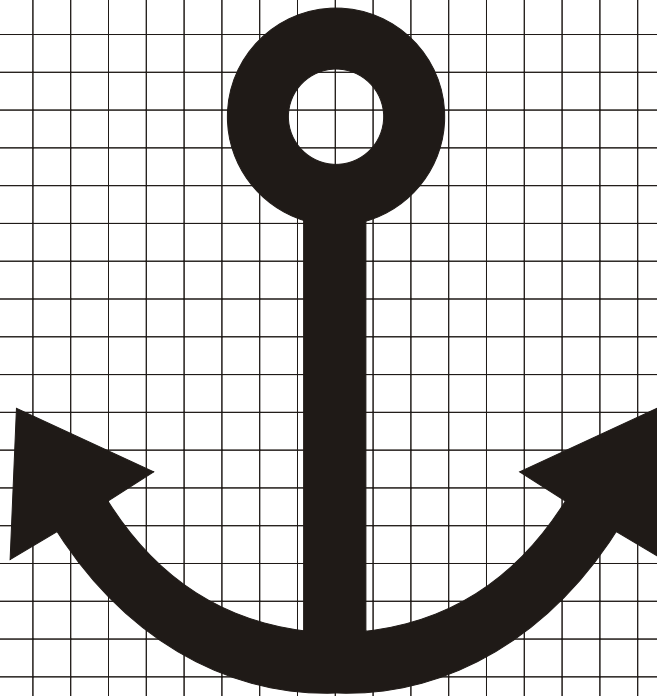

RW060

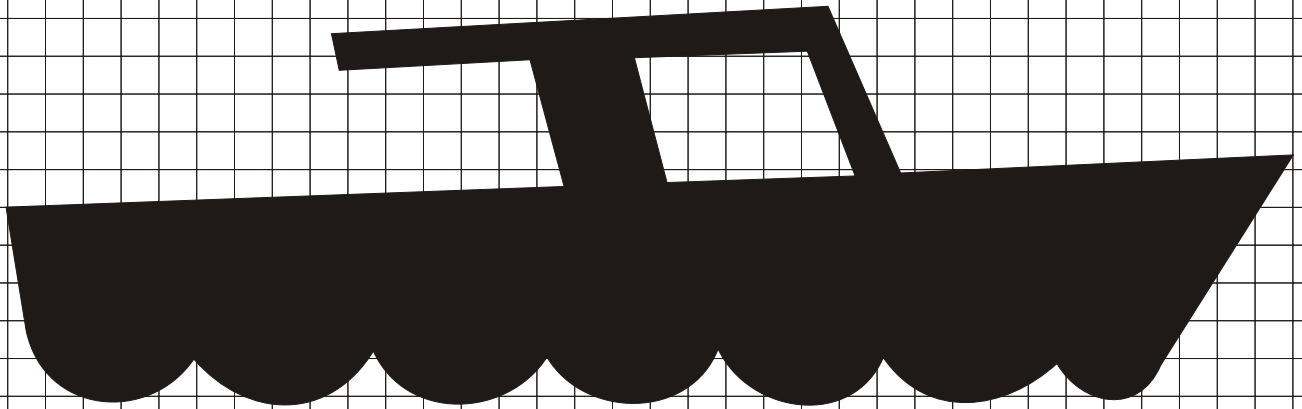

RW-070

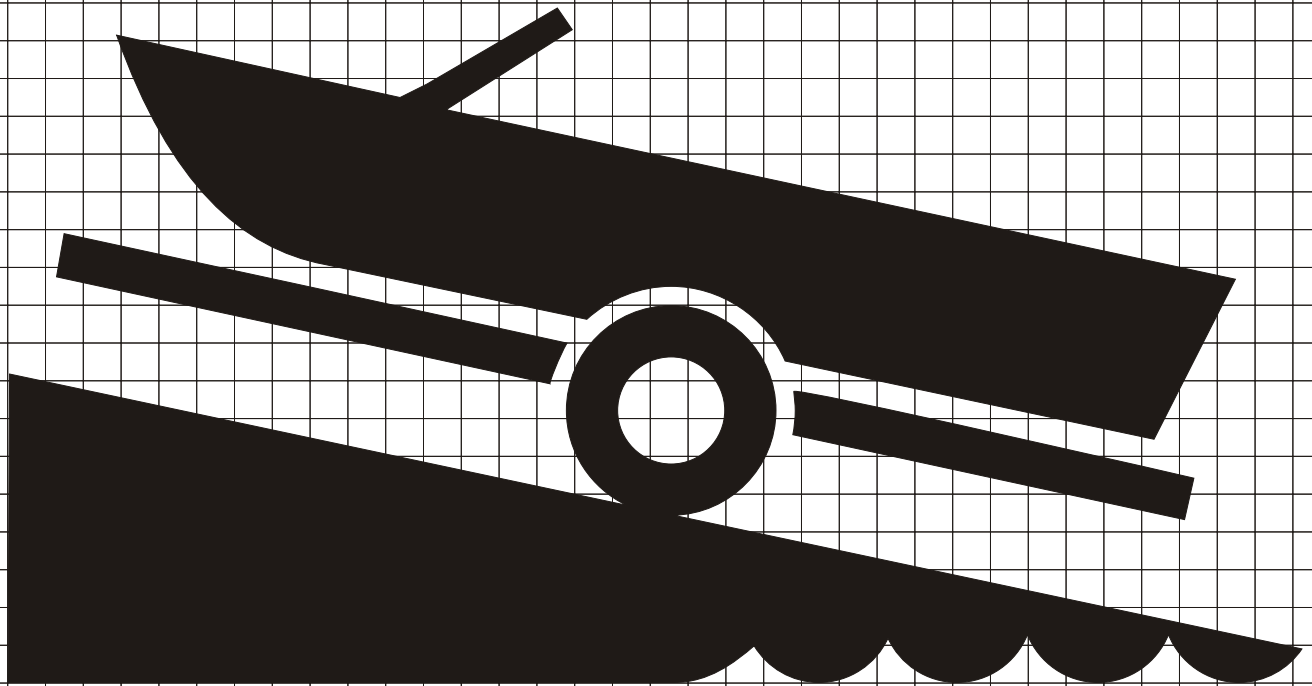

RW080

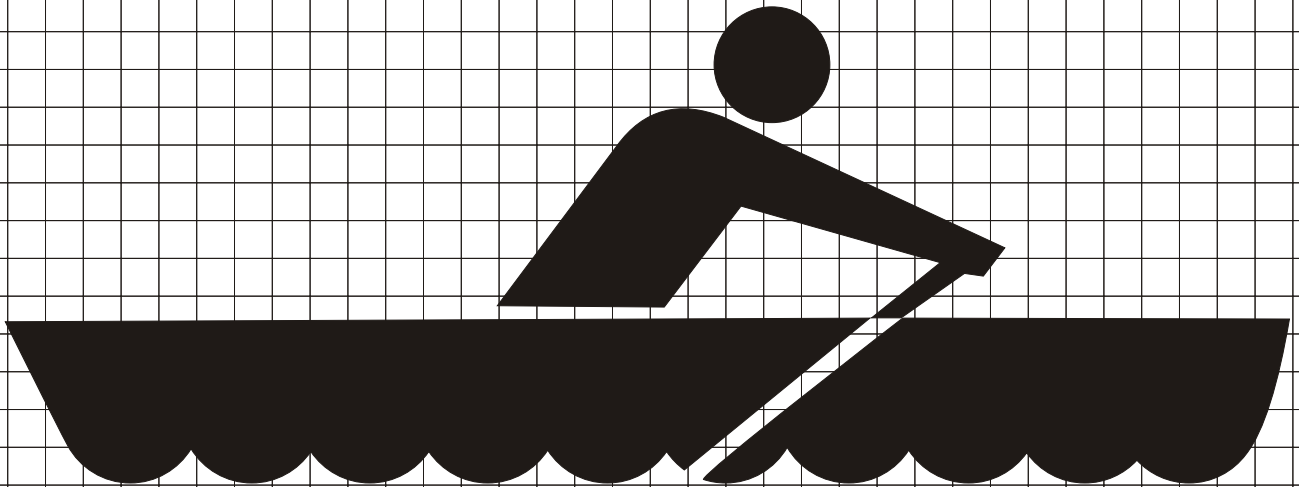

RW-090

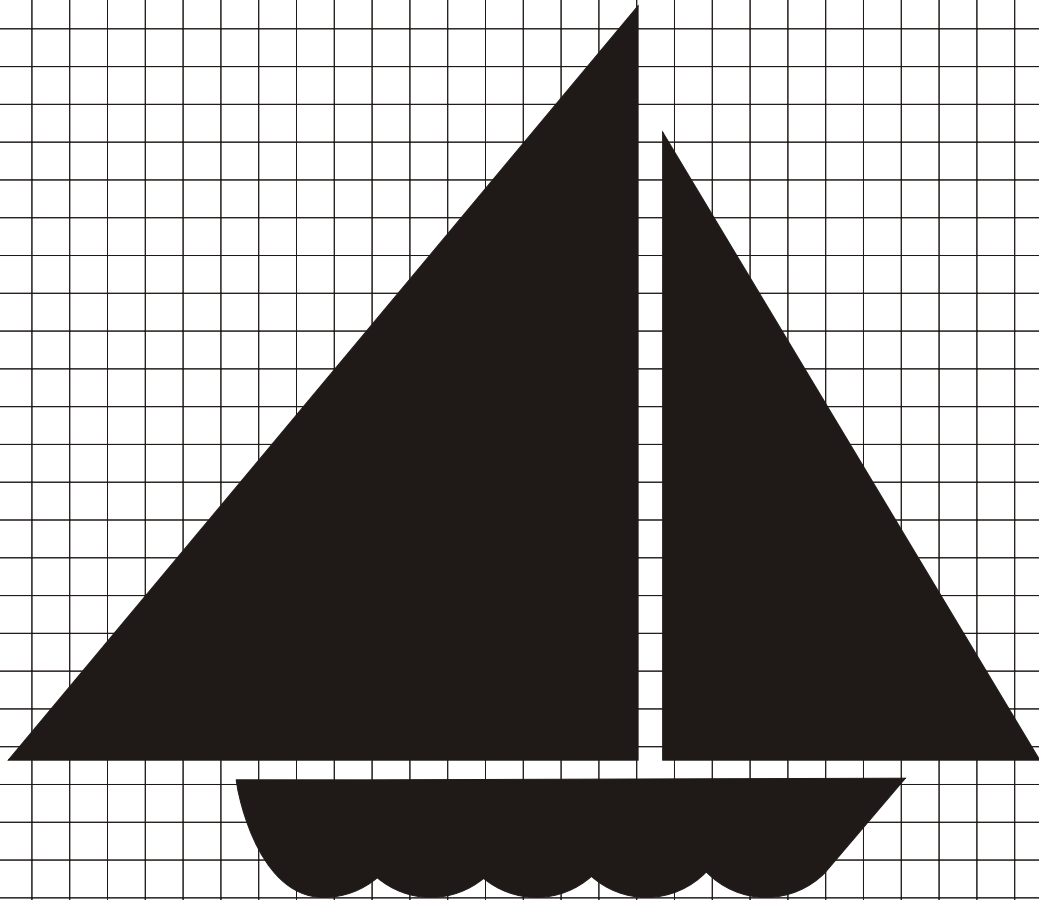

RW100

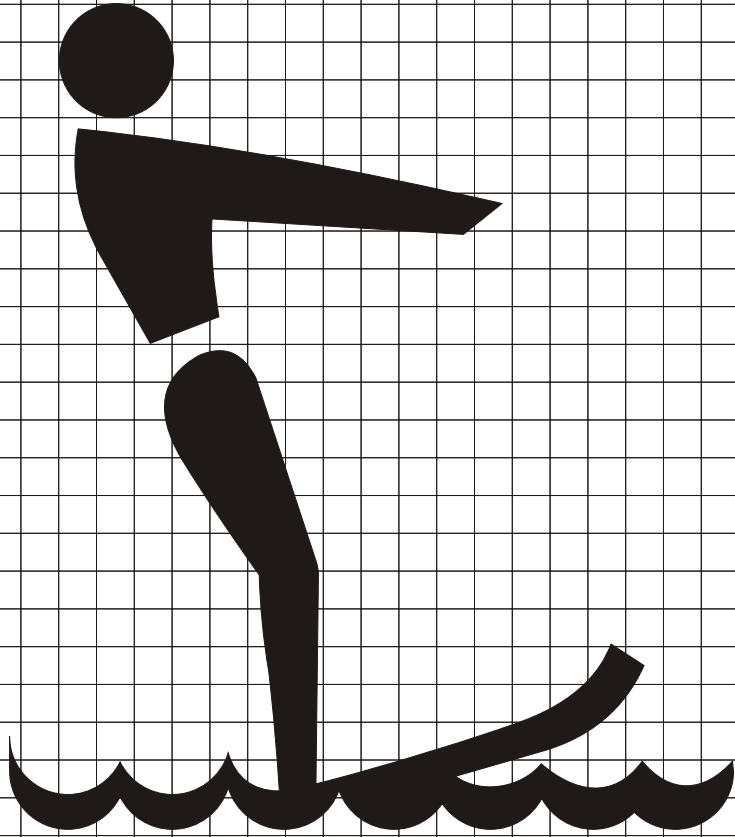

RW-110



RW120

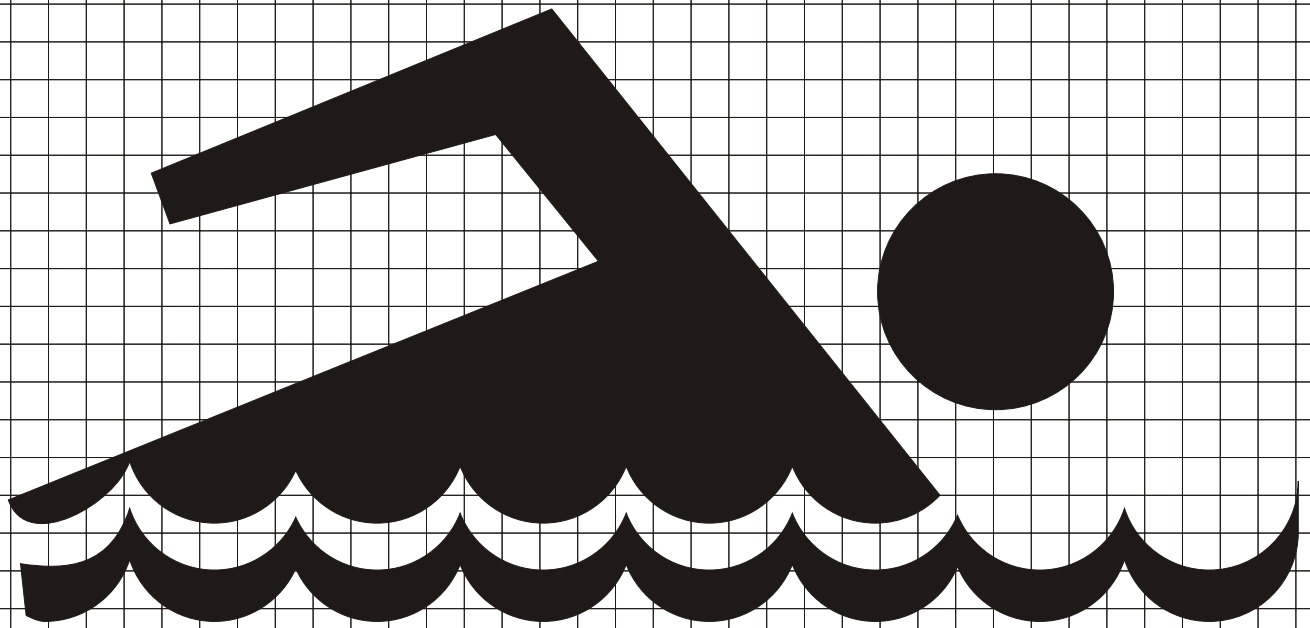

RW-130

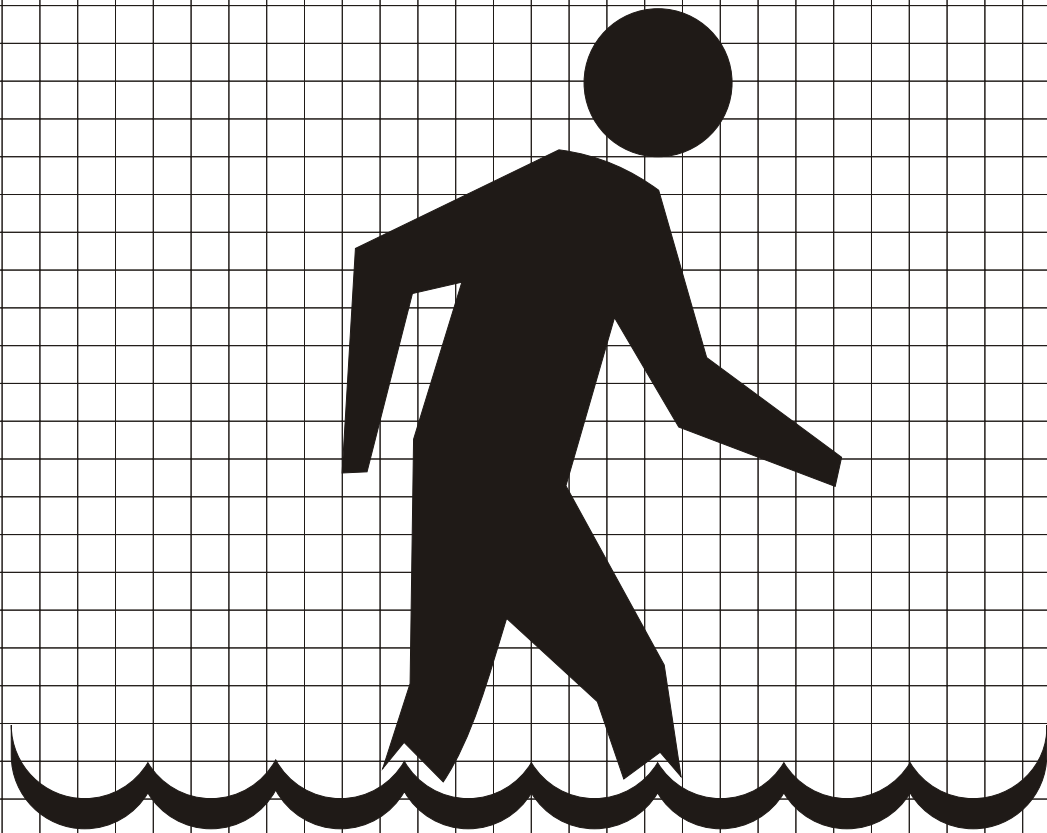

RW140

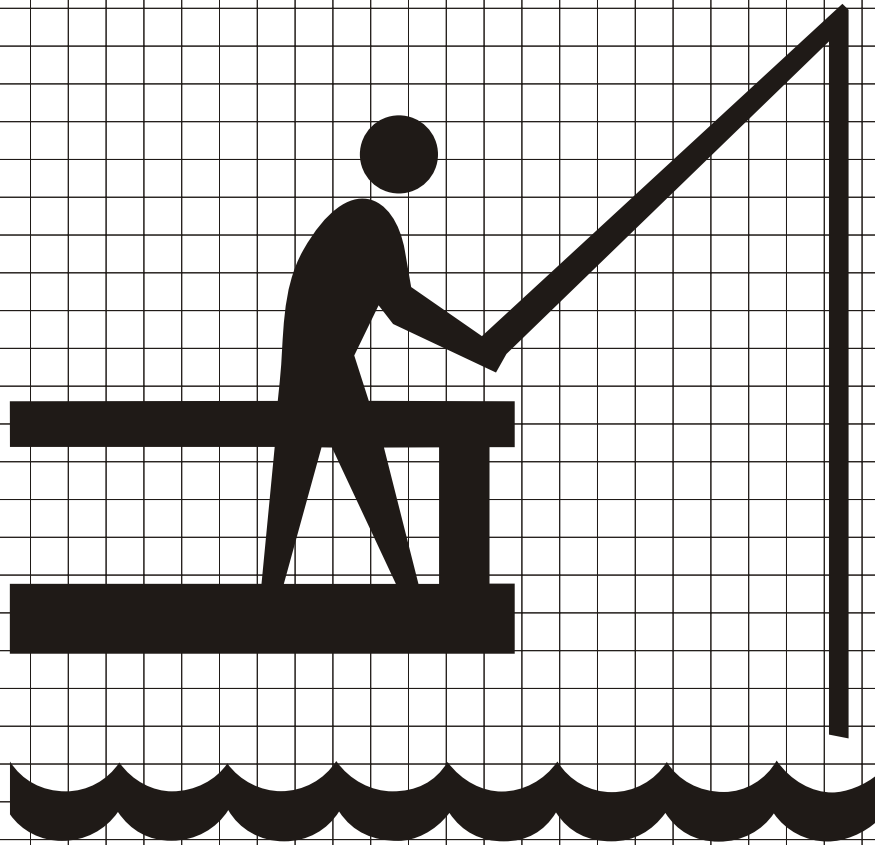

RW-160



RW170

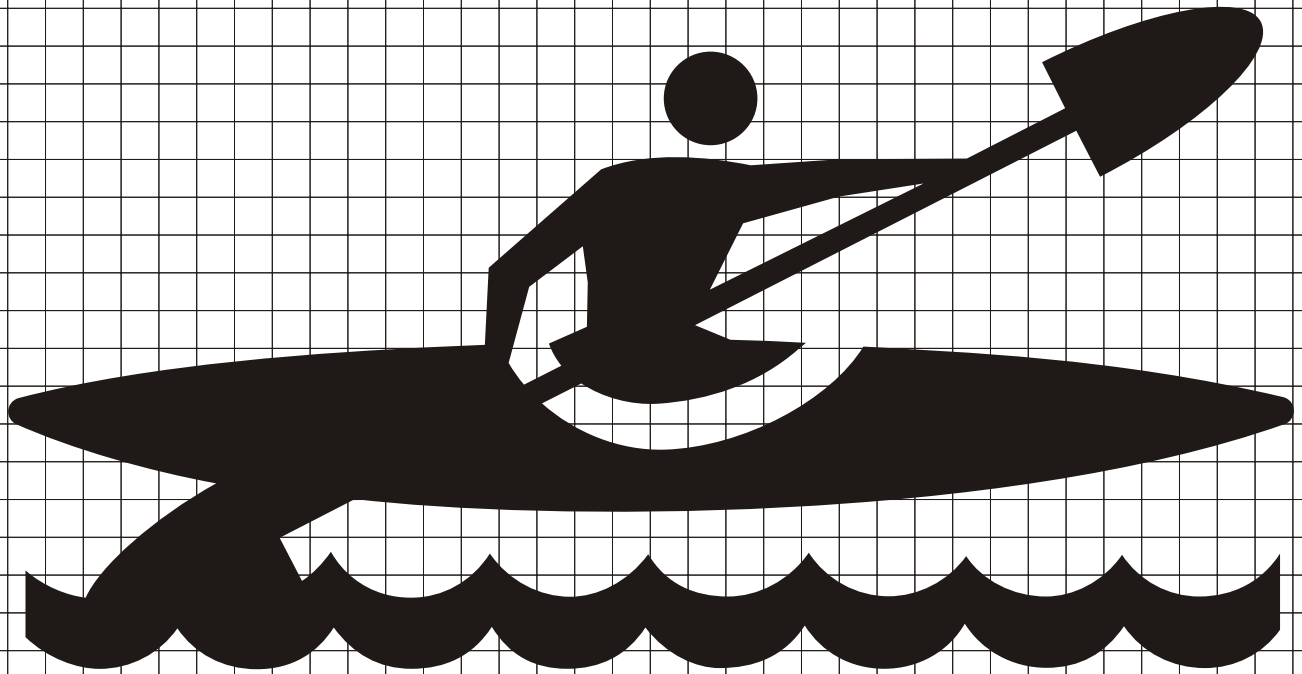

RW-190

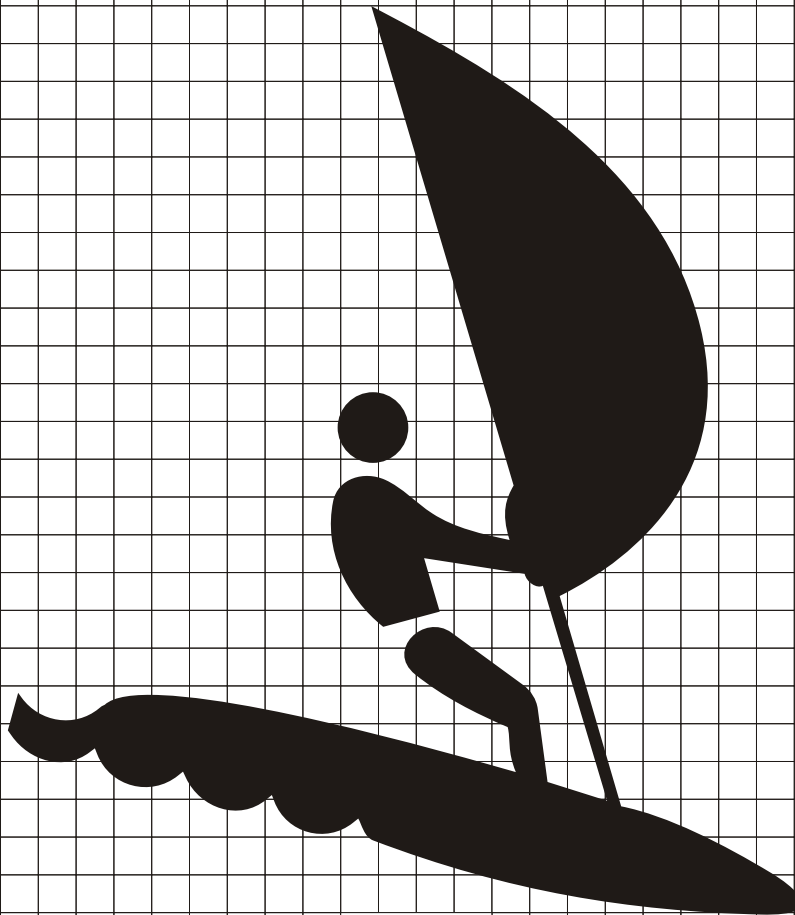

RW-210

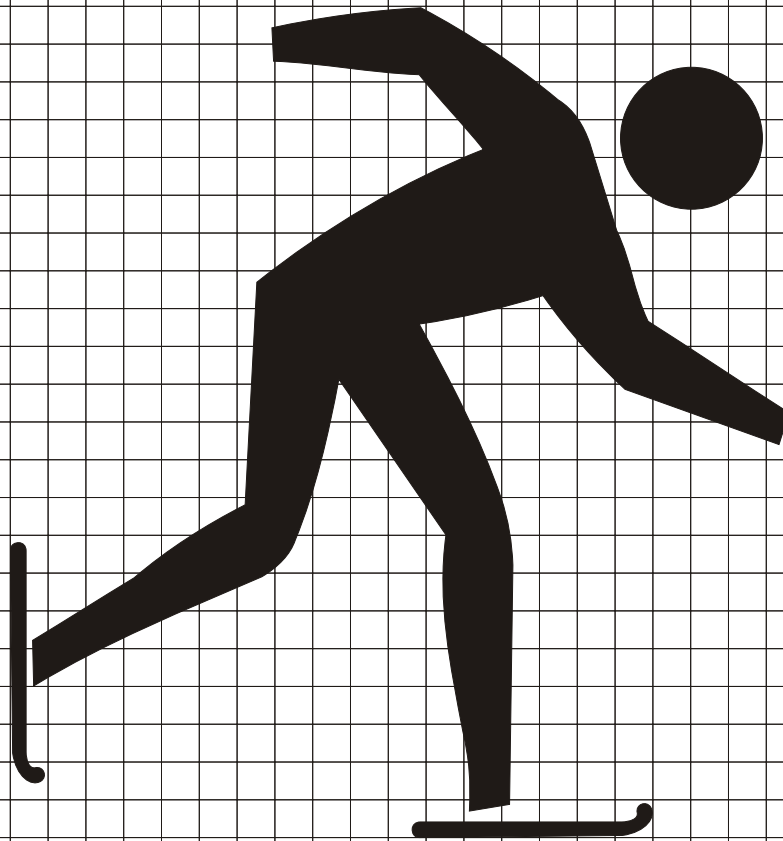

RS-010



RS-020

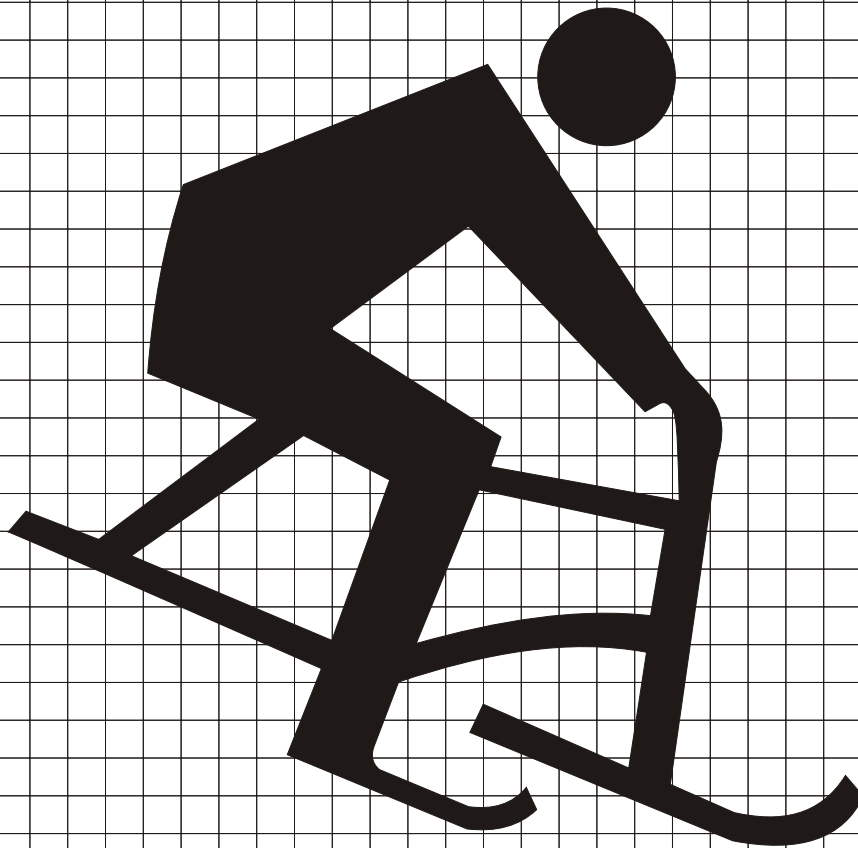

RS-030

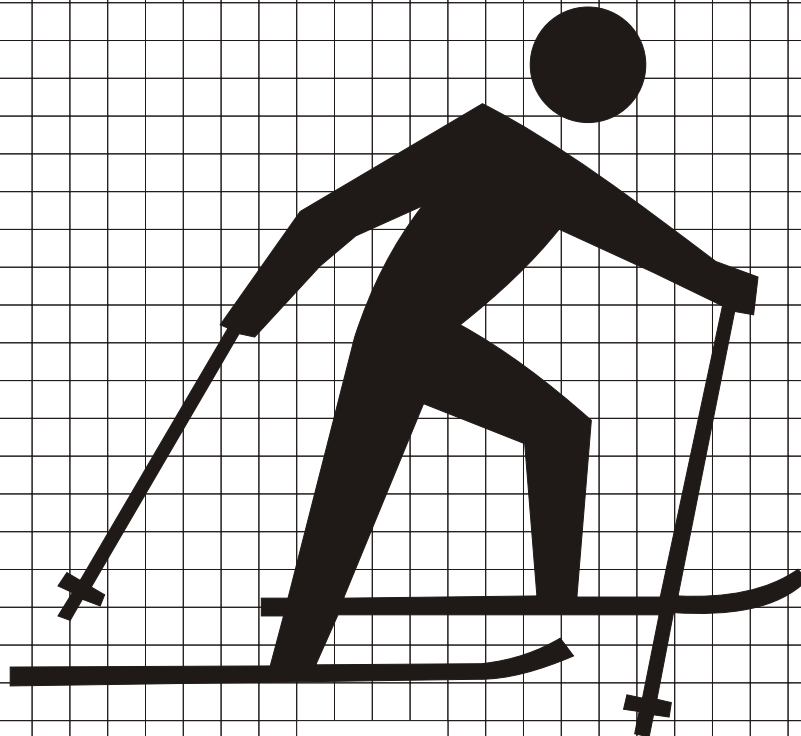

RS-040

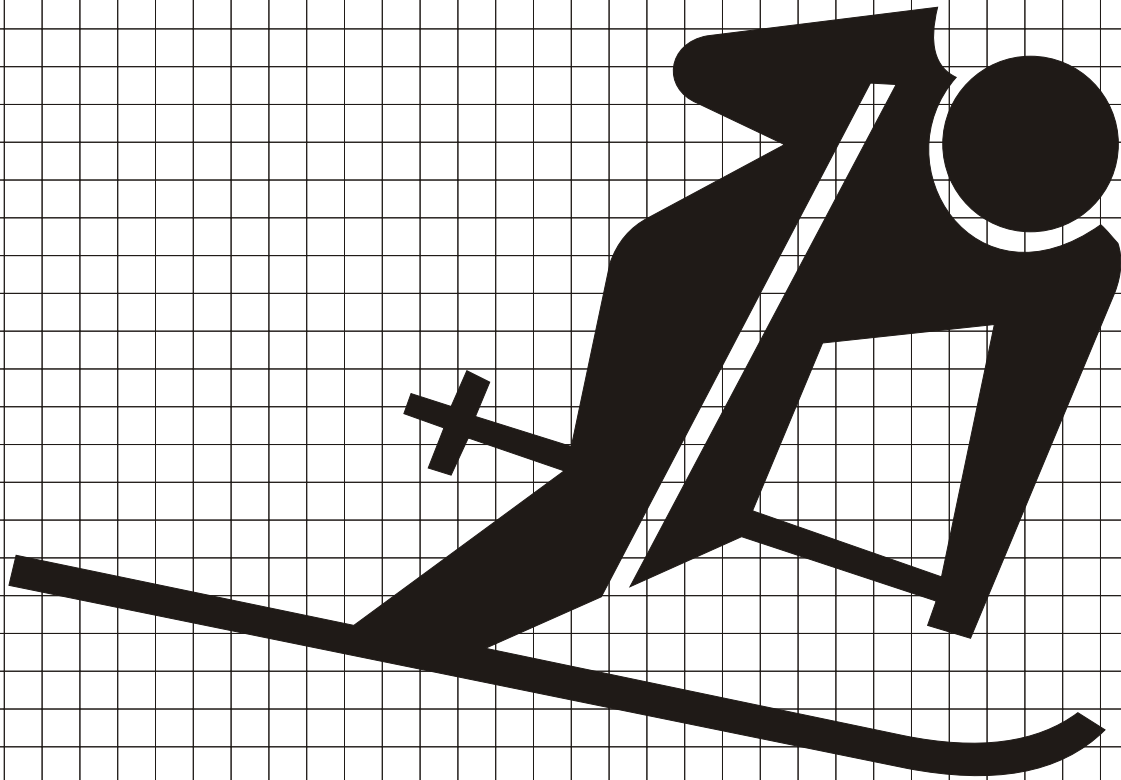

RS-050

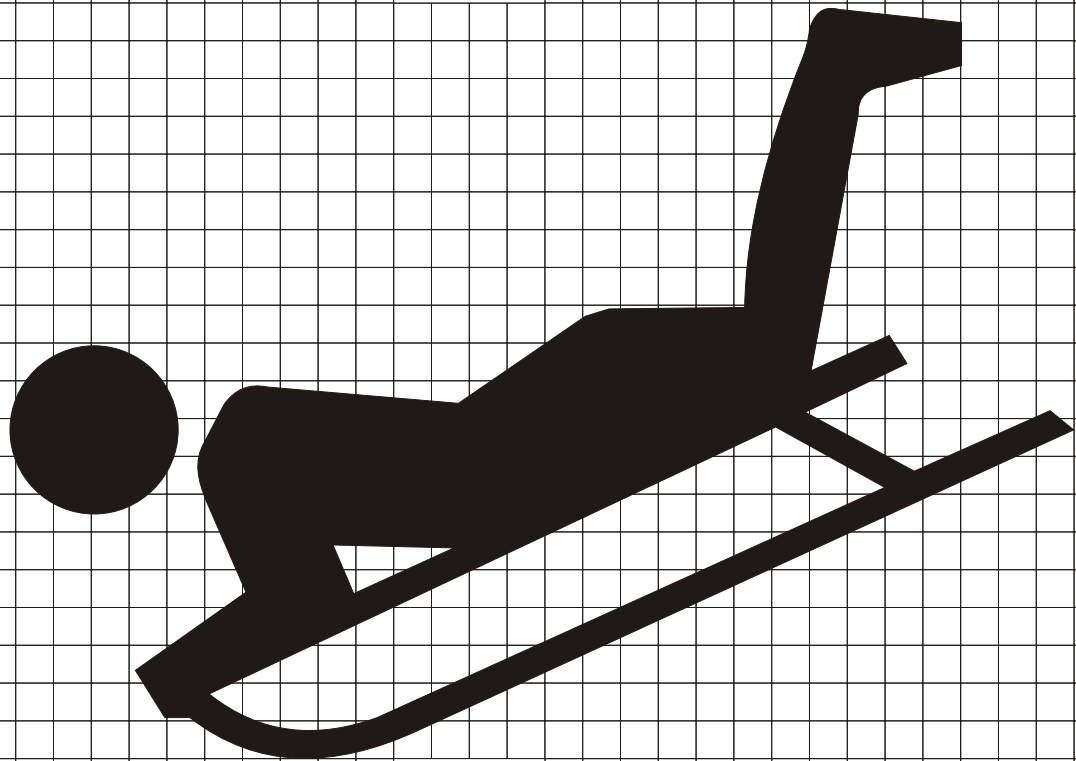

RS-060

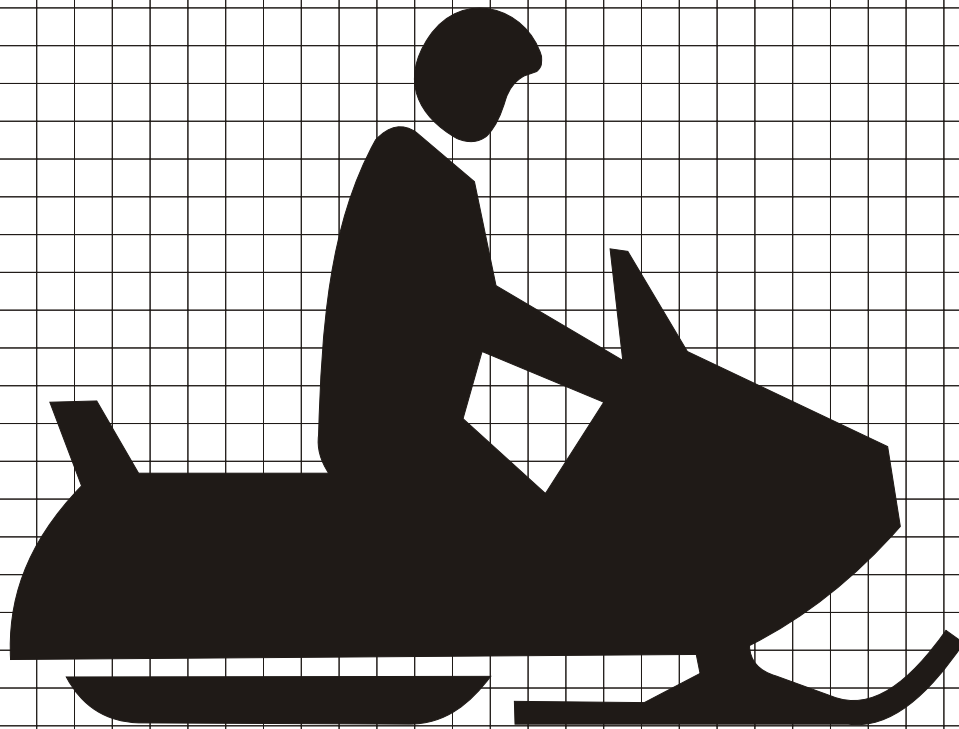

RS-070

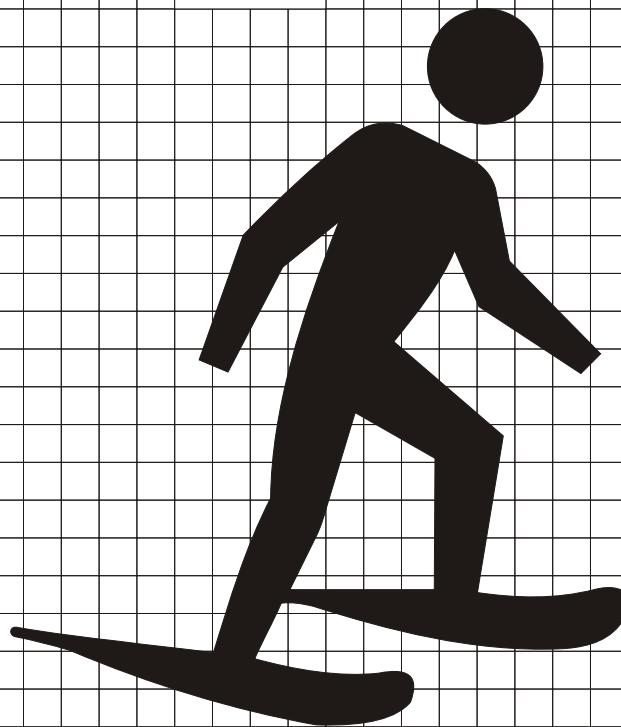

RS-080

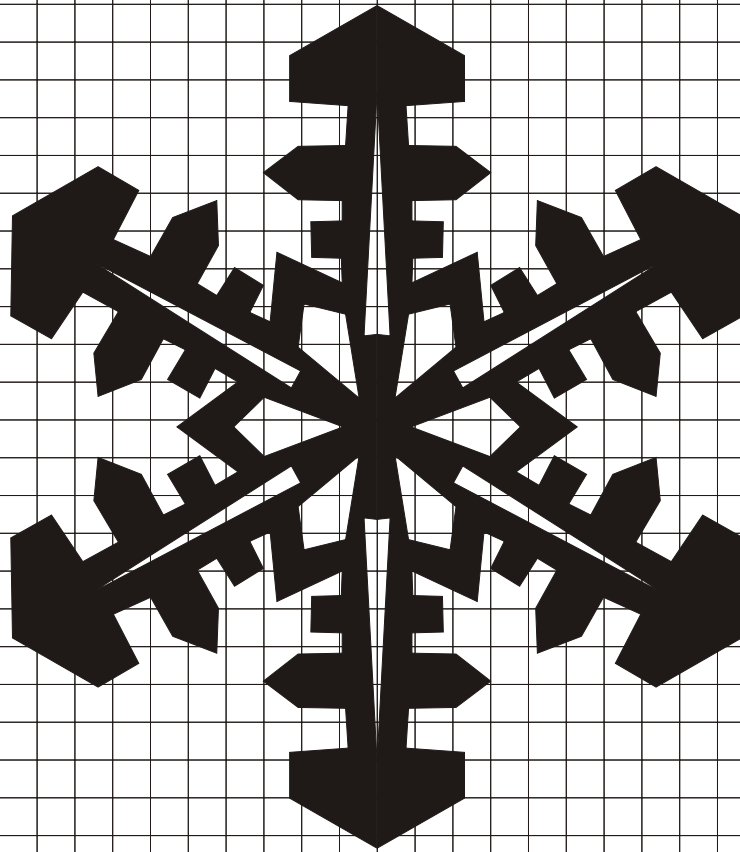

RS-090

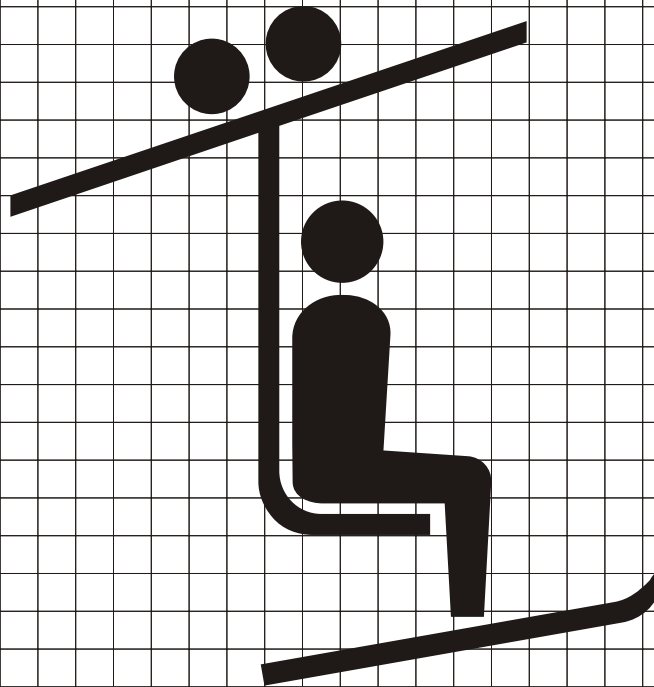

RS-100