

Centre No.						Paper Reference					Surname	Initial(s)			
Candidate No.						5	5	4	0	F	/	1	F	Signature	

Paper Reference(s)

5540F/1F

Edexcel GCSE

Mathematics A (Linear) – 2540

Paper 1 (Non-Calculator)

Foundation Tier

Monday 19 May 2008 – Morning

Time: 1 hour 30 minutes

Examiner's use only

--	--	--

Team Leader's use only

--	--	--



Materials required for examination

Ruler graduated in centimetres and millimetres, protractor, compasses, pen, HB pencil, eraser.
Tracing paper may be used.

Items included with question papers

Nil

Instructions to Candidates

In the boxes above, write your centre number, candidate number, your surname, initials and signature.

Check that you have the correct question paper.

Answer ALL the questions. Write your answers in the spaces provided in this question paper.

You must NOT write on the formulae page.

Anything you write on the formulae page will gain NO credit.

If you need more space to complete your answer to any question, use additional answer sheets.

Information for Candidates

The marks for individual questions and the parts of questions are shown in round brackets: e.g. (2).

There are 29 questions in this question paper. The total mark for this paper is 100.

There are 28 pages in this question paper. Any blank pages are indicated.

Calculators must not be used.

Advice to Candidates

Show all stages in any calculations.

Work steadily through the paper. Do not spend too long on one question.

If you cannot answer a question, leave it and attempt the next one.

Return at the end to those you have left out.

This publication may be reproduced only in accordance with Edexcel Limited copyright policy.
©2008 Edexcel Limited.

Lots more free papers at
<http://bland.in>

W850/R5540F/57570 6/6/6/3



Turn over

edexcel 
advancing learning, changing lives

GCSE Mathematics (Linear) 2540

Formulae: Foundation Tier

**You must not write on this formulae page.
Anything you write on this formulae page will gain NO credit.**

Area of trapezium = $\frac{1}{2}(a + b)h$

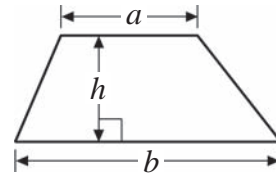

Volume of prism = area of cross section \times length

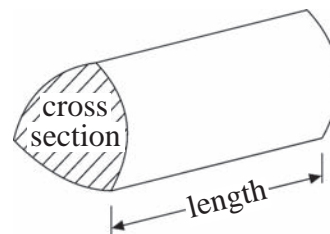

Answer ALL TWENTY NINE questions.

Write your answers in the spaces provided.

You must write down all stages in your working.

You must NOT use a calculator.

1. (a) Write the number 3187 to the nearest thousand.

.....
(1)

- (b) Write the number **four thousand six hundred and eighty one** in figures.

.....
(1)

- (c) Write the number 5060 in words.

.....
(1)

(Total 3 marks)

Q1

2.



- (a) Measure the length of the line *AB*.
Give the units with your answer.

.....
(2)

- (b) On the diagram, mark with a cross (×) the midpoint of the line *AB*.

(1)

(Total 3 marks)

Q2



3. Sharif buys some fruit.

The pictogram shows information about the number of apples and the number of oranges he buys.

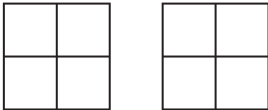
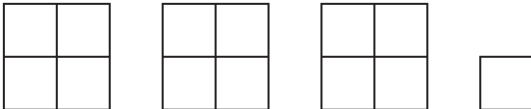
Apples	
Oranges	
Peaches	

Key:  represents 8 fruit

(a) Write down the number of apples he buys.

.....
(1)

(b) Write down the number of oranges he buys.

.....
(1)

Sharif buys 12 peaches.

(c) Use this information to complete the pictogram.

(1)

(Total 3 marks)

Q3



4. (a) Write these numbers in order of size.
Start with the smallest number.

17 6 168 24

.....
(1)

- (b) Write these numbers in order of size.
Start with the smallest number.

1.8 3.71 0.5 12.4

.....
(1)

(Total 2 marks)

Q4

5. The total cost of these 2 pens is 60p.

Work out the total cost of 5 of these pens.
Give your answer in pounds.

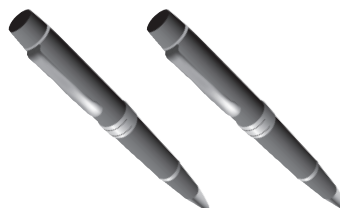

£

(Total 3 marks)

Q5



6. The table shows the distances in kilometres between 5 cities.

Hull				
100	Leeds			
162	73	Manchester		
110	60	65	Sheffield	
63	40	118	95	York

(a) Write down the distance between Hull and Manchester.

..... km
(1)

(b) From the table, write down the name of the city which is

(i) nearest to Hull,

.....

(ii) 60 km from Sheffield.

.....
(2)

(Total 3 marks)

Q6



7.

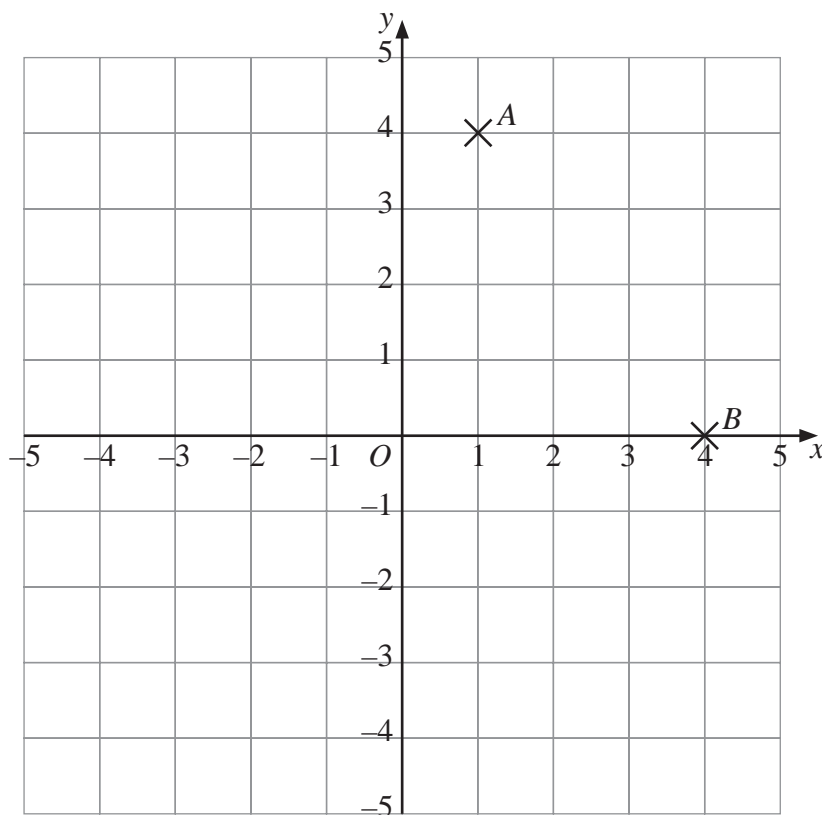

(a) (i) Write down the coordinates of the point A .

(..... ,)

(ii) Write down the coordinates of the point B .

(..... ,)
(2)

(b) (i) On the grid, plot the point $(3, 2)$.
Label this point P .

(ii) On the grid, plot the point $(-4, 3)$.
Label this point Q .

(2)

Q7

(Total 4 marks)



8. Steve asked his friends to tell him their favourite colour.

Here are his results.

Favourite colour	Tally	Frequency
Red		6
Blue		8
Green		5
Yellow		3

(a) Complete the bar chart to show his results.

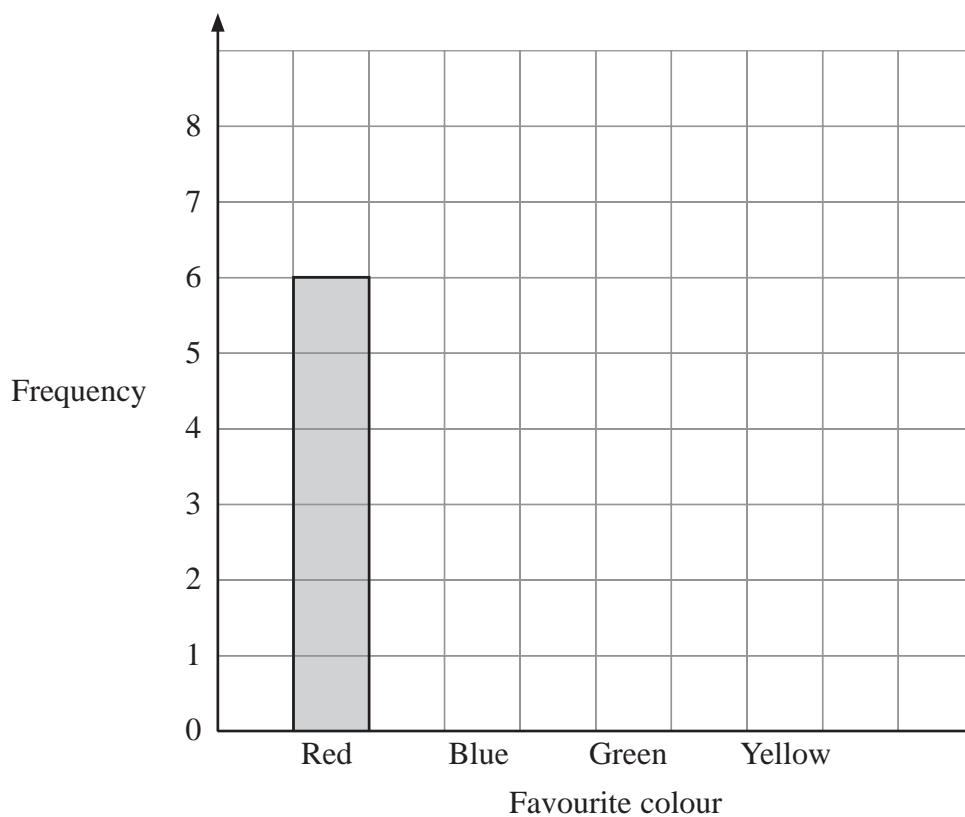

(2)

(b) Which colour did most of his friends say?

.....

(1)

(Total 3 marks)

Q8

9.

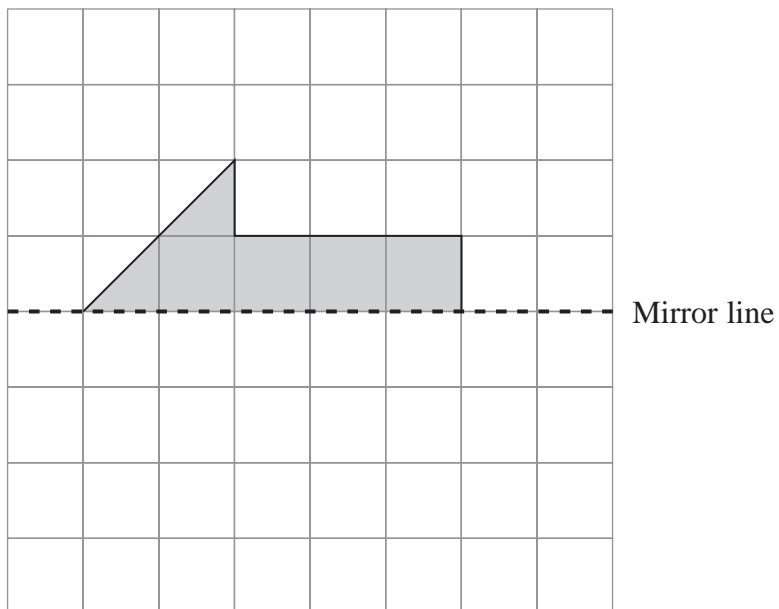

(a) Reflect the shaded shape in the mirror line.

(1)

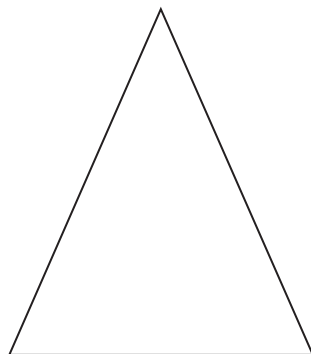

(b) Draw the line of symmetry on this triangle.

(1)

(Total 2 marks)

Q9

10. Work out

(i) $3 \times 3 - 5$

.....

(ii) $20 \div (12 - 2)$

.....

(iii) $7 + 8 \div 4$

.....

(Total 3 marks)

Q10

11. (a) Here are some fractions.

$$\frac{2}{4} \quad \frac{4}{8} \quad \frac{2}{5} \quad \frac{7}{14}$$

Which one of these fractions is **not** equal to $\frac{1}{2}$?

.....

Give a reason for your answer.

.....

.....

(2)

(b) Work out $\frac{3}{4}$ of 20

.....

(2)

(Total 4 marks)

Q11



12. $P = 3n$
 $n = 6$

(a) Work out the value of P .

$P = \dots\dots\dots$
(1)

$Q = 2c + d$
 $c = 3$
 $d = 2$

(b) Work out the value of Q .

$Q = \dots\dots\dots$
(2)

(Total 3 marks)

Q12

13. (a) Complete the table by writing a sensible **metric** unit for each measurement. The first one has been done for you.

The length of the river Nile	6700 <u>kilometres</u>
The height of the world's tallest tree	110
The weight of a chicken's egg	70
The amount of petrol in a full petrol tank of a car	40

(3)

(b) Change 4 metres to centimetres.

..... cm
(1)

(c) Change 1500 grams to kilograms.

..... kg
(1)

(Total 5 marks)

Q13

14. There are three beads in a bag.
One bead is blue, one bead is yellow and one bead is green.

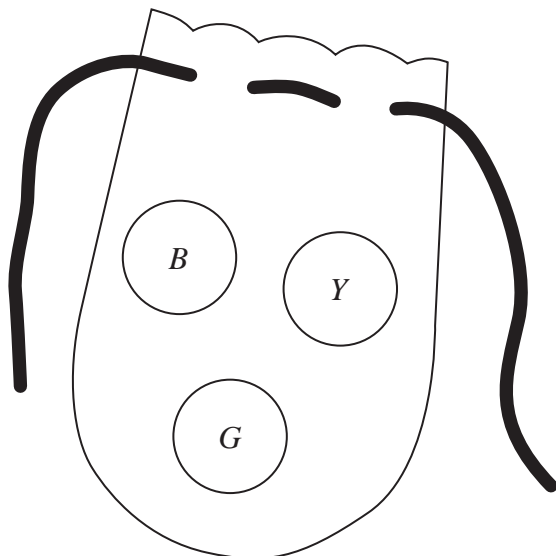

Zoe takes a bead at random from the bag.

- (a) On the probability scale, mark with the letter *B* the probability that she takes a blue bead.

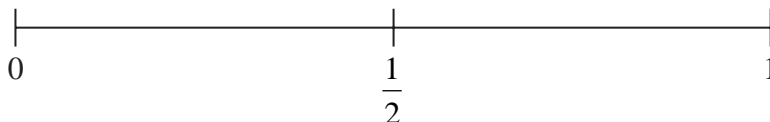

(1)

Zoe now throws a coin.

One possible outcome for the bead and the coin is (green, heads).

- (b) List all the possible outcomes for the bead and the coin.
One has already been done for you.

(green, heads)
.....
.....

(2)

(Total 3 marks)

Q14

15. (a)

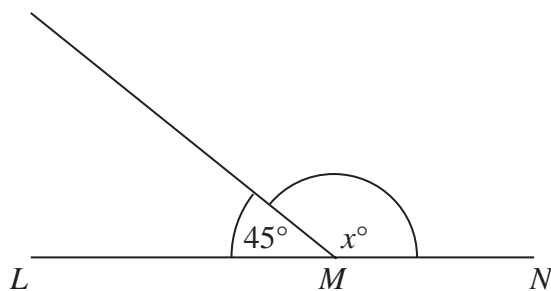

Diagram **NOT** accurately drawn

LMN is a straight line.

(i) Work out the value of x .

$x = \dots\dots\dots$

(ii) Give a reason for your answer.

.....

(2)

(b)

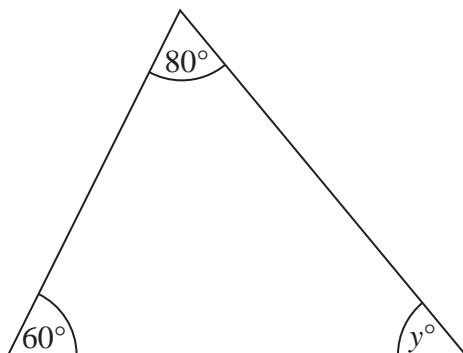

Diagram **NOT** accurately drawn

Work out the value of y .

$y = \dots\dots\dots$

(2)

Q15

(Total 4 marks)

16. (a) Write 92% as a decimal.

.....
(1)

(b) Write 3% as a fraction.

.....
(1)

(c) Work out 5% of 400 grams.

..... grams
(2)

(Total 4 marks)

Q16



17. The diagram shows the position of two airports, *A* and *B*.
A plane flies from airport *A* to airport *B*.

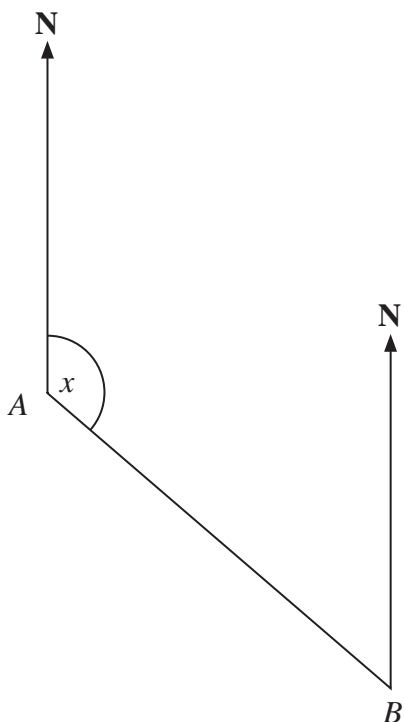

Scale: 1 cm represents 50 km

(a) Measure the size of the angle marked *x*.

.....^o
(1)

(b) Work out the real distance between airport *A* and airport *B*.
Use the scale 1 cm represents 50 km.

..... km
(2)

Airport *C* is 350 km on a bearing of 060° from airport *B*.

(c) On the diagram, mark airport *C* with a cross (×).
Label it *C*.

(2) **Q17**

(Total 5 marks)

18. (a) Complete the table of values for $y = 3x + 1$

x	-3	-2	-1	0	1	2
y	-8		-2			

(2)

(b) On the grid, draw the graph of $y = 3x + 1$

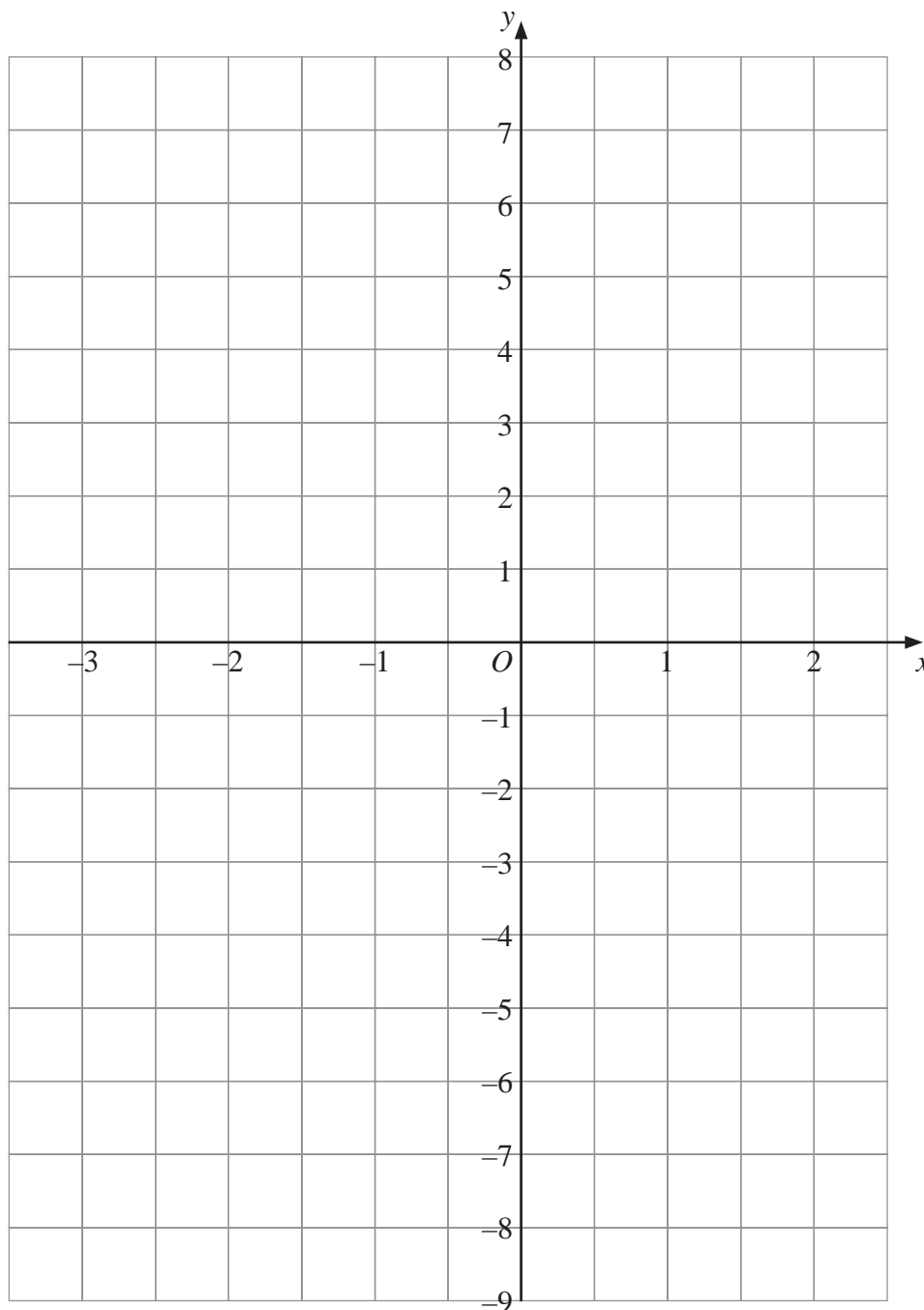

(2)

Q18

(Total 4 marks)

19. Kaysha has a part-time job.
 She is paid £5.40 for each hour she works.
 Last week Kaysha worked for 24 hours.

Work out Kaysha's total pay for last week.

£

(Total 3 marks)

Q19

20. (a) Work out $\frac{1}{3} + \frac{1}{12}$

.....

(2)

(b) Work out $\frac{3}{4} \times \frac{1}{5}$

.....

(1)

(Total 3 marks)

Q20



21. (a) Simplify $d + d + d + d + d$

.....
(1)

(b) Simplify $y^2 + y^2$

.....
(1)

(c) Expand $4(3a - 7)$

.....
(2)

(d) Simplify $t \times t^2$

.....
(1)

(e) Simplify $m^5 \div m^3$

.....
(1)

(Total 6 marks)

Q21



22. Here are the ages, in years, of 15 teachers.

35 52 42 27 36

23 31 41 50 34

44 28 45 45 53

- (a) Draw an ordered stem and leaf diagram to show this information.
You must include a key.

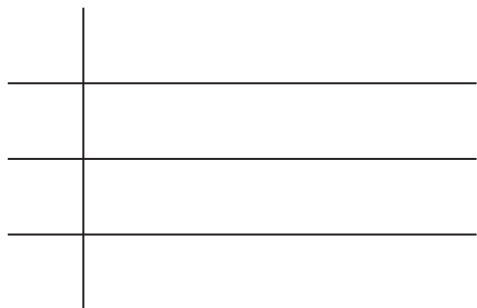

Key:

(3)

One of these teachers is picked at random.

- (b) Work out the probability that this teacher is more than 40 years old.

.....
(2)

(Total 5 marks)

Q22

23. David buys some stamps.
Each stamp costs 25p.
The total cost of the stamps is £3

(a) Work out the number of stamps David buys.

.....
(2)

Adam, Barry and Charlie each buy some stamps.
Adam buys x stamps.
Barry buys three times as many stamps as Adam.

(b) Write down an expression, in terms of x , for the number of stamps Barry buys.

.....
(1)

Charlie buys 5 more stamps than Adam.

(c) Write down an expression, in terms of x , for the number of stamps Charlie buys.

.....
(1)

(Total 4 marks)

Q23



24.

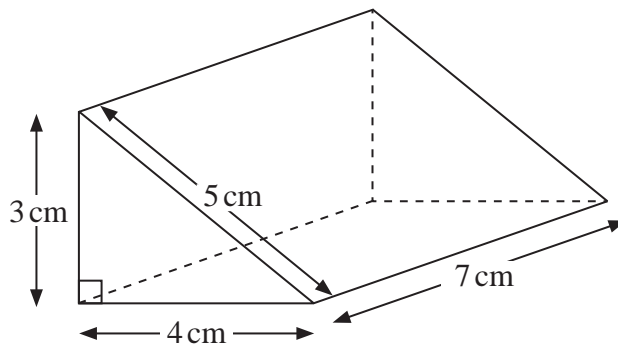

Diagram **NOT** accurately drawn

Work out the total surface area of the triangular prism.

..... cm²

(Total 3 marks)

Q24

25. Using the information that

$$4.8 \times 34 = 163.2$$

write down the value of

(a) 48×34

.....
(1)

(b) 4.8×3.4

.....
(1)

(c) $163.2 \div 48$

.....
(1)

(Total 3 marks)

Q25

26. Work out an estimate for

$$\frac{302 \times 9.96}{0.51}$$

.....
(Total 3 marks)

Q26



27. In the space below, use ruler and compasses to **construct** an equilateral triangle with sides of length 6 centimetres.

You must show all your construction lines.

One side of the triangle has already been drawn for you.



(Total 2 marks)

Q27

28. $-2 \leq x < 3$
 x is an integer.

Write down all the possible values of x .



(Total 2 marks)

Q28

29.

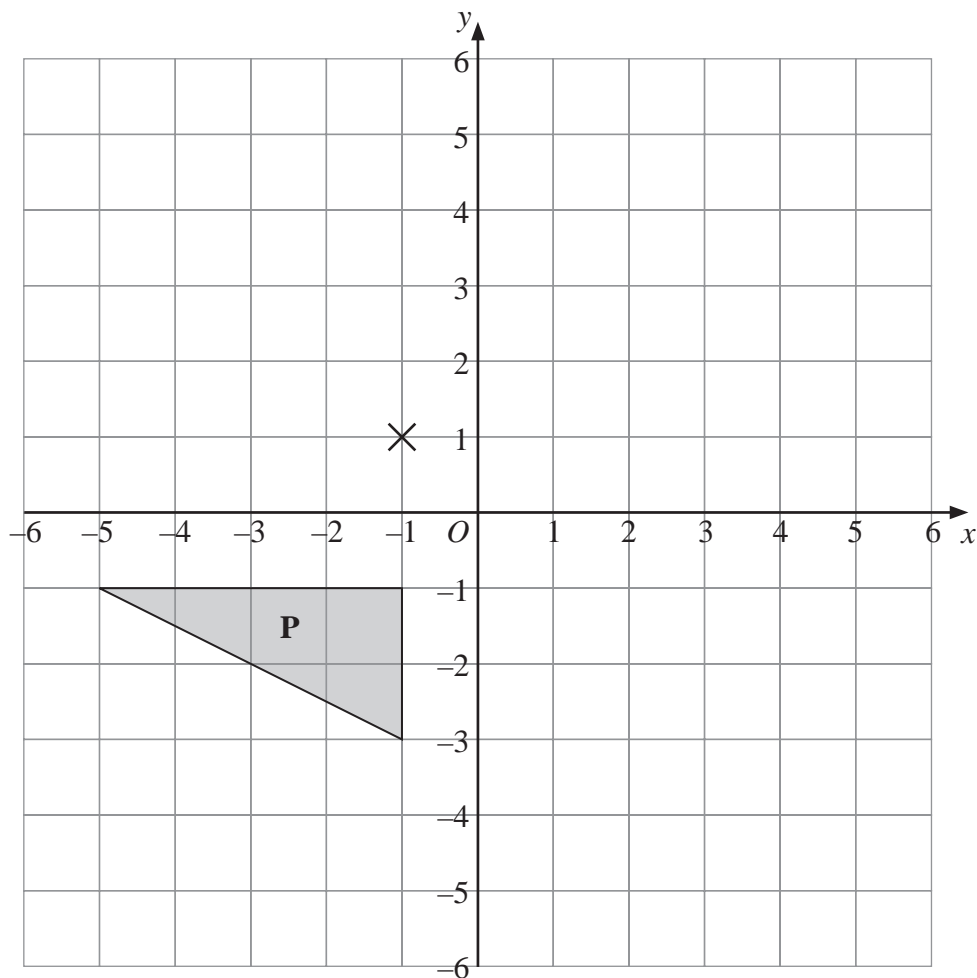

(a) Rotate triangle **P** 180° about the point $(-1, 1)$.

Label the new triangle **A**.

(2)

(b) Translate triangle **P** by the vector $\begin{pmatrix} 6 \\ -1 \end{pmatrix}$.

Label the new triangle **B**.

(1)

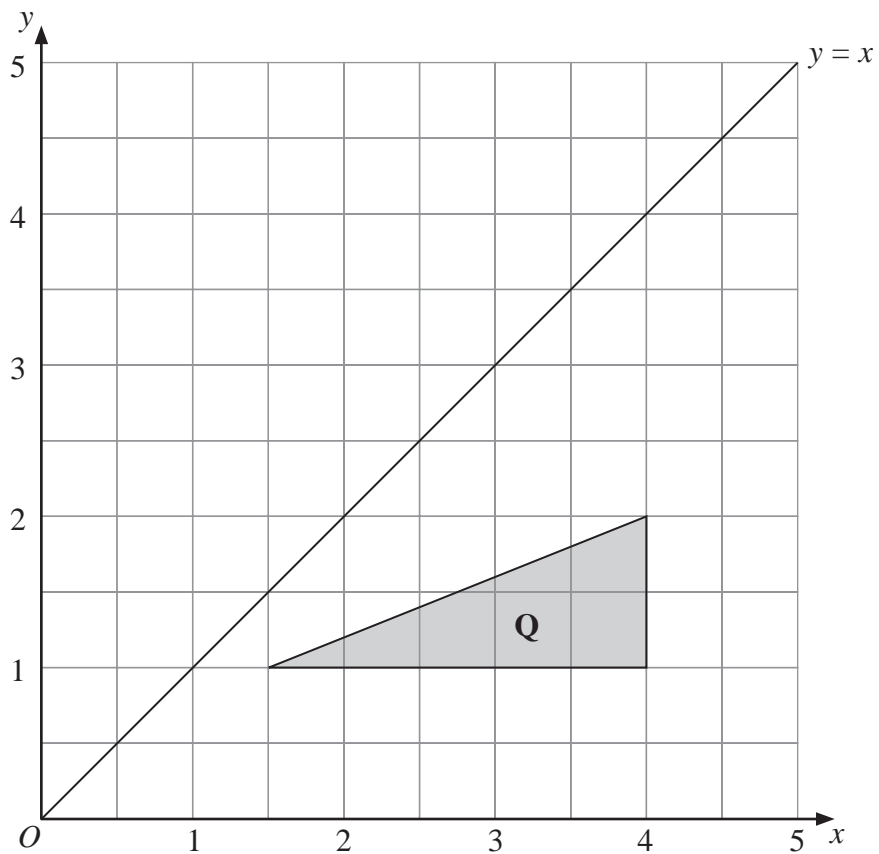

(c) Reflect triangle **Q** in the line $y = x$.

Label the new triangle **C**.

(2)

Q29

(Total 5 marks)

TOTAL FOR PAPER: 100 MARKS

END

BLANK PAGE



BLANK PAGE



BLANK PAGE

