



# **White Paper Blu-ray Disc™ Format**

**General**

**2<sup>nd</sup> Edition**

**October, 2010**

**White Paper Blu-ray Disc™ Format  
General**

Condition of Publication

---

**COPYRIGHT**

All rights reserved. This document contains information that is proprietary information of the Blu-ray Disc Association and its members and may not be used, copied or distributed without the written permission of the Blu-ray Disc Association or its License Office. All other use, copying and distribution are prohibited.

**TRADEMARK**

Blu-ray Disc™, Blu-ray™, Blu-ray 3D™, BD-Live™, BONUSVIEW™, BDXL™, AVCREC™, and the logos are trademarks of the Blu-ray Disc Association.

**DISCLAIMER**

The information contained herein is believed to be accurate as of the date of publication. However, none of the Blu-ray Disc Association, its Members, or its License Office will be liable for any damages, including indirect or consequential, from use of the White Paper or reliance on the accuracy of this document.

**LICENSING**

License is required from the Blu-ray Disc Association for the application of the System Description Blu-ray Disc™ Format in both disc and equipment products.

**NOTICE**

For any further explanation of the contents of this document, or in case of any perceived inconsistency or ambiguity of interpretation, please consult with:

Blu-ray Disc Association

License Office

10 Universal City Plaza, T-100,  
Universal City, CA 91608 U.S.A.

Fax.: +1-818-763-9027

Web Site: <http://www.blu-raydisc.info>

E-mail: [agent@blu-raydisc.info](mailto:agent@blu-raydisc.info)

## INDEX

### 1. General

#### 1.1 The objective of Blu-ray Disc™ format

#### 1.2 Optimization of the Cover Layer thickness

#### 1.3 Blu-ray Disc™ format

##### 1.3.1 Blu-ray Disc™ format overview

##### 1.3.2 Physical format

##### 1.3.3 Outline of the file system application format

###### 1.3.3.1 Application format

###### 1.3.3.2 File System format

#### 1.4 Multi Layer disc

##### 1.4.1 Dual Layer disc

##### 1.4.2 Triple Layer disc and Quadruple Layer disc (BDXL™)

##### 1.4.3 Requirements for signal quality

#### 1.5 Contents Protection System and Interface

#### 1.6 Hard-Coating for Bare Discs

#### 1.7 Blu-ray™ discs and Cartridges

#### 1.8 All Books

# 1 General

## 1.1 The Objective of Blu-ray Disc™ format

The standards for 12 cm optical discs, CDs, DVDs, and Blu-ray™ Rewritable discs (BD-RE Standard V1.0) were established in 1982, 1996, and 2002, respectively. The recording capacity required by applications was the important issue when these standards were decided (See Fig.1.1.1). The requirement for CDs was 74 minutes of recording 2-channel audio signals and a capacity of about 800 MB. For DVDs, the requirement as a video disc was the recording of a movie with a length of two hours and fifteen minutes using the SD (Standard Definition) with MPEG-2 compression. The capacity was determined to be 4.7 GB considering the balance with image quality. In the case of the Blu-ray Disc™, abbreviated as BD hereafter, a recording of an HDTV digital broadcast greater than two hours is needed since the BS digital broadcast started in 2000 and terrestrial digital broadcast has begun in 2003. It was a big motivation for us to realize this in an optical disc the recorder. In a DVD recorder, received and decoded video signals are compressed by an MPEG encoder and then recorded on the disc. To record in the same fashion an HDTV broadcast, an HDTV MPEG-2 encoder is required. However, such a device for home use has not yet been produced. In the case of BS digital broadcasts, signals are sent as a program stream at a fixed rate, which is 24 Mbps for one HDTV program. In the program stream of BS digital broadcast there is a case that the additional data stream is multiplexed, and it is desirable to record and read the data as is. Fig.1.1.2 shows the recording capacity with the data transfer rate and recording time parameters. Two hours of recording requires a recording capacity of 22 GB or more. This capacity is about 5 times that of DVDs, which cannot achieve this capacity by merely increasing the recording density.

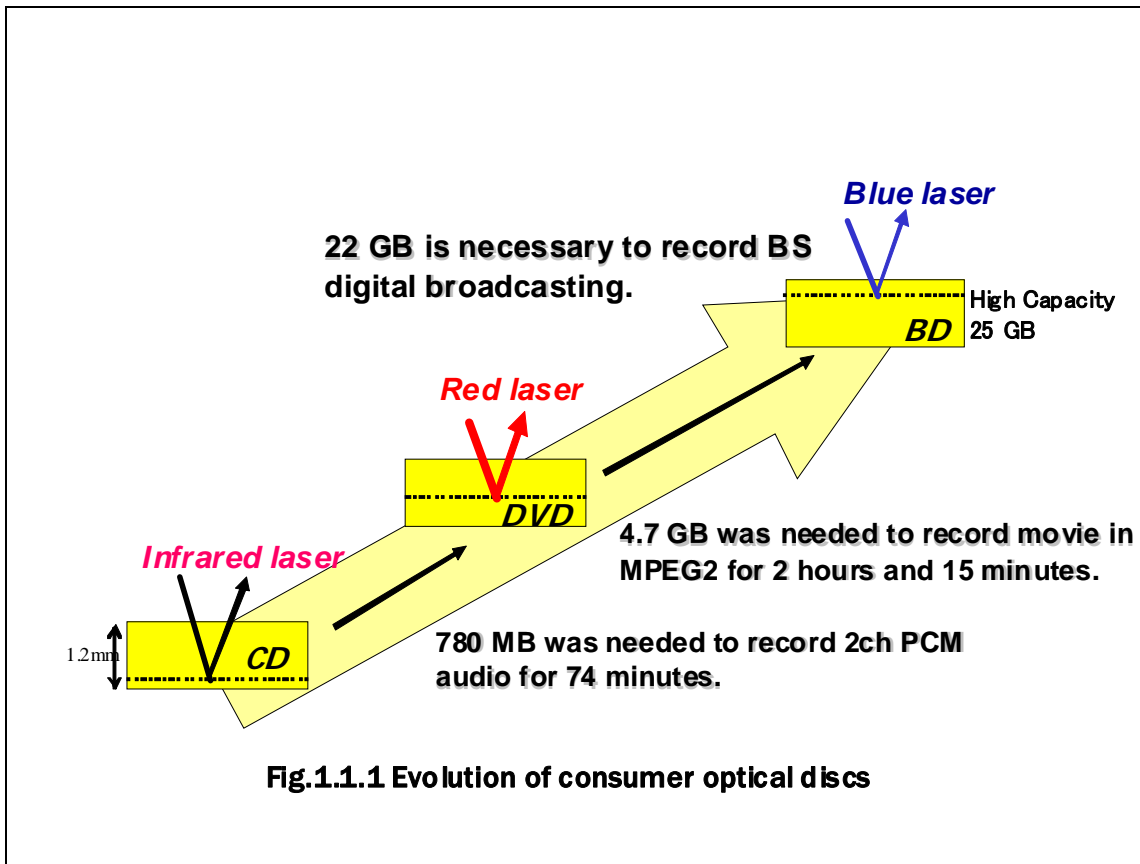

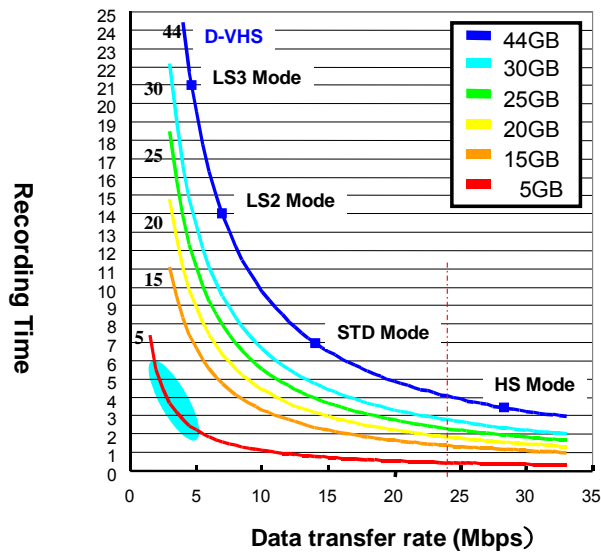
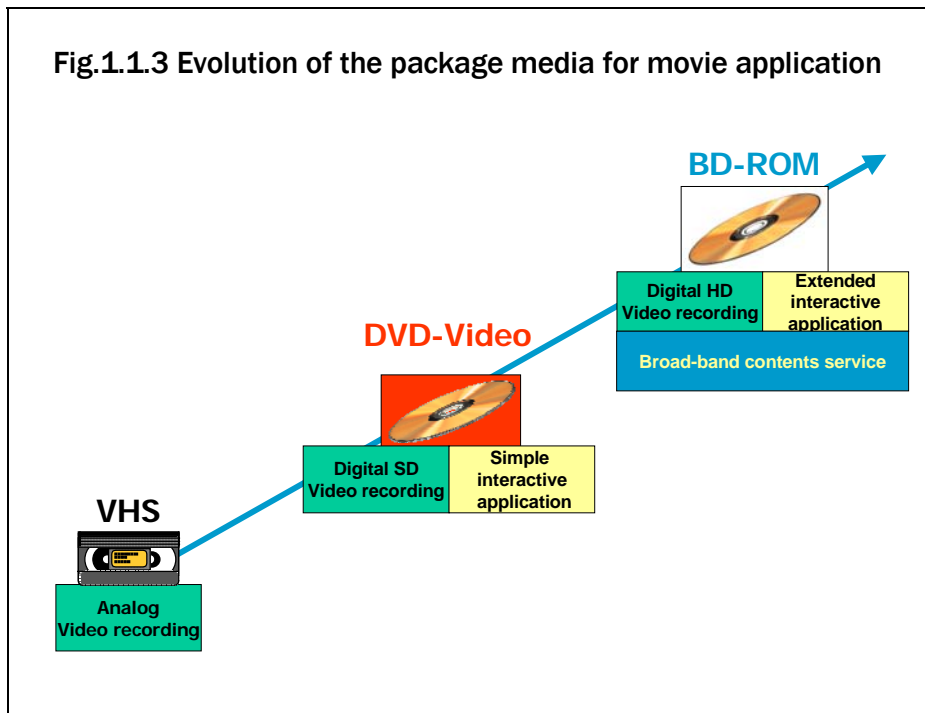

**Fig.1.1.2 Relation of Data transfer rate, Recording time and Required capacity**

To obtain this capacity we have developed a number of techniques such as: employing a blue-violet laser, increasing the numerical aperture of objective lens, making the optical beam passing Substrate thin, 0.1 mm, and evenly thick, using an aberration compensation method of pickup adapted to the Substrate thickness and Dual Layer discs, improving the modulation method, enhancing the ability of the Error Correction circuit without sacrificing the efficiency, employing the Viterbi decoding method for reading signals and improving the S/N ratio and the Inter Symbol Interference, using the On-Groove recording and highly reliable Wobbling address system, developing high speed recording Phase Change media, etc. In addition, the convenient functions of a recording device have also been realized in the application formats.

These techniques are described in this paper. Furthermore, the key concepts of the Blu-ray Disc™ standard such as the reason for employing 0.1 mm thick Transparent Layer and a Dual Layer recording disc will be described in each dedicated chapter. Following the Rewritable system, a Read-Only system and Write-once system has been launched.

In addition to high picture quality, the introduction of core and new functions is indispensable for the spread of the next generation package media. For example, during the switch from VHS to DVD, digital recording and interactive functions were newly introduced. Consequently, it is anticipated that the specifications of BD-ROM will provide a high performance interactivity and a connection to broadband services, reflecting the demands of the movie industry (Fig.1.1.3).



Recently, the digital HD broadcast started, and PDP and liquid crystal displays with large and high picture quality screens are spreading for home use. The recording of HD digital broadcasts and HD packages with BD-ROM are considered to accelerate this tendency and expected to be the trigger factors for the rapid spread of HD (Fig.1.1.4).

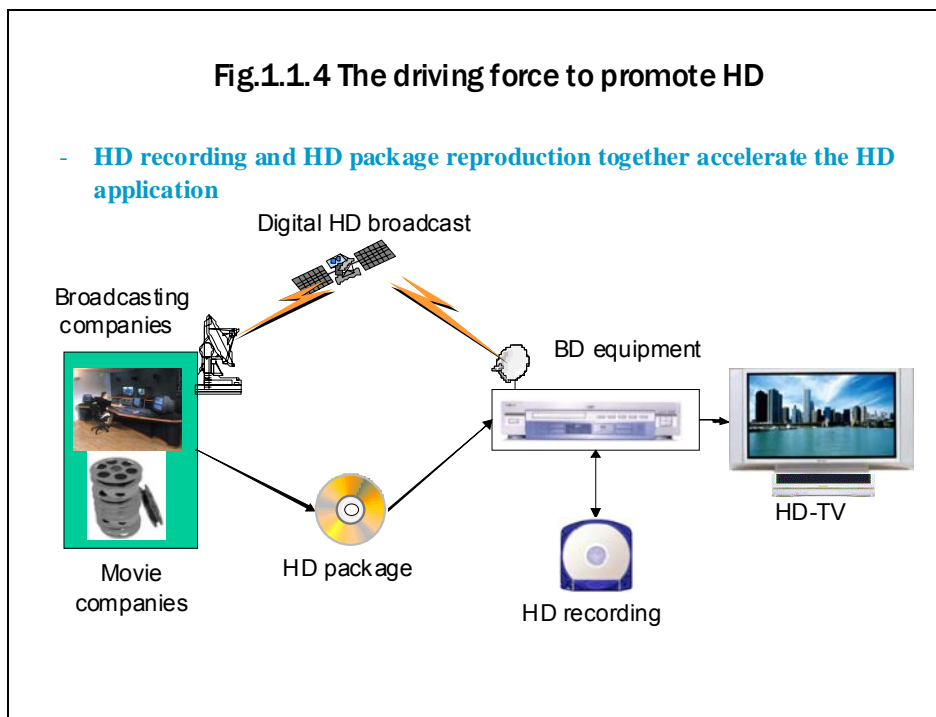

\* 1) The spelling of "Blu-ray™" is not a mistake. The character "e" is intentionally omitted because a daily-used term cannot be registered as a trademark.

## 1.2 Optimization of the Cover Layer Thickness

### Roots of a 1.2 mm Substrate existed in the video disc.

One of advantages of laser discs has been that they are hardly affected by dirt or dust on the disc surface since information is recorded and read through a Cover Layer. The first commercial optical disc, which was the videodisc called VLP or Laser Disc, used a 1.2 mm thick transparent Substrate, through which information was read. This thickness was determined from conditions such as:

- Deterioration of the S/N ratio due to surface contamination was suppressed to a minimum since it used analog recording,
- A disc of 30 cm in diameter can be molded,
- The disc has sufficient mechanical strength,
- The disc is as thin as possible while satisfying the flatness and optical uniformity.

The last condition is because the thinner the Cover Layer, the more easily the performance of the objective lens to converge the laser beam can be improved. This convergence performance of the objective lens is expressed by what we call NA (Numerical Aperture), and the diameter of a converging light is inversely proportional to NA (Fig. 1.2.1). Thus NA is required to be as large as possible. However, when the optical axis of the objective lens shift from perpendicular to the disc surface, a deterioration of the convergence performance (aberration) occurs and its amount grows proportionally to the cube of NA. Since we cannot avoid discs from tilting to some extent from the optical axis of the objective lens due to the bending of discs or inclination of the mounting, it has prevented the value of NA from increasing.

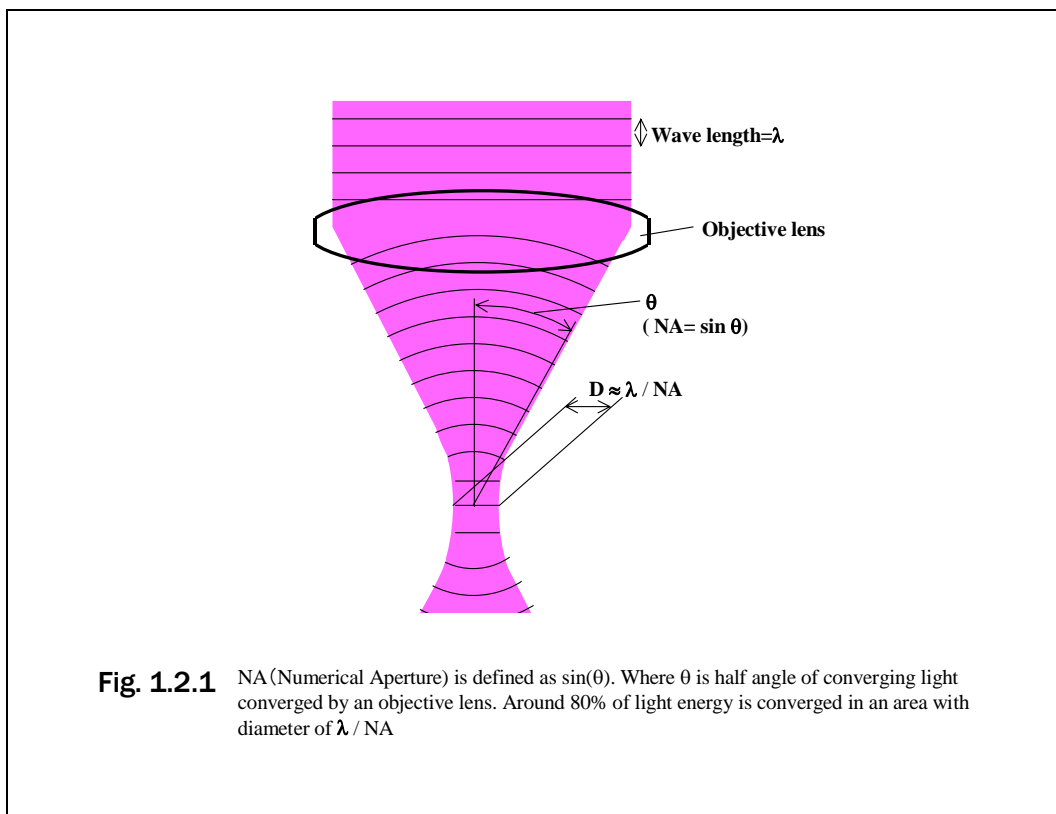

On the other hand, an aberration caused by a disc inclination is proportional to the thickness of the Cover Layer. This aberration originates by the refraction angle error at the Cover Layer interface resulting from the disc inclination. Further, the amount of blur in the beam spot due to the refraction angle error is proportional to the distance between the disc surface and the focal point (Fig. 1.2.2).

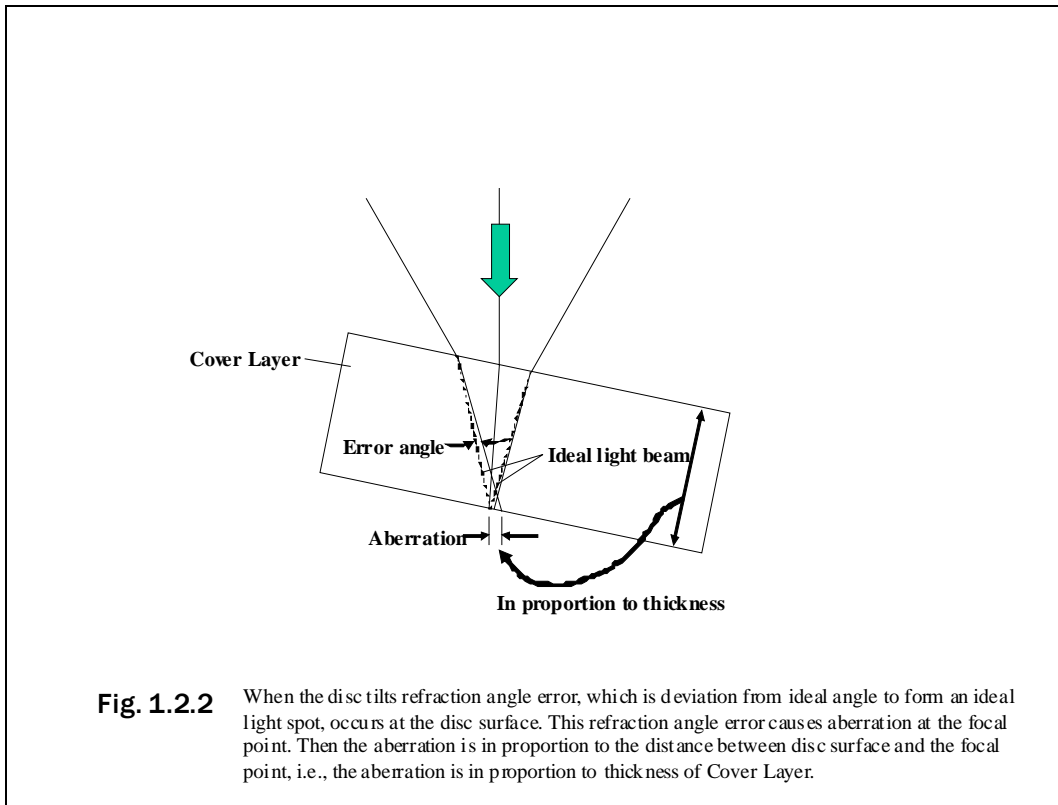

**The Objective Lens is designed in accordance with the Cover Layer Thickness.**

Although the first two conditions, which stated that the Cover Layer was to be a 1.2 mm thick Substrate, are not applicable to CD discs, the same thickness was eventually applied to CD discs. This was because of the great importance placed on the interchangeability of objective lens. Without raising the NA value of the objective lens, discs with a diameter as small as 12 cm could have sufficient capacity for digital audio use.

The interchangeability of the objective lens is generally lost when the thickness of the Cover Layer changes. This requires more explanation.

An objective lens must converge a laser beam in nearly ideal conditions. Such a laser beam has a spherical wave front in the Cover Layer and a wave front distorted from a spherical surface in the atmosphere before entering the layer. It is acceptable that the distortion of the spherical wave surface in the atmosphere is made equal to that of light that is spread from a point source placed at the spot where light converges. When a point light source is directed at the information surface of a laser disc, a spherical wave is formed and spread in the Cover Layer. The wave will be distorted when it enters the atmosphere. This is because the length of optical path from the virtual light source to the interface of the Cover Layer differs between a beam perpendicular to the interface and ambient beams. Since the difference in optical paths is proportional to the thickness of the Cover Layer, the thicker the layer is, the greater the amount of distortion from the spherical surface wave in the atmosphere (Fig. 1.2.3).



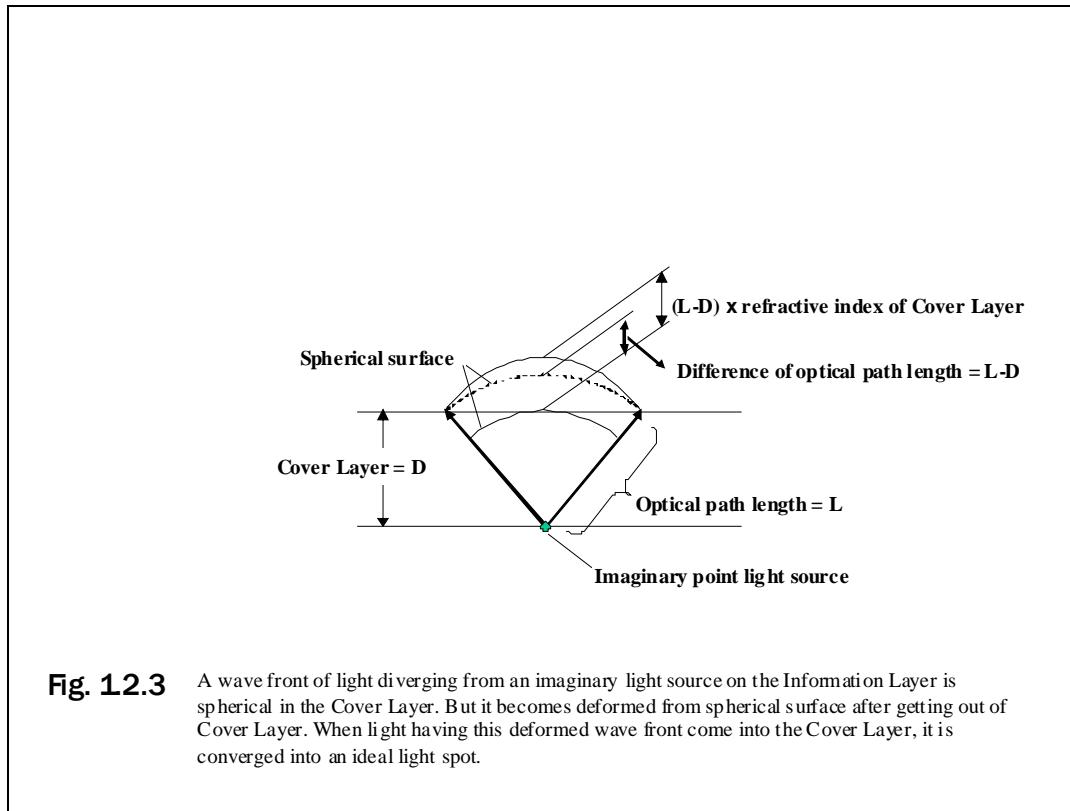

**Fig. 12.3** A wave front of light diverging from an imaginary light source on the Information Layer is spherical in the Cover Layer. But it becomes deformed from spherical surface after getting out of Cover Layer. When light having this deformed wave front come into the Cover Layer, it is converged into an ideal light spot.

An objective lens is designed to emit light with this distorted wave front. Because the ideal distortion amount differs with the thickness of Cover Layer, the design of objective lens also depends on the layer thickness. This is why the conventional thickness of the Cover Layer tends to be followed even if the format is changed.

### **Thickness Reduction of the Cover Layer**

Although a 1.2 mm thickness of the Cover Layer was adopted when the CD standard was defined, another approach was adopted for DVDs and BDs. This is because the necessary capacity could not be achieved if that particular thickness of the Cover Layer was used. Therefore, the optimization of the Cover Layer thickness was examined again in order to gain more capacity.

During digital recording, there's no need for anxiety about the deterioration of the S/N ratio of readout signals, compared with analog recording, as long as the signals can be read without error. In addition, the manufacturing process of 12 cm diameter discs is quite different from that of 30 cm discs. Consequently, there were attempts to reduce the thickness of Cover Layer as much as possible and increase the NA value of the objective lens as much as possible.

It has been regarded that one of principal advantages of optical discs is that the influence of dust on the disc surface is limited because the beams are defocused for dust on the surface of the Cover Layer when information is recorded and read. When the Cover Layer thickness is reduced, the NA value of objective lens can easily be increased, while this defocus effect is sacrificed. Since the Cover Layer thickness required for the defocus effect is different for digital and analog recordings, a reexamination is needed.

The defocusing effect when light passes through the Transmission Layer means that by increasing the cross section of incoming laser beam on the Surface Layer, the influence of small dust is diluted within the large section area of the beam. In other words, although the area influenced by dust is enlarged to entire section of light beam, the signal deterioration is reduced and reading errors are prevented. On the other hand, what we call Error Correction is generally used as a means to remove reading errors. During this operation, some redundancy data calculated from a large block of data is attached to the block as error check data. After the block is read, the check data is inversely calculated to correct partial errors. This can be compared to an image modification process where a partial defect of a photograph is corrected through estimations using adjacent image data. Through this method, errors

1.2 Optimization of the Cover Layer Thickness

are prevented by diluting the influence of partial signal defects in a large-scale data block. It can be said that this Error Correction method is the electronic version of defocusing by the Cover Layer. This further suggests that defocusing by the Cover Layer partially can be replaced by Error Correction (Fig. 1.2.4). However, there is a problem if the thickness of the cover layer is made nearly zero by raising the Error Correction capability. This is because the smallest unit of the Error Correction calculation is one byte, and a very small error such as one bit is practically magnified to a one-byte error. Therefore, defocusing is still desired to prevent small dust from causing bit errors. The thickness of the Cover Layer for that purpose is about several tens of micrometers.

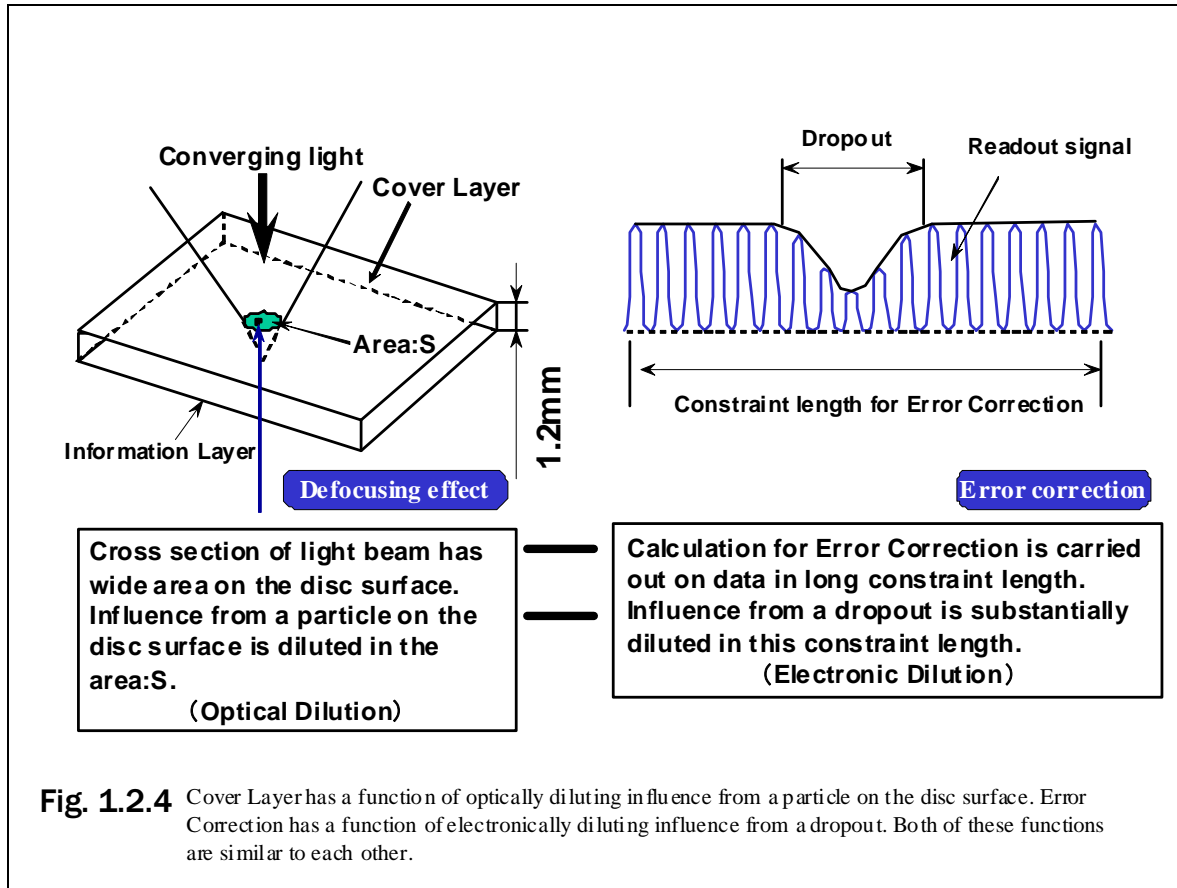

In the DVD standard, it was decided that the thickness of Cover Layer could be as small as 0.6 mm. This thickness could be made by the disc production facilities of those days, because the same mechanical strength as a CD could be obtained by sticking two pieces together.

For the purpose of BDs, this thickness was reconsidered with the essential condition to realize a 23 GB capacity, which is necessary to record a bit stream of Japanese BS digital HD broadcast for two hours.

At first, it was natural to consider using the same production facilities as DVDs, that is, to employ a thickness of 0.6 mm. However, the capacity could only reach around 12 GB by changing the wavelength from red (650 nm) to the blue (405 nm). As a further disadvantage, when there's an incline in the disc, the magnitude of aberrations increases in inverse proportion to the wavelength. To suppress this aberration, the NA value of the objective lens must be reduced. In the mass-produced record type DVD, NA is 0.65 the maximum, even if a tilt servo controlling the tilt angle of the optical pickup to the disc is used. As described before, the aberration when a disc is inclined is proportional to the cube of NA. To cancel the increase in aberrations due to shortening of the wavelength, NA should be reduced to around 0.55. In this case, the recording capacity is lowered to around 10 GB, far smaller than the 23 GB allowed by one of the newest reading technologies such as PRML. Although the narrowing of the Track Pitch was considered while suppressing crosstalk by recording in and between the guide Grooves, the influence of heat conduction became relatively large when the Track

Pitch was reduced. Further, the problem where heat conduction erased the next Track's information could not be overcome.

Thus, we tried to solve this problem by using Dual Layer recording. However, since the area of the beam spot for an NA value of 0.6 is almost double that for a value of 0.85, the power density of the spot decreases by half, and it has been revealed that the output power of blue laser requires more than 100 mW for Dual Layer recording. To achieve Dual Layer recording with a readily available blue laser, it is necessary to increase the NA value by further reducing the thickness of the Cover Layer.

To determine the thickness of the Cover Layer for BD, we had to either solve all of above-mentioned problems for a 0.6 mm thickness, or reduce the thickness. After all, there was no other choice than the latter because we could not find solutions for the above-mentioned problems.

As describe before, the required thickness of the Cover Layer is several 10  $\mu\text{m}$  or more. Considering the balance of the ease of production and the possibility of reducing costs in the future, a thickness of 100  $\mu\text{m}$  was adopted as a base value for the Cover Layer. By making the thickness of Cover Layer 100  $\mu\text{m}$ , the NA value of the objective lens could be raised to 0.85. For a capacity of 25 GB, the tilt margin ( $\pm 0.75$  degrees) was confirmed as nearly equal to that of DVD.

### **Compatibility was Obtained Using the Difference of Wavelengths**

As described above, the thickness of the Cover Layer has been inevitably changed each time to achieve the required capacity. Therefore, the problem has always been how to maintain compatibility with past standards. The most accepted method is to switch the objective lens. This was actually carried out in the DVD equipments for compatibility with CDs. At the time, many proposals to maintain the compatibility with one objective lens were presented. It is required to have an infrared laser with a 780 nm wavelength for reading CD-Rs, and a different wavelength red laser for DVD (650 nm wavelength) is utilized for the compatibility. Since the NA value of the objective lens for CDs is 0.45, which is smaller than that for DVDs (0.6), an optical device was introduced which lets a 780 nm wavelength beam pass through only the part of the objective lens corresponding to an NA value of 0.45 and which has a high dependency on the wavelength. This allowed the objective lens to perform in optimum conditions for a 1.2 mm thick Cover Layer. Through this method, a difference of 0.6mm in the Cover Layer thickness was absorbed within the 0.45 NA range of the objective lens.

A red laser is also required to be installed for BDs in order to guarantee compatibility with DVDs. Gold or silicone is used for the semitransparent Film Layer as the First Layer of a Dual Layer disc. These materials have a high selectivity of wavelength; the former prevents the reading of a further layer because it absorbs blue light and the latter prevents reading of a Nearer Layer because it does not reflect blue light.

Installation of red laser with blue laser can be utilized to realize compatibility with DVD with one objective lens like as compatibility between DVD and CD.

To realize compatibility between BD and DVD, a difference of 0.6mm in the Cover Layer thickness has to be absorbed the 0.6 NA range of the objective lens. Although the conditions for BD/DVD are more severe than for CD/DVD, it is a matter of degree. In fact, at the 2002 CE show, a prototype that achieved compatibility of BD/DVD with one objective lens was demonstrated. If two objective lenses are used and switched, BD/DVD compatibility can be easily achieved.

Although the difference in wavelength has been used to respond to different thicknesses of the Cover Layer with one objective lens, this is difficult to achieve with the same wavelength. For BD, the standard of Rewritable discs (BD-RE Standard) will be established first, and it is very natural that in the upcoming standards for Read-Only type and Recordable (Write-once) type discs, a Cover Layer thickness of 0.1 mm will be adopted (Fig. 1.2.5).

1.2 Optimization of the Cover Layer Thickness

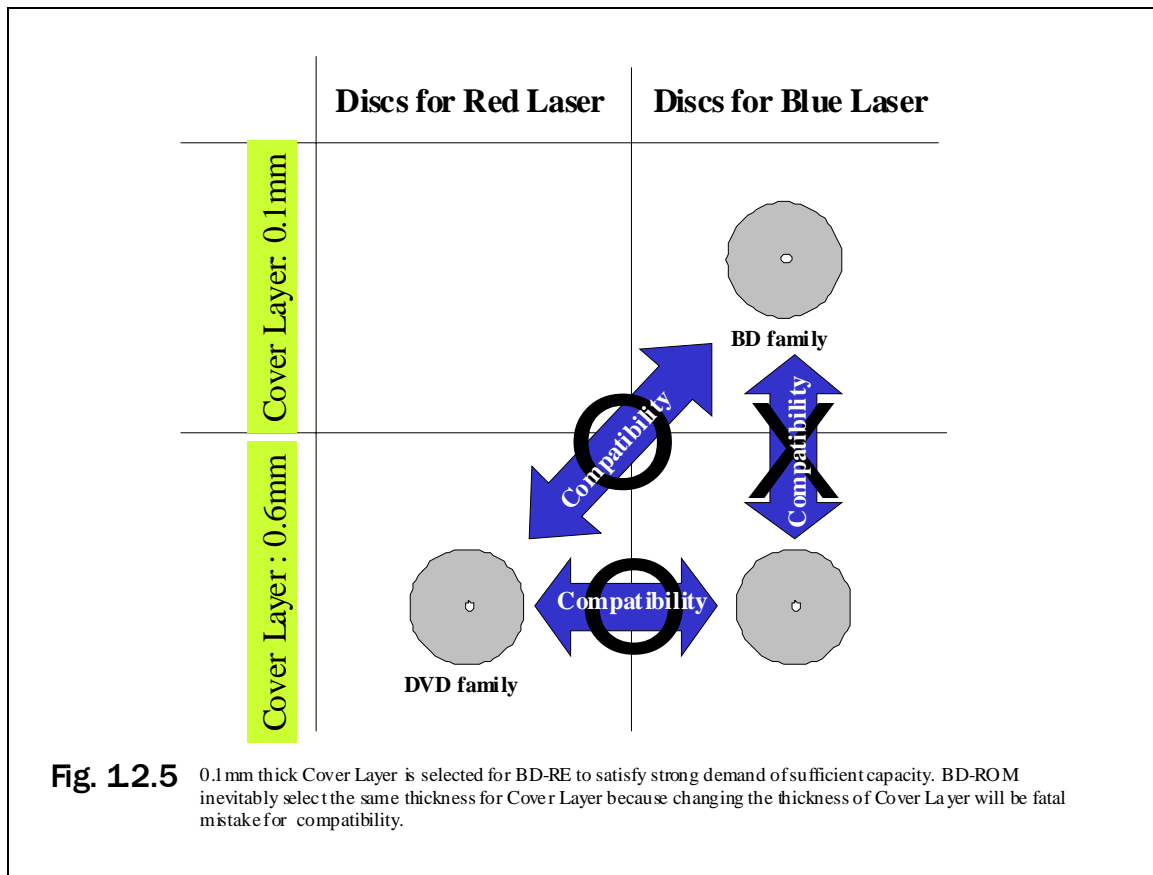

**Fig. 12.5** 0.1 mm thick Cover Layer is selected for BD-RE to satisfy strong demand of sufficient capacity. BD-ROM inevitably select the same thickness for Cover Layer because changing the thickness of Cover Layer will be fatal mistake for compatibility.

## 1.3 Blu-ray Disc™ format

### 1.3.1 Blu-ray Disc™ format overview

Table 1.3.1.1 shows key parameters of Blu-ray Disc™ formats for R (Recordable), RE (REwritable) and ROM (Read Only Media). The key parameters of R, RE and ROM such as wave length of the laser diode, Numerical Aperture of the objective lens, diameter of the disc, thickness of the disc and diameter of the center hole are common, and Blu-ray Disc™ format uses the same signal modulation as 17PP ((1, 7) RLL Parity-Preserve, Prohibit Repeated Minimum Transition Runlength code) and ECC (Error Correction Code) as LDC (Long Distance Code) with BIS (Burst Indicating Subcode). Because of specifying the same physical parameters and the same signal processing methods, we can employ common technologies to the optical pickup and LSI, and then it becomes easier to keep interoperability among R, RE and ROM.

Table 1.3.1.1 Key parameters of BD

Disc type	R	RE	ROM
Wave length of the laser	405nm		
Numerical Aperture of the objective lens	0.85		
Diameter of the disc	120mm		
Thickness of the disc	1.2mm		
Diameter of the center hole	15mm		
Signal modulation	17PP		
ECC	LDC with BIS		
Data track	Groove recording		Pit
Addressing method	Wobble		Pit

BD key parameters are defined with a good balance of conventional and new technologies in the best possible manner considering requests from the current market demands, interchangeability, and expandability in the future. Detail explanations are described at the later chapters

### 1.3.2 Physical format

The physical format of the Blu-ray disc™ system, which follows the 780 nm CD and the 650 nm DVD, will be the last optical disc system using visible light. Based on this information, we decided to use the following basic optical disc parameters, knowing that the development wasn't complete, in order to maintain the expectation of future progress:

- the shortest wavelength is 400 nm,
- the highest value of NA is 0.85,
- the reasonable Substrate thickness of 0.1mm,

A shorter wavelength was examined, but 400 nm was finally selected because a shorter wavelength causes a durability problem in the plastics of the Substrate Incident.

Fig. 1.3.2.1

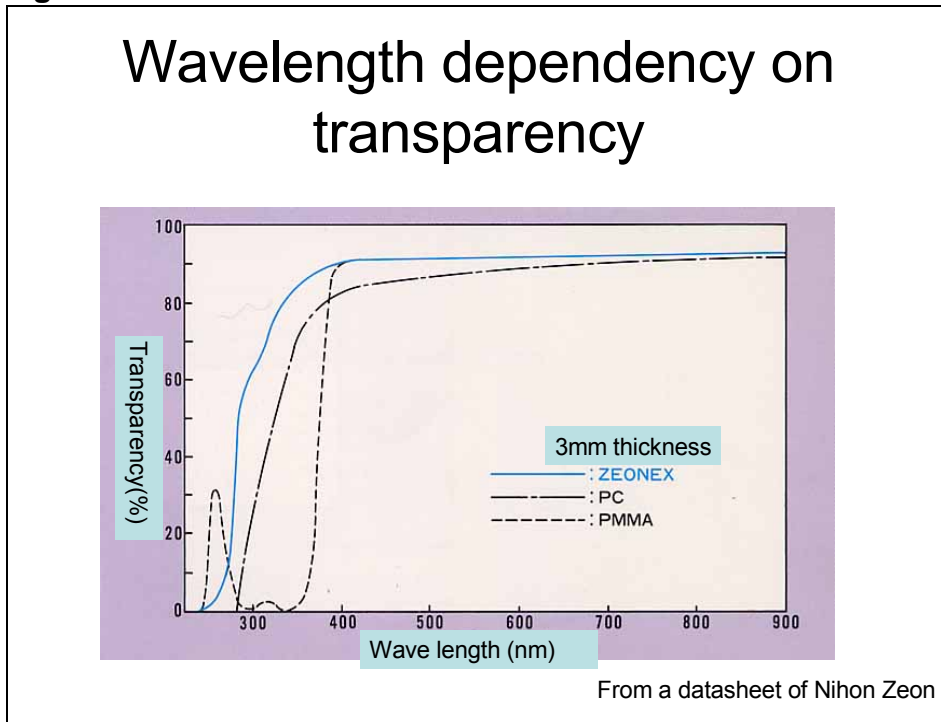

As shown in Fig. 1.3.2.1 many plastics for optical discs or optical devices suddenly show a poor transmission factor when under 400 nm. Furthermore, some are deteriorated by a phenomenon similar to sunburn.

The wavelength fluctuation during production must be considered. The tolerance is set so that the wavelength does not fall below 400 nm. In conventional cases, the wavelength is temperature dependent (for 780 nm the dependency = ca. 0.3 nm /deg.; for 650 nm ca. 0.25 nm/deg.). In particular, when recorded on a film with a pigment series recording sensitivity dependent on wavelength, a number of developments were needed. However, a 400 nm GaN laser seems to have a wavelength with a very small temperature dependency compared with 780 nm and 650 nm lasers.

The diameter of the concentrated beam is defined by the NA value of the objective lens and the wavelength, as in the following expression:

$$\text{Beam Diameter} = \alpha \times \lambda / \text{NA}$$

$\lambda$  = wavelength,  $\alpha$  = a constant

As seen in the above expression, the larger NA is, the smaller the beam diameter, although NA does not exceed 1.0 in the atmosphere. The largest NA values of CDs and DVDs obtainable during mass production were 0.45 and 0.6, respectively. For Blu-ray Disc™, an objective lens with an NA value of 0.85 was first made by laying two lenses, which can be manufactured with the technique for the 0.6 class NA, one on top of another. The working distance of this lens can be guaranteed at 0.14 mm at most, and it was often said that the lens would hit the disc, unlike CDs or DVDs. However, it was only in the early stages of the CD that using a lens with a diameter as large as 4.5 mm was possible and that the lens never physically hit the disc considering its moving distance. Because of the present compact designs, the lens can sometimes hit the disc both for CDs and DVDs. Therefore, we can't ignore the fact that the smaller the working distance, the higher the probability of a hit. However, some preventive measures can be taken by the hardware to sense danger and activate a protection circuit to prevent a hit, or a damper can be attached in case. In addition, JVC and other manufactures have recently started to design and prototype a stemma lens that can secure a working distance of approximately 0.5 mm. In all practicality, this distance will not cause any problem.

As described later, due to this large value of NA, the margin in the focus direction, which is affected by the square of NA, and the margin in the normal direction of the Cover Layer, which is affected by NA to the fourth power, must be considered. For optical recording, a large NA value is an advantage. Because of smaller spot size, it can be plainly said that the power necessary for recording by a Blu-ray™ system with a 400 nm wavelength and 0.85 NA is only 1/4 of a DVD system with a 650 nm wavelength and 0.6 NA.

Fig. 1.3.2.2

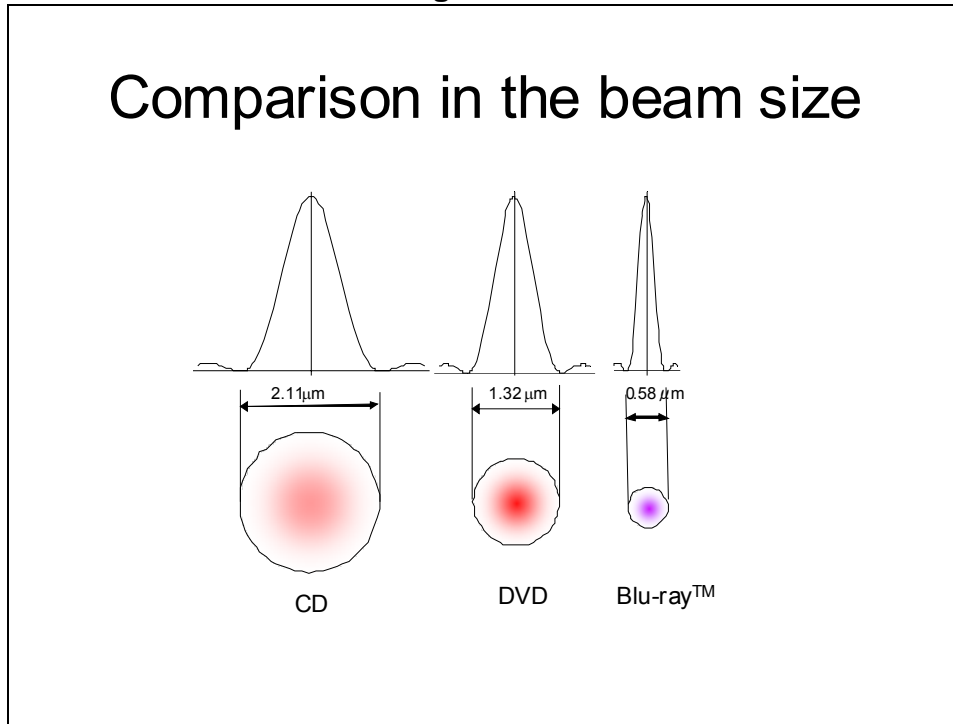

A comparison of diameter and intensity distribution of a concentrated beam on a disc between a CD and a DVD is shown in Fig. 1.3.2.2. The diameter used in the comparison is the first ring diameter when the Rim condition is satisfied at 100%. Since the integral of this waveform is the recording energy on an optical media, the energy is supposed to be input to the objective lens. Assuming the recording on the media begins with the same energy, the smaller the diameter (that is, the higher the density), the less the necessary laser power. This is one of reasons why Blu-ray™ requires only 5 mW for recording while CDs and DVDs require several tens of mW for a similar recording speed.

This will make room for recording power when Multi Layer recording or high-speed recording is developed in the future.

As described before, one of the Blu-ray Disc™ format features is its applicability to Multi Layer discs. Blu-ray™ discs are designed from the beginning that the format can be adapted to Multi Layer discs.

Fig. 1.3.2.3 shows the structure of Dual Layer disc as one of Multi Layer discs.

Fig. 1.3.2.3

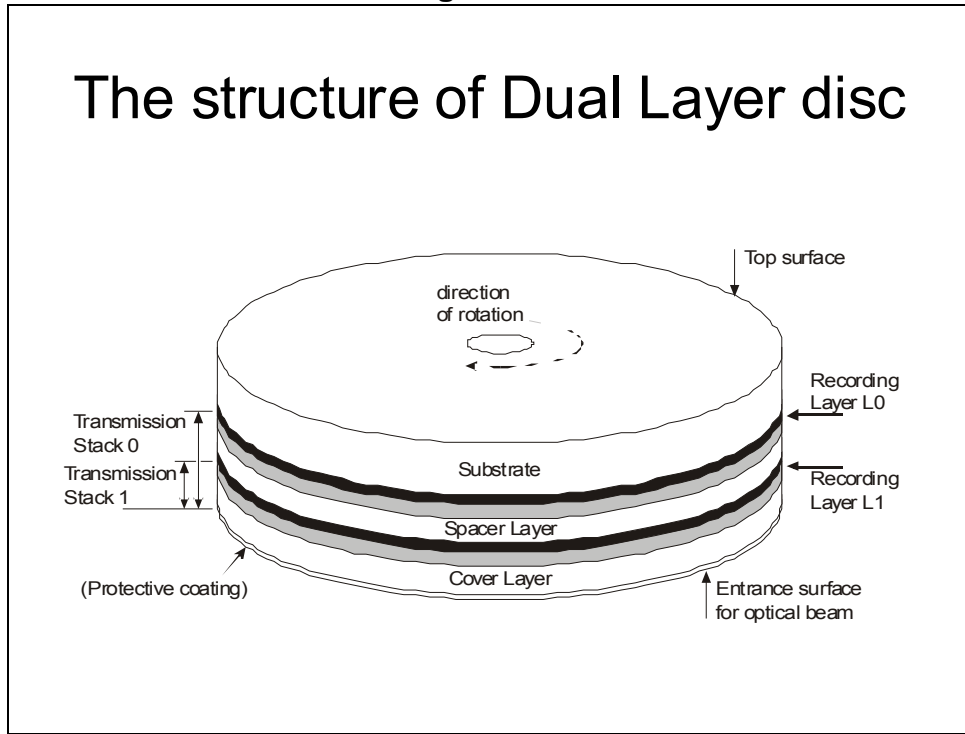

In this case, L1 is defined by the L0 plane sandwiched a 25  $\mu\text{m}$  thick Space Layer, and the thickness of the Cover Layer L1 is 75  $\mu\text{m}$ . L0 for all Multi Layer discs is always at the position of 100  $\mu\text{m}$  depth. Refer to the later chapter as 1.4 Multi Layer disc in detail.

Since Blu-ray Disc™ format employs different wavelengths, NA values, and Cover Layer thicknesses from CDs and DVDs, it is necessary to design and develop a compatible pickup for a system interchangeable with CDs and DVDs for recording and playing back. This is the same problem encountered for reading and writing CDs when a recording/playing back device for DVDs was planned. Some successful studies have already been released.



**Groove Format**

Physical structure of a Blu-ray™ disc is a Groove recording as shown the following figure.

**Fig. 1.3.2.4**

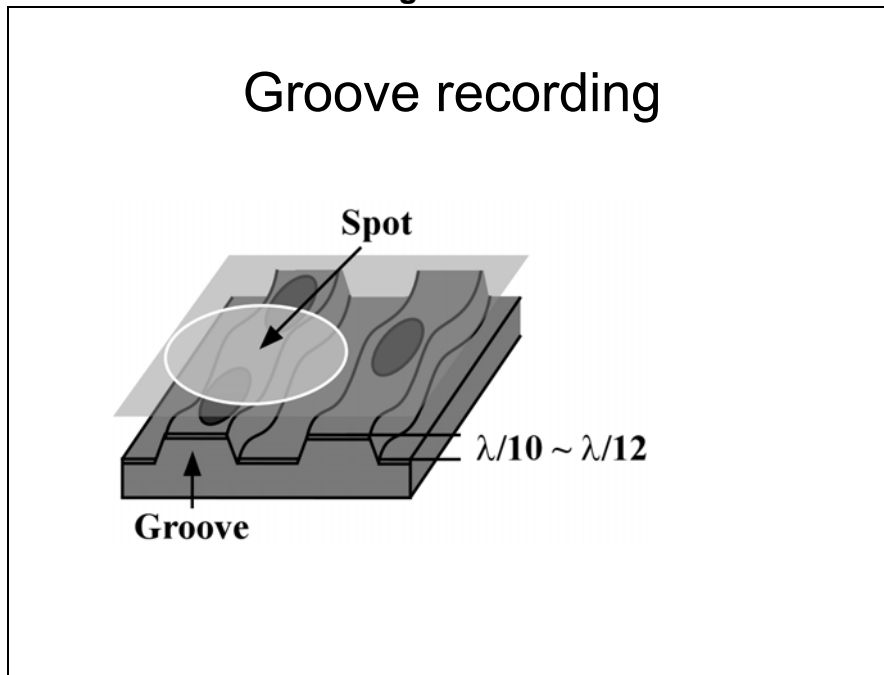

There were many opinions and study results concerning this, and it would be one of reasons why several recording formats were defined for DVDs. Fortunately, companies which dealt with the three DVD recording systems have joined the Blu-ray Disc™ format development group; all the studies have been reexamined and one physical format has been established. Furthermore, it was quite helpful that the most comprehensive erasable system was introduced first, unlike the cases for the CD and DVD in which the ROM came first and the other systems had to be adapted to it. It was natural that the master design of Blu-ray™ was made compatible for both home-use devices and computer peripheral devices. Therefore, the structure of the Data Unit arrangement was made, leaving a gap between blocks as with DVD-RAM. In addition, as in the past, to include ROM and R media into the vision, the Groove recording system was employed instead of Land/Groove recording in order to respond to these three kinds of recording media. This idea had also been adopted for CD-R, RW, DVD-RW, and +RW systems. One of reasons why discs of different Track Pitch coexist in the family is to prevent losing the freedom of the optical pickup design. At first, the mastering seemed to be extremely difficult for a 0.32 μm Track Pitch; the Groove itself must be formed with about a half the precision of 0.32 μm. Besides, since it would be necessary in the future to make a ROM type disc whose Pit must be formed by embossing, intensive developments have been carried out. As a result, mastering by Electron Beam (EB) was enabled first, and subsequently mastering by deep UV was enabled in the 25 GB class of Blu-ray Disc™. Furthermore, the mastering technology for Blu-ray™ using a beam with a wavelength of 400 nm was even developed, removing all obstacles against Groove recording. A stamping technology for this density has already been established.

Furthermore for BD-RE and BD-R H to L Type media, taking a high NA value such as 0.85 into account, the On-Groove method was selected instead of In-Groove. Although it is not easy to explain this in a scalar field, On-Groove was selected based on simulation results shown in the figure and actual experiments.

Fig. 1.3.2.5

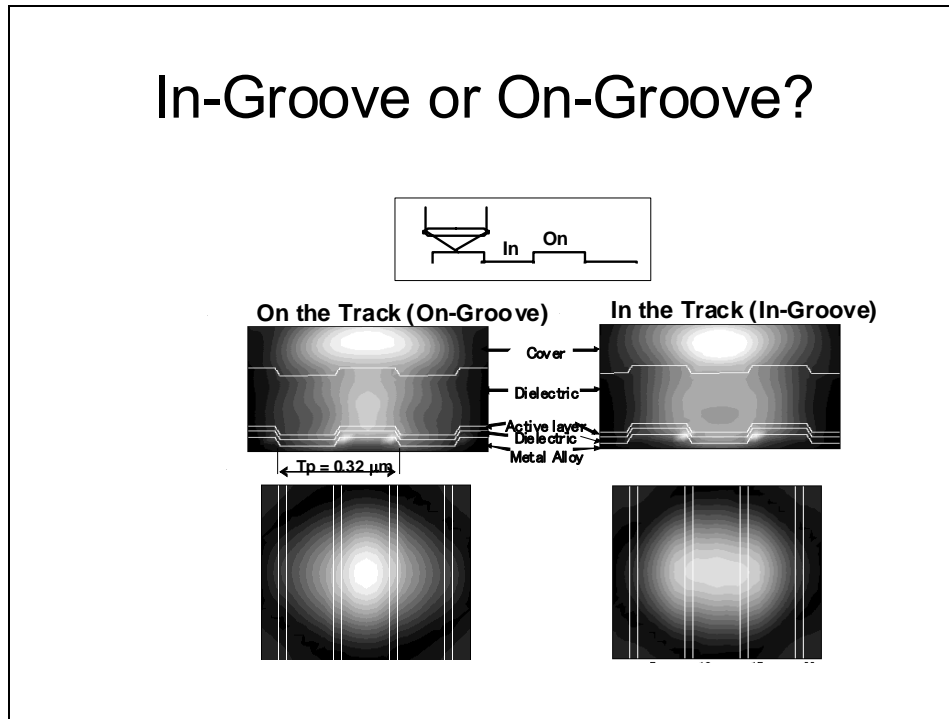

As seen in the In-Groove figure for these parameters, the power of the recording beam runs off in a radial direction. A narrow Track Pitch will make the Land/Groove recording system, which records both On-Groove and In-Groove, difficult.

At first, there were doubts whether or not the R media could respond to an On-Groove system. However an H to L Type R media that could respond to such a structure has already been developed and an On-Groove system can be applied to derivative formats such as CD and DVD.

Later the L to H Type R media was developed as the family of BD-R. This Type media adopted organic dye for the recording material. The dye Recording Layer is made by using the spin coating technology and In-Groove is suitable considering the manufacturing process. Among the dye media there are materials that irradiate heat or explode and induce the physical change around the recorded Mark during the recording. The Mark made by this kind of recording mechanism tends to extend in the radial direction and needs the In-Groove wall that can stop the Mark expansion in the radial direction. Therefore In-Groove recording was adopted for the L to H Type BD-R.

### **Addressing Method**

Blank addressing, when Groove recording is adopted, is formed only by the Wobble method. This concept is close to that employed for +RW. Although addressing with a Pit was first examined, an addressing system without a Pit was finally chosen considering that the recording density must be increased to make room for the header with the Pit and that in a Multi Layer disc, the Pit address has a great influence on the recording in other layers. The modulation technique Wobbling in the radial direction is based on MSK (Minimum Shift Keying) and formatted in blocks of 64 kB. The basic Wobble frequency is around 5  $\mu\text{m}$ , and 0 and 1 are expressed as the position where the sinusoidal wave is modulated by the MSK rule. Although the modulation energy of MSK is large, it is easily influenced by defects because information is localized. For that, a signal called STW (Saw Tooth Wobble) is used in form of multiplying to MSK. The STW adds secondary harmonics to all sinusoidal waves of Wobble, and 0 and 1 of the address data correspond to the polarity of added secondary harmonics. Since the energy of the STW signal is distributed in space unlike that of MSK, and detected by integration, it is robust against partial defects. The detection of an address in the Blu-ray™ system is robust because of the use of both MSK and STW.

### Error Correction Method

An Error Correction method must be designed in accordance with the error distribution of a Cover Layer thickness of 100 μm. This operation started by statistically treating the error distribution when the actual disc structure was subjected to a dust test and played back, and by modeling the distribution. As a result, what came out were short bursting errors by dust or scratches, and so-called picket codes with a structure matching long bursting errors that sometimes occur. This is made by combining a deep interleave to a long distance code, a kind of Reed-Solomon Code with a size of 64 kB, and then adding a burst indicator called BIS.

### Modulation Technique

The modulation technique of the main channel recorded along a track is called 17PP ((1, 7) RLL Parity-Preserve, Prohibit Repeated Minimum Transition Runlength code). This is a so-called d=1 code. As the examination results show, assuming that a Rewritable disc is taken first, the d=1 code was employed this time around because the wide detection window is advantageous as compared with the d=2 code used for CDs and DVDs (see the figure below). Further, a low Channel clock can be used when recording at high speed.

Fig. 1.3.2.6

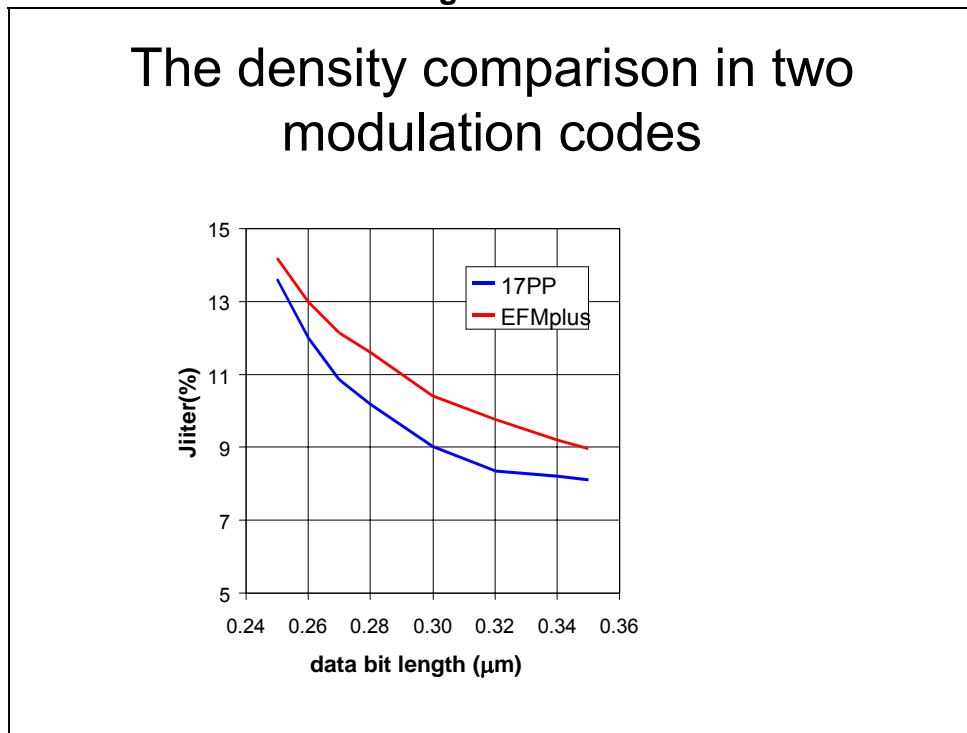

This data was obtained from a past experiment using a wavelength of 650 nm. Although the horizontal axis must be transformed to the density of Blu-ray™, this tendency was obtained when recorded and played back on a Phase Chang media. The use of d =1 means that non-linear Equalizer and PRML detection represented by Limit-Equalizer act more effectively, and this type of signal processing is more important in Blu-ray Disc™ compared with CD and DVD. Although the mastering and embossing ROM Pit seemed difficult at first because the minimum Pit is shorter than that of d=2, those processes were eventually successful thanks to the progress of the mastering technology when the capacity is around 25 GB. The Parity preserve means that DC balance of signals after modulation can be evaluated without looking at the 0-1 series, and it is effective in reducing the hardware load. Prohibit RMTR (Repeated Minimum Transition Runlength) is limited not to run seven or more in 17PP by preventing long run of minimum length (what represented by 101 after modulation).

[Reference]

“Optical Disc System for Digital Video Recording”, T. Narahara et.al., Jpn. J. Appl. Phys. 39 (2000) pp. 912-919.

### **Recording Medium and Writing Strategy**

Blu-ray Disc™ uses Phase Change film as a recording media. Phase Change film is classified into two types: a familiar example is what's called the GST (GeSbTe stoichiometrical composition) type used for DVD-RAM and the other is the eutectic type used for CD-RW, DVD-RW, and +RW. Each type has its advantages in repeat recording characteristics and high-speed recording. For Blu-ray Disc™, the recording pattern was devised to allow the application of both types of Phase Change films. Both media were also improved so that a recording pattern of the same type can be used with a predetermined density and a range of almost the same power. An example of recorded pattern for RE v1.0 is shown in Fig 1.3.2.7. It's a waveform for recording a Pit including two pulses of the Channel clock, which is the smallest Pit length, and a waveform for recording a longer Pit including five pulses.

**Fig. 1.3.2.7**

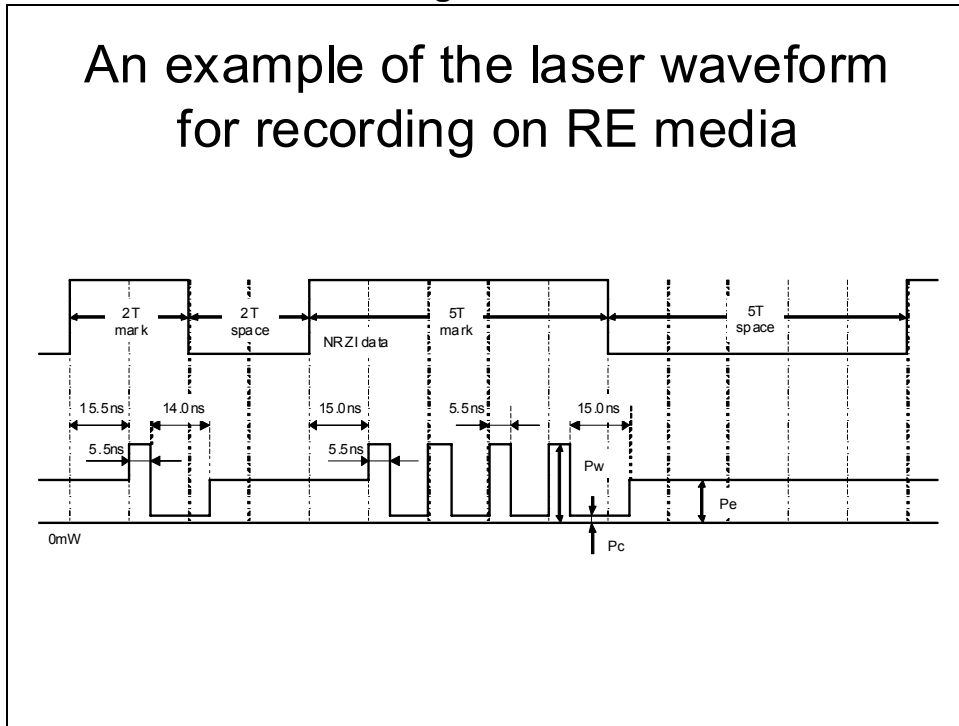

In BD-RE V1.0, the largest recording power at 36 Mbps is 5.2 mW (10.4 mW for dual layers). This was explained previously where a high NA value suppressed the power at this level, even for 36 Mbps.

### **1.3.3 Outline of the File System Application format**

The BD-RE standard consists of three parts: Part 1 (Physical format), Part 2 (File System format), and Part 3 (Application format). Abstracts are explained here on the Application format for R and RE and the File system format.

#### **1.3.3.1 Application format for RE and R**

First, the function of the Application format is described.

#### **Digital Broadcasting Direct Recording Function**

This recording function enables the recording of not only digital broadcast image data without destroying the image quality, but also of data broadcast data and multi-channel sound data altogether. To this end, this format employs the MPEG-2TS (Transport Stream), used by digital broadcasts, as a stream type for recording.

Received MPEG-2TS data is recorded on a disc as a Clip AV stream file (Fig. 1.3.3.1.1).

Fig 1.3.3.1.1

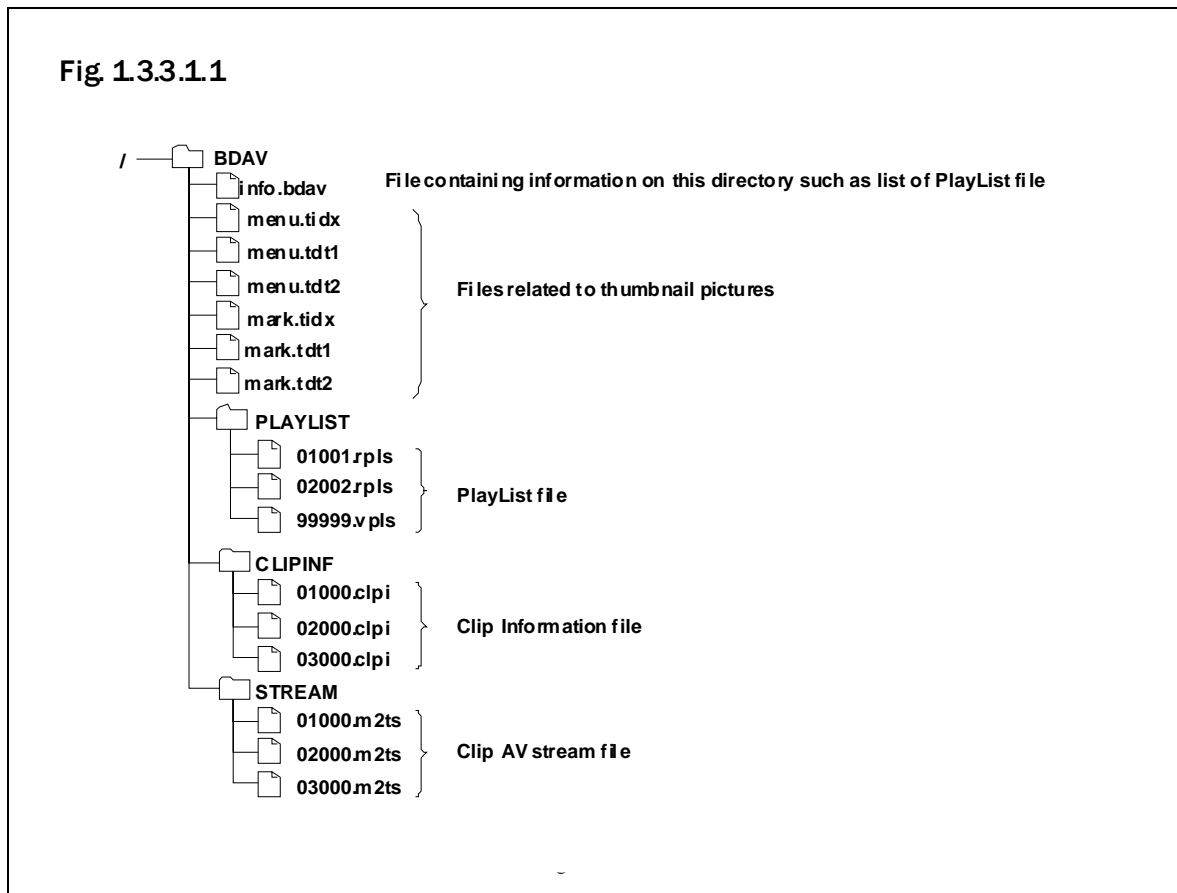

**Random Access High-speed Playback Function**

To achieve a function that enables random access to a desired scene in MPEG-2TS and high-speed playback, tables to obtain the record position of data corresponding to a playback time requested by the user are provided for each Clip AV stream file. The tables are stored in the Clip Information File shown in Fig. 1.3.3.1.1.

**Editing and Marking Function**

The PlayList file is provided for removing unnecessary scenes without copying or transferring recorded data like tape media, and editing material recorded on the disc without processing the original image (Fig. 1.3.2.1.1).

The PlayList file holds the playback order information necessary to designate what part of what Clip AV stream is played back (Fig. 1.3.3.1.2).

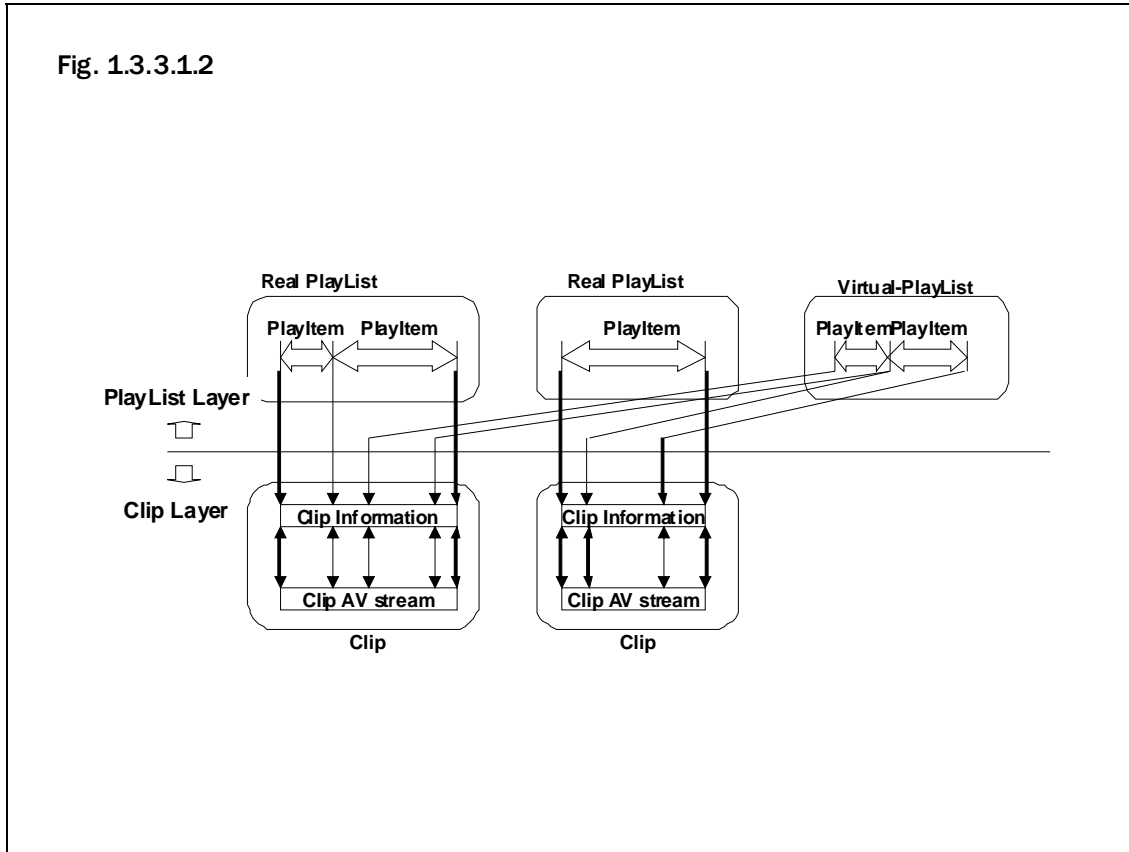

The PlayList file also holds bookmark information to enable direct access to a favorite scene.

### **Contents Search Function**

In each thumbnail related file shown in Fig. 1.3.3.1.1, thumbnails (representing a scaled-down version of picture) of the PlayList file and bookmarked scenes are stored. This enables the search for recorded contents and bookmarks by viewing thumbnail images.

### **1.3.3.2 File System format**

Main functions of the File system format are described next.

#### **High-speed Response**

To shorten the response as much as possible from the time the disc is inserted until recording/playing back becomes ready, files other than Clip AV stream files are stored closely in certain area on the disc.

#### **High Reliability**

Even if stored data becomes impossible to read due to scratches or dust, cases of lost recorded contents should be avoided as much as possible.

Therefore, the File system format has a mechanism that always copies the PlayList files, part of the thumbnail related files, Clip Information files, etc. to another recording area for backup.

## 1.4 Multi Layer disc

### 1.4.1 Dual Layer disc

Dual layer system is defined for rewritable or recordable type of Blu-ray™ discs. To achieve the Dual Layer, many new techniques such as super-thin recording films and assembly processes are needed. It can be said that continuous developments since 1994 produced results, i.e. the Dual Layer BD 1) 2). BD provides large recording capacities such as 50GB (25GB per layer). More than 4 hours of HDTV and more than 20 hours of SDTV can be recorded respectively. In addition, since recording and playback can be done from one side, user does not have to turn the disc over in the drive.

Fig. 1.4.1.1 shows a schematic drawing of the Dual Layer BD disc. In Blu-ray Disc™ format, an information recording layer 100 μm away from the laser incident plane is defined as the L0 Layer, and another information recording layer 75 μm away is called as the L1 Layer. A Phase Change material is used as the recording media because of prior experience with DVD-RAM, DVD-RW, etc.

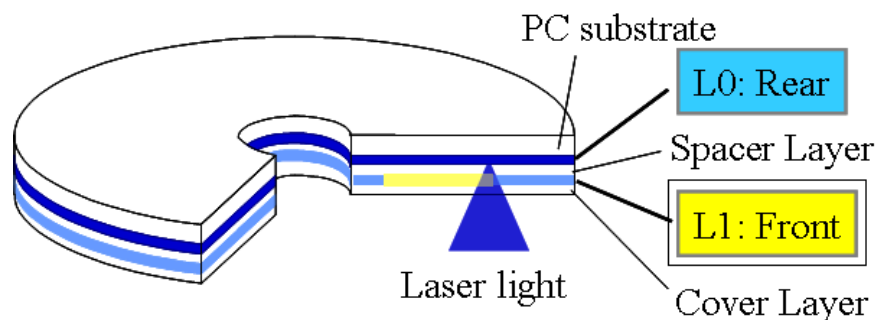
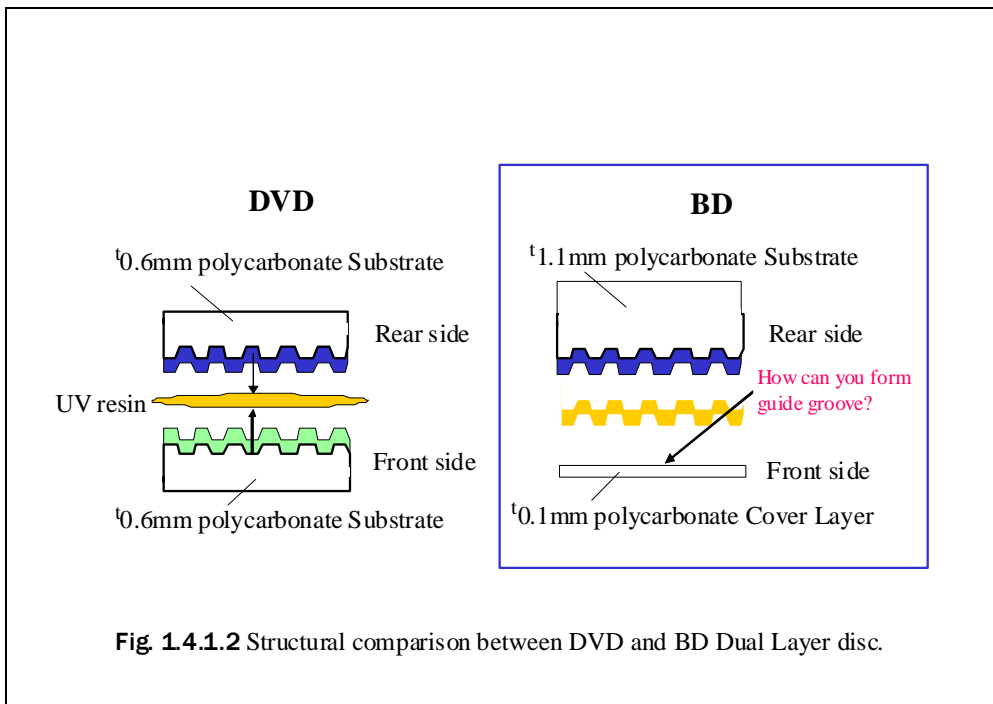
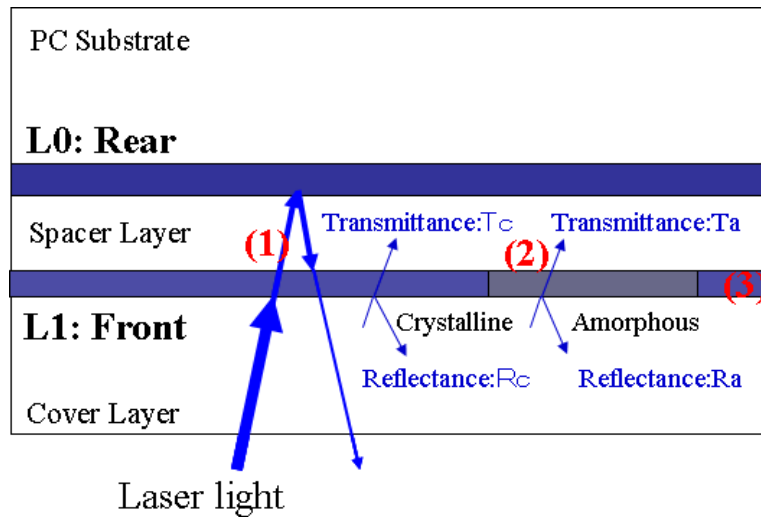

Fig. 1.4.1.1 Dual Layer disc

Fig. 1.4.1.2 is a comparison of the structures of the DVD (ROM) and BD Dual Layer discs. With the DVD, the Rear and the Front Layers are formed separately on two Substrates and then, the Substrates are attached one on top of another with a UV-hardening resin adhesive. Because each Substrate is 0.6 mm thick, a guide Groove for tracking can be formed independently. On the other hand, in BD, the Rear Layer consisting of Multi Layered films is formed on a 1.1 mm thick polycarbonate Substrate with a guide Groove for tracking, and then the 25 μm thickness of Space Layer made of resin is formed. The Front Layer is formed on it, and finally the 75 μm thick Cover Layer is formed. The Cover Layer is too thin to form a guide Groove. The first technological hurdle for BD is how to form this guide Groove. A suggested forming method specifies that a guide Groove for the Front Layer is transcribed on the Space Layer side like a stamping process 3).



The second technological hurdle for the Dual Layer BD disc is the Front Recording Layer. The following conditions are specified for the Front Layer (See Fig. 1.4.1.3).



**Fig. 1.4.1.3** The necessary condition on optical property of L1 Layer:  
1)  $T_a = T_c > 50\%$  and 2) large difference between  $R_c$  and  $R_a$



(1) Transmittance

Because in the Dual Layer disc the Rear Layer is recorded through the Front Layer, it is important that the Front Layer has a sufficiently large transmittance. It is natural that the Front Layer itself should be recorded and read with certain light power, therefore the target value of its transmittance is 50% to share light between both layers.

(2) The transmittance should not change before and after recording.

Since BD assumes random access recording, sometimes the Rear Layer is recorded or read while there are Recorded Areas and Unrecorded Areas mixed on the Front Layer. If the transmittances change depending on whether or not the area is recorded, the intensity of passed beams fluctuates and negatively influences the recording/reading of the Rear Layer. It is therefore desirable that the transmittance does not change between recorded and unrecorded states. Selection of the recording film material and the design of the Multi Layer film are important.

(3) Balance of the cooling speed and crystallization speed

Phase Change material becomes amorphous after high-power laser heating during recording followed by quick cooling and crystallizes with middle-power heating when being erased. To make the Front Layer semi-transparent, the reflection film and recording film tend to be thinner compared with conventional discs. However, there are problems with the former, where the cooling speed decreases after melting, and for the latter, the crystallization speed decreases.

In addition, it is desirable for the Rear Layer to be the same as a Single Layer considering the efficiency of development and production.

In consideration of the above-mentioned points, the development of the Dual Layer disc and the BD standardization were promoted. Fig. 1.4.1.4 shows the played-back signal (after Limit-Equalizer) of the developed 50 GB disc. The signal characteristics are comparable to a Single Layer BD disc. The development of the Dual Layer disc will be the key for further enhancements of BD's charm as a large-volume recording media.

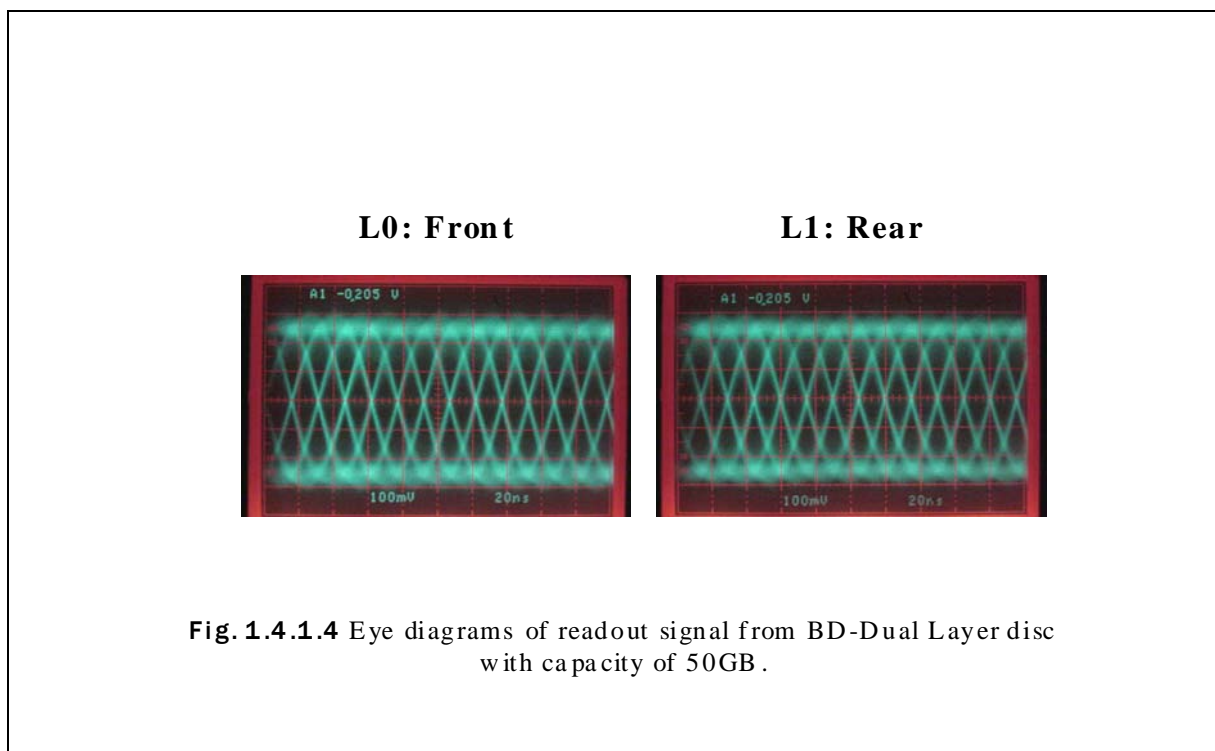

**White Paper Blu-ray Disc™ Format  
General**

1.4 Multi Layer disc

---

Table 1.4.1.1 shows brief physical specifications of Single Layer disc and Dual layer disc

Table 1.4.1.1 Brief physical specifications of SL disc and DL disc

Layer	SL	DL
Disc type	R, RE or ROM	
Capacity	25GB	50GB
Capacity/layer	25GB	
Minimum Mark length	0.149um	
Track Pitch	0.32um	
Modulation	17PP	
ECC	LDC with BIS	
Sector / Block size	2 kB / 64 kB	
Track path	-	OTP***
Write speed for media (except ROM)	RE: 1x**, 2x R: 1x. 2x. 4x(Opt.), 6x(Opt.)	

1x\*\* = 36 Mbps

OTP\*\*\*: Opposite track path

### 1.4.2 Triple Layer disc and Quadruple Layer disc (BDXL™)

One of Blu-ray Disc™ format features is to be able to pile up layers as Multi Layer disc. BDA successfully specified Triple Layer disc format 100GB for R and RE and Quadruple Layer disc format 128GB for R in June 2010. Either format is named as BDXL™.

BDA created BDXL™ Specifications on three basic design concepts as follows.

1. Used the same core parameters as SL/DL .

BDXL™ Specifications use the same core parameters such as L0 Layer thickness, laser wave length, lens NA, Track Pitch, ECC, modulation codec and Wobble address format (STW/MSK). It means a new device supporting BDXL™ discs can use almost the same technologies on the optical pickup and LSI as those used in a legacy device. It helps to realize the interoperability among Single Layer disc, Dual Layer disc, Triple Layer disc and Quadruple Layer disc.

2. Minimized the changes to achieve high capacity.

In order to achieve higher capacity, BDA (i) define the appropriate thickness of each Layer except L0 Layer for either the Triple Layer disc or the Quadruple Layer disc, (ii) increase the linear density (capacity/layer) and (iii) update some data alignments of disc management information.

3. Optimized Specifications for RE and R to reflect physical property differences of Multi Layer Recording Stacks

Physical parameters such as reflectivity, write power, read power etc were optimized to reflect its own physical property for either R or RE. Refer to White Paper of BD-RE and BD-R in detail.

Table 1.4.2.1 shows brief physical specifications of all BD Discs. Single Layer (SL) disc of 25GB or Dual Layer (DL) disc of 50GB is applied for R, RE and ROM. Triple Layer (TL) disc is applied for either R or RE, and Quadruple Layer (QL) disc is applied for R. RE has no QL disc since its technical feasibility has not been confirmed. The liner density of TL disc or QL disc is larger than that of SL disc or DL disc. The capacity per layer is different among SL/DL, TL and QL.

Table 1.4.2.1 Brief physical specifications of all BD discs

Layer	SL	DL	TL	QL
Disc type	R, RE or ROM		R or RE	R
Capacity	25GB	50GB	100GB	128GB
Capacity/layer	25GB		33.4GB	32GB
Minimum Mark length	0.149um		0.112um	0.117um
Track Pitch	0.32um			
Modulation	17PP			
ECC	LDC with BIS			
Sector / Block size	2 kB / 64 kB			
Track path	-	Opposite track path		
Write speed for media (except ROM)	RE: 1x**, 2x R: 1x. 2x. 4x(Opt.), 6x(Opt.)		RE: 2x R: 2x, 4x	R: 2x, 4x

1x\*\* = 36 Mbps

1.4 Multi Layer disc

Table 1.4.2.2 shows brief parameters of pickup and disc structure. Since the optical parameters of a pickup such as NA (Numerical Aperture) and wave length of the laser diode are common, the pick up to read the Triple Layer disc and/or the Quadruple Layer disc can read either the Single Layer disc or the Dual Layer disc easily. All types of BD discs have L0 Layer at the position of 100µm depth. At the start up timing, a pick up can seek L0 Layer of any disc with the compensation for 100µm spherical aberration and can find the disc type which it is reading. The thickness of the Space Layer is designed to avoid the cross talk from other layers. Refer to the White Paper R and RE in detail.

Table 1.4.2.2 Brief parameters of pickup and disc structure

Layer	DL	TL	QL
Pick up			
NA*	0.85		
Wave length*	405nm		
Disc structure*			

\* Typical value

Fig. 1.4.2.1 shows compatibility between legacy and BDXL™. A legacy device to support 25/50GB only cannot read nor write a BDXL™ disc. BDA has prepared a new logo as shown to clearly distinguish BDXL™ discs from 25/50GB discs and devices from the legacy ones. A device having this BDXL™ logo can handle a disc having the BDXL™ logo. It is not mandatory, but the new device supporting BDXL™ disc can be easily designed to support 25GB/50GB discs since BDXL™ specifications have been developed with small impact on pickup and LSI for 25/50GB discs.

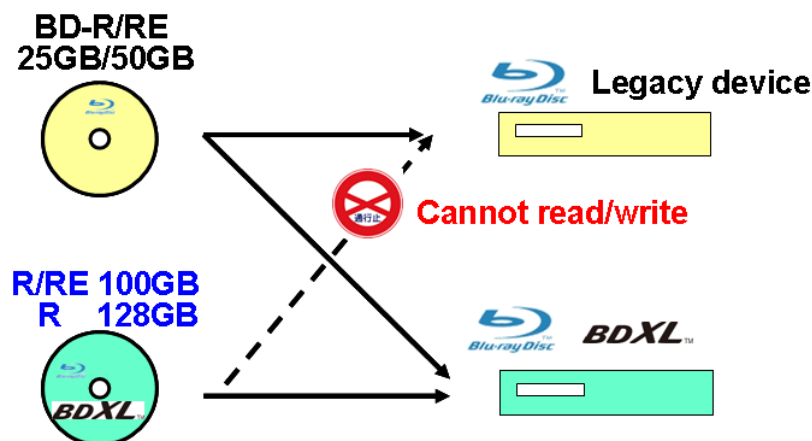

Fig.1.4.2.1 Compatibility between legacy and BDXL™

BDXL™ disc can be used for professional use. Fig. 1.4.2.2 shows some application images for BDXL™ disc. Data such as broad cast program, media data and internet data become bigger and bigger day by day. The archiving market is rapidly growing along with this data explosion. It is expected that BDXL™ disc would be useful for this market.

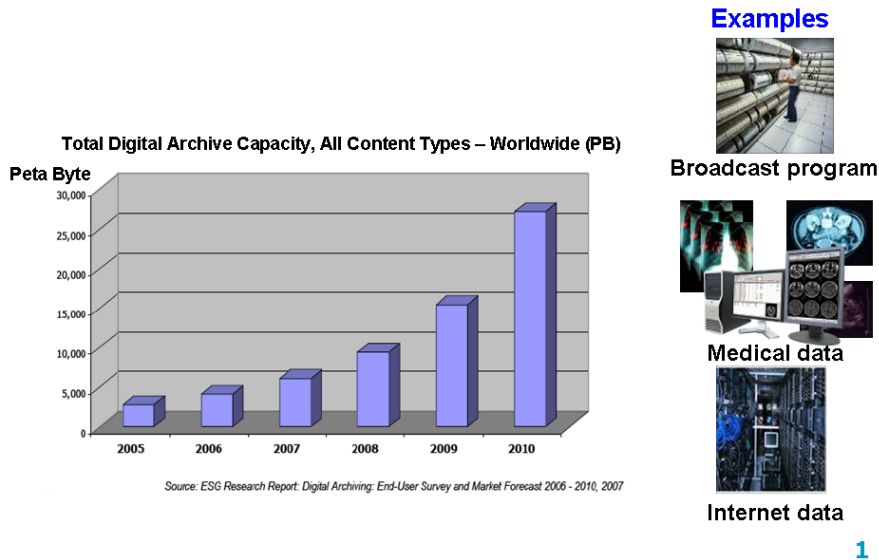

Fig. 1.4.2.2 One application image

Fig. 1.4.2.3 shows another example. Since the capacity of the flash memory becomes bigger and bigger, it is necessary to increase the disc capacity in order to backup this data. And also there is a strong requirement from professional industry to have large capacity storage devices for professional video camera and professional server to store huge data. BDXL™ disc is expected to meet these requirements. In addition BDXL™ disc can be used for the consumer market like a recorder which can record longer TV programs.

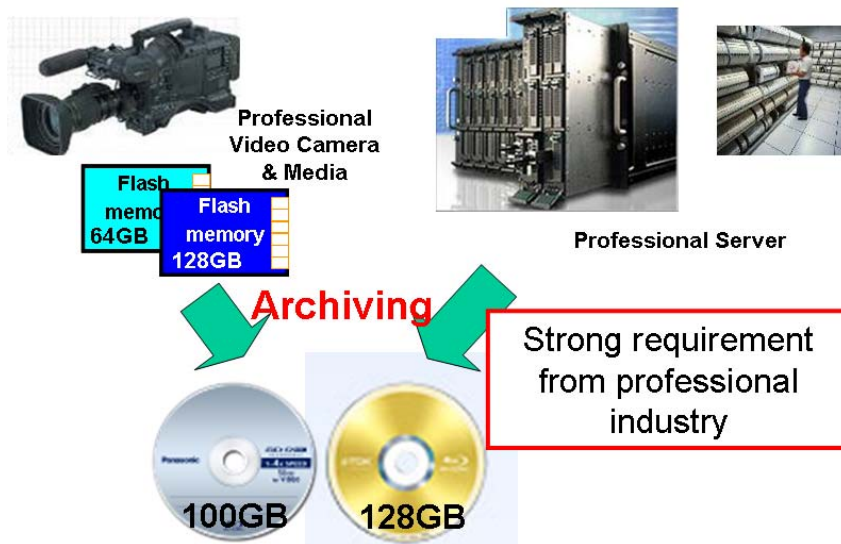

Fig. 1.4.2.3 Another application image

### 1.4.3 Requirements for signal quality

Table 1.4.3.1 shows requirements for signal quality specified in the Format Books.

Table 1.4.3.1 Requirements for signal quality

Layer	SL	DL	TL	QL
Disc type	R, RE or ROM		R or RE	R
Capacity	25GB	50GB	100GB	128GB
Signal Quality Evaluation Index required for disc with Tester	Limit-Equalizer jitter		i-MLSE* using PR(1,2,2,2,1)	
	L0: ≤ 7.0 % ≤ 6.5 % (without 2T edges)	L0: ≤ 7.0 % ≤ 6.5 % (without 2T edges) L1: ≤ 8.5 % ≤ 6.5 % (without 2T edges)	L0: ≤ 11.0 % L1: ≤ 11.5 % L2: ≤ 12.0 %	L0: ≤ 11.0 % L1: ≤ 11.0 % L2: ≤ 11.5 % L3: ≤ 12.0 %
R-SER required for disc with a Tester	2.0E-4 (defined in Part1 Specifications)			
R-SER required for drive with a Test disc	1.0E-3 (Criteria in Drive Test Specifications.)			

i-MLSE\*: integrated Maximum Likelihood Sequence error Estimation

The signal quality of SL disc or DL disc is measured by Limit-Equalizer. On the other hand, since the liner density becomes higher, the new signal quality evaluation index as i-MLSE, which stands for integrated Maximum Likelihood Sequence error Estimation using PR (1,2,2,2,1) is applied for TL disc or QL disc. The specification required for each layer of a disc is described in Table 1.4.3.1. The values are measured by a Tester in the Testing Center. The specification value of a closer layer to the pickup is more relaxed, because a shorter optical path has larger tolerance for the disc tilt.

There are two types of R-SER (Random-Symbol Error Rate). R-SER specified in Part1 Book is required for a disc. When a Tester in Testing Center writes and measures a disc, the disc has to satisfy less than 2.0E-4 of R-SER. R-SER specified in the Drive Test Specifications is required for a drive. When a drive writes a Test disc, the Test disc has to satisfy less than 1.0E-3 of R-SER by a Tester. The Tester mentioned above means a tester which satisfies the test conditions specified in the Format Book and the Test disc is a disc authorized by BDA for testing purpose.

Jitter measurement using the Limit-Equalizer

Generally, a playback signal reading system uses a Linear Equalizer to improve the Signal to Noise Ratio (SNR) around minimum-length Pits and to suppress Inter-Symbol Interference. Disc noise exists mainly in a low-frequency region as shown in Fig.1.4.3.1. When high frequency around minimum-length Pits is selectively boosted using the Linear Equalizer, the minimum-Pit-length signal level can be markedly enhanced with only a small increase in the total amount of noise. That is, it is possible to improve the SNR by using a Linear Equalizer that boosts high frequencies. However, since an excessive boosting of high frequencies causes an increase in Inter-Symbol Interference, the Conventional Linear Equalizer has a limit to SNR improvement.

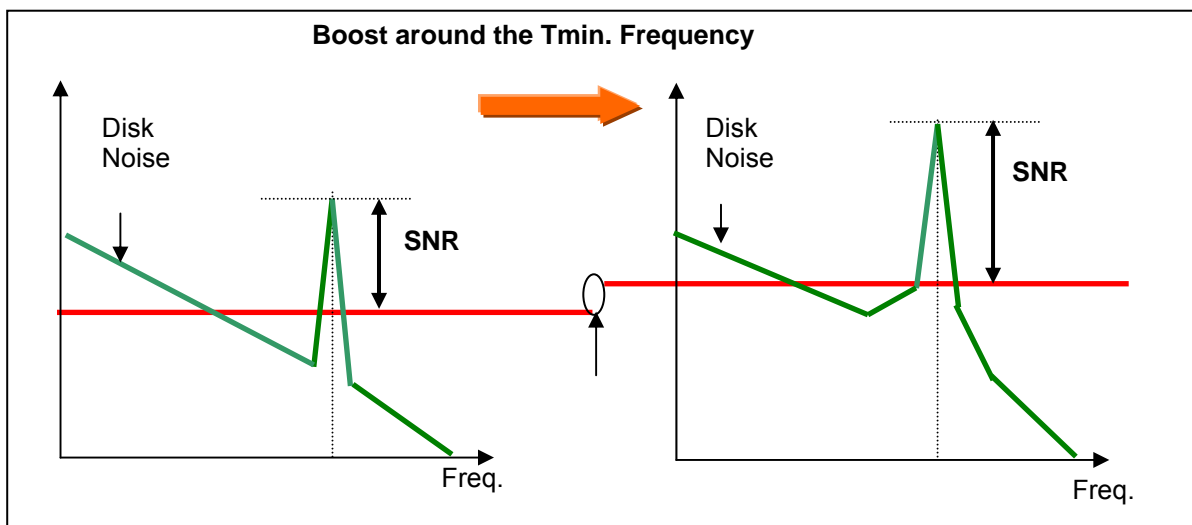

**Fig.1.4.3.1 SNR improvement of a Limit-Equalizer.**

A Limit-Equalizer is capable of boosting high frequencies without increasing Inter-Symbol Interference. Fig.1.4.3.2 shows the configuration of the Limit-Equalizer system used in 17PP modulation. In this system, a Pre-Equalizer first minimizes Inter-Symbol Interference.

A Conventional Linear Equalizer is used as the Pre-Equalizer. The Limit-Equalizer is located next to the Pre-Equalizer. The Limit-Equalizer has almost the same construction as a Finite-Impulse-Response (FIR) Linear Equalizer, except that the Limiter restricts the amplitude of part of playback signal. The FIR filter acts as a high-frequency-boosting Equalizer, and its gain is determined by coefficient "k." The gain of the FIR filter increases with the value of k.

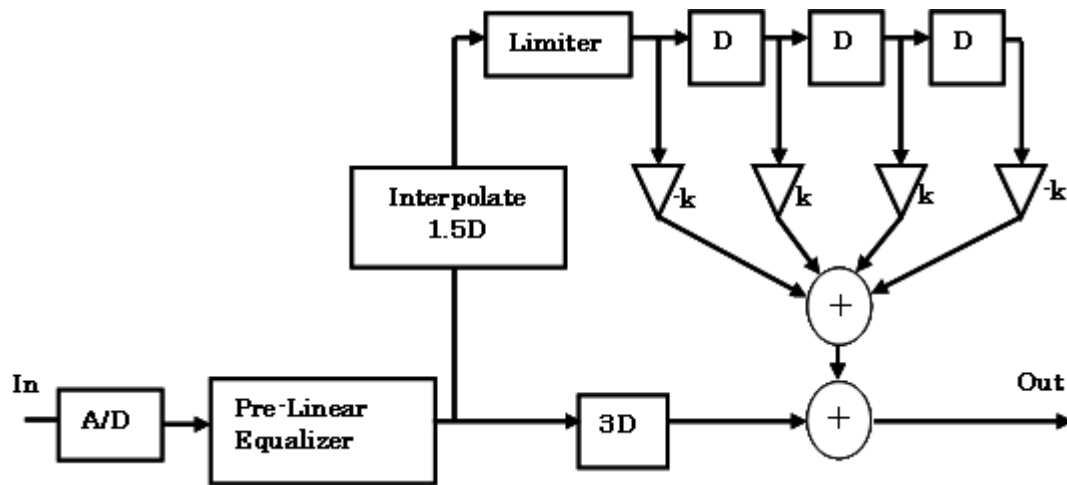

Fig.1.4.3.2 The configuration of a Limit-Equalizer

Sample values of the playback signal are indicated at the small-circle points in Fig.1.4.3.3. To understand the operation of the Limit-Equalizer, we pay attention to the zero-cross point and the sample values at points close to the zero-cross point. The operation of the Equalizer without a Limiter is as follows.

Referring to the left-side chart of Fig.1.4.3.3, if the playback signal waveform is symmetrical as indicated by the solid line, the data summed up by the Equalizer becomes 0 as expressed in Equation (1), and the zero-cross point does not move.

$$(-k)x(-a) + (k)x(-a) + (k)x(a) + (-k)x(a) = 0 \text{ --- (1)}$$

However, if the playback signal waveform is asymmetrical as shown in the dotted line, the data summed up by the Equalizer does not become 0 as indicated by Equation (2), resulting in the Inter-Symbol Interference.

$$(-k)x(b) + (k)x(c) + (k)x(d) + (-k)x(e) \neq 0 \text{ --- (2)}$$

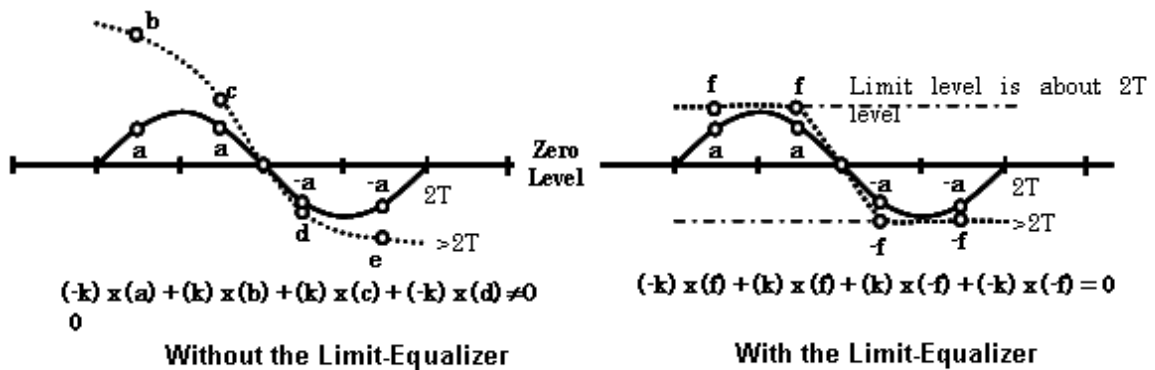

Fig.1.4.3.3 Behavior of a Linear Equalizer. and Limit-Equalizer.



If a Limiter is used to restrict the signal amplitude to around the peak amplitude level of the shortest wavelength signal, the waveform becomes symmetrical as shown by the dotted line in the right-side chart of Fig.1.4.3.3. In that case, the data summed up by the Equalizer is constantly 0, as expressed in Equation (3).

$$(-k)x(-f) + (k)x(-f) + (k)x(f) + (-k)x(f) = 0 \text{ --- (3)}$$

The Limiter does not act on a signal with minimum-length Mark, and the Equalizer amplifies the signal amplitude. For a low-frequency signal with high amplitude, the Limiter restricts the amplitude around the center tap, which is to be added to the sum. The filter gain is effectively decreased. Thus, the Limit-Equalizer can boost high frequencies without increasing Inter-Symbol Interference, and SNR is improved.

Since the Blu-ray Disc™ format adopts high-density recording and 17PP modulation, the minimum Mark length is shorter than for a conventional optical disc, and its SNR is lower. Viterbi decoding in the disc drive can compensate for the lower SNR to achieve good playback performance. However, since Viterbi decoding output is the result after 1/0 determination and is poor in sensitivity, it is not suitable for use in evaluating optical discs in general. The jitter of signals processed by a Linear Equalizer is dominated by the component attributed to the noise of disc itself rather than the component attributed to the quality of Recording Marks, making it difficult to determine whether or not the recording state is optimal. In this regard, a Linear Equalizer is not suitable for use in disc evaluation.

The Blu-ray Disc™ system employs a Limit-Equalizer to improve the SNR and to measure jitter for disc evaluation. With the Limit-Equalizer, it is possible to determine the quality of Recorded Marks with high sensitivity. Fig.1.4.3.4 shows the relation of jitter to the error rate. Though the Limit-Equalizer has a non linear operation block inside, the relationship of input to output is linear and suitable for the measurement system.

17PP 25GROM Jitter vs. SER (defocus)

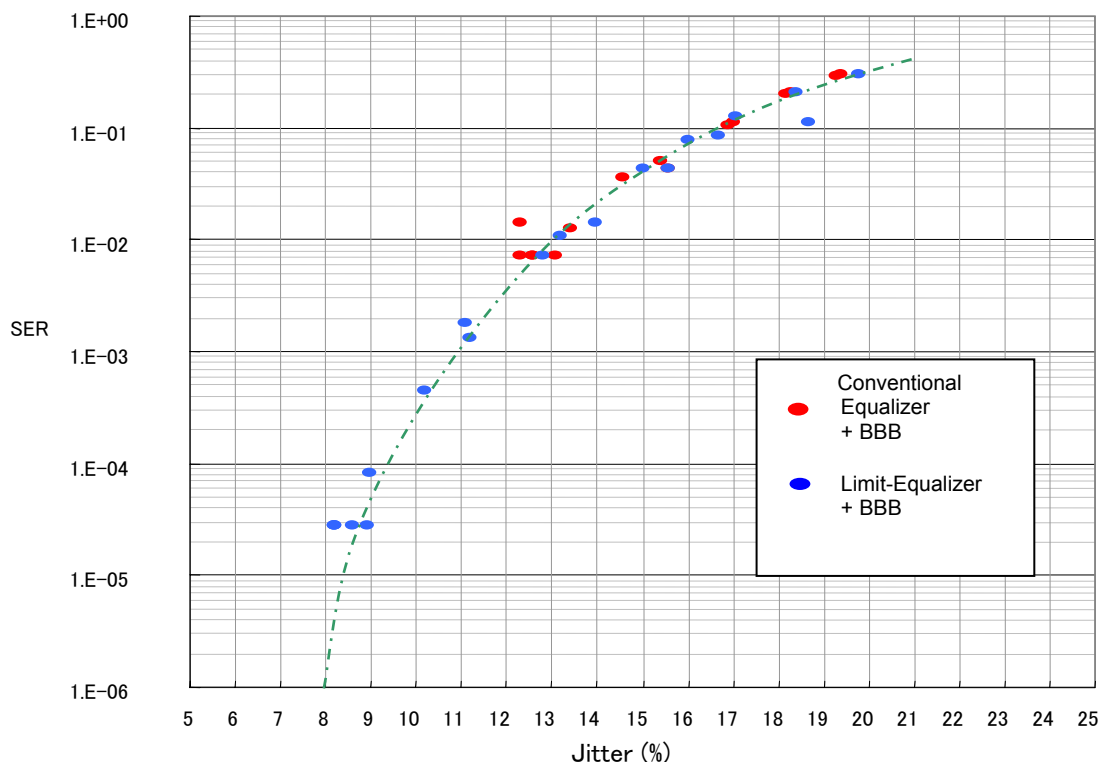
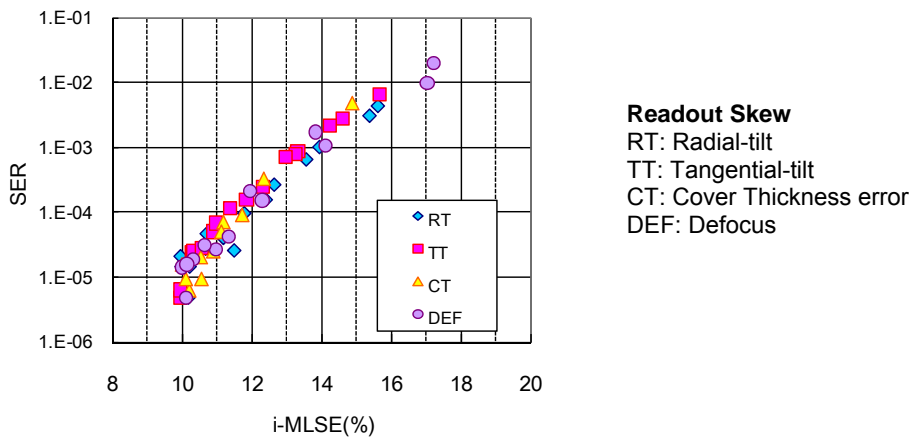

Fig.1.4.3.4 The relation of the error rate and Jitter of the Conventional Equalizer and the Limit-Equalizer

i-MULSE

In BDXL™ formats the capacity per layer is raised up to 33.4GB or 32.0GB only by increasing the linear density. As a result, in BDXL™, the Inter-Symbol-Interference (ISI) of the readout signal becomes much stronger compared to the prior format that allows just 25GB per layer. Therefore the readout signal processing needs to be improved. Also, the prior signal quality evaluation method using the Limit-Equalizer technology has turned out to be no longer applicable. Integrated-Maximum-Likelihood -Sequence-Error-Estimation (i-MLSE), which is an alternative signal quality evaluation method for BDXL™, was newly developed and retains the stability and the precision in such a severe ISI condition of BDXL™. The evaluation method of i-MLSE stands on the detection principle of the Viterbi-Algorithm (VA) in the Partial-Response-Maximum-Likelihood (PRML) readout signal processing. Refer to R or RE White Paper in detail.



Total Noise  
Level

**Figure 1.4.3.5: i-MLSE and SER correlation**

Random Symbol Error Rate (RSER)

ECC is designed to recover the correct data from the data damaged by defects. But ECC ability for correcting data in a disc is used not only for defects but also for the random error in a disc. In order to guarantee the ECC power for the user oriented defects such as fingerprints and scratches, both the Random Symbol Error Rate (RSER) of a disc and defects should be specified. Roughly more than half of the ECC power is reserved for the user oriented defects.

The RSER for judging the system margin is  $4.2 \times 10^{-3}$ . This value is derived from the worst condition that all degradations of a disc and a drive occur simultaneously. Thus such a value is too high for the RSER value in which ECC works. The RSER of  $1.0 \times 10^{-3}$  was used for DVD. The value corresponds to a boundary condition + some degradation such as the worst radial tilt with some tangential tilt and some defocus in a rather bad drive. In the BD system a Viterbi decoder is located between the retrieved HF signal and an ECC circuit. The Viterbi decoder has the ability of the SNR improvement and it can reduce the RSER value below 1/10. The measurement circuit Limit-Equalizer also can improve SNR as same as the Viterbi decoder and it also can reduce the RSER value below 1/10. For the RSER value of a disc measured after the Limit-Equalizer a value of  $2.0 \times 10^{-4}$  is specified, which is 1/5 of  $1.0 \times 10^{-3}$ . In order to measure RSER the degradation due to the defects should be taken out. At the development stage the averaging in a large ECC Blocks was used for removing the effects of defects. But the averaging method was not enough for measuring such the low RSER value. In the inner radius there are 2.11 ECC Blocks within one rotation. If there is a large defects as shown in Fig.1.4.3.6 then some 100 bytes errors are counted in every 2.11 ECC Blocks. That is the reason why the measured RSER jumped up around a defect.

Then it was decided to separate the defects and the RSER in the measurement method. Considering the ECC ability the allowed defects in an ECC Block (In the specification the block is called LDC Block.) is specified as 600 bytes in total and the maximum number of defects is specified as 7. From the measured RSER the consecutive errors longer than or equal 40 bytes are excluded. 40 bytes is the length of the 2 BIS (Burst Indicating Sub code) + data between BIS (38 bytes) and it corresponds to the minimum burst error length BIS can detect. In order to detect the burst error correctly the ECC method measurement as shown in Fig.1.4.3.7 is used. The correct data can be obtained after an ECC. By using additional circuit for the measurement the correct data after ECC is interleaved in order to get the correct data allocation on a disc. It is compared with the data on a disc and the erroneous symbols are identified.

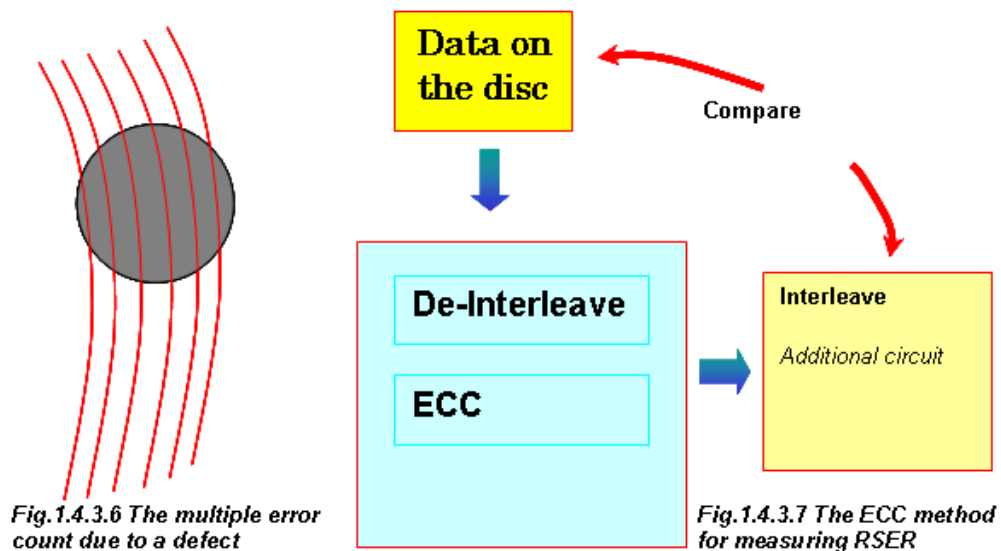

There are many cases that some correct bytes exist between the erroneous bytes. Fig.1.4.3.8 shows an example of an error pattern. In order to judge the 40 bytes burst error length the following procedure was specified. The burst starts after the correct bytes longer than or equal 3 bytes. The error length count continues if the correct bytes length between error bytes is less than or equal 2. The error length count stops if there appear correct bytes longer than or equal 3 bytes. Though the error length includes the correct bytes less than or equal 2 bytes, those correct bytes are excluded from the number of the erroneous bytes. The errors longer than or equal 40 bytes are excluded from both the numerator and the denominator of the RSER calculation. But the burst errors below 40 bytes are still included in the erroneous bytes. Although RSER is averaged over 10000 ECC Blocks, for the measurement 1000 Blocks averaging is allowed if the disc shows good RSER.

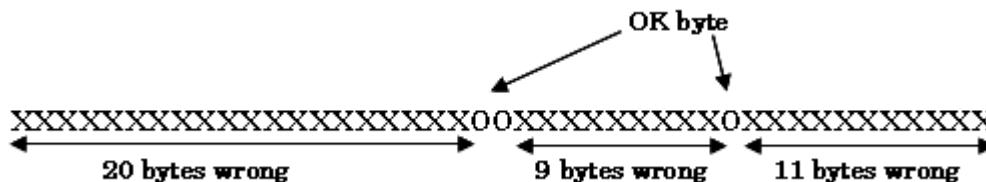

Fig.1.4.3.8 An example of the error pattern

[References]

- 1) K.A. Rubin et al: Proc. SPIE 2338 (1994) 247.
- 2) K. Nagata et al: Jpn. J. Appl. Phys. 38 (1999) 1679.
- 3) S. Hayashi et al: Technical Digest of ISOM2001, Taipei, Pd-33 (2001) 310.

## 1.5 Contents Protection System and Interface

Since BD assumes that the HD contents of digital broadcasts are being recorded, capabilities to protect such content, if desired, are more important than with conventional DVDs, on which only SD contents are recorded. Thus a new contents protection system (Advanced Access Content System Blu-ray Disc Recordable Book) optimized for MPEG-TS recordings of digital broadcasts has been adopted.

Fig. 1.5.1 shows the outline of the contents protection system when digital broadcast contents are recorded. Before the start of recording, copy control information within the digital broadcast signal is detected. When copying is allowed as per the copy control information, the contents and copy control information are protected and recorded on the disc. During playback, recorded contents are decoded and outputted from a device on which contents protection technology is installed, based on a copy control information.

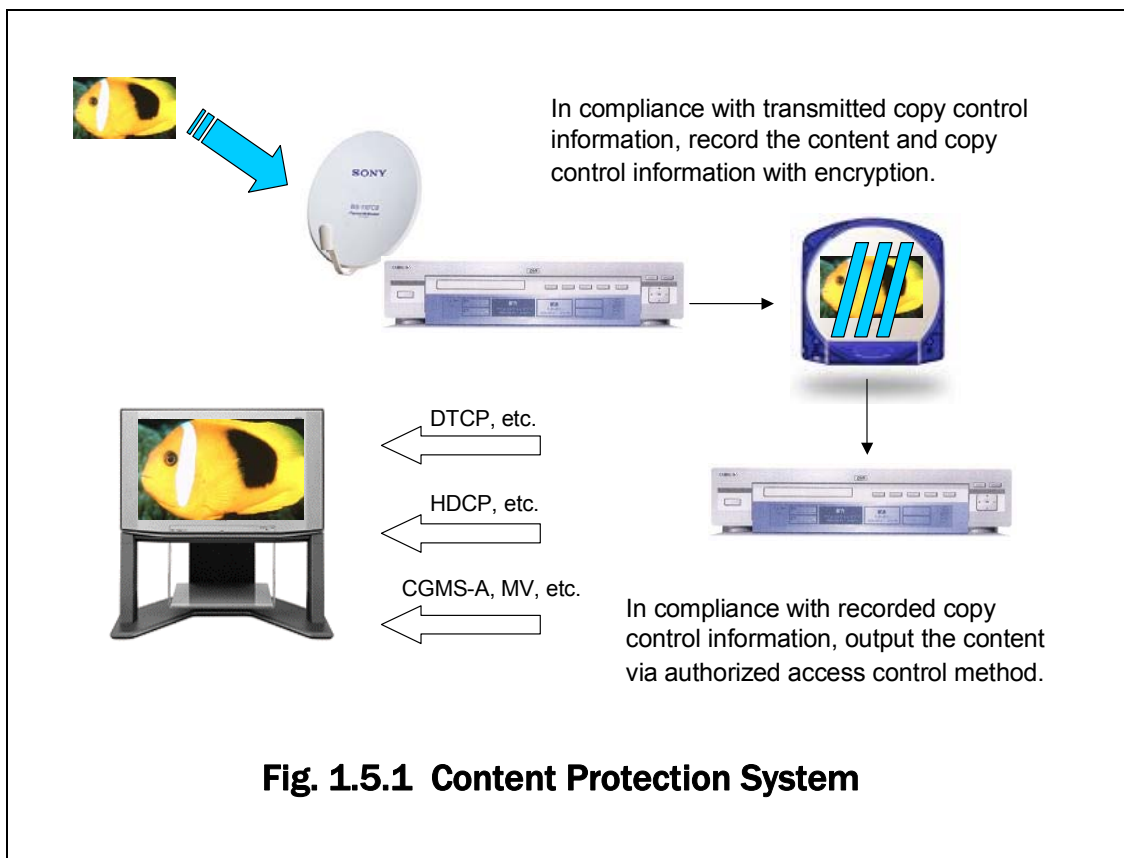

**Fig. 1.5.1 Content Protection System**

In the BD contents protection system, AES (Advanced Encryption Standard) with a key length of 128 bits has been adopted. In addition, for the exclusion of illegal devices (System Renewability) and for the prevention of illegal copying, MKB (Media Key Block) information and a Disc ID which is unique to the disc are written in the disc. Each recorder (player) has device keys, which differ depending on the manufacturer or the machine. An encryption key is generated by combining the device key and MKB. Therefore, illegal devices can be excluded by updating the MKB information. Furthermore, illegal copying is also prevented by using a Disc ID which is unique to the disc.

In addition to such highly-secure coding during recording, by implementing the contents protection technology in the interface to output played-back contents, illegal copying and retransmission to the general public through Internet can be prevented. Before being outputted, contents are protected by DTCP \*1) for MPEG-TS stream output and by HDCP \*2) for baseband digital output. In addition, CGMS-A and Macrovision copy control signal \*3) are added to the analog image signal.

- \* 1) Digital Transmission Content Protection: A content protection technology developed by five companies: Hitachi, Intel, Panasonic, Sony, and Toshiba. The specification is proprietary, and implementing DTCP requires a license.
- \* 2) High-bandwidth Digital Content Protection: A content protection technology developed by Intel. The specification is proprietary, and implementing HDCP requires a license.
- \* 3) Macrovision is a content protection technology developed by Rovi Corporation. The specification is proprietary, and utilizing Macrovision requires a license.

## 1.6 Hard-Coating for Bare Disc

BD is much more sensitive to scratches and fingerprints compared with DVD. Slight scratch or fingerprints will cause deterioration of error rates and/or loss of a tracking servo control. To avoid such problems, the first generation BD-RE (ver1.02) is protected with a Cartridge case. A Bare disc, however, is desired in order to downsize a disc drive. In addition, it is preferred to reduce the media manufacturing cost by making them Cartridge-free.

Thus the Hard-coat technology for the Bare discs has been explored, aiming mainly at scratch- and fingerprint-resistances. Hard-coatings have already been applied to some conventional optical media such as DVD-RW. UV-curable acrylic resin has been used as the Hard-coat in such cases. Although they have a moderate scratch-resistance, higher hardness will be necessary for some BD applications. Moreover, a problem of fingerprint has not been considered. Therefore many kinds of materials have been investigated for alternative Hard-coat. As a result, it was concluded that colloidal silica-dispersed UV-curable resin is one of the most promising candidates, in which scratch-resistance, optical property, and productivity are compatible<sup>1)</sup>.

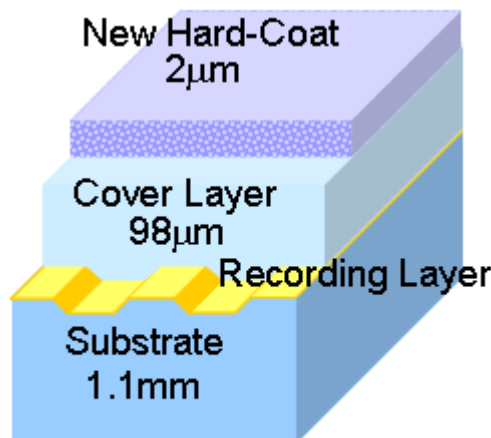

**Figure 1.6.1** Cross section of BD with the new Hard-coat.

The disc structure is shown in **Fig. 1.6.1**. A light-transmitting layer consists of a 98 µm thick Cover Layer and a 2 µm thick Hard-coat. For example, both layers can be spin-coated successively<sup>2)</sup>. In that case, a conventional UV-curable resin without colloidal silica can be used as the Cover Layer.

Typical properties of the Hard-coat are outlined below. In **Fig. 1.6.2** jitter values of BD-REs are shown with (a) polycarbonate sheet, (b) conventional UV-curable Hard-coat and (c) the new Hard-coat, whose surfaces were worn away by rubbing with steel wool. In the disc (c), over 300 times of abrasion did not give rise to deterioration of the jitter value. For general use, you will be able to obtain a secure feeling comparable to that of DVDs by the conventional Hard-coat (b), from a viewpoint of scratch-resistance. The new Hard-coat (c) will be required, however, to enhance reliability of BD systems, and will open up wide variety of applications (eg. long-term data archiving, use for camcorder, etc.).

Regarding the problem of fingerprints, you may accidentally put your fingerprints on a blank disc before setting it on a recorder. Generally data signals recorded over fingerprints contain much more errors than ROM data signals read through fingerprints. This is the reason that fingerprint-resistance is viewed as more crucial property in BD-RE or BD-R, compared to BD-ROM.

Against such a background, BD-RE requires some kind of Protective Coating to reduce an impact of fingerprint. Additionally, we should establish the way to evaluate an effect of fingerprints to the BD system, if BD-RE mandatory requires such a Protective Coating. In BD-RE format, anti-fingerprint effect is to be quantified as follows (**Fig. 1.6.3**).

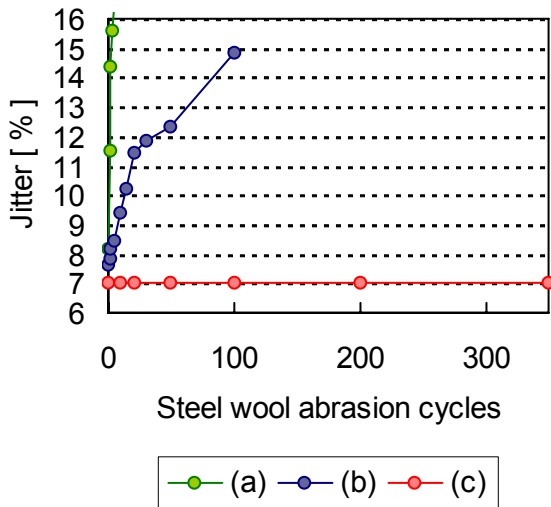

**Figure 1.6.2** Changes of jitter value of BD-REs with (a) polycarbonate sheet, (b) conventional UV-curable Hard-coat and (c) the new Hard-coat, whose surface were worn away by #000 steel wool with a load of 100 g/cm<sup>2</sup>. Random signals were written, followed by steel wool rubbing, and then jitter values were measured.

In the evaluation method, originally prepared artificial fingerprint (AFP) reagent is necessary<sup>3)</sup>. AFP reagent is a suspension which mainly consists of triolein (viscous fatty oil) and inorganic particle. Inorganic particles simulate insoluble ingredients and/or waxes included in actual fingerprint. It also has a function to enhance repeatability of AFP test. A procedure to put AFP onto the disc surface is based on that prescribed in JIS K2246:1994 with some modifications. In BD-RE format, SER shall be less than  $4.2 \times 10^{-3}$ , which is measured for the data signal recorded through AFP of prescribed level. This AFP level was determined with reference to the impact of fingerprint to DVD-RW/+RW/-RAM. In other words, BD-RE specification for bare disc guarantees fingerprint-resistance, which is comparable or superior to that of recordable DVDs.

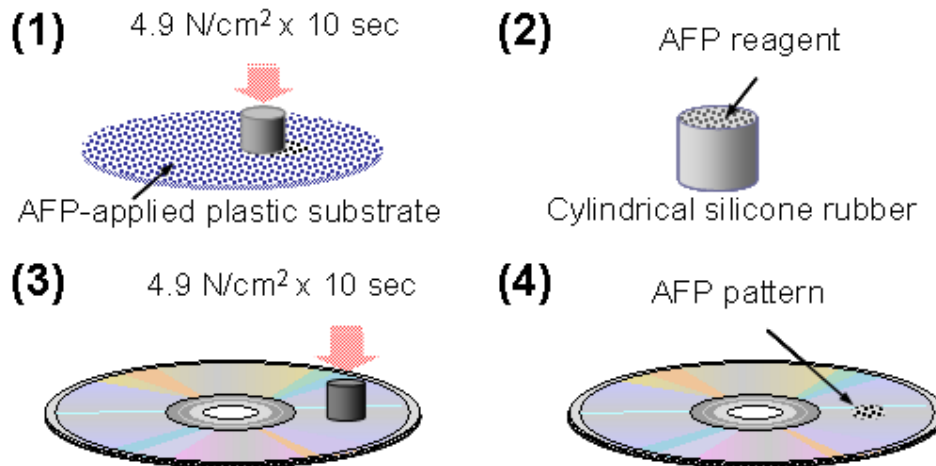
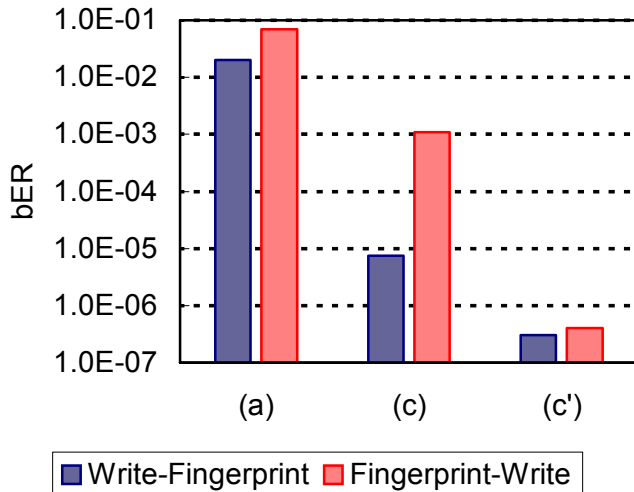

**Figure 1.6.3** Procedure to put AFP onto BD-RE. Firstly AFP reagent is prepared by mixing triolein, #11 of JIS test powder 1, and methoxy propanol (5/2/60 in weight). Then next, (1) AFP reagent-applied plastic (polycarbonate) substrate is prepared by spin-coating method (eg, 100rpm for 1sec, then 5000rpm for 1sec), and cylindrical silicone rubber is pressed on the substrate, thus (2) AFP reagent is put on an end face of the silicone rubber. The silicone rubber shall be preliminarily ground with sand paper as prescribed in JIS K2246, prior to the procedure (1). And then (3) the silicone rubber is pressed onto the surface of the disc to be evaluated, thus (4) AFP-applied BD-RE is prepared. A bare BD-RE specification requires that SER of above AFP-applied BD shall be less than  $4.2 \times 10^{-3}$ , which is measured for the data signal recorded through AFP.

1.6 Hard-Coating for Bare Disc

Actually, above-mentioned new Hard-coat is easily endowed with an anti-fingerprint property. It is possible to upgrade fingerprint-resistance while maintaining the original hardness of the silica-dispersed hard-coat.

In **Fig. 1.6.4** anti-fingerprint properties measured for different Hard-coatings are shown. AFPs were put onto the light-incident surfaces of (a) and (c), then bERs were measured (symbols for each sample are same as in **Fig. 1.6.2**). It must be noted that AFP level (*i.e.*, amount of AFP) applied to this evaluation is different from that in BD-RE specification, for experimental purpose.



**Figure 1.6.4** bERs measured after AFP adhesion. Blue bars represent bERs of the signals written before AFP adhesion, and red ones indicate bERs for the signals recorded after AFP adhesion.

As shown in **Fig. 1.6.4**, the impact of the fingerprint was severe in the disc (a), and tracking was not controllable in some cases. On the other hand, the disc (c) exhibited the bER of around  $1.0 \times 10^{-5}$ , which was measured for the data signal recorded prior to adhesion of AFP. In the disc (c'), anti-fingerprint property was improved while maintaining abrasion-resistance (see **Fig. 1.6.4**). It exhibited adequate fingerprint-resistance for the signals recorded both before and after the fingerprint adhesion.

Next, playability of AFP-applied BD-RE and DVDs was verified on commercial disc drives. As indicated in **Tab. 1.6.1**, BD with Hard-coat (c) shows good fingerprint-resistance which is equal or superior to that of DVDs. From the aspect of recording motion picture, the disc (c) will allow rough handling comparable to that of DVDs.

For all the playability results, the disc (c) may be still sensitive to fingerprint in terms of error rate, which is measured for the data signal recorded through fingerprints. However, playability could be further improved by using the anti-fingerprint hard-coating of type (c') due to the reduced bER especially for writing through FP.

**Table 1.6.1** Recordability and playability test on commercial disc drives.

	Artificial fingerprint level		
	Heavy	Medium	Light
Disc (a)	R/W NG	R/W NG	OK
Disc (c)	OK	OK	OK
DVD-R	R/W NG	OK	OK
DVD-RW	R/W NG	OK	OK
DVD-RAM	R/W NG	Read NG	OK

\*Commercial disc drives used in above test: BDZ-77 (Sony) for BD, DVR-55 (Pioneer) for DVD-R/-RW, and DMR-550 (Panasonic) for DVD-RAM.

\*Respective criteria were as follows: OK = both recording and playback normally completed; Read NG = recording operation completed (precise recording may not be done), but not playable; R/W NG = neither recording nor playback completed.

As shown in **Fig. 1.6.5**, the amount of AFP decreased drastically in discs (a), (c) and (c'), in this order. It implies a clear correlation between the amount of AFP and resulting bERs. In **Fig. 1.6.6**, shown is bER dependency on the area ratio of AFP. As can be seen from the figure, error rate depends almost entirely upon AFP area ratio, and is independent of the nature of the disk surface. In



other words, the disks (c) and (c') are endowed with the property to afford lower fingerprint area ratio compared to the disc (a), when you apply fingerprints of the same level.

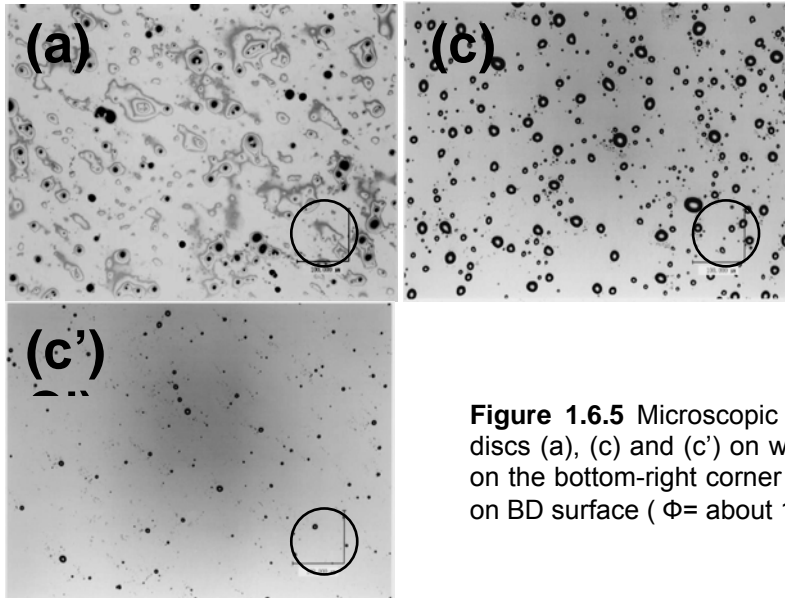

**Figure 1.6.5** Microscopic images of surfaces of the discs (a), (c) and (c') on which AFP was put. Circles on the bottom-right corner represent a laser spot size on BD surface ( $\Phi$ = about 130  $\mu$ m).

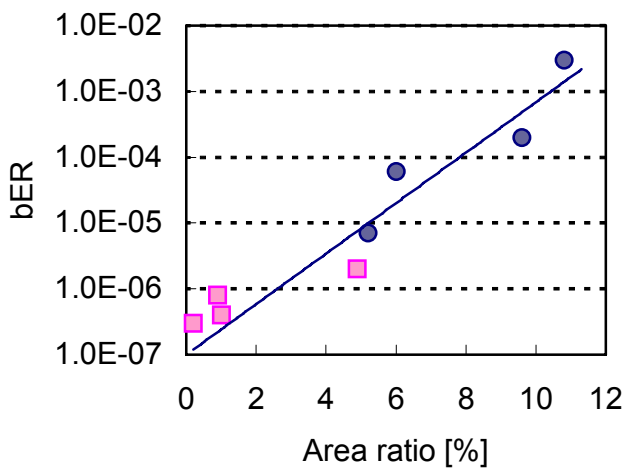

**Figure 1.6.6** bER dependency on AFP area ratio. Circular dots represent the data obtained for the disc (c), and square ones for the disc (c')

Although only “fingerprint repency” was described in this article, the discs (c) and (c') are superior to the disc (a) also in terms of “fingerprint removability”. It should be noted that the new Hard-coat (c') combined with the spin-coated Cover Layer has good production ability and will achieve the production cost comparable to that of recordable DVDs.

- 1) N. Hayashida, H. Hirata, T. Komaki, M. Usami, T. Ushida, H. Itoh, K. Yoneyama, and H. Utsunomiya, Jpn. J. Appl. Phys., 42, 750-753 (2003).
- 2) T. Komaki, H. Hirata, M. Usami, T. Ushida, N. Hayashida, H. Inoue, T. Kato, H. Shingai, and H. Utsunomiya, Jpn. J. Appl. Phys., 41, 3922-3923 (2002).
- 3) N. Hayashida, H. Itoh, K. Yoneyama, T. Kato, K. Tanaka, and H. Utsunomiya, Proc. of SPIE Vol. 5069, 361-368 (2003).

## 1.7 Blu-ray™ discs and Cartridges

Cartridge is defined for RE\_Part1 V1 as mandatory, and R\_Part1 V1 and RE\_Part1 V2 as option, and not defined for R\_Part1 V2 and RE\_Part1 V3 (see Fig. 1.8.2).

Two kinds of Blu-ray™ Cartridges has been defined, as shown in the figures below. As seen in Fig. 1.7.1-1.7.4, one has an opening for a printed surface and the other has an entirely sealed Cartridge structure. The shielded Cartridge was an option until August 31, 2003 and should not be used anymore. It should be possible to remove the disc from the Cartridge.

Fig. 1.7.1:



Fig. 1.7.2:

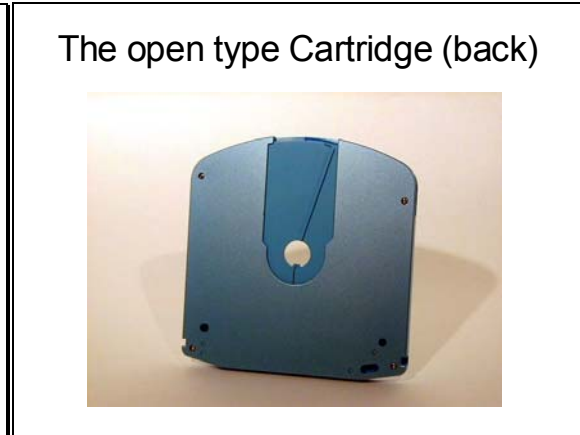

Fig. 1.7.3:



Fig. 1.7.4:



With respect to the open type Cartridge, the mechanism for releasing the disc can be freely designed by the manufacturer of the Cartridge as long as the Cartridge fulfills all specifications. Results of a dust test of this open type are shown in the figure below.

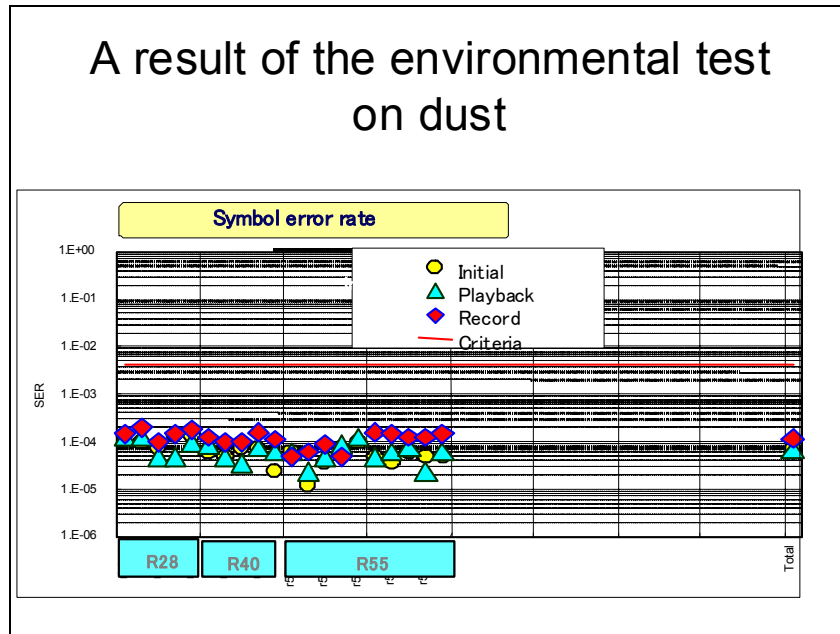

Fig. 1.7.5: A result of the environmental test on dust

This Cartridge has a mechanism to latch the disc. The latch is not released until a disc is inserted. The recording side is closed. When latched, the disc is in close contact with the Cartridge at the inner and outer perimeters to prevent dust. Data shown in the figure is a prediction for ten years of usage assuming a typical home environment. The error rate is far below the standard rate of 4.2E-3 per byte for Blu-ray™ (shown by the red line in the figure), and this durability is regarded as sufficient. It is expected that Blu-ray™ discs can be treated a little more roughly, like VTR tapes, by adopting the Cartridge.

The mechanism for releasing the disc can freely be designed by the manufacturer of the Cartridge as long as the Cartridge fulfills all specifications.

1.8 All Books

Fig.1.8.1 shows the history of the format creation in BDA and fig.1.8.2 shows all Books licensed by BDA. A gray box in Fig.1.8.2 shows FLLA (Format and Logo License Agreement). Part1 (Physical Specifications), Part2 (File System Specifications) and Part3 (Application Specifications) are licensed under the FLLA for each format.

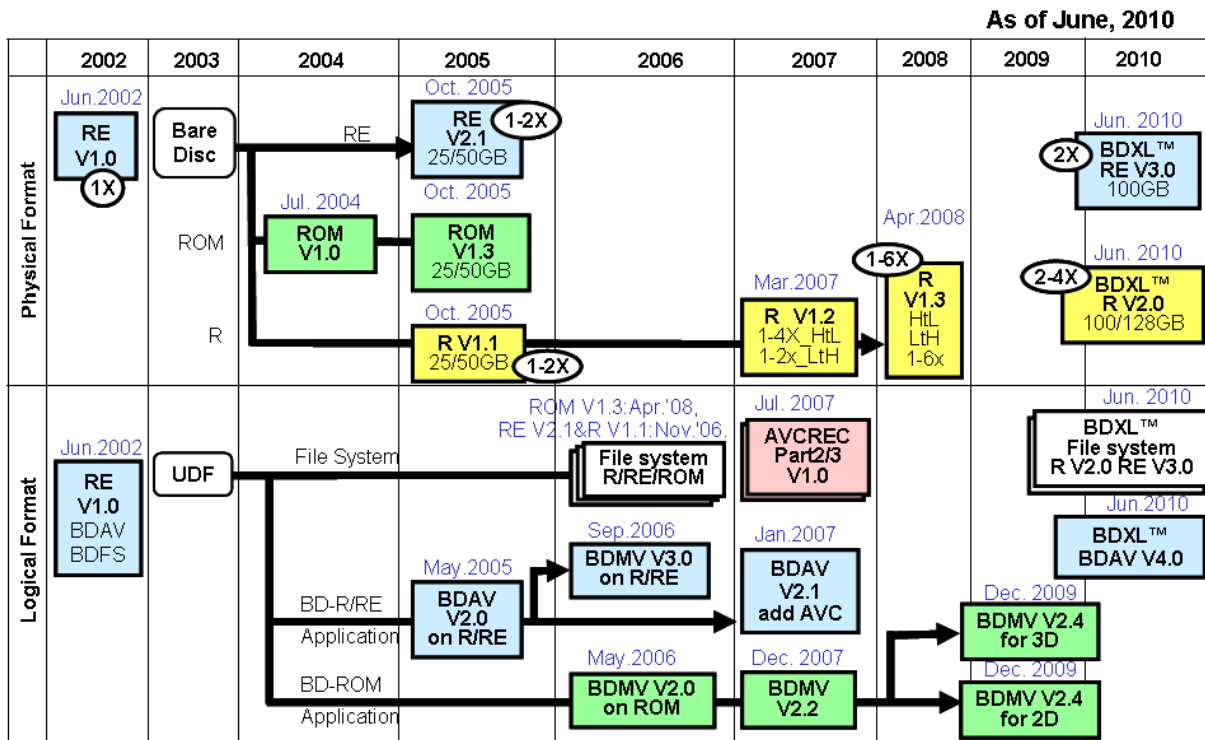

Fig.1.8.1 History of the format creation in BDA

RE1.0, the first standard, was issued in June 2002. Cartridge is mandated. Additional capacities of 23GB (a single layer) and 46GB (a dual layer), and the BD unique File system as BDFS are defined only in RE1.0. All other formats adopt a Bare disc in Part1 and UDF (Universal Disk Format), highly compatible with PC environment, in Part2. The storage capacity is 25GB (for Single Layer disc), 50GB (for Dual Layer disc), 100GB (for Triple Layer disc) and 128GB (for Quadruple Layer disc). Part1 of either R or RE defines an 8 cm disc of which capacity is 7.8GB for Single Layer disc or 15.6GB for Dual Layer disc. Both ROM disc and BDXL™ disc have no 8 cm disc defined.

High data transfer rate is achieved as described in Fig. 1.8.1. Both the large capacity and the high data transfer rate are suitable for not only CE use but also PC use, and BDXL™ disc can be expected to expand to professional use.

BDAV Specification for recording TV programs is prepared as the Application format Part3 for R disc and RE disc. The same Part3 Book applies for both R and RE. On the other hand, BDMV Specification for storing mainly a movie title is prepared as Part3 for ROM disc. It adopts several advanced Video CODEC besides MPEG2 in order to hold longer high definition movie contents at high picture and sound quality. BDMV Specification is also applied to R disc as R2.0 and RE disc as RE3.0. 2D Specifications are defined in Part3 of ROM2.0 and 3D Specifications are defined in Part3 of ROM3.0. 3D specifications should be referred to ROM Part3 White Paper in detail. AVCREC™ is the format which can record TV programs on DVD discs by using BDAV Specification.

As of June 2010

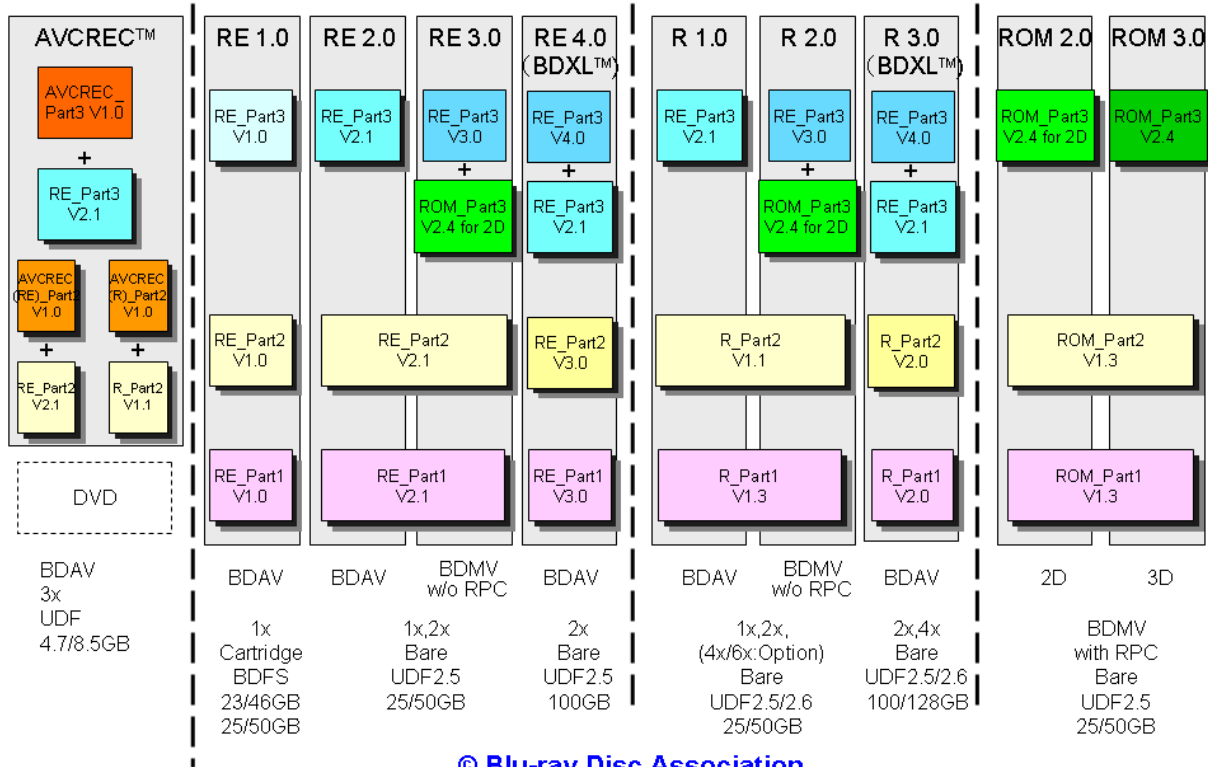

© Blu-ray Disc Association

Fig.1.8.2 All Books