

# HK45 / HK45 Compact Operator's Manual



**HK**<sup>®</sup>  
HECKLER & KOCH

Covers all HK45 (.45 ACP) series pistols including: HK45, HK45 Tactical (HK45T), HK45 Compact (HK45C) and HK45 Compact Tactical (HK45CT) models.

## SAFETY PRECAUTIONS

### CAUTION: Read the safety rules before handling the pistol!

Read this operators manual before handling your firearm. The following safety rules are placed in this manual by HK as an important reminder that firearms safety is your responsibility. If handled improperly firearms can be dangerous and can potentially cause damage to property, serious injury, or death.

1. Never point a firearm at anyone, or in any direction other than a SAFE direction, i.e. downrange.
2. Treat all firearms as if they are always loaded.
3. Keep your finger off the trigger and outside of the trigger guard until your sights are aligned on the target.
4. Keep your finger off the trigger and outside of the trigger guard while loading or unloading the firearm.
5. Keep your finger off the trigger and outside of the trigger guard while pulling the firearm out of the holster or while returning it to the holster.
6. Be sure of your target and the back stop beyond.
7. Never give a firearm to or take a firearm from anyone unless the action is open and the magazine and/or chamber are free of any ammunition or brass.
8. Be sure that the ammunition you are using is factory loaded, is of the correct caliber for the firearm in which it is to be used, and that it is not damaged in any way.
9. Before firing, remove the magazine from the firearm, lock the slide open, make sure the chamber is clear of any ammunition or brass, and check the barrel of the unloaded firearm for any possible obstructions.
10. Before firing any firearm that is unfamiliar to you, make sure that you understand exactly how it functions. A lack of familiarity with the firearm can result in serious accidents. Attend a certified training course on any firearm which you intend to use or with which you are not sufficiently familiar.
11. Always wear hearing and eye protection when using your firearm.
12. Keep all body parts, particularly the hands and fingers, away from the muzzle to avoid injury or burns.
13. Be sure that parts of the hand do not touch or interfere with the slide. The slide moves backwards by recoil force during firing and may cause serious injury.
14. Firearms should be stored separately from ammunition and beyond the reach of children, and/or any untrained individuals.
15. Avoid the use of any alcoholic beverages or drugs before and during the use of any firearm.
16. Discharging firearms in poorly ventilated areas, cleaning firearms, or handling ammunition may result in exposure to lead, a substance known to be associated with birth defects, reproductive harm, and other serious injury. Have adequate ventilation at all times. Wash hands thoroughly after exposure.
17. To make the HK45 pistol safe, one must insure the chambered round is removed during the clearing procedure. Removal of the pistol's magazine does not remove the chambered round. This can only be done with the rearward movement of the slide after the magazine is removed.

### STOP! KNOW HOW TO CLEAR THIS PISTOL BEFORE ATTEMPTING TO OPERATE.

#### CLEARING THE PISTOL

The HK45 series of pistols are not considered "clear" or safe unless:

1. The control lever (if applicable) is on "safe" and;
2. The magazine is removed from the pistol and;
3. The slide is locked to the rear and;
4. The chamber is free of brass or ammunition

#### To Clear the HK45 / HK45C:

1. Make sure fingers are outside of the trigger guard and the pistol is pointed in a safe direction at all times!
2. Engage control lever (if applicable) - press the control lever upwards until the "S" (safe) aligns with the reference line located on the frame.
3. Remove magazine - depress the magazine release lever and remove the magazine from the pistol.
4. Open and lock slide - while keeping the pistol pointed in a safe direction, lock the slide open by pulling the slide rearward as you press the slide release upward. Watch for a cartridge or empty case to be ejected from the pistol.
5. Inspect chamber - inspect chamber for the presence of a cartridge or empty case by:
  - Visually viewing chamber through the open ejection port and;
  - Physically inserting a finger into the chamber through the ejection port to check for the presence of a cartridge or empty case.
  - Remove any cartridges or empty cases from the chamber or from within the pistol.

The Pistol is now considered "Clear."

**WARNING: A firearm has the capability of taking your life or the life of someone else! Be extremely careful with your firearm. An accident can occur at anytime and is almost always the result of not following basic safety rules.**

## HK45/HK45 Compact Operator's Manual



**Covers all HK45 (.45 ACP) series pistols including: HK45, HK45 Tactical (HK45T), HK45 Compact (HK45C) and HK45 Compact Tactical (HK45CT) models.**

**Heckler & Koch**  
5675 Transport Boulevard  
Columbus, Georgia 31907 USA  
Tel: (706) 568-1906  
Fax: (706) 568-9151  
American Website: [www.hk-usa.com](http://www.hk-usa.com)  
Global Website: [www.heckler-koch.com](http://www.heckler-koch.com)

## **TABLE OF CONTENTS**

<b>Safety Rules</b> .....	inside cover
<b>Section 1 Introduction</b> .....	<b>6</b>
Changing/Converting Variants.....	8
Special Information on the LEM.....	8
Law Enforcement Modification (LEM) Description .....	8
Parts Unique to the Law Enforcement Modification .....	9
Operation of the Law Enforcement Modification .....	9
Traditional Double Action Only (DAO).....	10
Special LEM Considerations and the Lock-Out Device .....	11
Long Term Pistol Storage .....	11
Firing the HK45 equipped with LEM .....	11
<b>Section 2 Description</b> .....	<b>12</b>
Trigger and Firing Modes.....	12
Changing/Converting Variants & Unique Features .....	13
Nomenclature .....	16
Specifications .....	18
<b>Section 3 Function and Operation</b> .....	<b>19</b>
Clearing .....	19
Operating Controls and Components .....	20
Sights and Sight Adjustment.....	22
HK45 Tactical.....	23
<b>Section 4 Ammunition</b> .....	<b>26</b>
<b>Section 5 Instructions for Use</b> .....	<b>28</b>
Loading / Filling the Magazine .....	28
Unloading / Emptying the Magazine .....	28
Loading the Pistol .....	29
Firing the Pistol .....	29
Unloading the Pistol.....	30
Selection and Use of a Holster.....	30
Returning the Pistol to the Holster .....	31
Storage and Transport .....	31

## **HK45 & HK45 Compact**

<b>Section 6 Disassembly and Assembly</b> .....	<b>32</b>
Disassembly (Field stripping) .....	32
Removal / Installation of Modular Backstraps.....	34
Assembly .....	37
Function Check .....	40
Magazine Disassembly .....	44
Magazine Assembly .....	45
<b>Section 7 Cleaning and Maintenance</b> .....	<b>46</b>
Inspection .....	48
Lubrication .....	48
<b>Section 8 HK LOCK-OUT Device</b> .....	<b>50</b>
<b>Section 9 Exploded Views &amp; Parts Lists</b> .....	<b>52</b>
HK45 Exploded Diagram .....	52
HK45 Parts List .....	53
HK45 Compact Exploded Diagram .....	54
HK45 Compact Parts List .....	55
Firearms Service Record .....	56

## SECTION 1

### INTRODUCTION

The HK45 and HK45 Compact were developed as product improvements to the highly regarded HK USP45 and USP45 Compact family of pistols, first released in the 1990s. New user-inspired enhancements found on the HK45 and HK45 Compact are also found on recent Heckler & Koch semi-automatic pistols, including the P2000, P2000SK (Subcompact), and P30.

The HK45 and HK45 Compact were also developed as possible candidates for the Joint Combat Pistol (JCP) and Combat Pistol (CP) programs administered by the U.S. military in their search for a new service handgun to replace the 9mm M9. These programs were suspended before completion and no pistols were selected.

#### Key features and system characteristics

- Integral MIL STD 1913 (Picatinny) rail molded into the polymer frame dust cover for mounting lights, laser aimers, and other accessories
- Ergonomic (HK45 full-size) and slim-line (HK45 Compact) grip profiles with user replaceable grip panels to adjust the feel and grip circumference of the weapon to suit individual operator hand size and shooting preference
- HK45/HK45C grip-to-slide angle matches Model 1911's profile
- Common high-capacity metal magazines with a capacity of 10 rounds (for both models). A compact 8-round magazine is also available for use with the HK45C
- Ambidextrous controls with dual slide releases and enlarged magazine release
- Uses the proven modified Browning linkless recoil operating system
- O-ring barrel for precise barrel-to-slide lockup
- Polygonal rifling for longer barrel life and better accuracy
- Improved ergonomic control levers (safety and/or decocking)
- Low profile drift adjustable 3-dot sights
- Contoured and radiused slide with forward slide (grasping) grooves and anti-glare longitudinal ribs

The HK45 and HK45C (Compact) are designed for the commercial, law enforcement, and military markets. Both models are available, or can be converted to, a wide variety of variants that use different trigger firing modes, including SA/DA (single action/double action), SA (single action) Only, and DAO (double action only) using the unique HK LEM (Law Enforcement Modification) system.

The control lever, a combination safety and decocking lever, is frame mounted and quickly accessible; unlike the slide mounted safeties common on many pistols. The HK45 control lever has a positive stop and returns to the "fire" position after decocking.

## HK45 & HK45 Compact



Figure 1 HK45 Compact (left) HK45 (right)

By using a modular approach to the internal components, the control lever function of the HK45 can be switched from the left to the right side of the pistol to accommodate left handed shooters. Left, right and ambidextrous control levers provide safety and/or decocking functions as required and can be fitted to the pistol simply by changing parts. A control lever can also be mounted on both sides of the pistol if required.

Like the Model 1911 pistol, the HK45 properly outfitted, can be safely carried "cocked and locked." Most DAO variants of the HK45 have no external control lever.

The polymer frame of the HK45 was designed using technical experience gained by HK engineers in the development of the world's first composite material pistols, the VP70Z and P9S. This same type high-strength and corrosion free material is used in the Mark 23 .45 ACP pistol designed by Heckler & Koch and fielded within the US Special Operations Command (USSOCOM). HK's experience working with polymers in handgun designs continued with the USP, USP Compact., P2000, P2000SK, and most recently the P30.

**NOTE: Scratching of the external surface and/or holster wear of the finish is normal and not covered under warranty. Any finish may wear over time.**

Major metal components like the one-piece, machined steel slide are treated with a special, extremely hard, nitro-carburized protective exterior treatment that resists corrosion from salt spray and wear from hard use.

A unique internal mechanical recoil reduction system reduces the recoil forces imparted to the weapon and shooter by as much as 30%, improving shooter control during rapid firing and component service life. Capable of firing standard .45 ACP ball through +P ammunition, the HK45 combines the accuracy, modularity, reliability and minimum 20,000 round service life of the famed USP45 series with the improved ergonomics of the P2000 series pistols. Both HK45 models can be fitted with threaded barrels for use with muzzle mounted sound suppressors.

**Changing/Converting Variants**

Due to this innovative design approach unique to some HK pistols, it is possible to modify an HK45 into any one of the listed variants.

Changing the trigger/firing mode of the pistol is accomplished by installing a different set of component parts. Not only can the control lever function (safety/decocking) be switched from one side of the pistol to the other, it is possible to have a single-action/double-action (SA/DA) version converted to a double action only (LEM DAO) version, or to any other configuration listed. Optional ambidextrous controls are available.

This unique design allows the HK45 Pistol to be configured for a variety of purposes depending on the requirements of the user, without having to purchase a new pistol.

**Special Information on the Law Enforcement Modification (LEM)**

The HK45 Pistol received with this manual may be fitted with a special enhanced Double-Action Only (DAO) Law Enforcement Modification (LEM) trigger system developed by HK.

The remaining pages of this manual contain information common to all HK45 Pistol models. Many parts of the HK45 are identical for all models, (HK45, HK45T, HK45C and HK45CT) and the term HK45 applies to all models of this pistol unless otherwise specified. Please carefully review this material and the main body of this operator's manual before handling the firearm.

**Law Enforcement Modification (LEM) Description**

The LEM is a series of unique trigger parts created specifically to improve the quality and reduce the weight of the Double-Action Only trigger pull in HK pistols. With these parts installed, the HK45 Pistol can be fired like a standard DAO pistol where every round is fired by simply pulling the trigger fully rearward with the hammer starting at the forward rest position. Generally there is no external decocking or safety levers present or required, though they are available as an option.

Due to the design of the proprietary HK LEM, the weight of the DAO trigger pull has been reduced to 7.5-8.5 pounds when new and is easier to use due to the smoothness of the trigger pull.

**NOTE: An optional 4.5-5.5 pound trigger pull is also available for the HK45 LEM model.**

**Parts Unique to the Law Enforcement Modification**

The unique parts of the Enhanced Trigger System pistol are listed below. Part numbers can be found on the parts lists contained in this manual or by contacting HK Customer Service at (706) 568-1906.

Hammer	Hammer axle
Cocking piece	Hammer strut
Cocking piece spring	Trigger rebound spring
Hammer spring	Catch
Sear	

**Operation of the Law Enforcement Modification**

HK45 Pistols fitted with LEM parts operate like standard variants of the HK45 Pistol. However, the way in which the hammer is cocked is unique. The hammer in the LEM is a two-piece hammer comprised of a cocking piece (not visible with the pistol assembled) and an external (visible) hammer.

The hammer on a conventional Double-Action (DA) or Double Action Only (DAO) pistol is normally drawn to the rear fully cocked and automatically released by the relatively long, heavy rearward pull of the trigger by the operator. To insure reliable primer ignition even under adverse conditions, the hammer spring that drives the hammer forward is relatively strong.

In a conventional DA or DAO pistol the operator is forced to compress the hammer spring by squeezing through the entire DA trigger pull while at the same time trying to hold the sights in alignment for accurate aiming. This can be difficult especially if the operators hand strength is marginal.

To address this dilemma, HK devised the unique LEM. In the LEM, the quality of the trigger pull is improved while at the same time a stronger hammer spring can be employed to improve reliability by increasing the firing pin indent (strike) on the primer. The stronger hammer spring also helps to reduce the slide velocity when firing "hot" ammunition thus improving function and reduce stresses on components of the pistol.

The HK LEM uses the rearward movement of the slide during loading or firing to fully compress the hammer spring instead of relying on the rearward pull of the trigger as in conventional DA or DAO systems.

As the slides moves back to the rear, either by the operator chambering the first round or by the slide recoiling to the rear after ignition of the cartridge, the bottom of the slide engages and pushes down on the hammer and cocking piece.

The hammer strut and hammer strut spring are positioned on the bottom center of the cocking piece. Thus, when the slide passes over the hammer, the hammer strut is pushed downward and the hammer strut spring is compressed. Both the hammer and the cocking piece initially rotate on the hammer axle as the slide moves forward into battery.

The flat spring provides constant pressure on the front of the sear. The cocking piece rotates until the sear lug located on the lower left hand side of the cocking piece engages and is held by the sear. The cocking piece spring ensures that the hammer is always in the up position. The cocking piece spring is needed to ensure that the hammer is always in the “up” position.

When the trigger is pulled, the trigger bar, which is mounted on the right hand side of the trigger, moves forward. The lug on rear of the trigger bar engages and then rotates the hammer forward as well as pivoting the sear actuator latch upwards. The hook located on the bottom of the sear actuator latch engages the roll pin located on the bottom of the sear. The spring tension of the flat spring is overcome and the sear disengages from the cocking piece, allowing the hammer to strike the back of the firing pin.

This unique pre-cocked hammer system combines the advantages of a cocked striker fire component (constant level of trigger pull and short, constant trigger travel from first to last round fired). This ensures an extremely safe pistol with regard to unintended firing.

There are currently two trigger pull weight options available for the LEM system:

- Standard Trigger Pull (approximately 7.5 to 8.5 lbs)
- Light Trigger Pull (approximately 4.5 to 5.5 lbs)

#### **Traditional Double Action Only (DAO)**

If, for any reason, the slide does not recoil to the rear after firing (i.e., failure to fire), the LEM features a traditional DAO trigger pull. In this situation, the trigger is pulled and the trigger bar moves forward engaging and rotating the hammer. In the case of a traditional DAO trigger pull, the hammer strut spring must be compressed by the operator pulling the trigger whereas in the LEM mode the hammer strut spring is compressed by the slide passing over the hammer.

The traditional DAO was incorporated as a back up system that allows the operator to re-engage the trigger (albeit with a heavier trigger pull). If the traditional DAO system were not added to the LEM design, the operator would be forced to rack the slide to the rear to recock the hammer before attempting a follow-up shot.

---

**NOTE: The LEM system will ALWAYS be activated by the slide passing over the hammer. The only time the Traditional DAO system is activated is when the slide does not recoil out of battery. Examples of such a situation include a weak primer strike and/or failure for the cartridge to ignite.**

---

The weight of the trigger pull can be adjusted by an armorer by replacing or exchanging the firing pin block spring and trigger spring.

#### **Special LEM Considerations and the HK Lock-Out Device**

On HK45 Pistols that have LEM parts and HK Lock-Out Device installed (see page 11), the HK Lock-Out Device cannot be engaged (locked) if the Law Enforcement Modification cocking piece is cocked and the hammer spring is compressed. To engage the HK Lock-Out Device on pistols fitted with LEM parts the pressure stored in the hammer spring must first be released. You must CLEAR the pistol (see inside cover), ensure that it is unloaded and safe and dry fire the pistol once to release the cocking piece and the tension on the hammer spring before you can engage the HK Lock-Out Device.

#### **Long Term Pistol Storage**

Anytime the slide is moved fully rearward on the HK45 Pistol fitted with LEM parts the hammer spring is compressed and held in that position until the cocking piece is released by pulling the trigger on the pistol. Therefore for long-term storage (more than 1 year) it is suggested that the pistol first be CLEARED, and made safe, then pointed in a safe direction and dry fired to release pressure on the hammer spring to maintain its life span.

#### **Firing the HK45 equipped with LEM**

All rounds are fired in the LEM DAO mode of fire as they are in conventional DA or DAO handguns. When pulling the trigger rearward you will first feel a relatively long length of free travel (slack) and then a second stage of heavier but consistent pull that actually releases the hammer and fires the pistol. This slack can and should be safely taken up, once the pistol is pointed at the target, to enhance trigger pull consistency.

In addition to providing an improved DAO trigger pull, the LEM also provides a very short trigger reset distance to enhance the speed of multiple or follow-up shots (forward movement of the trigger before firing once again is possible) and allows for double-strike capability to restrike an unfired round without manipulation of the slide, as is required in some conventional DA only or striker fired handguns.

---

**WARNING: Do not place your finger on the trigger or within the trigger guard until you have made a conscious decision to fire the pistol. If you need additional information, please contact your customer service representative at HK Customer Service at (706) 568-1906.**

---

DESCRIPTION

HK45 & HK45C FIRE MODES & CONTROL FUNCTIONS (conversion by HK certified armorer only)	Double Action		Single Action		Control Lever (Left Side)		Control Lever (Right Side)		Control Lever (Manual Safety)		Control Lever (Decocking)		Control Lever (No Decocking)		Caliber Availability		
	DA	SA	DA	SA	DA	SA	DA	SA	DA	SA	DA	SA	DA	SA	DA	SA	
Variant 1	●	●			●		●		●								.45 ACP
Variant 2	●	●				●	●	●									.45 ACP
Variant 3	●	●			●				●								.45 ACP
Variant 4	●	●				●			●								.45 ACP
Variant 5			●	●			●			●							.45 ACP
Variant 6			●		●	●				●							.45 ACP
Variant 7*			●														.45 ACP
No V8																	
Variant 9	●	●			●		●			●							.45 ACP
Variant 10	●	●			●	●			●								.45 ACP

\*Law Enforcement Modification

Figure 2 HK45 & HK45C Trigger (Fire) Modes

Trigger System and Control Level Functions by Variant

The HK45 is available in the following trigger/firing mode configurations (see Fig. 2).

**NOTE: Trigger/firing mode conversion should be made by a HK certified armorer.**

Trigger/Firing Modes by Variant

- 1 DA/SA with "safe" position and control lever (manual safety/decocking lever) on left side of frame
- 2 DA/SA with "safe" position and control lever (manual safety/decocking lever) on right side of frame

Variants 1 and 2 allow the user to carry the pistol in a single-action mode (cocked and locked) with the manual safety engaged. This same pistol, without modification, can be carried in double-action mode, with or without the manual safety engaged.

- 3 DA/SA without "safe" position with control lever (decocking lever) on the left side of frame
- 4 DA/SA without "safe" position with control lever (decocking lever) on the right side of frame

Variants 3 and 4 provide the user with a frame-mounted decocking lever that does not have the "safe" position. This combination only allows the hammer to be lowered from SA position to DA position. It does not provide the "safe" position to prevent the pistol from firing when the trigger is pulled.

- 5 LEM DA-Only with "safe" position and control lever (manual safety) on the left side of frame
- 6 LEM DA-Only with "safe" position and control lever (manual safety) on the right side of frame
- 7 LEM DA-Only without control lever (no safety/decocking lever)

For the LEM DA-Only user, variants 5, 6, and 7 of the HK45 operate as double action only pistols with a bobbed hammer always returning to the DA position (forward) after each shot is fired. To fire each shot, the trigger must be pulled through the smooth DA trigger pull. Variants 5 and 6 have a manual safety lever. No control lever is provided on variant 7.

**NOTE: To be consistent with the variant designations of the HK USP and USP Compact, there is no Variant 8. Variant 8 was a designation reserved for a HK USP government test model.**

- 9 DA/SA with "safe" position and control lever (manual safety) on the left side of frame
- 10 DA/SA with "safe" position and control lever (manual safety) on the right side of frame

Variants 9 and 10 allow the user to carry the pistol in a single-action mode (cocked and locked) with the manual safety engaged. Unlike variants 1 and 2, the control lever can not be used to decock the hammer. These variants are the ideal choice for users who prefer shooting the pistol in single-action (SA) mode with the thumb placed on top of the manual safety. This same pistol, without modification, can be carried in the double-action mode and provides second primer strike ability to single-action shooters.

**WARNING: The control lever on variants 1, 2, 3 and 4 should always be used to decock the cocked hammer. Decocking (lowering) the hammer manually, if done incorrectly, may cause the pistol to fire. Manual decocking of the cocked hammer is not recommended on any HK45 variant, including variants 9 and 10.**

Changing/Converting Variants & Unique Features

Due to this innovative design approach unique to some HK pistols, it is possible to modify an HK45 into any one of the listed variants.

Changing the trigger/firing mode of the pistol is accomplished by installing a different set of component parts. Not only can the control lever function (safety/decocking) be switched from one side of the pistol to the other, it is possible to have a single-action/double-action (SA/DA) version converted to a double action only (LEM DAO) version, or to any other configuration listed.

Optional ambidextrous controls are available.

This unique design allows the HK45 Pistol to be configured for a variety of purposes depending on the requirements of the user, without having to purchase a new pistol.

### Magazine Release

In addition to a wide selection of trigger/firing modes, the HK45 has an extended ambidextrous magazine release lever which is shielded from inadvertent actuation by the design of the trigger guard. It is possible to depress the magazine release lever with the thumb or index finger of the firing hand, in most cases without adjusting the firing grip.

The use of the trigger finger to depress the magazine release is recommended as it allows the firing grip to remain unchanged and removes the trigger finger from the vicinity of the trigger during reloads.

### Magazines

The metal magazine will drop free of the frame when the magazine release is actuated. By using metal magazines in the HK45, grip size is kept to a minimum. Magazines have a series of viewing holes on the back side for counting the cartridges remaining inside. Magazine floor plates can be easily removed without tools during disassembly.

### Slide Release

The ambidextrous extended slide release is positioned to allow easy actuation without adjustment of the grip of the shooting hand.

### Magazine Disconnect

Another feature of the HK45 is the absence of a magazine disconnect device (exceptions being certain special order models).

---

**WARNING: Except on special order models supplied with a magazine disconnect feature, the HK45 will fire if the magazine is removed, a cartridge is in the chamber, and the trigger is pressed. Insure the chamber is always empty during the clearing procedure.**

---

### Recoil Reduction/Buffer System

One of the most important unique design features of the HK45 is the mechanical recoil reduction system. This system is incorporated into the recoil/buffer spring assembly located below the barrel. Not only does this system reduce the felt recoil to the shooter but it also buffers the recoil forces to the components of the pistol, thus greatly extending the life expectancy of the pistol.

This recoil reduction system buffers the impact of the slide on the frame as the barrel unlocks and when the slide travels rearward. Its buffering effect plays a major role in extending the service life of the HK45, especially when considering the punishment inflicted on any pistol when firing powerful +P or +P+ cartridges.

The recoil reduction system employed in the HK45 is insensitive to ammunition types and requires no special adjustment or maintenance. It functions effectively in all models of the pistol.

Two metal inserts are molded into the polymer frame on which the slide recoils. These inserts are not subjected to the full recoil forces of the cartridge due to the buffering action of the recoil reduction system.

The HK45 is an extremely safe firearm, with no less than four safety features, some passive and some active in nature. Simple to field strip and maintain, the pistol is both reliable and trouble-free.

### Barrel with O-ring

The barrel of the HK45 is cold hammer forged for strength and durability, and has HK's unique polygonal bore profile. Polygonal bores increase muzzle velocity, reduce barrel wear and ease cleaning. The high temperature rubber O-ring, located near the muzzle, holds the barrel consistently within the slide during firing and enhances accuracy. Barrels of the HK45 "Tactical" models are extended in length and are threaded for use with screw-on sound/flash suppressors.

### Accessory Rail

Finally, a MIL-STD-1913 "Picatinny" accessory rail is incorporated into the dust cover on the polymer frame. This rail allows accessories such as tactical lights and laser aimers to be mounted quickly and without tools on the HK45 and HK45 Compact without modification to the pistol.

---

**NOTE: Improperly designed or installed accessories may result in damage to the MIL-STD-1913 rail and/or the pistol. Such damage is not covered under the limited lifetime warranty. Be certain to use only HK authorized accessories and follow installation and precautions carefully.**

---

---

**WARNING: Always "clear" the HK45 before installing or removing accessories on the frame mounting rails.**

---



## NOMENCLATURE

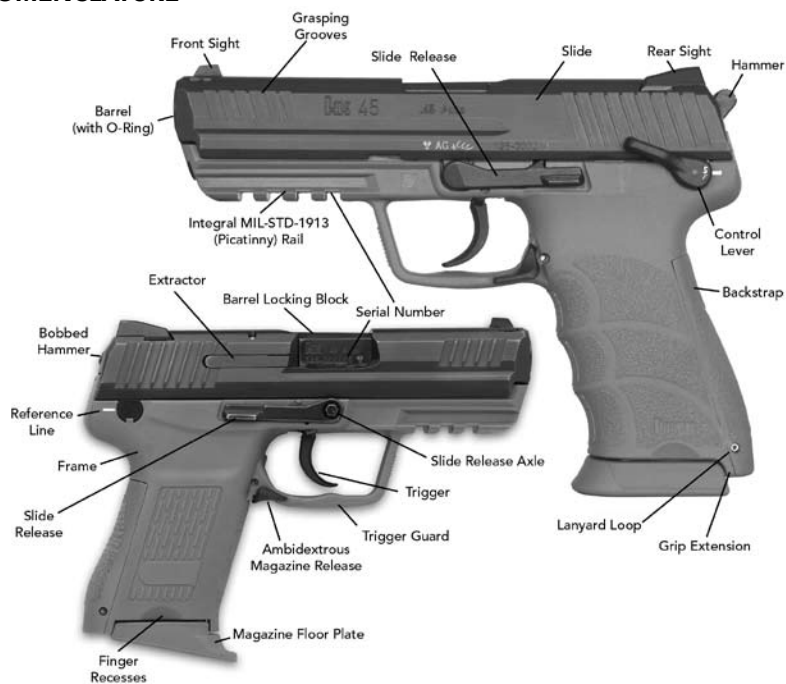

Figure 3  
HK45 Compact (right) and HK45 (left)

**SLIDE**-Machined from a solid profile bar of high carbon steel, finished with the HK Hostile Environment (HE) finish.

**EXTRACTOR**-Large, steel, spring loaded extractor held in by a pin. Doubles as a loaded chamber indicator.

**BARREL LOCKING BLOCK** -Large rectangular area on the top of the barrel provides the surface to lock the barrel into battery within the slide.

**FRONT SIGHT**-Pressed into a dove-tail, adjustable for elevation by replacement with a sight of different height.

**FRAME**-Polymer with metal inserts.

**TRIGGER GUARD**-Large to accommodate gloved hands, flared on the bottom to shield the magazine release.

**TRIGGER**-Located in the trigger guard.

**INTEGRAL MIL-STD-1913 (Picatinny) RAIL**-Used for the mounting of accessories.

**SLIDE RELEASE AXLE**-On the right side of the frame, axle protrudes from the conical hole in slide release to aid in the removal of the slide release.

**LANYARD LOOP**-Used to attach a lanyard.

**REFERENCE LINE**-Marked on each side of the frame to be used with the safety/decocker to indicate the position of the lever.

**AMBIDEXTROUS SLIDE RELEASE**-Locks the slide to the rear when actuated by the shooter and after the last round is fired from the magazine. Also used to release the slide when it is locked back. This is located above the trigger on both sides of the slide.

**HAMMER**-Hits the firing pin to fire the gun. LEM (DAO) pistols have bobbed hammers.

**CONTROL LEVER**-Used to determine the condition of the firing mechanism. (safe/fire/decock). Can be tailored for left or right hand, or ambidextrous, use.

**GRIP EXTENSION**-Extends below the magazine well in the rear of the frame to act as a guide when inserting a magazine. After the magazine is inserted, it gives the butt of the pistol a clean cosmetic appearance. It also is the location for the lanyard loop insert.

**FINGER RECESSES**-Located on either side of the magazine well to allow the magazine to be removed from the pistol in the unlikely event that the magazine does not release from the pistol when the magazine release is depressed.

**AMBIDEXTROUS MAGAZINE RELEASE** -One-piece magazine release located on the trigger guard can be activated from either side of the pistol with firing thumb or index finger.

**SERIAL NUMBER**- Located on a metal insert plate in the bottom of the frame in front of the trigger guard; on the right side of the barrel locking block; and on the left side of the slide.

**GRASPING GROOVES**-Vertical serrations on the slide to aid in pulling the slide rearward during loading, unloading and conducting a "press check".

**BACK STRAP**- Removable grip insert that allows user adjustment of the grip to meet individual grip preferences.

**TRANSPONDER (OPTIONAL)** -Internal (molded-in) electronic data storage device. Permits permanent and changeable data (serial number, rack number, user name, round count, etc.) storage on pistol by operator, armorer.

**BARREL with O-ring**- Tilting one-piece cold hammer forged barrel with O-ring design. Requires no separate barrel bushing. Available with or without threading for sound suppressor attachment.

## SPECIFICATIONS

	HK45	HK45 Tactical	HK45 Compact	HK45 CT*
<b>Caliber</b>	.45 ACP	Same as HK45 unless noted	.45 ACP	Same as HK45C unless noted
<b>Barrel Type</b>	Standard	Threaded	Standard	Threaded
<b>Operating Principle</b>	Short Recoil			
<b>Action Type</b>	Modified Browning Type, Linkless			
<b>Sights</b>	Fixed low profile partridge style, drift adjustable for windage, adjustable for elevation using higher/lower front sights, standard 3-dot or optional Tritium or click adjustable			
<b>Overall Length</b>	204 mm (8.03 in.)	220 mm (8.66 in.)	184 mm (7.24 in.)	200 mm (7.87 in.)
<b>Barrel Length</b>	114 mm (4.47 in.)	130 mm (5.11 in.)	99 mm (3.90 in.)	116 mm (4.57 in.)
<b>Sight Radius</b>	169 mm (6.65 in.)		153 mm (6.04 in.)	
<b>Twist Length</b>	406 mm (15.98 in.)		406 mm (15.98 in.)	
<b>Height (total)</b>	150 mm (5.91 in.)		140 mm (5.51 in.)	
<b>Width of Slide</b>	28.5 mm (1.12 in.)		28.5 mm (1.12 in.)	
<b>Width of Frame</b>	29 mm (1.14 in.)		29 mm (1.14 in.)	
<b>Weight</b>	880 g (30.86 oz)	890 g (31.39 oz)	810 g (28.57 oz)	820 g (28.92 oz)
<b>Weight of Magazine (Empty)</b>	110 grams (3.88 oz)		95 grams (3.35 oz)	
<b>Slide Force (to retract slide)</b>	8 kg (17.6 lbs)		8 kg (17.6 lbs)	
<b>Trigger Pull</b>	Single Action Double Action	approx. 20 Newtons (4.50 pound-force) approx. 51 Newtons (11.46 pound-force)		
<b>Trigger Travel (rest to hammer release)</b>	Single Action Double Action	6 mm (.24 in.) 12 mm (.47 in.)		
<b>Trigger Reach (center of trigger to back of frame)</b>	Single Action Double Action	67.5 mm (2.66 in.) 74.5 mm (2.93 in.)		
<b>Magazine Capacity (does not include cartridge in chamber)</b>	10 Cartridges - standard		8 Cartridges - standard 10 Cartridges - high capacity	

### Safety Features:

1. External Safety Lever (Variant 1,2,5,6,9,10);
2. Decocking Lever (Variant 1,2,3,4);
3. Disconnecter (all variants);
4. Firing Pin Block (all variants);
5. Drop Safety (all variants)
6. Hammer Intercept Notch (all variants)
7. Lock Out Device (all variants);
8. Loaded Chamber Indicator (all variants)

\*Compact Tactical

## Function and Operation

**WARNING: Always clear the pistol before handling it.**

### CLEARING THE PISTOL:

The HK45 is not considered "clear" or safe unless:

1. The control lever is on safe" (if applicable) and;
2. The magazine is removed from the pistol and;
3. The slide is locked to the rear and;
4. The chamber is free of brass or ammunition

### CLEARING PROCEDURE (VARIANTS 1, 2, 5, 6, 9, and 10):

1. Point the muzzle in a safe direction with the operator's finger off the trigger and outside the trigger guard.
2. Place the Control Lever on "S" (Safe).
3. Remove the magazine (if applicable) by engaging the ambidextrous magazine release lever.
4. Rack the Slide to the rear and release three or four time to extract and eject any round left in the chamber.
5. Lock the slide towards the rear. Pull back on the slide until the slide reaches its limit of rear-ward travel. Once the slide is all the way towards the rear, push up on the slide release levers located on the left and right hand sides of the frame.
6. Conduct both a visual and physical inspection of the chamber/magazine well area.

### CLEARING PROCEDURE (VARIANTS 3, 4, and 7):

1. Point the muzzle in a safe direction with the operator's finger off the trigger and outside the trigger guard.
2. Remove the magazine (if applicable) by engaging the ambidextrous magazine release lever.
3. Rack the Slide to the rear and release three or four time to extract and eject any round left in the chamber.
4. Lock the Slide towards the rear. Pull back on the slide until the slide reaches its limit of rear-ward travel. Once the slide is all the way towards the rear, push up on the slide release located on the left hand side of the frame.
5. Conduct both a visual and physical inspection of the chamber/magazine well area.

**NOTE: The LEM system will ALWAYS be activated by the slide passing over the hammer. The only time the traditional DAO system is activated is when the slide does not recoil out of battery. Examples of such a situation include a weak primer strike and/or failure for the cartridge to ignite.**

**Operating Controls & Components**

**WARNING: The HK45 series or pistols incorporate single-action and double-action modes of operation. Anytime the trigger is pulled with control lever (if applicable) in the fire (horizontal) position and a cartridge in the chamber, the pistol will fire from either the hammer down or cocked positions.**

**NOTE: Some variants do not have a control lever.**

Control lever as a Safety Lever - On HK45s with the "safe" position (Variants 1, 2, 5, 6, 9, &10), the front of this lever is fully raised above horizontal so that the "S" on the lever itself aligns with the reference line on the frame (See Figure 4). With this control lever engaged, the release of the hammer is blocked in the single-action mode of fire. In the double-action mode, the hammer will partially cock but will not release to fire the pistol.



Figure 4 Control Lever in "safe" position

To fire the pistol, the front of the control lever is moved down into a horizontal position into the "FIRE" position. In this position, the "F" on the lever aligns with the reference line located on the frame (See Figure 5). With the control lever set on "F", the pistol will fire if the trigger is pulled and a cartridge is present in the chamber.



Figure 5 Control lever in "fire" position

Control lever as a Decocking Lever - On HK45's without the "safe" position (Variants 3 & 4), the front of the control lever cannot be raised above horizontal and the pistol will fire anytime the trigger is pulled with a cartridge in the

chamber. The lever only functions as a decocking lever to lower the cocked hammer into the double-action mode. The cocked hammer is lowered when the decocking lever is fully depressed by the operator (See Figure 6). This lever is spring actuated and springs back up into the horizontal (fire) position when released.

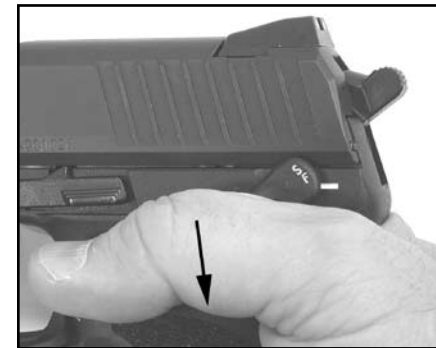

Figure 6 Control lever in "decocking" position

On HK45 variants 1 and 2, the control lever can be placed in the safe, fire, and decocking positions described above.

An HK45 pistol fitted with this control lever can be carried as a single action or double action pistol, with or without the safe position. The control lever also allows the cocked hammer to be decocked when the control lever is fully depressed. (Figure 6). Optional ambidextrous controls levers are also available for the HK45.

**WARNING: The HK45 should not be carried in the single action mode without the control lever in the safe position.**

**Extractor**

The extractor located on the right hand side of the slide acts as a loaded chamber indicator. When a cartridge or case is present in the chamber the red painted surface of the extractor protrudes from the slide presenting a visual and tactile indicator to the operator.

**Slide Release**

This lever is located on both sides of the frame directly above the trigger. This lever is used to lock the slide open, to release the slide when open, and to disassemble the pistol. As a slide stop, it is lifted upward by the magazine follower or the operator's finger as the slide travels rearward during recoil or manual manipulation. The slide release engages in the recess located on the left side of the slide at its midpoint. The slide release is spring actuated and is held down out of engagement with the slide until required. The slide release will automatically hold the slide open when the last shot is fired. As a disassembly lever, the slide release is removed from the left side of the frame when the slide is held partially rearward.

**WARNING: Do not rely on the slide lock to determine if the magazine is empty. Always check visually and physically to ensure that the pistol is not loaded.**

**Magazine Release Lever**

This ambidextrous, spring actuated lever holds the magazine in place within the grip by engaging in the notch located on the front of the magazine housing. Depressing this lever downward with the firing index finger or thumb will allow the magazine, regardless of the number of cartridges inside, to drop free of the frame. The magazine release lever is shielded from accidental actuation by the design of the polymer frame and trigger guard surrounding it.

**Frame**

All sides of the reinforced polymer frame are textured to ensure a firm grip, even with wet hands or under conditions of rapid fire. The trigger guard is extended and grooved to provide a firm grip when using two hands or gloves to fire the pistol. The frame is a one-piece molded component with metal inserts cast into the frame during production. The slide rides on these metal inserts during operation. The frame contains a MIL-STD-1913 (Picatinny) rail for accessory attachment and finger recesses located to the left and right of the magazine well for manual extraction of the magazine, if needed. The serial number of the pistol is engraved in the metal insert incorporated into the front of the frame in front of the trigger guard, on the barrel locking block, and on the left side of the slide.

**Sights and Sight Adjustment**

The sighting system on the HK45 is the proven 3-dot arrangement first made popular on earlier model HK pistols. By aligning all three dots horizontally on the target, with the front sight dot centered between the rear sight dots, the operator can quickly and easily engage the target with a high degree of accuracy (Figure 7).



Figure 7 Rear and front sight aligned

With optional tritium sights installed, precise and rapid target engagements are possible under low light conditions as well. The rear sight can be adjusted for windage by drifting the sight to the left or to the right, depending on the desired shot placement. Bullet impact on target will move in the same direction that the rear sight is moved. Be careful not to damage the slide finish when adjusting the rear sight.

Adjustments for elevation is accomplished by exchanging the front sight with a taller or shorter sight, available from HK. The height of the front sight is indicated on the underside of the sight. The front sight must be removed by using a drift punch or the HK sight pusher. The accessory HK sight pusher can be used to install, remove, and adjust the front and rear sights on all HK45 pistols.

To raise the bullet impact on target, a shorter front sight is installed. To lower the bullet impact on target, a taller front sight is installed. Installing the next taller or shorter front sight will change the point-of-impact approximately 2 inches at 25 meters, depending on the firer and the ammunition used. All HK45's are function fired and zeroed at the factory at 25 meters, point-of-aim, point-of-impact. Your actual zero may vary depending on the ammunition used and/or your style of shooting. Optional click adjustable sights are available with and without self-luminous tritium dots for all HK45 pistols.

**Standard Sights**

Item	Part Number	POI Shift from 6.5mm Sight
Front Sight (6.1mm)	234343	4 inches higher @ 25 meters
Front Sight (6.3mm)	234344	2 inches higher @ 25 meters
Front Sight (6.5mm) Standard	234345	Theoretical POA=POI @ 25 meters
Front Sight (6.7mm)	234346	2 inches lower @ 25 meters
Front Sight (6.9mm)	234347	4 inches lower @ 25 meters

**Extended Sights for use with Suppressor**

Item	Part Number	POI Shift from 10.7mm Sight
Front Sight (10.3mm)	234470	4 inches higher @ 25 meters
Front Sight (10.5mm)	234471	2 inches higher @ 25 meters
Front Sight (10.7mm) Standard	234472	Theoretical POA=POI @ 25 meters
Front Sight (10.9mm)	234473	2 inches lower @ 25 meters
Front Sight (11.1mm)	234474	4 inches lower @ 25 meters

**“Tactical” HK45 Pistol**

The HK45 or HK45 Compact “Tactical” pistols have all of the features found on the standard pistol with the addition of the following:

- high profile front and rear sights
- extended threaded barrel

**High profile front sight (Installed by an HK Certified Armorer)**

The high profile front and rear sight set is mounted on the slide in a dovetail. It allows the operator to obtain a normal sight picture when an optional sound suppressor is mounted.

**Extended barrel and muzzle threads**

The HK cold hammer forged polygonal barrel is engineered for increased accuracy, improve service life and user safety in case of obstructed bore

occurrences. The left hand threads used on the barrel of the HK45 tactical pistol barrels will accept only those accessories designed for the pistol. Locking serrations are provided at the muzzle to prevent loosening of the sound suppressor during use. An optional threaded cap is available to protect the threads during use and rough handling.

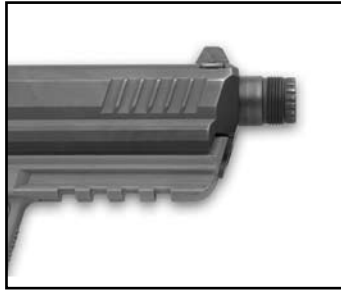

Figure 8  
Threaded Barrel



Figure 9  
HK45CT with suppressor

**CAUTION: The MK23 and USP 45 Tactical sound suppressor cannot be attached to the HK45 or HK45C pistols as they are not "tuned" for proper function on these models! A specially designed sound suppressor is available for the HK45 Tactical pistol.**

### Use of the Sound Suppressor

Remember, the barrel and the suppressor piston has LEFT HAND threads.

1. Install the suppressor on the barrel by turning it counter-clockwise on the barrel threads
2. For maximum suppression, install the Wipe Capsule. Remove the thread protector from the end of the suppressor by loosening it "counter-clockwise". Install the Wipe Capsule with three (3) wipes. These wipes will add additional flash/sound suppression for about 30 rounds. Extra wipes need to be stored in an air tight container in a dark location to preserve their shelf life. The Wipe Capsule has right hand threads. Install and tighten by turning "clockwise".
3. Check suppressor frequently to ensure it is securely attached to the barrel. Remember, LEFT HAND threads.
4. To remove the suppressor, turn it "clockwise" on the barrel threads.

**CAUTION: Use only HK approved suppressors with the HK45 Tactical and HK45 Compact Tactical pistols**

**NOTE: Even though all types of high velocity supersonic (+P) ammunition can be fired, for maximum effectiveness (suppression) only subsonic ball ammunition should be used when a sound suppressor is attached.**

Assembly and disassembly of HK45 and HK45 Compacts with threaded barrels is the same as for other HK45 pistols depicted in this manual.

### Ammunition

**WARNING: HK specifically disclaims any responsibilities for any damage or injury that should occur because of, or as a result of, the use of faulty, remanufactured, or reloaded (hand-loaded) ammunition, or of cartridges other than those for which the pistol was originally chambered.**

---

The HK45 is designed to fire quality, factory loaded ammunition loaded to SAAMI specifications for use specifically in .45 ACP handguns. The following guidelines should be considered when selecting the correct ammunition for your pistol.

1. Make sure the ammunition you have chosen is compatible with your pistol - proper caliber .45 ACP (Automatic Colt Pistol), cartridge, bullet weight, etc. Caliber markings on the HK45 series appear on the left side of the slide and on the barrel locking block, visible through the ejection port on the right side of the slide.

**CAUTION: Do not attempt to fire other types of .45 ammunition in the HK45 such as .45 GAP or .45 Colt, as damage to the pistol may occur. Use only ".45 ACP" ammunition in the HK45.**

---

2. Prior to loading the magazine and chamber, carefully inspect all cartridges for the following abnormalities:
  - Cracked, split, dirty or corroded cases
  - Improperly seated projectiles and/or primers
  - Damaged projectiles
3. Do not attempt to fire a cartridge in which the projectile has been forced back into the case. Upon firing, this condition may result in increased chamber pressure above safe limits.
4. Do not fire ammunition through the pistol that:
  - Is reloaded, remanufactured, or hand loaded
  - Is foreign and/or outdated military surplus
  - Is assembled with corrosive primer and/or propellant
  - Is loaded specifically for use in submachine guns.
  - Is exposed to oil, grease, water, or direct sunlight.

Remove contaminants if possible before use and cool down ammunition exposed to direct sunlight or heat. (Exposure to sources of heat could raise the chamber pressure of the cartridge above safe limits.)

**CAUTION: The use of incorrect or unserviceable ammunition in the pistol could result in damage to the pistol and/or injury to the operator or bystanders.**

---

**NOTE: Currently there are no known .45 ACP ammunition types that are not compatible with the HK45 pistols with the exception of some light, match grade wadcutter loads that provide insufficient recoil impulse to reliably operate the HK45. All HK45 pistols are approved for use with +P and +P+ ammunition. The use of +P and +P+ ammunition does accelerate wear and reduce the service life on the component parts of any pistol including the HK45.**

---

**INSTRUCTIONS FOR USE****Filling the Magazine***Figure 10 Filling the magazine*

1. Hold the magazine in the non-firing hand with the backside of the magazine resting against the palm.
2. Using the firing hand, hold a cartridge between the index finger and thumb with the projectile facing the palm.
3. Press the rim of the cartridge down against the forward edge of the magazine follower or on the top cartridge already in the magazine.
4. Slide the cartridge back into the magazine under the feed lips.
5. Repeat steps 1-4 until the magazine is full. The viewing holes in the back of the magazine allow the operator to confirm the number of cartridges present within the magazine.

**NOTE: Do not attempt to load more than the prescribed number of cartridges into the magazine. Do not alter the shape of the magazine housing, follower, or spring. To do so may cause stoppages or the magazine may not seat properly in the pistol. For easier loading and to increase magazine service life, use an accessory magazine loader.**

**Emptying the Magazine**

Exert pressure with a finger on the base of the cartridge and push each cartridge forward out of the magazine one at a time until the magazine is empty.

**Loading the Pistol**

**WARNING: Forcefully inserting a loaded magazine into the HK45 may cause the pistols slide to close, chambering a cartridge and making the HK45 ready to fire. When inserting a magazine, always be certain that the pistol pointed in a safe direction with your fingers off the trigger and outside the trigger guard. Failure to do so could cause you to unintentionally fire the pistol, resulting in serious injury or death.**

1. Make sure fingers are outside of the trigger guard and the pistol is pointed in a safe direction at all times!
2. On safe - place the control lever in the safe position (if applicable).
3. Insert magazine - insert the magazine firmly into the frame. Tug on the magazine to insure that it is fully seated and engaged.
4. Chamber a cartridge - chamber a cartridge by depressing the slide release or by pulling the slide fully to the rear and releasing it. Do not ride the slide forward!
5. Decock/On Safe - depress the control lever to decock the hammer and/or place the control lever on "safe".
6. Top off- remove the magazine and top it off by inserting one additional cartridge.
7. Reinsert magazine- replace the magazine firmly into the frame. Tug on the magazine to insure that it is fully seated and engaged.

**Firing the Pistol****WARNING:**

- Be sure of the target and what's behind it! A bullet from a pistol can travel as far as a mile. It can easily penetrate wood or plasterboard walls or even a car door.
- Be sure that hands and all parts of your body are kept away from the muzzle of your pistol at all times!
- Always wear eye and ear protection when firing the pistol.

Single-action mode (Hammer cocked)

1. Disengage control lever - disengage the control lever by pressing it downward with the firing thumb so that the "F" on the lever aligns with the reference line located on the frame.
2. Aim - aim at the target.
3. Fire - fire the pistol by pressing the trigger straight to the rear with gradually increasing pressure.
4. Re-engage control lever - re-engage control lever in "safe" position to remain in the single-action mode once firing is completed.

**CAUTION: Single action mode trigger pull is lighter & shorter than double action mode. Keep your finger off the trigger & outside the trigger guard except when firing.**



Firing the Law Enforcement Modification (LEM) Double-action mode (Hammer uncocked)

1. Disengage control lever (if applicable) - disengage the control lever by pressing it downward with the firing thumb so that the "F" on the lever aligns with the reference line located on the frame.
2. Aim - aim at the target.
3. Remove slack – Remove the slack (free movement of the trigger before hammer release) before step 4 below.
4. Fire - fire the pistol by pressing the trigger straight the rear with gradually increasing pressure.
5. Engage control lever – rotate control lever up to place the pistol on safe once firing is completed.

**NOTE: The hammer on HK45 variants 5, 6, & 7 will automatically return to the uncocked position each time the slide returns to its forward position.**

### Unloading the Pistol

To unload the pistol, follow the "Clearing" procedure found on page 19.

If the pistol fails to fire, clear and disassemble it and check for:

1. Obstructions in the chamber bore or frame. Remove obstructions.
2. Bad ammunition. Try new ammunition.
3. Unserviceable magazine. Replace magazine.
4. Fouling or lack of lubrication. Clean and lubricate the pistol in accordance with the instructions contained in this manual.
5. Evidence of severely worn or broken parts.

If your pistol still fails to operate correctly, contact your unit armorer HK Customer Service at (706) 568-1906.

**WARNING: If a cartridge is assembled without powder (a fault of the manufacturing process), the primer alone may have enough power to propel the bullet into the bore. A bullet lodged in the bore may cause damage to the barrel and/or pistol if another cartridge is fired and could cause personal injury or even death. This event is commonly called a "squib load" or "pop and no kick" and is characterized by a reduced report and little or no movement of the slide. An alert operator could notice the occurrence of this event in time to avoid firing the next cartridge.**

### Selection and Use of a Holster

When selecting a carrying holster for the HK45, it is important to consider the following points:

1. The holster must not make contact with or actuate any of the operating controls. This includes the hammer, slide release, magazine release lever, and most importantly the control lever and the trigger. The design of the holster must also not actuate these controls when the pistol is carried in, drawn from, or returned to the holster.
2. The holster should not cause the slide to move (unlock) when the pistol is returned to the holster.
3. Accommodations must be provided in the holster for any accessories that might be present on the pistol.
4. Choose holster designed specifically for the HK45.

### Returning the Pistol to the Holster

The HK45 must be made "safe" (or cleared) prior to returning it to the holster.

The pistol is considered safe to return it to the holster when:

1. All fingers are off of the trigger and outside of the trigger guard and;
2. The pistol is "clear" or;
3. The hammer is in the decocked (down) position or;
4. The control lever (if applicable) is engaged in the safe position when the hammer is cocked.

**WARNING: The pistol must never be returned to the holster unless the above procedures have been completely followed or injury or death could occur.**

### Storage and Transport

1. Store or transport the pistol and its components clean and lubricated.
2. Store and transport the pistol without cartridges in the chamber, magazine, or in the storage container.
3. Store and transport the pistol with the slide forward and the hammer down (uncocked).
4. Clean and lubricate the pistol and it's components at least every twelve (12) months during storage.
5. Store the pistol and it's components in a clean, dry, dust-free environment with regulated temperature controls.
6. Store the pistol and ammunition separately under lock and key.
7. LEM variants stored for more than one year should be stored clear with the weapon dry fired to relieve spring pressure on the internal cocking piece inside the hammer.



**DISASSEMBLY AND REASSEMBLY**

**Disassembly (Field stripping) of the Pistol**

1. Follow Clearing Procedures found on page 19 and "clear" the pistol.
2. Depress the slide release and allow the slide to return forward.
3. Using the firing hand, retract and hold the slide to the rear so that the axle of the slide release is visible through the recess in the left side of the slide (See arrows, Figure 11).
4. With the non-firing hand, completely remove the slide release from the left side of the frame by pressing on it from the right side of the frame (Figure 12), and pulling it out of the left side of the frame.



Figure 11



Figure 12

**CAUTION: Hold the recoil/bullet assembly in place while removing the slide from the frame. If not, this assembly could be released under spring tension and could possibly cause injury to personnel, or become damaged or lost.**

5. Remove the slide with barrel and recoil/buffer spring assembly by sliding it forward off of the frames (see Figure 13).



Figure 13

6. Set the slide down inverted with the sights on a flat surface.
7. Carefully remove the recoil/buffer spring assembly from the barrel and slide by lifting up on the rear of the recoil spring guide rod. The entire assembly can now be lifted out of the slide (see Figure 15) HK45 Pistols have one piece "captive" recoil springs and are removed as a unit.



Figure 14

8. Lift the rear of the barrel near the locking block and withdraw it from the slide (see Figure 15)



Figure 15

9. Rotate the right side slide release clockwise approximately 45 degrees (Figure 16) and separate it from the frame.

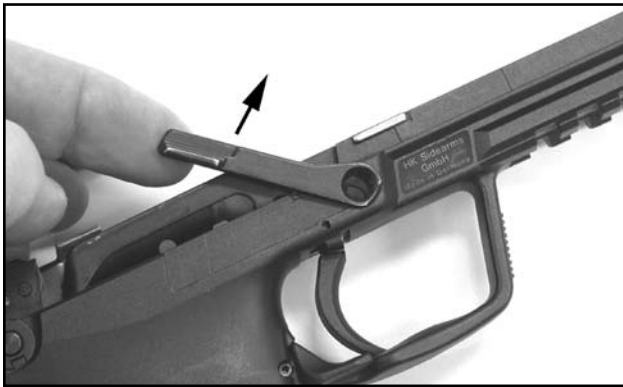

Figure 16

**Removal and Installation of Backstraps** (Interchangeable grip panels)

**Removal**

1. Ensure that the pistol is CLEAR and decocked (see page 19) and the magazine is removed. Dry firing the pistol will relieve any tension on the hammer spring prior to removal of the grip panels.
2. With a (1/8 " or 3 mm) metal punch, carefully tap out the backstrap retaining pin (Figure 17 & 18).



Figure 17



Figure 18

Extract the pin once it is protruding from the frame.

3. When the pin is removed, the grip panel can be slid downward off the frame (Figure 19).

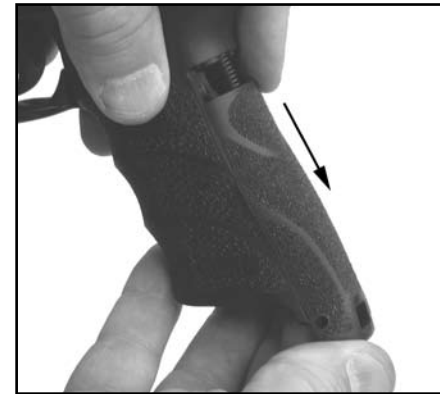

Figure 19

**Installation**

1. Place the replacement grip panel on the back of the frame approximately 1 inch lower than its assembled position and push the grip panel up onto the grip rails (Figure 19). Continue to slide the grip panel upward until it fits flush and there is no gap between the top of the grip panel and frame (Fig 21).



Figure 20

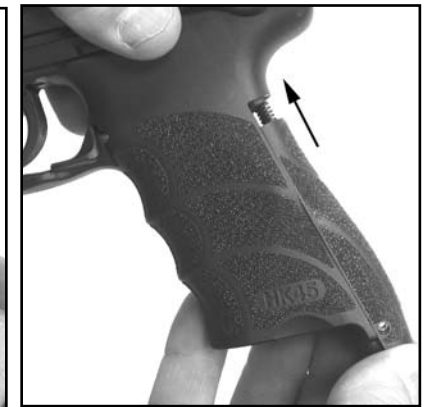

Figure 21

2. At this point, the holes in the grip panel and on the frame will line up. Carefully reinsert the pin and push it through the grip panel and frame using finger pressure.
3. With the pin properly aligned in the grip panel and the frame, carefully tap the pin until it is fully seated and centered in the frame.

**NOTE: Disassembly of the pistol is now complete. Only HK certified armorers should disassemble the pistol further.**



Figure 22  
HK45 fieldstripped into Major Assembly Groups

- 1 Slide
- 2 Barrel
- 3 Recoil Spring Assembly
- 4 Frame
- 5 Magazine
- 6 Slide Release

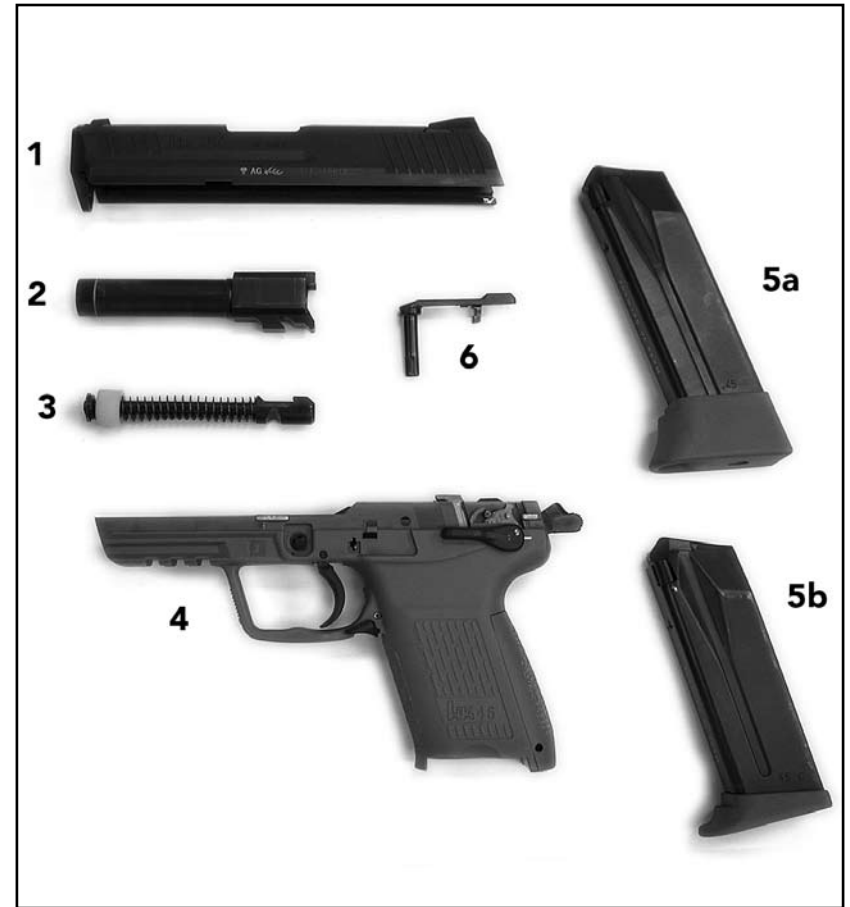

Figure 23  
HK45 Compact fieldstripped into Major Assembly Groups

- 1 Slide
- 2 Barrel
- 3 Recoil Spring Assembly
- 4 Frame
- 5a Magazine (10 round)
- 5b Magazine (8 round)
- 6 Slide Release

**Assembly of the Pistol**

- I. Position the barrel, either the standard barrel, or the threaded tactical barrel in the slide so that the muzzle of the barrel fits in the larger hole at the front

of the slide; the locking block portion of the barrel fits within the ejection port, and the angled locking surfaces of the locking block are visible along the bottom of the slide.



*Figure 24*

*Relationship of recoil spring to barrel locking block inside of slide*

2. Install the recoil/buffer spring assembly into the slide so that the front of the recoil spring guide rod engages in the small hole (ARROW) provided in the front of the slide (Figure 25).



*Figure 25*

3. Compress the recoil spring slightly and align the opposing angled locking surfaces on the rear end of the recoil spring guide rod with those located on the bottom of the barrel locking block.
4. Push the rear of the recoil/buffer spring assembly forward enough so that the recoil spring retainer can be engaged on the shelf provided on the front of the barrel locking block. (Figure 24 shows this relationship).
5. Check the position of the sear axle on the frame. Ensure that it does not protrude from the right side of the frame.
6. Position the right hand slide release at a 45 degree angle and insert onto the mounting surface of the frame. Rotate the right hand slide release downwards (Figure 26).
7. Hold the slide in the non-firing hand with the thumb holding the rear end of the recoil/buffer spring assembly in place on the slide.

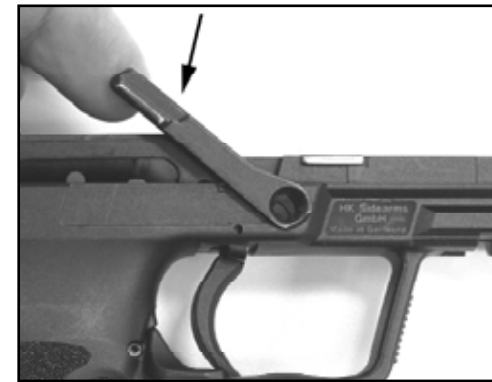

*Figure 26*

8. Hold the frame in the firing hand. Position the rear of the slide above the front edge of the frame.
9. Slowly draw the slide back onto the frame so that the metal inserts in the frame fit into the grooves on the inside of the slide.



*Figure 27*

10. Retract the slide to the point where the recess in the left side of the slide is positioned over the hole where the axle of the slide release will go and hold it there (Figure 27).
11. Insert the slide release from left to right into the frame until it is flush with the side of the frame (Figure 28). Release the slide and allow it to return forward.



Figure 28

**NOTE: Assembly of the pistol is now complete.**

Follow the Function Checks for specific variants on the following pages.

**FUNCTION CHECK**

**FUNCTION CHECK FOR VARIANTS 1 and 2**

1. **CLEAR THE HK45.**
2. Point the muzzle of the HK45 in a safe direction and ensure that the pistol is unloaded.
3. Cycle the slide to the rear and release approximately three to four times to ensure that:
  - The pistol is unloaded
  - The slide travels smoothly back and forth on the frame with no binding or excessive friction
4. Cock the hammer.
5. Decock the hammer using the control lever.
6. Press the trigger to dry fire the pistol in the double action mode.
7. Place the safety "on".
8. Cycle the slide with the safety "on".
9. Check the safety by attempting to dry fire the pistol.
10. Place the safety in the "fire" position.
11. Press the trigger to dry fire the pistol in single action mode.
12. Hold the trigger fully rearward.
13. Cycle the slide; hammer should stay to the rear.
14. Release the trigger and press again to dry fire the pistol in the single action mode.
15. Insert the magazine.
16. Cycle the slide to the rear; magazine follower should lock slide to the rear.
17. Remove the magazine.
18. Release the slide using the slide release.

**The function check is now complete.**

**FUNCTION CHECK FOR VARIANTS 3 and 4**

1. **CLEAR THE HK45.**
2. Point the muzzle of the HK45 in a safe direction and ensure that the pistol is unloaded.
3. Cycle the slide to the rear and release approximately three to four times to ensure that:
  - The pistol is unloaded.
  - The slide travels smoothly back and forth on the frame with no binding or excessive friction.
4. Cock the hammer.
5. Decock the hammer using the control lever.
6. Press the trigger to dry fire the pistol in the double action mode.
7. Cycle the slide; hammer should stay to the rear.
8. Press the trigger to dry fire the pistol in single action mode.
9. Hold the trigger fully rearward.
10. Cycle the slide; hammer should stay to the rear.
11. Release the trigger and press again to dry fire the pistol in the single action mode.
12. Insert the magazine.
13. Cycle the slide to the rear; magazine follower should lock slide to the rear.
14. Remove the magazine.
15. Release the slide using the slide release.
16. Decock using control lever.

**The function check is now complete.**

**FUNCTION CHECK FOR VARIANTS 5 and 6**

1. **CLEAR THE HK45.**
2. Point the muzzle of the HK45 in a safe direction and ensure that the pistol is unloaded.
3. Cycle the slide to the rear and release approximately three to four times to ensure that:
  - The pistol is unloaded
  - The slide travels smoothly back and forth on the frame with no binding or excessive friction
4. Press the trigger to dry fire the pistol in the double action mode.
5. Place the safety "on".
6. Check the safety by attempting to dry fire the pistol.
7. Place the safety in the "fire" position.
8. Press the trigger and hold fully rearward.
9. Cycle the slide; hammer should return forward.
10. Slowly release the trigger, click of disconnect re-engaging should be heard.
11. Insert the magazine.
12. Cycle the slide to the rear; magazine follower should lock slide to the rear.
13. Remove the magazine.
14. Release the slide using the slide release.

**The function check is now complete.**

**FUNCTION CHECK FOR VARIANT 7**

1. **CLEAR THE HK45.**
2. Point the muzzle of the HK45 in a safe direction and ensure that the pistol is unloaded.
3. Rack the slide to the rear and release approximately three to four times to ensure that:
  - The pistol is unloaded.
  - The slide travels smoothly back and forth on the frame with no binding or excessive friction.
4. With the muzzle pointed in a safe direction and the HK45 unloaded, pull the trigger to the rear and hold; the hammer should fall with the lighter LEM trigger pull.
5. With the trigger still held towards the rear, cycle the slide and release the trigger.
6. Press the trigger; again the hammer should fall with the lighter LEM trigger pull. Release the trigger.
7. The hammer should now be fully forward (uncocked). Press the trigger to the rear and hold. The hammer should now fall with the heavier double action only (DAO) trigger pull.
8. With the trigger still held towards the rear, cycle the slide and release the trigger.
9. Press the trigger; again the hammer should fall with the lighter LEM trigger pull. Release the trigger.
10. Insert the magazine.
11. Cycle the slide to the rear; magazine follower should lock slide to the rear.
12. Remove the magazine.
13. Release the slide using the slide release.

**The function check is now complete.**

**FUNCTION CHECK FOR VARIANTS 9 and 10**

1. **CLEAR THE HK45.**
2. Point the muzzle of the HK45 in a safe direction and ensure that the pistol is unloaded.
3. Cycle the slide to the rear and release approximately three to four times to ensure that:
  - The pistol is unloaded
  - The slide travels smoothly back and forth on the frame with no binding or excessive friction
4. Place the safety "on".
5. Check the double action safety by attempting to dry fire. Hammer should move but not release.
6. Place the safety in the "fire" position.
7. Press the trigger to dry fire the pistol and hold fully rearward, hammer should fall.
8. Cycle the slide; hammer should remain to the rear.
9. Slowly release the trigger, click of disconnecter re-engaging should be heard.
10. Place the safety "on".

11. Check the single action safety by attempting to dry fire.
12. Place the safety in the "fire" position.
13. Press the trigger to dry fire the pistol in single action mode; hammer should fall.
14. Press the trigger double action.
15. Insert the magazine.
16. Cycle the slide to the rear; magazine follower should lock slide to the rear.
17. Remove the magazine.
18. Release the slide using the slide release.

**The function check is now complete.**

## MAGAZINE DISASSEMBLY

**CAUTION: Beware of the spring tension exerted by the magazine spring while removing and installing the magazine floor plate. Keep the base of the magazine pointed in a safe direction (away from the face and eyes) at all times during disassembly.**

1. Using a blunt pointed instrument depress the locking detent located in the floor plate and hold it there (see Figure 29).

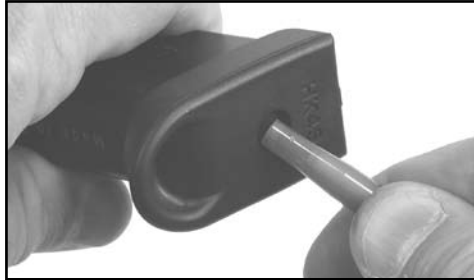

Figure 29

2. Place a portion of either hand over the base of the magazine to control the release of the magazine spring and locking plate.



Figure 30

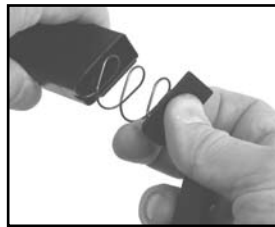

Figure 31

3. Slowly slide the floor plate forward off of the magazine housing (Figure 30) maintaining pressure against the locking plate and spring.
4. Gradually allow the locking plate and magazine spring to expand out of the magazine housing (Figure 31).
5. Remove the locking plate, magazine spring and magazine follower from the magazine housing (Figure 32).

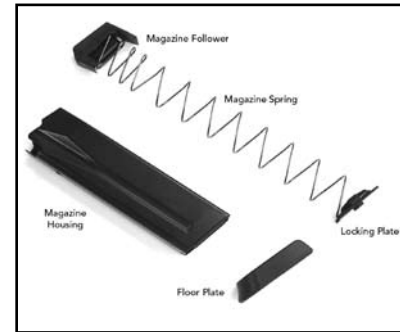

Figure 32



Figure 33 Magazines

## MAGAZINE ASSEMBLY

1. Place the magazine follower onto the magazine spring with the end of the spring positioned on the left of the follower.
2. Insert the follower and magazine spring into the magazine housing as depicted in Figure 34.
3. Push the locking plate down into the magazine housing against the pressure of the magazine spring and hold it there).
4. Push the floor plate over the base of the magazine housing and the locking plate from front to rear. Make sure the floor plate is fully seated on the magazine housing and the locking detent on the locking plate fits within the hole in the floor plate (Figure 34).

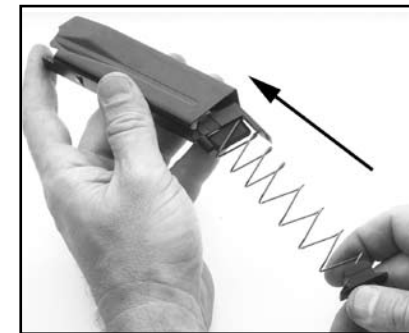

Figure 34

5. Check the magazine for proper assembly by insuring that the follower slides up and down freely within the magazine housing under spring tension. Also check that the magazine follower rises within the magazine housing to be nearly flush against the bottom of the magazine lips.

### Cleaning and Maintenance

**NOTE: The service life and performance of the HK45 is dependent upon the correct handling and proper care by the operator.**

Materials Required - At a minimum, the following materials are suggested to properly clean the HK45.

- Cleaning rod with handle and patch holder
- Nylon toothbrush
- Bronze bristle bore brush (.45 caliber)
- Cleaning patches (.45 caliber)
- Lint-free wiping rag
- Cleaning solvent/lubricant, MIL-L-63460 (CLP) + MIL-L-14107 (LAW)
- Cotton swabs

**CAUTION: Use safety goggles when using solvents and hearing protection if using compressed air.**

Modular Pistol Cleaning Kits (HK article no. 701958 .45 ACP pistol) are available from HK for thorough cleaning of the HK45 and other firearms.

Cleaning Intervals - There are two types of operator cleaning for the HK45. Normal and Major cleaning.

**Normal Cleaning** - Performed after each firing, every 500 rounds (without sound suppressor, 250 rounds with sound suppressor) or every twelve (12) months.

**Major Cleaning** - Often referred to as "detailed cleaning". Performed after the firing of 1000 rounds (500 suppressed) or when the pistol is exposed to, or laden throughout with sand, dust, water (especially salt water), or other visible contaminants or foreign matter.

#### Normal Cleaning

##### Slide

- Gently scrub all internal surfaces of the slide using the nylon toothbrush moistened with solvent.
- Remove all loose fouling from all surfaces of the slide using a rag and cotton swabs.

##### Recoil/buffer spring assembly

- Remove all visible fouling using solvent, a nylon toothbrush, a rag and cotton swabs.

##### Barrel (with locking block)

- Moisten a bronze bore brush with solvent and scrub the bore from chamber to muzzle at least six (6) passes, back and forth.
- Remove the loose fouling from the bore using cleaning patches.

- Gently scrub the exterior of the barrel and locking block with the nylon toothbrush moistened with solvent.
- Remove all loose fouling from the exterior of the barrel and barrel threads (where applicable) using a rag and cotton swabs. Place a drop of lubricant on the barrel O-ring during cleaning and replace the O-ring after 5,000 rounds of suppressor use (20,000 rounds of standard use). Spare O-rings are provided with each new HK45 series pistol. Prolonged use of +P ammunition through the pistol with the sound suppressor attached is not recommended.

#### Frame

- Gently scrub all internal surfaces where carbon fouling is present using the nylon toothbrush moistened with solvent. Concentrate on the area normally covered by the slide.
- Using a rag and cotton swabs, remove all loose fouling from all areas of the frame.

#### Magazine

- Gently scrub the top of the magazine, concentrating on the follower and feed lips, using the nylon toothbrush moistened with solvent.
- Using a rag and cotton swabs, remove all loose fouling from all surfaces of the magazine.

#### Major Cleaning

Major Cleaning is the same as normal cleaning except that:

- The magazine is disassembled for cleaning.
- All parts should be rinsed with, or immersed in solvent and thoroughly scrubbed with a nylon brush. The parts can then be dried using compressed air or with a rag and cotton swabs.

**NOTE: Parts of the HK45 can be immersed in any cleaning solvent that it is safe to put your hands into, including ultrasonic cleaning solution. Painted surfaces of the pistol (i.e. control lever, white index line on frame, and extractor markings) can be removed by using ultrasonic cleaning machines, so care must be taken to protect these painted surfaces.**



**Inspection**

During and after cleaning visually inspect the pistol and its components for any irregularities that may cause problems or stoppages during its operation. Generally, you should keep a watchful eye out for the discrepancies listed below.

Always clear the pistol (Page 19) before conducting your inspection!

- Damaged or missing parts to include the barrel O-ring
- Improper assembly or function
- Absence of free movement, where applicable
- Absence of spring tension, where applicable
- Unaccustomed looseness
- Parts exhibiting signs of cracks, burrs, dents, or obvious signs of damage or stress
- Presence of stops or tactile clicks, where applicable
- General overall cleanliness
- Presence of sufficient lubrication
- Presence of corrosion or degradation of surface finish
- O-ring within sound suppressor coupler
- Missing sight dots on tritium inserts
- Missing or loose sight retaining screws

**CAUTION: This pistol has been developed by capable and experienced engineers. Its present design represents an optimization of a combination of safety, speed of deployment, accuracy, dependability, and durability. Do not attempt to make this pistol "better" by altering any of its components. Altering any part of the pistol or magazine may cause injury or death and will also void any HK warranty on the product.**

**Lubrication**

Metal surfaces of the HK45 are treated with HK's special "Hostile Environment" surface finish protecting the pistol from corrosion and wear. This surface treatment does not completely reduce the friction between moving parts and it is recommended that a lubricant be applied to the pistol to ensure proper functioning. Any type of high-quality, medium weight lubricant (oil) specifically designed for use on firearms will work well on the HK45 Pistol. Do not use lubricants that boast of their ability to penetrate metal as these substances may enter into and deaden primers.

**Where, and How Much****No Lube - Surface is dry and not slippery to the touch**

- Plastic components

**Light Lube - A finger run across the surface yields little or no lube (1 drop)**

- Bore, chamber, and exterior of barrel; including O-ring and muzzle threads if applicable
- All metal parts
- All internal parts in slide and frame
- Magazine spring

- Recoil/buffer spring assembly
- Sights
- Magazine housing
- Barrel O-Ring and threads (if applicable)
- Sound suppressor O-ring and threads (if applicable)

**Medium Lube - A finger run across the surface yields some lube but lube does not run down surface when it is held in a vertical position (2 - 3 drops)**

- Barrel locking block
- Slide rails and grooves
- All operating controls
- Detent plate & detent slide (items 45 & 47, see diagram on pages 53)
- Locking insert and guiding part in frame
- Extractor

**Heavy Lube - Lubrication runs down the surface when it is held in a vertical position (4 - 5 drops)****No heavy lube is required on the HK45.**

Reapply lubricant periodically during firing as it burns off from the heat. Apply lubricant using a clean shaving brush, cotton swabs, patches, or rag. A spray bottle of lubricant also works well when using compressed air to circulate the lubricant into all parts and to remove the excess from the pistol.

The ten inspection criteria as listed in the Inspection section should be checked prior to contacting HK if your pistol fails to function properly. Other common causes of problems that are often overlooked include:

- Fouled or improperly lubricated pistol
- Bad ammunition
- Damaged magazines
- Operator error

If your HK45 still fails to function, contact your unit armorer or HK Customer Service at (706) 568-1906 for assistance.

**NOTE: If after reviewing this manual you still have questions, please contact your unit armorer or Heckler & Koch Customer Service Department.**

**HK LOCK-OUT DEVICE**

HK45 and HK45 Compact pistols are equipped with a patented HK Lock-Out™ device unless otherwise specified by the agency or contract. This component replaces the grip panel in the frame and when engaged locks the handgun's action by blocking any movement of the trigger, the hammer, and the slide. The handgun is locked and can not fire until unlocked. The Lock-Out control plate is accessible through the pistol's magazine well (see Figure 35).



*Figure 35*

*Turning the key clockwise 1/4 turn locks the action, turning it counter-clockwise unlocks the action*

Clear the pistol and dry fire it prior to activating the Lock-Out device. Use the two pronged key supplied with the pistol to lock or unlock the pistol as desired. When the holes on the Lock-Out Device are horizontally positioned the pistol is locked and can not be fired (see Figure 36).



*Figure 36  
Locked position*

When the holes on the Lock-Out Device are vertically positioned the pistol is unlocked and can be fired (see Figure 37).



*Figure 37  
Unlocked/fire position*

**WARNING: The HK Lock-Out Device is not a substitute for safe gun handling practices. Never point the muzzle of the pistol in an unsafe direction (at yourself or others). When the Lock-Out Device is placed in the locked position the slide is locked in the closed position and can not be moved! Forcing the slide rearward while the gun is in this locked position will damage the pistol.**

For more information contact HK Customer Service at 706) 568-1906.

**Accessories**

Sets of integral MIL STD 1913 (Picatinny) rails are molded into the polymer frame dust cover of the HK45 and HK45C for mounting lights, laser aimers, and other accessories, allowing a wide variety of lights, laser aimers, and accessories to be added by simply sliding them onto the open rail system.



*Figure 38*

*Mounting accessory light on HK45 Picatinny rail*

Follow the instructions of the manufacturer for installing, operating, and removing accessories from the mounting rails. Always ensure the HK45 is "clear" and unloaded before installing or removing accessories. Slide the accessory onto the rails until it locks into the locking slot located on the bottom of frame.

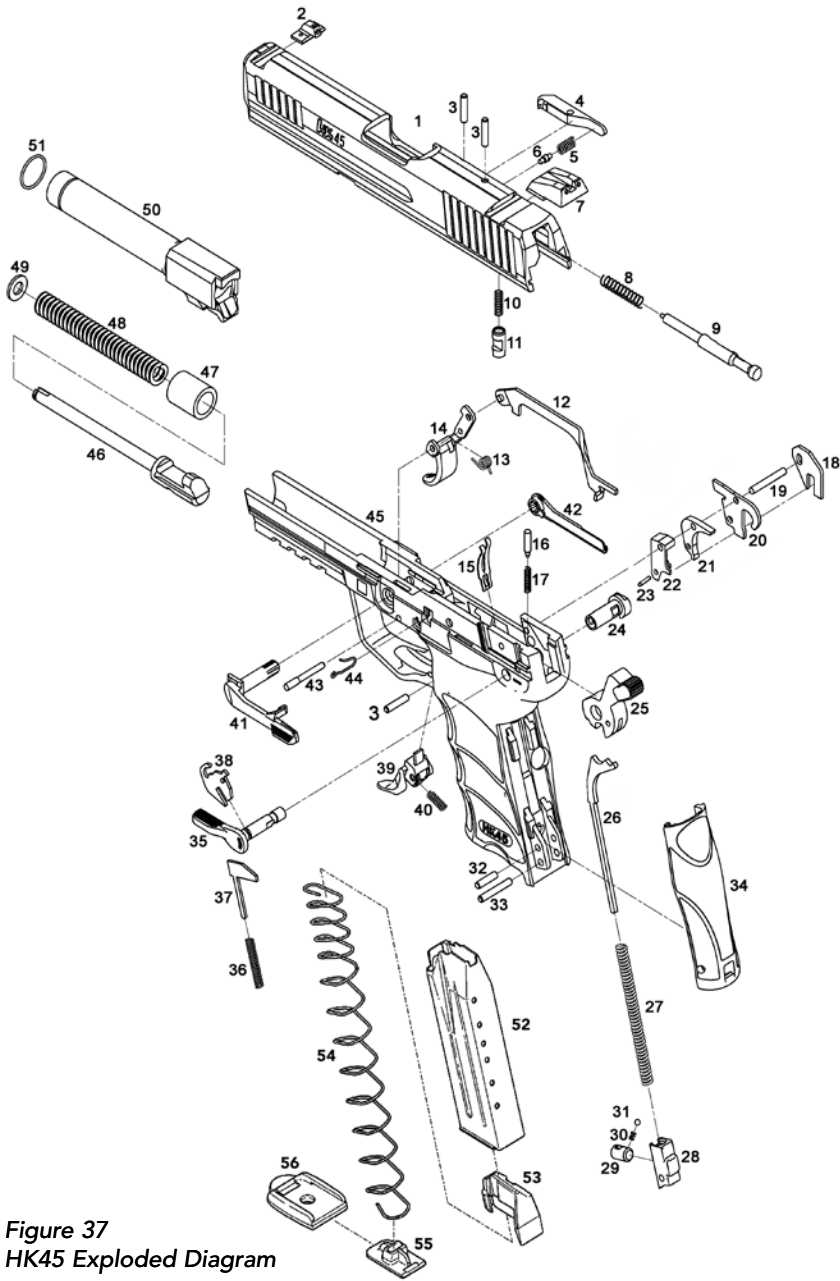

Figure 37  
HK45 Exploded Diagram

HK45 Parts List

	Slide, complete (1-11) . . . . .	227709
1	Slide . . . . .	233313
2	Front sight, complete (5,9 mm) . . . . .	227711
2.1	Front sight, complete (6,1 mm) . . . . .	234327
2.2	Front sight, complete (6,3 mm) . . . . .	234328
2.3	Front sight, complete (6,5 mm) . . . . .	234329
2.4	Front sight, complete (6,7 mm) . . . . .	234386
2.5	Front sight, complete (6,9 mm) . . . . .	234387
3	Roll pin (3x) . . . . .	988891
4	Extractor . . . . .	218316
5	Extractor spring . . . . .	218315
6	Rubber plug . . . . .	209294
7	Rear sight, complete . . . . .	234323
8	Firing pin spring . . . . .	214190
9	Firing pin . . . . .	233370
10	Firing pin block spring . . . . .	209296
11	Firing pin block . . . . .	209313
	Frame, complete (12-45) . . . . .	234660
12	Trigger bar . . . . .	215924
13	Trigger rebound spring . . . . .	214164
14	Trigger . . . . .	234458
15	Flat spring . . . . .	215691
16	Trigger bar bolt . . . . .	214165
17	Trigger bar spring . . . . .	214166
18	Disconnecter . . . . .	214840
19	Sear axle . . . . .	214101
20	Catch . . . . .	214817
21	Sear actuator latch . . . . .	219442
	Sear, complete (22/23) . . . . .	214179
22	Sear (incomplete) . . . . .	214180
23	Roll pin . . . . .	982785
24	Hammer axle . . . . .	214774
25	Hammer . . . . .	218570
26	Hammer strut . . . . .	214819
27	Hammer spring . . . . .	215694
	Gunlock, complete (28-31) . . . . .	234664
28	Gunlock . . . . .	234665
29	Safety . . . . .	207191
30	Compression spring . . . . .	985934
31	Ball . . . . .	929134
32	Cylindrical pin . . . . .	970074
33	Clamping pin . . . . .	978170
34	Back strap "S" . . . . .	234662
	Back strap "M" . . . . .	234663
35	Safety lever . . . . .	234339
36	Compression spring . . . . .	214104
37	Slide plate . . . . .	214105
38	Detent plate . . . . .	234465
39	Magazine release . . . . .	234296
40	Magazine release spring . . . . .	215929
41	Slide release . . . . .	234337
42	Slide release, right . . . . .	209268
43	Trigger axle . . . . .	214154
44	Shaped spring . . . . .	214171
45	Frame . . . . .	234661
	Recoil spring guide rod, complete (46-49) . . . . .	233314
46	Recoil spring guide rod . . . . .	215828
47	Sleeve . . . . .	233371
48	Recoil spring . . . . .	234250
49	Recoil spring retainer . . . . .	215831
50	Barrel . . . . .	233315
51	O-ring . . . . .	986429
52	Magazine housing (10 round) . . . . .	233317
53	Follower . . . . .	215938
54	Magazine spring . . . . .	234155
55	Locking plate/insert . . . . .	215937
56	Magazine floorplate . . . . .	227523
	Magazine (10 round) complete, not illustrated . . . . .	227710

NOTE: Not all parts and components for all HK45 variants depicted or listed

HK45 Compact Parts List

1	Slide, complete (1-11)	234017
2	Slide	234018
2	Front sight, complete (5,9 mm)	227711
2.1	Front sight, complete (6,1 mm)	234327
2.2	Front sight, complete (6,3 mm)	234328
2.3	Front sight, complete (6,5 mm, standard)	234329
2.4	Front sight, complete (6,7 mm)	234386
2.5	Front sight, complete (6,9 mm)	234387
3	Roll pin (3x)	988891
4	Extractor	218316
5	Extractor spring	218315
6	Rubber plug	209294
7	Rear sight, complete	234323
8	Firing pin spring	215822
9	Firing pin	215928
10	Firing pin block spring	209296
11	Firing pin block	209313
12	Frame, complete (12-45)	234660
13	Trigger bar	215924
14	Trigger rebound spring	214164
15	Trigger	215816
16	Flat spring	215691
17	Trigger bar bolt	214165
18	Trigger bar spring	214166
19	Disconnect	214840
20	Sear axle	214101
21	Catch	214817
22	Sear actuator	219442
23	Sear, complete (22/23)	214179
24	Sear, incomplete	214180
25	Roll pin	982785
26	Hammer axle	214774
27	Hammer	218570
28	Hammer strut	234459
29	Hammer spring	234479
30	Gunlock, complete (28-31)	234664
31	Gunlock	234665
32	Safety	207191
33	Compression spring	985934
34	Ball	929134
35	Cylindrical pin	970074
36	Clamping pin	978170
37	Back strap "S"	234021
38	Back strap "M"	234022
39	Safety lever	234339
40	Compression spring	214104
41	Slide plate	214105
42	Detent plate	234465
43	Magazine release	234270
44	Magazine release spring	215929
45	Magazine, complete (8 rounds)	234269
46	Slide release	234337
47	Slide release, right	209268
48	Trigger axle	214154
49	Shaped spring	214171
50	Frame	234016
51	Frame, complete (12-45)	234015
52	Recoil spring guide rod	215931
53	Sleeve	215932
54	Recoil spring	215830
55	Recoil spring retainer	215831
56	Recoil spring guide rod, compl.(46-49)	215930
57	Barrel	234019
58	O-ring	986429
59	Magazine, 8 rounds, complete (not illustrated)	234269
60	Magazine housing (8 round)	215934
61	Follower	215938
62	Magazine spring (8 round)	214212
63	Locking plate/insert	215937
64	Magazine floorplate (8 round)	234150

Magazine, 10 rounds, complete (not illustrated)	234268
Magazine housing (10 rounds)	233317
Follower	215938
Magazine spring (10 rounds)	234155
Locking plate/insert	215937
Magazine floorplate (10 rounds)	234151

NOTE: Not all parts and components for all HK45 Compact variants depicted or listed

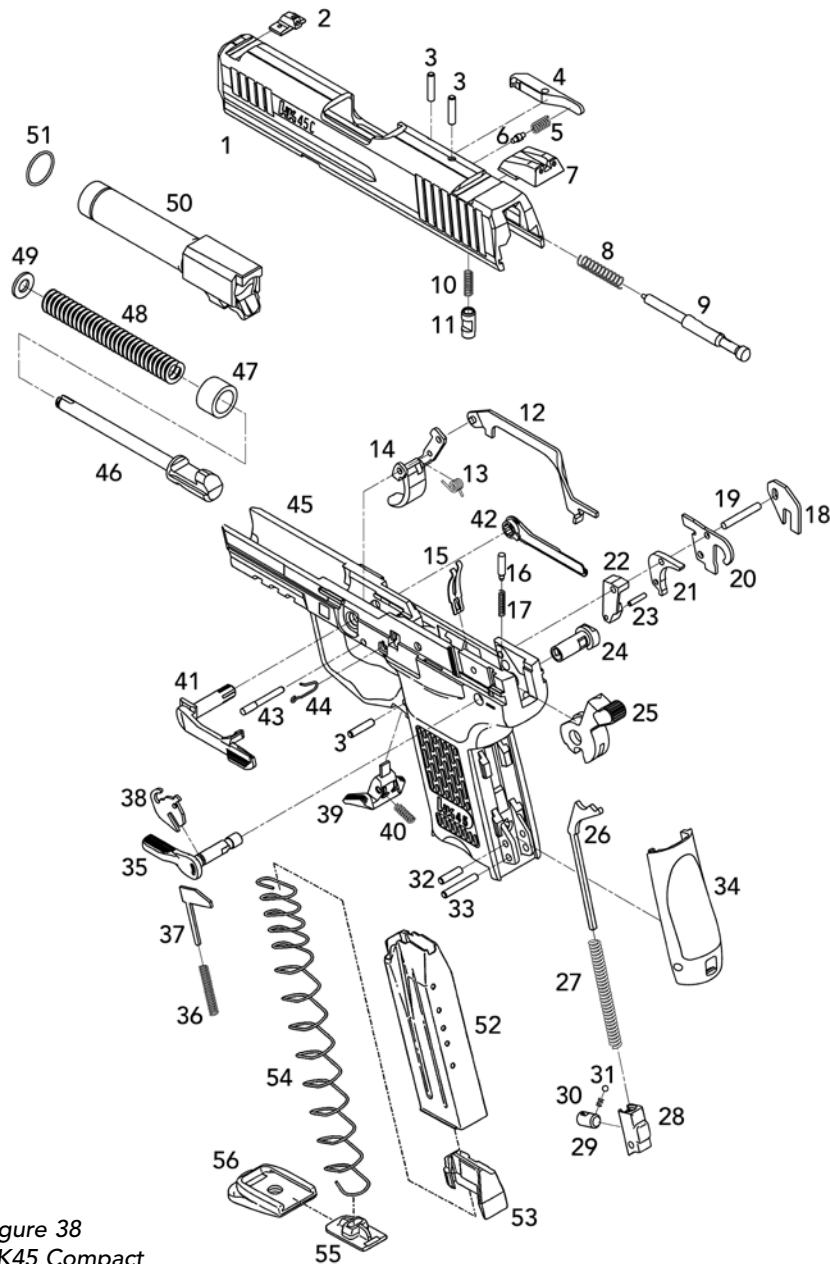

Figure 38  
HK45 Compact  
Exploded Diagram







---

**HECKLER & KOCH**  
5675 Transport Boulevard  
Columbus, Georgia 31907  
United States of America  
Tel: (706) 568-1906  
Fax: (706) 568-9151  
American Website: [www.hk-usa.com](http://www.hk-usa.com)

**HECKLER & KOCH**  
D-78722 Oberndorf/Neckar  
Postfach 1329  
Germany  
Tel: 011-49-7423/79-0  
Fax: 011-49-7423/2280  
Global Website: [www.heckler-koch.com](http://www.heckler-koch.com)