A close-up photograph of a water polo player in a blue cap and jersey, holding a yellow and white water polo ball. The player is in the water, with splashing water visible. The background is a bright blue pool. The text is overlaid on the top left of the image.

Water Polo for Players & Teachers of Aquatics

WATER POLO FOR PLAYERS & TEACHERS OF AQUATICS

Pete Snyder, Ph. D.

Professor, Fullerton College, Fullerton, California

Layout Design: Mary Jo Reutter

©2008. All rights reserved.

This manual may not, in whole or in part, be copied, photocopied, reproduced, translated, or converted to any electronic or machine readable form without prior written consent of the author. It is Web-published by the LA84 Foundation under a license from the author.

Printed in the USA

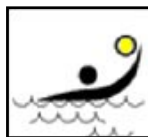

Acknowledgements

This book would not have been completed and had its particular attention to detail without the help and support of the following individuals.

First I'd like to thank Mr. Lundy Smith, an English teacher and head Girls Water Polo Coach at Phillips Exeter Academy in Exeter, New Hampshire. Lundy was most helpful in points of emphasis and grammatical structure in the book.

I'd also like to thank Roger Nekton from Phillips Exeter. Roger just retired as head boys water polo and swimming coach after a long and very distinguished career of over thirty years at the Academy. Roger provided valuable technical input as well as encouragement regarding the need for written material in the sport of water polo.

As a picture is worth a thousand words, I'm very indebted to Mrs. Chris Kittredge of CMK Enterprises (www.tudorgraphics.com). Chris was able to capture some of the more difficult team aspects of the game only because of her dedication, extensive knowledge of over twenty years with the sport and her brilliance as a photographer.

Matt Brown (www.mattbrownphoto.com) is another photographer who exhibited a tremendous amount of alacrity in his water polo photos. Matt has been in Orange County for two decades and has a vast repertoire and portfolio of sporting photos.

Many great photos throughout the book were made available through the generosity of Joan Gould (www.waterpoloplanet.com). Joan's tireless efforts at taking and posting photos have helped spread water polo throughout the country and the world.

For technical expertise I am indebted to Phil Thurman (www.sports.fullcoll.edu), Sports Information Director at Fullerton College. Phil's willingness to answer the mundane and often remedial computer and technical questions was extremely valuable. Phil also created the cover for the book.

Many thanks also to my wife, Becky Snyder, President of ABC-CLIO (www.ABC-CLIO.com), an award winning publishing company of history material for the education market. Becky passed on bits of her expertise regarding the publishing industry and the market (or lack thereof) for water polo.

And, last and most importantly, my children Grady and Kendall, both of whom were generous enough to allow me to publish their high school and college water polo photos as well as field numerous innocuous questions and comments about the sport we know and love.

Sincerely,
Pete Snyder, Ph.D.

Table of Contents

Chapter 1: History and Tradition	7
Comparisons With Other Sports	7
Evolution and Rules.....	7
Women’s Water Polo History.....	11
Notable Historical Changes in the Sport.....	13
References.....	16
Chapter 2: Physiological, Psychological, and Medical Aspects of Water Polo	18
Physiology	18
Psychology.....	19
Biomechanics.....	20
Upper Body	21
Lower Body	24
Nutrition.....	26
Injuries	26
Gender Differences.....	28
References.....	29
Chapter 3: Basic Swimming Skills as Applied to Water Polo	33
Front Crawl.....	34
Back Crawl	35
Breaststroke.....	36
Side Stroke.....	37
Sample Swimming Conditioning Drills and Their Applicability to Water Polo	38
Sample Ball Handling Conditioning Drills	39
Eggbeater Leg Motion and Sample Drills	40
References.....	41
Chapter 4: Individual Offensive Ball Handling Skills	42
Dribbling	42
Ball Pickup.....	43
Baseball Pass and Pass Reception.....	47

Layout Pass When Closely Guarded.....	49
Basic Passing Drills, Guarded and Unguarded.....	51
References.....	53
Chapter 5: Individual Offensive Skills –Team Offense	54
Where to Shoot, Targets on the Goal	54
Basic Shooting Drills	55
Two Meter Offense Responsibilities, Shots	59
Half Court Offense Positions, Names, and Numbers	63
Two Basic Offensive Patterns	64
Drive Style.....	65
Pick Style	66
References.....	67
Chapter 6: Individual Defensive Skills – Team Defense	68
Body Position – Player-to-player Pressure Defense	68
Front Court Pressing Defense	70
Pressuring the Ball	72
Guarding the Two-Meter Player	73
Field Shot Blocking	75
Sloughing and Crashing	76
Other Individual Defensive Moves	78
References.....	84
Chapter 7: Basic Water Polo Rules	85
Field of Play	85
Classification of Fouls	86
Ordinary.....	86
Ejection.....	88
Penalty.....	89
Major	90
Referee Signals	91
Rules Questions and Resources	91
References.....	92
Chapter 8: Six on Five Offense, Five on Six Defense.....	94
Quick Shot on Goal	94
4-2 Offensive Configuration	95

Basic Passes to the Posts.....	95
Shots From 1 & 6 Positions.....	98
Three-Three Offensive Configuration	99
Five on Six (Player down) Defense	100
References.....	105
Chapter 9: The Goalie – “le gardien de but”	107
History.....	107
Psychological Traits of Goalies	108
Physical Makeup	111
Goalie Fundamentals	113
Eggbeater Kick, Sculling	113
Body Position- Ready Position	114
Hand Positions	115
Positioning	116
During and After the Save	117
Five Meters	121
Lobs.....	122
Final Thoughts	124
References.....	125
Chapter 10: Fast Break or Counterattack Offense and Defense ..	126
Offensive Transition	126
Defense to Offense positioning	126
Initial Break, Releases	126
Numerical Advantages on the Fast Break	129
One on the Goalie	129
Two Offensive Players on One Defensive Player	131
Three Offensive Players on Two Defenders	132
Four Offensive Players on Three Defenders	132
Additional Thoughts Regarding Offense on the Fast Break	135
Counterattack Defense	136
References.....	137
Appendix 1, Men’s Olympic Water Polo Results	138
Appendix 2, Women’s Olympic Water Polo Results	139
Appendix 3, Stretching	140
Appendix 4, Specific Strength Training	145

History and Tradition

Comparisons

Water polo is a game that captures a number of different facets of some of the more popular sports in world culture. Much of what is involved with water polo, as can be seen in this chapter, is comparable to the sports of hockey, basketball, and soccer.

To visualize the sport, combine the dual skills of swimming and ball handling; and, add to it the physicality and power play opportunities of hockey, the fast break opportunities and passing of basketball with the pivot (center) position, and the penetration and goalie play of soccer. Water polo players typically swim over 1.5 miles in a game.

Physiologists have ranked the sport as one of the most strenuous activities of all. In 1991, water polo was quoted as the “Best overall sport in terms of physiological demands placed on the athlete,” by a panel of physiology experts from all over the U.S. (Ludovise, C1,6) The exercise of swimming itself utilizes many sets of muscles. Add to swimming the head-high ball handling skills of passing and shooting, the leg support generated through the eggbeater kick and the physical contact between players, and you have a thoroughly arduous sport.

Evolution and Rules

The game has as its roots the aquatic festivals, called galas, which were held in the English resort towns in the mid-1800’s. In order to attract more spectators, the fes-



Fig. 1-1. A fantasy version of early water polo

tivals included a rugby-style game which involved a submersible ball. The name is the only connection between water polo and the horse version, as polo was derived from the East Indies word “pulu” which means ball. The first “pulu” ball was made of Indian rubber. (Smith, 2) There was, however, a variety of the game where the players played on barrels with sticks. (Fig. 1-1)

In the 1860’s, there was a version of “football in the water” which was developed but not codified by the London Swimming Association. The first game of Water Football was played at the Crystal Palace in London in 1874. In 1876, the first rules were written by William Wilson in Aberdeen, Scotland at the Bon Accord Club. At this time, Wilson deemed the sport “Aquatic Football.”

True to its early descriptions, the game was similar to a scrum in rugby and points were scored by physically advancing the ball over or underwater and placing it on a goal. The ball, originally a pig’s bladder was later made of rubber, and malleable enough to even fit in a players’ swim suit. (Fig. 1-2) Two hands were allowed by all players. (Fig. 1-3)(Worldwide aquatics, 1)



J. HARE

Fig 1-2. Second official National Championships, Madison Square Garden, 1899

Ten years later, in 1886, the Association Swimming Club of Glasgow formed a committee to standardize the rules. Within a year, goalposts were used to “shoot” at, one hand at a time was allowed to touch ball, and players were not allowed to use the bottom of the pool. (Lambert and Gaughran, 4)

CHAPTER 1
History and Tradition

In 1888, the London water polo league met and revised the rules to take advantage of changes in the swimming strokes (Trudgeon) and thus speed up the game. The goal was made larger (3 feet by 10 feet) and a point could be scored by throwing the ball into this area. The composition of the ball was changed to leather and the seven field players could only use one hand, and could only be tackled if they were in possession of the ball. Passing became a much more integral part of the game. (Worldwide aquatics, 1)



HARPER'S WEEKLY

Fig 1-3. Water polo at the Manhattan Athletic Club, February 28, 1891

In the same year John Robinson, an Englishman, introduced the game in the United States at the Boston Athletic Club. The first men's competitions in the sport were between clubs, with the Knickerbocker Club of New York taking the first National Championship in 1898. The New York Athletic Club started water polo in the fall of 1890. One of the first recorded series of matches was between the Boston Athletic Association (Club) and Sydenham of Providence, in 1890. (Boston Athletic Association Report, 1890)

For decades the U.S. game used the early physical style of play, even to the extent of requiring the 1904 Olympic Games in Saint Louis be played by these 1876 vintage rules. The result was that no European teams participated in the 1904 Games and the U.S. “won” gold, silver, and bronze medals.

CHAPTER 1
History and Tradition

The dimensions of the pool had a large impact on the early tenor of the game. With few large pools, water polo had a very rough style because there wasn't much room for the fourteen players and thus minimal swimming space available. With the addition of new facilities, the European game changed. The Europeans took a dominant role in the sport most especially with the adoption of FINA, the Federation International de Natacion Amateur, as the uniform rules in 1911. The U.S. schools and Clubs still "clung" to the older style wrestling "softball water polo" rules for years to come.

As an Olympic sport, men's water polo was added to the program in 1900 at the Paris Games. Water polo, along with soccer, are thus the oldest team sports in the Games. (Fig. 1-4)

Water polo has long been affiliated with schools. Cambridge University in England fielded its men's water polo team in 1882 and started the oldest collegiate rivalry in the sport with Oxford in 1891. The U.S. universities started water polo as early as 1897, when the University of Pennsylvania began its program. (Lambert and Gaughran, 5,11) The sport was unfortunately dropped as men's varsity status from the Ivy League in 1937. Most recently, Prince William was a member of the University of St. Andrews water polo team and prior to that played at Eton. (Prince of Wales, 1)

Men's water polo was revived on the West Coast in the late 1920's and early 30's as newer Colleges and universities were the beneficiaries of more modern pools which created the opportunity to play the sport using a more mobile swimming style.
– Fullerton established the first community college team in 1933.

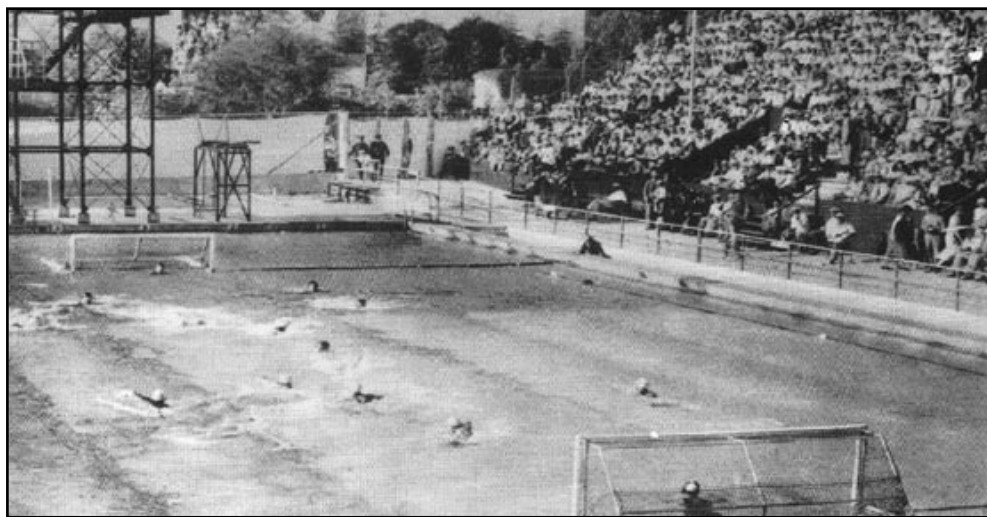

U.S. Olympic Committee, www.usolympicteam.com

Fig. 1-4. Olympiad X, 1932, Los Angeles Coliseum Pool

As part of its resurrection, the N.C.A.A. devised a “new” set of water polo rules which were similar to basketball. These were played throughout the 1950’s and 1960’s and required that field players be allowed a limited number of fouls (five) of any variety per game. Once again, the Americans, during their college season, played different rules than the rest of the world.

The first N.C.A.A. Men’s Water Polo Championship was contested in 1969. Gradually, there were incremental changes until finally, in 1976, the colleges adopted the F.I.N.A. style of rules allowing unlimited “normal” fouls. There are currently fifty Colleges and Universities in the U.S. which sponsor Men’s varsity intercollegiate water polo. (N.C.A.A. website)

Fact: Seven California Colleges have won all 38 Men’s N.C.A.A. Championships – no college from another state has won as of yet.

Women's Water Polo History

As in many sports, women’s water polo remained in relative obscurity through the early 1900’s. Women’s intramural varieties of water polo were played in the early 1900’s (Cambridge website). One of the earliest recorded competitions took place in 1926, when the Amateur Athletic Union (A.A.U.) Nationals were won by the Los Angeles Athletic Club. The National Championships were established on a permanent basis between 1961-1962, largely due to the efforts of Rose Mary Dawson, coach of the Ann Arbor Club in Michigan. (2004 Hall of Fame, 19)



Fig. 1-5. Women's Outdoor National Club Championships, 1926-1977 (A.A.U.) ; 1978-present United States Water Polo, Inc. (Smith, 429, HickokSports.com)

- | | |
|------|--|
| 1926 | Los Angeles Athletic Club, Los Angeles, California |
| 1931 | Pacific Coast Club, Long Beach, California |
| 1962 | Ann Arbor Swim Club, Ann Arbor, Michigan |

CHAPTER 1

History and Tradition

1964	Montana Swim Club, Miles City, Montana
1965-1967	Northern Virginia Aquatic Club, Arlington, Virginia
1968	Foothill Farms Swim Club, Sacramento, California
1969	Northern Virginia Aquatic Club, Arlington, Virginia
1970	Sheridan Swim Club, Quincy, Illinois
1972-1973	Coral Gables Swim Association, Coral Gables, Florida
1974	North Dade Swim Club, Miami, Florida
1975	North Miami Beach Club, Miami, Florida
1976	Fullerton Area Swim Team, Fullerton, California
1980-1981	Industry Hills Aquatic Club, Industry Hills, California
1982	Slippery Rock Swim Club, Slippery Rock, Pennsylvania
1983	Seal Beach Swim Club, Seal Beach, California
1984	Industry Hills Aquatic Club, Industry Hills, California
1985	Industry Hills Aquatic Club, Industry Hills, California
1986	Santa Ana Water Polo Club, Santa Ana, California
1987	Beach Aquatics, Long Beach, California
1988	Hawaiian Water Polo Club, Honolulu, Hawaii
1989	Beach Aquatics, Long Beach, California
1990	Beach Aquatics, Long Beach, California
1991	California Water Polo Club, Berkeley, California
1992	Beach Aquatics, Long Beach, California
1993	Sunset Aquatics, San Diego, California
1994	Modesto/Stanslaus Water Polo, Modesto, California
1995	Sunset Aquatics, San Diego, California
1996	Sunset Aquatics, San Diego, California
1997	Modesto/Stanslaus Water Polo, Modesto, California
1998	California Water Polo Club, Berkeley, California
1999	Golden Bear Water Polo Club, Berkeley, California
2000	Nor Cal Aquatics, Concord, California
2001	O.R.C.A., Villa Park, California
2002	San Diego State "A", San Diego, California
2003	Stanford Water Polo, Palo Alto, California
2004	Devil Mountain, Walnut Creek, California
2005	San Diego Shores, San Diego, California
2006	Southern Cal, Los Angeles, California

Official recognition of girls water polo as sanctioned high school Championship sport took place in California in 1998. The first women's N.C.A.A. Championship



Fig. 1-6. Women's Action, Sydney Olympic Games 2000

Tournament was contested in 2001. There are currently sixty one Colleges and Universities in the U.S. which sponsor women's water polo as a varsity intercollegiate sport. (NCAA website)

Women's Water Polo became an Olympic sport in 2000 at the Sydney Games. (Fig. 1-6) The addition of the women's competition to the Olympic Program was due in large measure to daily protests that were staged by the Australian Women's National Team during the 1999 International Olympic Committee meeting in Melbourne. (Wigo, "Speaking Out", 7)

Notable Evolutionary Changes in the Sport

- Ball – Its composition changed from leather to rubber exterior with a cotton inner lining due to James R. Smith's invention and collaboration with AMF Voit in 1936. Folklore has it that the color was changed from red to current "yellow" in 1948 because the fabric for the rubber ball was made from "Mae West" life jackets. Another reason given for the new "optic yellow" look was to improve visibility. The rubber ball finally was used in the 1956 Melbourne Olympics. In the 1980 Moscow Olympics a nylon inner lining was introduced, which made the rubber ball much "livelier" and more likely to skip on the surface of the water than the cotton-lined ball. (UPS, 2)
- Caps – Originally used cotton material without numerals, and two different colors to distinguish teams. In the mid seventies, cotton with numerals and earguards for

CHAPTER 1

History and Tradition

protection were worn. Currently, nylon caps with numerals and earguards and multiple colors are used.

- Suits – changed from full length “costumes” to “trunks” (or briefs) for men in the early 1930’s, thereby allowing less material for players to grab a hold of. Women’s suits continue to evolve in efforts to overcome these restraining impediments due to player-to-player contact. (Lambert and Gaughran, 14)
- Length of game – changed from four quarters of five minutes each to four quarters of seven minutes each in 1976 Montreal Olympics to place more emphasis on endurance. Currently the game length is four quarters of eight minutes each.
- Game format – Went from two halves to four quarters in the late 1950’s.
- Size of squad – changed from eleven players on a side to thirteen players on a side in 1984 Los Angeles Olympics in order to allow for more substitution among players. The Women’s roster size has remained at eleven. (Athens, 1)
- Time outs – Were not allowed until 2000 Sydney Olympic Games, where two were allowed for the regulation game and one during overtime.
- Pool dimensions – the 30m. by 20m. course with minimum depth of 7ft. and numbers of players on a side (n=7) have remained constant for nearly a century. The size of the goal has remained 3 feet by 10 feet perpetually, as well. In the women’s game, the course is slightly shorter (25m.). The one exception was the 2004 Athens Olympic Games where the length was moved to 30m.
- Overtime play – First introduced in the 1988 Olympics in order to break ties as a possible conclusion to matches in championship games. (The U.S. lost a chance for a gold medal in the 1984 Los Angeles Olympic Games as a result of a tie with Yugoslavia in the gold medal game. These were the last Games where a medal could be decided after a tie on the basis of goal differential.)
- Referees – originally there was one referee utilized per match. In 1980, at the Moscow Olympic Games, this was changed to include two referees in order to detect and call more of the fouling that takes place. In 1997, the use of flags to indicate possession was dropped in favor of hand directions and pointing.

One of the more memorable moments in Men’s Olympic history involved this exact dilemma of having only one referee. During the 1956 Melbourne Olympic Games the Hungarian team was playing a match with the Soviet Union when a Russian player, Valentin Prokopov, opened up Ervin Zador’s eye with a punch in the fourth quar-



photo courtesy Christine Zador

Fig. 1-7. December , 1956

ter. (Fig. 1-7) The game had to be called off with the Hungarians winning, 4-0 and much blood-letting. One referee wasn't nearly enough to control the overly-physical contact. Half of the Hungarian team defected after the game rather than return to Soviet repression at home. Many of these players came to California and taught the U.S. players new tactics, including the eggbeater kick. (wikidpolo, 4-5). The story of the Hungarian water polo athletes and their defection from the awful brutality occurring in Budapest has been captured in a recent 2006 documentary: "Freedom's Fury," written, directed and filmed by Colin Keith Gray and Megan Raney Aarons. www.freedomsfury.com



Jamie Squire, Allsport

Fig. 1-8. The "modern" game – water polo at the 1996 Olympic Games in Atlanta

**Geopolitics & Water Polo continued:
After the European Championships of 16 June, 2003 in which Serbia & Montenegro defeated Croatia for the Championship, riots broke out in Belgrade, Novi Sad, and Subotica, Serbia and at the pool in Kranj, Slovenia. Several persons were arrested.**

- Exclusions – with this variety of foul, a player is removed for a specified period of time. The amount of time has been reduced over the years from until a goal is scored (prior to 1964) to the present 20 seconds **or** until there is a change of possession or goal scored. (Fig. 1-8)
- No moving rule – prior to 1952, players were to remain stationary after the whistle was blown. This was changed to allow more movement in the game in the 1956 Melbourne Olympics. (U.S.A. Water Polo, “Tribute to 1996...”, 17-18)

As one can see, the rules evolution has added swimming stamina and team play to the already rugged nature of water polo. This has made the game dynamic, fast moving, and quick thereby increasing spectator interest.

In Men’s Olympic competition, Hungary has been far and away the most dominant country, winning eight gold medals in over 100 years of competition, with Great Britain a distant second with four – mostly early in the 20th century (see Appendix#1). There are 75 participating countries in the World that participate internationally in the sport of water polo. (FINA, 1)

In Women’s Olympic competition, the two gold medalists have been Australia (’00) and Italy (’04) (see Appendix #2).

References:

Arts, Books and Sport. “That Sinking Feeling.” *The Economist*, 332.7876 (August 13, 1994): 49.

Athens 2004. “The Official Website of the Athens Olympic Games – XXVII Olympiad.” Athens Olympic Committee. 8 August 2004. <www.Athens2004.com>

Boston Athletic Association Report, 1890-91.

F.I.N.A. “Officials List.” Federation Internationale de Natacion Amateur. 3 April 2005. <<http://www.fina.org/officialslist>>

Juba, Kelvin. *All About Water Polo*. London: Pelham Books, 1972

Kozole, Lovorka and Stojkovic, Dragan. “Sports as War.” *Transitions Online*, (June 23, 2003):pN.PaG

CHAPTER 1
History and Tradition

Lambert, Arthur and Robert Gaughran. *The Technique of v. North Hollywood, CA.: Swimming World Publications, 1969.*

Ludovise, Barbie. "In Demand, This Sport is Top." *Los Angeles Times*, 16 January 1991, C1, C6

N.C.A.A. "Past Champions, Water Polo." N.C.A.A. publications. May 2005. www.ncaasports.com/waterpolo

National Collegiate Athletic Association. *Water Polo Rule Book*. Indianapolis, Indiana: N.C.A.A. Publications, 2004.

Prince of Wales. "St. Andrews." April 2004. <<http://www.princeowales.gov.uk>>

People Magazine. "Prince William Wet & Wild." *People*, 61.17 (May 3, 2004): 58-59.

United Parcel Service. "The Origins of Water Polo." U.P.S. International Cup Game Program July 1999:12.

U.S. Water Polo Championships. September 2005. www.HickokSports.com>

U.S.A. Water Polo. "A Brief History of Water Polo." Hall of Fame Program January 2004: 17-18.

U.S.A. Water Polo. "Tribute to 1996 United States Olympic Water Polo Team." Los Olivos, Ca. 1996

Smith, James R. *The World Encyclopedia of Water Polo*. Los Olivos, Ca.: Olive Press, 1989.

Sykey, Bill. "Factoid." *Sports Illustrated* 101.1 (July 5, 2004): 40.

Wigo, Bruce. "Speaking Out." *Water Polo Scoreboard* (October/November 2000): 6.

Wikipedia. "Water Polo." 24 March 2005, p.4, http://en.wikipedia.org/wiki/Water_Polo

World Wide Aquatics. "About Water Polo." *World Wide Aquatics*, 6 September 2000 www.worldwideaquatics.com

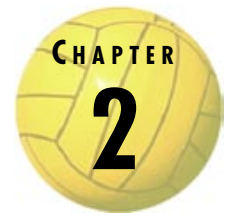

Physiological, Psychological, and Medical Aspects of Water Polo

Physiology

Physiologically and psychologically, water polo is a very demanding and mentally challenging sport. A panel of eight exercise physiologists (Ludovese, C6) ranked water polo highest in athleticism when comparing it to badminton, baseball, basketball, cross-country, football, golf, soccer, softball, swimming, tennis, track and field, volleyball, and wrestling. This ranking included measures for aerobic endurance, agility, anaerobic endurance, body composition, quickness, skill, speed and strength. Let's look at the physiological, psychological, biomechanical, and medical bases for this high ranking.

First, water polo combines the sport of swimming with ball handling. Swimming itself utilizes 15.7-20.0 kilocalories per minute, more than any other form of physical activity (Wilmore and Costil, p.148). In addition, swimming has been found to have a Metabolic Equivalent (MET) value of 20-30, roughly the same as running (Wilmore & Costil, p.622).

Like swimming, water polo makes large demands on aerobic and anaerobic systems. The variety of work involved in the game for field players can be broken down as roughly 50-60% aerobic, 30-35% anaerobic, and 10-15% , immediate energy (ATP-PC) system (Smith, p.331). The third component listed – immediate energy - is largely the result of the physical contact involved in the game.

Water polo is very intermittent, with intense bursts of activity occurring and varying according to the players' positions in the pool. It has been observed that elite male water polo players have approximately 6-20% greater oxygen consumption than competitive swimmers (Smith, p.328). Comparative studies have shown that VO₂ max is higher for international level swimmers than water polo players or pentathletes (Cazorla & Montpetit, p.253). (Vo₂ is a measure of the bodies' ability to use oxygen in the production of energy that is aerobic energy, measured in Liters per minute)

CHAPTER 2

Physiological, Psychological, and Medical Aspects of Water Polo

Water polo players' heart rates have been measured in excess of 150 beats per minute for 91.8% of actual playing time (Smith, Pinnington, et. al., p.6). And, water polo players blood lactate levels have been measured at a range of 6.72mmol/L for younger female players (Nemet, et.al. p.360) to 7-9mmol/L. for older elite and female male players (Rodriguez...Hollander). Lactate levels are a measure of energy output during exercise and the typical resting, non-exercise rate is between 1 and 2 mmol/L. Track competitors, by comparison, have blood lactate levels ranging between 8-10mmol/L. during competition (Wilmore & Costill, p.199)

The usual distance swum by players during a water polo competition is between 1500-1800 meters (Smith, p.322, Hohmann & Frase, p.316). Considering the percentage of aerobic work being done during a water polo match, this system should be addressed very similarly to swimmers' training (4-6,000m./day). Both aerobic and anaerobic systems must be built in the training of water polo players, because of the total playing time a large percentage of the swimming was "steady state" and below the aerobic threshold (Hohmann & Frase, 316).

Secondly, muscular endurance is the ability of a single muscle or group to sustain high intensity, and repetitive or static exercise. It is therefore likely that the most effective form of conditioning for water polo is "...repeated, fast-paced, brief variable bursts with short rest intervals between bursts..." to achieve the exercise most similar to the water polo game(Wilmore & Costil, p.273). A combination of training that includes both aerobic and anaerobic emphases is best to develop the musculature and cardiovascular systems necessary for the competition. Fatleik (fast/slow) training with about 20% of the time swimming at sprint speed and 80% at slow speed is another recommended form of training (Hohmann & Frase, p.319).

Additional positive physical benefits of water polo are enlargement of the heart muscle in order to pump more blood, and an increase in body mass as a result of the physical struggle and contact made between players (Pavli, et. al).

Psychology

The major factor regarding the psychology of water polo has to do with the tactical decision-making the players utilize while expending the bodily energy just mentioned. When compared with expert volleyball and basketball players, water polo players were found to be highest in decision-making (game situation), visual reaction time, and

CHAPTER 2

Physiological, Psychological, and Medical Aspects of Water Polo

spatial orientations – while basketball players were better on prediction and selective attention and volleyball players were best on perceptual speed, focused attention, prediction, and estimation of speed and direction of a moving object (Kiomourtzoglou, et.al, 1998).

Similar to other sports, a psychological variable which has been proven beneficial for water polo athletes is the development of a pre-performance routine. Marlow, et. al. (1999) found significant increases in water polo penalty shot performances due to personalized pre-performance routines including concentration cues, relaxation, imagery, and cue words.

Water polo requires thinking which is analytical and immediate. Players, because of the lack of visual memory that is available through the media, are much the beneficiaries of actual experience in complex situations that accumulate over a number of years.

Biomechanics

As in all sports, strength training is of great value in enhancing successful water polo performances. There are several muscle groups utilized in the basic actions of throwing a ball as well as in swimming head up and eggbeatering.

Regarding throwing technique, Newton's 2nd law of motion ($F=m \cdot a$) as applied to acceleration states that the velocity of an object...depends upon both the amount of force and the length of time over which the force is applied. Therefore, when more muscles are used over a longer distance, more force is attainable. And, when more contributing body parts (joints) are brought into the action, if they are in sequence, the more speed is possible. (Broer, p.234,246)

The optimal succession of levers (joints) for the overarm baseball throw used in water polo is:

Outward/inward rotation of spine & back (Fig. 2-1, 2-2) → extension to flexion, external to internal rotation and horizontal ab- to adduction of shoulder (Fig. 2-3, 2-4) → extension to flexion of elbow (Fig. 2-5, 2-6) → hyper extension to flexion and pronation of wrist and fingers. (Fig. 2-5, 2-6)

Upcoming are photographic representations of the over thirty-five major muscle groups utilized in water polo, in the approximate sequence of their chain.

CHAPTER 2

Physiological, Psychological, and Medical Aspects of Water Polo

Upper Body Musculature – Major Muscle Groups as Part of Throwing Motion:

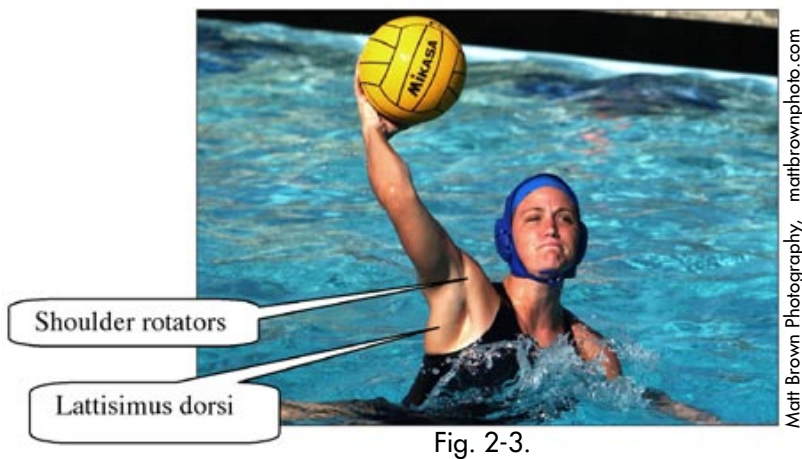
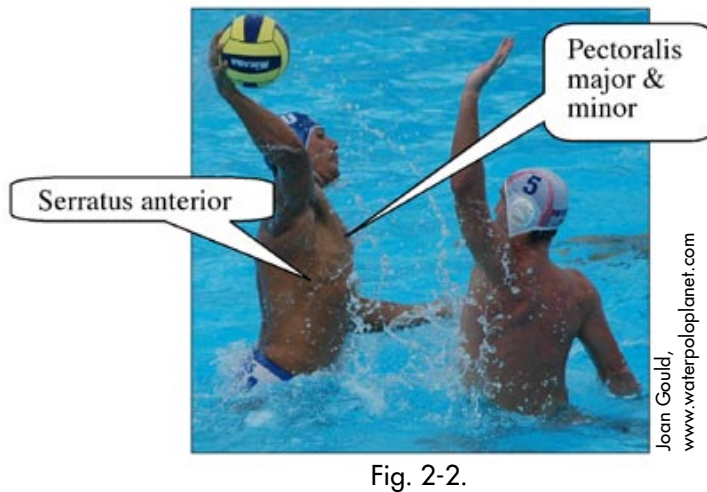
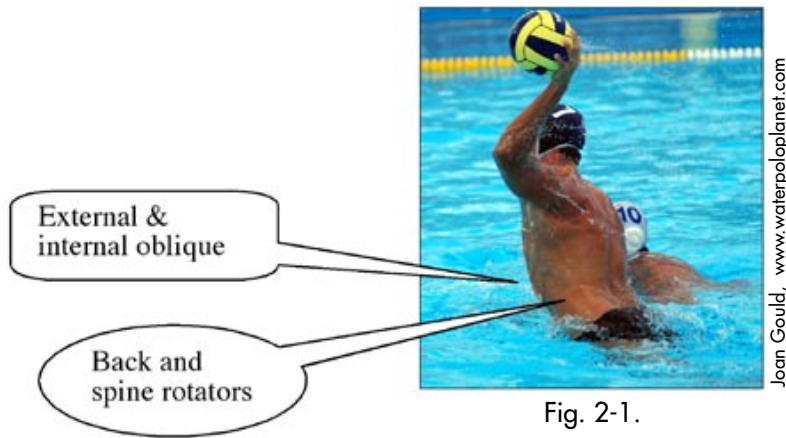

CHAPTER 2

Physiological, Psychological, and Medical Aspects of Water Polo



Fig. 2-4.

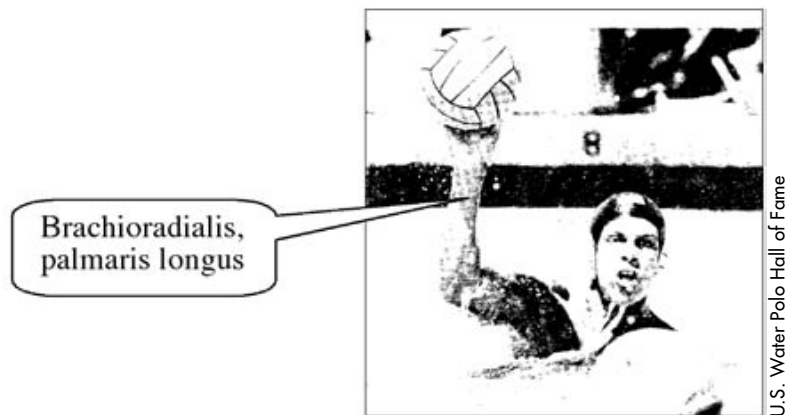

Fig. 2-5.

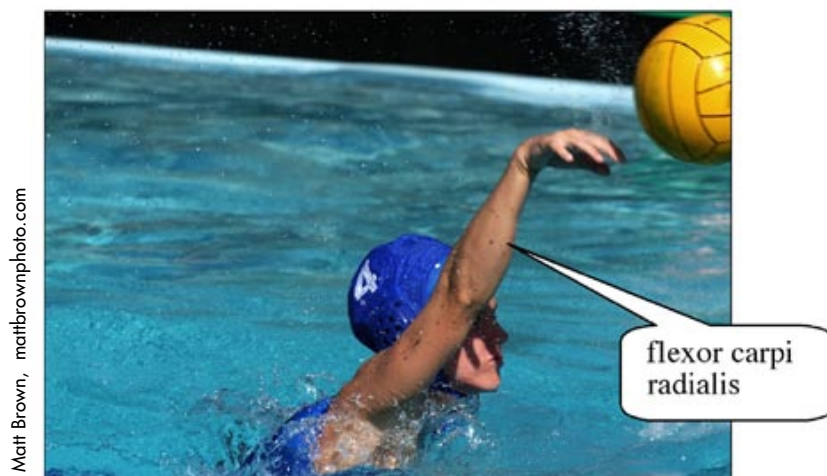

Fig. 2-6.

CHAPTER 2

Physiological, Psychological, and Medical Aspects of Water Polo



Fig. 2-7.



Fig. 2-8.

The biomechanics and kinematics of successful and non-injurious arm movement in the throwing motion have been studied and analyzed with the following recommendations: (Davis & Blanksby, Elliot & Armour, Falcone, Feltner and Nelson, Whiting, et.al.)

- Regarding the angle bend at the **elbow**, during the throwing motion the initial starting point after a circular path backward should be between 89-155°, with the optimal between 90-120°.
- The angle for the **elbow** at the release point is between 148° and 158°.
- At the conclusion of the throw, the release point for the **wrist** is between 148° and 180°.

CHAPTER 2

Physiological, Psychological, and Medical Aspects of Water Polo

- The follow through angle of the elbow should be 180°.
- The internal rotation and horizontal adduction of the shoulder, as part of the succession of levers, contribute significantly to ball speed at release.
- The eggbeater kick is an essential stabilizing component, as there is no fixed point from which the body can pivot. Typically the extension phase of the legs coincides with the forward movement of the throwing arm.

As itemized above, the sequence of levers facilitates the transfer of torque from the large muscle groups to the small distal muscle groups thereby increasing the force. At the end of the chain, “The movement of the wrist joint should be coordinated with elbow extension if maximum ball velocity is to be achieved.”(Elliott & Armour, p.113)

Progressive resistance, plyometric, and isokinetic exercises which can strengthen the aforementioned muscles should be done before, during, and after the season of competition. These type of exercises, especially working on the musculature which is significantly weaker and imbalanced with other muscle groups, are beneficial in rehabilitation and prevention of injuries. (see Appendix three)

Women in particular can gain considerable major increase in strength (20-40%) as a result of resistance training. And, contrary to the concern over “bigness” this strength gain is not accompanied by large increases in muscle mass as the larger levels of testosterone in males is what contributes to more muscles (Wilmore & Costil, p. 580,82).

Lower body musculature – stabilization via eggbeater (alternating frog) kick

Coordination between one leg and another in the eggbeater kick is an important base for the pass and shot in water polo. Correct technique with this kick will help provide adequate support to be able to pass and shoot. This optimal sequence is as follows (one leg):

Succession of Levers for One Leg in the Eggbeater Kick:

(see chapter 9 “Goalkeeper” also)

Hip abduction, flexion, & outward rotation → knee flexion → ankle dorsiflexion & eversion → ankle inversion & plantarflexion → knee extension → hip adduction, extension & inward rotation. (Fig. 2-9, 2-10)

CHAPTER 2

Physiological, Psychological, and Medical Aspects of Water Polo

The timing of the two-leg cycle is such that at full knee extension and plantarflexion for the first leg, the second leg is at maximal knee flexion and ankle dorsiflexion, and vice-versa. (Sanders, p.282). (Fig. 2-11)

Major muscle groups used in the eggbeater kick are shown below:

Underwater photos of leg muscles utilized in eggbeater

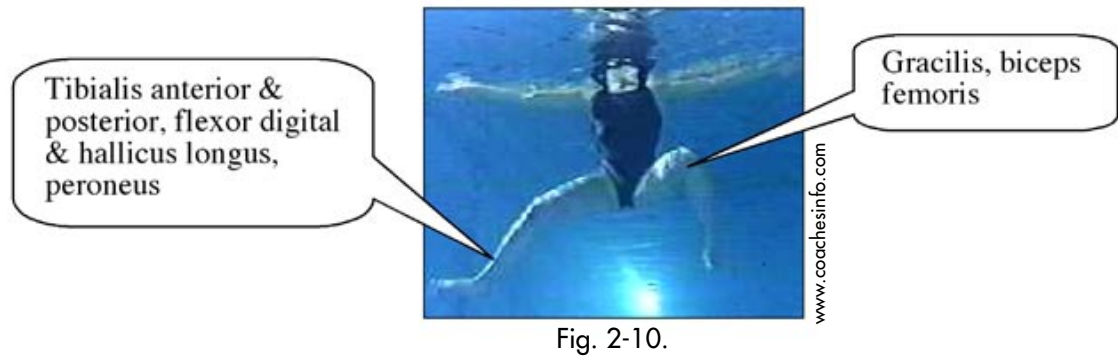
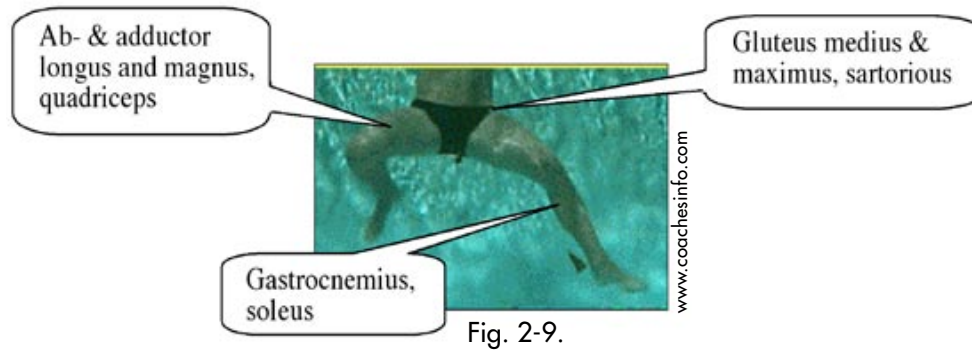

Eggbeater kick - maximum vertical propulsion, above-water photo



CHAPTER 2

Physiological, Psychological, and Medical Aspects of Water Polo

Nutrition

As with most sports, hydration is of utmost importance. “Fluid balance during exercise is critical for optimal cardiovascular and thermoregulatory function.” (Wilmore & Costil, p.178) Fluid loss is not as pronounced in aquatics athletes as in runners. Most fluid loss for aquatics athletes comes through conduction and convection, therefore there is not the evaporation that takes place on land. For land sport athletes, 80% of heat loss comes through evaporation (Wilmore & Costil, p.311).

The average long distance runner loses .96 to 1.27 L/hour of fluids. (Juhn, MS & Henehan, p.393) Male basketball players lose 7.97-10.79L/hour of fluids. (Cox, et.al., p.190) In contrast, the average fluid loss for water polo players has been reported as .51 L/hour.

Aquatics athletes, in general, need .5L/hour in order to be well hydrated during competition. A loss of more than 5% of his or her total body weight will likely result in performance decrements for water polo athletes.

In order to enable efficient muscular contraction, three basic minerals are necessary as part of fluid and/or solid intake: calcium, potassium, and sodium. Calcium can be found in large percentages dairy products and vegetables; potassium is found in fruits, vegetables, and milk products; and sodium can be attained through moderate addition of salt to the diet. (Houtkooper, pp.39-40)

The most essential nutrient necessary for replacement during rigorous exercise is glycogen. Because of the demands on the anaerobic system and the glycolic anaerobic system, and for muscular efficiency, it has been suggested that water polo athletes need 6 grams of carbohydrate 8 times a day (Farajian, et. al, p.570). Muscle glycogen resynthesis is most rapid when individuals are fed at least 50grams of glucose every two hours after exercise (Wilmore & Costil, p.178)

Injuries

The all-encompassing usage of musculature in water polo makes it very beneficial to the health of the body but at the same time places an extra burden on certain areas. Water polo is the only “true” contact sport in the Aquatics discipline. This aspect,

CHAPTER 2

Physiological, Psychological, and Medical Aspects of Water Polo

combined with head up swimming, reduces the amount of body roll the athlete can use during his (her) strokes and therefore more forced ab- and adduction movements of the shoulder region.

In addition, the water polo athlete must **throw** from many different body positions without a firm base upon which to balance – i.e. there is no fixed point around which to rotate. **Good mechanics are essential in order to avoid injury.** In the shoulder joint, abduction and external rotation, combined with maximum forward flexion of the glenohumeral joint places a large amount of force on the rotator cuff area. (Colville & Markman, p.307, Chalmers & Morrison, p.761)

Shoulder pain in water polo can most often be attributed to the following:

- A strength imbalance between the internal rotators and adductors of the shoulder in contrast to the external rotators of the deltoid and rotator cuff muscles.
- Biomechanics that place undue stress on the shoulder as part of the succession of levers (i.e. $<90^\circ$ or $>120^\circ$ at the elbow joint)
- Inadequate warm-up of musculature and tendons prior to the high degree of acceleration and kinetic energy applied to the body during shooting.
- Combinations of head up swimming (butterfly) and passing/shooting done in excess prior to the supporting musculature being strong enough to support these activities over a long term.

Even good throwers are susceptible to injury due to the transfer of torque through the succession of levers.

At a minimum, water polo players should work to establish a remedial program to rebalance the rotator cuff with exercises that work on the abductors and external rotators in order to equalize the musculature strength in this area. (McMaster, et. al., p.75)

The elbow area is another common injurious site for water polo players. Pain is correlated with the overhead throwing motion, during which stress can occur in the ulna collateral ligament complex (Colville & Markman, p.309). Once again, the lever angle at the elbow joint, if $>150^\circ$, is a contributor to increased amounts of stress on the ligaments and tendons in this region. Goalies in particular can experience hyper-extension injuries at the elbow joint, largely the result of improper absorption of contact with the ball.

CHAPTER 2

Physiological, Psychological, and Medical Aspects of Water Polo

In the hand and wrist region, commonly encountered injuries include lacerations, dislocations and fractures of the bones and joints (Richardson, p.370). There is a lot of hand contact with the ball and with other players, and the strength and flexibility of these muscles and tendons is important in order to be prepared for this contact. (Colville & Markman, p. 310) Goalkeepers in particular are susceptible to trauma in this ulna collateral ligament region – particularly when coming in contact with the post of the goal.

The eggbeater kick contributes to possible lower body injury – specifically at the knee and hip joints. The pattern of the legs in eggbeater with abduction and internal rotation at both of these joints places stress on the medial collateral ligament and can become inflamed (Brooks, p.318). Due to the turning and twisting motions of the torso, the spine and extremities have been identified as common regions for injury (Chalmers & Morrison, p.761). Again, strengthening and flexibility exercises for both of these regions is beneficial as prevention.

Finally, most water polo players rarely take precautions for the mouth area. Studies have shown that a mouthguard would be advisable prevention for contact to this region. (Brooks, 316).

Gender Differences

The rapid advance and proliferation of girls and women's water polo has stimulated research regarding female development in the sport. Recent research has pointed towards the following comparisons between genders:

- There is no significant difference in the beginning and duration of the menstrual cycle between female water polo and non-water polo players. (Sambanis, et.al., p.401)
- Women have lower sweat rates than men for the same heat stress – with no effect on women's ability to tolerate heat (Wilmore & Costil, p.597)
- Female water polo players have more shoulder injuries, generally, than males. (Sallis, et. al., p.421), (Brooks, p. 318)
- Gender differences for the elbow and wrist angles have been observed during the overarm throw, with women having less range of motion for the wrist (Elliott & Armour, p.110). It has been speculated that this disadvantage was due to the

CHAPTER 2

Physiological, Psychological, and Medical Aspects of Water Polo

smaller hand to ball size ratio. And, it has been found that the angle at the elbow joint is a critical variable for females, with the necessity of approaching 100° so that there is less strain placed on the shoulder rotator muscles.

Females adherence to efficient biomechanical leverage in passing and shooting motions is therefore maximized in order to prevent the possibility of injury mentioned above.

References:

Andreoli, A, Monteleone, M, Van Loan, M, Promenzio, JI, Trantinu, U., De Lorenzo, A. "Effects of different sports on bone density and muscle mass in highly trained athletes." *Medicine & Science in Sports & Exercise* 33.4 (April 2001): 507-11.

Bielen, Robert. "Common Overuse Problems," *Water Polo Scoreboard* 5.6 (1990): 15-16.

Broer, Marion. *Efficiency of Human Movement*. Philadelphia, Pa: W.B. Saunders, 3rd edition, 1973.

Brooks, Joy. "Injuries in Water Polo." *Clinics in Sports Medicine* 18.2, (April 1999): 313-19.

Carzorla, Georges and Montpetit, Richard R. "Metabolic and Cardiac Responses of Swimmers, Modern Pentathletes, and Water Polo Players During Freestyle Swimming to a Maximum," in Ungerechts B., et.al. eds., *Swimming Science V*. Champaign (IL): Human Kinetics, 1988: 251-7.

Chalmers, D.J., Morrison, L. "Epidemiology of Non-Submersion Injuries in Aquatic Sporting and Recreational Activities." *Sports Medicine* 33.10 (2003): 745-770.

Clarys, J.P, Cabri, J. Teirlinck, P. "An Electromyographic and Impact Force Study of the Overhand Water Polo Throw." In Malaren, D. et.al., eds. *Swimming Science VI: Biomechanics and Medicine in Swimming*. London: E & FN Sport, 1992, 111-16.

Ball: Coaches Info. Water Polo, 20 September 2005.
<http://www.coachesinfo.com/category/water_polo>

CHAPTER 2

Physiological, Psychological, and Medical Aspects of Water Polo

Colville, James, Markman, Bruce. "Competitive Water Polo: Upper Extremity Injuries." *Clinics in Sports Medicine* 18.2 (April 1999): 305-12.

Cox, G.R., Broad, E., Riley, M., and Burke, L. "Body Mass Changes and Voluntary Fluid Intakes of Elite Level Water Polo Players and Swimmers." *Journal of Science and Medicine in Sport* 5. 3 (Sept. 2002): 183-93.

Davis, T., Blanksby, B.A. "A Cinematographic Analysis of the Overhand Water Polo Throw." *Journal of Sports Medicine* 1977, 17, 5-16.

Elliott, Bruce and Julie Armour. "The Penalty Throw in Water Polo: A Cinematographic Analysis." *Journal of Sports Sciences* 6 (January 1988): 103-14.
Falcone, Kelly. "Three-Dimensional Biomechanical Analysis of the Water Polo Penalty Shot in Female Athletes." Master's Thesis, San Diego State University (Fall 2005).

Farajian, P., et.al. "Dietary Intake and Nutritional Practices of Elite Greek Aquatic Athletes," *International Journal of Sport Nutrition & Exercise Metabolism* 14. 5 (October 2004): 574-85.

Feltner, Michael E. and Nelson, September. "Three-Dimensional Kinematics of the Throwing Arm During the Penalty Throw in Water Polo." *Journal of Applied Biomechanics* 12 (1996):359-82.

Hohman, A. and Frase, R. "Analysis of Swimming Speed and Energy Metabolism in Competitive Water Polo Games." In Malaren, D. et.al., eds. *Swimming Science VI: Biomechanics and Medicine in Swimming*. London: E & FN Sport, 1992, 313-319.

Houtkooper, Linda. "Causes of Muscle Cramps." *Swimming World* (August 1991): 39-40.

Juhn, Mark, Henahan, M. "Body Mass Loss and Fluid Consumption in Aquatic Sport: A study of Elite Water Polo Players During Competition." *Australian & New Zealand Journal of Medicine* 30.3 (June 2000): 393-4.

Kioumonourtzoglou, Efthimios, et.al. "Differences in Several Perceptual Abilities Between Experts and Novices in Basketball, Volleyball and Water-polo." *Perceptual and Motor Skills* 86.3pt 1 (1998): 899-912.

CHAPTER 2

Physiological, Psychological, and Medical Aspects of Water Polo

Ludovise, Barbie. "In Demand, This Sport is Top." *Los Angeles Times*, 16 January 1991, C1, C6.

Marlow, Caroline, et.al. "The Use of a Single Case Design to Investigate the Effect of a Pre-performance Routine on the Water Polo Penalty Shot." *Journal of Science and Medicine in Sport* 1.3 (1998): 143-155.

McMaster, William, Long, Susan, and Caiozzo, Vincent. "Isokinetic Torque Imbalances in the Rotator Cuff of the Elite Water Polo Player." *American Journal of Sports Medicine* 19.1 (1991):72-75

Nemet, Dan, et.al. "Effect of Water Polo Practice on Cytokines, Growth Mediators, and Leukocytes in Girls," *Medicine and Science in Sports and Exercise*. 35.2 (February 2003): 356-63.

Newland, Edward. "Conditioning" in Hale, Ralph, ed. *The Complete Book of Water Polo*. New York: Simon & Schuster, 1986.

Pinnington, Hugh, Dawson, Brian & Blanksby, Brian. "Training for Water Polo," Department of Human Movement and Recreation Studies, University of Western Australia, 1987.

Richardson, Allen. "Thoracic Outlet Syndrome in Aquatic Athletes." *Clinics in Sports Medicine* 18.2 (April 1999): 361-377.

Sallis, R., et.al. "Comparing Sports Injuries in Men and Women." *International Journal of Sports Medicine* 22 (2001): 420-423.

Sambanis, et.al. "A Study of the Effects on the Ovarian Cycle of Athletic Training in Different Sports." *Journal of Sports Medicine and Physical Fitness*. 43.3 (September 2003): 398-403.

Sanders, Ross H. "A Model of Kinematic Variables Determining Height Achieved in Water Polo Boosts." *Journal of Applied Biomechanics*. 15 (1999): 270-283.

Schipper, David. "Waterworld." *Men's Health*. 20.6 (July/August 2005): 64.

CHAPTER 2

Physiological, Psychological, and Medical Aspects of Water Polo

Smith, Heather. "Applied Physiology of Water Polo." *Sports Medicine*. 26.5 (November 1988):317:34.

Snyder, Peter. "Strength Training for Polo, Diving and Synchro." *Swimming Technique* (August 1980): 31-32.

Whiting, William, et.al. "Three-dimensional Cinematographic Analysis of Water Polo Throwing in Elite Performers." *American Journal of Sports Medicine* 13.2 (1985): 95-8.

Wilmore, Jack and David Costil. *Physiology of Sport and Exercise*. Champaign (IL): Human Kinetics, 3rd edition, 2004.

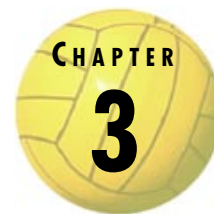

Basic Swimming Skills as Applied to Water Polo

Water polo can provide great physical and psychological cross-training benefits for swimmers and other athletes. A typical season lasts a little over three months, during which many mental and physical growth patterns can occur.

Pediatricians have found that overtraining and specialization on one activity or sport can have negative consequences for youth sports participants (American Academy of Pediatrics, p.156). The specific areas of concern are: physical – musculoskeletal injury and growth impairment, physiological – improper nutritional intake, and psychological – personality developments which may adversely affect the longevity of involvement in sports.

Great athletes in their early development typically participate in a variety of sports in order to learn various physical and mental skills and increase enjoyment in these activities. In addition, as stated in Chapter 2, different physiological systems are developed in water polo in comparison to many other sports.

The team aspect of water polo also adds a facet that is not found in individual sports. One can have a great individual performance while at the same time his(her) team is not having success. Individual sacrifice for team success is an attribute that water polo shares with many other team sports.

To follow up on the physiology of swimming conditioning and water polo, we will look at the modifications in training that water polo players must do. Swimming strokes for water polo must be adapted in order to make sure that the players can:

- See where the ball is.
- See where his(her) teammates and opponents are.
- See where (s)he is in the pool and where the goal is.
- See where the referee is pointing and what (s)he is indicating.
- Hear the referee's whistle.
- Hear teammate communication and coaching instruction.

CHAPTER 3

Basic Swimming Skills as Applied to Water Polo

The adjustments that must be made from swimming technique to water polo technique for each of the competitive strokes are as follows:



Joan Gould, www.waterpoloplanet.com

Fig. 3-1. Head up Front Crawl – Sprint

Front Crawl

Used as the mainstay for speed, strength, and lateral movements. Endurance, quickness, forward sprint, turning, and stop/start/transfer to eggbeater all part of this stroke and its variations. (Fig. 3-1, 3-2)

Technique points:

- Head up high so that eyes, ears, and neck are above the water surface.
- Entry point for hands outside the shoulders so as to increase stroke rate and add buoyancy and velocity to the body position and arm turnover.
- Elbows riding high, above the forearm and shoulder to assist in protecting the ball.
- Arm turnover rapid and choppy to enhance acceleration and allow for hands out of water to receive pass.



Joan Gould, www.waterpoloplanet.com

Fig. 3-2. Head up front crawl: short, choppy strokes

CHAPTER 3

Basic Swimming Skills as Applied to Water Polo



Fig. 3-3. Head up back crawl (white caps)



Fig. 3-4.

- Flutter kick – short and explosive to add buoyancy to body position and inhibit defenders.

Back Crawl

Used to get the best look at the field and to make direct eye and/or verbal contact with another field player or the goalie. (Fig. 3-3, 3-4, 3-5)

Technique points:

- Head up so that eyes, ears, and neck are above the water surface.
- Body position “sitting down” so that head and upper torso out of water.
- Entry point for hands outside the shoulders so as to increase stroke rate and add buoyancy and velocity to the body position and arm turnover. Straight arm entry just as in swimming technique.
- Short, choppy and rapid strokes so as not to lose speed advantage in relation to other players.

CHAPTER 3

Basic Swimming Skills as Applied to Water Polo

- Leg kick either cross frog and/or flutter depending on rate of speed desired and body height in relation to the water – the more body elevation desired, the more frog kick needed.



www.newzealandwaterpolo.com

Fig. 3-5. Head up back crawl (dark cap)

Breaststroke

Used to slowly advance, rest, as part of preparatory body position for front crawl sprint, and transition to eggbeater kick used for all passing, shooting, offensive and defensive moves. (Fig. 3-6, 3-7)

Technique points:

- Head up so that eyes, ears, and neck are above the water surface.
- Shortened circle pulls so as to allow for immediate transition to other strokes.
- Preparation of body position – prone to the water - for quick starts.
- Short, circular and backward thrusts of frog kick to keep body level on water surface.
- Preface to the eggbeater kick; most especially valuable and mandatory for goalies as their lower body support to block the ball.



Joan Gould, www.waterpoloplanet.com

Fig. 3-6. Body position – skull/breaststroke

CHAPTER 3

Basic Swimming Skills as Applied to Water Polo



Joan Gould, www.waterpoloplanet.com

Fig. 3-7. Skulling, resting, preparation of body position

Side Stroke

Used primarily for change of direction; water polo requires 45°, 90° and 180° pivots and turns by the body; the trunk rotation to the side and use of the scissors kick helps drive these moves. (Fig. 3-8)



Joan Gould, www.waterpoloplanet.com

Fig. 3-8. Extended on side, ready for quick start (sidestroke)

Techniques points:

- Layout position includes extending upper arm to catch as much water as possible - especially useful for the sprint at the start of the period.
- Quick, short side pulls to the chest level only.
- Hinging (flexion) of trunk and abdomen, timed with bent knee scissors kick for quick and explosive starting and change of direction.

CHAPTER 3

Basic Swimming Skills as Applied to Water Polo

Sample Swimming Conditioning Drills and Their Applicability to Water Polo:

Drill	Energy System Used	Area of Water Polo benefitted
Swimming sets with timed intervals – head down swimming – all four strokes for distances of 50,75,100,200,400 yds. depending on energy system development	Aerobic & Anaerobic	Building aerobic base, increasing bodily recovery, developing VO2 maximum uptake, endurance.
Head up Reversals 180°, front crawl, change direction on whistle command	Anaerobic	Reaction time, mobility, flexibility, quickness, endurance, head up crawl capability.
Three strokes head up front crawl, three strokes head up back crawl, repeat pattern or on whistle command for 25+ yds.	Anaerobic	Technique for head up backstroke, mobility between front and back crawl, flexibility for prone and supine body positions.
Change of directions – 45°, 90°, 180° combinations as per pointed direction	Anaerobic	Reaction time, mobility, flexibility, quickness, endurance, head up crawl capability, ability to move in multiple directions.
Quick starts front crawl from head up prone body position, whistle command	Anerobic	Beneficial body position for quickness, reaction time, rapid acceleration.
Head up butterfly short distances	Aerobic/Anaerobic	Utilization of multiple muscle groups, rigorous exercise, endurance.
*On top swimming/underwater swimming – alternate short distances	Anaerobic, Anaerobic glycolic	Lung capacity, O2 deprivation, swimming efficiency.

* GREAT CAUTION – no hyperventilating during this conditioning so as to avoid the chance of shallow water blackout.



Stanley Hu, Accelphoto.com

Fig. 3-9. Dribbling, defender guarding closely (dark caps)

CHAPTER 3

Basic Swimming Skills as Applied to Water Polo



Fig. 3-10. Dribbling, defender guarding closely (dark caps)

Sample Ball Handling Conditioning Drills:

Head up dribble reversals 180°, front crawl, change direction on whistle command	Anaerobic	Reaction time, mobility, flexibility, ball pick-up and movement, quickness, endurance, head up dribble capability.
Dribble with ball, pick up over head, fake three times, replace, dribble – repeat pattern	Anaerobic	Dribbling and ball pick up proficiency, faking motions effectiveness for shooting, eggbeater kick as support for body position.
Head up dribbling with defender contact –holding and resisting (Fig. 3-9, 3-10)	Anaerobic, Anaerobic glycolic	Ball handling with physical contact, overcoming resistance and drag from defender, maintaining technique under duress.
Change of directions, dribbling – 45°, 90°, 180° combinations as per pointed direction	Anaerobic	Reaction time, mobility, flexibility, quickness, endurance, head up dribbling capability, ability to move in multiple directions with the ball.
Turn (spin) 90°, 180°, vertical position, in possession of the ball with defender guarding	Anaerobic, Anaerobic glycolic	Ball handling, contact with defender, and leverage with the ball, offensive tactic for advantage on defender with hips down.
Dribble, pick ball up, spin 360° clockwise or counterclockwise, set ball back down, continue	Anaerobic	Dribbling, ball pick-up, rotation of body resulting from leg strength, balance, ball control.
Walking with the ball clutched in hand as part of a dribble/ crawl stroke	Anaerobic	Gripping the ball, dexterity, stroke mechanics with ball.

Water Polo

Technique

Players are not allowed to touch the bottom of the pool. They may use a rotary or "eggbeater" kick to keep themselves afloat so their arms are free for shooting, passing or catching the ball. This effort goes on while players are colliding and fighting for the ball.



The kick's lifting power comes from the sweeping action of the leg and foot.



The lower legs alternately rotate in large circular motions sideways and backward, and then sharply forward.

LATimes.com

Fig. 3-11.



Joan Gould, www.waterpoloplanet.com

Fig. 3-12. Arm up defense, eggbeater support

CHAPTER 3

Basic Swimming Skills as Applied to Water Polo

Suggested Eggbeater Conditioning Drills – Leg Strength:

(Fig. 3-11, 3-12)

**Eggbeater 4 directions – forward, backward, sideways left, sideways right –multiple variations	Anaerobic	Leg strength and eggbeater proficiency, body position as necessary for passing, shooting and goaltending.
Eggbeater pushing flutter kick: players paired, facing each other – eggbeater should “win”	Anaerobic	Leg strength; flutter kick and eggbeater proficiency, body position as necessary for passing, shooting and goaltending.
Lateral (sideway) lunges eggbeater with arms extended- on command - stationary	Anaerobic	Lateral mobility for effectiveness in offensive and defensive movements, leg strength, and goaltending technique.
Lateral lunges eggbeater with arms extended- intermittent combined with head up crawl	Anaerobic	Lateral mobility for effectiveness in offensive and defensive movements, transition from horizontal to vertical leg strength.
Leap frog over partner – eggbeater kick	Anaerobic	Leg strength, vertical power, physical contact, fun
Submersing of partner - hands on shoulders from behind: straight arm, bent arm, complete sink for decreasing amounts of time	Anaerobic, Anaerobic Glycolic	Leg strength, vertical power, physical contact, fun.

** Many varieties for this drill – hands in water, out of water, on head, extended, carrying resistance, weight belts, etc.

References:

Anderson, Steven J., M.D., et. al. “Intensive Training and Sports Specialization in Young Athletes.” *Pediatrics* 106 (July 2000): 154-158.

Lambert, Arthur and Robert Gaughran. *The Technique of Water Polo*. North Hollywood, CA.: Swimming World Publications, 1969.

Los Angeles Times. “Athens 2004: Water Polo Technique.” July 15, 2004, C4.

Stockdale, John C. *Water Polo Canada Coaching Certification Program Level 1 – Basic Coach*. Ottawa, Can.: Coaching Association of Canada, 1977.

www.athens2004.com/ Aquatics: Water Polo

Individual Offensive Ball Handling Skills

As in any sport, in order to develop the motor pathways necessary for coordinated motions players should start with basic water polo skills and move to more complex physical tasks. This chapter will follow a progression which will evolve from simple to complex. Photos will be used for each skill in order to provide the reader with a visual example of each of the skills.

Dribbling – Head Up

This skill is utilized to advance the ball from the defensive to the offensive end of the pool. (Fig. 4-1, 4-2)

Technique points:

- Head held high to see over the ball.
- Arms wide entry to avoid contact with the ball during stroking.
- Rapid turnover to stabilize the ball position in front of the head.
- Elevated hip and body position to ward off defenders.
- Strong flutter kick to gain speed while dribbling.

* NOTE – head down dribble an option for additional speed.



Matt Brown, mattbrownphoto.com

Fig. 4-1. Dribbling: wide strokes, head high

CHAPTER 4

Individual Offensive Ball Handling Skills



www.sportsworld.photorelect.com

Fig. 4-2. Dribbling: high elbows, head high, viewing the field

Ball Pick Up – Under Water and On Top of the Water

(Underneath pick up Fig. 4-3, 4-4, 4-5)

The player will need to execute this skill both as part of his(her) swimming/dribbling motion and as a “stand alone” motion. A clean pick up of the ball is the foundation of any sort of pass or shot, and therefore needs lots of practice. (On top pick up Fig. 4-6, 4-7, 4-8)



Katina Kitchens, www.magnoliahs.org

Fig. 4-3. Stationary underwater pick up, unguarded

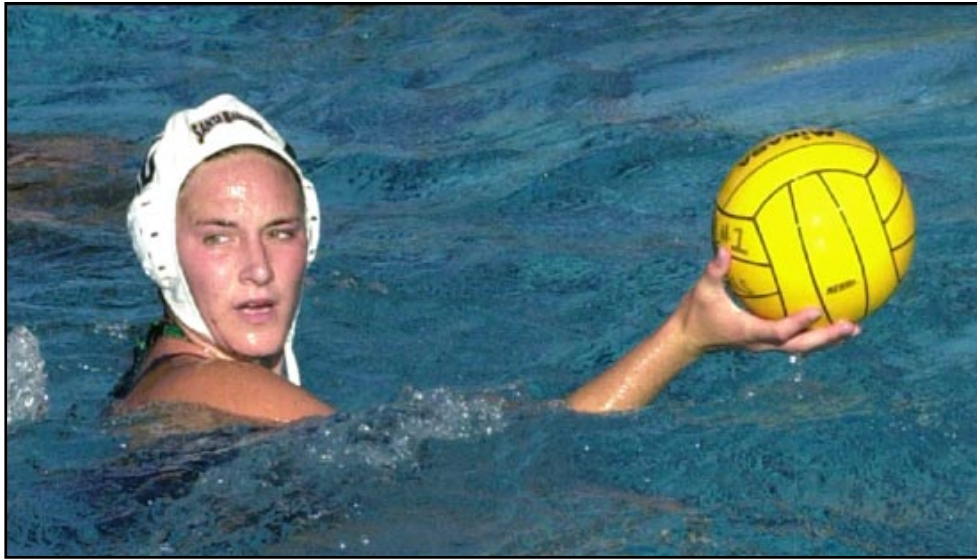

Mike Sandford

Fig. 4-4. Stationary underwater pick up, unguarded



Matt Brown, mattbrownphoto.com

Fig. 4-5. Stationary underwater pick up, closely guarded

CHAPTER 4
Individual Offensive Ball Handling Skills



Matt Brown, matbrownphoto.com

Fig. 4-6. Stationary on top pick-up, unguarded



Joan Gould, www.waterpoloplanet.com

Fig. 4-7. Dribbling on top pick-up, unguarded



Matt Brown, matbrownphoto.com

Fig. 4-8. Dribbling on top pick-up, unguarded



www.newzealandwaterpolo.com

Fig. 4-9. Preparation for underwater pick-up while dribbling (note: high elbows)



Joan Gould, www.waterpoloplanet.com

Fig. 4-10. Preparation for on top pick-up while dribbling, closely defended (note: high elbows)



www.newzealandwaterpolo.com

Fig. 4-11. Opposite hand underwater pick-up while dribbling, preparation for flip pass, toss-up or pop shot

CHAPTER 4

Individual Offensive Ball Handling Skills

Technique points:

- Fingers and thumb spread apart so as to distribute the mass of the ball.
- Elbow above hand on top pick-up OR hand above elbow underneath pick-up for maximum leverage.
- Pick-up arm slightly bent at elbow for additional ball control and quicker vertical or horizontal movement if needed.
- Under water pick-up emphasized initially so as to avoid “ball under water” technical foul and the defense or goalie knowing when the pick-up is made.
- If pick-up is part of the dribble, opposite arm must continue its swimming motion so as to provide potential base to elevate the body and not tip off the goalie or a defender as to when the pick-up will be made. (Fig. 4-9, 4-10, 4-11)

Note: Four skills at one time - dribbling, picking up ball, eggbeatering and looking towards direction or target of pass or shot.

Baseball Pass and Pass Reception

The motion for passing in water polo and the sequence involved were described in detail in chapter two as part of the biomechanics of throwing. This segment on passing emphasizes checks in the motion.

Technique points:

- The ball should start well above the head and extended back as far behind the head as is possible. (Fig. 4-12, 4-13)
- The elbow should lead the throwing motion. (Fig. 4-14)
- The ball should finish its exit point from the middle and index fingers of the throwing hand, thumb pointing down, like throwing a football.
- There should be backspin on the ball as part of the snapping motion of the wrist (pronation) on the follow-through, like a shot in basketball. (Fig. 4-15, 4-16)

CHAPTER 4
Individual Offensive Ball Handling Skills



Joan Gould, www.waterpoloplanet.com

Fig. 4-12. High ball position, pass or shot



Joan Gould, www.waterpoloplanet.com

Fig. 4-13. High ball position, pass or shot, wrist laid back (hyperextended)



Joan Gould, www.waterpoloplanet.com

Fig. 4-14. Lead with elbow

CHAPTER 4

Individual Offensive Ball Handling Skills



Fig. 4-15. Follow thru, thumb down (pronation), ball touched last by index and middle fingers

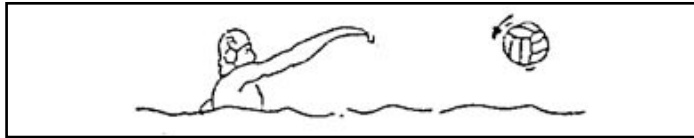

Fig. 4-16. Backspin on the ball

Layout Pass When Closely Guarded or Unguarded

This is a wet area pass, or a dry, in the hand pass to a receiver requiring the passer to initially turn his or her back to the target in order to protect the ball from a defender.

Technique points:

- Rolling torso from position on stomach protecting the ball to position on back while holding on to ball with arm extended. (roll towards left shoulder when holding on to ball with right hand, towards right shoulder when holding on to ball with left hand) (Fig. 4-17, 4-18, 4-19)
- Looking over shoulder several times to see where receiver or target is.
- Utilizing eggbeater, 45° turn, or “step-out” move to get distance from defender. (Fig. 4-20, 4-21)



Fig. 4-17. Layout pass preparation, throwing arm extended, looking for receiver or target

CHAPTER 4

Individual Offensive Ball Handling Skills

- Body position on back – continuous eggbeater or breaststroke kick. (Fig. 4-20)
- Follow through with baseball pass motion.



Matt Brown, matbrownphoto.com

Fig. 4-18. Layout pass preparation, throwing arm extended, looking for receiver or target



Matt Brown, matbrownphoto.com

Fig. 4-19. Layout pass roll to back



Matt Brown, matbrownphoto.com

Fig. 4-20. Layout pass continue kick on back

CHAPTER 4

Individual Offensive Ball Handling Skills



Fig. 4-21. Layout pass, distance from defender

Basic Passing Drills, Guarded and Unguarded

The upcoming drills are suitable for most levels of play. They emphasize accuracy, good form, and bodily movements leading up to a successful pass.

Technique points:

- **Eye-to-eye** contact between passer and receiver paramount.
- Communication between passer and receiver essential.
- Continual movement of the ball and player motion imperative to keep the defense off-guard.
- Dry pass reception – fingers spread, decelerate the ball into the passing motion. (Fig. 4-22)
- Body position for passing and reception – hips behind, strong eggbeater, soft hands – always ready to shoot the ball off from the pass (immediately upon reception).
- Distinction between wet area pass and dry in-the-hand pass essential; knowledge of what an assist pass is and where it must be thrown. Wet area passes usually made to receivers that are closely guarded or not ready to shoot; dry passes to a potential shooter. (Fig. 4-23)

Passing Drills

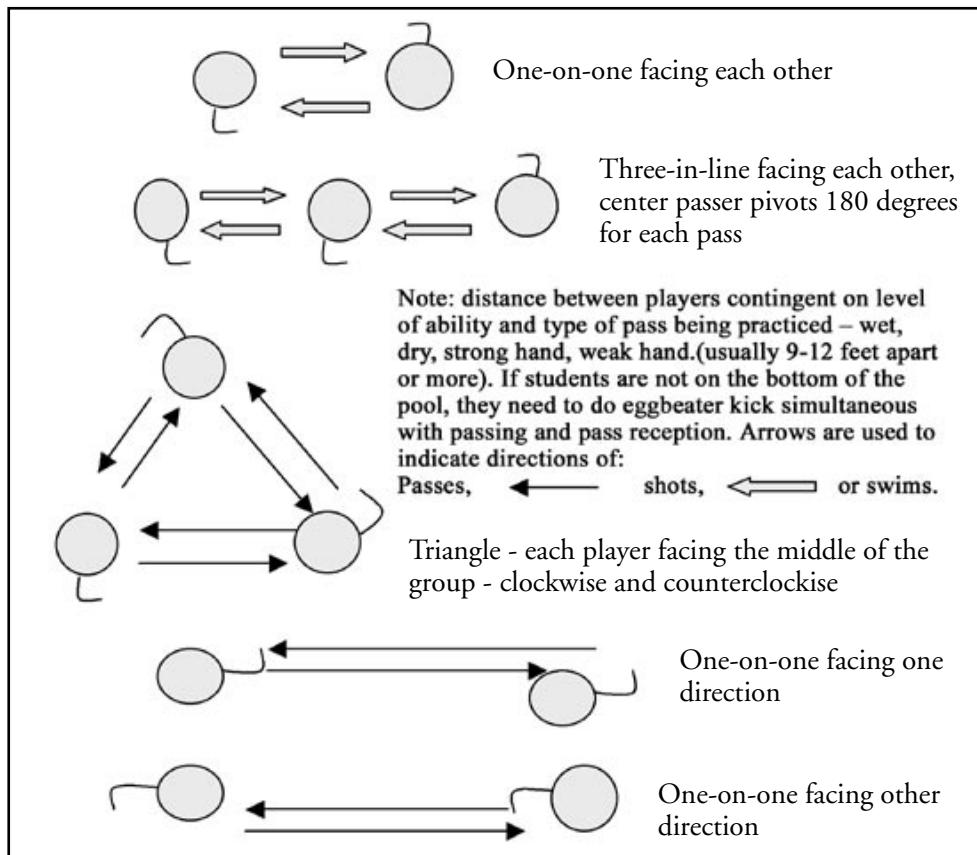

Fig. 4-22. Suggested Basic Static Passing Formations

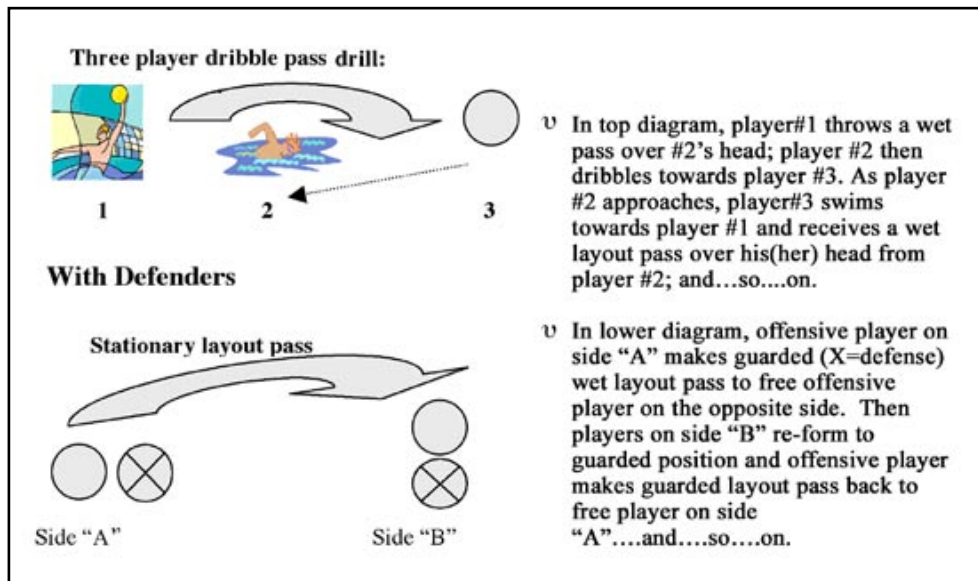

Fig. 4-23. Suggested stationary and mobile passing drills – objectives: looking for ball always, passing with pressure, accurate wet (area) passes.

References:

Cutino, Peter J. and Bledsoe, Dennis. Polo: The Manual for Coach and Player. Los Angeles: Swimming World, 1976.

Cutino, Peter J. Sr. and Cutino, Peter J. Jr. 101 Offensive Drills. Monterey: Coaches Choice, 2002.

Lambert, Arthur and Robert Gaughran. The Technique of Water Polo. North Hollywood, CA.: Swimming World Publications, 1969.

Newland, Edward H. "Fundamental Skills and Concepts for Defense and Offense," Southern California All Sports Clinic, May 1990.

Gallo, Rezso and Somlai, Ivan. Coaching Water Polo. Ottawa: Canadian Water Polo Association, 1977.

Individual Offensive Skills – Team Offense

The mesh between six offensive players and their efforts to score requires teamwork and practice on basic patterns. This coordination and the end product – a high percentage shot – is the focus of this chapter.

Where to Shoot, Targets On the Goal (see goalie Fig. 5-1 below)

Shooting, though an individual skill, is included as part of team offense because the shot is often set up by a good pass as a result of good teamwork

Technique points:

- Players should focus on a spot to shoot at that is open and strive for accuracy first, speed second. (Fig. 5-2)



Fig. 5-1.



Fig. 5-2. Eyes on target while shooting

www.sportsworld.photorelect.com

CHAPTER 5

Individual Offensive Skills – Team Offense



Stanley Hu, www.sportsworld.photorefect.com

Fig. 5-3. Follow thru on shot

- In general, low shots should be taken when closer to the goal (<5m.); any shots that are “skipped” on the water with backspin should have the ball bounce start < 1m. from the cage.
- High shots should be taken from a further distance (>6m.). (Fig. 5-3)
- Over the head shots should be mid-range or closer (<5m.).
- Under the arm shots should be closer to the goal (<4m.).
- Lob shots should be taken from the corner angles and not within the confines of the goal posts to allow more space to shoot towards.
- Cross-cage shots should be taken from the angled (i.e. outside the posts) positions – the goalie will likely cover the near side.

Basic Shooting Drills

There are endless possibilities for these practice situations - all should try to simulate a portion of the game.

Technique points:

- Passing (assist) accuracy and velocity are essential – must know where and how the shooter wants the ball on an assist.
- Players should be equally adept receiving and shooting an assist from their strong side as well as their **cross-face** (draw) side. (see Fig 5-4)
- Firm and dry assist passes should be made on a line so as to optimize beating the goalie and avoid interception.

CHAPTER 5

Individual Offensive Skills – Team Offense



Fig. 5-4. Cross-face reception for Shot or Assist (dark cap, below), with defenders.
Note: fingers spread apart, ready to absorb, decelerate and draw the ball back

- Shooters should try to take shot directly after receiving the passed ball so as to **beat the goalie**. A pass always travels faster than the goalie crossing the cage.
- Players should get in the habit of continuing the drill rather than admiring their shots; **watching shots not** a good routine to get into.
- Player movements and passes should simulate game situations as much as is possible.
- Drills should include defensive players on occasion to **simulate** game-like patterns.
- All pass placements previous to the assist important – assist maker should not have difficulty getting to the ball.

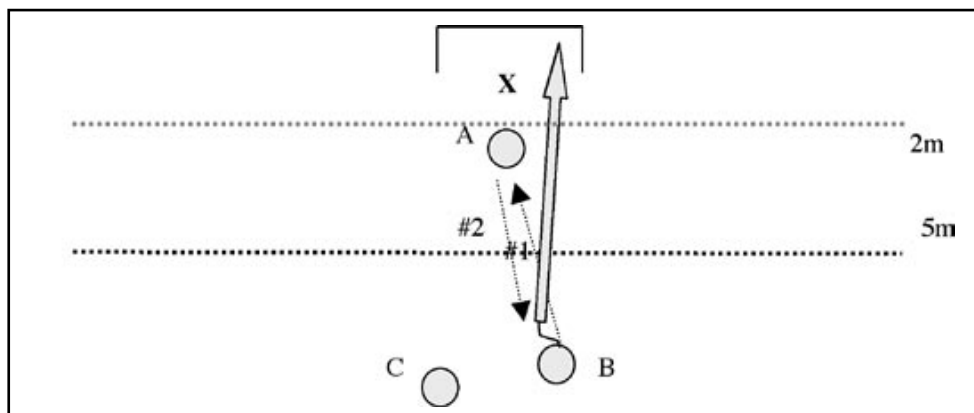

Fig. 5-5. "R.B." Shooting

Player "B" passes wet pass (#1) to player "A" and swims in a few strokes; player "A" returns a dry pass (#2) to player "B", for a shot. Player "C" forms the line of shooters.

CHAPTER 5

Individual Offensive Skills – Team Offense

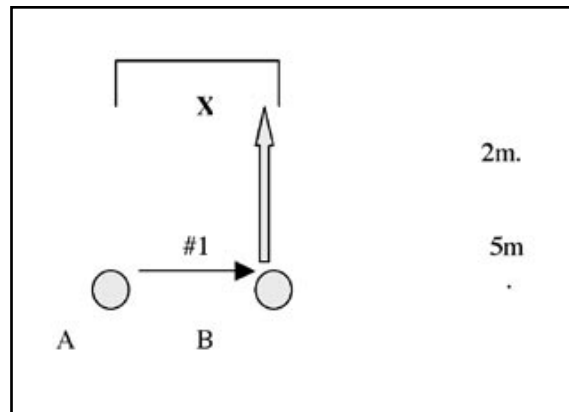

Fig. 5-6. "Cross-pass, shot"

Player "A" passes dry pass (#1) to player "B" who takes a shot.

Lines form behind players "A" and "B".

Assists and shots can be taken from either side.

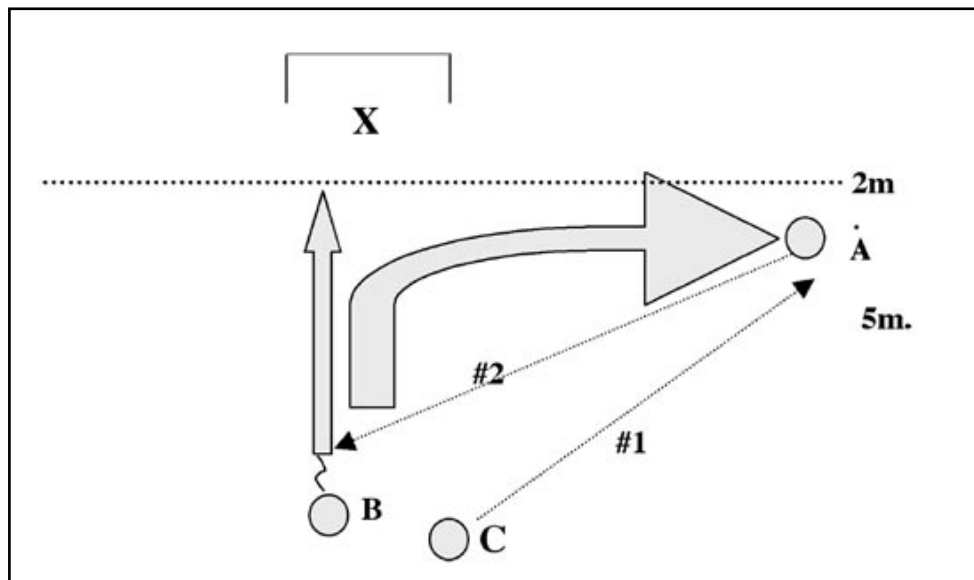

Fig. 5-7. "Hook and shoot"

- Player "C" passes wet area pass (#1) to player "A" at the end of his(her) wing square-out, who then throws a dry assist pass (#2) to player "B" for a shot.
- Player "B" then swims the same pattern to the wing and receives a wet pass from the next player in line, and...so...on.

VARIATIONS:

- Drill can be done with wet pass to wing and dry pass to shooter or wet pass to wing and wet pass to shooter.
- Drill can start with player "A" going to opposite (right-hander's) wing to start the sequence.
- Drill can add a second wing – forming a TRIANGLE – with two dry passes before assist and shot.
- Drill can add a flat/wing (2-1) pick on the right-hander's wing with a 2m. player making the assist after a wet entry pass.

CHAPTER 5

Individual Offensive Skills – Team Offense

- Pass **reception** prior to shooting essential – “don’t shoot before you catch it” – as clean and fluid as is possible while decelerating the ball; pass should continue momentum to be part of shooting motion; “soft” hands; flexible arms and shoulders. Like a football player – “don’t run before you catch the ball.”
- Players should learn and practice at least ONE **wet**, drive-in shot (push, pop, back-hand) with defenders so that they develop confidence and can score this in a game. (Fig. 5-8, 5-9)
- **Faking** is a necessary part of shooting; Players should be able to rapidly move the ball through half of their shooting motion and draw the ball back behind their heads – this must be a realistic motion resulting in an equal movement by the goalie.

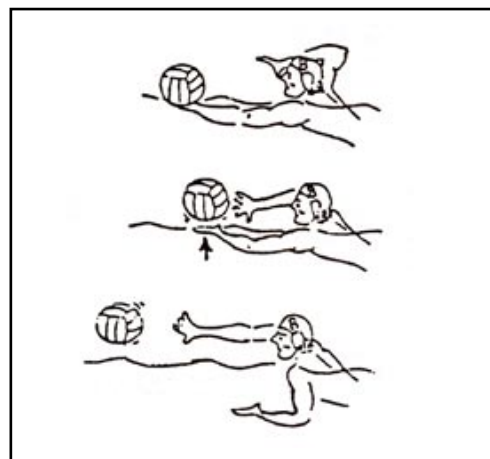

FINA Water Polo Manual, 1990, p.16

Fig. 5-8. Pop shot

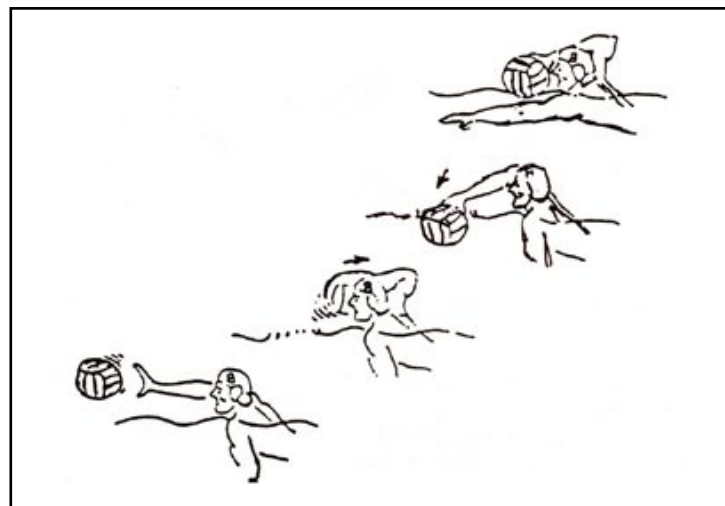

FINA Water Polo Manual, 1990, p.16

Fig. 5-9. Push shot

CHAPTER 5

Individual Offensive Skills – Team Offense

Two-meter Offense (also know as “hole”, “set”, #6) Responsibilities, Shots

The two meter player, much like a center in basketball, is a specialist who is usually expected to be able to shoot, pass, and absorb fouls from this closest position to the opponents cage.

*Technique points - This **player**:*

- Will touch the ball more than any other on offense because (s)he is in the middle and in direct proximity to the cage, therefore must be a good **ball handler**.
- Will need to **establish** an area for the perimeter (1,2,3,4,5) players to make an entry pass to. (S)he will need to absorb fouls. (Fig. 5-10, 5-11, 5-12)



Joan Gould, www.waterpoloplanet.com

Fig. 5-10. Establishing Two-meter Position (white cap = offense)



Joan Gould, www.waterpoloplanet.com

Fig. 5-11. Creating a two-meter entry pass area (dark cap = offense)

CHAPTER 5

Individual Offensive Skills – Team Offense



Joan Gould, www.waterpoloplanet.com

Fig. 5-12. Backing in, establishing two-meter set position (white cap) – notice eggbeater kick

- Will likely take more **physical** contact than any other player on offense and therefore need more body strength leg strength, and poise. (Fig. 5-13, 5-14, 5-15)
- Should have different types of **shots** to use as (s)he is in an optimal area to score. There will be a few possible decisions – thus the 2m.player must think. (Fig. 5-16, 5-17)
Basic shots include sweep, backhand, and layout motions. (Fig. 5-18)
- Should be able to pass effectively to his(her) teammates in the perimeter positions or to another set (2m.) player; and be able to use **either hand**.
- Should be able to turn with the ball to either side and face the goal – this requires strength and aggressiveness. (Fig. 5-19, 5-20)



Joan Gould, www.waterpoloplanet.com

Fig. 5-13. Absorbing the foul upon entry pass, preparing to shoot or pass (dark cap = offense)

CHAPTER 5

Individual Offensive Skills – Team Offense



Newzealandwaterpolo.com

Fig. 5-14. Absorbing the foul, entry pass to two-meters, stepping to ball (dark cap)



Joan Gould, www.waterpoloplanet.com

Fig. 5-15. Absorbing the foul, entry pass to two-meters, stepping to ball (white cap)



Athens2004.com

Fig. 5-16. Backhand shot preparation, right-handed (dark cap)

CHAPTER 5
Individual Offensive Skills – Team Offense



Joan Gould, www.waterpoloplanet.com

Fig. 5-15. Backhand shot preparation, right-handed (dark cap)

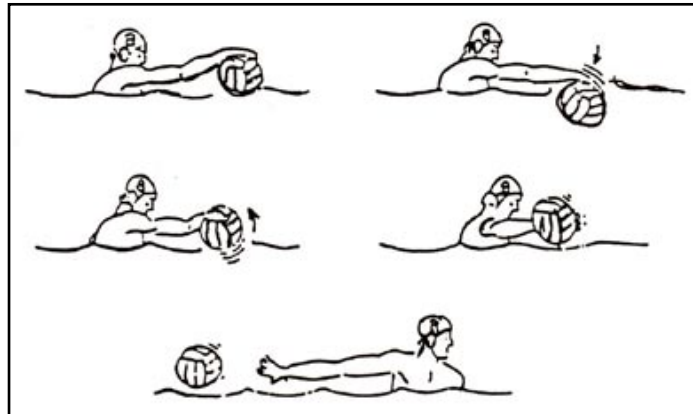

FINA Water Polo Manual, 1990, p.15

Fig. 5-15a. Backhand shot.



Joan Gould, www.waterpoloplanet.com

Fig. 5-16. Turning to face the cage, right-handed (white cap)
During turn moves, be cautious to avoid offensive foul call due to above-water contact.

CHAPTER 5

Individual Offensive Skills – Team Offense



Matt Brown, mattbrownphoto.com

Fig. 5-17. Turning with ball: defender guarding closely

Additional notes on two-meter shooting:

- Two meter players need to step out towards the ball to get distance from their defender. (Fig. 5-15)
- For each of the basic three shots – backhand, forehand, and layout – the two meter player must have a smooth pick-up to be able to shoot quickly – there will likely be an outside defender coming towards him(her).
- Positioning in relation to the cage is essential; as close to the middle of the cage as possible and leaving as much of the rectangle to shoot at.
- Quickness is more important than accuracy - depending on closeness to the cage; the goalie has very little time to react and the less time, the better.
- If the entry pass is not to a good spot, it is better to receive the foul and pass out, to a driver or to another hole set.
- Practice, practice, practice shots– both with and without defense and goalie.

Half – Court (Set) Offense

At the conclusion of the fast break, a team's effort at utilizing the 20-24 seconds of possession time is much dependent on their ability to position, drive and pass the ball for an ejection or high percentage shot. Upcoming are various formations to attempt a successful half court offense.

Note: The above formation is a “basic” three-three balance of the offensive players, also known as an “umbrella.” There are many variations to this; but, these are the numbers that will be used here. (Fig. 5-21)

CHAPTER 5

Individual Offensive Skills – Team Offense

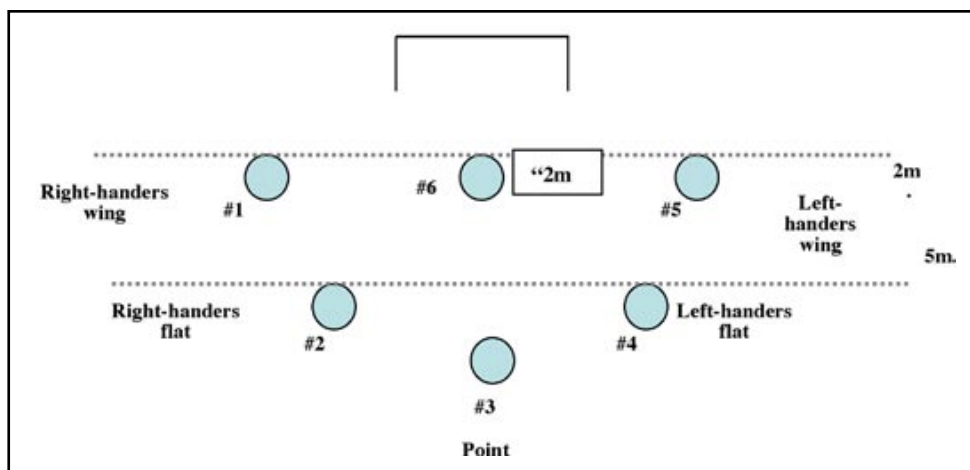

Fig. 5-21. Front Court Offense position names and numbers

Technique points:

Half court offenses need to keep spread so that one defender cannot guard two offensive players. The offense also needs to adjust to the type of defense being confronted – pressing, sloughing, etc. Constant player and ball movement is essential, as is:

- Eye-to-eye contact between passer and receiver.
- Accurate wet and dry passes (two meter players must know what their “wet” and “dry” side passes are to their teammates).
- Good fakes on and consciousness of the goalie.
- Awareness of the possession and game clock times.
- High percentage shot selection.
- Verbal communication regarding being open and seeing opportunities.

Two Basic Offensive Patterns

The two styles of front court offense require motion on the part of the five perimeter players. The driving style emphasizes drives towards the goal and the pick style crossing patterns and screens. The goal of each offense is a “good” shot.

Driving Style offense (Fig. 5-22, 5-23)

Pick-style offense (Fig. 5-24, 5-25)

CHAPTER 5

Individual Offensive Skills – Team Offense

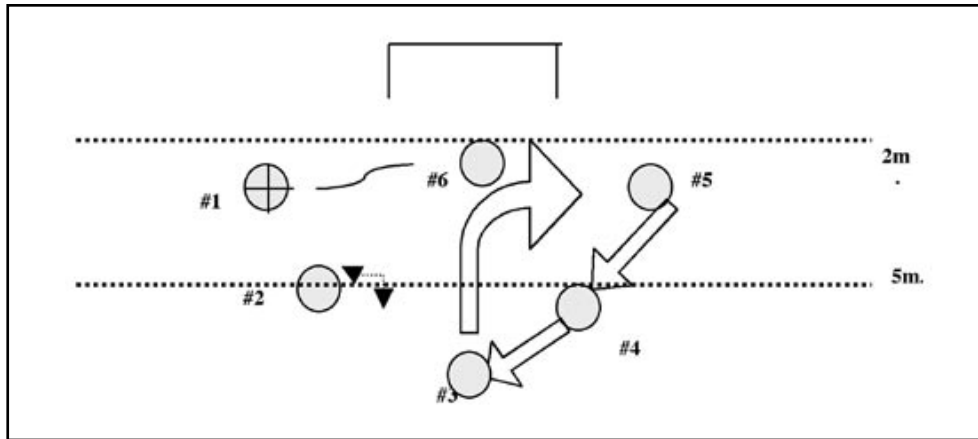

Fig. 5-22. #1. Point drive

Upon the wet pass from player #1 to player #6, player #3 drives head-up towards #6; if (s)he doesn't receive a pass from #6, (s)he goes immediately out towards player #5, then player #5 rotates towards #4, and player #4 rotates to fill the hole created by player #3's drive....and..so..on. (note: players #1 and #2 do "V-outs" @ the same time.) The same driving pattern can be done towards the #1 side when player #5 makes entry pass. NOTE: never drive into the 2m. entry passing lane.

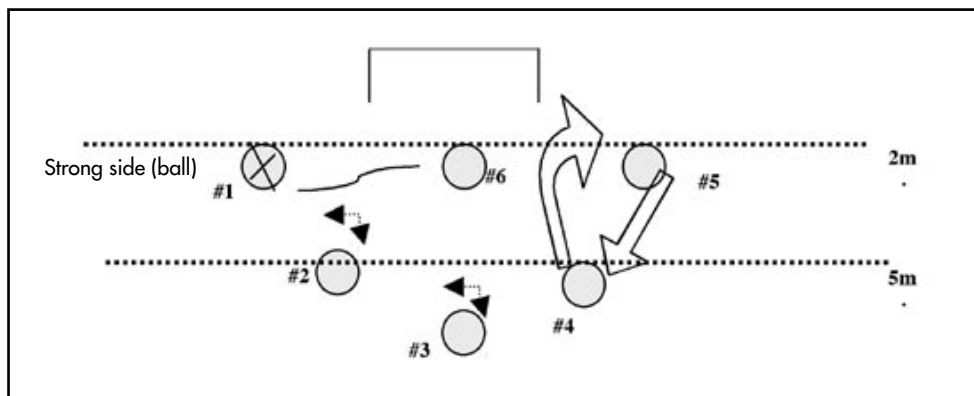

Fig. 5-23. #2. Weak side flat drive offense

Upon the wet pass from player #1 to player #6, player #4 drives head-up towards #6; if (s)he doesn't receive a pass from #6, (s)he goes immediately out towards player #5, then player #5 rotates towards #4 to fill the hole created by player #4's drive....and..so..on. (note: players #2 and #3 do "V-outs" @ the same time.) The same driving pattern can be done towards the #1 side when player #5 makes entry pass.

NOTE: never drive into the 2m. entry passing lane.

CHAPTER 5

Individual Offensive Skills – Team Offense

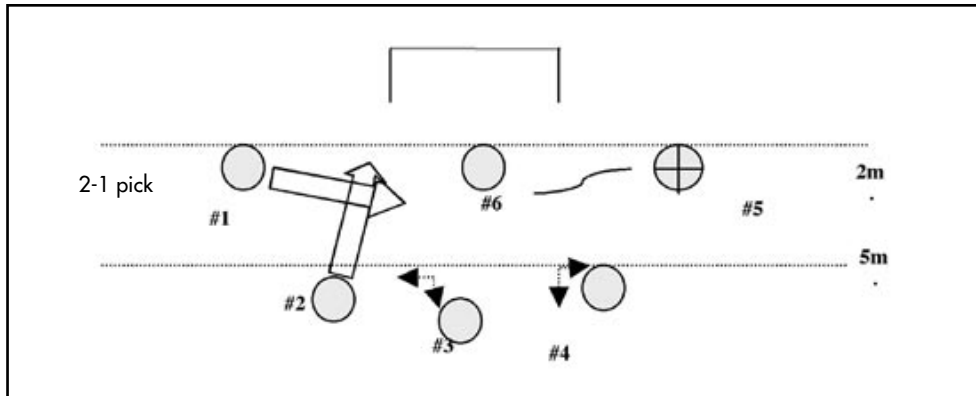

Fig. 5-24. #3. Pick style offense

To create an open player off from a driving pick, player #2 drives towards the goal when the wet entry pass is made to player #6, and, in sequence, player #1 swims across his(her) hips to create confusion for the defense and a likely open passing lane to either player #1 or #2. This combination can be done in the same fashion with players #4 and #5 – especially if there is a left handed player(s) on that side. These picks can also be done between “2” & “3”; and “3” & “4.” The remaining players not involved in the pick do “v-out” movements to be available for perimeter or 2m. passes.

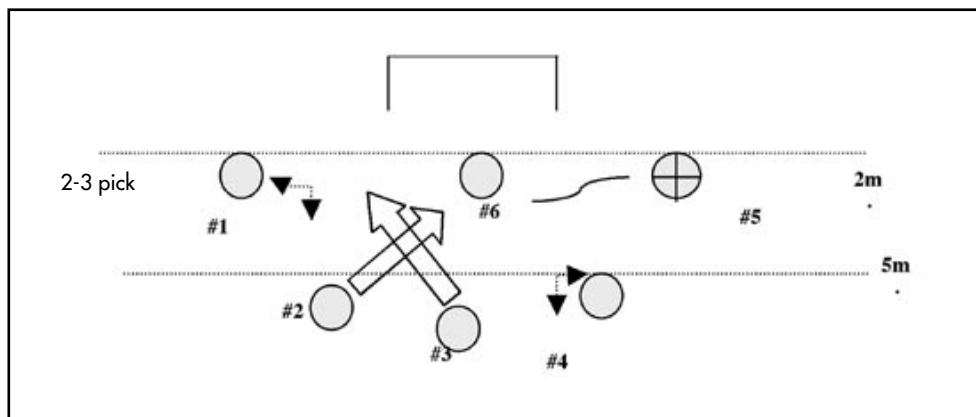

Fig. 5-25. #3a. Pick style offense

To create an open player off from a driving pick, player #2 drives towards the 2m player when the wet entry pass is made to player #6, and, in sequence, player #3 swims across his(her) hips to create confusion for the defense and a likely open passing lane to either player #2 or #3. This combination can be done in the same fashion with players #3 and #4 – especially if there is a left handed player(s). The remaining players not involved in the pick do “v-out” movements to be available for perimeter or 2m. passes.

CHAPTER 5

Individual Offensive Skills – Team Offense

References:

Barnett, Bill. "Basic Water Polo Concepts: Offense." Irvine, Ca: National Swimming & Water Polo Clinic, (1994): 15-20.

Op. cit. United States Water Polo: Level Two Manual. Colorado Springs: USA Water Polo, 1996: 20-44.

Cutino, Peter J. and Bledsoe, Dennis. Polo: The Manual for Coach and Player. Los Angeles: Swimming World, 1976.

Cutino, Peter J. Sr. and Cutino, Peter J. Jr. 101 Water Polo Offensive Drills. Monterey, Ca: Coaches Choice, 2002.

Hale, Ralph M.D. ed. The Complete Book of Water Polo. New York: Simon & Schuster, 1986.

Gaughran, Robert and Arthur F. Lambert. The Technique of Water Polo. Los Angeles, Swimming World, 1969.

Heidmous, Jeff. "Perimeter Shooting." Long Beach, Ca: N.C.A.A. YES Water Polo Clinic, 1991.

Hinman, Scott. "Front Court Offense." Walnut, Ca: FCCAT Water Polo Camp, 2005.

Newland, Edward H. "Fundamental Skills and Concepts for Defense and Offense." Irvine, Ca: National Swimming & Water Polo Clinic, (May 1990): 1-3.

Nitzkowski, Monte. United States Tactical Water Polo. Pittsburgh, Pa: Sports Syndicate, 1994.

Reed, Edward. "Shooting." Long Beach, Ca.: N.C.A.A. YES Water Polo Clinic, 1991.

Schroeder, Terry. "Being Successful at 2 Meter Offense." Irvine, Ca: National Swimming & Water Polo Clinic (May 1999): 73-76.

Shooting, technique - outside shot: Wigo, Mikasa ad.
<http://www.youtube.com/watch?v=yA4uQxGIU-I>

Shooting, examples -
<http://www.youtube.com/watch?v=4rShVOJ27YQ&feature=related>

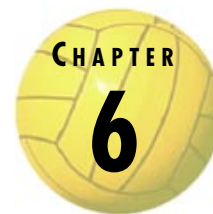

Individual Defensive Skills – Team Defense

“Defense wins championships.....No rebounds, no rings.” Such are the statements of team sports coaches regarding the value of defensive efforts.

To quote five-time Olympic water polo coach Monte Nitzkowski: “It is my opinion that most games are won because of great individual and team defensive skills. Even if the offense is having an ‘off day,’ the defense can carry a team to victory.” (Nitzkowski, p.29) Seven-time N.C.A.A. Water Polo Championship coach Pete Cutino states: “We feel that the most important phase of water polo is defense.” (Cutino, p.44)

This chapter will look at individual and team skills that contribute to good defensive play. Each player should master these skills so as not to be the “Achilles heel” of their team. Players must remember that good defense only occurs when teammates and goalies play together and help each other out when someone is out of position, mismatched, or beaten.

Every player should understand the value of defense and take pride in his(her) ability to contribute to a solid team effort, even though there are few statistics that will give notoriety to his(her) performances. Water polo players don’t need to be blessed with tremendous skills to be able to play defense, just good anticipation, hustle and desire.

Body Position – Player-to-player, Pressure Defense

There are at least two distinct varieties of defense - pressure and/or dropping. This segment will cover the pressing style defense.

*Technique points: **Players:***

- Should recover their bodies as quickly as possible when swimming from offense to defense so that their **hips are on top** or near the surface of the water and **towards the cage**. (Fig. 6-3)
- Should try to show their **hands** as much as is possible when guarding an offensive player to show the referee that they are not fouling and therefore stopping the clock. (Fig. 6-1, 6-2)

CHAPTER 6

Individual Defensive Skills – Team Defense

- Safest defensive position is usually between the player someone is guarding and the cage.
- Should know at least **three** of the following situations all of the time on defense a) where the ball is, b) where the player(s) is(are) that they are guarding, c) where the cage, other defenders and goalie are, and d) the possession clock time.
- Should try to, whenever possible, stay between the ball and the person they are guarding – i.e. **ball-side defense**. This will prevent the offensive player from easily receiving the ball. (Fig. 6-3, 6-4)
- Should always try to swim for position; i.e., to an area **before** the offensive player rather than grab, hold, pull back, etc. the offensive player to obtain an advantageous spot. (anticipate)



Len Wood, lwood@santamariatimes.com

Fig. 6-1. Hands up body position when defending one-on-one (dark cap = defense)



Joan Gould, www.waterpoloplanet.com

Fig. 6-2. Hands up defense, pressing the player with the ball (dark cap = defense)

CHAPTER 6

Individual Defensive Skills – Team Defense



Joan Gould,
www.waterpoloplanet.com

Fig. 6-3. Hips up and towards the cage, watching the ball (dark cap = defense)



Joan Gould,
www.waterpoloplanet.com

Fig. 6-4. Front position guarding 2m., hips up & towards the ball, closely guarding offense (white cap = defense)

Front Court Pressing Defense

All defensive (X) players in graphic on next page are playing “ball side”i.e. they are playing **between** the offensive player with the ball (#5) and the offensive players #1,2,3,4,6 that they are guarding. This effectively denies a pass anywhere else in the pool except the unguarded goalie at the other end. (Fig. 6-5)

Players must constantly look back and forth between the ball and the player they are guarding (“head on a swivel”). On defense, one **cannot assume** that the ball nor the player being guarded will remain stationary for very long. (Fig. 6-7, 6-8)

The player below (white cap#7) is showing body position for guarding a perimeter player and denying her the ball. (Fig. 6-6)

CHAPTER 6

Individual Defensive Skills – Team Defense

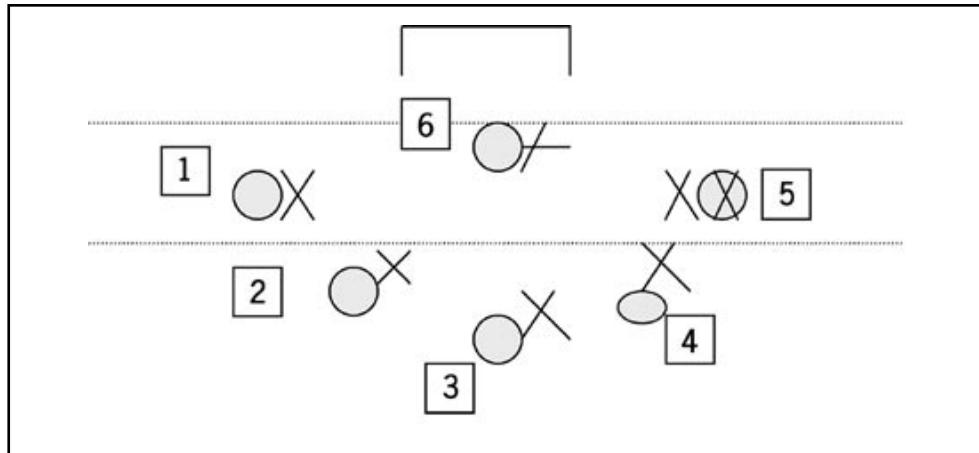

Fig. 6-5. "Ball-side, pressure defense" – offensive player #5 has the ball. (x=defense, O=offense)



Joan Gould, www.waterpoloplanet.com

Fig. 6-6. Hips up and towards the cage – perimeter guarding (white cap #7)



Joan Gould, www.waterpoloplanet.com

Fig. 6-7. Defending the passing lane, i.e. between the ball and the offensive player (defense = white cap)

CHAPTER 6

Individual Defensive Skills – Team Defense



Joan Gould, www.waterpoloplanet.com

Fig. 6-8. Guarding driver on the perimeter, hips up and towards the cage, watching ball (white cap= defense)

Pressuring the Ball

Marking the ball makes it less easy for the passer to see his(her) receivers.

Technique points:

- Try to match the defenders hand to the passers hand. (Fig. 6-9, 6-10)
- Continuous eggbeater motion necessary while moving towards the ball.
- Avoid unnecessary fouls which stop the clock and give a free pass; but, at the same time adequately press the pass.
- Keep hips up on the surface to avoid being “turned.”



Joan Gould, www.waterpoloplanet.com

Fig. 6-9. Matching Hands – defender’s (white cap) left, passer’s right



Fig. 6-10. Extending arm to the ball to hinder passer (dark cap)

Guarding the Two-Meter Player

This “match up” is usually pre-assigned before the scrimmage or competition begins. Players usually have a designated role as a two-meter offense or defense player, though all players should learn how to defend the two meter position.

Technique points:

- Don't concede a beneficial position for the offense (strike zone). Try to force him(her) as far away and off-center as is possible. **Eggbeater strength** is essential guarding this position.
- Try to stay ball side for as long as there is adequate pressure on the ball as it advances down the pool.
- Keep distance from the offensive player. If you are too close with any portion of your body, this is a form of leverage (s)he will use to position (him)herself. Most especially, **HIPS must be UP** while guarding this player so as not to be “turned.” (Fig. 6-11)
- This is a thankless task; you must be willing to put up with physical contact and continue to strive to avoid a disadvantageous position – i.e. behind the 2m.offense.
- Minimize the shots your goalie must cover; for most offensive 2m.players, this means giving the backhand shot side – i.e. playing on the power side shoulder. (left shoulder for right-handed 2m. players, right shoulder for left-handers)
- When an entry pass is made, make an equal effort to reach the ball as does the offensive player; try to stay to the side of the offensive player – i.e. **NOT over** the top of (him)her. (Fig. 6-12, 6-13)

CHAPTER 6

Individual Defensive Skills – Team Defense

- When making contact with the 2m.offense, try to check (him)her in the low torso so as to keep the player off-balance and move (him)her to a less advantageous scoring position.
- Referees calls must be **adjusted** to; each referee typically has slightly different interpretations of what an ejection foul will be. Listen for the whistle as you foul the 2m. player; back off and reposition ball-side once you hear the whistle.



Joan Gould,
www.waterpoloplanet.com

Fig. 6-11. Hands up 2m. defense (white cap)



Joan Gould,
www.waterpoloplanet.com

Fig. 6-12. Moving to the side position, two-meter guard (white cap)



Joan Gould,
www.waterpoloplanet.com

Fig. 6-13. Fouling two-meters, moving to side (dark cap = defense)

CHAPTER 6

Individual Defensive Skills – Team Defense

Field shot blocking, zone defense skills

Dropping/zone: norm. This next section will cover aspects of the dropping defense, where defenders are responsible for areas of the pool in addition or instead of pressuring the offense. This “match up” is usually pre-assigned before the scrimmage or competition begins. Players usually have a designated role as a two-meter offense or defense player, though all players should learn how to defend the two meter position.

Technique points- Field players should:

- Extend one arm straight up over head and walk (eggbeater) towards the shooter – narrowing his(her) angle on the cage, do not waive arm. (Fig. 6-14)
- Listen to goalie commands – whether to press the offensive player or not.
- Funnel all shots to the middle of the cage so the goalie has fewer square feet to cover. (Fig. 6-15, 6-16)



Joan Gould, www.waterpoloplanet.com

Fig. 6-14. Field player (dark cap) arm extension, up on hip, walking towards shooter – listen to goalie commands



Joan Gould, www.waterpoloplanet.com

Fig. 6-15. Funneling shots to the center of the goal, matching arms (defense = white cap)

CHAPTER 6

Individual Defensive Skills – Team Defense



Kitredge, www.tudorgraphics.com

Fig. 6-16. White cap #3 matching arms with player @ 3 spot – point position

- When shot taken, try to absorb with middle of forearm, not hand or fingers (tipping).
- Try to rotate over the hip in order to increase range when moving body towards the shooter.

Sloughing and Crashing

This “match up” is usually pre-assigned before the scrimmage or competition begins. Players usually have a designated role as a two-meter offense or defense player, though all players should learn how to defend the two meter position.

Technique points:

- Perimeter defensive players should look back to the 2meter match-up and see if the guard needs help.
- A “**crash**” is made by the defensive player swimming toward the entry pass as it is being made to two meters; a “**slough**” can occur anywhere in the pool before the pass or shot.

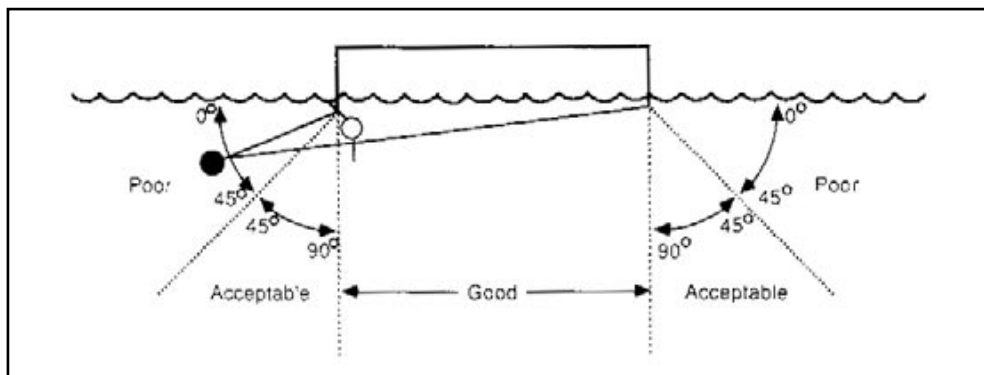

Fig. 6-17.

From: Heaston, Steve and Figueroa, Gary. "Shooting", Chapter 12. The Complete Book of Water Polo.

CHAPTER 6

Individual Defensive Skills – Team Defense

- The angled portions of the pool are typically the best areas to crash and slough from because these shots typically do not have as high percentage of scoring. (Fig. 6-17)
- Perimeter players should swim head-up freestyle with quick choppy strokes when crashing to get to the two meter entry pass before the 2m.offensive player; if no whistle is heard designating a foul, the crasher should swim through the ball and dribble it to a safe area (on the outside). (Fig. 6-18)



Fig. 6-18. Crashing to the two meter area to prevent a shot (white caps #8 and #12)

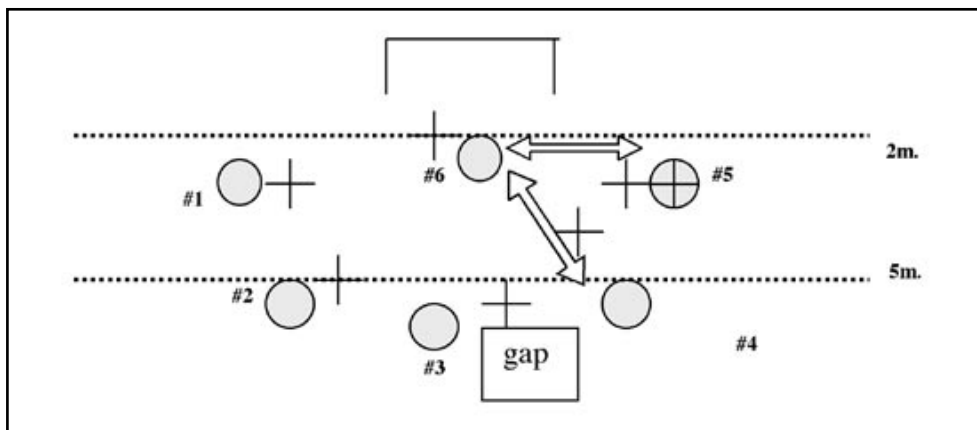

Fig. 6-19. #2. Perimeter slough/crash: 4-5 drop

The objectives of sloughing, dropping, and crashing from the perimeter are to: encourage a poor angle shot (see previous page), prevent a shot from 2m., and force the offense to make drives and accurate passes to be able to beat the goalie with a shot. There are many variations of this defense. The 4-5 drop/crash, shown above, takes place between the defenders of the 4 and 5 spots. When "5" has the ball the "4" defender drops and when "4" (or 1, 2, or 3) has the ball the "5" defender drops. It is a "teeter-totter" between the two defenders. A defender crashes when the ball is passed to 2m. This is most effective when there are right-handed players at "4" and "5". Notice that the other defenders #1, 2 are in the passing lanes to prevent cross-passes! The #3 defender is playing in the "gap" as well – another form of partial zone defense.

CHAPTER 6

Individual Defensive Skills – Team Defense



Fig. 6-20. 5 drop defense, dark caps = defenders

- There are many combinations and variations of the partial zone dropping/sloughing/crashing type of defense. All involve the defenders covering more than one offensive player and an area of the set offense. The goalie must be prepared for outside shots when this defense is utilized. Above is an example of one variety of this defense. (Fig. 6-19, 6-20)

Other Individual Defensive Moves

Technique points: Water polo is a team game therefore no player should assume that (s)he only has the responsibility (unless so designated) to guard one player the whole time. The best defenses always have all seven players looking to help each other. Examples of individuals include:

- Switching - used **any** time a defensive player is in a disadvantageous position (i.e. behind the offense); or, if there is a mismatch between the offensive and defensive players. Can be used effectively on counterattack defense and in the set defense. For example, in the diagram below, the defender of player #4 switches over to #3 take away his(her) offensive advantage. (Fig. 6-21)
- Stair-stepping (ladder-down) – used when the offensive players are lined up towards the offensive end rather than in an arc and spread. This allows the defense to double-team an offensive player, with or without the ball, from behind and perhaps steal the ball or deflect the pass or shot from behind. (Fig. 6-22, 6-23, 6-24)
- Foul-and-drop – used to help or double-team on another offensive player. Immediately after fouling, the defensive player swims to an area to prevent a pass to an open player. The fouled player has a free throw and cannot shoot (unless outside 7m. or 5m.) and therefore must find a different teammate to pass other than the open one. (Fig. 6-25, 6-26)

CHAPTER 6

Individual Defensive Skills – Team Defense

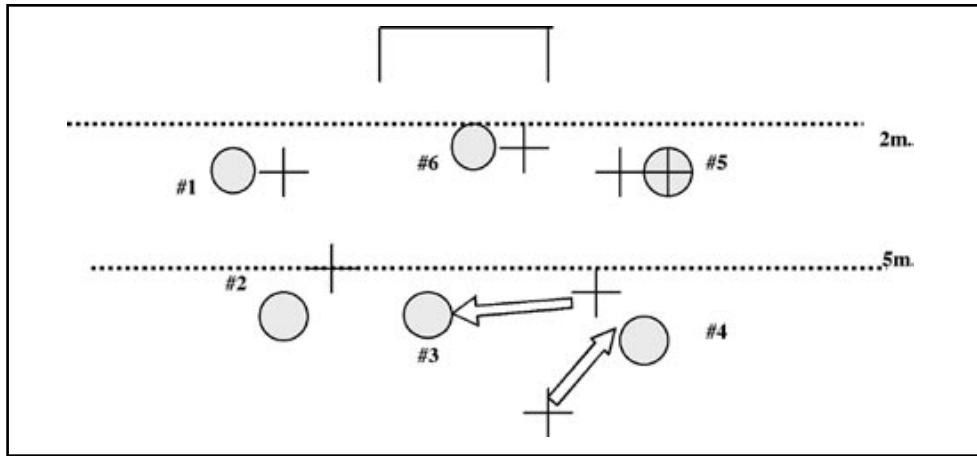

Fig. 6-21.



Joan Gould,
www.waterpoloplanet.com

Fig. 6-22. White caps = offense, dark = defense: dark cap # 8 looking to "stair step" on white cap #5

Note: possible "switch" needed in the sequence above between defensive players #6 & #8 to avoid the offensive pick.



Joan Gould,
www.waterpoloplanet.com

Fig. 6-23. Double-team or stair-stepping the dark cap offensive player #10

CHAPTER 6

Individual Defensive Skills – Team Defense



Chris Kittredge, www.tudographics.com

Fig. 6-24. Stair-stepping on #3 spot – two blue caps on one white @ point position



www.newzealandwaterpolo.com

Fig. 6-25. Foul and drop – white cap #12 making perimeter foul so that dark cap #13 cannot shoot the ball.



Jean Gould, www.waterpoloplanet.com

Fig. 6-26. Drop – dark cap #6 dropping after foul

- Gapping – occurs anywhere in the set defense when a defender moves to an area between two offensive players and attempts to cover both by moving between them quickly. In the diagram below, the defenders of #2 and #3 have “gapped” between the 2, 3, and 4 players, thereby allowing the #4 guard to double-team another player, if necessary. (Fig. 6-27, 6-28; note: defender should have hips on surface towards cage)

CHAPTER 6

Individual Defensive Skills – Team Defense

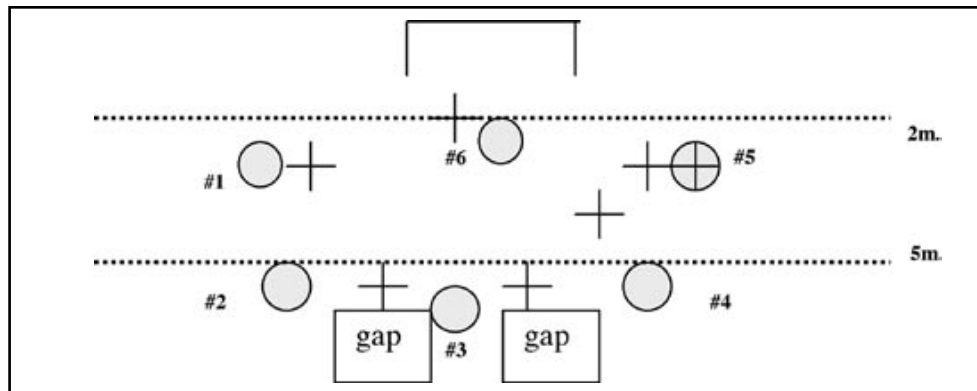

Fig. 6-27.



Mike Sandford

Fig. 6-28. Defender “gapping” between two offensive players, likely at the 2 & 3 spots (white cap = defense)

- Fronting - Defender stays in the passing lane between the player with the ball and the 2m. player (or any other potential receiver) to deny this player the ball. This can be done front-to-front, hips up; or, back-to-front so as to look for the ball, as in photos below. (Fig. 6-29, 6-30)



Joan Gould
www.waterpoloplanet.com

Fig. 6-29. White cap#11 fronting dark cap, front-to-front

CHAPTER 6

Individual Defensive Skills – Team Defense



Joan Gould, www.waterpoloplanet.com

Fig. 6-30. Back-to-front, dark cap #9 defense looking to ball and fronting versus white cap #8



Joan Gould, www.waterpoloplanet.com

Fig. 6-31. White cap #7 below takes an extra stroke to move between dark cap #11 and the goal

- Extra-stroke - An effort by the defender to swim to a spot and beat the dribbler or driver so as to avoid a disadvantageous position and possible ejection foul. (Fig. 6-31)
- Baiting: encouraging an interceptable pass. Defender places (his)her body in a position in or near a passing lane which disguises and allows the possibility of a steal.
- Foul-to-steal: pressing very tightly on the ball and trying to strip the offense of the ball. Typically done when a team is behind in a game and trying to get a quick score.
- Jamming & Stunting: moving back and forth between the ball and other open offensive players to try to slow the ball down and allow a teammate(s) to catch up. In the diagram

CHAPTER 6

Individual Defensive Skills – Team Defense

below, defensive player “b” jams and stunts between offensive players #3 and #4 to try to slow down the ball and allow defensive player “c” to catch up. (Fig. 6-32)

- Spinning - defender turns his(her) body so as not to be held by offensive player. Important move for the defender to avoid an ejection foul or a 2m.shot. This move is particularly important for women players, as there is more swim suit material for the offense to make contact with. (Fig. 6-33)

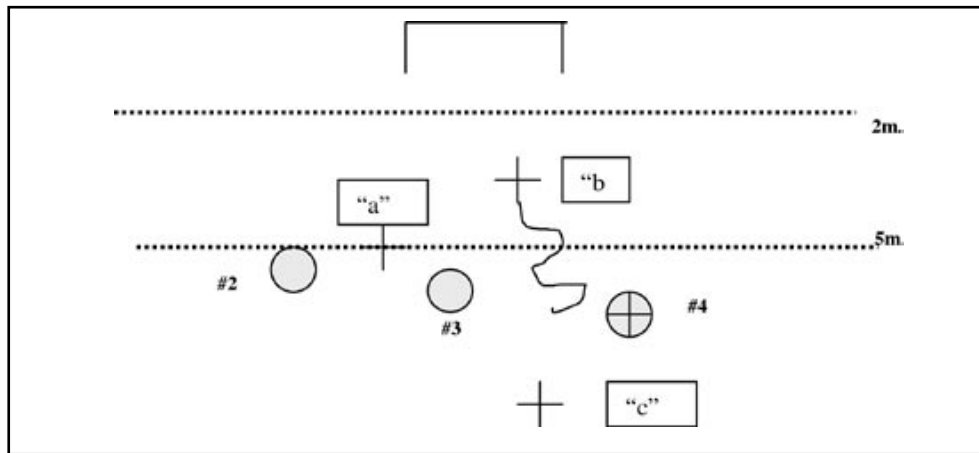

Fig. 6-32.



Joan Gould, www.waterpoloplanet.com

Fig. 6-33. Defensive player dark cap #4 twists (spins) to get free from grasp of offensive player white cap #4

CHAPTER 6

Individual Defensive Skills – Team Defense

References:

Barnett, Bill. "Defense," in Hale, Ralph M.D. ed. *The Complete Book of Water Polo*. New York: Simon & Schuster, 1986.

_____. *United States Water Polo Level Two Coaching Manual*. Colorado Springs, Co: US Water Polo, 1996.

Comer, Lynn, "Defense: Team and Individual" Mission, Kansas: NCAA, NCAA Yes Clinic, 1988.

Corso, Richard, "Attacking with Multiple Defenses," unpublished paper, USA Water Polo, 1990.

Cutino, Peter J. and Bledsoe, Dennis. *Polo: The Manual for Coach and Player*. Los Angeles: Swimming World, 1976.

Gaughran, Robert and Arthur F. Lambert. *The Technique of Water Polo*. Los Angeles, Swimming World, 1969.

Loughran, John. "Team Defense," Long Beach, Ca: NCAA Yes Clinic, 1993.

Nitzkowski, Monte, "Defending the two meter offensive specialist," *Water Polo Scoreboard*, 6.1 (January/February 1991): 23

Schofield, Mike, "Individual and Team Defense," Long Beach, Ca.: NCAA Yes Clinic, 1991.

Tanner, John, "Front Court Defense," Long Beach, Ca.: NCAA Yes Clinic, 1992.

Basic Water Polo Rules

As covered in Chapter 1, the history of water polo is replete with rules changes and differences in rules from one continent to the next. In the United States, there was a long period where the Americans didn't play by the European and F.I.N.A. rules at all (circa. 1890-1910), then only during the summer Club season (circa 1950-1975) and now, the two sets – N.C.A.A. and F.I.N.A. are very similar.*

Field of 1 Play

Water polo is played in a pool with a course that is either 30m. X 20m.for men or 25m. X 20m. for women. The minimum depth of the pool should be 6.5 ft. (Fig. 7-1)

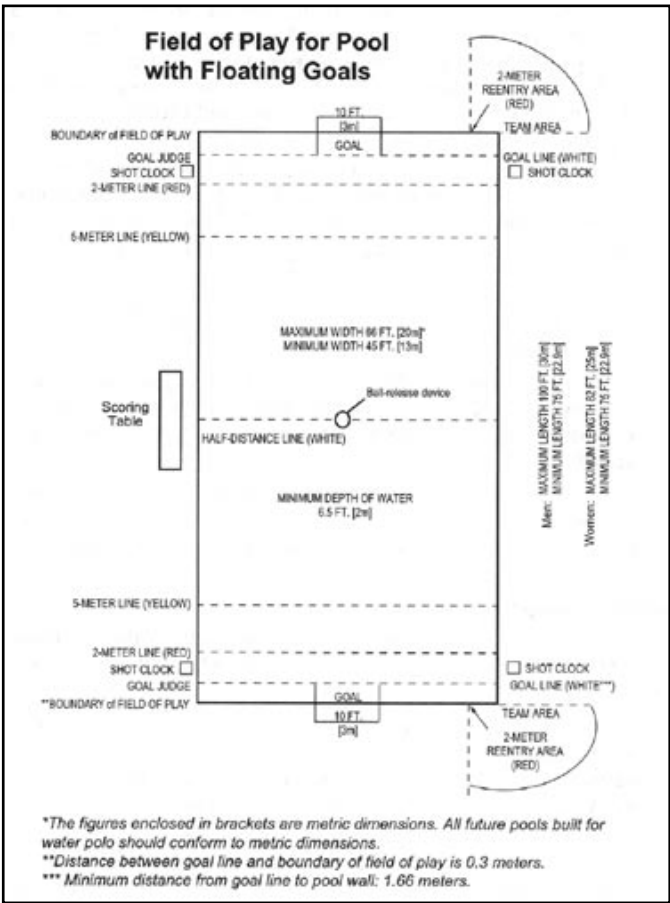

Fig. 7-1.

CHAPTER 7

Basic Water Polo Rules

Markings on the pool and their significance are as follows:

Red: 2meter line – an offensive player inside the 2m.line without the ball or ahead of the ball is offside (ordinary foul).

Yellow: 5 meter line – a major foul within the 5m.line may result in a penalty shot; and an offensive player may take a direct shot after an ordinary foul if beyond this line.

White: Half distance line – players line up after a goal and the goalie may not touch the ball past this line.

* Note: see end of chapter for current differences between N.C.A.A. and F.I.N.A. rules.

Classification of Fouls

There can be unlimited fouls of a certain variety in water polo. Most of the fouls committed are termed “ordinary.” The penalty for this type of foul is a “free throw” given to the player who was fouled; or, if committed by the offense, given to the closest player on the opposing team.

Examples of these types of *ordinary* regular infractions (unlimited), are:

- Placing the ball under water. (see sequence below): when a defender presses down on the offensive player’s hand and (s)he is in contact with the ball. If the offensive player is without contact, it is allowable to take the ball under water. (Fig. 7-2, 7-3, 7-4)

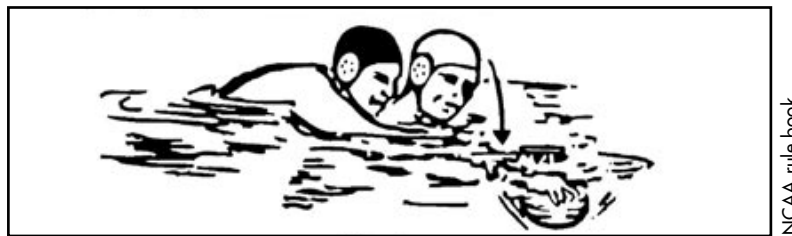

NCAA rule book

Fig. 7-2.



Joan Gould,
www.waterpoloplanet.com

Fig. 7-3. Ball under example part 1 – white cap defender reaching over offensive player (#2) with her hand on top of the ball



Joan Gould,
 www.waterpoloplanet.com

Fig. 7-4. Ball under part two- total submergence of yellow sphere

- Making contact with a player who is not in control of the ball. (Fig. 7-5)

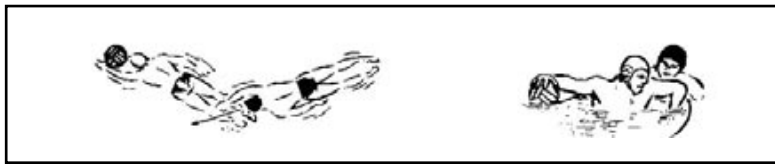

NCAA rule book

Fig. 7-5.

- Going inside the opponents' two-meter area on offense without the ball going first.
- A player's cap coming off – not called until capless player's team on offense; stoppage of play.
- Using the bottom of the pool to assist in an offensive or defensive motion – goalie excepted.
- Using two hands to handle the ball – goalie excepted.
- Using a clenched fist while making contact with the ball – goalie excepted.
- Failure to take the free throw within a reasonable period of time.
- Leaving early for the start of the period.
- To assist a player at the start of the period or any other time of the game.
- Using more than 35 seconds of offense. (30 seconds in F.I.N.A. rules)
- Pushing off from an opponent. By using the hands or feet, a player may not use another as an object to gain separation and advantage by pushing or kicking. (Fig. 7-6)

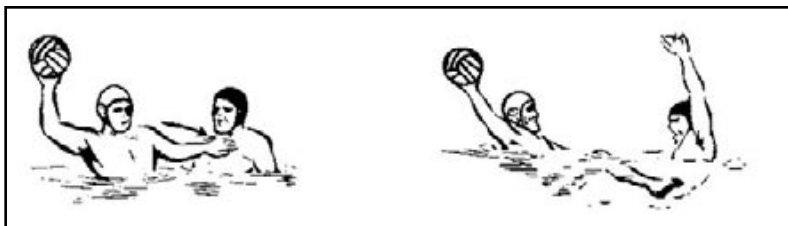

NCAA rule book

Fig. 7-6.

Ejection (exclusion) fouls: punished by removal from the field of play for a period of twenty seconds. Limited to three per player per game. Examples of this type of foul include:

- Interfering with a free throw. (Fig. 7-7)
- Splashing in the face of an opponent. (Fig. 7-8)
- Holding, sinking, or pulling back an opponent not in possession of the ball. (Fig. 7-9, 7-10, 7-11, 7-12)

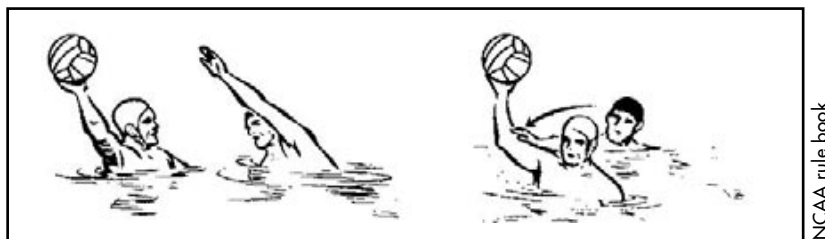

Fig. 7-7.

NCAA rule book

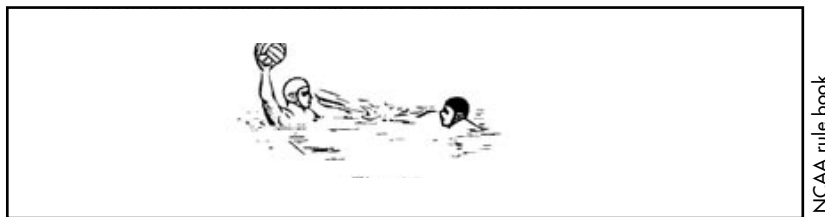

Fig. 7-8.

NCAA rule book

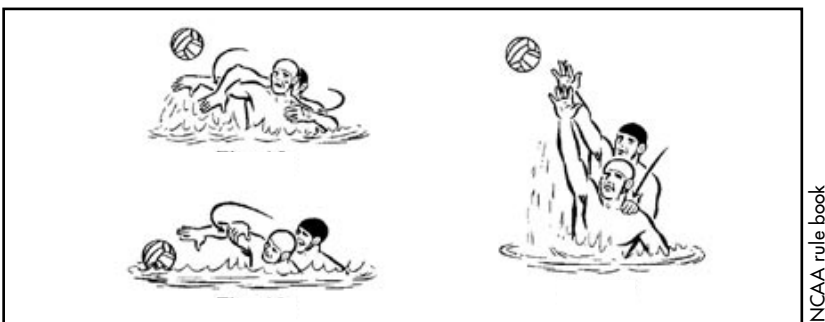

Fig. 7-9.

NCAA rule book



Joan Gould,
www.waterpoloplanet.com

Fig. 7-10. Holding exclusion foul – dark cap#6 has his left hand under water & his right on top of offensive player



Joan Gould,
www.waterpoloplanet.com

Fig. 7-11. Sinking exclusion foul – white cap defender sinking the dark-capped offensive player on the entry pass.



Joan Gould,

Fig. 7-12. Pulling back exclusion foul – white cap defender #10 is pulling back the submerged offensive player from reaching the ball

Penalty Fouls: Examples of this category of foul, punished by a free shot on goal at 5 meter mark.

- For a goalkeeper or other defending player to pull down or otherwise displace the goal.
- For a defending player intentionally to play or attempt to play the ball or block a shot with two hands.
- For a defending player intentionally to block or attempt to block a pass with two hands.
- For a defending player to play the ball with a clenched fist.

CHAPTER 7

Basic Water Polo Rules

- For a goalkeeper or other defending player to take the ball under the water when tackled. .
- A field player blocking a shot with two hands.

“It is important to note that while the fouls described above, and other fouls such as holding, pulling back, impeding, etc., would normally be punished by a free throw (and exclusion if appropriate), they become penalty fouls if committed within the 5 meter area by a defending player if a probable goal would otherwise have been scored.” (www.fina.org) (Fig. 7-13)



Joan Gould,
www.waterpoloplanet.com

Fig. 7-13. Penalty foul: dark-capped player pulling back white-capped dribbler as she shoots (inside 5m. area)

Game Exclusion Fouls: Punished by removal from the game and perhaps penalty throw. (Fig. 7-14)

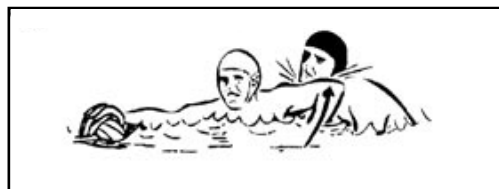

NCAA rule book

Fig. 7-14.

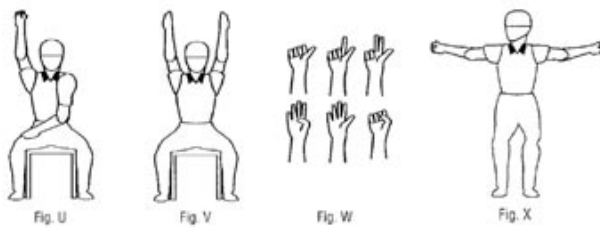

Fig. U

Fig. V

Fig. W

Fig. X

Fig. V. By a goal judge to signal an improper start by raising both arms vertically.

Fig. W. To indicate a player's cap number. To enable the referee to communicate better with the players and the secretary, signals are made using both hands if appropriate where the number exceeds five. One hand shows five fingers with the other hand showing additional fingers to make up the sum of the player's number. For the number 10, a clenched fist is shown. If the number exceeds 10, one hand is shown as a clenched fist with the other hand showing additional fingers to make up the sum of the player's number.

Fig. 7-15.

NCAA rule book

Referee Signals

The officials refereeing the game will use their arms, hands, and fingers to indicate who is in possession of the ball, who is ejected, when a goal is scored, etc. (Fig. 7-15)

Rules Questions & Resources

www.scafwfp.org or www.ncaa.org or www.fina.org or www.nfhs.com

True or False:

1. Re-entry areas are always located at the team bench area, which is usually at the corners of the field of play opposite the official's table.
2. When a person is called for an exclusion foul, (s)he can re-enter the field of play without going to the penalty box.
3. If a team on offense does not come out of its huddle without undue delay after a time-out expires, the referee shall award the ball to the opposing team.
4. The ball may be played by either player involved in a neutral throw before it hits the water.
5. A referee may issue a red card to a player in the water if (s)he refuses to leave the field of play after he has been whistled for either a misconduct or disrespect foul.
6. A goalie can touch the ball on the opposition's side of half.
7. It is considered a goal (i.e. 1 point) if 50% of the ball goes inside the plane of the goal.
8. A goalie can shoot and score a goal at the opposition's net.
9. A referee will point in the direction of the team that is on offense after (s)he makes a call.
10. A ball lands partially onto a sideline and rolls back into the field of play. This ball was never out of bounds.

(see answers below)

1. T 2. F 3. T 4. T 5. T 6. F 7. F 8. T 9. T 10. T

CHAPTER 7

Basic Water Polo Rules

Game management for water polo includes responsibilities which rely on rudimentary understanding of the aforementioned rules. Dr. Barbara Kalbus, past President of United States Water Polo and an expert in competition management, has written a very definitive version of these responsibilities as applied to the workings of the timers, scorer, and exclusion secretaries. See the website: www.sopacwp.com (“online host form” – “desk manual”) for a complete description of these responsibilities.

References:

Burke, Andy “The Rules,” in Hale, Ralph W. ed. *The Complete Book of Water Polo*. New York, N.Y.: Simon & Schuster, 1986, pp.28-34.

Burgess, Randall, “Water Polo Lesson Plans for Middle School & High School Boys and Girls,” Monterey, California CAHPERD Conference (March 17-20, 2005):13-19.

Federation de Internationale Natation Amateur (F.I.N.A.) *Water Polo Guide*. Lausanne, Switzerland: F.I.N.A., 1988.

Gaughran, Robert and Lambert, Arthur F. *The Technique of Water Polo*. North Hollywood, CA.: Swimming World Publications, 1969.

Kalbus, Barbara, <http://www.sopacwp.com/DeskManual.pdf> , 2006.

N.C.A.A. 2005 Water Polo Rules. N.C.A.A. Indianapolis, Indiana: 2005.

Ibid, May 15, 1951.

Smith, James R. *The World Encyclopedia of Water Polo*. Los Olivos, CA: Olive Press, 1989.

Water Polo Rules, 05 December, 2005.

<http://www.fina.org/rules/wp/rules.htm>

Water Polo Rules, 05 December, 2005

< <http://www1.ncaa.org/eprise/main/playingrules/waterpolo/index>>

Water Polo Rules, 05 December, 2005

< <http://www.nfhs.com/>>

* Rules Differences between N.C.A.A. and F.I.N.A.

http://www1.ncaa.org/membership/governance/sports_and_rules_ctees/playing_rules/waterpolo/waterpolorulesdifferences

Six on Five Offense, Five on Six Defense

As is highlighted in the rules from the previous chapter, there are varieties of penalties which result in an excluded player typically from the defensive team. That player must go over to the corner of the pool, near the sideline behind his(her) own cage for a period of time.

It is during this “exclusion” time that both the offense and the defense work to execute tactics for scoring or preventing a goal. As Nitzkowski says: “A productive Six-on-Five Offense has never been more important to the successful team than it is today.” (p 281) Depending on the level of play, there can be upwards of 15-20 total exclusions per game. **All other things considered even**, a teams’ ability to score during this opportunity or prevent the other team from scoring will likely decide the outcome of the match.

Quick Shot on Goal

Numerically, the best opportunity for a team to score is **right after** the exclusion foul is called. This fast outlet pass and perhaps 2nd pass for an assist is called a “quick.” (Fig. 8-1)

It is thus very important that both the offensive and defensive teams **hear** the referee’s whistle and identify where the excluded player is in the pool. In addition, rather than mechanically swimming to spots, the offense should make release moves, “v-outs”, to try for this quick if there aren’t many defenders around the goal.

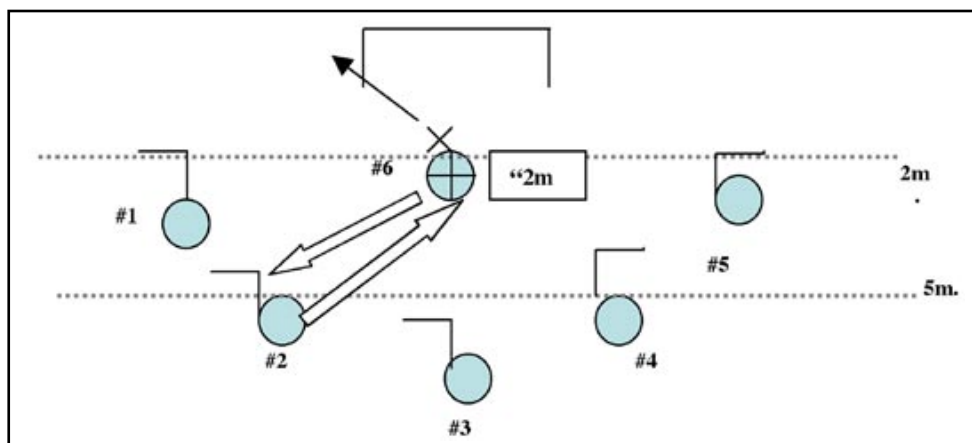

Fig. 8-1. The “quick” right back to beat the 5 on 6 zone – at the very instant of the ejection whistles, the 2m. offense dry passes out to #2 and right back for the shot.

CHAPTER 8

Six on Five Offense, Five on Six Defense

Teams typically attack the six on five by having one of two configurations: the “4-2” or the “3-3”. These formations combine different movements to achieve the highest percentage shot possible. There is much teamwork involved with the execution of the six on five offense, and players should be familiar with each other and how and where their teammates want their passes.

4-2 Offensive Configuration

This arrangement has four offensive players at or near the 2 meter mark and two players at or near the five meter mark (Fig. 8-2)

Technique points – Offensive players need to put the ball up above the head and move quickly to spots while at the same time looking to shoot and keeping the goalie on alert. The most fundamental principle of extra-player offense is to move the goalie and the defense out of the position through quick, accurate, dry passes and realistic fakes. The adage: “one fake and a pass” holds true when trying to move the goalie and field players out of position for a quick cross or post pass. Other strategies include multiple fakes, player rotations, and inward/outward shifts before passing the assist.

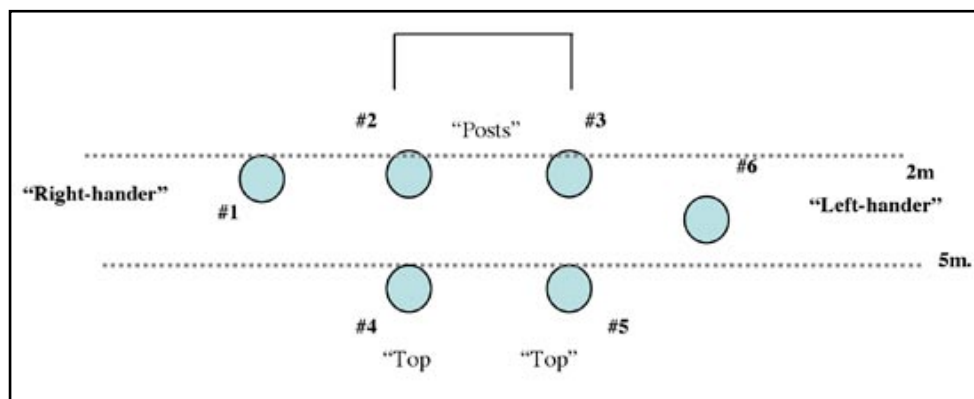

Fig. 8-2. 4-2 Six-on-Five Offense position names and numbers

Basic Passes to the Posts

- These include, but are not limited to #6 to #3; #6 to #2; #4 to #3; #5 to #2; and #1 to either #2 and/or #3. The six position, given that most players are right-handed, is typically an assist position. With a left-handed player, the 6 spot is also a shooting spot, as is the 1 spot. This is so because each of these players (1 and 6) have only one defender, in addition to the goalie, to beat for a score. The closest and highest percentage shots come from players #2 and #3.
 - a) Six-to-three: This assist is set up with quick passes between the #5 (top) and #6 (left) positions, and goalie fakes, to move the defenders away from the posts and then the assist into #3. (Fig. 8-3, 8-4, 8-5)

CHAPTER 8

Six on Five Offense, Five on Six Defense



Joan Gould, www.waterpoloplanet.com

Fig. 8-3. Six-to-three prep and pass – in the sequence below, white cap #10 is playing on the “3” post. She extends her arm & “steps out” to receive the assist from the “6” spot (not seen). “Step out prep”, six-to-three pass, White cap #10



Joan Gould, www.waterpoloplanet.com

Fig. 8-4. Receive and shoot, six-to-three passes below, white cap #10, dark cap #3 on the three posts



Michael Moriatis

Fig. 8-5.

CHAPTER 8

Six on Five Offense, Five on Six Defense

- b) Six-to-two “lob” or direct line pass: similarly, the #6 player makes set-up passes with player #4 and/or #1 before making a pass to the open player @ post #2. In the photo below, white cap #8 has successfully drawn the dark cap defenders to his side to be able to pass a lob to the #2 post (or to #1 spot) for a shot. (Fig. 8-6)



Fig. 8-6. Six to two “lob” pass

- c) Five-to-two or Four-to-three “diagonal” pass to post: when the center defender playing between the posts allows a passing lane between the top and the #2 and/or #3 positions, the top players can make a line pass above the post players head for a forehand or backhand reception and shot. (Fig. 8-7, 8-8)



Fig. 8-7. Four-to-three post pass (diagonal) – blue cap #7 passing to three-post

CHAPTER 8

Six on Five Offense, Five on Six Defense



Joan Gould, www.waterpoloplanet.com

Fig. 8-8. #3 Post rising high to take backhand shot after pass from #4 spot

- Shots from #1 and #6: Teams usually put their best shooters at these two positions so that the defense must “honor” them and the offense gains a high percentage shot. Whenever possible, it is beneficial for the #1 or #6 player to: receive a cross pass before shooting; move towards the cage to improve the shooting angle; and/or fake the goalie to have him(her) commit. (Fig. 8-9, 8-10, 8-11)
- It is also important for these 1 & 6 players to be able to shoot to the opposite side of the goal (cross cage) as the goalie typically dives to the near side on a cross pass.



Joan Gould, www.waterpoloplanet.com

Fig. 8-9. Shot from the #6 position, left-hander (dark #7) with good angle, few field player arms

CHAPTER 8

Six on Five Offense, Five on Six Defense



Joan Gould, www.waterpoloplanet.com

Fig. 8-10. Shot from one position (#4 dark cap), beating goalie & defender (#4 white), likely off from cross pass



Joan Gould, www.waterpoloplanet.com

Fig. 8-11. Shot from #1 position (dark cap), beating the goalie off cross pass

Notice the goalies position above – he had been on the opposite side of the cage and therefore had difficulty moving across to the near side to block the shot.

Three-Three Offensive Configuration

This approach involves spreading the defenders so as to maximize the opportunity for a high percentage outside shot (4-6m. away). There are three offensive players on the 2m.line and three in the 5-7m.area, with the three outside offensive players attempting to exploit their 3 on 2 advantage. (Fig. 8-12)

CHAPTER 8

Six on Five Offense, Five on Six Defense

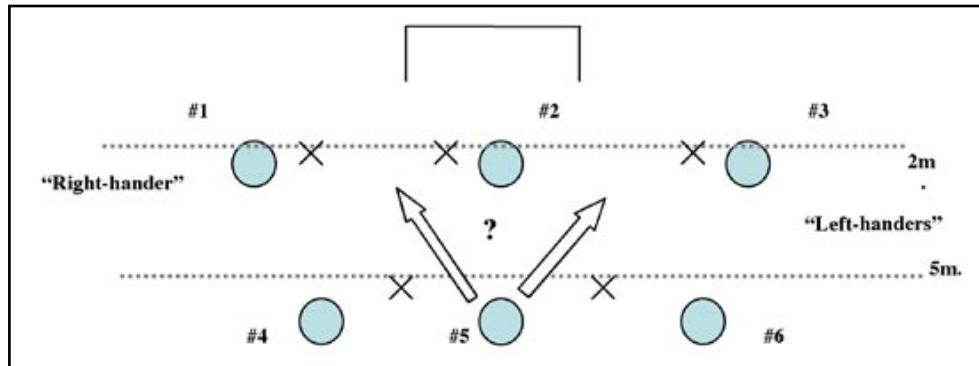

Fig. 8-12. 3-3 Six on Five Offense position names and numbers

Technique points:

- Much like a point guard in basketball, the #5 player penetrates, “walking” with the ball above his(her) head towards the cage @ an angle and tries to get one of the outside defenders to commit. When this defender does commit, #5 “dishes” off to either #4 or #6 teammate, depending on who committed, for the shot. (Fig. 8-12)
- If neither of the top defenders commits as the #5 player approaches the 4m. line, this point player takes the shot.
- This configuration is more effective with left-handed players at the #6 and #3 spots, so that they can quickly catch and shoot the ball.
- The three-three generally takes less familiarity and time to implement because the ball is usually handled by only 2-3 offensive players and the passes are relatively basic.

Five on Six Defense (player down)

When a player receives an ejection foul (s)he must exit to the designated corner behind the goal line. The other five field players must prepare to “kill the penalty.”

Technique points – at its heart, the five player defense is a zone. In figure 8-13, one



Joan Gould, www.waterpoloplanet.com

Fig. 8-13. Five-player zone (dark caps)

CHAPTER 8

Six on Five Offense, Five on Six Defense

can see all five dark cap players compacted into a space that effectively only allows “outside” shots. The defensive players must quickly get to their zone positions **immediately** upon hearing the multiple whistles indicating an exclusion AND cover the center (“back line”) to prevent the “quick.”

Player Responsibilities, 3/2, Five on Six

Post players “a” and “c”.

These two players have shot blocking responsibilities to obstruct the near side of the cage for offense #1 & #6 – see white cap player “c” in upcoming photos. These players must NOT allow shots to the near side of the cage as the goalie is depending on them to prevent this. (Fig. 8-16, 8-17, 8-18, 8-19)

- In addition, players “a” and “c” have responsibilities to go back to the 2 and 3 post positions, respectively and cut off passes to these players. These players need to decide, in concert with their goalie, whether to put the outside arm up or match arms. (Fig. 8-15)
- It is important that when the field defender blocks the ball, (s)he does so with a slight motion, not waiving at the ball. The ball should be knocked down, not tipped. The goaltender will have much more chance on this than with a deflection.

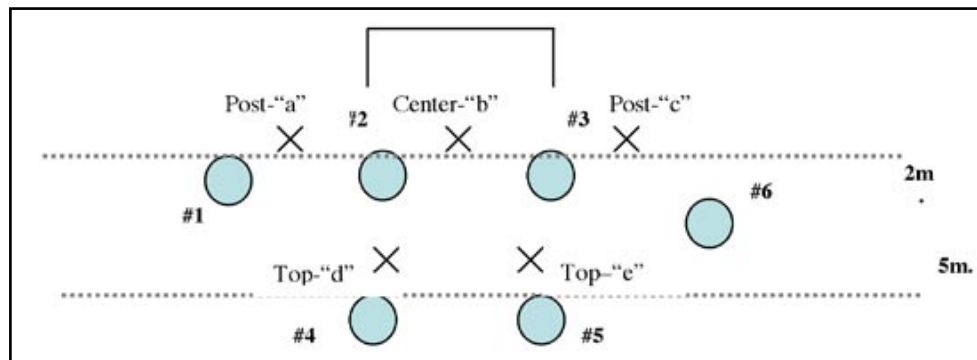

Fig. 8-14. 3-2 Five on Six Defense position names and letters



Fig. 8-15. Responsibilities for “d” and “e” defenders front view – “funneling the ball”

CHAPTER 8

Six on Five Offense, Five on Six Defense



Joan Gould, www.waterpoloplanet.com

Fig. 8-16. Back line defender "c" (white cap) covering near post of the goal



Joan Gould, www.waterpoloplanet.com

Fig. 8-17. Back line "c" defender (dark cap) cutting off near side of cage



Joan Gould, www.waterpoloplanet.com

Fig. 8-18. Player "c" defender (white cap) matching arms with left-hander @ 6 position

CHAPTER 8

Six on Five Offense, Five on Six Defense



Joan Gould, www.waterpoloplanet.com

Fig. 8-19. Player "a" defender (white cap) matching arms with right-hander (dark cap#6) @ 1 position

Center Back Defensive Position - "b" spot

This player is a mirror of the goalie; (s)he is responsible for passes to both of the posts, shots from both the 4 and 5 "top" offensive positions, and the diagonal passes from 4 to 3 and 5 to 2. (Fig. 8-20, 8-21)

- The player assuming this position should have good lateral mobility, preferably long arms, and work in concert with the goalie so as not to screen him(her).
- As with all defenders, being able to block and not deflect the ball is of the utmost importance, by using the forearm as much as is possible and not waving the arm.



Joan Gould, www.waterpoloplanet.com

Fig. 8-20. Center back "b" defender with arm up closing off cross-cage shot and pass to 3 post

CHAPTER 8

Six on Five Offense, Five on Six Defense



Fig. 8-21. Center back “b” defender (dark cap) putting arm up to block cross-cage shot from offensive player on top (likely 4 spot)

Top Defenders “d” and “e”

These players have responsibilities as shot blockers for the 4 and 5 offensive players and must move back to the 2 and 3 posts when the top players don't have the ball. In addition, these players should not be rotated out of position when the offense rotates in one direction or the other. (Fig. 8-22)



Fig. 8-22. Top defender “d” (White cap #3) putting arm up and attempting to block near side of cage

More Notes Regarding 5 On 6

- All shots should be “funneled” to the middle of the cage so the goalie has the best chance of blocking them. A goalie should be responsible for the inner 2.4 sq.m. or 24 sq. ft. of the surface area of the cage, not the 1ft. 3 ft. inside & adjacent to both posts. (Fig. 8-15)

CHAPTER 8

Six on Five Offense, Five on Six Defense

- Defenders (especially “a”, “b”, & “c”) must “seal off”, i.e. prevent all rebounds from goalie blocks so that the offensive team does not have a second chance (garbage).
- Hands must be up continuously so that players cannot shoot immediately after a pass is made.
- Players should be “on their hips” to cover maximum amount of distance in the zone in the shortest amount of time.
- When the excluded player returns, the other five should rotate towards the nearest player (a=2,b=3,c=6,d=4,e=5 OR c=3, b=2, a=1, d=4, e=5 depending on the entry area); players must be careful not to fully leave their zone until the re-entering player gets to his(her) player, and resume full strength (six on six) defense.
- There are variations to the 3-2 zone, and most of these involve splitting and gapping the 4,5, and 6 players, especially if they are all right-handed.
- There are variations which require the defense to be aggressive and foul the perimeter players (1,4,5 and/or 6) in order to stop good shooters.
- The five-on-six is a good time for the “d” and “e” players to “bait” passes – particularly the 6 to 5, 1 to 4, 5 to 1 and 4 to 6 passes. Defenders can do this baiting by sliding their legs into the passing lane and then popping up to intercept immediately after the pass is made.

References:

Barnett, Bill, Ch's. 8,9. United States Water Polo Coaching Manual – Level Two. Colorado Springs, Co: U.S. Water Polo, 1996.

Dettamanti, Dante, “5 on 6 Defense,” Irvine, Ca National Swimming /Water Polo Coaches Clinic.; (May,1993): 29-32.

F.I.N.A. Chapter 10, “Fundamentals of Extra Man.” Water Polo Manual. Australia: Institute of Sport, 1991.

Hart, David. Level II Coaching. Ottawa, Ontario: Coaching Association of Canada, 1978.

CHAPTER 8

Six on Five Offense, Five on Six Defense

Lindgren, Kenneth, Ch. 10“Man up, Man Down” in Hale, Ralph M.D. ed. The Complete Book of Water Polo. New York: Simon & Schuster, 1986.

Newland, Edward. “Six on Five Offense and Defense,” Irvine, Ca National Swimming /Water Polo Coaches Clinic,: (May,1990): 65-68.

Nitzkowski, Monte. Ch. 9, United States Tactical Water Polo. Pittsburgh, Pa: Sports Syndicate, 1994.

Oeding, Chris. “Extra Man – Defense,” Irvine, Ca National Swimming /Water Polo Coaches Clinic,: (May,1999): 134-135.

Tanner, John, “Five-on-Six and Six-on-five,” Irvine, Ca National Swimming /Water Polo Coaches Clinic,: (May,1993): 89-90.

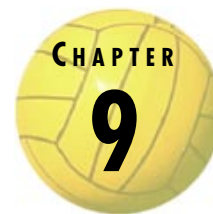

The Goalie – “le gardien de but”

As excerpted from: “Craig Wilson’s Guide to Water Polo Goalkeeping, 1995”

History

From the very beginning, goal keepers were special. They had to be big, strong and fearless. They needed to be able to hold their breath underwater for long periods. But, they did not need to be a great swimmer. For the majority of the game, goalies could hang on the wall and watch their teammates slug it out with the opponents. On the rare occasions the ball came near, they had the pleasure of trying to drown the ball carrier.

In the early 1880’s the Scots put up rugby goal posts about 10 feet wide at the end of the pool to minimize the scoring area. With this innovation came a rule that permitted the goalkeeper to defend the goal from the pool deck. Goalies prevented goals simply by jumping on the victims. They would wait for the opponent to arrive with the ball and then jump onto the players head when they got in scoring range. Apparently, after a few broken necks the rules brought goalies back into the water again.

By the late 1880’s, the Scottish rules modified to reflect soccer. In fact, for a brief period of time, the game was actually called “water soccer.” Under the new, more civilized rules, goals were scored by throwing the ball into a 3’ X 10’ netted cage. Although field players could only use one hand, goalies retained the special privilege of using both hands. This particular rule has remained essentially the same for the past 100 years, but the speed of the game has changed dramatically.

The goalie position as we know it today has remained basically the same for over 50 years. The first major breakthrough for the goalkeeper was the innovation of the egg-beater kick by the Hungarians in the 1940’s. This kick allowed water polo players to maintain a stable, head above water, body position. Still, the goalkeeper was passive, remaining locked in front of the goal.

Today, many goalies play as the seventh field player darting out from the goal to steal or breakup a cross pass before the shot can even be taken.

CHAPTER 9

The Goalie – “le gardien de but”

Additionally, in changing the rule that kept goalies from passing the ball past half-court, modern goalies now make 20 meter passes to get the fast break or counterattack started.

Unlike the other six players, the goalie position still does have its own set of rules, such as:

- Privilege to use two hands on the ball within the 5 meter area.
- Privilege to use a clenched fist to block the ball.
- Privilege to stand, walk, and jump from the bottom of the pool within the 5 meter area.
- Restricted to the defensive half of the pool.

In the current game, the goalie must be a versatile seventh player. The three keys to success in the cage are: 1) great fundamentals, 2) positioning and 3) knowing the capabilities of the shooter and your opponents. Once the equation between goalie and shooter is equal, blocking is a chess game, psychological warfare of who can outsmart whom. This is one enjoyable aspect of water polo: matching wits with the opponents every time the ball comes down the pool towards the goal you're defending.

Psychological Traits of Goalies

- The goalie must show leadership.

By virtue of his(her) vantage point at either end of the pool, (s)he has a **total** view of the playing field. For this reason, (s)he must continually communicate to his(her) teammates information about what is going on in the game. (S)he is the voice of the team, primarily for the defense, but also (s)he can relay critical information to the offense (e.g. time on the shot clock). (S)he must have the ability to make quick decisions, speak up and feel comfortable guiding the field players with concise, timely and relevant information.

- The goalie must have guts.

The most essential yet elusive quality requires the courage to WANT to be hit by the ball. When starting out, this is the toughest fear to conquer. We are all born with the human survival instinct. It is natural to want to dodge large projectiles hurled at your body. Seasoned goalies will admit that the survival instinct was probably one of their toughest hurdles to overcome, at least it was for me. One day it finally dawned on me

CHAPTER 9

The Goalie – “le gardien de but”

that being hit by the ball, including the face, rarely hurt for more than a couple of seconds. In addition, I was always happy to be hit by the ball because that meant that I blocked it. Of course, there are the rare and embarrassing occasions when you are hit by the ball and it still goes in the goal. Shake it off and look forward to the next shot.

I don't have any specific tricks or drills that can help you through this transition other than to say that all goalies go through it. The quicker a goalie can forget about being hit, the quicker (s)he move on to more serious training and playing.



U.C.S.B. Daily Nexus

Fig. 9-1. Face shot



Fig. 9-2. Getting Over It

CHAPTER 9

The Goalie – “le gardien de but”

- The goalie must be a quarterback.

After a save or a steal the goalie must **quickly** survey his(her) team as they counter-attack down the pool, evaluate the predicament then make a pin-point pass to the correct player. Failing to identify the right “outlet” player can cost your team a fast-break goal. Goalies should be able to make passes up to 25 meters down the pool with the ball landing in an area no larger than 1 square meter.

- The goalie must maintain a positive attitude.

(S)he is the last line of defense and the last hope. The position lends itself to being placed in a pressure cooker. A positive attitude is infectious. If you stay positive your teammates will believe in you and will share in your outlook. You probably have heard that some people look at a glass half-empty while others look at a glass half-full. Goalies must never see a half-empty glass.

There is no place for getting “down in the dumps” during a game. When the “chips are down” it is imperative that you maintain your composure. In the goal, like being on a stage, there is no place to hide. If a moment arrives when the pressure becomes too much, don't let your teammates and **especially** your opponent know that you are temporarily scared or worried.

When you have a goal scored against you **always** make a mental note to yourself detailing the specific circumstances that resulted in the goal and most importantly maintain your composure. If the goal was scored because of an outstanding play then you can tip your hat to your opponent.

If you missed a shot that you should have blocked search your thoughts for a reason why you may have missed the ball. If no clear reason is readily apparent then chalk it up as a bad play on your part. We have all missed shots in games that we were able to block with our eyes closed in during practice. During a quarter break or after the game, ask yourself, your teammates and coach what could have done if anything, to prevent the same goal from happening again.

- The goalie must be a student of the game.

The goalie position differs greatly from the field positions in water polo. In order to reach your potential as goalie you must understand every aspect of the game in order to play in synchronization with the field players. A defense (goalie & field play-

CHAPTER 9

The Goalie – “le gardien de but”

ers) will consistently play at a high level when they understand the fundamentals of individual and team defense, execute the team’s defensive strategy together, know the strengths and weaknesses of their teammates and keep open lines of communication during the game. When a goalie and his defense are “in synch” the opposing team will look as if they are playing with lethargy and without a clear offensive strategy.

Being a student of the game is easy: therefore make it a part of your training regimen. You can never learn enough about water polo. Study your opponents by watching their games, listen to your coach(s), break out the water polo video collection and study your written as well as mental notes. By becoming a student of the game you will develop more common sense and analytical skills which will give you the ability to figure out the best percentages for defensive alignments, shooting angles, etc.

- The goalie must be patient and acquire experience.

Experience is an entity that cannot be trained and is the lifeblood that makes a good goalie great. It helps a goalie to better anticipate the shot, make the outlet pass to the right player, lead the team through communication and leadership, and stay cool under pressure. The bottom line is that experienced goalies make less mistakes, hence they give up less goals.

If you were to ask a group of coaches what is their top consideration when selection a goalie to play in a big game, my guess is that you would see that experience would top the list. This is why you find most starting goalies in the international arena above the age of 30. Even though the younger second and third string goalies may display more physical talent, my hunch is that the coaches keep the younger goalies on the bench giving them the experience of watching the older veteran play.

Physical Makeup

The goalie should have good **mobility & quickness**. Leg strength and overall flexibility are necessary attributes that allow a goalie to cover the inside dimensions of the cage. Ideally, you want a player who is proficient in the egg-beater kick.

- Flexibility helps a goalie to stretch for a ball while the body is contorted having just moved from one portion of the cage to another. This may be the difference between a deflection and a goal. Goalies must be able to move sideways, forwards, backwards, and straight up. Goalies must work on this flexibility and range of motion through daily stretching.

CHAPTER 9

The Goalie – “le gardien de but”

- Reaction speed is a prerequisite for goalies. Much like a sprinter in swimming, you must have a quick first movement to get to the ball before it goes past you. Reflexes must be sharpened through practice.

The goalie should be able to **swim**. For short distances, goalies need swimming speed to be able to out-swim field players and make steals. Don't assume that because you are a goalie, you will not have to swim. Try to learn how to swim the front crawl as well as you can, because it will become one of your best threats to steal the ball. I swam competitively as a youth through my Junior year in high school and was one of the faster players (50 yards) on the Olympic team.

The goalie must be **physically fit**. Strength will increase stamina, speed and longevity. The goalies desired body type should be lean so as to enhance flexibility and range of motion. You don't have to be tall. I have seen shorter goalies who play excellent water polo.

It is important to remember that a goalie is only as good as the defense in front of him or her. Great defensive performances will make a weaker goalie look strong while poor defensive performances will make a superior goalie appear weak. If you have had the opportunity to watch a game from directly behind the goal, then you have seen the individual skills of the goalie and the coordination of the defense. Although a goalies individual performance can be evaluated in a vacuum, it is more appropriate to view the goalies performance as it related to the team defense.

A great performance by a team makes the goalie look strong while a weak team performance makes the goalie appear weak. If you have watched a game from directly behind the goal, you have seen the critical importance of the team concept in overall coordination of the defense. A goalie can only be as strong as the team defense in front of him/her. Although, individual performance does play an important role, the team concept will add greatly to a goalies performance. Most of the time goalies receive the compliments for a good performance, when in fact the entire team should have also received the same praise.

By virtue of the number of different jobs a goalie must do, many of the famous names in the sport of water polo have this to say about goalies:

“(He/She) Changes the outcome of a game single-handedly.”(Steve Heaston, 1988 Olympic Coach, 1993 Coaches Clinic)

CHAPTER 9

The Goalie – “le gardien de but”

“Is the most important player on the team.” (Pete Cutino, National Coach , 1976)

“Can help field players take more liberties defensively.”(Art Lambert, Olympic Coach, 1972)

“Starts the offensive charge. (Monte Nitzkowski, Olympic Coach, 1989)

“Strong goalkeepers win games.”(Robert Horn, former U.C.L.A. coach,1988 Y.E.S. clinic)

Goalie Fundamentals

Eggbeater kick (see chapter 2 & 3 also)

The eggbeater kick is most critical. Many manuals have been written on the fundamentals of the eggbeater kick so we will not attempt to explain in detail how it is done. As seen by the diagrams, the breaststroke kick is alternated so that each leg operates independently and continuously. While one leg is recovering the other is flexing, and so on. The kick is done with the body in a vertical, or sitting position. (Fig. 9-3)

My philosophy is that you can never spend enough time training with the eggbeater. If your knees or hips begin to hurt, STOP immediately and let your body rest. It is telling you that there is a problem. If you don't have any pain, just soreness, then spend more time working on your leg strength and quickness.

As a lead up, I have found that beginning goalies should learn eggbeater while holding a kick board. This frees the hands and allows you to fully concentrate on the legs. In the beginning of each season, I would take a kick board, hold it in the water as if it were a plow and eggbeater laps. My coach in Italy made me do this in the beginning of the season for the first week before we started with strenuous eggbeater and I never had a problem with extreme soreness and injury as I had in the previous years. The rule of thumb is to work your way up to extreme training.

In addition to the eggbeater, goalies should be proficient and practice at the flutter kick. This crawl kick will be useful for the short sprints necessary and for general flexibility of the legs.

Sculling is another technique that can help your eggbeater. You should be able to move your hands back and forth lightly on the surface of the water to assist in propelling

CHAPTER 9

The Goalie – “le gardien de but”

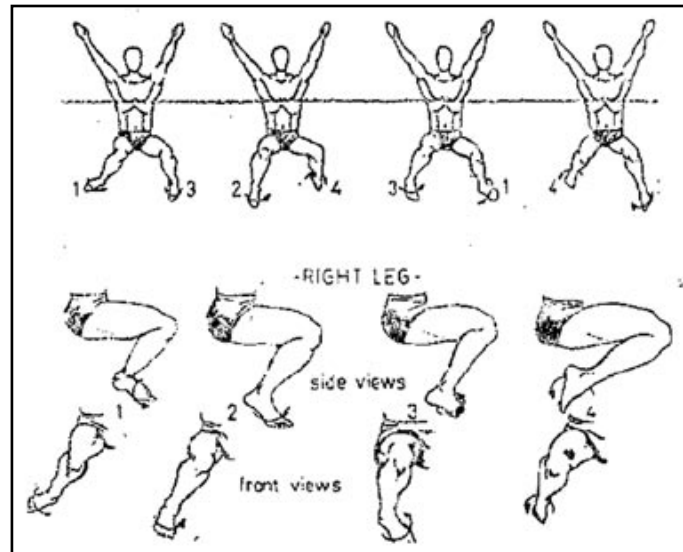

Canadian Water Polo Coaching Manual, level 1, 1976, p.28

Fig. 9-3. The Eggbeater Kick

ling you across the width of the cage. I practiced sculling while in the sitting position. My coaches called this the “Chair Drill”. Sculling helps with lateral movement and gives the goalie a good feel for the water.

Body position – ready position.

There is a definite difference between the resting eggbeater kick and the alert, ready position. Goalies must begin to rise higher in the water in order to prepare for a shot and see all that transpires in the field or water in front. (S)he needs to have a minimum height of the chest above the surface of the water for this alert position. The hip position should be slightly behind the torso, that is, not vertical. (Fig. 9-4, 9-5, 9-6)



Joan Gould, www.waterpoloplanet.com

Fig. 9-4. Ready position, side view, outside shots

CHAPTER 9

The Goalie – “le gardien de but”



Chris Kittredge, www.tudorgraphics.com

Fig. 9-5. Ready position, front view, outside shots



Joan Gould, www.waterpoloplanet.com

Fig. 9-6. Ready position, outside shots

In conjunction with this body position, the goalie must also be concerned with the next fundamental – hand positions.

Hand positions.

The hands are an important stabilizing and mobility force through the sculling motion. But: A goalie's hands should NEVER be too far below the surface of the water when a shooter has the ball.

CHAPTER 9

The Goalie – “le gardien de but”

Another way to interpret the amount of hand motion a goalie should use is given by three-time-Hungarian Olympian Andre Molnar: “I use my hands when the ball is being passed from one player to another. When a player has the ball and is ready to shoot I ease up on the arms and hands; the legs take over.” (Fig. 9-7)



Chris Kittredge, www.tudorgraphics.com

Fig. 9-7. Ready position ball close to cage

The ready position listed above will change according to the closeness of the ball to the cage. As a general guideline, I have found that your hands should be in front of your body, elbows bent comfortably and the following distances kept in mind. When the ball is:

- Outside of 6 meters the hands are just below the surface of the water.
- Between 4-6 meters the hands should be ON the surface of the water and not below it.
- Closer than 4 meters the hands need to be all the way out of the water.

Positioning

- Angles: This term applies to the goalies reference point in relation to his (her) body, the cage, and the shooter. (Fig. 9-8)

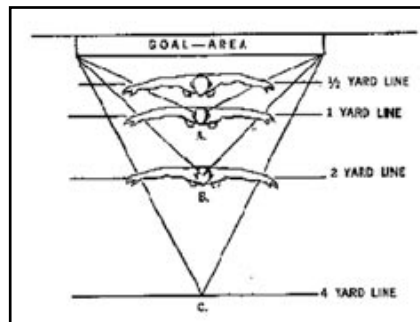

Fig. 9-8. The Most Advantageous Angle - as shooter gets closer to the cage

CHAPTER 9

The Goalie – “le gardien de but”

- Movements and shot anticipation: When the ball is released, the goalie must move his head towards the ball, as his (her) body will follow. (Fig. 9-9)



Joan Gauld, www.waterpoloplanet.com

Fig. 9-9. Head to the Ball

- The near side of the cage – i.e. the side closest to the ball – is the most important area of the cage for the goalie to cover. (Fig. 9-10)



Chris Kittredge, www.tudorgraphics.com

Fig. 9-10. Ready position ball close to cage, cutting off near side of cage

During and After the Save.

Blocking the ball is primary, but secondarily the goalie must continue to be active in order to secure the safe possession of the ball.

- Gain complete control of the ball while at the same time listening to the bench for information that a free player may be open. Relying on the coach and bench can be dangerous so at the same time you should work with your teammates to know where and when to deliver the ball and know tendencies of their counterattack.

CHAPTER 9

The Goalie – “le gardien de but”

The question of how or whether to use one or two hands when moving to the ball is dependent on how fast the shot is approaching and where it is directed. If possible, use two hands to block the ball when there is:

- A softer shot close to the body.
- A longer, weaker shot to the outer portions of the cage.

In these instances, the palms should be facing each other to form a ladle-shape, fingers together, thumbs close together. The wrists need to be firm so that the ball doesn't “squirt” through the hands. (Fig. 9-12 to 9-17)

NOTE: In all other instances, one hand or any portion of the body should be used to reach and block the ball. (Fig. 9-11) One-hand lunges from the goalie can reach farther and faster than two-hand lunges.



Joan Gould, www.waterpoloplanet.com

Fig. 9-11. Controlling the ball in front of the cage – notice hand position



Joan Gould, www.waterpoloplanet.com

Fig. 9-12. Two hands to block and control the ball in front of the cage, high shot, goalies right

CHAPTER 9

The Goalie – “le gardien de but”



www.usawaterpolo.com

Fig. 9-13.



Joan Gould, www.waterpoloplanet.com

Fig. 9-14. Two hands to control the ball in front of the cage, goalie's left & right



Joan Gould, www.waterpoloplanet.com

Fig. 9-15.

CHAPTER 9

The Goalie – “le gardien de but”



Fig. 9-16. Maximum two-hand control of low shot

- Hold the ball high so you players will know that you have the ball while at the same time looking down the pool for possible passing opportunities. Always look down the deep right side of the pool first, the center of the pool second, the deep left side third, short right fourth and short left last. This order ensures that the ball will get the correct player fastest. You don't want to throw the ball to the short left when you may have a player open deep right. This order will become second nature. Visualize yourself looking down the pool to these locations and making perfect passes to each one.
- If you have time, swim the ball out to the 3 or 4 meter line and then hold the ball high looking for an open player. This will make the pass shorter and more accurate. Be sure to keep your head up high because you may have to make an immediate “quick strike” throw.



Fig. 9-17. Over head block – two hands

CHAPTER 9

The Goalie – “le gardien de but”

Five Meters

Psychologically, this shot should be looked at as a very positive chance for the goalie. In all instances the field player is EXPECTED to make the shot therefore, a block is an embarrassment to the shooter and his/her team. Chris Dorst (1980 & 1984 Olympian) was the master at penalty shot blocking. I believe that during his tenure at Stanford, he held an unbelievable 30% penalty throw blocking percentage. His strategy was to verbally and physically interrupt the field players concentration from the moment the penalty was called by the referee until the moment of the shot.

The two styles of penalty shot blocking are:

- Moving towards one side of the cage as the best guess or
- Moving out towards the shooter with arms spread so as to eliminate the lower or upper portion of the goal. (Fig. 9-18)

More than 3/4 of all penalty shots go to the low corners. Therefore, you will want to try to cover as much of the surface of the water as possible after the whistle.

Once you have determined the area of the goal that you want to defend then timing is the next factor to consider. You can improve your chances by exaggerating the layout position with arms extended out wide, sculling, and anticipating the referee's whistle.

This anticipation of the whistle is similar to what the sprinter does at the start of the period. It involves slight movements towards the penalty throw shooter. The worst that can happen, short of being removed, is for the referee to assess you a major foul - one of three possible during the game. Be aware, that some shooters will take a longer windup than others before finally releasing the ball. Look at where the players arm position is and how they are holding the ball. This will give you some indication as to how quickly the ball will be released.

It is of equal importance to have scouted the penalty shooters from the opposing team. Few players will deviate from their favorite corner each penalty shot. Before the game begins, you should know which style of blocking you will use and the timing required for each player. Most good shooters have different targets, but the same release point, so you can work to time the block.

Try to get the shooters thinking about their shot because thinking makes them anxious, which is a basic cause of most “bad” shots.

CHAPTER 9

The Goalie – “le gardien de but”

The 5-meter throw is a way for you to shine and, perhaps more importantly, give your team a lift by preventing what is expected to be a sure goal, while at the same time deflating the other team. Practice your routine daily.



Fig. 9-18. Penalty throw block, wall goal

Lobs

Anticipating when this variety of shot will be taken is the first key to blocking the lob shot. The lob shot itself moves at a much slower rate of speed and therefore gives you more time to get to it than the power shot. The field player who is a good lob shooter will often observe one or both of the following two faulty features in a goalie before attempting a lob:

- You are out of the cage too far (forward/backward).
- You are off-balance because you have reacted to the shooter's fakes.

Maintaining a good centering position (forward/backward) and staying on balance will deter most shooters from attempting the lob shot. There is one other situation where the likelihood of a lob is very high - when the shooter is at an angle where the power shot does not stand a good chance of scoring. Corner lob shots have a larger area margin for entry into the cage than do straight-on lob shots.

The technique for blocking the lob shot is different than all other shots because the goalie is moving back into the goal to intersect the arc of the lob. This movement is the opposite of the power shot where the goalie moves forward to “cut off the angle.”

CHAPTER 9

The Goalie – “le gardien de but”

When the lob shot leaves the shooter’s hand, you must pivot your torso to point one shoulder at the ball and the other toward the extreme opposite post of the cage. Your eyes need to always be on the ball as you turn 1/4 to move towards a spot 1-1/2 meter away and close to the opposite post. Then, you can either scull rapidly or take a quick stroke or two toward that spot. You should try to make these movements directly across the goal mouth. Above all else, **WAIT FOR THE BALL TO COME TO YOU!**

After reaching this spot and while the ball is in flight, you must extend the arm and fingers that are closest to the ball straight up. For example, if the lob comes from your right, you should extend your right arm up; if the lob comes from the left, you should extend your left arm up. The opposite (non-extended) arm should continue to scull to provide you continued body support. (Fig. 9-19, 9-20)

If at all possible, the lob is one shot that you should try to, in the following order:

- Catch the ball and gain control of it.
- Tip it out to a place in the water away from any immediate field players. This is a shot that, if rebounded, is an easy “garbage” rebound for a player to put in the goal.
- Tip the ball out of bounds (over the cross-bar) if there are opposing players who are in near pursuit of the ball.



Joan Gould, www.waterpoloplanet.com

Fig. 9-19. Lob Shot Block – last sequence
Lob block on shot from the 4/5 side of the pool – notice left hand used to block(catch) ball

CHAPTER 9

The Goalie – “le gardien de but”



Fig. 9-20. Lob block on shot from 1/2 side of the pool – notice right hand used to block(catch) ball

Final Thoughts

LESSON #1: Always expect the unexpected.

LESSON #2: Do not alter your playing style because of an embarrassing incident. Every game, regardless of your experience level, will always provide a lesson learned. It is **your** responsibility to find the lesson and learn from it (them). The second that you think that you know it all is the instant you will cease to improve as a player.

The goalie has much to learn and develop. Some improvements will come naturally while some will take time to develop with the assistance of coaching and practice. A goalie doesn't have to be tops in all areas. It is important that the individual selected develop his (her) own style suited to his(her) strengths. Regardless of one's skill level when they start, their strengths will get stronger and their weaknesses will diminish.

LESSON #3: Goalie Proverb:

“Do all of the preparation, suggestions and work mentioned in this chapter in order to avoid a goalies most embarrassing moment!! - - reaching back in the cage to retrieve the water polo ball.”

Keep in mind also that although a goal scored on you may be embarrassing, if you try to learn from every goal and every game, you will develop into a better goalie over time.

CHAPTER 9

The Goalie – “le gardien de but”

References:

Almquist, David, “Drills for the Goalkeeper,” U.S.A. National Team, 1988.

Barr, David & Andrew Gordon. *Water Polo*. East Yorkshire, England: E.P. Publishing, Ltd., 1980.

Cutino, Peter J. and Dennis Bledsoe. *Polo: The Complete Manual for Player and Coach*. Los Angeles, Ca.: Swimming World Publications, 1976.

Gallo, Rezso and Ivan Somlai. *Coaching Water Polo*. Ottawa, Canada: The Canadian Water Polo Association, Inc., 1977.

Hale, Ralph (ed.). *The Complete Book of Water Polo*. New York: Simon & Schuster, Inc., 1986.

Hammond, Steve. *Goalie Drills*, 1998

Hart, David. *Level II Coaching*. Ottawa, Canada: Canadian Water Polo Association, Inc., 1978.

Horn, Robert, “The Goalkeeper,” Los Angeles, Ca. National Swimming/Water Polo Coaches Clinic. (May, 1988).

Lambert, Arthur F. and Robert Gaughran. *The Technique of Water Polo*. North Hollywood, Ca.: Swimming World Publications, 1969.

Nitzkowski, Monte. *United States Tactical Water Polo*. Pittsburgh, Pa.: Sports Support Syndicate, Inc., 1994.

Sprague, Stan, “The Goalkeeper – Selection, Fundamentals, Drills/Workouts,” U.S. National Junior Team Manual, 1990.

Wiltens, James S. *Individual Tactics in Water Polo*. New York, New York: A.S. Barnes and Company, 1978.



Fast Break or Counterattack Offense and Defense

Offense Transition

The ability to transition from defense to offense often provides a team with good to excellent scoring opportunities. There are at least five opportunities for this offensive advantage situation to happen:

- Goalie block and possession of ball.
- Shot either tipped by defender or missing the cage completely.
- Steal by a defender.
- Offensive foul.
- Possession clock expires.

The fast break should be a natural reaction for a team on every transition listed above. The opposition is most vulnerable when a shot is taken because the shooter and his(her) teammates might be watching to see whether a goal has been scored or not.

This chapter will look at the transition from defense to offense and tactical ways to maximize these scoring opportunities.

Defense to Offensive Positioning

Players on the weak side (#1, 2 spots) should “cheat” up towards the other end of the pool with their hips up, ready to sprint to offense and find swimming lanes for approximately 12-20 meters of fast, head up swimming. (Fig. 10-1)

Initial break – *releasing* for goalie or field player pass:

In order to receive the first(outlet) pass as part of the fast break, the players going to offense should make a release move to help with the ball advancement. The pass is usually made by the goalie.

CHAPTER 10

Fast Break or Counterattack Offense and Defense

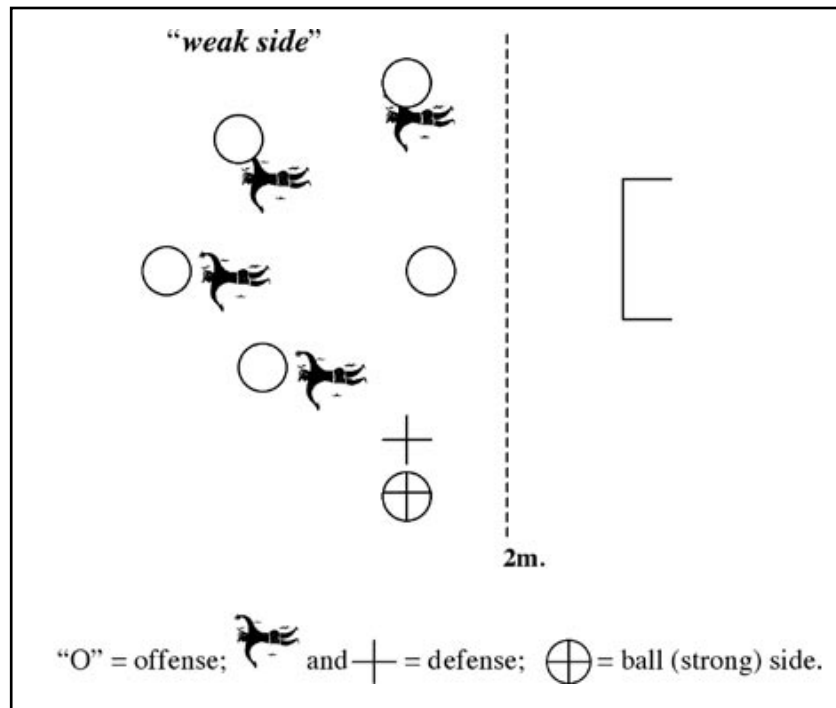

Fig. 10-1.



Fig. 10-2. Short release – White team on offense - notice possession clock, 90° move to the "outside", eye contact between the goalie and the receiver on right side

In order to get free from a defender and create an open area for the goalie or passer to throw an air or wet pass, the offensive player must make a movement towards the *outside* (the edge of the course) of the pool or back towards the goalie or passer. Most

CHAPTER 10

Fast Break or Counterattack Offense and Defense

releases are done to the goalies *right* because most players are right handed and can receive an assist pass easier if it comes from their right side. ***And, it is essential to keep the ball away from the middle of the pool!*** (Fig. 10-2)

There are at least three different possible movements to free a releaser on counterattack: (the choice depends on how much defensive pressure there is and how quickly the ball needs to be advanced – least pressure (fastest) = banana; most pressure (slowest) = hook.) The goalie or field players pass must be **accurate** so the players don't have to deviate from their paths. Much like a football pass, this release pass should be a wet pass made to where the receiver **will be**, not where they are. There are some occasions when this could be a dry pass to the releaser.

The potential receivers of the release pass should ALWAYS know where the ball is and even take a stroke or two on his (her) back to get eye contact with the passer. (Fig. 10-3 to 10-5)

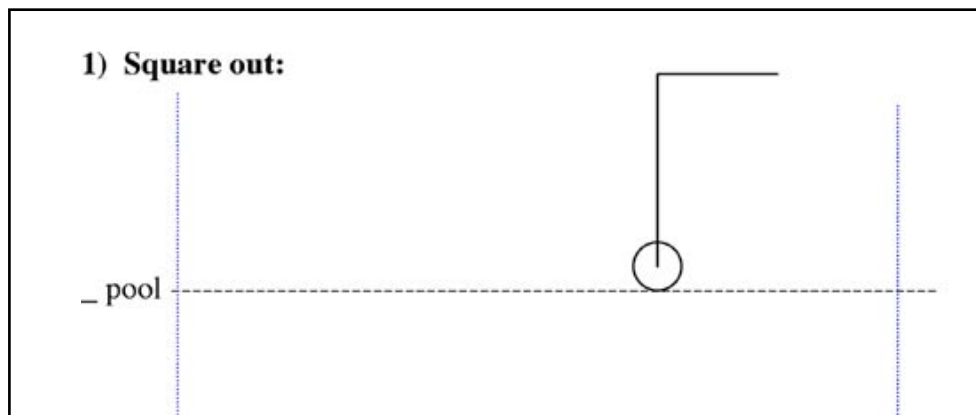

Fig. 10-3.

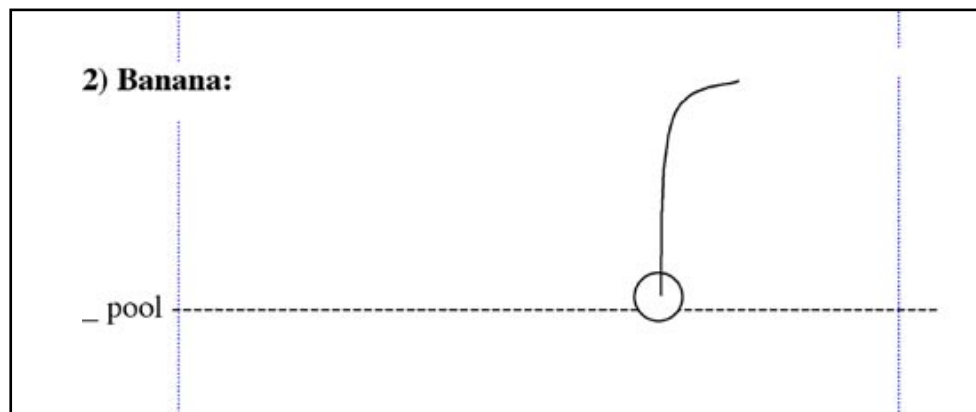

Fig. 10-4.

CHAPTER 10

Fast Break or Counterattack Offense and Defense

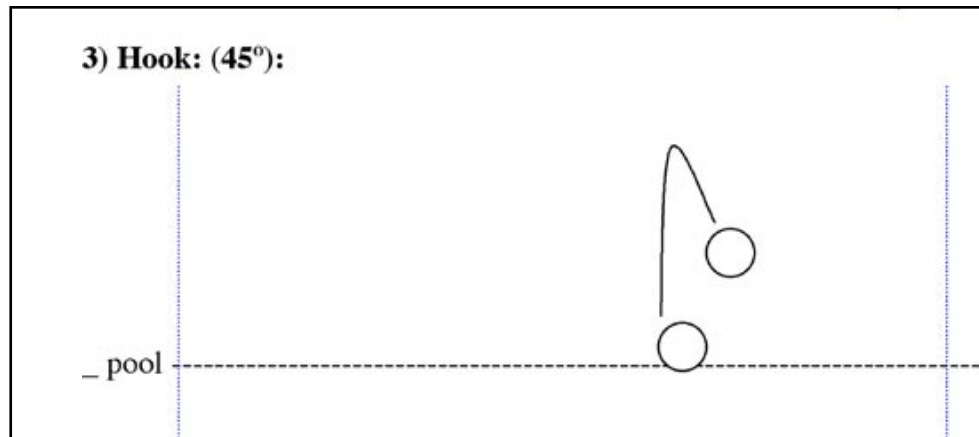

Fig. 10-5.



Fig. 10-6. Dark hat release to the right side of the pool – deep wing, “square out”, goalie area pass in the air

Finally, it is important that during the fast break the ball moves ahead of the rest of the offensive field players so that easier assist passes can be made to the players sprinting down pool who are free. This placement can be termed the “deep wing”.(Fig. 10-6)

Numerical Advantages On the Fast Break

For each of the fast break opportunities, there are different variations on attacking the opposition and goalie:

One on the goalie –

Technique points:

- Move the ball to the middle of the cage for the best angle, approximately 3-4m. from the cage.

CHAPTER 10

Fast Break or Counterattack Offense and Defense

- Try to get the goalie to jump and get off center with a good pick up and fake of the ball.
- Know how much time there is before a defender is near.
- Good technique dribbling and ball pick up are essential. The shooter should keep his or hers dribble rate for as long as possible – not slowing down to let defenders catch up and tip off the goalie for the shot attempt. A fluid motion is beneficial.
- Find where the biggest hole is and shoot there without hesitation.
- If the goalie is covering the strong side of the cage, shoot across to the opposite side.
- If the goalie doesn't come up, a high shot is a good percentage location; if the goalie does come up, a low shot is good percentage location. (Fig. 10-7 to 10-9)



Fig. 10-7. White 11 out in front, pick up ball on the post



Fig. 10-8. Blue 3 in front, looking behind for defenders, picking up ball, near side post

CHAPTER 10

Fast Break or Counterattack Offense and Defense



Fig. 10-9. Blue 3 picks up ball high over head, shoots cross-cage (notice low near side option)

Two offensive players on one defensive player:

Technique points:

- Bracket the cage. One player on one post at the 2m. line, one on the other post to extend the goalie and keep a good shooting angle. (Fig. 10-10)
- Clean pick up of the ball. (Fig. 10-11)
- Set the goalie on the strong side of the cage. (Fig. 10-12)
- Be sure to look at the goalie to get him(her) to commit, and see your teammate(s) out of the “corner of your eye.”
- Pass a catchable assist, preferably firm, quick and over any interceding defenders; or, shoot to the open portion of the net.



Fig. 10-10. 2 on 1, Red team bracketing the cage, setting the goalie to the near side

CHAPTER 10

Fast Break or Counterattack Offense and Defense



Fig. 10-11. 2 on 1, White team ball pick up, setting goalie to near side



Fig. 10-12. 2 on 1, White team faking goalie, ready to pass or shoot

Three offensive players on two defenders:

- **One approach** – rotation away from the ball. In the upcoming diagram, the ball starts on the outside right portion of the pool. (S)he (player #1) must improve his(her) shooting angle by taking the ball towards the middle of the cage. Player #2 needs to rotate to the opposite post of the cage at two meters distance, away from the dribbler, thereby forcing the defender (“b”) to move out of the path of the dribbler or leave player #2 wide open in front of the cage. Player #3 occupies his(her) defender (“a”) by *forming a triangle* passing lane and moving slightly middle. Player “c” is the defender trailing the dribbler. (Fig. 10-13)
- **A second approach:** Using this “**direct**” method, the dribbler follows a straight path to the 2m. line and his(her) teammates form a triangle in two other high percentage areas of the front court. Thus player #2 “pops” directly back away from the 2m. line to create a passing lane from player #1 and player #3 goes towards the 2m. line, to open a second passing lane also from player #1. (Fig. 10-14)

Four offensive players on three defenders:

- In the sequence above, the red cap player releases for the ball on the left hand side of the pool. The free player is the 4th red in the middle, being trailed by a white-capped player. The goalie has the ball ready to release pass to the left. (Fig. 10-15)

CHAPTER 10

Fast Break or Counterattack Offense and Defense

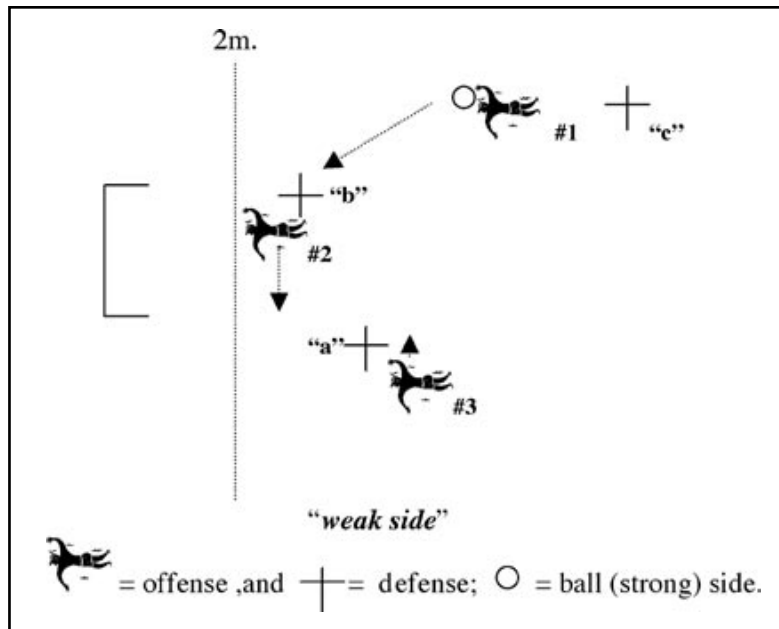

Fig. 10-13.

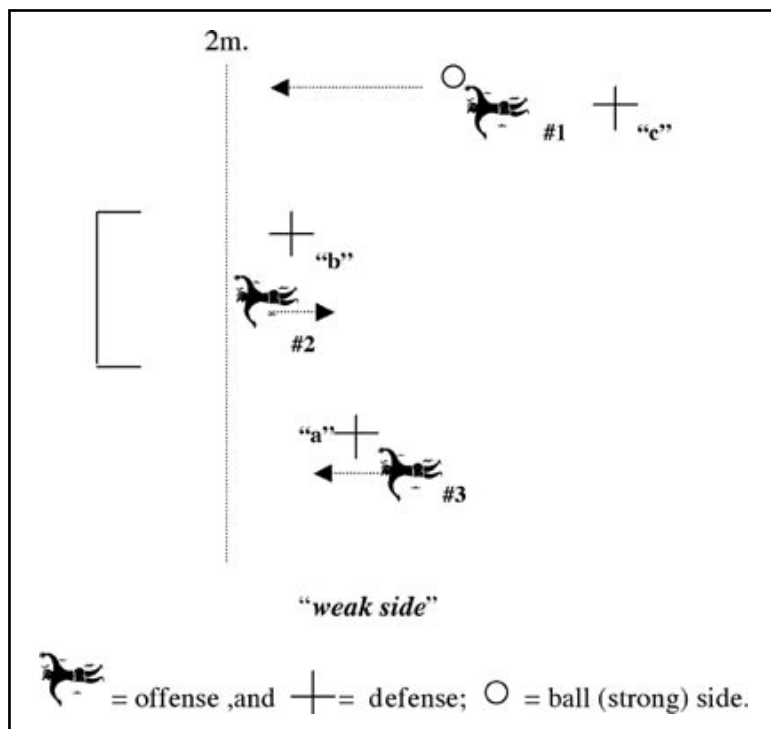

Fig. 10-14.

CHAPTER 10

Fast Break or Counterattack Offense and Defense



Chris Kittredge, www.tudorgraphics.com

Fig. 10-15. Releasing for the ball with 4 on 3 advantage for the red team



Chris Kittredge, www.tudorgraphics.com

Fig. 10-16. Offense (red team) spreading the defenders and moving towards the cage

- In the second portion of the 4 on 3 sequence above, the red player on the left wing has the ball and penetrates towards the cage. Her teammates spread the field away from the ball so that they can stay open and available to help the dribbler if she is attacked. (Fig. 10-16)
- In the last portion of the 4 on 3 sequence (Fig. 10-17), the red dribbler is committed to by the nearest white defender and by the goalie. At this point, the red dribbler passes the ball to her teammate on the far post who then quickly shoots, beating the goalie. (Notice that the furthest red player from the ball has moved to the right in order to allow for the open passing lane and assist.)

CHAPTER 10

Fast Break or Counterattack Offense and Defense



Fig. 10-17. Cross Pass from the Red team left wing to the far post beating the Goalie

Additional Thoughts Regarding Offense On the Fast Break

- 1) Fast breaking is very physically demanding – players must be in superior condition to do this style regularly.
- 2) Developing court sense and positioning takes time – coaches and players must build from simple to complex and players must try different positions in order to be a consistent contributor to the fast break.
- 3) Use “trailers” when practicing drills simulating the advantage situations. Have these players start well after the initial wave of players goes towards the cage (use a second whistle for this).
- 4) A good cross cage pass will almost always beat the goalie because the ball travels much faster than (s)he does.
- 5) Realize that from 4 on 3 on up, the complexity of positioning increases and these are not necessarily high percentage scoring opportunities. The table below (Fig. 10-18), shows a team’s vulnerability if they force a pass or shot and perhaps give the ball to the other team. Be careful! The objective is not always to score on a fast break but also to wear down the opponent, set up the offense, and put pressure on the defense .

Offense advantage	Defense opportunity
1-0	6-5
2-1	5-4
3-2	4-3
4-3	3-2
5-4	2-1
6-5	1-0

Fig. 10-18.

Counterattack Defense

“A team is most vulnerable to defense when it’s on offense.” (proverb)

Things to keep in mind when transitioning to defense:

- Keep a balanced offensive formation – spread, not too many players (< 3) committed inside the 2-4m. line when attacking. This allows more players to contribute sooner to the defensive end.
- Do not watch shots or turnovers. Overcome the habit of spectating to see if the shot goes in or the ball changes hands. In both of these instances, the offensive players should be rotating back to defense.
- Seal off the paths of the offensive players towards the other end of the pool. In the figure above, all six of the offensive players are moving into the paths of the defenders in order to alter their paths towards the offensive end of the pool. (Fig. 10-19)

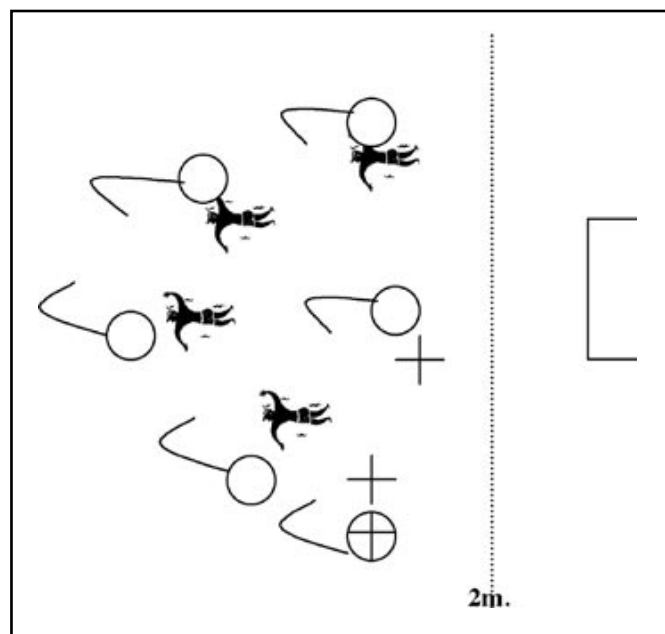

Fig. 10-19. “Sealing off” opposition

- HELP to the center of the pool (also called “jamming center”), preferably doing back-stroke so as to be able to see the offensive players that may be open. The shortest distance between two points is a straight line; therefore, the middle is the quickest spot to go to in order to cover a free offensive player.
- FOUL and DROP – if there is a free player advancing without the ball, the defender on the ball should foul him(her) in order to pick up the free offensive player. This foul dis-

CHAPTER 10

Fast Break or Counterattack Offense and Defense

allows the dribbler the opportunity to shoot if inside 5 meters. (Fig. 6-25, 6-26)

- “Stunt” the dribbler – if there is not time to foul the dribbler as in letter E above, the defender should take a couple of quick strokes out to the ball and then rapidly come back to the center so as to slow him(her) down. (Fig. 6-32)
- Go back on the CHERRY PICKER – the goalie should call this out. It is better to play five on five rather than leave one player open for an uncontested shot.
- Field players guard the player the goalie designates.....(s)he is the last line of defense.

References:

Barnett, Bill . Level Three Coaching Manual. Colorado Springs, Colorado: U.S. Water Polo, 1998, pp.2-11, 62-3.

Ibid. Level Two Manual, 1996.

Dettamanti, Dante, “Effective Defense of the Counterattack,” National Coaches Clinic, Irvine, California, 1993, pp.29-36

Ibid. “The Counterattack,” N.C.A.A. Yes Water Polo Clinic, 1998.

Gaughran, Robert and Arthur F. Lambert. The Technique of Water Polo. Los Angeles, Swimming World, 1969.

Hart, David. Level II Coaching Manual. Ottawa, Ontario: Canadian Water Polo Association, Inc., 1978.

Horn, Robert, “U.C.L.A. Counterattack,” Irvine, Ca: National Swimming & Water Polo Clinic, May 1990.

Nitzkowski, Monte. United States Tactical Water Polo. Pittsburg, Pa: Sports Syndicate, 1994, chapter 5.

Appendix #1

Modern Olympic Games Water Polo Medal Winners, Men's Competition, 1900-2012



Belgium: 4 silver, 2 bronze



Croatia: 1 gold, 1 silver

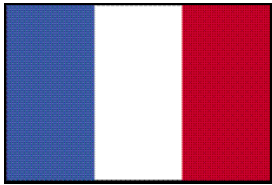

France: 1 gold, 4 silver



Germany: 1 gold, 2 silver, 1 bronze



Great Britain: 4 gold



Hungary: 9 gold, 3 silver, 3 bronze



Italy: 3 gold, 2 silver, 2 bronze



Netherlands: 2 bronze



Russia: 2 gold, 3 silver, 5 bronze



Spain: 1 gold, 1 silver



Sweden: 1 silver, 2 bronze



U.S.A.: 1 gold, 4 silver, 4 bronze



Serbia: 1 silver, 1 bronze



Yugoslavia: 3 gold, 4 Silver, 2 bronze

Appendix #2

Modern Olympic Games Water Polo Medal Winners, Women's Competition, 2000-2012



Australia: 1 gold, 2 bronze



Greece: 1 silver



Italy: 1 gold



Netherlands: 1 gold



Russia: 1 bronze



Spain: 1 silver

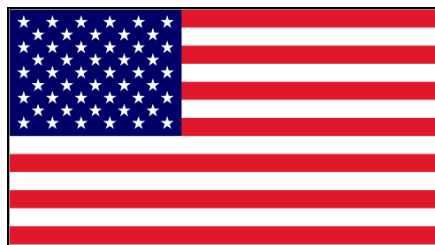

U.S.A.: 1 gold, 2 silver, 1 bronze

Appendix 3

Stretching

Stretching of musculature and joints is beneficial for optimal range of motion and performance, as well as prevention of injury. It is recommended that the core body temperature be elevated prior to performing these exercises, preferably by light conditioning for a period of minutes.

When performing a stretch, recommended time elapsed 15 seconds, with no bouncing movements to risk injury to tendons. Ease carefully through the motion and try to increase range of stretch over time. Regularity of stretching is a key. These should be done prior to and after conditioning.

It is particularly imperative to stretch around multiple matches so as to enhance muscular receptivity. Remember that water polo utilizes over thirty-five muscle groups in the body.

References:

Fosdick, Dennis. FINA Water Polo Manual. Lusanne, Sw: FINA,1990.

Stockdale, John C. Water Polo Canada Coaching Certification Program Level 1 – Basic Coach. Ottawa, Can.: Coaching Association of Canada, 1977.

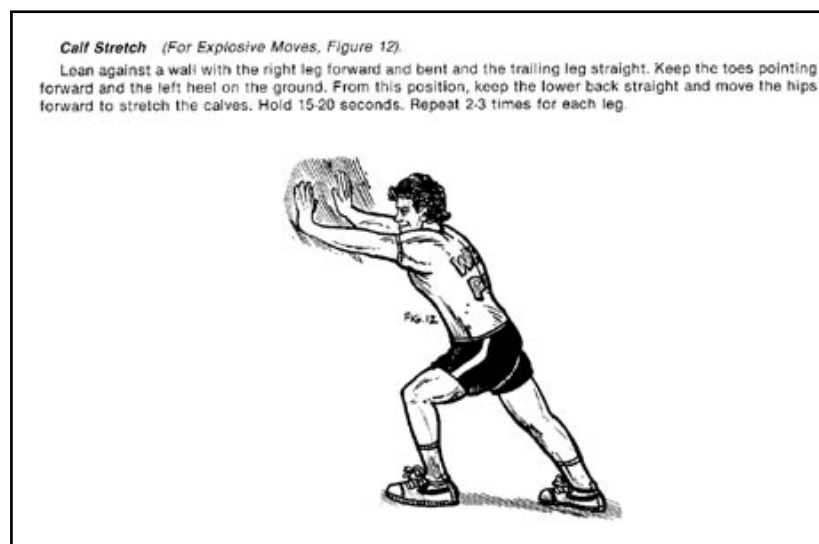

Groin Stretch (For "Eggbeater" Kick, Goalies, and Two-Meter Kick, Figure 9).

From a sitting position with the legs bent and the soles of the feet pressed together, grasp the ankles and press the elbows downward against the inner thigh to stretch the groin. Hold for 20-seconds and repeat 3-5 times.



Hamstring Stretch (For Explosive Kicks and Start, Figure 10).

From a supine position with the legs straight, bend the right leg at the hip (keeping the knee bent) and hold with the hands on the back of the thigh. Keep the toes pointing toward the shin and straighten the leg to stretch the hamstrings. Hold for ten seconds. Repeat 3-5 times for each leg.

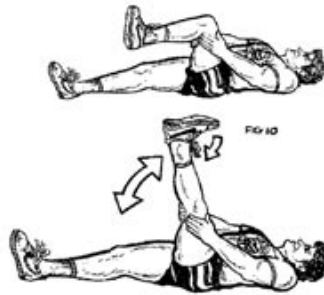

Quadriceps Stretch (For Explosive Starts and "Eggbeater" Kick, Figure 11A).

From a prone position with the legs straight and together, grab the right foot or ankle and pull the heel towards the buttocks to stretch the upper thigh. Remember to keep the knees together (Figure 11B and 11C), and the hips contacting the floor. Hold for ten seconds. Repeat 3-5 times for each leg. CAUTION: Do not stretch the knee to the point of pain. Avoid this stretch if you experience knee problems.



Trunk and Hip Stretch ("Pretzel Stretch" For Trunk Mobility and Changing Directions In The Water, Figure 8A).

From a straight leg sitting position, cross the right leg over the left so that the foot is resting flat on the floor above the knee. Put the left elbow on the outside of the bent-knee and push against the knee to rotate the shoulders away from the push. Hold 10-seconds. Repeat 3-5 times for each side. Variation (Figure 8B); bend both legs to increase the stretch to the hip.



Lower Trunk Stretch (For "Head-High" Swimming, Figure 7).

From a prone position with the hands beneath the shoulders, straighten the arms (as in a push-up with the legs and hips left on the floor), and arch the trunk upward while exhaling. Keep the head up as though "dribbling" and hold for five seconds. Return the starting position and repeat 3-5 times.

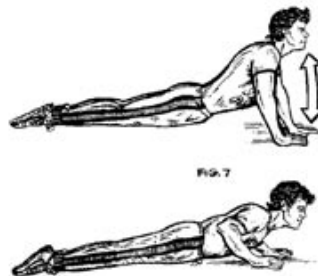

Shoulder Stretch (For Swimming and Throwing, Figure 2).

Place the right palm on the left shoulder with the elbow up and pointing forward. Reach over the arm with the left hand and grasp the back of the right arm slightly above the elbow. Turn the head to the right and pull the right arm across the body. Hold for 10 seconds. Repeat 2-4 times for each arm in a standing or sitting position.



Shoulder and Lat Stretch (For Swimming, Figure 5).

From all fours with the arms extended forward, sit back so that a stretch is felt along the arms, shoulders, sides and upper back. Hold 15 seconds and repeat 3-5 times.



Forearm and Wrist Stretch (For Swimming and Wrist-Shots, Figure 6).

From all fours with the palms flat and the fingers pointing toward the knees, sit back to stretch the front part of the forearms. Hold for 20 seconds and repeat 3-5 times. CAUTION: Remember to stretch only to a point of "slight" discomfort.



Arm and Shoulder Wall Stretch (For Swimming and Throwing, Figure 3).

Stand with the right side to a wall and the right palm against the wall with the arm held straight at shoulder level. While maintaining contact with the wall, rotate the trunk and reach behind so that the left hand moves toward the right. Hold 15 seconds. Repeat 3-5 times for each side.



APPENDIX 3



Appendix 4

Specific Strength Training

In order to prevent injury, rehabilitate and strengthen musculature for the passing and shooting motions, certain prescribed movements, resistance exercises, and stretching should be done before and during the season. A general bodily warm-up would be beneficial prior to doing these exercises and stretches, so as to elevate core temperature and enhance muscle performance.

The major focus of these movements is to strengthen and elongate musculature that is not used to the extent that it should in relation to other more prominent muscle groups; therefore, creating a disparity between stronger and weaker muscle groups.

Upcoming are samples of these exercises.

ROTATOR CUFF, SUPPORTING MUSCLE GROUPS –

Reference:

Jobe, Frank, et.al. Shoulder and Arm Exercises for Baseball Players. Inglewood, CA: Centinela Hospital, 1982.

To summarize, the object of conditioning, warm-up and the rest of good body mechanics is to allow the player to operate at a level just below that which would cause him injury, but yet generates enough energy and force to strike out a player of equal ability.

The exercises are presented here for the first time. They have been prepared for sports medicine physicians and coaches and are meant to be used only under their supervision.

Frank W. Jobe, M.D., Director
Biomechanics Laboratory
Centinela Hospital Medical Center
Inglewood, California 90307

COMPONENTS OF ROTATOR CUFF

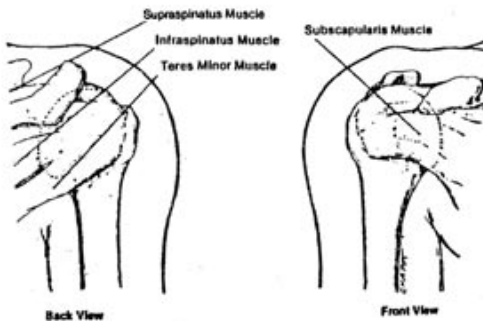

The above four muscles, underlying the deltoid muscle, are widely termed the "rotator cuff." Together they have an essential steadying effect on the head of the humerus.

Rotator cuff stretch with arm overhead.

Finally, this exercise should be repeated with your arm as far overhead as possible. Your head should remain supported while the shoulder itself is over the table edge. Again, just allow the weight to pull your arm down gently.



Posterior cuff stretch.

The back portion of the shoulder joint can be stretched out in this position, by gently pulling your arm across your body.



Inferior cuff stretch.

The other portions of the rotator cuff can be stretched by reaching overhead and gently pulling on your elbow with the opposite hand.



SHOULDER AND ARM EXERCISES FOR BASEBALL PLAYERS

Stretching the Rotator Cuff

Rotator cuff stretch at 90°

The capsule around the shoulder joint needs to be stretched before maximum movement can be obtained. Begin these exercises on a table with a small weight in your hand. Your shoulder should be over the table edge and elbow bent to 90°. Just allow the weight to pull your arm down gently in this position.



Rotator cuff stretch with arm at 135°.

During static flexibility exercises a particular position is held for a period of time. Static stretching is the best way to initiate a sequence. After stretching, a muscle can be gently moved through the range of motion. In this exercise, raising your arm another 35° stretches more of the tissue surrounding the shoulder.



Strengthening the Shoulder Muscles

Although it may not seem to take enormous strength to throw a baseball, conditioning and endurance are still necessary. The strengthening exercises you will see in the next few drawings can be started with just a few pounds of weight and increased as time goes on.



Supraspinatus.

The rotator cuff in the shoulder needs to be strengthened separately from the other shoulder muscles. This first exercise should be done with the elbow straight and thumb turned toward the floor. Rather than putting the arm straight out to the side, slowly raise your arm in a plane about 30° forward of that posture. Do not lift your arm higher than just below shoulder level; slowly lower it to the starting position and repeat.

Lower trapezius

To strengthen muscles lower in your back, remain in the same position on the table and, this time, raise your arm behind you as high as possible, remembering to keep your elbow straight.



Strengthening the Forearm and Elbow

Elbow Flexion

The muscles in the arm which surround the wrist and elbow must be strengthened as well. The biceps can be exercised in a number of ways, one of which is demonstrated here in the standing position. Keeping the elbow held at the side, lift the weight slowly by bending the elbow, and then return slowly to the starting position.



Forearm supination.

The musculature of the forearm and wrist plays an important part in the ultimate control of the ball. To strengthen the forearm, two separate exercises can be done. First, while seated at a table and holding a bar weighted at one end, rotate your forearm until the bar is pointed at the ceiling.



Forearm pronation.

The second forearm exercise is also done seated, only this time with palm turned up while holding onto the weighted bar. Rotate the bar from right to left, until it is pointed straight up to the ceiling. Pay some attention to keeping your elbow as motionless as possible.



Triceps

To exercise the triceps muscle, lie on your back with your throwing arm extended up towards the ceiling, and have your elbow completely flexed. Use your opposite hand to help support your arm, just below the elbow. Then, extend the elbow completely while holding onto a weight.



External rotation.

Another part of the rotator cuff can be strengthened by lying on your side with your elbow held close against your ribs. Slowly raise the weight until it is pointed at the ceiling, and then lower it in a controlled fashion.



Internal rotation.

The other portion of the rotator cuff should be exercised while lying on your back. Again, with your arm at the side, raise the weight until it is pointed toward the ceiling and then lower it slowly back to the starting position.



Shoulder abduction.

Lifting the weight out to the side and then overhead strengthens the central part of the deltoid, which is one of the most powerful muscles in the shoulder. Note how the hand slowly changes position as the exercise progresses until the palm faces the opposite side as your arm reaches straight overhead.



Shoulder flexion.

This particular exercise strengthens a portion of the deltoid as well as other muscles in the front of the shoulder. In this and in succeeding exercises it is important to move the weights slowly, controlling both the lifting and lowering. The elbow should be kept straight throughout the exercise.



Strengthening the Back Muscles

Rhomboids

Back muscles are also important in throwing. Lying on your stomach, grasp the weight firmly and raise it until your arm is straight out to the side, keeping the elbow extended. Slowly lower it to the starting position.

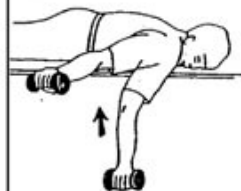

Strengthening the Wrist

Wrist flexion

There are several exercises which can help strengthen the wrist muscles. This one is done while seated, with the forearm supported on the table and the wrist over the edge, palm facing up. Use the opposite hand to help stabilize the forearm. Lift the weight slowly, flexing the wrist, and then lower the weight back to the starting position.



Wrist extension

While in the same position as the previous exercise, this time turn the palm down toward the floor. Lift the weight by extending the wrist and then lower it back to the original position.



Ulnar deviation

To strengthen the muscles which control the side to side motion occurring at the wrist, stand with your arm at your side, holding onto the end of a weighted bar. Lift the weight as shown here by bending the wrist laterally. Return slowly to the starting position.



These exercises should be done daily. Begin the program by doing two sets of 10 each, using a light (two pound) weight for resistance. The amount of weight can be increased later, but this should be done gradually so that it does not cause soreness.

We hope that by working on these specific shoulder and arm conditioning and strengthening techniques, you may be able to avoid injury and to improve the efficiency of your throwing motion.