

Guide to Meteorological Instruments and Methods of Observation



**World
Meteorological
Organization**

Weather • Climate • Water

WMO-No. 8

Weather • Climate • Water

Guide to Meteorological Instruments and Methods of Observation

WMO-No. 8

Seventh edition

2008



**World
Meteorological
Organization**
Weather • Climate • Water

WMO-No. 8

© World Meteorological Organization, 2008

The right of publication in print, electronic and any other form and in any language is reserved by WMO. Short extracts from WMO publications may be reproduced without authorization, provided that the complete source is clearly indicated. Editorial correspondence and requests to publish, reproduce or translate this publication in part or in whole should be addressed to:

Chairperson, Publications Board
World Meteorological Organization (WMO)
7 *bis*, avenue de la Paix
P.O. Box No. 2300
CH-1211 Geneva 2, Switzerland

Tel.: +41 (0) 22 730 84 03
Fax: +41 (0) 22 730 80 40
E-mail: publications@wmo.int

ISBN 978-92-63-10008-5

NOTE

The designations employed in WMO publications and the presentation of material in this publication do not imply the expression of any opinion whatsoever on the part of the Secretariat of WMO concerning the legal status of any country, territory, city or area, or of its authorities, or concerning the delimitation of its frontiers or boundaries.

Opinions expressed in WMO publications are those of the authors and do not necessarily reflect those of WMO. The mention of specific companies or products does not imply that they are endorsed or recommended by WMO in preference to others of a similar nature which are not mentioned or advertised.

PREFACE

One of the purposes of the World Meteorological Organization (WMO) is to coordinate the activities of its 188 Members in the generation of data and information on weather, climate and water, according to internationally agreed standards. With this in mind, each session of the World Meteorological Congress adopts Technical Regulations which lay down the meteorological practices and procedures to be followed by WMO Members. These Technical Regulations are supplemented by a number of Manuals and Guides which describe in more detail the practices, procedures and specifications that Members are requested to follow and implement. While Manuals contain mandatory practices, Guides such as this one contain recommended practices.

The first edition of the *Guide to Meteorological Instruments and Methods of Observation* was published in 1954 and consisted of twelve chapters. Since then, standardization has remained a key concern of the Commission for Instruments and Methods of Observation (CIMO) activities, and CIMO has periodically reviewed the contents of the Guide, making recommendations for additions and amendments whenever appropriate.

The present, seventh, edition is a fully revised version which includes additional topics and chapters reflecting recent technological developments. Its purpose, as with the previous editions, is to give comprehensive and up-to-date guidance on the most effective practices for carrying out meteorological observations and measurements. This edition was prepared through the collaborative efforts of 42 experts from 17 countries and was adopted by the fourteenth session of CIMO (Geneva, December 2006).

The Guide describes most instruments, systems and techniques in regular use, from the simplest to the most complex and sophisticated, but does not attempt to deal with methods and instruments used only for research or experimentally. Furthermore,

the Guide is not intended to be a detailed instruction manual for use by observers and technicians, but rather, it is intended to provide the basis for the preparation of manuals by National Meteorological and Hydrological Services (NMHSs) or other interested users operating observing systems, to meet their specific needs. However, no attempt is made to specify the fully detailed design of instruments, since to do so might hinder their further development. It was instead considered preferable to restrict standardization to the essential requirements and to confine recommendations to those features which are generally most common to various configurations of a given instrument or measurement system.

Although the Guide is written primarily for NMHSs, many other organizations and research and educational institutions taking meteorological observations have found it useful, so their requirements have been kept in mind in the preparation of the Guide. Additionally, many instrument manufacturers have recognized the usefulness of the Guide in the development and production of instruments and systems especially suited to Members' needs. Because of the considerable demand for this publication, a decision was taken to make it available on the WMO website to all interested users.

Therefore, on behalf of WMO, I wish to express my gratitude to all those NMHSs, technical commissions, expert teams and individuals who have contributed to this publication.



(M. Jarraud)
Secretary-General

CONTENTS

	<i>Page</i>
PART I. MEASUREMENT OF METEOROLOGICAL VARIABLES	
CHAPTER 1. General.....	I.1-1
CHAPTER 2. Measurement of temperature	I.2-1
CHAPTER 3. Measurement of atmospheric pressure	I.3-1
CHAPTER 4. Measurement of humidity	I.4-1
CHAPTER 5. Measurement of surface wind.....	I.5-1
CHAPTER 6. Measurement of precipitation	I.6-1
CHAPTER 7. Measurement of radiation	I.7-1
CHAPTER 8. Measurement of sunshine duration	I.8-1
CHAPTER 9. Measurement of visibility	I.9-1
CHAPTER 10. Measurement of evaporation.....	I.10-1
CHAPTER 11. Measurement of soil moisture	I.11-1
CHAPTER 12. Measurement of upper-air pressure, temperature and humidity	I.12-1
CHAPTER 13. Measurement of upper wind.....	I.13-1
CHAPTER 14. Present and past weather; state of the ground	I.14-1
CHAPTER 15. Observation of clouds.....	I.15-1
CHAPTER 16. Measurement of ozone	I.16-1
CHAPTER 17. Measurement of atmospheric composition.....	I.17-1

PART II. OBSERVING SYSTEMS

CHAPTER 1. Measurements at automatic weather stations	II.1-1
CHAPTER 2. Measurements and observations at aeronautical meteorological stations.....	II.2-1
CHAPTER 3. Aircraft observations.....	II.3-1
CHAPTER 4. Marine observations	II.4-1
CHAPTER 5. Special profiling techniques for the boundary layer and the troposphere	II.5-1
CHAPTER 6. Rocket measurements in the stratosphere and mesosphere.....	II.6-1
CHAPTER 7. Locating the sources of atmospherics.....	II.7-1
CHAPTER 8. Satellite observations	II.8-1
CHAPTER 9. Radar measurements.....	II.9-1
CHAPTER 10. Balloon techniques	II.10-1
CHAPTER 11. Urban observations.....	II.11-1
CHAPTER 12. Road Meteorological Measurements.....	II.12-1

PART III. QUALITY ASSURANCE AND MANAGEMENT OF OBSERVING SYSTEMS

CHAPTER 1. Quality management	III.1-1
CHAPTER 2. Sampling meteorological variables.....	III.2-1
CHAPTER 3. Data reduction	III.3-1
CHAPTER 4. Testing, calibration and intercomparison.....	III.4-1
CHAPTER 5. Training of instrument specialists.....	III.5-1
LIST OF CONTRIBUTORS TO THE GUIDE	III.3-1

PART I

MEASUREMENT OF METEOROLOGICAL VARIABLES

PART I. MEASUREMENT OF METEOROLOGICAL VARIABLES

CONTENTS

	<i>Page</i>
CHAPTER 1. GENERAL.....	I.1-1
1.1 Meteorological observations.....	I.1-1
1.2 Meteorological observing systems	I.1-2
1.3 General requirements of a meteorological station	I.1-2
1.4 General requirements of instruments.....	I.1-6
1.5 Measurement standards and definitions	I.1-7
1.6 Uncertainty of measurements	I.1-9
Annex 1.A. Regional centres	I.1-17
Annex 1.B. Operational measurement uncertainty requirements and instrument performance	I.1-19
Annex 1.C. Station exposure description	I.1-25
References and further reading	I.1-27
CHAPTER 2. MEASUREMENT OF TEMPERATURE.....	I.2-1
2.1 General.....	I.2-1
2.2 Liquid-in-glass thermometers	I.2-4
2.3 Mechanical thermographs	I.2-10
2.4 Electrical thermometers	I.2-11
2.5 Radiation shields.....	I.2-16
Annex. Defining the fixed points of the international temperature scale of 1990	I.2-18
References and further reading	I.2-20
CHAPTER 3. MEASUREMENT OF ATMOSPHERIC PRESSURE	I.3-1
3.1 General.....	I.3-1
3.2 Mercury barometers.....	I.3-3
3.3 Electronic barometers	I.3-8
3.4 Aneroid barometers.....	I.3-11
3.5 Barographs	I.3-12
3.6 Bourdon-tube barometers	I.3-13
3.7 Barometric change	I.3-13
3.8 General exposure requirements.....	I.3-14
3.9 Barometer exposure	I.3-14
3.10 Comparison, calibration and maintenance.....	I.3-15
3.11 Adjustment of barometer readings to other levels	I.3-20
3.12 Pressure tendency and pressure tendency characteristic	I.3-21
Annex 3.A. Correction of barometer readings to standard conditions	I.3-22
Annex 3.B. Regional standard barometers.....	I.3-25
References and further reading	I.3-26
CHAPTER 4. MEASUREMENT OF HUMIDITY	I.4-1
4.1 General.....	I.4-1
4.2 The psychrometer	I.4-6
4.3 The hair hygrometer	I.4-12
4.4 The chilled-mirror dewpoint hygrometer.....	I.4-14
4.5 The lithium chloride heated condensation hygrometer (dew cell).....	I.4-17

4.6	Electrical resistive and capacitive hygrometers	I.4-20
4.7	Hygrometers using absorption of electromagnetic radiation	I.4-21
4.8	Safety	I.4-21
4.9	Standard instruments and calibration	I.4-23
	Annex 4.A. Definitions and specifications of water vapour in the atmosphere.....	I.4-26
	Annex 4.B. Formulae for the computation of measures of humidity	I.4-29
	References and further reading	I.4-30
CHAPTER 5. MEASUREMENT OF SURFACE WIND.....		I.5-1
5.1	General.....	I.5-1
5.2	Estimation of wind	I.5-3
5.3	Simple instrumental methods	I.5-4
5.4	Cup and propeller sensors	I.5-4
5.5	Wind-direction vanes.....	I.5-5
5.6	Other wind sensors	I.5-5
5.7	Sensors and sensor combinations for component resolution	I.5-6
5.8	Data-processing methods.....	I.5-6
5.9	Exposure of wind instruments.....	I.5-8
5.10	Calibration and maintenance.....	I.5-11
	Annex. The effective roughness length	I.5-12
	References and further reading	I.5-13
CHAPTER 6. MEASUREMENT OF PRECIPITATION		I.6-1
6.1	General.....	I.6-1
6.2	Siting and exposure	I.6-3
6.3	Non-recording precipitation gauges	I.6-3
6.4	Precipitation gauge errors and corrections	I.6-6
6.5	Recording precipitation gauges	I.6-8
6.6	Measurement of dew, ice accumulation and fog precipitation	I.6-11
6.7	Measurement of snowfall and snow cover	I.6-14
	Annex 6.A. Precipitation intercomparison sites	I.6-18
	Annex 6.B. Suggested correction procedures for precipitation measurements	I.6-19
	References and further reading	I.6-20
CHAPTER 7. MEASUREMENT OF RADIATION.....		I.7-1
7.1	General.....	I.7-1
7.2	Measurement of direct solar radiation.....	I.7-5
7.3	Measurement of global and diffuse sky radiation	I.7-11
7.4	Measurement of total and long-wave radiation	I.7-19
7.5	Measurement of special radiation quantities	I.7-24
7.6	Measurement of UV radiation	I.7-25
	Annex 7.A. Nomenclature of radiometric and photometric quantities	I.7-31
	Annex 7.B. Meteorological radiation quantities, symbols and definitions	I.7-33
	Annex 7.C. Specifications for world, regional and national radiation centres	I.7-35
	Annex 7.D. Useful formulae	I.7-37
	Annex 7.E. Diffuse sky radiation – correction for a shading ring.....	I.7-39
	References and further reading	I.7-40

	<i>Page</i>
CHAPTER 8. MEASUREMENT OF SUNSHINE DURATION	I.8-1
8.1 General.....	I.8-1
8.2 Instruments and sensors.....	I.8-3
8.3 Exposure of sunshine detectors	I.8-7
8.4 General sources of error	I.8-7
8.5 Calibration	I.8-7
8.6 Maintenance	I.8-9
Annex. Algorithm to estimate sunshine duration from direct global irradiance measurements	I.8-10
References and further reading.....	I.8-11
 CHAPTER 9. MEASUREMENT OF VISIBILITY	I.9-1
9.1 General.....	I.9-1
9.2 Visual estimation of meteorological optical range.....	I.9-5
9.3 Instrumental measurement of the meteorological optical range.....	I.9-8
References and further reading.....	I.9-15
 CHAPTER 10. MEASUREMENT OF EVAPORATION.....	I.10-1
10.1 General.....	I.10-1
10.2 Atmometers.....	I.10-2
10.3 Evaporation pans and tanks	I.10-3
10.4 Evapotranspirometers (lysimeters)	I.10-6
10.5 Estimation of evaporation from natural surfaces	I.10-7
References and further reading.....	I.10-10
 CHAPTER 11. MEASUREMENT OF SOIL MOISTURE.....	I.11-1
11.1 General.....	I.11-1
11.2 Gravimetric direct measurement of soil water content	I.11-3
11.3 Soil water content: indirect methods	I.11-4
11.4 Soil water potential instrumentation	I.11-6
11.5 Remote sensing of soil moisture.....	I.11-8
11.6 Site selection and sample size.....	I.11-9
References and further reading.....	I.11-10
 CHAPTER 12. MEASUREMENT OF UPPER-AIR PRESSURE, TEMPERATURE AND HUMIDITY	I.12-1
12.1 General.....	I.12-1
12.2 Radiosonde electronics	I.12-6
12.3 Temperature sensors.....	I.12-7
12.4 Pressure sensors.....	I.12-9
12.5 Relative humidity sensors.....	I.12-12
12.6 Ground station equipment.....	I.12-15
12.7 Radiosonde operations.....	I.12-16
12.8 Radiosondes errors	I.12-18
12.9 Comparison, calibration and maintenance.....	I.12-28
12.10 Computations and reporting.....	I.12-31
Annex 12.A. Accuracy requirements (standard error) for upper-air measurements for synoptic meteorology, interpreted for conventional upper-air and wind measurements	I.12-34

Annex 12.B. Performance limits for upper wind and radiosonde temperature, relative humidity and geopotential height	I.12-35
Annex 12.C. Guidelines for organizing radiosonde intercomparisons and for the establishment of test sites	I.12-40
References and further reading	I.12-44
CHAPTER 13. MEASUREMENT OF UPPER WIND	I.13-1
13.1 General.....	I.13-1
13.2 Upper-wind sensors and instruments.....	I.13-4
13.3 Measurement methods	I.13-10
13.4 Exposure of ground equipment.....	I.13-12
13.5 Sources of error	I.13-13
13.6 Comparison, calibration and maintenance.....	I.13-18
13.7 Corrections.....	I.13-19
References and further reading.....	I.13-21
CHAPTER 14. PRESENT AND PAST WEATHER; STATE OF THE GROUND.....	I.14-1
14.1 General.....	I.14-1
14.2 Observation of present and past weather.....	I.14-2
14.3 State of the ground	I.14-5
14.4 Special phenomena.....	I.14-5
Annex. Criteria for light, moderate and heavy precipitation intensity	I.14-7
References and further reading.....	I.14-8
CHAPTER 15. OBSERVATION OF CLOUDS	I.15-1
15.1 General.....	I.15-1
15.2 Estimation and observation of cloud amount, height and type.....	I.15-3
15.3 Instrumental measurements of cloud amount.....	I.15-5
15.4 Measurement of cloud height using a searchlight	I.15-5
15.5 Measurement of cloud height using a balloon.....	I.15-7
15.6 Rotating-beam ceilometer.....	I.15-7
15.7 Laser ceilometer	I.15-8
References and further reading.....	I.15-11
CHAPTER 16. MEASUREMENT OF OZONE.....	I.16-1
16.1 General.....	I.16-1
16.2 Surface ozone measurements.....	I.16-3
16.3 Total ozone measurements	I.16-4
16.4 Measurements of the vertical profile of ozone	I.16-11
16.5 Corrections to ozone measurements	I.16-16
16.6 Aircraft and satellite observations	I.16-17
Annex 16.A. Units for total and local ozone	I.16-18
Annex 16.B. Measurement theory	I.16-20
References and further reading.....	I.16-22
CHAPTER 17. MEASUREMENT OF ATMOSPHERIC COMPOSITION	I.17-1
17.1 General.....	I.17-1
17.2 Measurement of specific variables	I.17-1
17.3 Quality assurance.....	I.17-10
References and further reading.....	I.17-12

CHAPTER 1

GENERAL

1.1 METEOROLOGICAL OBSERVATIONS

1.1.1 General

Meteorological (and related environmental and geophysical) observations are made for a variety of reasons. They are used for the real-time preparation of weather analyses, forecasts and severe weather warnings, for the study of climate, for local weather-dependent operations (for example, local aerodrome flying operations, construction work on land and at sea), for hydrology and agricultural meteorology, and for research in meteorology and climatology. The purpose of the *Guide to Meteorological Instruments and Methods of Observation* is to support these activities by giving advice on good practices for meteorological measurements and observations.

There are many other sources of additional advice, and users should refer to the references placed at the end of each chapter for a bibliography of theory and practice relating to instruments and methods of observation. The references also contain national practices, national and international standards, and specific literature. They also include reports published by the World Meteorological Organization (WMO) for the Commission for Instruments and Methods of Observation (CIMO) on technical conferences, instrumentation, and international comparisons of instruments. Many other Manuals and Guides issued by WMO refer to particular applications of meteorological observations (see especially those relating to the Global Observing System (WMO, 2003a; 1989), aeronautical meteorology (WMO, 1990), hydrology (WMO, 1994), agricultural meteorology (WMO, 1981) and climatology (WMO, 1983).

Quality assurance and maintenance are of special interest for instrument measurements. Throughout this Guide many recommendations are made in order to meet the stated performance requirements. Particularly, Part III of this Guide is dedicated to quality assurance and management of observing systems. It is recognized that quality management and training of instrument specialists is of utmost importance. Therefore, on the recommendation of CIMO,¹ several regional associations of WMO have

set up Regional Instrument Centres (RICs) to maintain standards and provide advice. Their terms of reference and locations are given in Annex 1.A.

The definitions and standards stated in this Guide (see section 1.5.1) will always conform to internationally adopted standards. Basic documents to be referred to are the *International Meteorological Vocabulary* (WMO, 1992a) and the *International Vocabulary of Basic and General Terms in Metrology* (ISO, 1993a).

1.1.2 Representativeness

The representativeness of an observation is the degree to which it accurately describes the value of the variable needed for a specific purpose. Therefore, it is not a fixed quality of any observation, but results from joint appraisal of instrumentation, measurement interval and exposure against the requirements of some particular application. For instance, synoptic observations should typically be representative of an area up to 100 km around the station, but for small-scale or local applications the considered area may have dimensions of 10 km or less.

In particular, applications have their own preferred timescales and space scales for averaging, station density and resolution of phenomena — small for agricultural meteorology, large for global long-range forecasting. Forecasting scales are closely related to the timescales of the phenomena; thus, shorter-range weather forecasts require more frequent observations from a denser network over a limited area in order to detect any small-scale phenomena and their quick development. Using various sources (WMO, 2003a; 2001; Orlanski, 1975), horizontal meteorological scales may be classified as follows, with a factor two uncertainty:

- (a) Microscale (less than 100 m) for agricultural meteorology, for example, evaporation;
- (b) Toposcale or local scale (100–3 km), for example, air pollution, tornadoes;
- (c) Mesoscale (3–100 km), for example, thunderstorms, sea and mountain breezes;
- (d) Large scale (100–3 000 km), for example, fronts, various cyclones, cloud clusters;
- (e) Planetary scale (larger than 3 000 km), for example, long upper tropospheric waves.

¹ Recommended by the Commission for Instruments and Methods of Observation at its ninth session (1985) through Recommendation 19.

Section 1.6 discusses the required and achievable uncertainties of instrument systems. The stated achievable uncertainties can be obtained with good instrument systems that are properly operated, but are not always obtained in practice. Good observing practices require skill, training, equipment and support, which are not always available in sufficient degree. The measurement intervals required vary by application: minutes for aviation, hours for agriculture, and days for climate description. Data storage arrangements are a compromise between available capacity and user needs.

Good exposure, which is representative on scales from a few metres to 100 km, is difficult to achieve (see section 1.3). Errors of unrepresentative exposure may be much larger than those expected from the instrument system in isolation. A station in a hilly or coastal location is likely to be unrepresentative on the large scale or mesoscale. However, good homogeneity of observations in time may enable users to employ data even from unrepresentative stations for climate studies.

1.1.3 Metadata

The purpose of this Guide and related WMO publications is to ensure reliability of observations by standardization. However, local resources and circumstances may cause deviations from the agreed standards of instrumentation and exposure. A typical example is that of regions with much snowfall, where the instruments are mounted higher than usual so that they can be useful in winter as well as summer.

Users of meteorological observations often need to know the actual exposure, type and condition of the equipment and its operation; and perhaps the circumstances of the observations. This is now particularly significant in the study of climate, in which detailed station histories have to be examined. Metadata (data about data) should be kept concerning all of the station establishment and maintenance matters described in section 1.3, and concerning changes which occur, including calibration and maintenance history and the changes in terms of exposure and staff (WMO, 2003*b*). Metadata are especially important for elements which are particularly sensitive to exposure, such as precipitation, wind and temperature. One very basic form of metadata is information on the existence, availability and quality of meteorological data and of the metadata about them.

1.2 METEOROLOGICAL OBSERVING SYSTEMS

The requirements for observational data may be met using in situ measurements or remote-sensing (including space-borne) systems, according to the ability of the various sensing systems to measure the elements needed. WMO (2003*a*) describes the requirements in terms of global, regional and national scales and according to the application area. The Global Observing System, designed to meet these requirements, is composed of the surface-based subsystem and the space-based subsystem. The surface-based subsystem comprises a wide variety of types of stations according to the particular application (for example, surface synoptic station, upper-air station, climatological station, and so on). The space-based subsystem comprises a number of spacecraft with on-board sounding missions and the associated ground segment for command, control and data reception. The succeeding paragraphs and chapters in this Guide deal with the surface-based system and, to a lesser extent, with the space-based subsystem. To derive certain meteorological observations by automated systems, for example, present weather, a so-called “multi-sensor” approach is necessary, where an algorithm is applied to compute the result from the outputs of several sensors.

1.3 GENERAL REQUIREMENTS OF A METEOROLOGICAL STATION

The requirements for elements to be observed according to the type of station and observing network are detailed in WMO (2003*a*). In this section, the observational requirements of a typical climatological station or a surface synoptic network station are considered.

The following elements are observed at a station making surface observations (the chapters refer to Part I of the Guide):

Present weather	(Chapter 14)
Past weather	(Chapter 14)
Wind direction and speed	(Chapter 5)
Cloud amount	(Chapter 15)
Cloud type	(Chapter 15)
Cloud-base height	(Chapter 15)
Visibility	(Chapter 9)
Temperature	(Chapter 2)
Relative humidity	(Chapter 4)

Atmospheric pressure	(Chapter 3)
Precipitation	(Chapter 6)
Snow cover	(Chapter 6)
Sunshine and/ or solar radiation	(Chapters 7, 8)
Soil temperature	(Chapter 2)
Evaporation	(Chapter 10)

Instruments exist which can measure all of these elements, except cloud type. However, with current technology, instruments for present and past weather, cloud amount and height, and snow cover are not able to make observations of the whole range of phenomena, whereas human observers are able to do so.

Some meteorological stations take upper-air measurements (Part I, Chapters 12 and 13), measurements of soil moisture (Part I, Chapter 11), ozone (Part I, Chapter 16) and atmospheric composition (Part I, Chapter 17), and some make use of special instrument systems as described in Part II of this Guide.

Details of observing methods and appropriate instrumentation are contained in the succeeding chapters of this Guide.

1.3.1 Automatic weather stations

Most of the elements required for synoptic, climatological or aeronautical purposes can be measured by automatic instrumentation (Part II, Chapter 1).

As the capabilities of automatic systems increase, the ratio of purely automatic weather stations to observer-staffed weather stations (with or without automatic instrumentation) increases steadily. The guidance in the following paragraphs regarding siting and exposure, changes of instrumentation, and inspection and maintenance apply equally to automatic weather stations and staffed weather stations.

1.3.2 Observers

Meteorological observers are required for a number of reasons, as follows:

- (a) To make synoptic and/or climatological observations to the required uncertainty and representativeness with the aid of appropriate instruments;
- (b) To maintain instruments, metadata documentation and observing sites in good order;

- (c) To code and dispatch observations (in the absence of automatic coding and communication systems);
- (d) To maintain in situ recording devices, including the changing of charts when provided;
- (e) To make or collate weekly and/or monthly records of climatological data where automatic systems are unavailable or inadequate;
- (f) To provide supplementary or back-up observations when automatic equipment does not make observations of all required elements, or when it is out of service;
- (g) To respond to public and professional enquiries.

Observers should be trained and/or certified by an authorized Meteorological Service to establish their competence to make observations to the required standards. They should have the ability to interpret instructions for the use of instrumental and manual techniques that apply to their own particular observing systems. Guidance on the instrument training requirements for observers will be given in Part III, Chapter 5.

1.3.3 Siting and exposure

1.3.3.1 Site selection

Meteorological observing stations are designed so that representative measurements (or observations) can be taken according to the type of station involved. Thus, a station in the synoptic network should make observations to meet synoptic-scale requirements, whereas an aviation meteorological observing station should make observations that describe the conditions specific to the local (aerodrome) site. Where stations are used for several purposes, for example, aviation, synoptic and climatological purposes, the most stringent requirement will dictate the precise location of an observing site and its associated sensors. A detailed study on siting and exposure is published in WMO (1993a).

As an example, the following considerations apply to the selection of site and instrument exposure requirements for a typical synoptic or climatological station in a regional or national network:

- (a) Outdoor instruments should be installed on a level piece of ground, preferably no smaller than 25 m x 25 m where there are many installations, but in cases where there are relatively few installations (as in Figure 1.1)

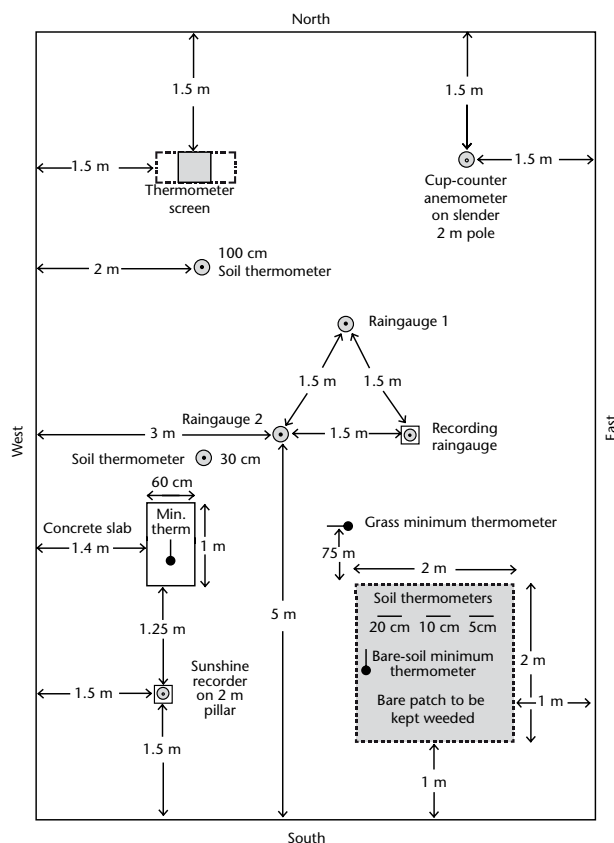

Figure 1.1. Layout of an observing station in the northern hemisphere showing minimum distances between installations

the area may be considerably smaller, for example, 10 m x 7 m (the enclosure). The ground should be covered with short grass or a surface representative of the locality, and surrounded by open fencing or palings to exclude unauthorized persons. Within the enclosure, a bare patch of ground of about 2 m x 2 m is reserved for observations of the state of the ground and of soil temperature at depths of equal to or less than 20 cm (Part I, Chapter 2) (soil temperatures at depths greater than 20 cm can be measured outside this bare patch of ground). An example of the layout of such a station is given in Figure 1.1 (taken from WMO, 1989);

- (b) There should be no steeply sloping ground in the vicinity, and the site should not be in a hollow. If these conditions are not met, the observations may show peculiarities of entirely local significance;
- (c) The site should be well away from trees, buildings, walls or other obstructions. The distance of any such obstacle (including

fencing) from the raingauge should not be less than twice the height of the object above the rim of the gauge, and preferably four times the height;

- (d) The sunshine recorder, raingauge and anemometer must be exposed according to their requirements, preferably on the same site as the other instruments;
- (e) It should be noted that the enclosure may not be the best place from which to estimate the wind speed and direction; another observing point, more exposed to the wind, may be desirable;
- (f) Very open sites which are satisfactory for most instruments are unsuitable for rain-gauges. For such sites, the rainfall catch is reduced in conditions other than light winds and some degree of shelter is needed;
- (g) If in the instrument enclosure surroundings, maybe at some distance, objects like trees or buildings obstruct the horizon significantly, alternative viewpoints should be selected for observations of sunshine or radiation;

- (h) The position used for observing cloud and visibility should be as open as possible and command the widest possible view of the sky and the surrounding country;
- (i) At coastal stations, it is desirable that the station command a view of the open sea. However, the station should not be too near the edge of a cliff because the wind eddies created by the cliff will affect the wind and precipitation measurements;
- (j) Night observations of cloud and visibility are best made from a site unaffected by extraneous lighting.

It is obvious that some of the above considerations are somewhat contradictory and require compromise solutions. Detailed information appropriate to specific instruments and measurements is given in the succeeding chapters.

1.3.3.2 Coordinates of the station

The position of a station referred to in the World Geodetic System 1984 (WGS-84) Earth Geodetic Model 1996 (EGM96) must be accurately known and recorded.² The coordinates of a station are:

- (a) The latitude in degrees with a resolution of 1 in 1 000;
- (b) The longitude in degrees with a resolution of 1 in 1 000;
- (c) The height of the station above mean sea level,³ namely, the elevation of the station, to the nearest metre.

These coordinates refer to the plot on which the observations are taken and may not be the same as those of the town, village or airfield after which the station is named.

The elevation of the station is defined as the height above mean sea level of the ground on which the rain gauge stands or, if there is no rain gauge, the ground beneath the thermometer screen. If there is neither rain gauge nor screen, it is the average level of terrain in the vicinity of the station. If the station reports pressure, the elevation to which the station pressure relates

must be separately specified. It is the datum level to which barometric reports at the station refer; such barometric values being termed “station pressure” and understood to refer to the given level for the purpose of maintaining continuity in the pressure records (WMO, 1993*b*).

If a station is located at an aerodrome, other elevations must be specified (see Part II, Chapter 2, and WMO, 1990). Definitions of measures of height and mean sea level are given in WMO (1992*a*).

1.3.4 Changes of instrumentation and homogeneity

The characteristics of an observing site will generally change over time, for example, through the growth of trees or erection of buildings on adjacent plots. Sites should be chosen to minimize these effects, if possible. Documentation of the geography of the site and its exposure should be kept and regularly updated as a component of the metadata (see Annex 1.C and WMO, 2003*b*).

It is especially important to minimize the effects of changes of instrument and/or changes in the siting of specific instruments. Although the static characteristics of new instruments might be well understood, when they are deployed operationally they can introduce apparent changes in site climatology. In order to guard against this eventuality, observations from new instruments should be compared over an extended interval (at least one year; see the *Guide to Climatological Practices* (WMO, 1983) before the old measurement system is taken out of service. The same applies when there has been a change of site. Where this procedure is impractical at all sites, it is essential to carry out comparisons at selected representative sites to attempt to deduce changes in measurement data which might be a result of changing technology or enforced site changes.

1.3.5 Inspection and maintenance

1.3.5.1 Inspection of stations

All synoptic land stations and principal climatological stations should be inspected no less than once every two years. Agricultural meteorological and special stations should be inspected at intervals sufficiently short to ensure the maintenance of a high standard of observations and the correct functioning of instruments.

2 For an explanation of the WGS-84 and recording issues, see ICAO, 2002.

3 Mean sea level (MSL) is defined in WMO, 1992*a*. The fixed reference level of MSL should be a well-defined geoid, like the WGS-84 Earth Geodetic Model 1996 (EGM96) [Geoid: the equipotential surface of the Earth's gravity field which best fits, in a least squares sense, global MSL].

The principal objective of such inspections is to ascertain that:

- (a) The siting and exposure of instruments are known, acceptable and adequately documented;
- (b) Instruments are of the approved type, in good order, and regularly verified against standards, as necessary;
- (c) There is uniformity in the methods of observation and the procedures for calculating derived quantities from the observations;
- (d) The observers are competent to carry out their duties;
- (e) The metadata information is up to date.

Further information on the standardization of instruments is given in section 1.5.

1.3.5.2 Maintenance

Observing sites and instruments should be maintained regularly so that the quality of observations does not deteriorate significantly between station inspections. Routine (preventive) maintenance schedules include regular “housekeeping” at observing sites (for example, grass cutting and cleaning of exposed instrument surfaces) and manufacturers’ recommended checks on automatic instruments. Routine quality control checks carried out at the station or at a central point should be designed to detect equipment faults at the earliest possible stage. Depending on the nature of the fault and the type of station, the equipment should be replaced or repaired according to agreed priorities and timescales. As part of the metadata, it is especially important that a log be kept of instrument faults, exposure changes, and remedial action taken where data are used for climatological purposes.

Further information on station inspection and management can be found in WMO (1989).

1.4 GENERAL REQUIREMENTS OF INSTRUMENTS

1.4.1 Desirable characteristics

The most important requirements for meteorological instruments are the following:

- (a) Uncertainty, according to the stated requirement for the particular variable;
- (b) Reliability and stability;
- (c) Convenience of operation, calibration and maintenance;

- (d) Simplicity of design which is consistent with requirements;
- (e) Durability;
- (f) Acceptable cost of instrument, consumables and spare parts.

With regard to the first two requirements, it is important that an instrument should be able to maintain a known uncertainty over a long period. This is much better than having a high initial uncertainty that cannot be retained for long under operating conditions.

Initial calibrations of instruments will, in general, reveal departures from the ideal output, necessitating corrections to observed data during normal operations. It is important that the corrections should be retained with the instruments at the observing site and that clear guidance be given to observers for their use.

Simplicity, strength of construction, and convenience of operation and maintenance are important since most meteorological instruments are in continuous use year in, year out, and may be located far away from good repair facilities. Robust construction is especially desirable for instruments that are wholly or partially exposed to the weather. Adherence to such characteristics will often reduce the overall cost of providing good observations, outweighing the initial cost.

1.4.2 Recording instruments

In many of the recording instruments used in meteorology, the motion of the sensing element is magnified by levers that move a pen on a chart on a clock-driven drum. Such recorders should be as free as possible from friction, not only in the bearings, but also between the pen and paper. Some means of adjusting the pressure of the pen on the paper should be provided, but this pressure should be reduced to a minimum consistent with a continuous legible trace. Means should also be provided in clock-driven recorders for making time marks. In the design of recording instruments that will be used in cold climates, particular care must be taken to ensure that their performance is not adversely affected by extreme cold and moisture, and that routine procedures (time marks, and so forth) can be carried out by the observers while wearing gloves.

Recording instruments should be compared frequently with instruments of the direct-reading type.

An increasing number of instruments make use of electronic recording in magnetic media or in semiconductor microcircuits. Many of the same considerations given for bearings, friction and cold-weather servicing apply to the mechanical components of such instruments.

1.5 MEASUREMENT STANDARDS AND DEFINITIONS

1.5.1 Definitions of standards of measurement

The term “standard” and other similar terms denote the various instruments, methods and scales used to establish the uncertainty of measurements. A nomenclature for standards of measurement is given in the *International Vocabulary of Basic and General Terms in Metrology*, which was prepared simultaneously by the International Bureau of Weights and Measures, the International Electrotechnical Commission, the International Federation of Clinical Chemistry, the International Organization for Standardization, the International Union of Pure and Applied Chemistry, the International Union of Pure and Applied Physics and the International Organization of Legal Metrology and issued by ISO (1993a). Some of the definitions are as follows:

(Measurement) standard: A material measure, measuring instrument, reference material or measuring system intended to define, realize, conserve or reproduce a unit or one or more values of a quantity to serve as a reference.

Examples: 1 kg mass standard
100 Ω standard resistor

Notes:

1. A set of similar material measures or measuring instruments that, through their combined use, constitutes a standard is called a “collective standard”.
2. A set of standards of chosen values that, individually or in combination, provides a series of values of quantities of the same kind is called a “group standard”.

International standard: A standard recognized by an international agreement to serve internationally as the basis for assigning values to other standards of the quantity concerned.

National standard: A standard recognized by a national decision to serve, in a country, as the basis

for assigning values to other standards of the same quantity.

Primary standard: A standard that is designated or widely acknowledged as having the highest metrological qualities and whose value is accepted without reference to other standards of the same quantity.

Secondary standard: A standard whose value is assigned by comparison with a primary standard of the same quantity.

Reference standard: A standard, generally having the highest metrological quality available at a given location or in a given organization, from which the measurements taken there are derived.

Working standard: A standard that is used routinely to calibrate or check material measures, measuring instruments or reference materials.

Notes:

1. A working standard is usually calibrated against a reference standard.
2. A working standard used routinely to ensure that measurements are being carried out correctly is called a “check standard”.

Transfer standard: A standard used as an intermediary to compare standards.

Note: The term “transfer device” should be used when the intermediary is not a standard.

Travelling standard: A standard, sometimes of special construction, intended for transport between different locations.

Collective standard: A set of similar material measures or measuring instruments fulfilling, by their combined use, the role of a standard.

Example: The World Radiometric Reference

Notes:

1. A collective standard is usually intended to provide a single value of a quantity.
2. The value provided by a collective standard is an appropriate mean of the values provided by the individual instruments.

Traceability: A property of the result of a measurement or the value of a standard whereby it can be related to stated references, usually national or international standards, through an unbroken chain of comparisons all having stated uncertainties.

Calibration: The set of operations which establish, under specified conditions, the relationship between values indicated by a measuring instrument or measuring system, or values represented by a material measure, and the corresponding known values of a measurand (the physical quantity being measured).

Notes:

1. The result of a calibration permits the estimation of errors of indication of the measuring instrument, measuring system or material measure, or the assignment of marks on arbitrary scales.
2. A calibration may also determine other metrological properties.
3. The result of a calibration may be recorded in a document, sometimes called a calibration certificate or calibration report.
4. The result of a calibration is sometimes expressed as a calibration factor, or as a series of calibration factors in the form of a calibration curve.

1.5.2 Procedures for standardization

In order to control effectively the standardization of meteorological instruments on a national and international scale, a system of national and regional standards has been adopted by WMO. The locations of the regional standards for pressure and radiation are given in Part I, Chapter 3 (Annex 3.B), and Part I, Chapter 7 (Annex 7.C), respectively. In general, regional standards are designated by the regional associations, and national standards by the individual Members. Unless otherwise specified, instruments designated as regional and national standards should be compared by means of travelling standards at least once every five years. It is not essential for the instruments used as travelling standards to possess the uncertainty of primary or secondary standards; they should, however, be sufficiently robust to withstand transportation without changing their calibration.

Similarly, the instruments in operational use at a Service should be periodically compared directly or indirectly with the national standards. Comparisons of instruments within a Service should, as far as possible, be made at the time when the instruments are issued to a station and subsequently during each regular inspection of the station, as recommended in section 1.3.5. Portable standard instruments used by inspectors should be checked against the standard instruments of the Service before and after each tour of inspection.

Comparisons should be carried out between operational instruments of different designs (or principles of operation) to ensure homogeneity of measurements over space and time (see section 1.3.4).

1.5.3 Symbols, units and constants

1.5.3.1 Symbols and units

Instrument measurements produce numerical values. The purpose of these measurements is to obtain physical or meteorological quantities representing the state of the local atmosphere. For meteorological practices, instrument readings represent variables, such as “atmospheric pressure”, “air temperature” or “wind speed”. A variable with symbol a is usually represented in the form $a = \{a\} \cdot [a]$, where $\{a\}$ stands for the numerical value and $[a]$ stands for the symbol for the unit. General principles concerning quantities, units and symbols are stated by ISO (1993*b*) and IUPAP (1987). The International System of Units (SI) should be used as the system of units for the evaluation of meteorological elements included in reports for international exchange. This system is published and updated by BIPM (1998). Guides for the use of SI are issued by NIST (1995) and ISO (1993*b*). Variables not defined as an international symbol by the International System of Quantities (ISQ), but commonly used in meteorology can be found in the *International Meteorological Tables* (WMO, 1966) and relevant chapters in this Guide.

The following units should be used for meteorological observations:

- (a) Atmospheric pressure, p , in hectopascals (hPa);⁴
- (b) Temperature, t , in degrees Celsius (°C) or T in kelvin (K);

Note: The Celsius and kelvin temperature scales should conform to the actual definition of the International Temperature Scale (for 2004: ITS-90, see BIPM, 1990).

- (c) Wind speed, in both surface and upper-air observations, in metres per second (m s^{-1});
- (d) Wind direction in degrees clockwise from north or on the scale 0–36, where 36 is the wind from the north and 09 the wind from the east (°);
- (e) Relative humidity, U , in per cent (%);
- (f) Precipitation (total amount) in millimetres (mm) or kilograms per m^{-2} (kg m^{-2});⁵

4 The unit “pascal” is the principal SI derived unit for the pressure quantity. The unit and symbol “bar” is a unit outside the SI system; in every document where it is used, this unit (bar) should be defined in relation to the SI. Its continued use is not encouraged. By definition, 1 mbar (millibar) = 1 hPa (hectopascal).

5 Assuming that 1 mm equals 1 kg m^{-2} independent of temperature.

- (g) Precipitation intensity, R_i , in millimetres per hour (mm h^{-1}) or kilograms per m^{-2} per second ($\text{kg m}^{-2} \text{s}^{-1}$);⁶
- (h) Snow water equivalent in kilograms per m^{-2} (kg m^{-2});
- (i) Evaporation in millimetres (mm);
- (j) Visibility in metres (m);
- (k) Irradiance in watts per m^2 and radiant exposure in joules per m^2 (W m^{-2} , J m^{-2});
- (l) Duration of sunshine in hours (h);
- (m) Cloud height in metres (m);
- (n) Cloud amount in oktas;
- (o) Geopotential, used in upper-air observations, in standard geopotential metres (m').

Note: Height, level or altitude are presented with respect to a well-defined reference. Typical references are Mean Sea Level (MSL), station altitude or the 1013.2 hPa plane.

The standard geopotential metre is defined as 0.980 665 of the dynamic metre; for levels in the troposphere, the geopotential is close in numerical value to the height expressed in metres.

1.5.3.2 Constants

The following constants have been adopted for meteorological use:

- (a) Absolute temperature of the normal ice point $T_0 = 273.15 \text{ K}$ ($t = 0.00^\circ\text{C}$);
- (b) Absolute temperature of the triple point of water $T = 273.16 \text{ K}$ ($t = 0.01^\circ\text{C}$), by definition of ITS-90;
- (c) Standard normal gravity (g_n) = $9.806 65 \text{ m s}^{-2}$;
- (d) Density of mercury at $0^\circ\text{C} = 1.359 51 \cdot 10^4 \text{ kg m}^{-3}$.

The values of other constants are given in WMO (1973; 1988).

1.6 UNCERTAINTY OF MEASUREMENTS

1.6.1 Meteorological measurements

1.6.1.1 General

This section deals with definitions that are relevant to the assessment of accuracy and the measurement of uncertainties in physical measurements, and concludes with statements of required and achievable uncertainties in meteorology. First, it discusses some issues that arise particularly in meteorological measurements.

The term *measurement* is carefully defined in section 1.6.2, but in most of this Guide it is used less strictly to mean the process of measurement or its result, which may also be called an “observation”. A *sample* is a single measurement, typically one of a series of spot or instantaneous readings of a sensor system, from which an average or smoothed value is derived to make an observation. For a more theoretical approach to this discussion, see Part III, Chapters 2 and 3.

The terms *accuracy*, *error* and *uncertainty* are carefully defined in section 1.6.2, which explains that accuracy is a qualitative term, the numerical expression of which is uncertainty. This is good practice and is the form followed in this Guide. Formerly, the common and less precise use of accuracy was as in “an accuracy of $\pm x$ ”, which should read “an uncertainty of x ”.

1.6.1.2 Sources and estimates of error

The sources of error in the various meteorological measurements are discussed in specific detail in the following chapters of this Guide, but in general they may be seen as accumulating through the chain of traceability and the measurement conditions.

It is convenient to take air temperature as an example to discuss how errors arise, but it is not difficult to adapt the following argument to pressure, wind and other meteorological quantities. For temperature, the sources of error in an individual measurement are as follows:

- (a) Errors in the international, national and working standards, and in the comparisons made between them. These may be assumed to be negligible for meteorological applications;
- (b) Errors in the comparisons made between the working, travelling and/or check standards and the field instruments in the laboratory or in liquid baths in the field (if that is how the traceability is established). These are small if the practice is good (say $\pm 0.1 \text{ K}$ uncertainty at the 95 per cent confidence level, including the errors in (a) above), but may quite easily be larger, depending on the skill of the operator and the quality of the equipment;
- (c) Non-linearity, drift, repeatability and reproducibility in the field thermometer and its transducer (depending on the type of thermometer element);
- (d) The effectiveness of the heat transfer between the thermometer element and the air in the thermometer shelter, which should ensure that the element is at thermal equilibrium

⁶ Recommendation 3 (CBS-XII), Annex 1, adopted through Resolution 4 (EC-LIII).

with the air (related to system time-constant or lag coefficient). In a well-designed aspirated shelter this error will be very small, but it may be large otherwise;

- (e) The effectiveness of the thermometer shelter, which should ensure that the air in the shelter is at the same temperature as the air immediately surrounding it. In a well-designed case this error is small, but the difference between an effective and an ineffective shelter may be 3°C or more in some circumstances;
- (f) The exposure, which should ensure that the shelter is at a temperature which is representative of the region to be monitored. Nearby sources and heat sinks (buildings, other unrepresentative surfaces below and around the shelter) and topography (hills, land-water boundaries) may introduce large errors. The station metadata should contain a good and regularly updated description of exposure (see Annex 1.C) to inform data users about possible exposure errors.

Systematic and random errors both arise at all the above-mentioned stages. The effects of the error sources (d) to (f) can be kept small if operations are very careful and if convenient terrain for siting is available; otherwise these error sources may contribute to a very large overall error. However, they are sometimes overlooked in the discussion of errors, as though the laboratory calibration of the sensor could define the total error completely.

Establishing the true value is difficult in meteorology (Linacre, 1992). Well-designed instrument comparisons in the field may establish the characteristics of instruments to give a good estimate of uncertainty arising from stages (a) to (e) above. If station exposure has been documented adequately, the effects of imperfect exposure can be corrected systematically for some parameters (for example, wind; see WMO, 2002) and should be estimated for others.

Comparing station data against numerically analysed fields using neighbouring stations is an effective operational quality control procedure, if there are sufficient reliable stations in the region. Differences between the individual observations at the station and the values interpolated from the analysed field are due to errors in the field as well as to the performance of the station. However, over a period, the average error at each point in the analysed field may be assumed to be zero if the surrounding stations are adequate for a sound

analysis. In that case, the mean and standard deviation of the differences between the station and the analysed field may be calculated, and these may be taken as the errors in the station measurement system (including effects of exposure). The uncertainty in the estimate of the mean value in the long term may, thus, be made quite small (if the circumstances at the station do not change), and this is the basis of climate change studies.

1.6.2 Definitions of measurements and their errors

The following terminology relating to the accuracy of measurements is taken from ISO (1993a), which contains many definitions applicable to the practices of meteorological observations. ISO (1995) gives very useful and detailed practical guidance on the calculation and expression of uncertainty in measurements.

Measurement: A set of operations having the objective of determining the value of a quantity.

Note: The operations may be performed automatically.

Result of a measurement: Value attributed to a measurand (the physical quantity that is being measured), obtained by measurement.

Notes:

1. When a result is given, it should be made clear whether it refers to the indication, the uncorrected result or the corrected result, and whether several values are averaged.
2. A complete statement of the result of a measurement includes information about the uncertainty of the measurement.

Corrected result: The result of a measurement after correction for systematic error.

Value (of a quantity): The magnitude of a particular quantity generally expressed as a unit of measurement multiplied by a number.

Example: Length of a rod: 5.34 m.

True value (of a quantity): A value consistent with the definition of a given particular quantity.

$$\langle \text{true value} \rangle = \langle \text{measured value} \rangle \pm \langle \text{uncertainty} \rangle$$

Notes:

1. This is a value that would be obtained by a perfect measurement.
2. True values are by nature indeterminate.

Accuracy (of measurement): The closeness of the agreement between the result of a measurement and a true value of the measurand.

Notes:

1. "Accuracy" is a qualitative concept.
2. The term "precision" should not be used for "accuracy".

Repeatability (of results of measurements): The closeness of the agreement between the results of successive measurements of the same measurand carried out under the same measurement conditions.

Notes:

1. These conditions are called repeatability conditions.
2. Repeatability conditions include:
 - (a) The same measurement procedure;
 - (b) The same observer;
 - (c) The same measuring instrument used under the same conditions (including weather);
 - (d) The same location;
 - (e) Repetition over a short period of time.
3. Repeatability may be expressed quantitatively in terms of the dispersion characteristics of the results.

Reproducibility (of results of measurements): The closeness of the agreement between the results of measurements of the same measurand carried out under changed measurement conditions.

Notes:

1. A valid statement of reproducibility requires specification of the conditions changed.
2. The changed conditions may include:
 - (a) The principle of measurement;
 - (b) The method of measurement;
 - (c) The observer;
 - (d) The measuring instrument;
 - (e) The reference standard;
 - (f) The location;
 - (g) The conditions of use (including weather);
 - (h) The time.
3. Reproducibility may be expressed quantitatively in terms of the dispersion characteristics of the results.
4. Here, results are usually understood to be corrected results.

Uncertainty (of measurement): A variable associated with the result of a measurement that characterizes the dispersion of the values that could be reasonably attributed to the measurand.

Notes:

1. The variable may be, for example, a standard deviation (or a given multiple thereof), or the half-width of an interval having a stated level of confidence.

2. Uncertainty of measurement comprises, in general, many components. Some of these components may be evaluated from the statistical distribution of the results of a series of measurements and can be characterized by experimental standard deviations. The other components, which can also be characterized by standard deviations, are evaluated from assumed probability distributions based on experience or other information.

3. It is understood that the result of the measurement is the best estimate of the value of the measurand, and that all components of uncertainty, including those arising from systematic effects, such as components associated with corrections and reference standards, contribute to the dispersion.

Error (of measurement): The result of a measurement minus a true value of the measurand.

Note: Since a true value cannot be determined, in practice a conventional true value is used.

Deviation: The value minus its conventional true value.

Random error: The result of a measurement minus the mean that would result from an infinite number of measurements of the same measurand carried out under repeatability conditions.

Notes:

1. Random error is equal to error minus systematic error.
2. Because only a finite number of measurements can be taken, it is possible to determine only an estimate of random error.

Systematic error: A mean that would result from an infinite number of measurements of the same measurand carried out under repeatability conditions minus a true value of the measurand.

Notes:

1. Systematic error is equal to error minus random error.
2. Like true value, systematic error and its causes cannot be completely known.

Correction: The value added algebraically to the uncorrected result of a measurement to compensate for a systematic error.

1.6.3 Characteristics of instruments

Some other properties of instruments which must be understood when considering their uncertainty are taken from ISO (1993a).

Sensitivity: The change in the response of a measuring instrument divided by the corresponding change in the stimulus.

Note: Sensitivity may depend on the value of the stimulus.

Discrimination: The ability of a measuring instrument to respond to small changes in the value of the stimulus.

Resolution: A quantitative expression of the ability of an indicating device to distinguish meaningfully between closely adjacent values of the quantity indicated.

Hysteresis: The property of a measuring instrument whereby its response to a given stimulus depends on the sequence of preceding stimuli.

Stability (of an instrument): The ability of an instrument to maintain its metrological characteristics constant with time.

Drift: The slow variation with time of a metrological characteristic of a measuring instrument.

Response time: The time interval between the instant when a stimulus is subjected to a specified abrupt change and the instant when the response reaches and remains within specified limits around its final steady value.

The following other definitions are used frequently in meteorology:

Statements of response time: The time for 90 per cent of the step change is often given. The time for 50 per cent of the step change is sometimes referred to as the half-time.

Calculation of response time: In most simple systems, the response to a step change is:

$$Y = A(1 - e^{-t/\tau}) \quad (1.1)$$

where Y is the change after elapsed time t ; A is the amplitude of the step change applied; t is the elapsed time from the step change; and τ is a characteristic variable of the system having the dimension of time.

The variable τ is referred to as the time-constant or the lag coefficient. It is the time taken, after a step change, for the instrument to reach $1/e$ of the final steady reading.

In other systems, the response is more complicated and will not be considered here (see also Part III, Chapter 2).

Lag error: The error that a set of measurements may possess due to the finite response time of the observing instrument.

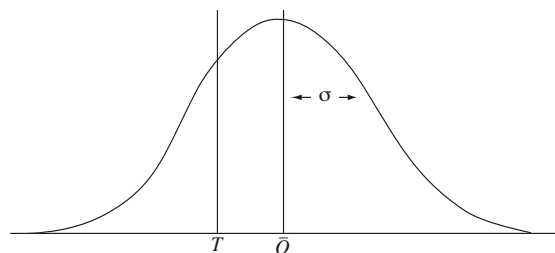

Figure 1.2. The distribution of data in an instrument comparison

1.6.4 The measurement uncertainties of a single instrument

ISO (1995) should be used for the expression and calculation of uncertainties. It gives a detailed practical account of definitions and methods of reporting, and a comprehensive description of suitable statistical methods, with many illustrative examples.

1.6.4.1 The statistical distributions of observations

To determine the uncertainty of any individual measurement, a statistical approach is to be considered in the first place. For this purpose, the following definitions are stated (ISO, 1993; 1995):

- (a) Standard uncertainty;
- (b) Expanded uncertainty;
- (c) Variance, standard deviation;
- (d) Statistical coverage interval.

If n comparisons of an operational instrument are made with the measured variable and all other significant variables held constant, if the best estimate of the true value is established by use of a reference standard, and if the measured variable has a Gaussian distribution,⁷ the results may be displayed as in Figure 1.2.

In this figure, T is the true value, \bar{O} is the mean of the n values O observed with one instrument, and σ is the standard deviation of the observed values with respect to their mean values.

In this situation, the following characteristics can be identified:

- (a) The systematic error, often termed bias, given by the algebraic difference $\bar{O} - T$. Systematic errors cannot be eliminated but may often be reduced. A correction factor can be applied to compensate for the systematic effect. Typically, appropriate calibrations and

⁷ However, note that several meteorological variables do not follow a Gaussian distribution. See section 1.6.4.2.3.

adjustments should be performed to eliminate the systematic errors of sensors. Systematic errors due to environmental or siting effects can only be reduced;

- (b) The random error, which arises from unpredictable or stochastic temporal and spatial variations. The measure of this random effect can be expressed by the standard deviation σ determined after n measurements, where n should be large enough. In principle, σ is a measure for the uncertainty of \bar{O} ;
- (c) The accuracy of measurement, which is the closeness of the agreement between the result of a measurement and a true value of the measurand. The accuracy of a measuring instrument is the ability to give responses close to a true value. Note that "accuracy" is a qualitative concept;
- (d) The uncertainty of measurement, which represents a parameter associated with the result of a measurement, that characterizes the dispersion of the values that could be reasonably attributed to the measurand. The uncertainties associated with the random and systematic effects that give rise to the error can be evaluated to express the uncertainty of measurement.

1.6.4.2 Estimating the true value

In normal practice, observations are used to make an estimate of the true value. If a systematic error does not exist or has been removed from the data, the true value can be approximated by taking the mean of a very large number of carefully executed independent measurements. When fewer measurements are available, their mean has a distribution of its own and only certain limits within which the true value can be expected to lie can be indicated. In order to do this, it is necessary to choose a statistical probability (level of confidence) for the limits, and the error distribution of the means must be known.

A very useful and clear explanation of this notion and related subjects is given by Natrella (1966). Further discussion is given by Eisenhart (1963).

1.6.4.2.1 Estimating the true value – n large

When the number of n observations is large, the distribution of the means of samples is Gaussian, even when the observational errors themselves are not. In this situation, or when the distribution of the means of samples is known to be Gaussian for other reasons, the limits between which the true value of the mean can be expected to lie are obtained from:

$$\text{Upper limit: } L_U = \bar{X} + k \cdot \frac{\sigma}{\sqrt{n}} \tag{1.2}$$

$$\text{Lower limit: } L_L = \bar{X} - k \cdot \frac{\sigma}{\sqrt{n}} \tag{1.3}$$

where \bar{X} is the average of the observations \bar{O} corrected for systematic error; σ is the standard deviation of the whole population; and k is a factor, according to the chosen level of confidence, which can be calculated using the normal distribution function.

Some values of k are as follows:

Level of confidence	90%	95%	99%
k	1.645	1.960	2.575

The level of confidence used in the table above is for the condition that the true value will not be outside the one particular limit (upper or lower) to be computed. When stating the level of confidence that the true value will lie between both limits, both the upper and lower outside zones have to be considered. With this in mind, it can be seen that k takes the value 1.96 for a 95 per cent probability, and that the true value of the mean lies between the limits L_U and L_L .

1.6.4.2.2 Estimating the true value – n small

When n is small, the means of samples conform to Student's t distribution provided that the observational errors have a Gaussian or near-Gaussian distribution. In this situation, and for a chosen level of confidence, the upper and lower limits can be obtained from:

$$\text{Upper limit: } L_U \approx \bar{X} + t \cdot \frac{\hat{\sigma}}{\sqrt{n}} \tag{1.4}$$

$$\text{Lower limit: } L_L \approx \bar{X} - t \cdot \frac{\hat{\sigma}}{\sqrt{n}} \tag{1.5}$$

where t is a factor (Student's t) which depends upon the chosen level of confidence and the number n of measurements; and $\hat{\sigma}$ is the estimate of the standard deviation of the whole population, made from the measurements obtained, using:

$$\hat{\sigma}^2 = \frac{\sum_{i=1}^n (X_i - \bar{X})^2}{n - 1} = \frac{n}{n - 1} \cdot \sigma_0^2 \tag{1.6}$$

where X_i is an individual value O_i corrected for systematic error.

Some values of t are as follows:

Level of confidence	90%	95%	99%
<i>df</i>			
1	6.314	12.706	63.657
4	2.132	2.776	4.604
8	1.860	2.306	3.355
60	1.671	2.000	2.660

where df is the degrees of freedom related to the number of measurements by $df = n - 1$. The level of confidence used in this table is for the condition that the true value will not be outside the one particular limit (upper or lower) to be computed. When stating the level of confidence that the true value will lie between the two limits, allowance has to be made for the case in which n is large. With this in mind, it can be seen that t takes the value 2.306 for a 95 per cent probability that the true value lies between the limits L_U and L_L , when the estimate is made from nine measurements ($df = 8$).

The values of t approach the values of k as n becomes large, and it can be seen that the values of k are very nearly equalled by the values of t when df equals 60. For this reason, tables of k (rather than tables of t) are quite often used when the number of measurements of a mean value is greater than 60 or so.

1.6.4.2.3 Estimating the true value – additional remarks

Investigators should consider whether or not the distribution of errors is likely to be Gaussian. The distribution of some variables themselves, such as sunshine, visibility, humidity and ceiling, is not Gaussian and their mathematical treatment must, therefore, be made according to rules valid for each particular distribution (Brooks and Carruthers, 1953).

In practice, observations contain both random and systematic errors. In every case, the observed mean value has to be corrected for the systematic error insofar as it is known. When doing this, the estimate of the true value remains inaccurate because of the

random errors as indicated by the expressions and because of any unknown component of the systematic error. Limits should be set to the uncertainty of the systematic error and should be added to those for random errors to obtain the overall uncertainty. However, unless the uncertainty of the systematic error can be expressed in probability terms and combined suitably with the random error, the level of confidence is not known. It is desirable, therefore, that the systematic error be fully determined.

1.6.4.3 Expressing the uncertainty

If random and systematic effects are recognized, but reduction or corrections are not possible or not applied, the resulting uncertainty of the measurement should be estimated. This uncertainty is determined after an estimation of the uncertainty arising from random effects and from imperfect correction of the result for systematic effects. It is common practice to express the uncertainty as “expanded uncertainty” in relation to the “statistical coverage interval”. To be consistent with common practice in metrology, the 95 per cent confidence level, or $k = 2$, should be used for all types of measurements, namely:

$$\langle \text{expanded uncertainty} \rangle = k \cdot \sigma = 2 \cdot \sigma \quad (1.7)$$

As a result, the true value, defined in section 1.6.2, will be expressed as:

$$\langle \text{true value} \rangle = \langle \text{measured value} \rangle \pm \langle \text{expanded uncertainty} \rangle = \langle \text{measured value} \rangle \pm 2 \sigma$$

1.6.4.4 Measurements of discrete values

While the state of the atmosphere may be described well by physical variables or quantities, a number of meteorological phenomena are expressed in terms of discrete values. Typical examples of such values are the detection of sunshine, precipitation or lightning and freezing precipitation. All these parameters can only be expressed by “yes” or “no”. For a number of parameters, all of which are members of the group of present weather phenomena, more than two possibilities exist. For instance, discrimination between drizzle, rain, snow, hail and their combinations is required when reporting present weather. For these practices, uncertainty calculations like those stated above are not applicable. Some of these parameters are related to a numerical threshold value (for example, sunshine detection using direct radiation intensity), and the determination of the uncertainty of any derived variable (for example, sunshine

duration) can be calculated from the estimated uncertainty of the source variable (for example, direct radiation intensity). However, this method is applicable only for derived parameters, and not for the typical present weather phenomena. Although a simple numerical approach cannot be presented, a number of statistical techniques are available to determine the quality of such observations. Such techniques are based on comparisons of two data sets, with one set defined as a reference. Such a comparison results in a contingency matrix, representing the cross-related frequencies of the mutual phenomena. In its most simple form, when a variable is Boolean (“yes” or “no”), such a matrix is a two by two matrix with the number of equal occurrences in the elements of the diagonal axis and the “missing hits” and “false alarms” in the other elements. Such a matrix makes it possible to derive verification scores or indices to be representative for the quality of the observation. This technique is described by Murphy and Katz (1985). An overview is given by Kok (2000).

1.6.5 Accuracy requirements

1.6.5.1 General

The uncertainty with which a meteorological variable should be measured varies with the specific purpose for which the measurement is required. In general, the limits of performance of a measuring device or system will be determined by the variability of the element to be measured on the spatial and temporal scales appropriate to the application.

Any measurement can be regarded as made up of two parts: the signal and the noise. The signal constitutes the quantity which is to be determined, and the noise is the part which is irrelevant. The noise may arise in several ways: from observational error, because the observation is not made at the right time and place, or because short-period or small-scale irregularities occur in the observed quantity which are irrelevant to the observations and need to be smoothed out. Assuming that the observational error could be reduced at will, the noise arising from other causes would set a limit to the accuracy. Further refinement in the observing technique would improve the measurement of the noise but would not give much better results for the signal.

At the other extreme, an instrument – the error of which is greater than the amplitude of the signal itself – can give little or no information about the

signal. Thus, for various purposes, the amplitudes of the noise and the signal serve, respectively, to determine:

- (a) The limits of performance beyond which improvement is unnecessary;
- (b) The limits of performance below which the data obtained would be of negligible value.

This argument, defining and determining limits (a) and (b) above, was developed extensively for upper-air data by WMO (1970). However, statements of requirements are usually derived not from such reasoning but from perceptions of practically attainable performance, on the one hand, and the needs of the data users, on the other.

1.6.5.2 Required and achievable performance

The performance of a measuring system includes its reliability, capital, recurrent and lifetime cost, and spatial resolution, but the performance under discussion here is confined to uncertainty (including scale resolution) and resolution in time.

Various statements of requirements have been made, and both needs and capability change with time. The statements given in Annex 1.B are the most authoritative at the time of writing, and may be taken as useful guides for development, but they are not fully definitive.

The requirements for the variables most commonly used in synoptic, aviation and marine meteorology, and in climatology are summarized in Annex 1.B.⁸ It gives requirements only for surface measurements that are exchanged internationally. Details on the observational data requirements for Global Data-processing and Forecasting System Centres for global and regional exchange are given in WMO (1992*b*). The uncertainty requirement for wind measurements is given separately for speed and direction because that is how wind is reported.

The ability of individual sensors or observing systems to meet the stated requirements is changing constantly as instrumentation and observing technology advance. The characteristics of typical

⁸ Established by the CBS Expert Team on Requirements for Data from Automatic Weather Stations (2004) and approved by the president of CIMO for inclusion in this edition of the Guide after consultation with the presidents of the other technical commissions.

sensors or systems currently available are given in Annex 1.B.⁹ It should be noted that the achievable operational uncertainty in many cases does not meet the stated requirements. For some of the quantities, these uncertainties are achievable

only with the highest quality equipment and procedures.

Uncertainty requirements for upper-air measurements are dealt with in Part I, Chapter 12.

⁹ Established by the CIMO Expert Team on Surface Technology and Measurement Techniques (2004) and confirmed for inclusion in this Guide by the president of CIMO.

ANNEX 1.A

REGIONAL CENTRES

1. Considering the need for the regular calibration and maintenance of meteorological instruments to meet the increasing needs for high-quality meteorological and hydrological data, the need for building the hierarchy of the traceability of measurements to the International System of Units (SI) standards, Members' requirements for the standardization of meteorological and related environmental instruments, the need for international instrument comparisons and evaluations in support of worldwide data compatibility and homogeneity, the need for training instrument experts and the role played by Regional Instrument Centres (RICs) in the Global Earth Observing System of Systems, the Natural Disaster Prevention and Mitigation Programme and other WMO cross-cutting programmes, it has been recommended that:¹⁰

A. **Regional Instrument Centres with full capabilities and functions** should have the following capabilities to carry out their corresponding functions:

Capabilities:

- (a) A RIC must have, or have access to, the necessary facilities and laboratory equipment to perform the functions necessary for the calibration of meteorological and related environmental instruments;
- (b) A RIC must maintain a set of meteorological standard instruments and establish the traceability of its own measurement standards and measuring instruments to the SI;
- (c) A RIC must have qualified managerial and technical staff with the necessary experience to fulfil its functions;
- (d) A RIC must develop its individual technical procedures for the calibration of meteorological and related environmental instruments using calibration equipment employed by the RIC;
- (e) A RIC must develop its individual quality assurance procedures;
- (f) A RIC must participate in, or organize, inter-laboratory comparisons of standard calibration instruments and methods;
- (g) A RIC must, when appropriate, utilize the resources and capabilities of the Region according to the Region's best interests;
- (h) A RIC must, as far as possible, apply international standards applicable for calibration laboratories, such as ISO/IEC 17025;
- (i) A recognized authority must assess a RIC, at least every five years, to verify its capabilities and performance;

Corresponding functions:

- (j) A RIC must assist Members of the Region in calibrating their national meteorological standards and related environmental monitoring instruments;
- (k) A RIC must participate in, or organize, WMO and/or regional instrument intercomparisons, following relevant CIMO recommendations;
- (l) According to relevant recommendations on the WMO Quality Management Framework, a RIC must make a positive contribution to Members regarding the quality of measurements;
- (m) A RIC must advise Members on enquiries regarding instrument performance, maintenance and the availability of relevant guidance materials;
- (n) A RIC must actively participate, or assist, in the organization of regional workshops on meteorological and related environmental instruments;
- (o) The RIC must cooperate with other RICs in the standardization of meteorological and related environmental measurements;
- (p) A RIC must regularly inform Members and report,¹¹ on an annual basis, to the president of the regional association and to the WMO Secretariat on the services offered to Members and activities carried out;

B. **Regional Instrument Centres with basic capabilities and functions** should have the following capabilities to carry out their corresponding functions:

Capabilities:

- (a) A RIC must have the necessary facilities and laboratory equipment to perform the functions necessary for the calibration of meteorological and related environmental instruments;

¹⁰ Recommended by the Commission for Instruments and Methods of Observation at its fourteenth session, held in 2006.

¹¹ A Web-based approach is recommended.

- (b) A RIC must maintain a set of meteorological standard instruments¹² and establish the traceability of its own measurement standards and measuring instruments to the SI;
- (c) A RIC must have qualified managerial and technical staff with the necessary experience to fulfil its functions;
- (d) A RIC must develop its individual technical procedures for the calibration of meteorological and related environmental instruments using calibration equipment employed by the RIC;
- (e) A RIC must develop its individual quality assurance procedures;
- (f) A RIC must participate in, or organize, inter-laboratory comparisons of standard calibration instruments and methods;
- (g) A RIC must, when appropriate, utilize the resources and capabilities of the Region according to the Region's best interests;
- (h) A RIC must, as far as possible, apply international standards applicable for calibration laboratories, such as ISO/IEC 17025;
- (i) A recognized authority must assess a RIC, at least every five years, to verify its capabilities and performance;
- (k) meteorological and related environmental monitoring instruments according to **Capabilities** (b);
- (l) According to relevant recommendations on the WMO Quality Management Framework, a RIC must make a positive contribution to Members regarding the quality of measurements;
- (m) A RIC must advise Members on enquiries regarding instrument performance, maintenance and the availability of relevant guidance materials;
- (n) The RIC must cooperate with other RICs in the standardization of meteorological and related environmental instruments;
- (o) A RIC must regularly inform Members and report,¹³ on an annual basis, to the president of the regional association and to the WMO Secretariat on the services offered to Members and activities carried out.

2. The following RICs have been designated by the regional associations concerned: Algiers (Algeria), Cairo (Egypt), Casablanca (Morocco), Nairobi (Kenya) and Gaborone (Botswana) for RA I; Beijing (China) and Tsukuba (Japan) for RA II; Buenos Aires (Argentina) for RA III; Bridgetown (Barbados), Mount Washington (United States) and San José (Costa Rica) for RA IV; Manila (Philippines) and Melbourne (Australia) for RA V; , Bratislava (Slovakia), Ljubljana (Slovenia) and Trappes (France) for RA VI.

Corresponding functions:

- (j) A RIC must assist Members of the Region in calibrating their national standard

¹² For calibrating one or more of the following variables: temperature, humidity, pressure or others specified by the Region.

¹³ A Web-based approach is recommended.

**ANNEX 1.B
OPERATIONAL MEASUREMENT UNCERTAINTY REQUIREMENTS AND INSTRUMENT PERFORMANCE**

(1) <i>Variable</i>	(2) <i>Range</i>	(3) <i>Reported resolution</i>	(4) <i>Mode of measurement/ observation</i>	(5) <i>Required measurement uncertainty</i>	(6) <i>Sensor time constant</i>	(7) <i>Output averaging time</i>	(8) <i>Achievable measurement uncertainty</i>	(9) <i>Remarks</i>
1. Temperature								
1.1	Air temperature -80 – +60°C	0.1 K	I	0.3 K for ≤ -40°C 0.1 K for > -40°C and ≤ +40°C 0.3 K for > +40°C	20 s	1 min	0.2 K	Achievable uncertainty and effective time-constant may be affected by the design of the thermometer solar radiation screen Time-constant depends on the air-flow over the sensor
1.2	Extremes of air temperature -80 – +60°C	0.1 K	I	0.5 K for ≤ -40°C 0.3 K for > -40°C and ≤ +40°C 0.5 K for > +40°C	20 s	1 min	0.2 K	
1.3	Sea surface temperature -2 – +40°C	0.1 K	I	0.1 K	20 s	1 min	0.2 K	
2. Humidity								
2.1	Dewpoint temperature -80 – +35°C	0.1 K	I	0.1 K	20 s	1 min	0.5 K	
2.2	Relative humidity 0 – 100%	1%	I	1%	20 s	1 min	0.2 K	Wet-bulb temperature (psychrometer) If measured directly and in combination with air temperature (dry bulb) Large errors are possible due to aspiration and cleanliness problems (see also note 11)
					40 s	1 min	3%	Solid state and others Solid state sensors may show significant temperature and humidity dependence

(1) Variable	(2) Range	(3) Reported resolution	(4) Mode of measurement/ observation	(5) Required measurement uncertainty	(6) Sensor time constant	(7) Output averaging time	(8) Achievable measurement uncertainty	(9) Remarks
3. Atmospheric pressure								
3.1 Pressure	500 – 1 080 hPa	0.1 hPa	I	0.1 hPa	20 s	1 min	0.3 hPa	Both station pressure and MSL pressure Measurement uncertainty is seriously affected by dynamic pressure due to wind if no precautions are taken Inadequate temperature compensation of the transducer may affect the measurement uncertainty significantly
3.2 Tendency	Not specified	0.1 hPa	I	0.2 hPa			0.2 hPa	Difference between instantaneous values
4. Clouds								
4.1 Cloud amount	0/8 – 8/8	1/8	I	1/8	n/a		2/8	Period (30 s) clustering algorithms may be used to estimate low cloud amount automatically
4.2 Height of cloud base	0 m – 30 km	10 m	I	10 m for ≤ 100 m 10% for > 100 m	n/a		~10 m	Achievable measurement uncertainty is undetermined because no clear definition exists for instrumentally measured cloud-base height (e.g. based on penetration depth or significant discontinuity in the extinction profile) Significant bias during precipitation
4.3 Height of cloud top	Not available							

(1) Variable	(2) Range	(3) Reported resolution	(4) Mode of measurement/ observation	(5) Required measurement uncertainty	(6) Sensor time constant	(7) Output averaging time	(8) Achievable measurement uncertainty	(9) Remarks
5. Wind								
5.1 Speed	0 – 75 m s ⁻¹	0.5 m s ⁻¹	A	0.5 m s ⁻¹ for ≤ 5 m s ⁻¹ 10% for > 5 m s ⁻¹	Distance constant 2 – 5 m	2 and/or 10 min	0.5 m s ⁻¹ for ≤ 5 m s ⁻¹ 10% for > 5 m s ⁻¹	Average over 2 and/or 10 min Non-linear devices. Care needed in design of averaging process Distance constant is usually expressed as response length Averages computed over Cartesian components (see Part III, Chapter 3, section 3.6 of this Guide)
5.2 Direction	0 – 360°	1°	A	5°	1 s	2 and/or 10 min	5°	
5.3 Gusts	0.1 – 150 m s ⁻¹	0.1 m s ⁻¹	A	10%		3 s	0.5 m s ⁻¹ for ≤ 5 m s ⁻¹ 10% for > 5 m s ⁻¹	Highest 3 s average should be recorded
6. Precipitation								
6.1 Amount (daily)	0 – 500 mm	0.1 mm	T	0.1 mm for ≤ 5 mm 2% for > 5 mm	n/a	n/a	The larger of 5% or 0.1 mm	Quantity based on daily amounts Measurement uncertainty depends on aerodynamic collection efficiency of gauges and evaporation losses in heated gauges Average depth over an area representative of the observing site
6.2 Depth of snow	0 – 25 m	1 cm	A	1 cm for ≤ 20 cm 5% for > 20 cm				
6.3 Thickness of ice accretion on ships	Not specified	1 cm	I	1 cm for ≤ 10 cm 10% for > 10 cm				

(1) Variable	(2) Range	(3) Reported resolution	(4) Mode of measurement/ observation	(5) Required measurement uncertainty	(6) Sensor time constant	(7) Output averaging time	(8) Achievable measurement uncertainty	(9) Remarks
6.4 Precipitation intensity	0.02 mm h ⁻¹ – 2 000 mm h ⁻¹	0.1 mm h ⁻¹	I	(trace): n/a for 0.02 – 0.2 mm h ⁻¹ 0.1 mm h ⁻¹ for 0.2 – 2 mm h ⁻¹ 5% for > 2 mm h ⁻¹	< 30 s	1 min		Uncertainty values for liquid precipitation only Uncertainty is seriously affected by wind Sensors may show significant non-linear behaviour For < 0.2 mm h ⁻¹ : detection only (yes/no) sensor time constant is significantly affected during solid precipitation using catchment type of gauges
7. Radiation								
7.1 Sunshine duration (daily)	0 – 24 h	60 s	T	0.1 h	20 s	n/a	The larger of 0.1 h or 2%	
7.2 Net radiation, radiant exposure (daily)	Not specified	1 J m ⁻²	T	0.4 MJ m ⁻² for ≤ 8 MJ m ⁻² 5% for > 8 MJ m ⁻²	20 s	n/a	0.4 MJ m ⁻² for ≤ 8 MJ m ⁻² 5% for > 8 MJ m ⁻²	Radiant exposure expressed as daily sums (amount) of (net) radiation
8. Visibility								
8.1 Meteorological optical range (MOR)	10 m – 100 km	1 m	I	50 m for ≤ 600 m 10% for > 600 m – ≤ 1 600 m 20% for > 1 500 m	< 30 s	1 and 10 min	The larger of 20 m or 20%	Achievable measurement uncertainty may depend on the cause of obscuration Quantity to be averaged: extinction coefficient (see Part III, Chapter 3, section 3.6, of this Guide). Preference for averaging logarithmic values

(1) Variable	(2) Range	(3) Reported resolution	(4) Mode of measurement/ observation	(5) Required measurement uncertainty	(6) Sensor time constant	(7) Output averaging time	(8) Achievable measurement uncertainty	(9) Remarks
8.2 Runway visual range (RVR)	10 m – 1 500 m	1 m	A	10 m for ≤ 400 m 25 m for > 400 m – ≤ 800 m 10% for > 800 m	< 30 s	1 and 10 min	The larger of 20 m or 20% 20 m or 20% 20 m or 20% 20 m or 20%	In accordance with WMO-No. 49, Volume II, Attachment A (2004 ed.) and ICAO Doc 9328-AN/908 (second ed., 2000)
9 Waves								
9.1 Significant wave height	0 – 50 m	0.1 m	A	0.5 m for ≤ 5 m 10% for > 5 m	0.5 s	20 min	0.5 m for \leq 5 m 10% for $>$ 5 m	Average over 20 min for instrumental measurements
9.2 Wave period	0 – 100 s	1 s	A	0.5 s	0.5 s	20 min	0.5 s	Average over 20 min for instrumental measurements
9.3 Wave direction	0 – 360°	1°	A	10°	0.5 s	20 min	20°	Average over 20 min for instrumental measurements
10. Evaporation								
10.1 Amount of pan evaporation	0 – 100 mm	0.1 mm	T	0.1 mm for ≤ 5 mm 2% for > 5 mm	n/a			

Notes:

- Column 1 gives the basic variable.
- Column 2 gives the common range for most variables; limits depend on local climatological conditions.
- Column 3 gives the most stringent resolution as determined by the *Manual on Codes* (WMO-No. 306).
- In column 4:
 - I = Instantaneous; In order to exclude the natural small-scale variability and the noise, an average value over a period of 1 min is considered as a minimum and most suitable; averages over periods of up to 10 min are acceptable.
 - A: = Averaging; Average values over a fixed period, as specified by the coding requirements.
 - T: = Totals; Totals over a fixed period, as specified by coding requirements.

5. Column 5 gives the recommended measurement uncertainty requirements for general operational use, i.e. of Level II data according to FM 12, 13, 14, 15 and its BUFR equivalents. They have been adopted by all eight technical commissions and are applicable for synoptic, aeronautical, agricultural and marine meteorology, hydrology, climatology, etc. These requirements are applicable for both manned and automatic weather stations as defined in the *Manual on the Global Observing System* (WMO-No. 544). Individual applications may have less stringent requirements. The stated value of required measurement uncertainty represents the uncertainty of the reported value with respect to the true value and indicates the interval in which the true value lies with a stated probability. The recommended probability level is 95 per cent ($k = 2$), which corresponds to the 2σ level for a normal (Gaussian) distribution of the variable. The assumption that all known corrections are taken into account implies that the errors in reported values will have a mean value (or bias) close to zero. Any residual bias should be small compared with the stated measurement uncertainty requirement. The true value is the value which, under operational conditions, perfectly characterizes the variable to be measured/observed over the representative time interval, area and/or volume required, taking into account siting and exposure.
6. Columns 2 to 5 refer to the requirements established by the CBS Expert Team on Requirements for Data from Automatic Weather Stations in 2004.
7. Columns 6 to 8 refer to the typical operational performance established by the CIMO Expert Team on Surface Technology and Measurement Techniques in 2004.
8. Achievable measurement uncertainty (column 8) is based on sensor performance under nominal and recommended exposure that can be achieved in operational practice. It should be regarded as a practical aid to users in defining achievable and affordable requirements.
9. n/a = not applicable.
10. The term *uncertainty* has preference over *accuracy* (i.e. uncertainty is in accordance with ISO standards on the uncertainty of measurements (ISO, 1995)).
11. Dewpoint temperature, relative humidity and air temperature are linked, and thus their uncertainties are linked. When averaging, preference is given to absolute humidity as the principal variable.

ANNEX 1.C

STATION EXPOSURE DESCRIPTION

The accuracy with which an observation describes the state of a selected part of the atmosphere is not the same as the uncertainty of the instrument, because the value of the observation also depends on the instrument's exposure to the atmosphere. This is not a technical matter, so its description is the responsibility of the station observer or attendant. In practice, an ideal site with perfect exposure is seldom available and, unless the actual exposure is adequately documented, the reliability of observations cannot be determined (WMO, 2002).

Station metadata should contain the following aspects of instrument exposure:

- (a) Height of the instruments above the surface (or below it, for soil temperature);
- (b) Type of sheltering and degree of ventilation for temperature and humidity;
- (c) Degree of interference from other instruments or objects (masts, ventilators);
- (d) Microscale and toposcale surroundings of the instrument, in particular:
 - (i) The state of the enclosure's surface, influencing temperature and humidity; nearby major obstacles (buildings, fences, trees) and their size;
 - (ii) The degree of horizon obstruction for sunshine and radiation observations;
 - (iii) Surrounding terrain roughness and major vegetation, influencing the wind;
 - (iv) All toposcale terrain features such as small slopes, pavements, water surfaces;
 - (v) Major mesoscale terrain features, such as coasts, mountains or urbanization.

Most of these matters will be semi-permanent, but any significant changes (growth of vegetation, new buildings) should be recorded in the station log-book, and dated.

For documenting the toposcale exposure, a map with a scale not larger than 1:25 000 showing contours of ≈ 1 m elevation differences is desirable. On this map the locations of buildings and trees (with height), surface cover and installed instruments should be marked. At map edges, major distant terrain features (for example, built-up areas, woods, open water, hills) should be indicated. Photographs are useful if they are not merely close-ups of the instrument or shelter, but are taken at sufficient distance to show the instrument and its terrain background. Such photographs should be taken from all cardinal directions.

The necessary minimum metadata for instrument exposure can be provided by filling in the template given on the next page for every station in a network (see Figure 1.3). An example of how to do this is shown in WMO (2003*b*). The classes used here for describing terrain roughness are given in Part I, Chapter 5, of the Guide. A more extensive description of metadata matters is given in WMO (2004).







Station	Update	
Elevation	Latitude	Longitude
<div style="margin-bottom: 5px;">  </div> <div style="margin-bottom: 5px;">  Enclosure </div> <div style="margin-bottom: 5px;">  Building </div> <div style="margin-bottom: 5px;">  Road </div> <div style="margin-bottom: 5px;">  Trees, bushes </div> <div style="margin-bottom: 5px;"> (12) Height (m) of obstacle </div> <div style="margin-bottom: 5px;">  Elevation contour </div>	 N	
Radiation horizon		
1: 6 1: 10 1: 20		8° 4° 0°
Temperature and humidity: Sensor height Surface cover under screen Artificial ventilation? yes/no Soil under screen		
Precipitation: Gauge rim height		
Wind: Anemometer height Free-standing? yes/no (if "no" above: building height , width , length . Terrain roughness class: to N , to E , to S, to W .		
Remarks:		

Figure I.3. General template for station exposure metadata

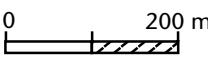
REFERENCES AND FURTHER READING

- Bureau International des Poids et Mesures/Comité Consultatif de Thermométrie, 1990: The International Temperature Scale of 1990 (ITS-90) (H. Preston Thomas). *Metrologia*, 1990, 27, pp. 3–10.
- Bureau International des Poids et Mesures, 1998: *The International System of Units (SI)*. Seventh edition, BIPM, Sèvres/Paris.
- Brooks, C.E.P. and N. Carruthers, 1953: *Handbook of Statistical Methods in Meteorology*. MO 538, Meteorological Office, London.
- Eisenhart, C., 1963: Realistic evaluation of the precision and accuracy of instrument calibration systems. National Bureau of Standards–C, Engineering and Instrumentation, *Journal of Research*, Volume 67C, Number 2, April–June 1963.
- International Civil Aviation Organization, 2002: *World Geodetic System — 1984 (WGS-84) Manual*. ICAO Doc 9674-AN/946. Second edition, Quebec.
- International Organization for Standardization, 1993a: *International Vocabulary of Basic and General Terms in Metrology*. Prepared by BIPM/ISO/OIML/IEC/IFCC/IUPAC and IUPAP, second edition, Geneva.
- International Organization for Standardization, 1993b: *ISO Standards Handbook: Quantities and Units*. ISO 31:1992, third edition, Geneva.
- International Organization for Standardization, 1995: *Guide to the Expression of Uncertainty of Measurement*. Published in the name of BIPM/IEC/IFCC/ISO/IUPAC/IUPAP and OIML, first edition, Geneva.
- International Union of Pure and Applied Physics, 1987: *Symbols, Units, Nomenclature and Fundamental Constants in Physics*. SUNAMCO Document IUPAP-25 (E.R. Cohen and P. Giacomo), reprinted from *Physica* 146A, pp. 1–68.
- Kok, C.J., 2000: *On the Behaviour of a Few Popular Verification Scores in Yes/No Forecasting*. Scientific Report, WR-2000-04, KNMI, De Bilt.
- Linacre, E., 1992: *Climate Data and Resources – A Reference and Guide*. Routledge, London, 366 pp.
- Murphy, A.H. and R.W. Katz (eds.), 1985: *Probability, Statistics and Decision Making in the Atmospheric Sciences*. Westview Press, Boulder.
- National Institute of Standards and Technology, 1995: *Guide for the Use of the International System of Units (SI)* (B.N. Taylor). NIST Special Publication No. 811, Gaithersburg, United States.
- Natrella, M.G., 1966: *Experimental Statistics*. National Bureau of Standards Handbook 91, Washington DC.
- Orlanski, I., 1975: A rational subdivision of scales for atmospheric processes. *Bulletin of the American Meteorological Society*, 56, pp. 527-530.
- World Meteorological Organization, 1966: *International Meteorological Tables* (S. Letestu, ed.) (1973 amendment), WMO-No. 188. TP.94, Geneva.
- World Meteorological Organization, 1970: *Performance Requirements of Aerological Instruments* (C.L. Hawson). Technical Note No. 112, WMO-No. 267. TP.151, Geneva.
- World Meteorological Organization, 1981: *Guide to Agricultural Meteorological Practices*. Second edition, WMO-No. 134, Geneva.
- World Meteorological Organization, 1983: *Guide to Climatological Practices*. Second edition, WMO-No. 100, Geneva (updates available at <http://www.wmo.int/web/wcp/ccl/>).
- World Meteorological Organization, 1988: *Technical Regulations*. Volume I, Appendix A, WMO-No. 49, Geneva.
- World Meteorological Organization, 1989: *Guide on the Global Observing System*. WMO-No. 488, Geneva.
- World Meteorological Organization, 1990: *Guide on Meteorological Observation and Information Distribution Systems at Aerodromes*. WMO-No. 731, Geneva.
- World Meteorological Organization, 1992a: *International Meteorological Vocabulary*. Second edition, WMO-No. 182, Geneva.
- World Meteorological Organization, 1992b: *Manual on the Global Data-processing and Forecasting System*. Volume I – Global Aspects, Appendix I-2, WMO-No. 485, Geneva.
- World Meteorological Organization, 1993a: *Siting and Exposure of Meteorological Instruments* (J. Ehinger). Instruments and Observing Methods Report No. 55, WMO/TD-No. 589, Geneva.
- World Meteorological Organization, 1993b: *Weather Reporting*. Volume A – Observing stations, WMO-No. 9, Geneva.
- World Meteorological Organization, 1994: *Guide to Hydrological Practices*. Fifth edition, WMO-No. 168, Geneva.

- World Meteorological Organization, 2001: *Lecture Notes for Training Agricultural Meteorological Personnel*. Second edition, WMO-No. 551, Geneva.
- World Meteorological Organization, 2002: Station exposure metadata needed for judging and improving the quality of observations of wind, temperature and other parameters (J. Wieringa and E. Rudel). *Papers Presented at the WMO Technical Conference on Meteorological and Environmental Instruments and Methods of Observation (TECO-2002)*, Instruments and Observing Methods Report No. 75, WMO/TD-No. 1123, Geneva.
- World Meteorological Organization, 2003a: *Manual on the Global Observing System*. Volume I – Global Aspects, WMO-No. 544, Geneva.
- World Meteorological Organization, 2003b: *Guidelines on Climate Metadata and Homogenization* (P. Llansó, ed.). World Climate Data and Monitoring Programme (WCDMP) Series Report No. 53, WMO/TD-No. 1186, Geneva.
-

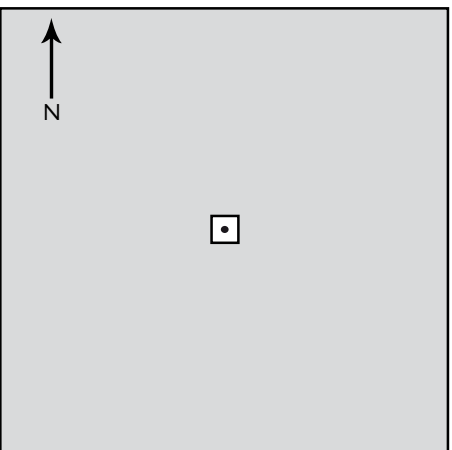
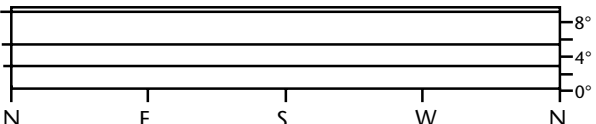
CHAPTER 2

MEASUREMENT OF TEMPERATURE

2.1 GENERAL

2.1.1 Definition

WMO (1992) defines temperature as a physical quantity characterizing the mean random motion of molecules in a physical body. Temperature is characterized by the behaviour whereby two bodies in thermal contact tend to an equal temperature. Thus, temperature represents the thermodynamic state of a body, and its value is determined by the direction of the net flow of heat between two bodies. In such a system, the body which overall loses heat to the other is said to be at the higher temperature. Defining the physical quantity temperature in relation to the “state of a body” however is difficult. A solution is found by defining an internationally approved temperature scale based on universal freezing and triple points.¹ The current such scale is the International Temperature Scale of 1990 (ITS-90)² and its temperature is indicated by T_{90} . For the meteorological range (–80 to +60°C) this scale is based on a linear relationship with the electrical resistance of platinum and the triple point of water, defined as 273.16 kelvin (BIPM, 1990).

For meteorological purposes, temperatures are measured for a number of media. The most common variable measured is air temperature (at various heights). Other variables are ground, soil, grass minimum and seawater temperature. WMO (1992) defines air temperature as “the temperature indicated by a thermometer exposed to the air in a place sheltered from direct solar radiation”. Although this definition cannot be used as the definition of the thermodynamic quantity itself, it is suitable for most applications.

1 The authoritative body for this scale is the International Bureau of Weights and Measures/Bureau International des Poids et Mesures (BIPM), Sèvres (Paris); see <http://www.bipm.org>. BIPM's Consultative Committee for Thermometry (CCT) is the executive body responsible for establishing and realizing the ITS.

2 Practical information on ITS-90 can be found on the ITS-90 website: <http://www.its-90.com>.

2.1.2 UNITS AND SCALES

The thermodynamic temperature (T), with units of kelvin (K), (also defined as “kelvin temperature”), is the basic temperature. The kelvin is the fraction 1/273.16 of the thermodynamic temperature of the triple point of water. The temperature (t), in degrees Celsius (or “Celsius temperature”) defined by equation 2.1, is used for most meteorological purposes (from the ice-point secondary reference in Table 2 in the annex):

$$t/^{\circ}\text{C} = T/\text{K} - 273.15 \quad (2.1)$$

A temperature difference of one degree Celsius (°C) unit is equal to one kelvin (K) unit. Note that the unit K is used without the degree symbol.

In the thermodynamic scale of temperature, measurements are expressed as differences from absolute zero (0 K), the temperature at which the molecules of any substance possess no kinetic energy. The scale of temperature in general use since 1990 is the ITS-90 (see the annex), which is based on assigned values for the temperatures of a number of reproducible equilibrium states (see Table 1 in the annex) and on specified standard instruments calibrated at those temperatures. The ITS was chosen in such a way that the temperature measured against it is identical to the thermodynamic temperature, with any difference being within the present limits of measurement uncertainty. In addition to the defined fixed points of the ITS, other secondary reference points are available (see Table 2 in the annex). Temperatures of meteorological interest are obtained by interpolating between the fixed points by applying the standard formulae in the annex.

2.1.3 Meteorological requirements

2.1.3.1 General

Meteorological requirements for temperature measurements primarily relate to the following:

- The air near the Earth's surface;
- The surface of the ground;

- (c) The soil at various depths;
- (d) The surface levels of the sea and lakes;
- (e) The upper air.

These measurements are required, either jointly or independently and locally or globally, for input to numerical weather prediction models, for hydrological and agricultural purposes, and as indicators of climatic variability. Local temperature also has direct physiological significance for the day-to-day activities of the world's population. Measurements of temperature may be required as continuous records or may be sampled at different time intervals. This chapter deals with requirements relating to (a), (b) and (c).

2.1.3.2 Accuracy requirements

The range, reported resolution and required uncertainty for temperature measurements are detailed in Part I, Chapter 1, of this Guide. In practice, it may not be economical to provide thermometers that meet the required performance directly. Instead, cheaper thermometers, calibrated against a laboratory standard, are used with corrections being applied to their readings as necessary. It is necessary to limit the size of the corrections to keep residual errors within bounds. Also, the operational range of the thermometer will be chosen to reflect the local climatic range. As an example, the table below gives an acceptable range of calibration and errors for thermometers covering a typical measurement range.

Thermometer characteristic requirements

<i>Thermometer type</i>	<i>Ordinary</i>	<i>Maximum</i>	<i>Minimum</i>
Span of scale (°C)	-30 to 45	-30 to 50	-40 to 40
Range of calibration (°C)	-30 to 40	-25 to 40	-30 to 30
Maximum error	<0.2 K	0.2 K	0.3 K
Maximum difference between maximum and minimum correction within the range	0.2 K	0.3 K	0.5 K
Maximum variation of correction within any interval of 10°C	0.1 K	0.1 K	0.1 K

All temperature-measuring instruments should be issued with a certificate confirming compliance with the appropriate uncertainty or performance specification, or a calibration certificate that gives the corrections that must be applied to meet the required uncertainty. This initial testing and calibration should be performed by a national testing institution or an accredited calibration laboratory. Temperature-measuring instruments should also be checked subsequently at regular intervals, the exact apparatus used for this calibration being dependent on the instrument or sensor to be calibrated.

2.1.3.3 Response times of thermometers

For routine meteorological observations there is no advantage in using thermometers with a very small time-constant or lag coefficient, since the temperature of the air continually fluctuates up to one or two degrees within a few seconds. Thus, obtaining a representative reading with such a thermometer would require taking the mean of a number of readings, whereas a thermometer with a larger time-constant tends to smooth out the rapid fluctuations. Too long a time-constant, however, may result in errors when long-period changes of temperature occur. It is recommended that the time-constant, defined as the time required by the thermometer to register 63.2 per cent of a step change in air temperature, should be 20 s. The time-constant depends on the air-flow over the sensor.

2.1.3.4 Recording the circumstances in which measurements are taken

Temperature is one of the meteorological quantities whose measurements are particularly sensitive to exposure. For climate studies in particular, temperature measurements are affected by the state of the surroundings, by vegetation, by the presence of buildings and other objects, by ground cover, by the condition of, and changes in, the design of the radiation shield or screen, and by other changes in equipment. It is important that records should be kept not only of the temperature data, but also of the circumstances in which the measurements are taken. Such information is known as metadata (data about data).

2.1.4 Measurement methods

In order to measure the temperature of an object, a thermometer can be brought to the same temperature as the object (namely, into thermodynamic equilibrium with it), and the temperature of the thermometer itself can then be measured.

Alternatively, the temperature can be determined by a radiometer without the need for thermal equilibrium.

Any physical property of a substance which is a function of temperature can be used as the basis of a thermometer. The properties most widely used in meteorological thermometers are thermal expansion and the change in electrical resistance with temperature. Radiometric thermometers operate in the infrared part of the electromagnetic spectrum and are used, among other applications, for temperature measurements from satellites. A special technique to determine the air temperature using ultrasonic sampling, developed to determine air speeds, also provides the average speeds of the air molecules, and as a consequence its temperature (WMO, 2002a).

Thermometers which indicate the prevailing temperature are often known as ordinary thermometers, while those which indicate extreme temperature over a period of time are called maximum or minimum thermometers.

There are various standard texts on instrument design and laboratory practice for the measurement of temperature thermometry, such as Jones (1992) and Middleton and Spilhaus (1960). Considering the concepts of thermometry, care should be taken that, for meteorological applications, only specific technologies are applicable because of constraints determined by the typical climate or environment.

2.1.4.1 Thermometer exposure and siting

Radiation from the sun, clouds, the ground and other surrounding objects passes through the air without appreciably changing its temperature, but a thermometer exposed freely in the open can absorb considerable radiation. As a consequence, its temperature may differ from the true air temperature, with the difference depending on the radiation intensity and on the ratio of absorbed radiation to dissipated heat. For some thermometer elements, such as the very fine wire used in an open-wire resistance thermometer, the difference may be very small or even negligible. However, with the more usual operational thermometers the temperature difference may reach 25 K under extremely unfavourable conditions. Therefore, in order to ensure that the thermometer is at true air temperature it is necessary to protect the thermometer from radiation by a screen or shield that also serves to support the thermometer. This screen also shelters it from precipitation while allowing the free circulation

of air around it, and prevents accidental damage. Precipitation on the sensor will, depending on the local air-flow, depress the sensor temperature, causing it to behave as a wet-bulb thermometer. Maintaining free circulation may, however, be difficult to achieve under conditions of rime ice accretion. Practices for reducing observational errors under such conditions will vary and may involve the use of special designs of screens or temperature-measuring instruments, including artificial ventilation. Nevertheless, in the case of artificial ventilation, care should be taken to avoid unpredictable influences caused by wet deposition in combination with evaporation during precipitation, drizzle, fog, and the like. An overview of concepts of temperature measurement applicable for operational practices is given by Sparks (1970).

In order to achieve representative results when comparing thermometer readings at different places and at different times, a standardized exposure of the screen and, hence, of the thermometer itself is also indispensable. For general meteorological work, the observed air temperature should be representative of the free air conditions surrounding the station over as large an area as possible, at a height of between 1.2 and 2.0 m above ground level. The height above ground level is specified because large vertical temperature gradients may exist in the lowest layers of the atmosphere. The best site for the measurements is, therefore, over level ground, freely exposed to sunshine and wind and not shielded by, or close to, trees, buildings and other obstructions. Sites on steep slopes or in hollows are subject to exceptional conditions and should be avoided. In towns and cities, local peculiarities are expected to be more marked than in rural districts. Temperature observations on the top of buildings are of doubtful significance and use because of the variable vertical temperature gradient and the effect of the building itself on the temperature distribution.

2.1.4.2 Temperature standards

Laboratory standards

Primary standard thermometers will be held and maintained at national standards laboratories. A national meteorological or other accredited calibration laboratory will have, as a working standard, a high-grade platinum resistance thermometer, traceable to the national standard. The uncertainty of this thermometer may be checked periodically in a water triple-point cell. The triple point of water is defined exactly and can be reproduced in a triple-point cell with an uncertainty of $1 \cdot 10^{-4}$ K.

Field standards

The WMO reference psychrometer (WMO, 1992) is the reference instrument for determining the relationship between the air temperature measured by conventional surface instruments and the true air temperature. This instrument has been designed to be used as a free-standing instrument and not for deployment within a screen or shelter; it is the most accurate instrument available for evaluating and comparing instrument systems. It is not intended for continuous use in routine meteorological operations and is capable of providing a temperature measurement with an uncertainty of 0.04 K (at the 95 per cent confidence level). See Part I, Chapter 4, for further information.

2.2 LIQUID-IN-GLASS THERMOMETERS

2.2.1 General description

For routine observations of air temperature, including maximum, minimum and wet-bulb temperatures, liquid-in-glass thermometers are still commonly used. Such thermometers make use of the differential expansion of a pure liquid with respect to its glass container to indicate the temperature. The stem is a tube which has a fine bore attached to the main bulb; the volume of liquid in the thermometer is such that the bulb is filled completely but the stem is only partially filled at all temperatures to be measured. The changes in volume of the liquid with respect to its container are indicated by changes in the liquid column; by calibration with respect to a standard thermometer, a scale of temperature can be marked on the stem, or on a separate scale tightly attached to the stem.

The liquid used depends on the required temperature range; mercury is generally used for temperatures above its freezing point (-38.3°C), while ethyl alcohol or other pure organic liquids are used for lower temperatures. The glass should be one of the normal or borosilicate glasses approved for use in thermometers. The glass bulb is made as thin as is consistent with reasonable strength to facilitate the conduction of heat to and from the bulb and its contents. A narrower bore provides greater movement of liquid in the stem for a given temperature change, but reduces the useful temperature range of the thermometer for a given stem length. The thermometer should

be suitably annealed before it is graduated in order to minimize the slow changes that occur in the glass with ageing.

There are four main types of construction for meteorological thermometers, as follows:

- (a) The sheathed type with the scale engraved on the thermometer stem;
- (b) The sheathed type with the scale engraved on an opal glass strip attached to the thermometer tube inside the sheath;
- (c) The unsheathed type with the graduation marks on the stem and mounted on a metal, porcelain or wooden back carrying the scale numbers;
- (d) The unsheathed type with the scale engraved on the stem.

The stems of some thermometers are lens-fronted to provide a magnified image of the mercury thread.

Types (a) and (b) have the advantage over types (c) and (d) that their scale markings are protected from wear. For types (c) and (d), the markings may have to be reblacked from time to time; on the other hand, such thermometers are easier to make than types (a) and (b). Types (a) and (d) have the advantage of being less susceptible to parallax errors (see section 2.2.4). An overview of thermometers, designed for use in meteorological practices is given by HMSO (1980).

Whichever type is adopted, the sheath or mounting should not be unduly bulky as this would keep the heat capacity high. At the same time, the sheath or mounting should be sufficiently robust to withstand the normal risks associated with handling and transit.

For mercury-in-glass thermometers, especially maximum thermometers, it is important that the vacuum above the mercury column be nearly perfect. All thermometers should be graduated for total immersion, with the exception of thermometers for measuring soil temperature. The special requirements of thermometers for various purposes are dealt with hereafter under the appropriate headings.

2.2.1.1 Ordinary (station) thermometers

This is the most accurate instrument of all meteorological thermometers. Usually it is a mercury-in-glass-type thermometer. Its scale markings have an increment of 0.2 K or 0.5 K, and

the scale is longer than that of the other meteorological thermometers.

The ordinary thermometer is used in a thermometer screen to avoid radiation errors. A support keeps it in a vertical position with the bulb at the lower end. The form of the bulb is that of a cylinder or an onion.

A pair of ordinary thermometers can be used as a psychrometer if one of them is fitted with a wet-bulb³ sleeve.

2.2.1.2 Maximum thermometers

The recommended type for maximum thermometers is a mercury-in-glass thermometer with a constriction in the bore between the bulb and the beginning of the scale. This constriction prevents the mercury column from receding with falling temperatures. However, observers can reset by holding it firmly, bulb-end downwards, and swinging their arm until the mercury column is reunited. A maximum thermometer should be mounted at an angle of about 2° from the horizontal position, with the bulb at the lower end to ensure that the mercury column rests against the constriction without gravity forcing it to pass. It is desirable to have a widening of the bore at the top of the stem to enable parts of the column which have become separated to be easily united.

2.2.1.3 Minimum thermometers

As regards minimum thermometers, the most common instrument is a spirit thermometer with a dark glass index, about 2 cm long, immersed in the spirit. Since some air is left in the tube of a spirit thermometer, a safety chamber should be provided at the upper end which should be large enough to allow the instrument to withstand a temperature of 50°C without being damaged. Minimum thermometers should be supported in a similar manner to maximum thermometers, in a near-horizontal position. Various liquids can be used in minimum thermometers, such as ethyl alcohol, pentane and toluol. It is important that the liquid should be as pure as possible since the presence of certain impurities increases the tendency of the liquid to polymerize with exposure to light and after the passage of time; such polymerization causes a change in calibration.

In the case of ethyl alcohol, for example, the alcohol should be completely free of acetone.

Minimum thermometers are also exposed to obtain grass minimum temperature.

2.2.1.4 Soil thermometers

For measuring soil temperatures at depths of 20 cm or less, mercury-in-glass thermometers, with their stems bent at right angles, or any other suitable angle, below the lowest graduation, are in common use. The thermometer bulb is sunk into the ground to the required depth, and the scale is read with the thermometer in situ. These thermometers are graduated for immersion up to the measuring depth. Since the remainder of the thermometer is kept at air temperature, a safety chamber should be provided at the end of the stem for the expansion of the mercury.

For measuring temperature at depths of over 20 cm, mercury-in-glass thermometers, mounted on wooden, glass or plastic tubes, with their bulbs embedded in wax or metallic paint, are recommended. The thermometer-tube assemblies are then suspended or slipped in thin-walled metal or plastic tubes sunk into the ground to the required depth. In cold climates, the tops of the outer tubes should extend above the ground to a height greater than the expected depth of snow cover.

The technique of using vertical steel tubes is unsuitable for measuring the diurnal variation of soil temperature, particularly in dry soil, and calculations of soil thermal properties based on such measurements could be significantly in error because they will conduct heat from the surface layer.

The large time-constant due to the increased heat capacity enables the thermometers to be removed from the outer tubes and read before their temperature has had time to change appreciably from the soil temperature.

When the ground is covered by snow, and in order that the observer may approach the line of thermometers without disturbing the snow cover, it is recommended that a lightweight bridge be constructed parallel to the line of thermometers. The bridge should be designed so that the deck can be removed between readings without affecting the snow cover.

3 Wet-bulb temperatures are explained in Part I, Chapter 4.

2.2.2 Measurement procedures

2.2.2.1 Reading ordinary thermometers

Thermometers should be read as rapidly as possible in order to avoid changes of temperature caused by the observer's presence. Since the liquid meniscus, or index, and the thermometer scale are not on the same plane, care must be taken to avoid parallax errors. These will occur unless the observer ensures that the straight line from his/her eye to the meniscus, or index, is at a right angle to the thermometer stem. Since thermometer scales are not normally subdivided to less than one fifth of a degree, readings to the nearest tenth of a degree, which are essential in psychometry, must be made by estimation. Corrections for scale errors, if any, should be applied to the readings. Maximum and minimum thermometers should be read and set at least twice daily. Their readings should be compared frequently with those of an ordinary thermometer in order to ensure that no serious errors develop.

2.2.2.2 Measuring grass minimum temperatures

The grass minimum temperature is the lowest temperature reached overnight by a thermometer freely exposed to the sky just above short grass. The temperature is measured with a minimum thermometer such as that described in section 2.2.1.3. The thermometer should be mounted on suitable supports so that it is inclined at an angle of about 2° from the horizontal position, with the bulb lower than the stem, 25 to 50 mm above the ground and in contact with the tips of the grass. When the ground is covered with snow, the thermometer should be supported immediately above the surface of the snow, as near to it as possible without actually touching it.

Normally, the thermometer is exposed at the last observation hour before sunset, and the reading is taken the next morning. The instrument is kept within a screen or indoors during the day. However, at stations where an observer is not available near sunset, it may be necessary to leave the thermometer exposed throughout the day. In strong sunshine, exposing the thermometer in this way can cause the spirit to distil and collect in the top of the bore. This effect can be minimized by fitting a cotton sock on a black metal shield over the safety chamber end of the thermometer; this shield absorbs more radiation and

consequently reaches a higher temperature than the rest of the thermometer. Thus, any vapour will condense lower down the bore at the top of the spirit column.

2.2.2.3 Measuring soil temperatures

The standard depths for soil temperature measurements are 5, 10, 20, 50 and 100 cm below the surface; additional depths may be included. The site for such measurements should be a level plot of bare ground (about 75 cm^2) and typical of the surrounding soil for which information is required. If the surface is not representative of the general surroundings, its extent should not be less than 100 m^2 . When the ground is covered with snow, it is desirable to measure the temperature of the snow cover as well. Where snow is rare, the snow may be removed before taking the readings and then replaced.

When describing a site for soil temperature measurements, the soil type, soil cover and the degree and direction of the ground's slope should be recorded. Whenever possible, the physical soil constants, such as bulk density, thermal conductivity and the moisture content at field capacity, should be indicated. The level of the water table (if within 5 m of the surface) and the soil structure should also be included.

At agricultural meteorological stations, the continuous recording of soil temperatures and air temperatures at different levels in the layer adjacent to the soil (from ground level up to about 10 m above the upper limit of prevailing vegetation) is desirable.

2.2.3 Thermometer siting and exposure

Both ordinary thermometers and maximum and minimum thermometers are always exposed in a thermometer screen placed on a support. Extreme thermometers are mounted on suitable supports so that they are inclined at an angle of about 2° from the horizontal position, with the bulb being lower than the stem.

The siting and exposure of grass minimum thermometers is as prescribed in section 2.2.2.2. At a station where snow is persistent and of varying depth, it is possible to use a support that allows the thermometers to be raised or lowered to maintain the correct height above the snow surface.

2.2.4 Sources of error in liquid-in-glass thermometers

The main sources of error common to all liquid-in-glass thermometers are the following:

- (a) Elastic errors;
- (b) Errors caused by the emergent stem;
- (c) Parallax and gross reading errors;
- (d) Changes in the volume of the bulb produced by exterior or interior pressure;
- (e) Capillarity;
- (f) Errors in scale division and calibration;
- (g) Inequalities in the expansion of the liquid and glass over the range considered.

The last three errors can be minimized by the manufacturer and included in the corrections to be applied to the observed values. Some consideration needs to be given to the first three errors. Error (d) does not usually arise when the thermometers are used for meteorological purposes.

2.2.4.1 Elastic errors

There are two kinds of elastic errors, namely reversible and irreversible errors. The first is of importance only when a thermometer is exposed to a large temperature range in a short period of time. Thus, if a thermometer is checked at the steam point and shortly afterwards at the ice point, it will read slightly too low at first and then the indicated temperature will rise slowly to the correct value. This error depends on the quality of the glass employed in the thermometer, and may be as much as 1 K (with glass of the highest quality it should be only 0.03 K) and would be proportionately less for smaller ranges of temperature. The effect is of no importance in meteorological measurements, apart from the possibility of error in the original calibration.

The irreversible changes may be more significant. The thermometer bulb tends to contract slowly over a period of years and, thus, causes the zero to rise. The greatest change will take place in the first year, after which the rate of change will gradually decrease. This alteration can be reduced by subjecting the bulb to heat treatment and by using the most suitable glass. Even with glass of the highest quality, the change may be about 0.01 K per year at first. For accurate work, and especially with inspector or check thermometers, the zero should be redetermined at the recommended intervals and the necessary corrections applied.

2.2.4.2 Errors caused by the emergent stem

A thermometer used to measure air temperature is usually completely surrounded by air at an approximately uniform temperature, and is calibrated by immersing the thermometer either completely or only to the top of the mercury column (namely, calibrated by complete or partial immersion). When such a thermometer is used to determine the temperature of a medium which does not surround the stem, so that the effective temperature of the stem is different from that of the bulb, an error will result.

For meteorological applications, the most likely circumstance where this might be encountered is when checking the calibration of an ordinary thermometer in a vessel containing another liquid at a temperature significantly different from ambient temperature and only the bulb or lower part of the stem is immersed.

2.2.4.3 Parallax and gross reading errors

If the thermometer is not viewed on the plane that is perpendicular to the stem of the thermometer, parallax errors will arise. The error increases with the thickness of the thermometer stem and the angle between the actual and the correct line of sight. This error can be avoided only by taking great care when making an observation. With mercury-in-glass thermometers suspended vertically, as in an ordinary screen, the thermometer must be viewed at the horizontal level of the top of the mercury column.

Errors can also occur because observers usually disturb the surroundings in some way when they approach to read the thermometer. It is, therefore, necessary for observers to take the readings to the nearest tenth of a degree as soon as possible. Gross reading errors are usually 1, 5 or 10° in magnitude. Such errors will be avoided if observers recheck the tens and units figure after taking their initial reading.

2.2.4.4 Errors due to differential expansion

The coefficient of cubical expansion of mercury is $1.82 \cdot 10^{-4} \text{ K}^{-1}$, and that of most glass lies between $1.0 \cdot 10^{-5}$ and $3.0 \cdot 10^{-5} \text{ K}^{-1}$. The expansion coefficient of the glass is, thus, an important fraction of that of mercury and cannot be neglected. As neither the coefficients of cubical expansion of mercury and glass nor the cross-sectional area of the bore of

the stem are strictly constant over the range of temperature and length of the stem being used, the scale value of unit length of the stem varies along the stem, and the thermometer has to be calibrated by the manufacturer against a standard thermometer before it can be used.

2.2.4.5 Errors associated with spirit thermometers

The expansion coefficients of the liquids used in spirit thermometers are very much larger than those of mercury, and their freezing points are much lower (ethyl alcohol freezes at -115°C). Spirit is used in minimum thermometers because it is colourless and because its larger expansion coefficient enables a larger bore to be used. Spirit thermometers are less accurate than mercury thermometers of similar cost and quality. In addition to having the general disadvantages of liquid-in-glass thermometers, spirit thermometers have some peculiarities to themselves:

- (a) Adhesion of the spirit to the glass: Unlike mercury, organic liquids generally wet the glass. Therefore, when the temperature falls rapidly, a certain amount of the liquid may remain on the walls of the bore, causing the thermometer to read low. The liquid gradually drains down the bore if the thermometer is suspended vertically;
- (b) Breaking of the liquid column: Drops of the liquid often form in the upper part of the thermometer stem by a process of evaporation and condensation. These can be reunited with the main column, but errors may be caused at the beginning of the process before it is noticed. The column is also often broken during transport. This error is reduced during manufacture by sealing off the thermometer at its lowest temperature so that it contains the maximum amount of air in the stem;
- (c) Slow changes in the liquid: The organic liquids used tend to polymerize with age and exposure to light, with a consequent gradual diminution in liquid volume. This effect is speeded up by the presence of impurities; in particular, the presence of acetone in ethyl alcohol has been shown to be very deleterious. Great care has therefore to be taken over the preparation of the liquid for the thermometers. This effect may also be increased if dyes are used to colour the liquid to make it more visible.

The reduction of errors caused by breakage in the liquid column and the general care of spirit thermometers are dealt with later in this chapter.

2.2.5 Comparison and calibration in the field and laboratory

2.2.5.1 Laboratory calibration

Laboratory calibrations of thermometers should be carried out by national testing institutions or accredited calibration laboratories. For liquid-in-glass thermometers, a liquid bath should be employed, within which it should be possible to maintain the temperature at any desired values within the required range. The rate of temperature change within the liquid should not exceed the recommended limits, and the calibration apparatus should be provided with a means of stirring the liquid. The reference thermometers and thermometers being tested should be suspended independently of the container and fully immersed, and should not touch the sides.

Sufficient measurements should be taken to ensure that the corrections to be applied represent the performance of the thermometer under normal conditions, with errors due to interpolation at any intermediate point not exceeding the non-systematic errors (see Part III, Chapter 4).

2.2.5.2 Field checks and calibration

All liquid-in-glass thermometers experience gradual changes of zero. For this reason, it is desirable to check them at regular intervals, usually about once every two years. The thermometers should be stored in an upright position at room temperature for at least 24 h before the checking process begins.

The ice point may be checked by almost filling a Dewar flask with crushed ice made from distilled water and moistening it with more distilled water. The space between the ice pieces as well as the bottom of the vessel should be free from air. The water should remain 2 cm beneath the ice surface. An ordinary Thermos flask will accommodate the total immersion of most thermometers up to their ice point. The thermometers should be inserted so that as little of the mercury or spirit column as possible emerges from the ice. An interval of at least 15 min should elapse to allow the thermometer to take up the temperature of the melting ice before a reading of the indicated temperature is taken. Each thermometer should be moved backwards and forwards through the mixture and immediately read to a tenth part of the scale interval. Further readings at 5 min intervals should be taken and a mean value computed.

Other points in the range can be covered by reference to a travelling standard or inspector thermometer. Comparison should be made by immersing the reference thermometer and the thermometer, or thermometers, to be tested in a deep vessel of water. It is generally better to work indoors, especially if the sun is shining, and the best results will be obtained if the water is at, or close to, ambient temperature.

Each thermometer is compared with the reference thermometer; thermometers of the same type can be compared with each other. For each comparison, the thermometers are held with their bulbs close together, moved backwards and forwards through the water for about 1 min, and then read. It must be possible to read both thermometers without changing the depth of immersion; subject to this, the bulbs should be as deep in the water as possible. Most meteorological thermometers are calibrated for total immersion; provided that the difference between the water and air temperature is not more than 5 K, the emergent stem correction should be negligible. Often, with the bulbs at the same depth, the tops of the columns of mercury (or other liquid) in the reference thermometer and the thermometer being checked will not be very close together. Particular care should therefore be taken to avoid parallax errors.

These comparisons should be made at least three times for each pair of thermometers. For each set of comparisons, the mean of the differences between readings should not exceed the tolerances specified in the table in section 2.1.3.2.

Soil thermometers may be tested in this manner, but should be left in the water for at least 30 min to allow the wax in which the bulbs are embedded to take up the temperature of the water. The large time-constant of the soil thermometer makes it difficult to conduct a satisfactory check unless the temperature of the water can be kept very steady. If the test is carefully carried out in water whose temperature does not change by more than 1 K in 30 min, the difference from the corrected reading of the reference thermometer should not exceed 0.25 K.

2.2.6 Corrections

When initially issued, thermometers identified by a serial number should be provided with either a dated certificate confirming compliance with the uncertainty requirement, or a dated calibration

certificate giving the corrections that should be applied to the readings to achieve the required uncertainty.

In general, if the errors at selected points in the range of a thermometer (for example, 0°C, 10°C, 20°C) are all within 0.05 K, no corrections will be necessary and the thermometers can be used directly as ordinary thermometers in naturally ventilated screens and as maximum, minimum, soil or grass minimum thermometers. If the errors at these selected points are greater than 0.05 K, a table of corrections should be available to the observer at the place of reading, together with unambiguous instructions on how these corrections should be applied.

Thermometers for which certificates would normally be issued are those:

- (a) For use in ventilated psychrometers;
- (b) For use by inspectors as travelling standards;
- (c) For laboratory calibration references;
- (d) For special purposes for which the application of corrections is justified.

For psychrometric use, identical thermometers should be selected.

2.2.7 Maintenance

2.2.7.1 Breakage in the liquid column

The most common fault encountered is the breaking of the liquid column, especially during transit. This is most likely to occur in spirit (minimum) thermometers. Other problems associated with these thermometers are adhesion of the spirit to the glass and the formation by distillation of drops of spirit in the support part of the bore.

A broken liquid column can usually be reunited by holding the thermometer bulb-end downward and tapping the thermometer lightly and rapidly against the fingers or something else which is elastic and not too hard. The tapping should be continued for some time (5 min if necessary), and afterwards the thermometer should be hung, or stood, upright in a suitable container, bulb downward, for at least 1 h to allow any spirit adhering to the glass to drain down to the main column. If such treatment is not successful, a more drastic method is to cool the bulb in a freezing mixture of ice and salt, while keeping the upper part of the stem warm; the liquid will slowly distil back to the main column. Alternatively, the thermometer may be held

upright with its bulb in a vessel of warm water, while the stem is tapped or shaken from the water as soon as the top of the spirit column reaches the safety chamber at the top of the stem. Great care must be taken when using this method as there is a risk of bursting the thermometer if the spirit expands into the safety chamber.

2.2.7.2 Scale illegibility

Another shortcoming of unsheathed liquid-in-glass thermometers is that with time their scale can become illegible. This can be corrected at the station by rubbing the scale with a dark crayon or black lead pencil.

2.2.8 Safety

Mercury, which is the liquid most commonly used in liquid-in-glass thermometers, is poisonous if swallowed or if its vapour is inhaled. If a thermometer is broken and the droplets of mercury are not removed there is some danger to health, especially in confined spaces. (Advice on cleaning up after a breakage is given in Part I, Chapter 3, in section 3.2 on mercury barometers.) There may also be restrictions on the carriage of mercury thermometers on aircraft, or special precautions that must be taken to prevent the escape of mercury in the event of a breakage. The advice of the appropriate authority or carrier should be sought.

2.3 MECHANICAL THERMOGRAPHS

2.3.1 General description

The types of mechanical thermographs still commonly used are supplied with bimetallic or Bourdon-tube sensors since these are relatively inexpensive, reliable and portable. However, they are not readily adapted for remote or electronic recording. Such thermographs incorporate a rotating chart mechanism common to the family of classic recording instruments. In general, thermographs should be capable of operating over a range of about 60 K or even 80 K if they are to be used in continental climates. A scale value is needed such that the temperature can be read to 0.2 K without difficulty on a reasonably sized chart. To achieve this, provisions should be made for altering the zero setting of the instrument according to the season. The maximum error of a thermograph should not exceed 1 K.

2.3.1.1 Bimetallic thermograph

In bimetallic thermographs, the movement of the recording pen is controlled by the change in curvature of a bimetallic strip or helix, one end of which is rigidly fixed to an arm attached to the frame. A means of finely adjusting this arm should be provided so that the zero of the instrument can be altered when necessary. In addition, the instrument should be provided with a means of altering the scale value by adjusting the length of the lever that transfers the movement of the bimetal to the pen; this adjustment is best left to authorized personnel. The bimetallic element should be adequately protected from corrosion; this is best done by heavy copper, nickel or chromium plating, although a coat of lacquer may be adequate in some climates. A typical time-constant of about 25 s is obtained at an air speed of 5 m s⁻¹.

2.3.1.2 Bourdon-tube thermograph

The general arrangement is similar to that of the bimetallic type but its temperature-sensitive element is in the form of a curved metal tube of flat, elliptical section, filled with alcohol. The Bourdon tube is less sensitive than the bimetallic element and usually requires a multiplying level mechanism to give sufficient scale value. A typical time-constant is about 6 s at an air speed of 5 m s⁻¹.

2.3.2 Measurement procedures

In order to improve the resolution of the reading, thermographs will often be set, in different seasons, to one of two different ranges with corresponding charts. The exact date for changing from one set of charts to the other will vary according to the locality. However, when the change is made the instrument will need to be adjusted. This should be done either in the screen on a cloudy, windy day at a time when the temperature is practically constant or in a room where the temperature is constant. The adjustment is made by loosening the screw holding the pen arm to the pen spindle, moving the pen arm to the correct position and retightening, the screws. The instrument should then be left as is before rechecking, and any further adjustments made as necessary.

2.3.3 Exposure and siting

These instruments should be exposed in a large thermometer screen.

2.3.4 Sources of error

In the thermograph mechanism itself, friction is the main source of error. One cause of this is bad alignment of the helix with respect to the spindle. Unless accurately placed, the helix acts as a powerful spring and, if rigidly anchored, pushes the main spindle against one side of the bearings. With modern instruments this should not be a serious problem. Friction between the pen and the chart can be kept to a minimum by suitably adjusting the gate suspension.

2.3.5 Comparison and calibration

2.3.5.1 Laboratory calibration

There are two basic methods for the laboratory calibration of bimetallic thermographs. They may be checked by fixing them in a position with the bimetallic element in a bath of water. Alternatively, the thermograph may be placed in a commercial calibration chamber equipped with an air temperature control mechanism, a fan and a reference thermometer.

Comparisons should be made at two temperatures; from these, any necessary changes in the zero and magnification can be found. Scale adjustments should be performed by authorized personnel, and only after reference to the appropriate manufacturer's instrument handbook.

2.3.5.2 Field comparison

The time-constant of the instrument may be as low as one half that of the ordinary mercury thermometer, so that routine comparisons of the readings of the dry bulb and the thermograph at fixed hours will, in general, not produce exact agreement even if the instrument is working perfectly. A better procedure is to check the reading of the instrument on a suitable day at a time when the temperature is almost constant (usually a cloudy, windy day) or, alternatively, to compare the minimum readings of the thermograph trace with the reading of the minimum thermometer exposed in the same screen. Any necessary adjustment can then be made by means of the setting screw.

2.3.6 Corrections

Thermographs would not normally be issued with correction certificates. If station checks show an instrument to have excessive errors, and if these cannot be adjusted locally, the instrument should

be returned to an appropriate calibration laboratory for repair and recalibration.

2.3.7 Maintenance

Routine maintenance will involve an inspection of the general external condition, the play in the bearings, the inclination of the recording arm, the set of the pen, and the angle between the magnification arm and recording arm, and a check of the chart-drum clock timing. Such examinations should be performed in accordance with the recommendations of the manufacturer. In general, the helix should be handled carefully to avoid mechanical damage and should be kept clean. The bearings of the spindle should also be kept clean and oiled at intervals using a small amount of clock oil. The instrument is mechanically very simple and, provided that precautions are taken to keep the friction to a minimum and prevent corrosion, it should give good service.

2.4 ELECTRICAL THERMOMETERS

2.4.1 General description

Electrical instruments are in widespread use in meteorology for measuring temperatures. Their main virtue lies in their ability to provide an output signal suitable for use in remote indication, recording, storage, or transmission of temperature data. The most frequently used sensors are electrical resistance elements, semiconductor thermometers (thermistors) and thermocouples.

2.4.1.1 Electrical resistance thermometers

A measurement of the electrical resistance of a material whose resistance varies in a known manner with the temperature of the material can be used to represent the temperature.

For small temperature changes, the increase in resistance of pure metals is proportional to the change in temperature, as expressed in equation 2.2:

$$R_T = R_0 [1 + \alpha (T - T_0)] \quad (2.2)$$

where $(T - T_0)$ is small; R_T is the resistance of a fixed amount of the metal at temperature T ; R_0 is its resistance at a reference temperature T_0 , and α is the temperature coefficient of resistance in the vicinity of T_0 .

With 0°C as the reference temperature, equation 2.2 becomes:

$$R_T = R_0 (1 + \alpha \cdot t) \quad (2.3)$$

For larger temperature changes and for certain metallic alloys, equation 2.4 expresses the relationship more accurately:

$$R_T = R_0 [1 + \alpha (T - T_0) + \beta (T - T_0)^2] \quad (2.4)$$

With 0°C as the reference temperature, equation 2.4 becomes:

$$R_T = R_0 (1 + \alpha \cdot t + \beta \cdot t^2) \quad (2.5)$$

These equations give the proportional change in resistance of an actual thermometer, so that values for the coefficients α and β can be found by calibration of the thermometer concerned. Based on these results, the inverse function, namely, t as a function of R , can be derived. Such a function may be expressed in terms of a linear series of $(R_0 - R_T)$, namely, $t = t(R_0 - R_T) = c_1 (R_0 - R_T) + c_2 (R_0 - R_T)^2 + \dots$

A good metal resistance thermometer will satisfy the following requirements:

- (a) Its physical and chemical properties will remain the same through the temperature measurement range;
- (b) Its resistance will increase steadily with increasing temperature without any discontinuities in the range of measurement;
- (c) External influences such as humidity, corrosion or physical deformations will not alter its resistance appreciably;
- (d) Its characteristics will remain stable over a period of two years or more;
- (e) Its resistance and thermal coefficient should be large enough to be useful in a measuring circuit.

Pure platinum best satisfies the foregoing requirements. Thus, it is used for the primary standard thermometers needed for transferring the ITS-90 between instrument locations. Platinum thermometers are also used for secondary standards and for operational sensors.

Practical thermometers are artificially aged before use and are commonly made from platinum alloys, nickel and occasionally tungsten for meteorological purposes. Usually they are hermetically sealed in a ceramic sheath. Their time-constant is smaller than that of liquid-in-glass thermometers.

2.4.1.2 Semiconductor thermometers

Another type of resistance element in common use is the thermistor. This is a semiconductor with a relatively large temperature coefficient of resistance, which may be either positive or negative depending upon the actual material. Mixtures of sintered metallic oxides are suitable for making practical thermistors, which usually take the form of small discs, rods or spheres and are often glass-coated. The general expression for the temperature dependence of the resistance, R , of the thermistor is given in equation 2.6:

$$R = a \exp (b/T) \quad (2.6)$$

where a and b are constants and T is the temperature of the thermistor in kelvins.

The advantages of thermistors from a thermometric point of view are as follows:

- (a) The large temperature coefficient of resistance enables the voltage applied across a resistance bridge to be reduced while attaining the same sensitivity, thus reducing or even eliminating the need to account for the resistance of the leads and its changes;
- (b) The elements can be made very small, so their very low thermal capacities can yield a small time-constant. However, very small thermistors with their low thermal capacity have the disadvantage that, for a given dissipation, the self-heating effect is greater than for large thermometers. Thus, care must be taken to keep the power dissipation small.

A typical thermistor has a resistance which varies by a factor of 100 or 200 over the temperature range -40 to 40°C .

2.4.1.3 Thermocouples

In 1821 Seebeck discovered that a very small contact electromotive force was set up at the place where two different metals touched. If a simple circuit is made with two metals and with the conjunction at the same temperature, there will be no resultant electromotive force in the circuit because the two electromotive forces, one at each junction, will exactly oppose and cancel one another. If the temperature of one junction is altered, the two electromotive forces no longer balance and there is a net electromotive force set up in the circuit; a current will then flow. When there are several junctions, the resultant

electromotive force is the algebraic sum of the individual electromotive forces. The magnitude and sign of the contact electromotive force set up at any one junction depend on the types of metals joined and the temperature of the junction point, and may be empirically represented for any two metals by the expression:

$$(E_T - E_s) = \alpha (T - T_s) + \beta (T - T_s)^2 \quad (2.7)$$

where E_T is the contact electromotive force at a temperature T and E_s is the electromotive force at some standard temperature T_s , α and β being constants. If there are two junctions at temperatures T_1 and T_2 , the net electromotive force E_n (the thermal electromotive force) is given by $(E_1 - E_2)$, where E_1 is the electromotive force at temperature T_1 and E_2 is the contact electromotive force temperature T_2 . E_n can also be represented by a quadratic formula of the type given for $(E_T - E_s)$ to a good approximation:

$$E_n = E_1 - E_2 \quad (2.8)$$

$$E_n = a (T_1 - T_2) + b (T_1 - T_2)^2 \quad (2.9)$$

where a and b are constants for the two metals concerned. For most meteorological purposes, it is often possible to neglect the value of b , as it is always small compared with a .

Thermocouples are made by welding or soldering together wires of the metals concerned. These junctions can be made very small and with negligible heat capacity.

When used to measure temperature, a measurement is taken of the electromotive force set up when one junction is maintained at a standard known temperature and the other junction is allowed to take the temperature whose value is required. This electromotive force can be directly related to the difference in temperature between the two junctions by previous calibration of the system, and thus the unknown temperature is found by adding this difference algebraically to the known standard temperature.

In meteorology, thermocouples are mostly used when a thermometer of very small time-constant, of the order of 1 or 2 s, and capable of remote reading and recording is required, usually for special research tasks. A disadvantage, if the absolute temperature is required, is the necessity for a constant-temperature enclosure for both the cold junction and ancillary apparatus for the

measurements of the electromotive force that has been set up; thermocouples are best suited for the measurement of differential temperatures, since this complication does not arise. Very high accuracy can be achieved with suitably sensitive apparatus, but frequent calibration is necessary. Copper-constantan or iron-constantan combinations are suitable for meteorological work, as the electromotive force produced per degree Celsius is higher than with rarer and more expensive metals, which are normally used at high temperatures.

2.4.2 Measurements procedures

2.4.2.1 Electrical resistances and thermistors

Electrical resistance and thermistor thermometers may be connected to a variety of electrical measurement circuits, many of which are variations of resistance bridge circuits in either balanced or unbalanced form. In a balanced bridge, an accurate potentiometer is adjusted until no current flows in an indicator, with the position of the potentiometer arm being related to the temperature. In an unbalanced bridge, the out-of-balance current may be measured by a galvanometer; however, this current is not simply a function of the temperature and depends in part on other effects. An alternative which avoids this situation is to use a constant current source to power the bridge and to measure the out-of-balance voltage to obtain the temperature reading.

In the case of remote measuring, it should be taken into consideration that the wire between the resistance thermometer and the bridge also forms a resistance that alters depending on the temperature. Suitable precautions can be taken to avoid such errors.

Digital voltmeters can be used in conjunction with a constant current source to measure the temperature-dependent voltage drop across the thermometer element; the output can be scaled directly in temperature. Also, the digital output can be stored or transmitted without loss of accuracy and, thus, be available for further use. The digital output of the digital voltmeters can be subsequently converted back to an analogue voltage, if desired, to feed a recorder, for example.

2.4.2.2 Thermocouples

There are two main methods of measuring the electromotive force produced by thermocouples:

- (a) By measuring the current produced in the circuit with a sensitive galvanometer;
- (b) By balancing the thermoelectric electromotive force with a known electromotive force, so that no current actually flows through the thermocouples themselves.

In method (a), the galvanometer is connected directly in series with the two junctions. Method (b) will generally be used if a measuring uncertainty of better than 0.5 per cent is required. This procedure does not depend on the magnitude of, or changes in, the line resistance since no current flows in the balanced condition.

2.4.3 Exposure and siting

The requirements relating to the exposure and siting of electrical thermometers will, in general, be the same as those for liquid-in-glass thermometers (see section 2.2.3). Exceptions include the following:

- (a) The measurement of extreme values: Separate maximum and minimum thermometers may no longer be required if the electrical thermometer is connected to a continuously operating data recording system;
- (b) The measurement of surface temperatures: The radiative properties of electrical thermometers will be different from liquid-in-glass thermometers. Electrical thermometers exposed as grass minimum (or other surface) thermometers will, therefore, record different values from similarly exposed conventional thermometers. These differences may be minimized by placing the electrical thermometer within a glass sheath;
- (c) The measurement of soil temperatures: The use of mercury-in-glass thermometers in vertical steel tubes is quite unsuitable for the measurement of the diurnal variation of soil temperature because of heat conduction from the surface. It is possible to obtain readings that are much more representative by deploying electrical thermometers in brass plugs, inserted at the required depth into an undisturbed vertical soil face, the latter having been exposed by trenching. Electrical connections are brought out through plastic tubes via the trench, which is then refilled in such a way to restore, as far as possible, the original strata and drainage characteristics.

2.4.4 Sources of error

2.4.4.1 Electrical resistances and thermistors

The main sources of error in a temperature measurement taken with electrical resistance thermometers are the following:

- (a) Self-heating of the thermometer element;
- (b) Inadequate compensation for lead resistance;
- (c) Inadequate compensation for non-linearities in the sensor or processing instrument;
- (d) Sudden changes in switch contact resistances.

Self-heating occurs because the passage of a current through the resistance element produces heat and, thus, the temperature of the thermometer element becomes higher than that of the surrounding medium.

The resistance of the connecting leads will introduce an error in the temperature reading. This will become more significant for long leads, for example, when the resistance thermometer is located at some distance from the measuring instrument; the reading errors will also vary as the temperature of the cables changes. These errors can be compensated for by using extra conductors, ballast resistors and an appropriate bridge network.

Neither the electrical resistance thermometer nor the thermistor is linear over an extended temperature range but may approximate a linear output if the range is limited. Provision must, therefore, be made to compensate for such non-linearities. This is most likely to be required for thermistors, to achieve a usable meteorological range of measurement.

Sudden changes in switch contact resistance can occur as switches age. They may be variable and can go undetected unless regular system calibration checks are performed (see section 2.4.5).

2.4.4.2 Thermocouples

The main sources of error in the measurement of temperature using thermocouples are the following:

- (a) Changes in the resistances of the connecting leads with temperature. This effect may be minimized by keeping all the leads as short and compact as possible, and well insulated;

- (b) Conduction along the leads from the junction when there is a temperature gradient in the vicinity of the temperature measuring point;
- (c) Stray secondary thermal electromotive forces due to the use of metals that are different from the thermocouple metals in the connecting circuit. The temperature differences in the remainder of the circuit must, therefore, be kept as low as possible; this is especially important when the electromotive forces to be measured are small (periodical recalibration will be necessary to allow for this);
- (d) Leakage currents can occur from neighbouring power circuits. This can be minimized by suitable screening of the leads;
- (e) Galvanic currents can be set up if any leads or junctions are allowed to get wet;
- (f) Changes in temperature in the galvanometer alter its characteristics (chiefly by changing its resistance). This will not affect the readings by the potentiometric method to any degree, but will affect direct-reading instruments. This effect can be minimized by keeping the temperature of the galvanometer as near as possible to that at which the circuit was calibrated;
- (g) In the potentiometric measurement, changes in the electromotive force of the standard cell against which the potentiometer current is adjusted and changes in the potentiometer current between adjustments will cause corresponding errors in the measured electromotive force. These errors will normally be small, provided that the standard cell is treated correctly, and that adjustments of the potentiometer current are made just before taking a temperature measurement.

Errors (a) and (f) emphasize the superiority of the potentiometric method when a very high degree of accuracy is required.

2.4.5 Comparison and calibration

2.4.5.1 Electrical resistances and thermistors

The basic techniques and procedures for the laboratory calibration and field checking of electrical thermometers will be the same as for liquid-in-glass thermometers (see section 2.2.5). In general, however, it will not be possible to bring a resistance thermometer indoors since checks should include the thermometer's normal electrical leads. Checks

will therefore have to be carried out with the thermometers in the screen. Accurate comparative measurements of the temperatures indicated by the electrical thermometer and a reference mercury-in-glass or local indicating resistance thermometer will be difficult to achieve unless two observers are present. Since the measurement instrument is an integral part of the electrical thermometer, its calibration may be checked by substituting the resistance thermometer by an accurate decade resistance box and by applying resistances equivalent to fixed 5 K temperature increments over the operational temperature range. The error at any point should not exceed 0.1 K. This work would normally be performed by a servicing technician.

2.4.5.2 Thermocouples

The calibration and checking of thermocouples require the hot and cold junctions to be maintained at accurately known temperatures. The techniques and instrumentation necessary to undertake this work are generally very specialized and will not be described here.

2.4.6 Corrections

When initially issued, electrical thermometers (which have a serial number) should be provided with either:

- (a) A dated certificate confirming compliance with the appropriate standard; or
- (b) A dated calibration certificate giving the actual resistance at fixed points in the temperature range. These resistances should be used when checking the uncertainty of the measuring instrument or system interface before and during operation. The magnitude of the resistance difference from the nominal value should not, in general, be greater than an equivalent temperature error of 0.1 or 0.2 K.

2.4.7 Maintenance

The regular field checks should identify any changes in system calibration. These may occur as a result of long-term changes in the electrical characteristics of the thermometer, degradation of the electrical cables or their connections, changes in the contact resistance of switches or changes in the electrical characteristics of the measuring equipment. Identification of the exact source and correction of such errors will require specialized equipment and training and should be undertaken only by a maintenance technician.

2.5 RADIATION SHIELDS

A radiation shield or screen should be designed to provide an enclosure with an internal temperature that is both uniform and the same as that of the outside air. It should completely surround the thermometers and exclude radiant heat, precipitation and other phenomena that might influence the measurement. Screens with forced ventilation, in which air is drawn over the thermometer element by a fan, may help to avoid biases when the microclimate inside the screen deviates from the surrounding air mass. Such a deviation only occurs when the natural wind speed is very low ($< 1 \text{ m s}^{-1}$). When such artificial ventilation is used, care should be taken to prevent the deposition of aerosols and rain droplets on the sensor which decrease its temperature towards the wet-bulb temperature. As a shield material, highly polished, non-oxidized metal is favourable because of its high reflectivity and low heat absorption. Nevertheless, thermally insulating plastic-based material is preferable because of its simple maintenance requirements. Thermally insulating material must be used if the system relies on natural ventilation.

The performance of a screen (response behaviour and microclimate effects introducing unwanted biases) depends predominantly on its design, in which care must be taken to ensure both radiation protection and sufficient ventilation. Since the start of meteorological temperature measurements, very diverse types of screens have been designed. Following the introduction of temperature measurements taken in automatic weather stations, the variety of these designs has increased significantly (see WMO, 1998*a*). Because of differences in specific applications, the degree of automation and climatology, it is difficult to recommend one specific type of design suitable for worldwide measurements. Nevertheless, many investigations and intercomparisons on designs and their performance have been carried out. A clear overview of screen designs is given by WMO (1972). Results of thermometer screen intercomparisons are reported by Andersson and Mattison (1991); Sparks (2001); WMO (1998*b*; 1998*c*; 1998*d*; 2000*a*; 2000*b*; 2002*b*; 2002*c*; 2002*d*); and Zanghi (1987).

An international standard (ISO/DIS 17714) defines most relevant screen types and describes the methods to determine or compare screen performances (ISO, 2004).

2.5.1 Louvred screens

Most of the numerous varieties of louvred screen rely on natural ventilation. The walls of such a screen should preferably be double-louvred and the floor should be made of staggered boards, but other types of construction may be found to meet the above requirements. The roof should be double-layered, with provisions for ventilation of the space between the two layers. In cold climates, owing to the high reflectivity of snow (up to 88 per cent), the screen should also have a double floor. At the same time, however, the floor should easily drop or tilt so that any snow entering the screen during a storm can be removed.

The size and construction of the screen should be such that it keeps the heat capacity as low as practicable and allows ample space between the instruments and the walls. The latter feature excludes all possibility of direct contact between the thermometer sensing elements and the walls, and is particularly important in the tropics where insolation may heat the sides to the extent that an appreciable temperature gradient is caused in the screen. Direct contact between the sensing elements and the thermometer mounting should also be avoided. The screen should be painted both inside and outside with white, non-hygroscopic paint.

When double walls are provided, the layer of air between them serves to reduce the amount of heat that would otherwise be conducted from the outer wall to the inner enclosure, especially in strong sunshine. When the wind is appreciable, the air between the walls is changed continually so that the conduction of heat inwards from the outer walls is further decreased.

The free circulation of air throughout the screen helps the temperature of the inner wall adapt to ambient air changes. In this way, the influence of the inner wall upon the temperature of the thermometer is reduced. Also, the free circulation of air within the screen enables the thermometer to follow the ambient air changes more quickly than if radiative exchanges alone were operative. However, the air circulating through the screen spends a finite time in contact with the outer walls and may have its temperature altered thereby. This effect becomes appreciable when the wind is light and the temperature of the outer wall is markedly different from the air temperature. Thus, the temperature of the air in a screen can be expected to be higher than the true air temperature on a day

of strong sunshine and calm wind, and slightly lower on a clear, calm night, with errors perhaps reaching 2.5 and -0.5 K, respectively, in extreme cases. Additional errors may be introduced by cooling due to evaporation from a wet screen after rain. All these errors also have a direct influence on the readings of other instruments inside the screen, such as hygrometers, evaporimeters, and the like.

Errors due to variations in natural ventilation can be reduced if the screen is fitted with a suitably designed forced ventilation system that maintains a constant and known ventilation rate, at least at low wind speeds. Care should be taken in the design of such systems to ensure that heat from the fan or an electrical motor does not affect the screen temperature.

In general, only one door is needed, with the screen being placed so that the sun does not shine on the thermometers when the door is open at the times of observation. In the tropics, two doors are necessary for use during different periods of the year. Likewise, in polar regions (where the sun is at a low angle) precautions should be taken to protect the inside of the screen from the direct rays of the sun either by a form of shading or by using a screen which is mounted so that it can be turned to an appropriate angle while the door is open for readings.

Although most screens are still made of wood, some recent designs using plastic materials offer greater protection against radiation effects because of an improved louvre design that provides a better air-flow. In any case, the screen and stand should be constructed of sturdy materials and should be firmly installed so that errors in maximum and minimum thermometer readings caused by wind vibration are kept to a minimum. In some areas where wind vibration cannot be entirely damped, elastic mounting brackets are recommended. The ground cover beneath the screen should be grass or, in places

where grass does not grow, the natural surface of the area.

The screen should be kept clean and repainted regularly; in many places, repainting the screen once every two years is sufficient, but in areas subject to atmospheric pollution it may be necessary to repaint it at least once a year.

2.5.2 Other artificially ventilated shields

The main alternative to exposure in a louvred screen, which is either naturally or artificially ventilated, is to shield the thermometer bulb from direct radiation by placing it on the axis of two concentric cylindrical shields and drawing a current of air (with a speed between 2.5 and 10 m s^{-1}) between the shields and past the thermometer bulb. This type of exposure is normal in aspirated psychrometers (see Part I, Chapter 4). In principle, the shields should be made of a thermally insulating material, although in the Assmann psychrometer the shields are made of highly polished metal to reduce the absorption of solar radiation. The inner shield is kept in contact with a moving stream of air on both sides so that its temperature, and consequently that of the thermometer, can approximate very closely to that of the air. Such shields are usually mounted with their axes in a vertical position. The amount of direct radiation from the ground entering through the base of such shields is small and can be reduced by extending the base of the shields appreciably below the thermometer bulb. When the artificial ventilation is provided by an electrically driven fan, care should be taken to prevent any heat from the motor and fan from reaching the thermometers.

The design of the WMO reference psychrometer takes careful account of the effects of radiation and the use of artificial ventilation and shielding to ensure that the thermometer element is at equilibrium at the true air temperature (see Part I, Chapter 4).

ANNEX

DEFINING THE FIXED POINTS OF THE INTERNATIONAL TEMPERATURE SCALE OF 1990

The fixed points of the International Temperature Scale of 1990 (ITS-90) of interest to meteorological measurements are contained in Table 1, while secondary reference points of interest to meteorological measurements are contained in Table 2.

The standard method of interpolating between the fixed points uses formulae to establish the relation between indications of the standard instruments and the values of the ITS-90. The standard instrument used from -259.34 to 630.74°C is a platinum resistance thermometer for which the resistance ratio R_{100}/R_0 is 1.385 0; R_{100} is the resistance at 100°C and R_0 is the resistance at 0°C .

From 0 to 630.74°C , the resistance at temperature t is provided by the equation:

$$R_t = R_0 (1 + A \cdot t + B \cdot t^2) \quad (1)$$

where R_t is the resistance at temperature t of a platinum wire, R_0 is its resistance at 0°C and A and B are constants which are found from measurements at R_t at the boiling point of water and the freezing point of zinc.

From $-189.344\ 2^{\circ}\text{C}$ to 0°C , the resistance at temperature t is provided by the equation:

$$R_t = R_0 (1 + A \cdot t + B \cdot t^2 + C \cdot (t-100) \cdot t^3) \quad (2)$$

where R_t , R_0 , A and B are determined as for equation 1 above and C is found by measurement at the boiling point of oxygen.

Table 1. Defining fixed points on the ITS-90

<i>Equilibrium state</i>	<i>Assigned value of ITS</i>	
	<i>K</i>	<i>°C</i>
Equilibrium between the solid, liquid and vapour phases of argon (triple point of argon)	83.805 8	-189.344 2
Equilibrium between the solid, liquid and vapour phases of mercury (triple point of mercury)	234.315 6	-38.834 4
Equilibrium between the solid, liquid and vapour phases of water (triple point of water)	273.160 0	0.01
Equilibrium between the solid and liquid phases of gallium (freezing point of gallium)	302.914 6	29.764 6
Equilibrium between the solid and liquid phases of indium (freezing point of indium)	429.748 5	156.598 5

Table 2. Secondary reference points and their temperatures on the ITS-90

<i>Equilibrium state</i>	<i>Assigned value of ITS</i>	
	<i>K</i>	<i>°C</i>
Equilibrium between the solid and vapour phases of carbon dioxide (sublimation point of carbon dioxide) at standard atmospheric pressure p_0 (1 013.25 hPa). The temperature t as a function of the vapour pressure of carbon dioxide is given by the equation: $t = [1.210\,36 \cdot 10^{-2}(p-p_0) - 8.912\,26 \cdot 10^{-6}(p-p_0)^2 - 78.464] \text{ °C}$ where p is the atmospheric pressure in hPa, in the temperature range 194 to 195 K	194.686	-78.464
Equilibrium between the solid and liquid phases of mercury (freezing point of mercury) at standard atmospheric pressure	234.296	-38.854
Equilibrium between ice and air-saturated water (ice-point) at standard atmospheric pressure	273.150	0.00
Equilibrium between the solid, liquid and vapour phases of phenoxybenzene (diphenyl ether) (triple point of phenoxybenzene)	300.014	26.864

REFERENCES AND FURTHER READING

- Andersson, T. and I. Mattison, 1991: *A Field Test of Thermometer Screens*. SMHI Report No. RMK 62, Norrköping.
- Bureau International des Poids et Mesures/Comité Consultatif de Thermométrie, 1990: The International Temperature Scale of 1990 (ITS-90) (H. Preston-Thomas). *Metrologia*, 1990, 27, pp. 3-10.
- Her Majesty's Stationery Office/Meteorological Office, 1980: *Handbook of Meteorological Instruments*. Second edition, Volume 2: Measurement of temperature, London.
- International Organization for Standardization, 2004: *Test Methods for Comparing the Performance of Thermometer Shields/Screens and Defining Important Characteristics*. ISO/DIS 17714, Geneva.
- Jones, E.B., 1992: *Jones' Instrument Technology*. Volume 2: Measurement of temperature and chemical composition, fourth edition, Butterworths-Heinemann, Oxford.
- Middleton, W.E.K. and A.F. Spilhaus, 1960: *Meteorological Instruments*. Third edition, University of Toronto Press.
- Sparks, W.R., 1970: Current concepts of temperature measurement applicable to synoptic networks. *Meteorological Monographs*, Volume 11, Number 33, pp. 247-251.
- Sparks, W.R., 2001: Field trial of Metspec screens. *Technical Report TR19*, Met Office/OD, Wokingham, United Kingdom.
- World Meteorological Organization, 1972: *The Effect of Thermometer Screen Design on the Observed Temperature* (W.R. Sparks). WMO-No. 315, Geneva.
- World Meteorological Organization, 1992: *Measurement of Temperature and Humidity* (R.G. Wylie and T. Lalas). Technical Note No. 194, WMO-No. 759, Geneva.
- World Meteorological Organization, 1998a: *Recent Changes in Thermometer Screen Design and their Impact* (A. Barnett, D.B. Hatton and D.W. Jones). Instruments and Observing Methods Report No. 66, WMO/TD-No. 871, Geneva.
- World Meteorological Organization, 1998b: An investigation of temperature screens and their impact on temperature measurements (J. Warne). *Papers Presented at the WMO Technical Conference on Meteorological and Environmental Instruments and Methods of Observation (TECO-98)*, Instruments and Observing Methods Report No. 70, WMO/TD-No. 877, Geneva.
- World Meteorological Organization, 1998c: A thermometer screen intercomparison (J.P. van der Meulen). *Papers Presented at the WMO Technical Conference on Meteorological and Environmental Instruments and Methods of Observation (TECO-98)*, Instruments and Observing Methods Report No. 70, WMO/TD-No. 877, Geneva.
- World Meteorological Organization, 1998d: Comparison of meteorological screens for temperature measurement (G. Lefebvre). *Papers Presented at the WMO Technical Conference on Meteorological and Environmental Instruments and Methods of Observation (TECO-98)*, Instruments and Observing Methods Report No. 70, WMO/TD-No. 877, Geneva.
- World Meteorological Organization, 2000a: A comparison of air temperature radiation screens by field experiments and computational fluid dynamics (CFD) simulations (A. Spetalen, C. Lofseik and P. Ø. Nordli). *Papers Presented at the WMO Technical Conference on Meteorological and Environmental Instruments and Methods of Observation (TECO-2000)*, Instruments and Observing Methods Report No. 74, WMO/TD-No. 1028, Geneva.
- World Meteorological Organization, 2000b: Temperature measurements: Some considerations for the intercomparison of radiation screens (J.P. van der Meulen). *Papers Presented at the WMO Technical Conference on Meteorological and Environmental Instruments and Methods of Observation (TECO-2000)*, Instruments and Observing Methods Report No. 74, WMO/TD-No. 1028, Geneva.
- World Meteorological Organization, 2002a: Measurement of temperature with wind sensors during severe winter conditions (M. Musa, S. Suter, R. Hyvönen, M. Leroy, J. Rast and B. Tammelin). *Papers Presented at the WMO Technical Conference on Meteorological and Environmental Instruments and Methods of Observation (TECO-2002)*, Instruments and Observing Methods Report No. 75, WMO/TD-No. 1123, Geneva.
- World Meteorological Organization, 2002b: Norwegian national thermometer screen intercomparison (M.H. Larre and K. Hegg).

- Papers Presented at the WMO Technical Conference on Meteorological and Environmental Instruments and Methods of Observation (TECO-2002)*, Instruments and Observing Methods Report No. 75, WMO/TD-No. 1123, Geneva.
- World Meteorological Organization, 2002c: Results of an intercomparison of wooden and plastic thermometer screens (D.B. Hatton). *Papers Presented at the WMO Technical Conference on Meteorological and Environmental Instruments and Methods of Observation (TECO-2002)*, Instruments and Observing Methods Report No. 75, WMO/TD-No. 1123, Geneva.
- World Meteorological Organization, 2002d: Temperature and humidity measurements during icing conditions (M. Leroy, B. Tammelin, R. Hyvönen, J. Rast and M. Musa). *Papers Presented at the WMO Technical Conference on Meteorological and Environmental Instruments and Methods of Observation (TECO-2002)*, Instruments and Observing Methods Report No. 75, WMO/TD-No. 1123, Geneva.
- Zanghi, F., 1987: *Comparaison des Abris Météorologiques*. Technical Memorandum No. 11, Météo-France/SETIM, Trappes.
-

CHAPTER 3

MEASUREMENT OF ATMOSPHERIC PRESSURE

3.1 GENERAL

3.1.1 Definition

The atmospheric pressure on a given surface is the force per unit area exerted by virtue of the weight of the atmosphere above. The pressure is thus equal to the weight of a vertical column of air above a horizontal projection of the surface, extending to the outer limit of the atmosphere.

Apart from the actual pressure, pressure trend or tendency has to be determined as well. Pressure tendency is the character and amount of atmospheric pressure change for a 3 h or other specified period ending at the time of observation. Pressure tendency is composed of two parts, namely the pressure change and the pressure characteristic. The pressure change is the net difference between pressure readings at the beginning and end of a specified interval of time. The pressure characteristic is an indication of how the pressure has changed during that period of time, for example, decreasing then increasing, or increasing and then increasing more rapidly.

3.1.2 Units and scales

The basic unit for atmospheric pressure measurements is the pascal (Pa) (or newton per square metre). It is accepted practice to add the prefix “hecto” to this unit when reporting pressure for meteorological purposes, making the hectopascal (hPa), equal to 100 Pa, the preferred terminology. This is largely because one hectopascal equals one millibar (mbar), the formerly used unit.

The scales of all barometers used for meteorological purposes should be graduated in hPa. Some barometers are graduated in “millimetres or inches of mercury under standard conditions”, $(\text{mm Hg})_n$ and $(\text{in Hg})_n$, respectively. When it is clear from the context that standard conditions are implied, the briefer terms “millimetre of mercury” or “inch of mercury” may be used. Under these standard conditions, a column of mercury having a true scale height of 760 $(\text{mm Hg})_n$ exerts a pressure of 1 013.250 hPa.

The following conversion factors will then apply:

$$1 \text{ hPa} = 0.750\,062 \text{ (mm Hg)}_n$$

$$1 \text{ (mm Hg)}_n = 1.333\,224 \text{ hPa}$$

In the case where the conventional engineering relationship between the inch and the millimetre is assumed, namely $1 \text{ in} = 25.4 \text{ mm}$, the following conversion factors are obtained:

$$1 \text{ hPa} = 0.029\,530 \text{ (in Hg)}_n$$

$$1 \text{ (in Hg)}_n = 33.863\,9 \text{ hPa}$$

$$1 \text{ (mm Hg)}_n = 0.039\,370\,08 \text{ (in Hg)}_n$$

Scales on mercury barometers for meteorological purposes should be so graduated that they yield true pressure readings directly in standard units when the entire instrument is maintained at a standard temperature of 0°C and the standard value of gravity is $9.806\,65 \text{ m s}^{-2}$.

Barometers may have more than one scale engraved on them, for example, hPa and mm Hg, or hPa and in Hg, provided that the barometer is correctly calibrated under standard conditions.

Pressure data should be expressed in hectopascals. Hereafter in this chapter only the unit hectopascal will be used.

3.1.3 Meteorological requirements

Analysed pressure fields are a fundamental requirement of the science of meteorology. It is imperative that these pressure fields be accurately defined as they form the basis for all subsequent predictions of the state of the atmosphere. Pressure measurements must be as accurate as technology will allow, within realistic financial constraints, and there must be uniformity in the measurement and calibration procedures across national boundaries.

The level of accuracy needed for pressure measurements to satisfy the requirements of various meteorological applications has been identified by the respective WMO commissions and is outlined in Part I, Chapter 1, Annex 1.B, which is the primary reference for measurement specifications in this Guide. The requirements are as follows:

Measuring range:	500 – 1 080 hPa (both station pressure and mean sea-level pressure)
Required target uncertainty:	0.1 hPa
Reporting resolution:	0.1 hPa

Sensor time constant: 20 s
 Output averaging time: 1 min

The above requirements should be considered achievable for new barometers in a strictly controlled environment, such as those available in a properly equipped laboratory. They provide an appropriate target accuracy for barometers to meet before their installation in an operational environment.

For barometers installed in an operational environment, practical constraints will require well-designed equipment for a National Meteorological Service to maintain this target accuracy. Not only the barometer itself, but the exposure also requires special attention. Nevertheless, the performance of the operational network station barometer, when calibrated against a standard barometer whose index errors are known and allowed for, should not be below the stated criteria.

3.1.4 **Methods of measurement and observation**

For meteorological purposes, atmospheric pressure is generally measured with electronic barometers, mercury barometers, aneroid barometers or hypsometers. The latter class of instruments, which depends on the relationship between the boiling point of a liquid and the atmospheric pressure, has so far seen only limited application and will not be discussed in depth in this publication. A very useful discussion of the performance of digital barometers (which mostly have electronic read-out) is found in WMO (1992*a*).

Meteorological pressure instruments (barometers) are suitable for use as operational instruments for measuring atmospheric pressure if they meet the following requirements:

- (a) The instruments must be calibrated or controlled regularly against a (working) standard barometer using approved procedures. The period between two calibrations must be short enough to ensure that the total absolute measurement error will meet the accuracy requirements defined in this chapter;
- (b) Any variations in the accuracy (long-term and short-term) must be much smaller than the tolerances outlined in section 3.1.3. If some instruments have a history of a drift in calibration, they will be suitable operationally only if the period between calibrations

is short enough to ensure the required measurement accuracy at all times;

- (c) Instrument readings should not be affected by temperature variations. Instruments are suitable only if:
 - (i) Procedures for correcting the readings for temperature effects will ensure the required accuracy; and/or
 - (ii) The pressure sensor is placed in an environment where the temperature is stabilized so that the required accuracy will be met.

Some instruments measure the temperature of the pressure sensor in order to compensate for temperature effects. It is necessary to control and calibrate these temperature-compensating functions as part of the standard calibration activity;

- (d) The instrument must be placed in an environment where external effects will not lead to measurement errors. These effects include wind, radiation/temperature, shocks and vibrations, fluctuations in the electrical power supply and pressure shocks. Great care must be taken when selecting a position for the instrument, particularly for mercury barometers.

It is important that every meteorological observer should fully understand these effects and be able to assess whether any of them are affecting the accuracy of the readings of the barometer in use;

- (e) The instrument should be quick and easy to read. Instruments must be designed so that the standard deviation of their readings is less than one third of the stated absolute accuracy;
- (f) If the instrument has to be calibrated away from its operational location, the method of transportation employed must not affect the stability or accuracy of the barometer. Effects which may alter the calibration of the barometer include mechanical shocks and vibrations, and displacement from the vertical and large pressure variations such as may be encountered during transportation by air.

Most barometers with recent designs make use of transducers which transform the sensor response into pressure-related quantities. These are subsequently processed by using appropriate electrical integration circuits or data-acquisition systems with appropriate smoothing algorithms. A time constant of about 10 s (and definitely no greater than 20 s) is desirable for most synoptic barome-

ter applications. For mercury barometers, the time constant is generally not important.

There are several general methods for measuring atmospheric pressure which will be outlined in the following paragraphs.

Historically, the most extensively used method for measuring the pressure of the atmosphere involves balancing it against the weight of a column of liquid. For various reasons, the required accuracy can be conveniently attained only if the liquid used is mercury. Mercury barometers are, in general, regarded as having good long-term stability and accuracy, but are now losing favour to equally accurate electronic barometers, which are easier to read.

A membrane of elastic substance, held at the edges, will be deformed if the pressure on one side is greater than on the other. In practice, this is achieved by using a completely or partially evacuated closed metal capsule containing a strong metal spring to prevent the capsule from collapsing due to external atmospheric pressure. Mechanical or electrical means are used to measure the deformation caused by the pressure differential between the inside and outside of the capsule. This is the principle of the well-known aneroid barometer.

Pressure sensor elements comprising thin-walled nickel alloy cylinders, surrounded by a vacuum, have been developed. The natural resonant frequency of these cylinders varies as a function of the difference in pressure between the inside of the cylinder, which is at ambient atmospheric pressure, and the outside of the cylinder, which is maintained as a vacuum.

Absolute pressure transducers, which use a crystal-line quartz element, are becoming more commonly used. Pressure exerted via flexible bellows on the crystal face causes a compressive force on the crystal. On account of the crystal's piezoresistive properties, the application of pressure alters the balance of an active Wheatstone bridge. Balancing the bridge enables accurate determination of the pressure. These types of pressure transducers are virtually free of hysteresis effects.

The boiling point of a liquid is a function of the pressure under which it boils. Once this function has been determined, the temperature at which the liquid boils may be used in a hypsometer to determine the atmospheric pressure.

3.2 MERCURY BAROMETERS

There is an increasing move away from the use of mercury barometers because mercury vapour is highly toxic; free mercury is corrosive to the aluminium alloys used in air frames (for these reasons there are regulations proscribing the handling or carriage of mercury barometers in some countries); special lead glass is required for the tube; the barometer is very delicate and difficult to transport; it is difficult to maintain the instrument and to clean the mercury; the instrument must be read and corrections applied manually; and other pressure sensors of equivalent accuracy and stability with electronic read-out are now commonly available.

3.2.1 Construction requirements

The basic principle of a mercury barometer is that the pressure of the atmosphere is balanced against the weight of a column of mercury. In some barometers, the mercury column is weighed on a balance, but, for normal meteorological purposes, the length of the mercury column is measured against a scale graduated in units of pressure.

There are several types of mercury barometers in use at meteorological stations, with the fixed cistern and the Fortin types being the most common. The length to be measured is the distance between the top of the mercury column and the upper surface of the mercury in the cistern. Any change in the length of the mercury column is, of course, accompanied by a change in the level of the mercury in the cistern. In the Fortin barometer, the level of the mercury in the cistern can be adjusted to bring it into contact with an ivory pointer, the tip of which is at the zero of the barometer scale. In the fixed-cistern barometer, often called the Kew-pattern barometer, the mercury in the cistern does not need to be adjusted as the scale engraved on the barometer is contracted to allow for changes in the level of the mercury in the cistern.

3.2.2 General requirements

The main requirements of a good mercury station barometer include the following:

- (a) Its accuracy should not vary over long periods. In particular, its hysteresis effects should remain small;
- (b) It should be quick and easy to read, and readings should be corrected for all known effects. The observers employing these corrections must understand their significance to ensure

that the corrections applied are correct and not, in fact, causing a deterioration in the accuracy of the readings;

- (c) It should be transportable without a loss of accuracy;
- (d) The bore of the tube should not be less than 7 mm and should preferably be 9 mm;
- (e) The tube should be prepared and filled under vacuum. The purity of the mercury is of considerable significance. It should be double-distilled, degreased, repeatedly washed, and filtered;
- (f) The actual temperature for which the scale is assumed to give correct readings, at standard gravity, should be engraved upon the barometer. The scale should preferably be calibrated to give correct readings at 0°C;
- (g) The meniscus should not be flat unless the bore of the tube is large (greater than 20 mm);
- (h) For a marine barometer, the error at any point should not exceed 0.5 hPa.

The response time for mercury barometers at land stations is usually very small compared with that of marine barometers and instruments for measuring temperature, humidity and wind.

3.2.3 Standard conditions

Given that the length of the mercury column of a barometer depends on other factors, especially on temperature and gravity, in addition to the atmospheric pressure, it is necessary to specify the standard conditions under which the barometer should theoretically yield true pressure readings. The following standards are laid down in the international barometer conventions.

3.2.3.1 Standard temperature and density of mercury

The standard temperature to which mercury barometer readings are reduced to remove errors associated with the temperature-induced change in the density of mercury is 0°C.

The standard density of mercury at 0°C is taken to be $1.359\,51 \cdot 10^4$ kg m⁻³ and, for the purpose of calculating absolute pressure using the hydrostatic equation, the mercury in the column of a barometer is treated as an incompressible fluid.

The density of impure mercury is different from that of pure mercury. Hence, a barometer

containing impure mercury will produce reading errors as the indicated pressure is proportional to the density of mercury.

3.2.3.2 Standard gravity

Barometric readings have to be reduced from the local acceleration of gravity to standard (normal) gravity. The value of standard gravity (g_n) is regarded as a conventional constant, $g_n = 9.806\,65$ m s⁻².

Note: The need to adopt an arbitrary reference value for the acceleration of gravity is explained in WMO (1966). This value cannot be precisely related to the measured or theoretical value of the acceleration of gravity in specified conditions, for example, sea level at latitude 45°, because such values are likely to change as new experimental data become available.

3.2.4 Reading mercury barometers

When making an observation with a mercury barometer, the attached thermometer should be read first. This reading should be taken as quickly as possible, as the temperature of the thermometer may rise owing to the presence of the observer. The barometer should be tapped a few times with the finger in two places, one adjacent to the meniscus and the other near the cistern, so as to stabilize the mercury surfaces. If the barometer is not of a fixed-cistern type, the necessary adjustment should be made to bring the mercury in the cistern into contact with the fiducial pointer. Lastly, the vernier should be set to the meniscus and the reading taken. The vernier is correctly adjusted when its horizontal lower edge appears to be touching the highest part of the meniscus; with a magnifying glass it should be possible to see an exceedingly narrow strip of light between the vernier and the top of the mercury surface. Under no circumstances should the vernier “cut off” the top of the meniscus. The observer’s eye should be in such a position that both front and back lower edges of the vernier are in the line of vision.

3.2.4.1 Accuracy of readings

The reading should be taken to the nearest 0.1 hPa. Usually it is not possible to read the vernier to any greater accuracy.

Optical and digital systems have been developed to improve the reading of mercury barometers. Although they normally ease the observations, such systems may also introduce new sources of

error, unless they have been carefully designed and calibrated.

3.2.4.2 Changes in index correction

Any change in the index correction shown during an inspection should be considered on its merits, keeping in mind the following:

- (a) The history of the barometer;
- (b) The experience of the inspector in comparison work;
- (c) The magnitude of the observed change;
- (d) The standard deviation of the differences;
- (e) The availability of a spare barometer at the station, the correction of which is known with accuracy;
- (f) The behaviour of travelling standards during the tour;
- (g) The agreement, or otherwise, of the pressure readings of the station with those of neighbouring stations on the daily synoptic chart if the change is accepted;
- (h) Whether or not the instrument was cleaned before comparison.

Changes in index errors of station barometers, referred to as drift, are caused by:

- (a) Variations in the capillary depression of the mercury surfaces due to contamination of the mercury. In areas of severe atmospheric pollution from industrial sources, mercury contamination may constitute a serious problem and may require relatively frequent cleaning of the mercury and the barometer cistern;
- (b) The rise of air bubbles through the mercury column to the space above.

These changes may be erratic, or consistently positive or negative, depending on the cause.

Changes in index correction are also caused by:

- (a) Observer error resulting from failure to tap the barometer before taking the reading and improper setting of the vernier and fiducial point;
- (b) Lack of temperature equilibrium in either the station barometer or the travelling standard;
- (c) Non-simultaneity of readings when the pressure is changing rapidly.

Such changes can be caused by accidental displacement of the adjustable scale and the shrinkage or loosening of fiducial points in Fortin-type barometers.

3.2.4.3 Permissible changes in index correction

Changes in index correction should be treated as follows:

- (a) A change in correction within 0.1 hPa may be neglected unless persistent;
- (b) A change in correction exceeding 0.1 hPa but not exceeding 0.3 hPa may be provisionally accepted unless confirmed by at least one subsequent inspection;
- (c) A change in correction exceeding 0.3 hPa may be accepted provisionally only if the barometer is cleaned and a spare barometer with known correction is not available. This barometer should be replaced as soon as a correctly calibrated barometer becomes available.

Barometers with changes in index correction identified in (b) and (c) above warrant close attention. They should be recalibrated or replaced as soon as practicable.

The same criteria apply to changes in the index corrections of the travelling standards as those applied as to station barometers. A change in correction of less than 0.1 hPa may be neglected unless persistent. A larger change in correction should be confirmed and accepted only after repeated comparisons. The "before" and "after" tour index corrections of the travelling standard should not differ by more than 0.1 hPa. Only barometers with a long history of consistent corrections should, therefore, be used as travelling standards.

3.2.5 Correction of barometer readings to standard conditions

In order to transform barometer readings taken at different times and different places into usable atmospheric pressure values, the following corrections should be made:

- (a) Correction for index error;
- (b) Correction for gravity;
- (c) Correction for temperature.

For a large number of operational meteorological applications, it is possible to obtain acceptable results by following the barometer manufacturer's instructions, provided that it is clear that these procedures give pressure readings of the necessary uncertainty. However, if these results are not satisfactory or if higher precision is required, detailed procedures should be followed to correct for the above factors; these procedures are described in Annex 3.A.

3.2.6 **Errors and faults with mercury barometers**

3.2.6.1 **Uncertainties as to the temperature of the instrument**

The temperature indicated by the attached thermometer will not usually be identical to the mean temperature of the mercury, the scale and the cistern. The resultant error can be reduced by favourable exposure and by using a suitable observation procedure. Attention is drawn to the frequent existence of a large, stable vertical temperature gradient in a room, which may cause a considerable difference between the temperature of the upper and lower parts of the barometer. An electric fan can prevent such a temperature distribution but may cause local pressure variations and should be switched off before an observation is made. Under normal conditions, the error associated with the temperature reduction will not exceed 0.1 hPa if such precautions are taken.

3.2.6.2 **Defective vacuum space**

It is usually assumed that there is a perfect vacuum, or only a negligible amount of gas, above the mercury column when the instrument is calibrated. Any change in this respect will cause an error in pressure readings. A rough test for the presence of gas in the barometer tube can be made by tilting the tube and listening for the click when the mercury reaches the top, or by examining the closed end for the presence of a bubble, which should not exceed 1.5 mm in diameter when the barometer is inclined. The existence of water vapour cannot be detected in this way, as it is condensed when the volume decreases. According to Boyle's Law, the error caused by air and unsaturated water vapour in the space will be inversely proportional to the volume above the mercury. The only satisfactory way to overcome this error is by conducting a recalibration over the entire scale; if the error is large, the barometer tube should be refilled or replaced.

3.2.6.3 **The capillary depression of the mercury surfaces**

The height of the meniscus and the capillary depression,¹ for a given tube, may change with the ageing of the glass tube, mercury contamination, pressure

1 Capillary depression is a reduction in height of the meniscus of a liquid contained in a tube where the liquid (such as mercury) does not wet the walls of the tube. The meniscus is shaped convex upward.

tendency, and the position of the mercury in the tube. As far as is practicable, the mean height of the meniscus should be observed during the original calibration and noted on the barometer certificate. No corrections should be made for departures from the original meniscus height, and the information should be used only as an indication of the need, or otherwise, to overhaul or recalibrate the barometer. A 1 mm change in the height of the meniscus (from 1.8 to 0.8 mm) for an 8 mm tube may cause an error of about 0.5 hPa in the pressure readings.

It should be noted that large variations in the angle of contact between the mercury and the wall of the cistern in a fixed-cistern barometer may cause small but appreciable errors in the observed pressure.

3.2.6.4 **Lack of verticality**

If the bottom of a symmetrical barometer of normal length (about 90 cm), which hangs freely, is displaced by about 6 mm from the vertical position, the indicated pressure will be about 0.02 hPa too high. Such barometers generally hang more truly vertical than this.

In the case of an asymmetrical barometer, however, this source of error is more critical. For example, if the fiducial pointer in the cistern is about 12 mm from the axis, the cistern needs to be displaced by only about 1 mm from the vertical to cause an error of 0.02 hPa.

3.2.6.5 **General accuracy of the corrected pressure readings**

The standard deviation of a single, corrected barometer reading at an ordinary meteorological station should be within 0.1 hPa. This error will mainly be the result of the unavoidable uncertainty in the instrument correction, the uncertainty concerning the temperature of the instrument, and the error caused by the pumping effect of wind gusts on the mercury surface.

3.2.7 **Safety precautions for the use of mercury**

Mercury is used in relatively large quantities in barometers and, because it is poisonous, must be handled with care. Elemental mercury is a liquid at temperatures and pressures experienced at the Earth's surface. Mercury vapour forms in the air whenever liquid mercury is present. Mercury can be absorbed through the skin in both liquid and gaseous states and can be inhaled as a vapour.

The properties of mercury are described by Sax (1975). In many countries, precautions for its use are prescribed by regulations governing the handling of hazardous goods.

A large dose of mercury may cause acute poisoning. It can also accumulate in the body's hard and soft tissues and prolonged exposure to even a low dose can cause long-term damage to organs, or even death. Mercury mainly affects the central nervous system, and the mouth and gums, with symptoms that include pain, loosening of teeth, allergic reactions, tremors and psychological disturbance.

For barometric applications, the main risks occur in laboratories where barometers are frequently emptied or filled. There may also be problems in meteorological stations if quantities of mercury, for example from a broken barometer, are allowed to remain in places where it may continuously vaporize into an enclosed room where people work.

A danger exists even if the mercury is properly contained and if it is cleaned up after an accident. The following points must be considered when using mercury:

- (a) Vessels containing mercury must be well sealed and not likely to leak or easily break, and must be regularly inspected;
- (b) The floor of a room where mercury is stored or used in large quantities should have a sealed, impervious and crack-free floor covering, such as PVC. Small cracks in the floor, such as those between floor tiles, will trap mercury droplets. It is preferable to have the flooring material curving up the walls by approximately 10 cm, leaving no joint between the floor and the walls at floor level;
- (c) Mercury must not be stored in a metal container as it reacts with almost all metals, except iron, forming an amalgam which may also be hazardous. Mercury should not come into contact with any other metallic object;
- (d) Mercury must not be stored with other chemicals, especially amines, ammonia or acetylene;
- (e) Large quantities of mercury should always be stored and handled in a well-ventilated room. The raw material should be handled in a good-quality fume cupboard;
- (f) Mercury should never be stored near a heat source of any kind as it has a relatively low boiling point (357°C) and may produce hazardous concentrations of toxic vapour, especially during a fire;
- (g) If mercury is handled, the room where it is used and the personnel using it should be

regularly tested to determine if hazardous quantities of mercury are being encountered.

3.2.7.1 Spillages and disposal

The two common methods of cleaning up mercury spillages are either with a suitable aspirated pick-up system, as outlined below, or by adsorption/amalgamation of the mercury onto a powder.

Mercury should be cleaned up immediately. The operator should wear PVC gloves or gauntlets, safety goggles and, for significant spills, a respirator fitted with a mercury vapour cartridge. Depending upon how large the spillage is, the mercury will be picked up by using a vacuum system; an adsorption kit should then be used to clean up the small droplets. The use of an adsorption kit is imperative because, during a spillage, dozens of small droplets of less than 0.02 mm in diameter will adhere to surfaces and cannot be efficiently removed with a vacuum system.

In an aspirated pick-up system, the mercury is drawn through a small-diameter plastic tube into a glass flask with approximately 3 cm of water in the bottom, with the tube opening being below the water line in the flask. One end of a larger diameter plastic tube is connected to the air space above the water in the flask, and the other end is connected to a vacuum cleaner or vacuum pump. The water prevents the mercury vapour or droplets from being drawn into the vacuum cleaner or pump. The slurry is then placed in a clearly labelled plastic container for disposal.

By using adsorption material, a variety of compounds can be used to adsorb or amalgamate mercury. These include zinc powder, sulphur flour or activated carbon. Commercial kits are available for cleaning up mercury spills. The powder is sprinkled on the spill and allowed to adsorb or amalgamate the mercury. The resulting powder is swept up and placed in a clearly labelled plastic container for disposal.

The collected mercury can be either disposed of or recovered. Details on how to dispose of mercury can be obtained from local authorities and/or the supplier. The supplier can also advise on recovery and purification.

3.2.7.2 Fire

Mercury will not burn but does give off significant concentrations of toxic fumes. After a fire, the mercury vapour will condense on the nearest

cool surfaces, contaminating large areas and being adsorbed onto open surfaces, such as carbonized timber. During a fire, evacuate the area and remain upwind of any fumes. Advise the fire authorities of the location and quantity of mercury involved.

3.2.7.3 Transportation

The transportation by air of mercury or instruments containing mercury is regulated by the International Air Transport Association. Transportation by rail or road is usually governed by the hazardous material regulations in each country.

In general, metallic mercury must be packed in glass or plastic containers of less than 2.5 kg capacity. The containers should be packed with sufficient cushioning to prevent breakage and should be clearly labelled. Mercury-containing instruments should be packed in a strong cushioned case which is leak-proof and impervious to mercury.

3.3 ELECTRONIC BAROMETERS

Most barometers with recent designs make use of transducers which transform the sensor response into a pressure-related electrical quantity in the form of either analogue signals, for example, voltage (DC or AC with a frequency related to the actual pressure), or digital signals, for example, pulse frequency or with standard data communication protocols such as RS232, RS422 or IEEE488. Analogue signals can be displayed on a variety of electronic meters. Monitors and data-acquisition systems, such as those used in automatic weather stations, are frequently used to display digital outputs or digitized analogue outputs.

Current digital barometer technology employs various levels of redundancy to improve the long-term stability and accuracy of the measurements. One technique is to use three independently operating sensors under centralized microprocessor control. Even higher stability and reliability can be achieved by using three completely independent barometers, incorporating three sets of pressure transducers and microprocessors. Each configuration has automatic temperature compensation from internally mounted temperature sensors. Triple redundancy ensures excellent long-term stability and measurement accuracy, even in the most demanding applications. These approaches allow for continuous monitoring and verification of the individual sensor performances.

The use of digital barometers introduces some particular operational requirements, especially when they are used with automatic weather stations, and formal recommendations exist to ensure good practice (see Annex VII of the *Abridged Final Report of the Eleventh Session of the Commission for Instruments and Methods of Observation*, 1994, WMO-No. 807). Meteorological organizations should:

- (a) Control or re-adjust the calibration setting of digital barometers upon receipt and repeat these operations regularly (annually, until the rate of drift is determined);
- (b) Ensure regular calibration of digital barometers and investigate the possibility of using calibration facilities available nationally for this purpose;
- (c) Consider that certain types of digital barometers may be used as travelling standards because of their portability and good short-term stability;
- (d) Consider that the selection of a specific type of digital barometer should not only be based on stated instrument specifications but also on environmental conditions and maintenance facilities.

Manufacturers should:

- (a) Improve the temperature independence and the long-term stability of digital barometers;
- (b) Use standardized communication interfaces and protocols for data transmission;
- (c) Enable the power supply of a digital barometer to function over a large range of DC voltages (for example, 5 to 28 VDC).

3.3.1 Aneroid displacement transducers

Contact-free measurement of the displacement of the aneroid capsule is a virtual necessity as regards precision pressure-measuring instruments for meteorological applications. A wide variety of such transducers are in use, including capacitive displacement detectors, potentiometric displacement detectors, strain gauges placed at strategic points on the sensor, and force-balanced servo-systems which keep the sensor dimensions constant regardless of pressure.

All sensitive components must be encased in a die-cast housing. This housing must be kept at a constant temperature by an electronically controlled heater. Condensation of water must be completely prevented. An effective technique is to put a hygroscopic agent, such as silica gel crystals, into the die-cast housing and to prevent

water vapour diffusion into the housing by connecting a long plastic tube (approximately 25 m) with a bore of 2 mm or less between the pressure port and a static head (see section 3.8.1).

The pressure-sensor housing must be airtight, allowing external connection to the compartment where the pressure is to be measured.

3.3.2 Digital piezoresistive barometers

Measurements of atmospheric pressure have become possible by utilizing the piezoelectric (piezoresistive) effect. A common configuration features four measuring resistors placed onto the flexible surface of a monolithic silicon substrate interconnected to form a Wheatstone bridge circuit.

Axially loaded crystalline quartz elements are used in digital piezoresistive barometers and are a type of absolute pressure transducer. Crystalline quartz has been chosen because of its piezoelectric properties, stable frequency characteristics, small temperature effects and precisely reproducible frequency characteristics. Pressure applied to an inlet port causes an upward axial force by means of flexible bellows, thus resulting in a compressive force on the quartz crystal element. Since the crystal element is a substantially rigid membrane, the entire mechanical structure is constrained to minute deflections, thereby virtually eliminating mechanical hysteresis.

The fully active Wheatstone bridge mentioned above may consist either of semiconductor strain gauges or piezoresistive gauges. The strain gauges are either bonded to a thin circular diaphragm, which is clamped along its circumference, or atomically diffused into a silicon diaphragm configuration. In the case of diffused devices, the silicon integrated chip itself is the diaphragm. Applied pressure presents a distributed load to the diaphragm which, in turn, provides bending stress and resultant strains to which the strain gauges react. This stress creates a strain that is proportional to the applied pressure and which results in a bridge imbalance. The bridge output is then proportional to the net difference in pressure acting upon the diaphragm.

This mode of operation is based on the fact that the atmospheric pressure acts on the sensor element covering a small evacuated cell, through which the resistors are submitted to compressive

and tensile stresses. By the piezoelectric effect, the values of resistance change proportionally with atmospheric pressure. To eliminate temperature errors, the sensor often incorporates a built-in thermostat.

The output from the Wheatstone bridge, which is fed from a direct-current source, is transduced into a standard signal by an appropriate amplifier. A light-emitting diode or liquid crystal display usually presents the measured pressure values.

In a modern version of the pressure transducer using a piezoelectric transducer, two resonance frequencies of the piezoelectric element are determined. By calculating a linear function of these frequencies and with an appropriate set of variables obtained after calibration, a pressure is calculated by a microprocessor which is independent of the temperature of the sensor.

3.3.3 Cylindrical resonator barometers

Cylindrical resonator barometers use a sensing element which is a thin-walled cylinder of nickel alloy. This is electromagnetically maintained in a "hoop" mode of vibration. The input pressure is sensed by the variation it produces in the natural resonant frequency of the vibrating mechanical system. Cylinder wall movement is sensed by a pick-up coil whose signal is amplified and fed back to a drive coil. The air pressure to be measured is admitted to the inside of the cylinder, with a vacuum reference maintained on the outside. The natural resonant frequency of vibration then varies precisely with the stress set up in the wall due to the pressure difference across it. An increase in pressure gives rise to an increase in frequency.

The thin cylinder has sufficient rigidity and mass to cater for the pressure ranges over which it is designed to operate, and is mounted on a solid base. The cylinder is placed in a vacuum chamber and its inlet is connected to the free atmosphere for meteorological applications. Since there is a unique relationship between the natural resonant frequency of the cylinder and the pressure, the atmospheric pressure can be calculated from the measured resonant frequency. However, this relationship, determined during calibration, depends on the temperature and the density of the gas. Temperature compensation is therefore required and the air should be dried before it enters the inlet.

3.3.4 Reading electronic barometers

An electronic barometer measures the atmospheric pressure of the surrounding space or any space that is connected to it via a tube. In general, the barometer should be set to read the pressure at the level of the instrument. On board a ship or at low-level land stations, however, the instrument may be set to indicate the pressure at mean sea level, provided that the difference between the station pressure and the sea-level pressure can be regarded as constant.

Electronic barometers give accurate readings on a digital read-out, normally scaled in hPa but readily adaptable to other units, if required. Provision can usually be made for digital recording. Trend in pressure changes can be presented if the unit is microprocessor-controlled.

The accuracy of electronic barometers depends on the accuracy of the barometer's calibration, the effectiveness of the barometer's temperature compensation (residual air method, temperature measurement and correction, use of a thermostat) and the drift with time of the barometer's calibration.

Circuits may be attached to primary transducers which correct the primary output for sensor non-linearities and temperature effects and which convert output to standard units. Standard modern barometer versions comprise the barometer sensor, the microcomputer unit (including the display) and an interface circuit to communicate with any data logger or automatic weather station.

Electronic barometers which have more than one transducer or sensing element generally calculate a weighted mean of the outputs from each of the sensors and establish the resultant pressure with a resolution of 0.1 hPa. During calibration, each of the sensing elements can be checked with a resolution of 0.01 hPa. This should not lead operators to believe that the sensor accuracy is better than 0.1 hPa (see section 3.10.3.4).

3.3.5 Errors and faults with electronic barometers

3.3.5.1 Calibration drift

Calibration drift is one of the key sources of error with electronic barometers. It is often greater when the barometer is new and decreases with the passage of time. Step jumps in calibration may occur.

In order to maintain the acceptable performance of a barometer, the calibration corrections applied to the readings must be checked at relatively frequent intervals, for example, annually, for early detection and replacement of defective sensors.

The need to check frequently the calibration of electronic barometers imposes an additional burden on National Meteorological Services, particularly on those with extensive barometer networks. The ongoing cost of calibration must be taken into consideration when planning to replace mercury barometers with electronic barometers.

3.3.5.2 Temperature

Electronic barometers must be kept at a constant temperature if the calibration is to be maintained. It is also preferable that the temperature be near the calibration temperature. However, many commercially available electronic barometers are not temperature-controlled and are prone to greater error. Most depend on accurate temperature measurement of the sensing element and electronic correction of the pressure. This assumes that there are no thermal gradients within the sensing element of the barometer. In situations where the temperature changes reasonably quickly, this can result in short-term hysteresis errors in the measured pressure.

The change in calibration is also highly dependent on the thermal history of the barometer. Prolonged exposure to temperatures that differ from the calibration temperature can result in medium to long-term calibration shifts.

The electronics of the barometer can also introduce errors if it is not held at the same temperature as the sensor element. Electronic barometers are very often used in extreme climatic conditions, especially in automatic weather stations. In these situations, the barometer can be exposed to temperatures well in excess of its manufacturer's design and calibration specifications.

3.3.5.3 Electrical interference

As with all sensitive electronic measurement devices, electronic barometers should be shielded and kept away from sources of strong magnetic fields, such as transformers, computers, radar, and so forth. Although this is not often a problem, it can cause an increase in noise, with a resultant decrease in the precision of the device.

3.3.5.4 Nature of operation

Apparent changes in the calibration of an electronic barometer can be caused by differences in the way in which the barometer is operated during calibration, as compared with its operational use. A pressure read on a barometer that is run continuously and, therefore, warmed up will read differently from that read in a pulsed fashion every few seconds.

- (b) The scale errors at any point should not exceed 0.3 hPa and should remain within this tolerance over periods of at least one year, when in normal use;
- (c) The hysteresis should be sufficiently small to ensure that the difference in reading before a change in pressure of 50 hPa and after a return to the original value does not exceed 0.3 hPa;
- (d) It should be capable of withstanding ordinary transit risks without introducing inaccuracies beyond the limits specified above.

3.4 ANEROID BAROMETERS

3.4.1 Construction requirements

The greatest advantages of conventional aneroid barometers over mercury barometers are their compactness and portability, which make them particularly convenient for use at sea or in the field. The principal components are a closed metal chamber, completely or partly evacuated, and a strong spring system that prevents the chamber from collapsing under the external atmospheric pressure. At any given pressure, there will be an equilibrium between the force caused by the spring and that of the external pressure.

The aneroid chamber may be made of materials (steel or beryllium copper) that have elastic properties such that the chamber itself can act as a spring.

A means is required to detect and display the changes in deflection which occur. This may be a system of levers that amplify the deflections and drive a pointer over a scale graduated to indicate the pressure. Alternatively, a ray of light may be deviated over the scale. Instead of these mechanical analogue techniques, certain barometers are provided with a manually operated micrometer whose counter indicates the pressure directly in tenths of a hectopascal. A reading is taken when a luminous indicator signals that the micrometer has just made contact with the aneroid. This type of aneroid is portable and robust.

3.4.2 Accuracy requirements

The chief requirements of a good aneroid barometer are as follows:

- (a) It should be compensated for temperature so that the reading does not change by more than 0.3 hPa for a change in temperature of 30 K;

3.4.3 Reading aneroid barometers

3.4.3.1 Accuracy of readings

An aneroid barometer should always be read in the same orientation (vertical or horizontal) as during calibration. It should be tapped lightly before being read. As far as possible, it should be read to the nearest 0.1 hPa. Optical and digital devices are available for improving the reading accuracy and reducing the errors caused by mechanical levers.

3.4.3.2 Corrections applied to aneroid barometers

In general, aneroid barometers should be set to read the pressure at the level of the instrument. On board a ship or at low-lying land stations, however, the instrument may be set to indicate the pressure at mean sea level, provided that the difference between the station pressure and the sea-level pressure can be regarded as constant. The readings should be corrected for instrumental errors, but the instrument is usually assumed to be sufficiently compensated for temperature, and it needs no correction for gravity.

3.4.4 Errors and faults with aneroid barometers

3.4.4.1 Incomplete compensation for temperature

In an aneroid barometer, if the spring is weakened by an increase in temperature, the pressure indicated by the instrument will be too high. This effect is generally compensated for in one of the following ways:

- (a) By means of a bimetallic link in the lever system; or
- (b) By leaving a certain amount of gas inside the aneroid chamber.

In most ordinary aneroid barometers, the compensation obtained by these methods is complete only at one particular compensation pressure. It is desirable that all aneroid barometers and barographs used at meteorological stations should be properly compensated for temperatures over the full range of pressure. In digital read-out systems suitable for automation, such complete corrections can be applied as part of the electronic system.

3.4.4.2 Elasticity errors

An aneroid barometer may be subjected to a large and rapid change in pressure. For example, a strong gust of wind would cause an aneroid barometer to experience a rapid increase in pressure followed by a more gradual return to the original value. In such circumstances, the instrument will, owing to hysteresis, indicate a slightly different reading from the true pressure; a considerable time may elapse before this difference becomes negligible. However, since aneroids and barographs at surface stations are not usually directly exposed to such pressure changes, their hysteresis errors are not excessive.

There is also a secular error caused by slow changes in the metal of the aneroid capsule. This effect can be allowed for only by comparison at regular intervals, for example, annually, with a standard barometer. A good aneroid barometer should retain an accuracy of 0.1 hPa over a period of one year or more. In order to detect departures from this accuracy by individual barometers, a regular inspection procedure with calibration and adjustment as necessary should be instituted.

3.5 BAROGRAPHS

3.5.1 General requirements

Of the various types of barographs, only the aneroid barograph will be dealt with in detail here. For synoptic purposes, it is recommended that charts for barographs:

- (a) Be graduated in hPa;
- (b) Be readable to 0.1 hPa;
- (c) Have a scale factor of 10 hPa to 1.5 cm on the chart.

In addition, the following requirements are desirable:

- (a) The barograph should employ a first-class aneroid unit (see section 3.5.2);
- (b) The barograph should be compensated for temperature, so that the reading does not change by more than 1 hPa for a 20 K change in temperature;
- (c) Scale errors should not exceed 1.5 hPa at any point;
- (d) Hysteresis should be sufficiently small to ensure that the difference in reading before a change in pressure of 50 hPa and after a return to the original value does not exceed 1 hPa;
- (e) There should be a time-marking arrangement that allows the marks to be made without lifting the cover;
- (f) The pen arm should be pivoted in a "gate", the axis of which should be inclined in such a way that the pen rests on the chart through the effects of gravity. A means of adjustment should be provided for setting the position of the pen.

Marine barographs are subject to special requirements, which are considered in Part II, Chapter 4.

3.5.2 Construction of barographs

The principle of the aneroid barograph is similar to that of the aneroid barometer, except that a recording pen is used instead of a pointer. This involves some change in the design of the capsule stack, and usually means a decrease in the overall magnification and an increase in the number and size of the capsules used.

The "control" of the barograph may be expressed as the force required to move the pointer over one unit of the scale (1 hPa) and is, thus, equal to the force required to prevent the pen from moving when the pressure changes by 1 hPa. It is a measure of the effect that friction is likely to have on the details of the record.

The force required to overcome the movement of the capsule when the pressure changes by 1 hPa is $100 A$ newtons, where A is the effective cross-sectional area of the capsule in square metres. If the magnification is X , the force necessary to keep the pen from moving is $100 A/X$ newtons and varies as A/X . For a given type of capsule and scale value, the value of X will be largely independent of A , so that the control of a barograph pen may be considered to vary approximately with the effective cross-sectional area of the capsule.

3.5.3 Sources of error and inaccuracy

In addition to the sources of error mentioned for the aneroid (see section 3.4.4), the friction between the pen and the paper is important. The control of the pen depends largely on the effective cross-section of the aneroid. In a well-made barograph, the friction of the pen is appreciably greater than the total friction at all the pivots and bearings of the instrument; special attention should, therefore, be given to reduce such errors, for example, by having a sufficiently large aneroid capsule.

A first-class barograph should be capable of an uncertainty of about 0.2 hPa after corrections have been applied and should not alter for a period of one or two months. The barometric change read from such a barograph should usually be obtained within the same limits.

3.5.4 Instruments with data-processing capability

A barometer suitable for automated reading can be linked to a computer, typically a microprocessor, which can be programmed to provide suitably sampled data. These data, in turn, can be presented graphically to provide records similar to those supplied by a barograph. Models are available that print their own scales, thereby eliminating one source of error.

3.5.5 Reading a barograph

The barograph should be read without touching the instrument. The time mark and any inspection of the instrument involving lifting the cover, and so on, should always be made after the reading is completed.

3.5.5.1 Accuracy of readings

The chart should be read to the nearest 0.1 hPa. The barometric change should be obtained within the same resolution limits.

3.5.5.2 Corrections to be applied to barograph readings

The temperature compensation of each individual instrument should be tested before the instrument is used, and the scale factor should be adjusted by testing in a vacuum chamber. If the barograph is used only to find the barometric change, the corrections are not usually applied to the readings. In this

case, the accurate setting of the pen position is not important. When absolute pressure values are required from the barograph, the record should be compared with the corrected readings of a mercury barometer or a good aneroid barometer at least once every 24 h and the desired values found by interpolation.

3.6 BOURDON-TUBE BAROMETERS

Bourdon-tube barometers usually consist of a sensor element that, as for an aneroid capsule, changes its shape under the influence of pressure changes (pressure transducers) and a transducer that transforms the changes into a form directly usable by the observer. The display may be remote from the sensor. Precise and stable digital instruments with quartz Bourdon tubes are used as working standard reference barometers in calibration laboratories.

3.7 BAROMETRIC CHANGE

Two methods are available to stations making observations at least every 3 h as follows:

- (a) The change can be read from the barograph; or
- (b) The change can be obtained from appropriate readings of the barometer, corrected to station level. If the choice is between an ordinary mercury barometer and a first-class open-scale barograph, the latter should be selected for the reasons outlined below.

The error of a single barometric reading is mainly random, assuming that the barometer functions perfectly. Therefore, when two independent readings are subtracted to find the amount of change, the errors may be cumulative. Barograph errors are partly systematic in nature, so that in the relatively short period of 3 h, the errors are likely to have the same sign and would, therefore, be diminished by subtraction.

A further reason for using the barograph is the convenience of avoiding the need to correct barometric readings to station level. In any case, the barograph must be used to ascertain the characteristic of the barometric change.

Barometers with digital displays are also very suitable for determining the magnitude and character of a pressure change.

3.8 GENERAL EXPOSURE REQUIREMENTS

It is important that the location of barometers at observation stations be selected with great care. The main requirements of the place of exposure are uniform temperature, good light, a draught-free environment, a solid and vertical mounting, and protection against rough handling. The instrument should, therefore, be hung or placed in a room in which the temperature is constant, or changes only slowly, and in which gradients of temperature do not occur. The barometer should be shielded from direct sunshine at all times and should not be placed near any heating apparatus or where there is a draught.

3.8.1 The effect of wind

It should be noted that the effects of wind apply to all types of barometers. More information on wind effects is found in Liu and Darkow (1989).

A barometer will not give a true reading of the static pressure if it is influenced by gusty wind. Its reading will fluctuate with the wind speed and direction and with the magnitude and sign of the fluctuations, depending also on the nature of the room's openings and their position in relation to the direction of the wind. At sea, error is always present due to the ship's motion. A similar problem will arise if the barometer is installed in an air-conditioned room.

Wind can often cause dynamic changes of pressure in the room where the barometer is placed. These fluctuations are superimposed on the static pressure and, with strong and gusty wind, may amount to 2 or 3 hPa. It is usually impractical to correct for such fluctuations because the "pumping" effect on the mercury surface is dependent on both the direction and the force of the wind, as well as on the local circumstances of the barometer's location. Thus, the "mean value" does not only represent the true static pressure. When comparing barometers in different buildings, the possibility of a difference in readings due to the wind effect should be borne in mind.

It is possible to overcome this effect to a very large extent by using a static head between the exterior atmosphere and the inlet port of the sensor. Details concerning the operating principles of static heads can be found in several publications (Miksad, 1976; United States Weather Bureau, 1963). For a mercury barometer, the barometer cistern must be made airtight except for a lead to a special head exposed to the atmos-

phere and designed to ensure that the pressure inside is true static pressure. Aneroid and electronic barometers usually have simple connections to allow for the use of a static head, which should be located in an open environment not affected by the proximity of buildings. The design of such a head requires careful attention. Static pressure heads are commercially available, but there is no published literature on intercomparisons to demonstrate their performance.

3.8.2 The effects of air conditioning

Air conditioning may create a significant pressure differential between the inside and outside of a room. Therefore, if a barometer is to be installed in an air-conditioned room, it is advisable to use a static head with the barometer which will couple it to the air outside the building.

3.9 BAROMETER EXPOSURE

3.9.1 Exposure of mercury barometers

The general exposure requirements of mercury barometers have been outlined in the preceding sections. Mercury barometers have additional exposure requirements above those already mentioned. It is always preferable to hang the mercury barometer on an inside wall. For very accurate work, the best position would be in an unheated basement room with no windows and with a small electric fan to prevent any stratification of temperature.

In order to obtain uniform lighting conditions for reading the barometer, it is advisable to use artificial lighting for all observations. For this purpose, some sort of illuminator – which can provide a white and slightly luminous background for the mercury meniscus and, if necessary, for the fiducial point – may be provided. If no illuminator is used, care should be taken to provide the meniscus and the fiducial point with a light background, by such means as pieces of milk glass, white celluloid, or a sheet of white paper. Artificial light should also be provided for reading the barometer scale and the attached thermometer. Care should, however, be taken to guard against heating the barometer with artificial light during a barometer reading.

The barometer should be mounted in a place where it is not subject to vibration, preferably on a solid wall. The instrument must be mounted with the

mercury column in a vertical position. Errors due to departure from verticality are more critical for asymmetric barometers. Such barometers should be mounted with their longest axis vertical in order that a true setting of the mercury surface to the fiducial point remains correct even when the instruments are tilted from the vertical.

To protect the barometer from rough handling, dust and air currents, it is recommended that the instrument be placed in a box furnished with a hinged door with provisions for sufficient ventilation to prevent stratification of the air inside.

Great care should be taken when transporting a mercury barometer. The safest method is to carry the barometer upside down in a wooden case furnished with a sling. If the barometer cannot be accompanied by a responsible person, it ought to be transported in a suitable sprung crate with the cistern uppermost. The barometer should not be subject to violent movements and must always be turned over very slowly. Special precautions must be taken for some individual types of barometers before the instrument is turned over.

3.9.2 Exposure of electronic barometers

Electronic barometers require a clean, dry atmosphere that is free of corrosive substances. The barometer should also be kept at a constant temperature (see section 3.3.5.2). The instrument should be mounted in such a manner as to avoid mechanical shock and vibration. It should also be mounted away from electromagnetic sources, where this is not possible, the wires and casing should be shielded.

Barometers with digital read-outs should be mounted where there is good general lighting, but should not face a window or other strong light sources.

3.9.3 Exposure of aneroid barometers

The exposure requirements for aneroid barometers are similar to those for mercury barometers (see section 3.9.1) owing to the fact that such instruments may not be perfectly compensated for the effects of temperature. The place selected for mounting the device should preferably have a fairly uniform temperature throughout the day. Therefore, a location is required where the barometer is shielded from the direct rays of the sun and from other sources of either heat or cold, which can cause abrupt and marked changes in its temperature.

At land stations, it is an advantage to have the aneroid barometer installed in the vicinity of a mercury barometer for cross-checking and standardization purposes (see section 3.10).

3.9.4 Exposure of barographs

The barograph should be installed where it is protected from sudden changes in temperature and from vibration and dust. It should not be exposed to direct sunshine. The barograph should also be placed at a location where it is unlikely to be tampered with by unauthorized persons. Mounting the barograph on a sponge rubber cushion is a convenient means of reducing the effects of vibration. The site selected should be clean and dry. The air should also be relatively free of substances which would cause corrosion, fouling of the mechanism, and the like.

It is important to mount the instrument so that its face will be at a convenient height to be read at eye-level under normal operating conditions with a view to minimizing the effects of parallax. The exposure ought to be such that the barometer is uniformly illuminated, with artificial lighting being provided if necessary.

If a barograph has to be transported by air or transported at a high altitude, the pen arm should be disconnected and precautions should be taken to ensure that the mechanism is able to withstand the overload caused by exceeding the normal measuring range of the instrument.

3.10 COMPARISON, CALIBRATION AND MAINTENANCE

3.10.1 General requirements of a barometer comparison

In view of the importance of accurate pressure observations, especially for aeronautical and synoptic purposes, and of the various possible errors to which mercury barometers are subject, all station barometers should be checked regularly by an inspector. Some guidance is given in the following sections regarding the equipment to be used for checks, the frequency with which these should be carried out, and other related topics. Where precision aneroid barometers are used as station barometers, they should be checked frequently (at least once every week) against a mercury barometer, and a permanent record of all such checks should be kept on a suitable card or in a special log-book.

Alternatively, mercury barometers can be dispensed with if a daily comparison, both with a second aneroid barometer kept at the station and with analysed pressures in the vicinity, is undertaken. This should be supported by six monthly checks with a travelling standard.

The following symbols may be used to denote various categories of barometers in a National Meteorological Service:

- A: A primary or secondary standard barometer capable of independent determination of pressure to an uncertainty of at least 0.05 hPa;
- B: A working standard barometer of a design suitable for routine pressure comparisons and with known errors, which have been established by comparison with a primary or secondary standard;
- C: A reference standard barometer used for comparisons of travelling standard and station barometers at field supervising stations of a National Meteorological Service;
- S: A barometer (mercury, aneroid, electronic) located at an ordinary meteorological station;
- P: A mercury barometer of good quality and accuracy, which may be carried from one station to another and still retain calibration;
- N: A portable precision aneroid barometer of first quality;
- Q: A portable precision digital barometer of first quality, to be used as a travelling standard (Q stands for quality);
- M: A portable microbarograph of good quality and accuracy.

In order that barometer correction programmes be conducted on the same basis by all National Meteorological Services, it is desirable that uniform practices be followed in the quality of the equipment used, the frequency of comparisons, the procedures to be followed, the permissible changes in index correction, and the criteria for remedial action.

3.10.2 **Equipment used for barometer comparisons**

3.10.2.1 **Primary standard barometer**

There are different opinions regarding the best type of primary standard barometer. Two types are outlined in the following paragraphs.

One possible primary standard for atmospheric pressure consists of a precision dead weight tester that produces a calibrated pressure related to the precision weights used and the local gravity field. This type of barometer is relatively simple and does not suffer from the problem of excessive drift experienced by mercury barometers in a polluted environment.

The primary standard barometer may well be a high-quality mercury barometer specially designed for that purpose. The primary standard mercury barometer must have a high vacuum, contain very pure mercury with a well-known density maintained at a constant temperature, and be located in an environment where pollution effects are prevented. The barometer also needs a calibrated measure (scale) and an optical read-out facility. These types of barometers measure absolute pressure with high absolute accuracy, while dead weight testers are gauge pressure measuring instruments.

3.10.2.2 **Working standard barometer**

The working and reference standards, and the travelling standards used to compare barometers, should have high stability over long periods. These standards may be either mercury or electronic barometers. In the case of mercury barometers, they should have a tube with at least a 12 mm bore. It is also desirable that barometers be instruments in which the vacuum can be checked. They should be fully and carefully corrected for all known errors, which should have been established by two or more recent comparisons with barometers of a higher category.

3.10.2.3 **Travelling standard barometer**

A reliable travelling standard barometer must retain its index correction during transit to within 0.1 hPa. It should be standardized with reference to the working or reference standard before and after each tour. Once standardized, it should on no account be opened or adjusted in any fashion until after the final comparison at the station of origin of the tour. A travelling standard barometer needs to be carried in a high-quality, cushioned travelling case to protect it during transit.

Before the beginning of a tour, a mercury travelling standard should be examined carefully and checked to ensure that the mercury in the tube and cistern is clean, that there are no bubbles in the tube, and that the vacuum above the mercury in the tube is good. Every care should be taken in

handling, packing and transporting travelling standards so that there is the least possible cause for any change, however slight, in their index correction. Quick, jerky movements which might cause air bubbles from the tube cistern to rise in the tube should be avoided. Mercury travelling standards should be carried in a suitably cushioned leather or metal case, with the cistern end always higher than the tube.

3.10.2.4 Specifications of portable mercury barometers (P)

If a mercury barometer is to be used as a category P barometer, it must be designed so that the vacuum can be checked or so that a good degree of vacuum can be established at the top of the tube with a vacuum pump. A check valve for sealing the tube is essential. It should also have the property of high stability over long periods and have a tube with at least a 12 mm bore. Another desirable feature is a means of determining whether the quantity of mercury in the fixed cistern has remained constant since the original filling.

Also, a well-built Fortin-type barometer with a tube bore of at least 9 mm, but preferably 12 mm, can be used as a travelling standard. The degree of accuracy (as regards repeatability) considered necessary for a travelling standard is about 0.1 hPa. Category P barometers should be calibrated over a wide pressure and temperature range, covering all possible values likely to be encountered.

3.10.2.5 Specifications of portable electronic barometers (P)

Portable electronic barometers have now reached the level of development and reliability to allow them to be used as a category P barometer. The barometer must have a history of reliability with low drift corrections, as determined by several comparisons with a standard barometer both over a period of one year or more and over the maximum pressure range in which the barometer must be expected to operate.

Electronic barometers with multiple pressure transducers under independent microprocessor control are preferred. The temperature-compensation mechanism for the barometer must be proven to be accurate. The method for taking measurements from the pressure transducer must be contact-free and the barometer itself sufficiently robust to withstand the type of shock that may be encountered during transportation.

3.10.3 Barometer comparison

3.10.3.1 International barometer comparison

Great importance is attached to international barometer comparisons. The WMO Automatic Digital Barometer Intercomparison was carried out in De Bilt (Netherlands) from 1989 to 1991. Only by such comparisons is it possible to ensure consistency in the national standards of pressure-measuring instruments and thus prevent discontinuities in pressure data across international boundaries. The recommended procedure for such comparisons is given in section 3.10.4.

The programme of comparisons includes the following:

- (a) Comparison of national working standard B with primary or secondary standard barometer A, at least once every two years. If barometers A and B are located at the same centre, no travelling standards are required;
- (b) Comparison of reference standard C with national working standard B, at least once every two years by means of travelling standards;
- (c) Comparison of station barometer S with reference standard C, at least once every year, by means of travelling standards, or by comparison with the working standard B, every one to two years, depending upon the known characteristics of the barometers being used. It is a matter of policy whether the comparison occurs at the station or at a central calibration facility. In the latter case, travelling standards are not required.

It should be understood that the error of each barometer at the end of any link in a chain of comparison is determined with respect to the primary or secondary standard barometer A, so that the results of corrected barometric pressure readings are on an absolute basis at each stage.

3.10.3.2 Inspection of station barometers

For the inspection of station barometers, Fortin barometers with a tube bore of 9 mm are suitable; however, note section 3.2.7.3 on restrictions on the carriage of mercury instruments. Precision aneroid barometers and electronic barometers may also be used as travelling standards, provided that they have the necessary stability and accuracy. It is recommended that three or more such instruments be used at a time, so that any change in any one instrument can be detected

immediately. An aneroid barometer used for this purpose must not suffer from hysteresis effects. Furthermore, it should have a negligible temperature coefficient. These features can be obtained only by using special materials and designs. An essential feature of a suitable instrument is that the aneroid capsule should not be loaded by the indicating mechanism. Barometers with digital read-outs are very convenient as travelling standards, provided that their stability is good enough.

3.10.3.3 Procedure for the comparison of mercury barometers

The instructions given in previous sections should be generally followed. All normal precautions necessary while setting and reading barometers should be enforced with great care. Investigations show that readings averaging within 0.05 hPa can normally be achieved in a barometer comparison if adequate precautions are taken.

Comparative readings of the barometers should be entered in appropriate forms. A permanent record of all checks should be attached to the instrument and should include such information as the date of the check, the temperature and pressure at which the comparison was made, and the correction obtained.

Reports of barometer comparisons should be forwarded to the National Meteorological Service for evaluating errors, computing and issuing corrections, and determining the need for remedial action. Continuous records of the comparison data should be kept for each station barometer for a study of its performance over a period of years and for the detection of defects. Tabular and/or graphical records are useful visual tools for a barometer quality control programme.

3.10.3.4 Checking electronic barometers

At the current state of development, it is important to calibrate electronic barometers at intervals of about one year. It is standard procedure to calibrate an electronic barometer at a calibration facility immediately before its dispatch to a meteorological observation station. At the station, a number of comparison readings of pressure between the electronic barometer and the travelling standard should be taken over a period of several days. The readings should be taken with all barometers at the same height, when the wind speed is less than 12 m s^{-1} and when the pressure is either steady or changing by less than 1 hPa h^{-1} .

Any electronic barometer whose mean difference from the travelling standard exceeds 0.25 hPa should be regarded as unserviceable and returned to the calibration facility for recalibration.

If at all possible, it is advisable to install two independent electronic barometers at a meteorological observing station, with one barometer preferably having a history of low drift. This barometer is identified by the calibration facility staff from its calibration history and is identified as a low-drift barometer. With the arrival of each new barometer at a station, a set of comparison readings are taken, as described above, and the mean difference between the low-drift barometer and the new barometer is established. Once this is accomplished, daily readings from both barometers should be taken and a running sum of 25 differences calculated. If the new barometer and the low-drift barometer exhibit different rates of drift, the sums of the 25 differences will change. If a station has one mercury barometer and one electronic barometer, it would be normal for the mercury barometer to be the low-drift barometer. The low drift of the mercury barometer should still be verified by regular calibration checks.

These checks do not represent an inspection or a new calibration of the electronic barometer. Every National Meteorological Service should establish detailed inspection and calibration procedures for its electronic barometers, with the above method being used as a practical guide.

3.10.4 General procedure recommended for the comparison of barometers at different locations

The comparison of barometers is essential and should be undertaken in the following ways:

- (a) If barometer "1" is to be compared with barometer "2", a qualified person should carry three or more travelling standards, preferably of the P category, from barometer "1" to barometer "2", and then return to "1", thus closing the circuit. This procedure is applicable both between and within countries. Barometer "1" is usually at the central laboratory of a national standards organization or at the laboratory of a National Meteorological Service. Barometer "2" is at some other location. The carrying of category N and M standards is optional, and M may be omitted if microbarographs of good quality are installed at the two locations;
- (b) For standardization purposes, the travelling standards should be placed next to

the barometer to be compared and all the instruments given equal exposure for at least 24 h before official comparative readings are begun. An air current from an electric fan played on the instruments will aid in equalizing their temperature. The temperature of the room should be kept as uniform as practicable;

Note: The fan should be turned off before comparisons are made.

- (c) Comparative readings should not be taken if category M standards show the pressure to be fluctuating rapidly. Preference should be given to barometrically quiet periods (pressure steady or changing only slowly) for making the comparisons;
- (d) Comparative readings should be taken at uniform intervals of no less than 15 min in duration;
- (e) Experience indicates that at least five comparative readings are required for category S barometers at ordinary stations. At least 10 comparative barometer readings are required for barometers in categories A, B or C for standardization purposes;
- (f) If meteorological conditions permit, the comparative readings in the latter cases should be taken at different pressures covering both high and low pressures;
- (g) Records should include the attached thermometer observations, the readings of the travelling standards and barometers being compared, the wind speed, direction and gustiness, the corrections for gravity, temperature and instrumental error, the actual elevation above sea level of the zero point of the barometers, and the latitude, longitude, place name and date and time of observations;
- (h) The readings of category N barometers, if used, should include the readings of two or more precision aneroid barometers, corrected to a common reference, if standardization against instruments of category A or B shows them to differ in calibration. The correct readings of the aneroid barometers must be in agreement within tolerances appropriate to the instrument, otherwise the comparisons will be regarded as invalid;
- (i) With respect to comparisons using travelling standards, barometer "1" must be the highest class of standard barometer available at the point of departure. Barometer "1" should be of category A, B or B_r (see section 3.10.5.1), with category C being the lowest acceptable quality. Two sets of comparisons

of the travelling standards are necessary with barometer "1", at the following points in time:

- (i) Before the travelling standards are carried by hand from where barometer "1" is located to the place where barometer "2" is located;
 - (ii) After the return of the travelling standards to their point of origin, following transit to and from the location of barometer "2". The "before" and "after" comparisons should be checked against each other. If agreement with barometer "1" is within satisfactory tolerances for each of the instruments involved, it can be assumed that the comparisons between the travelling standards and barometer "2" are also within the required tolerances, provided that due care has been taken during all phases of the comparison process. However, if there is a significant disagreement or if a known mishap has occurred which might have affected the instruments, or if the validity of the comparison data is in question for any reason, the comparison exercise is deemed invalid and the whole process must be repeated;
 - (j) As far as practical, all discrepancies should finally be expressed with respect to a primary or secondary reading of a of category A barometer. This will ensure a common basis for all comparisons. In each case, the report of comparisons should indicate the standard used;
- Note: When a programme involving the elimination of residual barometric errors is adopted, there will be a homogeneous system of barometric observational data conforming to a single standard, which will permit the elimination of errors in horizontal pressure gradients from instrumental sources.
- (k) Comparisons are necessary both before and after the relocation of barometers at a laboratory or a station, or the cleaning of the mercury, to ensure early detection of the development of a defect.

3.10.5 Regional barometer comparison

3.10.5.1 Nomenclature and symbols

Symbols denoting barometer categories are as follows:

- A_r: A barometer of category A which has been selected by regional agreement as a reference standard for barometers of that Region;

B_r : A barometer of category B which the National Meteorological Services of the Region agree to use as the standard barometer for that Region, in the event that the category A barometer is unavailable in the Region.

Annex 3.B contains the list of regional standard barometers.

3.10.5.2 System of interregional comparison

The following measures must be considered when planning interregional comparisons:

- (a) Member countries in each Region will designate a primary or secondary standard barometer A to serve as A_r for the Region. If a primary or secondary barometer is not available within the Region, a category B barometer will be designated jointly as the regional standard barometer for that Region, with the barometer so chosen being denoted by the symbol B_r . Relative costs will determine whether a Region may deem it advantageous to designate more than one standard barometer;
- (b) A competent person carrying travelling standard barometers will travel from a central station equipped with a barometer of category A_r to a nearby Region equipped with a barometer of at least category B or B_r . A comparison of the barometers should then be performed in accordance with the method outlined in section 3.10.3. For the purposes of verification and intercomparison, it is sometimes desirable to repeat the process by comparing the B_r barometer with a barometer of category A_r from a different Region;
- (c) Copies of the comparison records should be transmitted to each of the central stations equipped with a category A barometer and to the station where the barometer B or B_r compared is located. Summaries of the comparison results should be forwarded to all National Meteorological Services in the Region where the barometer B or B_r is located.

3.10.5.3 System of international comparison within a Region

The following measures must be considered when planning international comparisons:

- (a) Each National Meteorological Service will compare its category B barometer with the category A barometer within the Region, if available, using the system outlined in

section 3.10.4. Where possible, preference should be given to the category A barometer for the Region as the standard instrument for the area;

- (b) When a category A barometer is not available in the Region, the category B barometers of the respective National Meteorological Service of the Region will be compared with the category B_r barometer for the Region, in accordance with section 3.10.4;
- (c) When a competent person is engaged in the execution of the programme to compare barometers of categories B with B_r , it is desirable that additional en route comparisons be made with barometers of categories B and C, while the person is travelling both to and from the station where the instrument B_r for the Region is located;
- (d) Copies of records and summaries of comparisons will be prepared and forwarded to interested agencies as outlined in paragraph 3.10.5.2 (c).

3.11 ADJUSTMENT OF BAROMETER READINGS TO OTHER LEVELS

In order to compare barometer readings taken at stations at different altitudes, it is necessary to reduce them to the same level. Various methods are in use for carrying out this reduction, but WMO has not yet recommended a particular method, except in the case of low-level stations.

The recommended method is described in WMO (1954; 1964; 1968). WMO (1966) contains a comprehensive set of formulae that may be used for calculations involving pressure.

3.11.1 Standard levels

The observed atmospheric pressure should be reduced to mean sea level (see Part I, Chapter 1) for all stations where this can be done with reasonable accuracy. Where this is not possible, a station should, by regional agreement, report either the geopotential of an agreed "constant pressure level" or the pressure reduced to an agreed datum for the station. The level chosen for each station should be reported to the WMO Secretariat for promulgation.

3.11.2 Low-level stations

At low-level stations (namely, those at a height of less than 50 m above mean sea level), pressure

readings should be reduced to mean sea level by adding to the station pressure a reduction constant C given by the following expression:

$$C = p \cdot H_p / 29.27 T_v$$

where p is the observed station pressure in hectopascals, H_p is the station elevation in metres, and T_v is the mean annual normal value of virtual temperature at the station in kelvins.

Note: The virtual temperature of damp air is the temperature at which dry air of the same pressure would have the same density as the damp air. WMO (1966) contains virtual temperature increments of saturated moist air for various pressures and temperatures.

This procedure should be employed only at stations of such low elevation that when the absolute extreme values of virtual temperature are substituted for T_v in the equation, the deviation of the result due to the other approximations of the equation (used for height rather than standard

geopotential, and with C to be small compared with P) is negligible in comparison.

3.12 PRESSURE TENDENCY AND PRESSURE TENDENCY CHARACTERISTIC

At surface synoptic observing stations, pressure tendency and the pressure tendency characteristic should be derived from pressure observations from the last 3 h (over 24 h in tropical regions). Typically, the pressure tendency characteristic can be expressed by the shape of the curve recorded by a barograph during the 3 h period preceding an observation (WMO, 2003). In the case of hourly observations, the amount and characteristic can be based on only four observations, and misinterpretations may result. Therefore, it is recommended that the characteristic should be determined on a higher frequency of observations, for example with 10 min intervals (WMO, 1985). Nine types of pressure tendency characteristics are defined (see WMO, 1992*b*, p. II-4-8).

ANNEX 3.A

CORRECTION OF BAROMETER READINGS TO STANDARD CONDITIONS

Correction for index error

The residual errors in the graduation of the scale of a barometer should be determined by comparison with a standard instrument. They may include errors due to inaccurate positioning or subdividing of the scale, capillarity and imperfect vacuum. Certificates of comparison with the standard should state the corrections to be applied for index error at no fewer than four points of the scale, for example, at every 50 hPa. In a good barometer, these corrections should not exceed a few tenths of a hectopascal.

Corrections for gravity

The reading of a mercury barometer at a given pressure and temperature depends upon the value of gravity, which in turn varies with latitude and altitude. Barometers for meteorological applications are calibrated to yield true pressure readings at the standard gravity of $9.806\ 65\ \text{m s}^{-2}$ and their readings at any other value of gravity must be corrected. The following method is recommended for reducing such barometer readings to standard gravity. Let B be the observed reading of the mercury barometer, B_t the barometer reading reduced to standard temperature but not to standard gravity, and corrected for instrumental errors, B_n be the barometer reading reduced to standard gravity and standard temperature, and corrected for instrumental errors, B_{ca} be the climatological average of B_t at the station, $g_{\phi H}$ the local acceleration of gravity (in m s^{-2}) at a station at latitude ϕ and elevation H above sea level, and g_n the standard acceleration of gravity, $9.806\ 65\ \text{m s}^{-2}$.

The following relations are appropriate:

$$B_n = B_t (g_{\phi H}/g_n) \quad (3.A.1)$$

or:

$$B_n = B_t + B_t [(g_{\phi H}/g_n) - 1] \quad (3.A.2)$$

The approximate equation 3.A.3 may be used, provided that the results obtained do not differ by more than 0.1 hPa from the results that would be obtained with the aid of equation 3.A.2:

$$B_n = B_t + B_{ca} [(g_{\phi H}/g_n) - 1] \quad (3.A.3)$$

The local acceleration of gravity $g_{\phi H}$ should be determined by the procedure outlined in the following section. The values so derived should be referred to as being on the International Gravity Standardization Net 1971 (IGSN71).

Determining local acceleration of gravity

In order to determine the local value of the acceleration of gravity at a station to a satisfactory degree of precision, one of two techniques should be used. These techniques involve, in the first case, the use of a gravimeter (an instrument for measuring the difference between the values of the acceleration of gravity at two points) and, in the second case, the use of the so-called Bouguer anomalies. Preference should be given to the gravimeter method. If neither of these methods can be applied, the local acceleration of gravity may be calculated using a simple model of the Earth.

Use of a gravimeter

Suppose g_1 represents the known local acceleration of gravity at a certain point O , usually a gravity base station established by a geodetic organization, where g_1 is on the IGSN71, and suppose further that g represents the unknown local acceleration of gravity on the meteorological gravity system at some other point X for which the value g is desired. Let Δg denote the difference in gravity acceleration at the two places, as observed by means of a gravimeter. That is, Δg is the value at point X minus the value at point O on a consistent system. Then, g is given by equation 3.A.4:

$$g = g_1 + \Delta g \quad (3.A.4)$$

Use of Bouguer anomalies

If a gravimeter is not available, interpolated Bouguer anomalies (A_B) may be used to obtain g at a given point. It is necessary that a contour chart of these anomalies be available from a geodetic organization or from a network of grav-

ity stations spaced at a density of at least one station per 10 000 km² (no more than a 100 km distance between stations) in the vicinity of the point.

Gravity networks of somewhat less density can be used as a basis provided that a geodetic organization considers that this method is expected to yield more reliable results than those that could be obtained by using a gravimeter.

The definition of the Bouguer anomaly (A_B) is derivable from equation 3.A.5:

$$g_s = (g_{\phi,0})_s - C \cdot H + A_B \quad (3.A.5)$$

where $(g_{\phi,0})_s$ is the theoretical value of the acceleration of gravity at latitude ϕ at sea level, as given by the formula actually used in computing the Bouguer anomaly. This formula expresses the value as a function of latitude in some systems. H is the elevation of the station (in metres) above sea level at which g_s is measured, g_s is the observed value of the acceleration of gravity (in m s⁻²); A_B is the Bouguer anomaly (in m s⁻²); and C is the elevation correction factor used in computing the Bouguer anomaly (for example, using a crustal specific gravity of 2.67, this factor is 0.000 001 968 m s⁻²).

When g is desired for a given station and has not been measured, the value of g_s should be computed by means of equation 3.A.5, provided that the appropriate value of A_B for the locality of the station can be interpolated from the aforementioned contour charts or from data representing the Bouguer anomalies supplied by a suitable network of gravity stations, as defined.

Calculating local acceleration of gravity

If neither of the preceding methods can be applied, the local value may be calculated less accurately according to a simple model. According to the Geodetic Reference System 1980, the theoretical value ($g_{\phi,0}$) of the acceleration of gravity at mean sea level at geographic latitude, ϕ , is computed by means of equation 3.A.6:

$$g_{\phi,0} = 9.806\ 20 (1 - 0.002\ 644\ 2 \cos 2\phi + 0.000\ 005\ 8 \cos^2 2\phi) \quad (3.A.6)$$

The local value of the acceleration of gravity at a given point on the surface of the ground at a land station is computed by means of equation 3.A.7:

$$g = g_{\phi,0} - 0.000\ 003\ 086\ H + 0.000\ 001\ 118\ (H - H') \quad (3.A.7)$$

where g is the calculated local value of the acceleration of gravity, in m s⁻², at a given point; $g_{\phi,0}$ is the theoretical value of the acceleration of gravity in m s⁻² at mean sea level at geographic latitude ϕ , computed according to equation 3.A.6 above; H is the actual elevation of the given point, in metres above mean sea level; and H' is the absolute value in metres of the difference between the height of the given point and the mean height of the actual surface of the terrain included within a circle whose radius is about 150 km, centred at the given point.

The local value of the acceleration of gravity at a given point within height H above mean sea level of not more than about 10 km, and where that point lies over the sea water surface, is computed by means of equation 3.A.8:

$$g = g_{\phi,0} - 0.000\ 003\ 086\ H - 0.000\ 006\ 88\ (D - D') \quad (3.A.8)$$

where D is the depth of water in metres below the given point; and D' is the mean depth of water, in metres, included within a circle whose radius is about 150 km centred at the given point.

At stations or points on or near the coast, the local value of acceleration of gravity should be calculated, so far as practicable, through the use of equations 3.A.7 and 3.A.8 on a pro rata basis, weighting the last term of equation 3.A.7 according to the relative area of land included within the specified circle, and weighting the last term of equation 3.A.8 according to the relative area of the sea included within the circle. The values thus obtained are then combined algebraically to obtain a correction which is applied to the final term in the right-hand side of both equations, as shown in equation 3.A.9:

$$g = g_{\phi,0} - 0.000\ 003\ 086\ H + 0.000\ 001\ 118\ \alpha (H - H') - 0.000\ 006\ 88\ (1 - \alpha) (D - D') \quad (3.A.9)$$

where α is the fraction of land area in the specified area, and H' and D' refer to the actual land and water areas, respectively.

Corrections for temperature

Barometer readings must be corrected to the values that would have been obtained if the mercury and the scale had been at their standard temperatures. The standard temperature for mercury barometers is 0°C. With reference to scales, some barometers have scales which read accurately at this same temperature, but some read accurately at 20°C.

The temperature correction necessary for adjustable cistern barometers (Fortin-type barometers) is different from that required for fixed-cistern barometers, though the principle reasons leading to the necessity for temperature corrections are the same for both types, namely, the fact that the coefficient of cubic thermal expansion of mercury is different from the coefficient of linear thermal expansion of the scale. Thus, a certain correction term is required for both types of mercury barometer.

A fixed-cistern barometer requires an additional correction. The reason for this is that an increase in temperature of the instrument causes an increase both in the volume of the mercury and in the cross-sectional areas of the (iron) cistern and the (glass) tube. Owing to these area changes, the apparent

rise of the mercury resulting from a temperature increase is less than would be the case if the areas remained constant. This is because some of the mercury from the barometer goes to occupy the capacity increment produced by the expansion of the cistern and tube.

The scale of a fixed-cistern barometer must, for a variety of reasons, undergo a calibration check against a primary standard barometer of the adjustable-cistern type. Some manufacturers decrease the volume of mercury by such an amount that the readings of the test barometer agree with the readings of the standard barometer at 20°C. Correction tables can be generated for fixed-cistern barometers using the readings from a primary standard barometer whose scales are accurate when 20°C is used as the reference temperature.

Temperature corrections for mercury barometers

Researchers have conducted exhaustive studies for temperature corrections for mercury barometers, the results of which are summarized below:

- | | | |
|----|---|---|
| 1. | (a) Scale correct at 0°C and additionally | $C_t = -B(\alpha - \beta) \cdot t$ |
| | (b) Hg volume correct at 0°C | $C_{t,V} = -B(\alpha - \beta) \cdot t - (\alpha - 3\eta) \cdot 4V/3A$ |
| 2. | Scale correct at 0°C and | |
| | Hg volume correct at 20°C | $C_{t,V} = -B(\alpha - \beta) \cdot t - (\alpha - 3\eta) \cdot (t - 20) \cdot 4V/3A$ |
| 3. | (a) Scale correct at 20°C | $C_t = -B[\alpha \cdot t - \beta \cdot (t - 20)]$ |
| | (b) Hg volume correct at 0°C | $C_{t,V} = -B \cdot t - \beta \cdot (t - 20) - (\alpha - 3\eta) \cdot t \cdot (4V/3A)$ |
| | (c) Hg volume decreasing by an amount
equivalent to 0.36 hPa | $C_{t,V} = -B(\alpha - \beta) \cdot t - (\alpha - 3\eta) \cdot t \cdot (4V/3A)$ |
| 4. | Scale correct at 20°C and | |
| | (a) Hg volume correct at 20°C | $C_{t,V} = -B \cdot t - \beta \cdot (t - 20) - (\alpha - 3\eta) \cdot (t - 20) \cdot (4V/3A)$ |
| | (b) Hg volume decreasing by an amount
equivalent to 0.36 hPa | $C_{t,V} = -B(\alpha - \beta) \cdot t - (\alpha - 3\eta) \cdot (t - 20) \cdot (4V/3A)$ |

where:

- C_t = temperature correction;
 $C_{t,V}$ = additional correction for fixed-cistern barometers;
 B = observed barometer reading;
 V = total volume of mercury in the fixed-cistern barometer;
 A = effective cross-sectional area of the cistern;
 t = temperature;
 α = cubic thermal expansion of mercury;
 β = coefficient of linear thermal expansion of the scale;
 η = coefficient of linear thermal expansion of the cistern.

ANNEX 3.B

REGIONAL STANDARD BAROMETERS

<i>WMO Region</i>	<i>Location</i>	<i>Category^a</i>
I	Cairo, Egypt	A _r
	Casablanca, Morocco	A _r
	Dakar, Senegal	A _r
	Douala, Cameroon	A _r
	Kinshasa/Binza, Democratic Republic of the Congo	A _r
	Nairobi, Kenya	A _r
	Oran, Algeria	A _r
II	Calcutta, India	B _r
III	Buenos Aires, Argentina	B _r
	Maracay, Venezuela	B _r
	Rio de Janeiro, Brazil	A _r
IV	Miami, Florida, United States (subregional)	A _r
	San Juan, Puerto Rico (subregional)	A _r
	Toronto, Canada (subregional)	A _r
	Washington DC (Gaithersburg, Maryland), United States	A _r
V	Melbourne, Australia	A _r
VI	London, United Kingdom	A _r
	St Petersburg, Russian Federation	A _r
	Trappes, France	A _r
	Hamburg, Germany	A _r

^a For category definitions, see section 3.10.5.1.

REFERENCES AND FURTHER READING

- Liu, H. and G. Darkow, 1989: Wind effect on measured atmospheric pressure. *Journal of Atmospheric and Oceanic Technology*, Volume 6, Issue 1, pp. 5-12.
- Miksad, R., 1976: An omni-directional static pressure probe. *Journal of Applied Meteorology*, Volume 15, pp. 1215-1225.
- Sax, N.I. 1975: *Dangerous Properties of Industrial Materials*. Fourth edition, Van Nostrand Reinhold Co., New York.
- United States Weather Bureau, 1963: *Manual of Barometry* (WBAN). Volume 1, first edition, US Government Printing Office, Washington DC.
- World Meteorological Organization, 1954: *Reduction of Atmospheric Pressure: Preliminary Report on Problems Involved*. WMO Technical Note No. 7, WMO-No. 36.TP.12, Geneva.
- World Meteorological Organization, 1964: *Note on the Standardization of Pressure Reduction Methods in the International Network of Synoptic Stations*. WMO Technical Note No. 61, WMO-No. 154.TP.74, Geneva.
- World Meteorological Organization, 1966: *International Meteorological Tables* (S. Letestu, ed.). WMO-No. 188, Geneva.
- World Meteorological Organization, 1968: *Methods in Use for the Reduction of Atmospheric Pressure*. WMO Technical Note No. 91, WMO-No. 226.TP.120, Geneva.
- World Meteorological Organization, 1985: Pressure tendency and discontinuity in wind (L. Bergman, T. Hovberg and H. Wibeck). *Papers Presented at the Third WMO Technical Conference on Instruments and Methods of Observation (TECIMO-III)*, Instruments and Observing Methods Report No. 22, WMO/TD-No. 50, Geneva.
- World Meteorological Organization, 1990: *Guide on Meteorological Observation and Information Distribution Systems at Aerodromes*. WMO-No. 731, Geneva.
- World Meteorological Organization, 1992a: *The WMO Automatic Digital Barometer Intercomparison* (J.P. van der Meulen). Instruments and Observing Methods Report No. 46, WMO/TD-No. 474, Geneva.
- World Meteorological Organization, 1992b: *Manual on the Global Data-processing and Forecasting System*. WMO-No. 485, Geneva.
- World Meteorological Organization, 2003: *Manual on the Global Observing System*. WMO-No. 544, Geneva.
-

CHAPTER 4

MEASUREMENT OF HUMIDITY

4.1 GENERAL

The measurement of atmospheric humidity, and often its continuous recording, is an important requirement in most areas of meteorological activity. This chapter deals with the measurement of humidity at or near the Earth's surface. There are many different methods in use, and there is extensive literature on the subject. An old but still useful wide-ranging account of the techniques is given in Wexler (1965).

4.1.1 Definitions

The definitions of the terms used in this chapter follow those given in the WMO *Technical Regulations* (WMO 1988, Appendix B), the text of which is reproduced in Annex 4.A.

The simple definitions of the most frequently used quantities in humidity measurements are as follows:

Mixing ratio r : The ratio between the mass of water vapour and the mass of dry air;

Specific humidity q : The ratio between the mass of water vapour and the mass of moist air;

Dewpoint temperature T_d : The temperature at which moist air saturated with respect to water at a given pressure has a saturation mixing ratio equal to the given mixing ratio;

Relative humidity U : The ratio in per cent of the observed vapour pressure to the saturation vapour pressure with respect to water at the same temperature and pressure;

Vapour pressure e' : The partial pressure of water vapour in air;

Saturation vapour pressures e'_w and e'_i : Vapour pressures in air in equilibrium with the surface of water and ice, respectively.

Annex 4.B provides the formulae for the computation of various measures of humidity. These versions of the formulae and coefficients were adopted by WMO in 1990.¹ They are convenient for computation and sufficiently accurate for all normal meteorological applications (WMO, 1989a).

More accurate and detailed formulations of these and other quantities may be found in Sonntag (1990; 1994). Other detailed formulations² are presented in WMO (1966, introductions to tables 4.8–10) and WMO (1988, Appendix A).³

4.1.2 Units and scales

The following units and symbols are normally used for expressing the most commonly used quantities associated with water vapour in the atmosphere:

- Mixing ratio r and specific humidity q (in kg kg^{-1});
- Vapour pressure in air e' , e'_w , e'_i and pressure p (in hPa);
- Temperature T , wet-bulb temperature T_w , dewpoint temperature T_d , and frost-point temperature T_f (in K);
- Temperature t , wet-bulb temperature t_w , dewpoint temperature t_d , and frost-point temperature t_f (in $^{\circ}\text{C}$);
- Relative humidity U (in per cent).

4.1.3 Meteorological requirements

Humidity measurements at the Earth's surface are required for meteorological analysis and forecasting, for climate studies, and for many special applications in hydrology, agriculture, aeronautical services and environmental studies, in general. They are particularly important because of their relevance to the changes of state of water in the atmosphere.

General requirements for the range, resolution and accuracy of humidity measurements are given in Part I, Chapter 1, and in Table 4.1 below. The achievable accuracies listed in the table refer to good quality instruments that are well operated and maintained. In practice, these are not easy to achieve. In particular, the psychrometer in a thermometer shelter without forced ventilation, still in widespread use, may have significantly lower performance.

1 Adopted by the Executive Council at its forty-second session of through Resolution 6 (EC-XLII).

2 Adopted by the Fourth Congress through Resolution 19 (Cg-IV).

3 The corrigendum to WMO (1988), issued in 2000, contains a typing error; the correct formulation is given in WMO (1966).

Table 4.1. Summary of performance requirements for surface humidity

<i>Requirement</i>	<i>Wet-bulb temperature</i>	<i>Relative humidity</i>	<i>Dewpoint temperature</i>
Range	–10 to 35°C	5 to 100%	At least 50 K in the range –60 to 35°C
Target accuracy ^a (uncertainty)	0.1 K high RH 0.2 K mid RH	1% high RH 5% mid RH	0.1 K high RH 0.5 K mid RH
Achievable observing uncertainty ^b	0.2 K	3 to 5% ^c	0.5 K ^c
Reporting code resolution	0.1 K	1%	0.1 K
Sensor time-constant ^d	20 s	40 s	20 s
Output averaging time ^e	60 s	60 s	60 s

^a Accuracy is the given uncertainty stated as two standard deviations.

^b At mid-range relative humidity for well-designed and well-operated instruments; difficult to achieve in practice.

^c If measured directly.

^d For climatological use, a time-constant of 60 s is required (for 63 per cent of a step change).

^e For climatological use, an averaging time of 3 min is required.

For most purposes, time-constants of the order of 1 min are appropriate for humidity measurements. The response times readily available with operational instruments are discussed in section 4.1.4.9.

4.1.4 Measurement methods

A general review of the state of the art in the field of hygrometry is given by Sonntag (1994).

4.1.4.1 Hygrometers

Any instrument for measuring humidity is known as a hygrometer. The physical principles most widely employed for hygrometry are given in sections 4.1.4.4 to 4.1.4.8. More information on the different methods is found in Wexler (1965). The report of a WMO international comparison of various hygrometers is given in WMO (1989*b*).

4.1.4.2 Exposure: general comments

The general requirements for the exposure of humidity sensors are similar to those for temperature sensors, and a suitably positioned thermometer screen may be used for that purpose. Particular requirements include:

- (a) Protection from direct solar radiation, atmospheric contaminants, rain and wind;
- (b) Avoidance of the creation of a local microclimate within the sensor housing structure or sampling device. Note that wood and many synthetic materials will adsorb or desorb water vapour according to the atmospheric humidity.

Exposures appropriate to particular instruments are described in sections 4.2 to 4.7.

4.1.4.3 Sources of error: general comments

Errors in the measurement of humidity may be caused by the following:

- (a) Modification of the air sample, for example, by heat or water-vapour source or sink;
- (b) Contamination of the sensor, for example, by dirt, sea spray;
- (c) Calibration error, including pressure correction, temperature coefficient of sensor, and electrical interface;
- (d) Inappropriate treatment of water/ice phase;
- (e) Poor instrument design, for example, stem heat conduction in the wet-bulb thermometer;
- (f) Incorrect operation, for example, failure to achieve stable equilibrium;
- (g) Inappropriate sampling and/or averaging intervals.

The time-constant of the sensor, the time-averaging of the output and the data requirement should be consistent.

The different types of humidity sensors vary in their susceptibility to, and the significance of, each of the above; further discussion will be found in the appropriate sections of this chapter.

4.1.4.4 Gravimetric hygrometry

This method uses the absorption of water vapour by a desiccant from a known volume of air (gravimetric hygrometer; used for primary standards only). Some details are given in section 4.9.

The gravimetric method yields an absolute measure of the water-vapour content of an air sample in terms of its humidity mixing ratio. This is obtained by first removing the water vapour from the sample. The mass of the water vapour is determined by weighing the drying agent before and after absorbing the vapour. The mass of the dry sample is determined either by weighing or by measuring its volume.

The method is restricted to providing an absolute calibration reference standard, and such apparatus is found mostly in national calibration standards laboratories.

4.1.4.5 Condensation methods

4.1.4.5.1 Chilled-mirror method (dewpoint or frost-point hygrometer)

When moist air at temperature T , pressure p and mixing ratio r_w (or r_i) is cooled, it eventually reaches its saturation point with respect to water (or to ice at lower temperatures) and a deposit of dew (or frost) can be detected on a solid non-hygroscopic surface. The temperature of this saturation point is the dewpoint temperature T_d (or the frost-point T_f).

The chilled-mirror hygrometer are used to measure T_d or T_f . The most widely used systems employ a small polished-metal reflecting surface, cooled electrically by using a Peltier-effect device, and sense condensation with an optical detector.

Instruments using condensation method are used for observational purposes and might also be used as working standards and/or reference standards (see section 4.4).

4.1.4.5.2 Heated salt-solution method (vapour equilibrium hygrometer, known as the dew cell)

The equilibrium vapour pressure at the surface of a saturated salt solution is less than that for a similar surface of pure water at the same temperature. This effect is exhibited by all salt solutions but particularly by lithium chloride, which has an exceptionally low equilibrium vapour pressure.

An aqueous salt solution (whose equilibrium vapour pressure is below the ambient vapour pressure) may be heated until a temperature is reached at which its equilibrium vapour pressure exceeds the ambient vapour pressure. At this point, the balance will shift from condensation to evaporation and eventually there will be a phase transition from the liquid solution to a solid hydrate (crystalline) form. The transition point may be detected through a characteristic decrease in the electrical conductivity of the solution as it crystallizes. The temperature of the solution at which the ambient vapour pressure is reached provides a measure of the ambient vapour pressure. For this purpose, a thermometer is placed in good thermal contact with the solution. The ambient dewpoint (namely, with respect to a plane

surface of pure water) may be determined by using empirical data relating vapour pressure to temperature for pure water and for salt solutions. The most frequently used salt solution for this type of sensor is lithium chloride.

This method is used for observational purposes, especially for automatic weather stations (see section 4.5).

4.1.4.6 The psychrometric method

A psychrometer consists essentially of two thermometers exposed side by side, with the surface of the sensing element of one being covered by a thin film of water or ice and termed the wet or ice bulb, as appropriate. The sensing element of the second thermometer is simply exposed to the air and is termed the dry bulb. This is the most widely used method and is described in detail in section 4.2.

Owing to evaporation of water from the wet bulb, the temperature measured by the wet-bulb thermometer is generally lower than that measured by the dry bulb. The difference in the temperatures measured by the pair of thermometers is a measure of the humidity of the air; the lower the ambient humidity, the greater the rate of evaporation and, consequently, the greater the depression of the wet-bulb temperature below the dry-bulb temperature. The size of the wet-bulb depression is related to the ambient humidity by a psychrometer formula.

This method is in widespread use for observational purposes. Instruments using the psychrometric method are also commonly used as working standards.

4.1.4.7 Sorption methods

Certain materials interact with water vapour and undergo a change in a chemical or physical property that is sufficiently reversible for use as a sensor of ambient humidity. Water vapour may be adsorbed or absorbed by the material, adsorption being the taking up of one substance at the surface of another and absorption being the penetration of a substance into the body of another. A hygroscopic substance is one that characteristically absorbs water vapour from the surrounding atmosphere, by virtue of having a saturation vapour pressure that is lower than that of the surrounding atmosphere. For absorption to take place, a necessary condition requires that the ambient vapour pressure of the atmosphere exceeds the saturation vapour pressure of the substance. The following are two properties of sorption:

- (a) Changes in the dimensions of hygroscopic materials: Certain materials vary dimensionally with humidity. Natural fibres tend to exhibit the greatest proportional change and, when coupled to a mechanical lever system, can be incorporated into an analogue linear displacement transducer. Such a transducer may be designed to move a pointer over a scale to provide a visual display, or be an electromechanical device which provides an electrical output.

Human hair is the most widely used material for this type of humidity sensor. Synthetic fibres may be used in place of human hair. Because of the very long lag time for synthetic fibres, such sensors should never be used below 10°C. The hair hygrometer is described in section 4.3.

Goldbeater's skin (an organic membrane obtained from the gut of domestic animals) has properties similar to those of human hair and has been used for humidity measurements, though most commonly in devices for taking upper-air measurement.

- (b) Changes in electrical properties of hygroscopic materials: Certain hygroscopic materials exhibit changes in their electrical properties in response to a change in the ambient relative humidity with only a small temperature dependence. Commonly used methods making use of these properties are described in section 4.6.

Electrical relative humidity sensors are increasingly used for remote-reading applications, particularly where a direct display of relative humidity is required.

Properties commonly exploited in the measurement of relative humidity include sensors made from chemically treated plastic material having an electrically conductive surface layer (electrical resistance) and sensors based upon the variation of the dielectric properties of a solid, hygroscopic material in relation to the ambient relative humidity (electrical capacitance).

4.1.4.8 Absorption of electromagnetic radiation by water vapour (ultraviolet and infrared absorption hygrometers)

The water molecule absorbs electromagnetic radiation in a range of wavebands and discrete wavelengths; this property can be exploited to obtain a measure of the molecular concentration of water vapour in a gas. The most useful regions of the electromagnetic spectrum for this purpose lie in the ultraviolet and infrared regions, and the principle of the method is to determine the attenuation of radiation in a waveband that is

specific to water-vapour absorption, along the path between a source of the radiation and a receiving device. There are two principal methods for determining the degree of attenuation of the radiation, namely:

- (a) The transmission of narrow band radiation at a fixed intensity to a calibrated receiver;
- (b) The transmission of radiation at two wavelengths, one of which is strongly absorbed by water vapour and the other is either not absorbed or only very weakly absorbed.

Both types of instruments require frequent calibration and are more suitable for measuring changes in vapour concentration rather than absolute levels. Their use remains restricted to research activities; a brief account of these instruments is given in section 4.7.

4.1.4.9 Time-constants of humidity sensors

The specification of the time-constant for a humidity sensor implies that the response of the sensor to a step change in humidity is consistent with a known function. In general usage, the term refers to the time taken for the sensor to indicate 63.2 per cent ($1/e$) of a step change in the measurand (in this case humidity), and assumes that the sensor has a first-order response to changes in the measurand (namely, the rate of change of the measurement is proportional to the difference between the measurement and the measurand). It is then possible to predict that 99.3 per cent of the change will take place after a period of five time-constants in duration.

Table 4.2 gives $1/e$ time-constant values typical for various types of humidity sensor.

4.1.4.10 Maintenance: general comments

The following maintenance procedures should be considered:

- (a) Cleanliness: Sensors and housings should be kept clean. Some sensors, for example, chilled-mirror and hair hygrometers, may be cleaned with distilled water and this should be carried out regularly. Others, notably those having some form of electrolyte coating, but also some with a polymeric substrate, may on no account be treated in this way. The provision of clear instructions for observers and maintenance staff is vital;
- (b) Checking and calibration of field instruments: Regular calibration is required for all humidity sensors in the field. For chilled-mirror psychrometers and heated

Table 4.2. Time-constants for humidity sensors

85 per cent relative humidity Sensor type	1/e time-constant (s)		
	20°C	0°C	-20°C
Ordinary human hair	32	75	440
Rolled hair	10	10	12
Goldbeater's skin	10	16	140
Electrical capacitance	1-10	1-10	1-10
Electrical resistance	1-10	—	—
Assmann psychrometer	} 30-50	} 30-50	} 30-50
Condensation hygrometers			
Electrolytic hygrometers			
Optical hygrometer	< 0.01	< 0.01	< 0.01

Note: The first-order relation does not hold particularly well for sorption sensors since the forcing agent for vapour equilibrium, the local gradient of vapour pressure, is dependent upon the local migration of water vapour molecules within the body of a solid humidity element. In general, a first-order response will be most closely exhibited by those sensors having a thin active element.

“dewpoint” hygrometers, which use a temperature detector, the calibration of the detector can be checked whenever the regular maintenance routine is performed. A comparison with a working reference hygrometer, such as an Assmann psychrometer, should also be performed at least once a month.

Saturated salt solutions have applications with sensors that require only a small sample volume. A very stable ambient temperature is required and it is difficult to be confident about their use in the field.

The use of a standard type of aspirated psychrometer, such as the Assmann, as a field reference has the advantage that its own integrity can be verified by comparing the dry- and wet-bulb thermometers, and that adequate aspiration may be expected from a healthy sounding fan. The reference instrument should itself be calibrated at intervals that are appropriate to its type.

It is important to check the calibration of electrical interfaces regularly and throughout their operational range. A simulator may be used in place of the sensor for this purpose. However, it will still be necessary to calibrate the ensemble at selected points, since the combination of calibration errors

for sensor and interface which are individually within specification may be outside the specification for the ensemble.

Detailed maintenance requirements specific to each class of hygrometer described in this chapter are included in the appropriate section.

4.1.4.11 Protective filters

A protective filter is commonly used to protect a humidity sensor from contaminants that may adversely affect its performance. Where a sensor is not artificially aspirated, the use of a filter tends to slow the response rate of the sensor by preventing the bulk movement of air and by relying upon molecular diffusion through the filter material. Although the diffusion of water vapour through some materials, such as some cellulose products, is theoretically more rapid than for still air, porous hydrophobic membranes achieve better diffusion rates in practice. The pore size should be sufficiently small to trap harmful aerosol particles (in a maritime environment sea-salt particles may be present in significant quantity down to a diameter of $0.1 \mu\text{m}$) and the porosity should be sufficient to allow an adequate diffusion rate.

The size of the filter, as well as its porosity, affects the overall diffusion rate. Diffusion will be enhanced by aspiration, but it must be remembered that this technique relies upon maintaining low air pressure on the sensing side of the filter, and that this can have a significant effect on the measurement.

Non-aspirated sensors should, in general, be protected using a hydrophobic, inert material. High-porosity polymer membranes made from an expanded form of polytetrafluoroethylene have been used successfully for this purpose in a variety of situations and are fairly robust.

Sintered metal filters may be used, but they should be heated to avoid problems with condensation within the material. This is not normally appropriate for a relative humidity sensor, but is quite acceptable for a dewpoint sensor. Sintered metal filters are robust and well suited for aspirated applications, which allow the use of a filter having a large surface area and, consequently, an acceptably small pressure differential.

Where diffusion is not enhanced by artificial aspiration, the relation of the surface area of the filter to the volume of the air being sampled by the sensor

must be considered. In the case of a typical sorption sensor composed of a flat substrate, a flat membrane positioned close to the sensor surface will provide the optimum configuration. In the case of a cylindrical sensing surface, a cylindrical filter is appropriate.

4.2 THE PSYCHROMETER

4.2.1 General considerations

4.2.1.1 Psychrometric formulae and tables

The following paragraphs summarize the existing practice in drawing up psychrometric tables.

The usual practice is to derive the vapour pressure e' under the conditions of observation from the following semi-empirical psychrometric formulae:

$$e' = e'_w(p, T_w) - Ap(T - T_w) \quad (4.1)$$

and:

$$e' = e'_i(p, T_i) - Ap(T - T_i) \quad (4.2)$$

where e'_w is the saturation vapour pressure with respect to water at temperature T_w and pressure p of the wet bulb; e'_i is the saturation vapour pressure with respect to ice at temperature T_i and pressure p of the ice bulb; p is the pressure of the air; T the temperature of the dry bulb; and A is the psychrometer coefficient. (The latter is preferred to the term "psychrometer constant", which is a misnomer.)

The wet-bulb thermometer temperature T_w for most instruments is not identical to the thermodynamic wet-bulb temperature, defined in Annex 4.A, which depends only upon p , T and r (the humidity mixing ratio). The temperature measured by a practical wet-bulb thermometer depends also upon a number of variables that are influenced by the dynamics of heat transfer across a liquid/gas interface (in which the gas must be characterized in terms of its component laminar and turbulent layers). The description of a satisfactory thermodynamic model is beyond the scope of this publication. The inequality of the thermodynamic and measured wet-bulb temperatures is resolved in practice through the empirical determination of the psychrometer coefficient A (see section 4.2.6).

In general, the coefficient A depends upon the design of the psychrometer (in particular the wet-bulb system), the rate of air-flow past the wet bulb

(termed the ventilation rate), and the air temperature and its humidity. At low rates of ventilation, A depends markedly upon the ventilation rate. However, at ventilation rates of 3 to 5 m s⁻¹ (for thermometers of conventional dimensions) or higher, the value of A becomes substantially independent of the ventilation rate and is practically the same for well-designed psychrometers. The value of A does not, then, depend very much on temperature or humidity and its dependence on these variables is usually considered unimportant. A is smaller when the wet bulb is coated with ice than when it is covered with water.

The formulae and coefficients appropriate for the various forms of psychrometer are discussed in the following sections.

4.2.1.2 The specification of a psychrometer

The equipment used for psychrometric observations should, as far as practicable, conform with the following recommendations (see sections 4.2.3 and 4.2.6):

- (a) At sea level, and in the case where the thermometers are of the types ordinarily used at meteorological stations, air should be drawn past the thermometer bulbs at a rate of no less than 2.2 m s⁻¹ and no greater than 10 m s⁻¹. For appreciably different altitudes, these air speed limits should be adjusted in inverse proportion to the density of the atmosphere;
- (b) The wet and dry bulbs must be protected from radiation, preferably by a minimum of two shields. In a psychrometer with forced ventilation, such as the Assmann, the shields may be of polished, unpainted metal, separated from the rest of the apparatus by insulating material. Thermally insulating material is preferable in principle and must be used in psychrometers which rely on natural ventilation;
- (c) If the psychrometer is exposed in a louvred screen with forced ventilation, separate ventilation ducts should be provided for the two thermometers. The entrance to the ducts should be located so as to yield a measurement of the true ambient temperature, and the air should be exhausted above the screen in such a way as to prevent recirculation;
- (d) The greatest care should be taken to prevent the transfer of significant amounts of heat from an aspirating motor to the thermometers;
- (e) The water reservoir and wick should be arranged in such a way that the water will

reach the bulb with sensibly the wet-bulb temperature, so as not to affect the temperature of the dry bulb.

4.2.1.3 The wet-bulb sleeve

The wet bulb usually has a cotton wick, or similar fabric, fitting closely around the sensing element in order to maintain an even covering of water, which is either applied directly or by some form of capillary feed from a reservoir. The wick commonly takes the form of a sleeve that has a good fit around the bulb and extends at least 2 cm up the stem of the thermometer.

The fabric used to cover the wet bulb should be thin but closely woven. Before installation, it should be washed thoroughly in an aqueous solution of sodium bicarbonate (NaHCO_3), at a dilution of 5 g per litre, and rinsed several times in distilled water. Alternatively, a solution of pure detergent in water may be used. If a wick is to be employed, it should be similarly treated.

Any visible contamination of the wick or the wet-bulb sleeve should be considered an absolute indication of the necessity for its replacement. Great care should be exercised in handling the sleeve and wick to prevent contamination from hands. Distilled water should be used for the wet bulb.

The proper management of the wet bulb is particularly important. Observers should be encouraged to change the wet-bulb sleeve and wick regularly. These should be replaced at least once a week for all psychrometers that are continuously exposed. At places near the sea and in dusty or industrialized districts it may be necessary to replace these items more frequently. The water supply should be checked frequently and replaced or replenished as required.

Under hot, dry conditions, it can be an advantage to wet the covering with water from a porous vessel. This will cause the water to be pre-cooled by evaporation from the porous surface. The vessel should be kept in the shade, but not in the immediate vicinity of the psychrometer.

4.2.1.4 Operation of the wet bulb below freezing

The psychrometer is difficult to operate at temperatures below freezing, but it is used in climates where such temperatures occur. A wick cannot be used to convey water from a reservoir to the wet-bulb sleeve by capillary action when the wet-bulb temperature is below 0°C . Under these conditions, care should

be taken to form only a thin layer of ice on the sleeve. It is an absolute necessity that the thermometers be artificially ventilated; if they are not, the management of the wet bulb will be extremely difficult.

The water should, as far as possible, have a temperature close to freezing point. If a button of ice forms at the lowest part of the bulb, it should be immersed in water long enough to melt the ice.

The time required for the wet bulb to reach a steady reading after the sleeve is wetted depends on the ventilation rate and the actual wet-bulb temperature. An unventilated thermometer usually requires from 15 to 45 min, while an aspirated thermometer will require a much shorter period. It is essential that the formation of a new ice film on the bulb be made at an appropriate time. If hourly observations are being made with a simple psychrometer, it will usually be preferable to form a new coating of ice just after each observation. If the observations are made at longer intervals, the observer should visit the screen sufficiently in advance of each observation to form a new ice film on the bulb. The wet bulb of the aspirated and sling psychrometers should be moistened immediately before use.

The evaporation of an ice film may be prevented or slowed by enclosing the wet bulb in a small glass tube, or by stopping the ventilation inlet of the wet bulb between intervals. (Note that the latter course should not be taken if the circumstances are such that the ventilating fan would overheat.)

The effect of supercooled water on the wet bulb may be dealt with in two ways:

- (a) By using different tables when the wet bulb is coated with ice and with supercooled water, respectively. To find out which table should be used, the wet bulb should be touched with a snow crystal, a pencil or other object, just after each observation is completed. If the temperature rises towards 0°C , and then commences to fall again, it can be assumed that the water on the wet bulb was supercooled at the time of the observation;
- (b) By using a table appropriate for an ice-covered wet bulb and inducing the freezing of supercooled water in the same way as for method (a). In order to save time and to ensure that the wet bulb is ice-covered, the observer should make a point of initiating the freezing of the water at each observation as soon as possible after moistening the

bulb. From the behaviour of the wetted thermometer at the freezing point it may usually be determined whether the bulb is covered by ice or by supercooled water. The recommended procedure, however, is to initiate the freezing of the water at each observation when the wet-bulb temperature is assumed to be below 0°C, regardless of whether the behaviour of the thermometer after moistening has been observed or not.

Although the first method is usually the quickest, it requires two tables and this may cause some confusion.

4.2.1.5 General procedure for making observations

The procedures outlined in Part 1, Chapter 2, for the measurement of temperature should be followed, in addition to the following procedures:

- (a) If the wet-bulb sleeve, wick or water has to be changed, this should be done sufficiently in advance of the observation. The period required for the correct wet-bulb temperature to be attained will depend upon the type of psychrometer;
- (b) The thermometers should be read to the nearest tenth of a degree;
- (c) When making an observation, the readings of the two thermometers should, as far as possible, be taken simultaneously, and it should be ascertained that the wet bulb is receiving a sufficient water supply.

4.2.1.6 Use of electrical resistance thermometers

Precision platinum electrical resistance thermometers are widely used in place of mercury-in-glass thermometers, in particular where remote reading and continuous measurements are required. It is necessary to ensure that the devices, and the interfacing electrical circuits selected, meet the performance requirements. These are detailed in Part I, Chapter 2. Particular care should always be taken with regard to self-heating effects in electrical thermometers.

The psychrometric formulae in Annex 4.B used for Assmann aspiration psychrometers are also valid if platinum resistance thermometers are used in place of the mercury-in-glass instruments, with different configurations of elements and thermometers. The formula for water on the wet bulb is also valid for some transversely ventilated psychrometers (WMO, 1989a).

4.2.1.7 Sources of error in psychrometry

The following main sources of error must be considered:

- (a) Index errors of the thermometers: It is very important in psychrometric measurements that the index errors of the thermometers be known over the actual temperature range and that corrections for these errors be applied to the readings before the humidity tables are used. Any other errors in the wet-bulb or ice-bulb temperature caused by other influences will appear in the same way as index errors. Table 4.3 shows the error in relative humidity $\varepsilon(U)$, derived from wet- and ice-bulb measurements having errors $\varepsilon(t_x)$, where x is water for $t > 0^\circ\text{C}$ and ice for $t < 0^\circ\text{C}$, respectively of 0.5 and 0.1 K, for a relative humidity U of 50 per cent and a range of true air temperatures (where the dry-bulb reading is assumed to give the true air temperature).

Table 4.3. Error in derived relative humidity resulting from wet- and ice-bulb index errors $\varepsilon(t_x)$ for $U = 50$ per cent

Air temperature in °C	Error in relative humidity, $\varepsilon(U)$ in per cent due to an error in wet- or ice-bulb temperature	
	$\varepsilon(t_x) = 0.5 \text{ K}$	$\varepsilon(t_x) = 0.1 \text{ K}$
-30	60	12
-20	27	5
-10	14	3
0	8	2
10	5	1
20	4	0.5
30	3	0.5
40	2	0.5
50	2	0

- (b) Thermometer lag coefficients: To obtain the highest accuracy with a psychrometer it is desirable to arrange for the wet and dry bulbs to have approximately the same lag coefficient; with thermometers having the same bulb size, the wet bulb has an appreciably smaller lag than the dry bulb.

- (c) Errors relating to ventilation: Errors due to insufficient ventilation become much more serious through the use of inappropriate humidity tables (see sections covering individual psychrometer types).
- (d) Errors due to excessive covering of ice on the wet bulb: Since a thick coating of ice will increase the lag of the thermometer, it should be removed immediately by dipping the bulb into distilled water.
- (e) Errors due to contamination of the wet-bulb sleeve or to impure water: Large errors may be caused by the presence of substances that alter the vapour pressure of water. The wet bulb with its covering sleeve should be washed at regular intervals in distilled water to remove soluble impurities. This procedure is more frequently necessary in some regions than others, for example, at or near the sea or in areas subject to air pollution.
- (f) Errors due to heat conduction from the thermometer stem to the wet-bulb system: The conduction of heat from the thermometer stem to the wet bulb will reduce the wet-bulb depression and lead to determinations of humidity that are too high. The effect is most pronounced at low relative humidity but can be effectively eliminated by extending the wet-bulb sleeve at least 2 cm beyond the bulb up the stem of the thermometer.

4.2.2 The Assmann aspirated psychrometer

4.2.2.1 Description

Two mercury-in-glass thermometers, mounted vertically side by side in a chromium- or nickel-plated polished metal frame, are connected by ducts to an aspirator. The aspirator may be driven by a spring or an electric motor. One thermometer bulb has a well-fitted muslin wick which, before use, is moistened with distilled water. Each thermometer is located inside a pair of coaxial metal tubes, highly polished inside and out, which screen the bulbs from external thermal radiation. The tubes are all thermally insulated from each other.

A WMO international intercomparison of Assmann-type psychrometers from 10 countries (WMO, 1989*a*) showed that there is good agreement between dry- and wet-bulb temperatures of psychrometers with the dimensional specifications close to the original specification, and with aspiration rates above 2.2 m s^{-1} . Not all commercially available instruments fully comply. A more detailed discussion is found in WMO (1989*a*). The performance of the Assmann

psychrometer in the field may be as good as the achievable accuracy stated in Table 4.1, and with great care it can be significantly improved.

Annex 4.B lists standard formulae for the computation of measures of humidity using an Assmann psychrometer,⁴ which are the bases of some of the other artificially ventilated psychrometers, in the absence of well-established alternatives.

4.2.2.2 Observation procedure

The wick, which must be free of grease, is moistened with distilled water. Dirty or crusty wicks should be replaced. Care should be taken not to introduce a water bridge between the wick and the radiation shield.

The mercury columns of the thermometers should be inspected for breaks, which should be closed up or the thermometer should be replaced.

The instrument is normally operated with the thermometers held vertically. The thermometer stems should be protected from solar radiation by turning the instrument so that the lateral shields are in line with the sun. The instrument should be tilted so that the inlet ducts open into the wind, but care should be taken so that solar radiation does not fall on the thermometer bulbs. A wind screen is necessary in very windy conditions when the rotation of the aspirator is otherwise affected.

The psychrometer should be in thermal equilibrium with the surrounding air. At air temperatures above 0°C , at least three measurements at 1 min intervals should be taken following an aspiration period. Below 0°C it is necessary to wait until the freezing process has finished, and to observe whether there is water or ice on the wick. During the freezing and thawing processes the wet-bulb temperature remains constant at 0°C . In the case of outdoor measurements, several measurements should be taken and the average taken. Thermometer readings should be made with a resolution of 0.1 K or better.

A summary of the observation procedure is as follows:

- (a) Moisten the wet bulb;
- (b) Wind the clockwork motor (or start the electric motor);
- (c) Wait 2 or 3 min or until the wet-bulb reading has become steady;
- (d) Read the dry bulb;

⁴ Recommended by the Commission for Instruments and Methods of Observation at its tenth session (1989).

- (e) Read the wet bulb;
- (f) Check the reading of the dry bulb.

4.2.2.3 Exposure and siting

Observations should be made in an open area with the instrument either suspended from a clamp or attached using a bracket to a thin post, or held with one hand at arm's length with the inlets slightly inclined into the wind. The inlets should be at a height of 1.2 to 2 m above ground for normal measurements of air temperature and humidity.

Great care should be taken to prevent the presence of the observer or any other nearby sources of heat and water vapour, such as the exhaust pipe of a motor vehicle, from having an influence on the readings.

4.2.2.4 Calibration

The ventilation system should be checked regularly, at least once per month.

The calibration of the thermometers should also be checked regularly. The two may be compared together, with both thermometers measuring the dry-bulb temperature. Comparison with a certified reference thermometer should be performed at least once a year.

4.2.2.5 Maintenance

Between readings, the instrument should be stored in an unheated room or be otherwise protected from precipitation and strong insolation. When not in use, the instrument should be stored indoors in a sturdy packing case such as that supplied by the manufacturer.

4.2.3 Screen psychrometer

4.2.3.1 Description

Two mercury-in-glass thermometers are mounted vertically in a thermometer screen. The diameter of the sensing bulbs should be about 10 mm. One of the bulbs is fitted with a wet-bulb sleeve, which should fit closely to the bulb and extend at least 20 mm up the stem beyond it. If a wick and water reservoir are used to keep the wet-bulb sleeve in a moist condition, the reservoir should preferably be placed to the side of the thermometer and with the mouth at the same level as, or slightly lower than, the top of the thermometer bulb. The wick should be kept as straight as possible and its length should be such that water reaches the bulb

with sensibly the wet-bulb temperature and in sufficient (but not excessive) quantity. If no wick is used, the wet bulb should be protected from dirt by enclosing the bulb in a small glass tube between readings.

It is recommended that screen psychrometers be artificially aspirated. Both thermometers should be aspirated at an air speed of about 3 m s^{-1} . Both spring-wound and electrically driven aspirators are in common use. The air should be drawn in horizontally across the bulbs, rather than vertically, and exhausted in such a way as to avoid recirculation.

The performance of the screen psychrometer may be much worse than that shown in Table 4.1, especially in light winds if the screen is not artificially ventilated.

The psychrometric formulae given in section 4.2.1.1 apply to screen psychrometers, but the coefficients are quite uncertain. A summary of some of the formulae in use is given by Bindon (1965). If there is artificial ventilation at 3 m s^{-1} or more across the wet bulb, the values given in Annex 4.B may be applied, with a psychrometer coefficient of $6.53 \cdot 10^{-4} \text{ K}^{-1}$ for water. However, values from 6.50 to $6.78 \cdot 10^{-4}$ are in use for wet bulbs above 0°C , and 5.70 to $6.53 \cdot 10^{-4}$ for below 0°C . For a naturally ventilated screen psychrometer, coefficients in use range from 7.7 to $8.0 \cdot 10^{-4}$ above freezing and 6.8 to $7.2 \cdot 10^{-4}$ for below freezing when there is some air movement in the screen, which is probably nearly always the case. However, coefficients up to $12 \cdot 10^{-4}$ for water and $10.6 \cdot 10^{-4}$ for ice have been advocated for when there is no air movement.

The psychrometer coefficient appropriate for a particular configuration of screen, shape of wet bulb and degree of ventilation may be determined by comparison with a suitable working or reference standard, but there will be a wide scatter in the data, and a very large experiment would be necessary to obtain a stable result. Even when a coefficient has been obtained by such an experiment, the confidence limits for any single observation will be wide, and there would be little justification for departing from established national practices.

4.2.3.2 Special observation procedures

The procedures described in section 4.2.1.5 apply to the screen psychrometer. In the case of a naturally aspirated wet bulb, provided that the

water reservoir has about the same temperature as the air, the correct wet-bulb temperature will be attained approximately 15 min after fitting a new sleeve; if the water temperature differs substantially from that of the air, it may be necessary to wait for 30 min.

4.2.3.3 Exposure and siting

The exposure and siting of the screen are described in Part I, Chapter 2.

4.2.4 Sling or whirling psychrometers

4.2.4.1 Description

A small portable type of whirling or sling psychrometer consists of two mercury-in-glass thermometers mounted on a sturdy frame, which is provided with a handle and spindle, and located at the furthest end from the thermometer bulbs, by means of which the frame and thermometers may be rotated rapidly about a horizontal axis.

The wet-bulb arrangement varies according to individual design. Some designs shield the thermometer bulbs from direct insolation, and these are to be preferred for meteorological measurements.

The psychrometric formulae in Annex 4.B may be used.

4.2.4.2 Observation procedure

The following guidelines should be applied:

- (a) All instructions with regard to the handling of Assmann aspirated psychrometers apply also to sling psychrometers;
- (b) Sling psychrometers lacking radiation shields for the thermometer bulbs should be shielded from direct insolation in some other way;
- (c) Thermometers should be read at once after aspiration ceases because the wet-bulb temperature will begin to rise immediately, and the thermometers are likely to be subject to insolation effects.

4.2.5 Heated psychrometer

The principle of the heated psychrometer is that the water-vapour content of an air mass does not change if it is heated. This property may be exploited to the advantage of the psychrometer by avoiding the need to maintain an ice bulb under freezing conditions.

4.2.5.1 Description

Air is drawn into a duct where it passes over an electrical heating element and then into a measuring chamber containing both dry- and wet-bulb thermometers and a water reservoir. The heating element control circuit ensures that the air temperature does not fall below a certain level, which might typically be 10°C. The temperature of the water reservoir is maintained in a similar way. Thus, neither the water in the reservoir nor the water at the wick should freeze, provided that the wet-bulb depression is less than 10 K, and that the continuous operation of the psychrometer is secured even if the air temperature is below 0°C. At temperatures above 10°C the heater may be automatically switched off, when the instrument reverts to normal psychrometric operation.

Electrical thermometers are used so that they may be entirely enclosed within the measuring chamber and without the need for visual readings.

A second dry-bulb thermometer is located at the inlet of the duct to provide a measurement of the ambient air temperature. Thus, the ambient relative humidity may be determined.

The psychrometric thermometer bulbs are axially aspirated at an air velocity in the region of 3 m s⁻¹.

4.2.5.2 Observation procedure

A heated psychrometer would be suitable for automatic weather stations.

4.2.5.3 Exposure and siting

The instrument itself should be mounted outside a thermometer screen. The air inlet, where ambient air temperature is measured, should be inside the screen.

4.2.6 The WMO reference psychrometer

The reference psychrometer and procedures for its operation are described in WMO (1992). The wet- and dry-bulb elements are enclosed in an aspirated shield, for use as a free-standing instrument. Its significant characteristic is that the psychrometer coefficient is calculable from the theory of heat and mass exchanges at the wet bulb, and is different from the coefficient for other psychrometers, with a value of $6.53 \cdot 10^{-4} \text{ K}^{-1}$ at 50 per cent relative humidity, 20°C and 1 000 hPa. Its wet-bulb temperature is very close to the theoretical value (see Annex 4.A,

paragraphs 18 and 19). This is achieved by ensuring that the evaporation at the wet bulb is very efficient and that extraneous heating is minimized. The nature of the air-flow over the wet bulb is controlled by careful shaping of the duct and the bulb, and by controlling the ventilation rate. The double shield is highly reflective externally, and blackened on the inside, and the thermometer elements are insulated and separated by a shield. The shields and the wet-bulb element (which contains the thermometer) are made of stainless steel to minimize thermal conduction.

The procedures for the use of the reference psychrometer ensure that the wet bulb is completely free of grease, even in the monomolecular layers that always arise from handling any part of the apparatus with the fingers. This is probably the main reason for the close relation of the coefficient to the theoretical value, and its difference from the psychrometer coefficients of other instruments.

The reference psychrometer is capable of great accuracy, 0.38 per cent uncertainty in relative humidity at 50 per cent relative humidity and 20°C. It has also been adopted as the WMO reference thermometer. It is designed for use in the field but is not suitable for routine use. It should be operated only by staff accustomed to very precise laboratory work. Its use as a reference instrument is discussed in section 4.9.7.

4.3 THE HAIR HYGROMETER

4.3.1 General considerations

Any absorbing material tends to equilibrium with its environment in terms of both temperature and humidity. The water-vapour pressure at the surface of the material is determined by the temperature and the amount of water bound by the material. Any difference between this pressure and the water-vapour pressure of the surrounding air will be equalized by the exchange of water molecules.

The change in the length of hair has been found to be a function primarily of the change in relative humidity with respect to liquid water (both above and below an air temperature of 0°C), with an increase of about 2 to 2.5 per cent when the humidity changes from 0 to 100 per cent. By rolling the hairs to produce an elliptical cross-section and by dissolving out the fatty substances with alcohol, the ratio of the surface area to the enclosed volume increases and yields a decreased lag coefficient

which is particularly relevant for use at low air temperatures. This procedure also results in a more linear response function, although the tensile strength is reduced. For accurate measurements, a single hair element is to be preferred, but a bundle of hairs is commonly used to provide a degree of ruggedness. Chemical treatment with barium (BaS) or sodium (Na₂S) sulfide yields further linearity of response.

The hair hygrograph or hygrometer is considered to be a satisfactory instrument for use in situations or during periods where extreme and very low humidities are seldom or never found. The mechanism of the instrument should be as simple as possible, even if this makes it necessary to have a non-linear scale. This is especially important in industrial regions, since air pollutants may act on the surface of the moving parts of the mechanism and increase friction between them.

The rate of response of the hair hygrometer is very dependent on air temperature. At -10°C the lag of the instrument is approximately three times greater than the lag at 10°C. For air temperatures between 0 and 30°C and relative humidities between 20 and 80 per cent a good hygrograph should indicate 90 per cent of a sudden change in humidity within about 3 min.

A good hygrograph in perfect condition should be capable of recording relative humidity at moderate temperatures with an uncertainty of ±3 per cent. At low temperatures, the uncertainty will be greater.

Using hair pre-treated by rolling (as described above) is a requirement if useful information is to be obtained at low temperatures.

4.3.2 Description

The detailed mechanism of hair hygrometers varies according to the manufacturer. Some instruments incorporate a transducer to provide an electrical signal, and these may also provide a linearizing function so that the overall response of the instrument is linear with respect to changes in relative humidity.

The most commonly used hair hygrometer is the hygrograph. This employs a bundle of hairs held under slight tension by a small spring and connected to a pen arm in such a way as to magnify a change in the length of the bundle. A pen at the end of the pen arm is in contact with a paper chart fitted around a metal cylinder and registers the angular displacement of the arm.

The cylinder rotates about its axis at a constant rate determined by a mechanical clock movement. The rate of rotation is usually one revolution either per week or per day. The chart has a scaled time axis that extends round the circumference of the cylinder and a scaled humidity axis parallel to the axis of the cylinder. The cylinder normally stands vertically.

The mechanism connecting the pen arm to the hair bundle may incorporate specially designed cams that translate the non-linear extension of the hair in response to humidity changes into a linear angular displacement of the arm.

The hair used in hygrometers may be of synthetic fibre. Where human hair is used it is normally first treated as described in section 4.3.1 to improve both the linearity of its response and the response lag, although this does result in a lower tensile strength.

The pen arm and clock assembly are normally housed in a box with glass panels which allow the registered humidity to be observed without disturbing the instrument, and with one end open to allow the hair element to be exposed in free space outside the limits of the box. The sides of the box are separate from the solid base, but the end opposite the hair element is attached to it by a hinge. This arrangement allows free access to the clock cylinder and hair element. The element may be protected by an open mesh cage.

4.3.3 **Observation procedure**

The hair hygrometer should always be tapped lightly before being read in order to free any tension in the mechanical system. The hygrograph should, as far as possible, not be touched between changes of the charts except in order to make of time marks.

Both the hygrometer and the hygrograph can normally be read to the nearest 1 per cent of relative humidity. Attention is drawn to the fact that the hair hygrometer measures relative humidity with respect to saturation over liquid water even at air temperatures below 0°C.

The humidity of the air may change very rapidly and, therefore, accurate setting of time marks on a hygrograph is very important. In making the marks, the pen arm should be moved only in the direction of decreasing humidity on the chart. This is done so that the hairs are slackened by the displacement and, to bring the pen back to its correct position, the restoring force is applied by

the tensioning spring. However, the effect of hysteresis may be evidenced in the failure of the pen to return to its original position.

4.3.4 **Exposure and siting**

The hygrograph or hygrometer should be exposed in a thermometer screen. Ammonia is very destructive to natural hair. Exposure in the immediate vicinity of stables and industrial plants using ammonia should be avoided.

When used in polar regions, the hygrograph should preferably be exposed in a special thermometer screen which provides the instrument with sufficient protection against precipitation and drifting snow. For example, a cover for the thermometer screen can be made of fine-meshed net (Mullergas) as a precautionary measure to prevent the accumulation of snow crystals on the hairs and the bearing surfaces of the mechanical linkage. This method can be used only if there is no risk of the net being wetted by melting snow crystals.

4.3.5 **Sources of error**

4.3.5.1 **Changes in zero offset**

For various reasons which are poorly understood, the hygrograph is liable to change its zero. The most likely cause is that excess tension has been induced in the hairs. For instance, the hairs may be stretched if time marks are made in the direction of increasing humidity on the chart or if the hygrograph mechanism sticks during decreasing humidity. The zero may also change if the hygrograph is kept in very dry air for a long time, but the change may be reversed by placing the instrument in a saturated atmosphere for a sufficient length of time.

4.3.5.2 **Errors due to contamination of the hair**

Most kinds of dust will cause appreciable errors in observations (perhaps as much as 15 per cent relative humidity). In most cases this may be eliminated, or at least reduced, by cleaning and washing the hairs. However, the harmful substances found in dust may also be destructive to hair (see section 4.3.4).

4.3.5.3 **Hysteresis**

Hysteresis is exhibited both in the response of the hair element and in the recording mechanism of the hair hygrometer. Hysteresis in the recording

mechanism is reduced through the use of a hair bundle, which allows a greater loading force to overcome friction. It should be remembered that the displacement magnification of the pen arm lever applies also to the frictional force between the pen and paper, and to overcome this force it requires a proportionately higher tension in the hair. The correct setting of the tensioning spring is also required to minimize hysteresis, as is the correct operation of all parts of the transducing linkage. The main fulcrum and any linearizing mechanism in the linkage introduce much of the total friction.

Hysteresis in the hair element is normally a short-term effect related to the absorption-desorption processes and is not a large source of error once vapour pressure equilibrium is established (see section 4.3.5.1 in respect of prolonged exposure at low humidity).

4.3.6 Calibration and comparisons

The readings of a hygrograph should be checked as frequently as is practical. In the case where wet- and dry-bulb thermometers are housed in the same thermometer screen, these may be used to provide a comparison whenever suitable steady conditions prevail, but otherwise field comparisons have limited value due to the difference in response rate of the instruments.

Accurate calibration can only be obtained through the use of an environmental chamber and by comparison with reference instruments.

The 100 per cent humidity point may be checked, preferably indoors with a steady air temperature, by surrounding the instrument with a saturated cloth (though the correct reading will not be obtained if a significant mass of liquid water droplets forms on the hairs).

The ambient indoor humidity may provide a low relative humidity checkpoint for comparison against a reference aspirated psychrometer. A series of readings should be obtained.

Long-term stability and bias may be appraised by presenting comparisons with a reference aspirated psychrometer in terms of a correlation function.

4.3.7 Maintenance

Observers should be encouraged to keep the hygrometer clean.

The hair should be washed at frequent intervals using distilled water on a soft brush to remove accumulated dust or soluble contaminants. At no time should the hair be touched by fingers. The bearings of the mechanism should be kept clean and a small amount of clock oil should be applied occasionally. The bearing surfaces of any linearizing mechanism will contribute largely to the total friction in the linkage, which may be minimized by polishing the surfaces with graphite. This procedure may be carried out by using a piece of blotting paper rubbed with a lead pencil.

With proper care, the hairs may last for several years in a temperate climate and when not subject to severe atmospheric pollution. Recalibration and adjustment will be required when hairs are replaced.

4.4 THE CHILLED-MIRROR DEWPOINT HYGROMETER

4.4.1 General considerations

4.4.1.1 Theory

The dewpoint (or frost-point) hygrometer is used to measure the temperature at which moist air, when cooled, reaches saturation and a deposit of dew (or ice) can be detected on a solid surface, which usually is a mirror. The deposit is normally detected optically. The principle of the measurement is described in section 4.1.4.5 and below.

The thermodynamic dewpoint is defined for a plane surface of pure water. In practice, water droplets have curved surfaces, over which the saturation vapour pressure is higher than for the plane surface (known as the Kelvin effect). Hydrophobic contaminants will exaggerate the effect, while soluble ones will have the opposite effect and lower the saturation vapour pressure (the Raoult effect). The Kelvin and Raoult effects (which, respectively, raise and lower the apparent dewpoint) are minimized if the critical droplet size adopted is large rather than small; this reduces the curvature effect directly and reduces the Raoult effect by lowering the concentration of a soluble contaminant.

4.4.1.2 Principles

When moist air at temperature T , pressure p and mixing ratio r_w (or r_i) is cooled, it eventually reaches its saturation point with respect to a free water

surface (or to a free ice surface at lower temperatures) and a deposit of dew (or frost) can be detected on a solid non-hygroscopic surface. The temperature of this saturation point is called the thermodynamic dewpoint temperature T_d (or the thermodynamic frost-point temperature T_f). The corresponding saturation vapour pressure with respect to water e'_w (or ice e'_i) is a function of T_d (or T_f), as shown in the following equations:

$$e'_w(p, T_d) = f(p) \cdot e_w(T_d) = \frac{r \cdot p}{0.62198 + r} \quad (4.3)$$

$$e'_i(p, T_f) = f(p) \cdot e_i(T_f) = \frac{r \cdot p}{0.62198 + r} \quad (4.4)$$

The hygrometer measures T_d or T_f . Despite the great dynamic range of moisture in the troposphere, this instrument is capable of detecting both very high and very low concentrations of water vapour by means of a thermal sensor alone.

Cooling using a low-boiling-point liquid has been used but is now largely superseded except for very low water-vapour concentrations.

It follows from the above that it must also be possible to determine whether the deposit is supercooled liquid or ice when the surface temperature is at or below freezing point.

The chilled-mirror hygrometer is used for meteorological measurements and as a reference instrument both in the field and in the laboratory.

4.4.2 Description

4.4.2.1 Sensor assembly

The most widely used systems employ a small polished-metal reflecting surface, cooled electrically using a Peltier-effect device. The sensor consists of a thin metallic mirror of small (2 to 5 mm) diameter that is thermally regulated using a cooling assembly (and possibly a heater), with a temperature sensor (thermocouple or platinum resistance thermometer) embedded on the underside of the mirror. The mirror should have a high thermal conductance, optical reflectivity and corrosion resistance combined with a low permeability to water vapour. Suitable materials used include gold, rhodium-plated silver, chromium-plated copper and stainless steel.

The mirror should be equipped with a (preferably automatic) device for detecting contaminants that may increase or decrease the apparent dewpoint (see section 4.4.2.2), so that they may be removed.

4.4.2.2 Optical detection assembly

An electro-optical system is usually employed to detect the formation of condensate and to provide the input to the servo-control system to regulate the temperature of the mirror. A narrow beam of light is directed at the mirror at an angle of incidence of about 55°. The light source may be incandescent but is now commonly a light-emitting diode. In simple systems, the intensity of the directly reflected light is detected by a photodetector that regulates the cooling and heating assembly through a servo-control. The specular reflectivity of the surface decreases as the thickness of the deposit increases; cooling should cease while the deposit is thin, with a reduction in reflectance in the range of 5 to 40 per cent. More elaborate systems use an auxiliary photodetector which detects the light scattered by the deposit; the two detectors are capable of very precise control. A second, uncooled, mirror may be used to improve the control system.

Greatest precision is obtained by controlling the mirror to a temperature at which condensate neither accumulates nor dissipates; however, in practice, the servo-system will oscillate around this temperature. The response time of the mirror to heating and cooling is critical in respect of the amplitude of the oscillation, and should be of the order of 1 to 2 s. The air-flow rate is also important for maintaining a stable deposit on the mirror. It is possible to determine the temperature at which condensation occurs with a precision of 0.05 K.

It is feasible, but a time-consuming and skilled task, to observe the formation of droplets by using a microscope and to regulate the mirror temperature under manual control.

4.4.2.3 Thermal control assembly

A Peltier-effect thermo-junction device provides a simple reversible heat pump; the polarity of direct current energization determines whether heat is pumped to, or from, the mirror. The device is bonded to, and in good thermal contact with, the underside of the mirror. For very low dewpoints, a multistage Peltier device may be required.

Thermal control is achieved by using an electrical servo-system that takes as input the signal from the optical detector subsystem. Modern systems operate under microprocessor control.

A low-boiling-point fluid, such as liquid nitrogen, may be used to provide cooling, but this technique is no longer widely used. Similarly, electrical resistance wire may be used for heating but has now been superseded with the advent of small Peltier devices.

4.4.2.4 Temperature display system

The mirror temperature, as measured by the electrical thermometer embedded beneath the mirror surface, is presented to the observer as the dewpoint of the air sample. Commercial instruments normally include an electrical interface for the mirror thermometer and a digital display, but may also provide digital and analogue electrical outputs for use with data-logging equipment. A chart recorder is particularly useful for monitoring the performance of the instrument in the case where the analogue output provides a continuous registration of the mirror thermometer signal but the digital display does not.

4.4.2.5 Auxiliary systems

A microscope may be incorporated to provide a visual method to discriminate between supercooled water droplets and ice crystals for mirror temperatures below 0°C. Some instruments have a detector mounted on the mirror surface to provide an automatic procedure for this purpose (for example, capacitive sensor), while others employ a method based on reflectance.

A microprocessor-based system may incorporate algorithms to calculate and display relative humidity. In this case, it is important that the instrument should discriminate correctly between a water and an ice deposit.

Many instruments provide an automatic procedure for minimizing the effects of contamination. This may be a regular heating cycle in which volatile contaminants are evaporated and removed in the air stream. Systems with a wiper to automatically clean the mirror by means of a wiper are also in use.

For meteorological measurements, and in most laboratory applications, a small pump is required to draw the sampled air through the measuring chamber. A regulating device is also required to

set the flow at a rate that is consistent with the stable operation of the mirror temperature servo-control system and at an acceptable rate of response to changes in humidity. The optimum flow rate is dependent upon the moisture content of the air sample and is normally within the range of 0.25 to 1 l min⁻¹.

4.4.3 Observation procedure

The correct operation of a dewpoint hygrometer depends upon achieving an appropriate volume air-flow rate through the measuring chamber. The setting of a regulator for this purpose, usually a throttling device located downstream of the measuring chamber, is likely to require adjustment to accommodate diurnal variations in air temperature. Adjustment of the air-flow will disturb the operation of the hygrometer, and it may even be advisable to initiate a heating cycle. Both measures should be taken with sufficient time in order for a stable operation to be achieved before a reading is taken. The amount of time required will depend upon the control cycle of the individual instrument. The manufacturer's instructions should be consulted to provide appropriate guidance on the air-flow rate to be set and on details of the instrument's control cycle.

The condition of the mirror should be checked frequently; the mirror should be cleaned as necessary. The stable operation of the instrument does not necessarily imply that the mirror is clean. It should be washed with distilled water and dried carefully by wiping it with a soft cloth or cotton dabstick to remove any soluble contaminant. Care must be taken not to scratch the surface of the mirror, most particularly where the surface has a thin plating to protect the substrate or where an ice/liquid detector is incorporated. If an air filter is not in use, cleaning should be performed at least daily. If an air filter is in use, its condition should be inspected at each observation. The observer should take care not to stand next to the air inlet or to allow the outlet to become blocked.

For readings at, or below, 0°C the observer should determine whether the mirror condensate is supercooled water or ice. If no automatic indication is given, the mirror must be observed. From time to time the operation of any automatic system should be verified.

An uncertainty of ± 0.3 K over a wide dewpoint range (-60 to 50°C) is specified for the best instruments.

4.4.4 Exposure and siting

The criteria for the siting of the sensor unit are similar to those for any aspirated hygrometer, although less stringent than for either a psychrometer or a relative humidity sensor, considering the fact that the dew or frost point of an air sample is unaffected by changes to the ambient temperature provided that it remains above the dewpoint at all times. For this reason, a temperature screen is not required. The sensor should be exposed in an open space and may be mounted on a post, within a protective housing structure, with an air inlet at the required level.

An air-sampling system is required. This is normally a small pump that must draw air from the outlet port of the measuring chamber and eject it away from the inlet duct. Recirculation of the air-flow should be avoided as this represents a poor sampling technique, although under stable operation the water-vapour content at the outlet should be effectively identical to that at the inlet. Recirculation may be avoided by fixing the outlet above the inlet, although this may not be effective under radiative atmospheric conditions when a negative air temperature lapse rate exists.

An air filter should be provided for continuous outdoor operations. It must be capable of allowing an adequate throughflow of air without a large blocking factor, as this may result in a significant drop in air pressure and affect the condensation temperature in the measuring chamber. A sintered metal filter may be used in this application to capture all but the smallest aerosol particles. A metal filter has the advantage that it may be heated easily by an electrical element in order to keep it dry under all conditions. It is more robust than the membrane-type filter and more suited to passing the relatively high air-flow rates required by the chilled-mirror method as compared with the sorption method. On the other hand, a metallic filter may be more susceptible to corrosion by atmospheric pollutants than some membrane filters.

4.4.5 Calibration

Regular comparisons against a reference instrument, such as an Assmann psychrometer or another chilled-mirror hygrometer, should be made as the operation of a field chilled mirror is subject to a number of influences which may degrade its performance. An instrument continuously in the field should be the subject of weekly check measurements. As the opportunity arises, its operation at both dew and frost points should be verified. When

the mirror temperature is below 0°C the deposit should be inspected visually, if this is possible, to determine whether it is of supercooled water or ice.

A useful check is to compare the mirror temperature measurement with the air temperature while the thermal control system of the hygrometer is inactive. The instrument should be aspirated, and the air temperature measured at the mouth of the hygrometer air intake. This check is best performed under stable, non-condensing conditions. In bright sunshine, the sensor and duct should be shaded and allowed to come to equilibrium. The aspiration rate may be increased for this test.

An independent field calibration of the mirror thermometer interface may be performed by simulating the thermometer signal. In the case of a platinum resistance thermometer, a standard platinum resistance simulation box, or a decade resistance box and a set of appropriate tables, may be used. A special simulator interface for the hygrometer control unit may also be required.

4.5 THE LITHIUM CHLORIDE HEATED CONDENSATION HYGROMETER (DEW CELL)

4.5.1 General considerations

4.5.1.1 Principles

The physical principles of the heated salt-solution method are discussed in section 4.1.4.5.2. The equilibrium vapour pressure at the surface of a saturated lithium chloride solution is exceptionally low. As a consequence, a solution of lithium chloride is extremely hygroscopic under typical conditions of surface atmospheric humidity; if the ambient vapour pressure exceeds the equilibrium vapour pressure of the solution, water vapour will condense over it (for example, at 0°C water vapour condenses over a plane surface of a saturated solution of lithium chloride to only 15 per cent relative humidity).

A thermodynamically self-regulating device may be achieved if the solution is heated directly by passing an electrical current through it from a constant-voltage device. An alternating current should be used to prevent polarization of the solution. As the electrical conductivity decreases, so will the heating current, and an equilibrium point will be reached whereby a constant temperature is maintained; any

cooling of the solution will result in the condensation of water vapour, thus causing an increase in conductivity and an increase in heating current, which will reverse the cooling trend. Heating beyond the balance point will evaporate water vapour until the consequent fall in conductivity reduces the electrical heating to the point where it is exceeded by heat losses, and cooling ensues.

It follows from the above that there is a lower limit to the ambient vapour pressure that may be measured in this way at any given temperature. Below this value, the salt solution would have to be cooled in order for water vapour to condense. This would be equivalent to the chilled-mirror method except that, in the latter case, condensation takes place at a lower temperature when saturation is achieved with respect to a pure water surface, namely, at the ambient dewpoint.

A degree of uncertainty is inherent in the method due to the existence of four different hydrates of lithium chloride. At certain critical temperatures, two of the hydrates may be in equilibrium with the aqueous phase, and the equilibrium temperature achieved by heating is affected according to the hydrate transition that follows. The most serious ambiguity for meteorological purposes occurs for ambient dewpoint temperatures below -12°C . For an ambient dewpoint of -23°C , the potential difference in equilibrium temperature, according to which one of the two hydrate-solution transitions takes place, results in an uncertainty of ± 3.5 K in the derived dewpoint value.

4.5.1.2 Description

The dew-cell hygrometer measures the temperature at which the equilibrium vapour pressure for a saturated solution of lithium chloride is equal to the ambient water-vapour pressure. Empirical transformation equations, based on saturation vapour pressure data for lithium chloride solution and for pure water, provide for the derivation of the ambient water vapour and dewpoint with respect to a plane surface of pure water. The dewpoint temperature range of -12 to 25°C results in dew-cell temperatures in the range of 17 to 71°C .

4.5.1.3 Sensors with direct heating

The sensor consists of a tube, or bobbin, with a resistance thermometer fitted axially within. The external surface of the tube is covered with a glass fibre material (usually tape wound around and along the tube) that is soaked with an aqueous

solution of lithium chloride, sometimes combined with potassium chloride. Bifilar silver or gold wire is wound over the covering of the bobbin, with equal spacing between the turns. An alternating electrical current source is connected to the two ends of the bifilar winding; this is commonly derived from the normal electrical supply (50 or 60 Hz). The lithium chloride solution is electrically conductive to a degree determined by the concentration of solute. A current passes between adjacent bifilar windings, which act as electrodes, and through the solution. The current heats the solution, which increases in temperature.

Except under conditions of extremely low humidity, the ambient vapour pressure will be higher than the equilibrium vapour pressure over the solution of lithium chloride at ambient air temperature, and water vapour will condense onto the solution. As the solution is heated by the electrical current, a temperature will eventually be reached above which the equilibrium vapour pressure exceeds the ambient vapour pressure, evaporation will begin, and the concentration of the solution will increase.

An operational equilibrium temperature exists for the instrument, depending upon the ambient water-vapour pressure. Above the equilibrium temperature, evaporation will increase the concentration of the solution, and the electrical current and the heating will decrease and allow heat losses to cause the temperature of the solution to fall. Below the equilibrium temperature, condensation will decrease the concentration of the solution, and the electrical current and the heating will increase and cause the temperature of the solution to rise. At the equilibrium temperature, neither evaporation nor condensation occurs because the equilibrium vapour pressure and the ambient vapour pressure are equal.

In practice, the equilibrium temperature measured is influenced by individual characteristics of sensor construction and has a tendency to be higher than that predicted from equilibrium vapour-pressure data for a saturated solution of lithium chloride. However, reproducibility is sufficiently good to allow the use of a standard transfer function for all sensors constructed to a given specification.

Strong ventilation affects the heat transfer characteristics of the sensor, and fluctuations in ventilation lead to unstable operation.

In order to minimize the risk of excessive current when switching on the hygrometer (as the resistance of the solution at ambient temperature is rather low), a current-limiting device, in the form of a small lamp, is normally connected to the heater element. The lamp is chosen so that, at normal bobbin-operating currents, the filament resistance will be low enough for the hygrometer to function properly, while the operating current for the incandescent lamp (even allowing for a bobbin-offering no electrical resistance) is below a value that might damage the heating element.

The equilibrium vapour pressure for saturated lithium chloride depends upon the hydrate being in equilibrium with the aqueous solution. In the range of solution temperatures corresponding to dewpoints of -12 to 41°C monohydrate normally occurs. Below -12°C , dihydrate forms, and above 41°C , anhydrous lithium chloride forms. Close to the transition points, the operation of the hygrometer is unstable and the readings ambiguous. However, the -12°C lower dewpoint limit may be extended to -30°C by the addition of a small amount of potassium chloride (KCl).

4.5.1.4 Sensors with indirect heating

Improved accuracy, compared with the arrangement described in section 4.5.1.2, may be obtained when a solution of lithium chloride is heated indirectly. The conductance of the solution is measured between two platinum electrodes and provides control of a heating coil.

4.5.2 Operational procedure

Readings of the equilibrium temperature of the bobbin are taken and a transfer function applied to obtain the dewpoint temperature.

Disturbing the sensor should be avoided as the equilibrium temperature is sensitive to changes in heat losses at the bobbin surface.

The instrument should be energized continuously. If allowed to cool below the equilibrium temperature for any length of time, condensation will occur and the electrolyte will drip off.

Check measurements with a working reference hygrometer must be taken at regular intervals and the instrument must be cleaned and retreated with a lithium chloride solution, as necessary.

A current-limiting device should be installed if not provided by the manufacturer, otherwise the high current may damage the sensor when the instrument is powered-up.

4.5.3 Exposure and siting

The hygrometer should be located in an open area in a housing structure which protects it from the effects of wind and rain. A system for providing a steady aspiration rate is required.

The heat from the hygrometer may affect other instruments; this should be taken into account when choosing its location.

The operation of the instrument will be affected by atmospheric pollutants, particularly substances which dissociate in solutions and produce a significant ion concentration.

4.5.4 Sources of error

An electrical resistance thermometer is required for measuring the equilibrium temperature; the usual sources of error for thermometry are present.

The equilibrium temperature achieved is determined by the properties of the solute, and significant amounts of contaminant will have an unpredictable effect.

Variations in aspiration affect the heat exchange mechanisms and, thus, the stability of operation of the instrument. A steady aspiration rate is required for a stable operation.

4.5.5 Calibration

A field calibration should be performed at least once a month, by means of comparison with a working standard instrument. Calibration of the bobbin thermometer and temperature display should be performed regularly, as for other operational thermometers and display systems.

4.5.6 Maintenance

The lithium chloride should be renewed regularly. This may be required once a month, but will depend upon the level of atmospheric pollution. When renewing the solution, the bobbin should be washed with distilled water and fresh solution subsequently applied. The housing structure should be cleaned at the same time.

Fresh solution may be prepared by mixing five parts by weight of anhydrous lithium chloride with 100 parts by weight of distilled water. This is equivalent to 1 g of anhydrous lithium chloride to 20 ml of water.

The temperature-sensing apparatus should be maintained in accordance with the recommendations for electrical instruments used for making air temperature measurements, but bearing in mind the difference in the range of temperatures measured.

4.6 **ELECTRICAL RESISTIVE AND CAPACITIVE HYGROMETERS**

4.6.1 **General considerations**

Certain hygroscopic materials exhibit changes in their electrical properties in response to a change in the ambient relative humidity with only a small temperature dependence.

Electrical relative humidity sensors are increasingly used for remote-reading applications, particularly where a direct display of relative humidity is required. Since many of them have very non-linear responses to changes in humidity, the manufacturers often supply them with special data-processing and display systems.

4.6.2 **Electrical resistance**

Sensors made from chemically treated plastic material having an electrically conductive surface layer on the non-conductive substrate may be used for meteorological purposes. The surface resistivity varies according to the ambient relative humidity. The process of adsorption, rather than absorption, is dominant because the humidity-sensitive part of such a sensor is restricted to the surface layer. As a result, this type of sensor is capable of responding rapidly to a change in ambient humidity.

This class of sensor includes various electrolytic types in which the availability of conductive ions in a hygroscopic electrolyte is a function of the amount of adsorbed water vapour. The electrolyte may take various physical forms, such as liquid or gel solutions, or an ion-exchange resin. The change in impedance to an alternating current, rather than to a direct current, is measured in

order to avoid polarization of the electrolyte. Low-frequency supply can be used, given that the DC resistance is to be measured, and therefore it is possible to employ quite long leads between the sensor and its electrical interface.

4.6.3 **Electrical capacitance**

The method is based upon the variation of the dielectric properties of a solid, hygroscopic material in relation to the ambient relative humidity. Polymeric materials are most widely used for this purpose. The water bound in the polymer alters its dielectric properties owing to the large dipole moment of the water molecule.

The active part of the humidity sensor consists of a polymer foil sandwiched between two electrodes to form a capacitor. The electrical impedance of this capacitor provides a measure of relative humidity. The nominal value of capacitance may be only a few or several hundred picofarads, depending upon the size of the electrodes and the thickness of the dielectric. This will, in turn, influence the range of excitation frequency used to measure the impedance of the device, which is normally at least several kilohertz and, thus, requires that short connections be made between the sensor and the electrical interface to minimize the effect of stray capacitance. Therefore, capacitance sensors normally have the electrical interface built into the probe, and it is necessary to consider the effect of environmental temperature on the performance of the circuit components.

4.6.4 **Observation procedure**

Sensors based on changes in the electronic properties of hygroscopic materials are frequently used for the remote reading of relative humidity and also for automatic weather stations.

4.6.5 **Exposure and siting**

The sensors should be mounted inside a thermometer screen. The manufacturer's advice regarding the mounting of the actual sensor should be followed. The use of protective filters is mandatory. Direct contact with liquid water will seriously harm sensors using hygroscopic electrolyte as a sensor element. Great care should be taken to prevent liquid water from reaching the sensitive element of such sensors.

4.6.6 Calibration

Field and laboratory calibrations should be carried out as for hair hygrometers. Suitable auxiliary equipment to enable checks by means of salt solutions is available for most sensors of this type.

4.6.7 Maintenance

Observers should be encouraged to maintain the hygrometer in clean conditions (see section 4.1.4.10).

4.7 HYGROMETERS USING ABSORPTION OF ELECTROMAGNETIC RADIATION

The water molecule absorbs electromagnetic radiation (EMR) in a range of wavebands and discrete wavelengths; this property can be exploited to obtain a measure of the molecular concentration of water vapour in a gas. The most useful regions of the electromagnetic spectrum, for this purpose, lie in the ultraviolet and infrared regions. Therefore, the techniques are often classified as optical hygrometry or, more correctly, EMR absorption hygrometry.

The method makes use of measurements of the attenuation of radiation in a waveband specific to water-vapour absorption, along the path between a source of the radiation and a receiving device. There are two principal methods for determining the degree of attenuation of the radiation as follows:

- (a) Transmission of narrow-band radiation at a fixed intensity to a calibrated receiver: The most commonly used source of radiation is hydrogen gas; the emission spectrum of hydrogen includes the Lyman-Alpha line at 121.6 nm, which coincides with a water-vapour absorption band in the ultraviolet region where there is little absorption by other common atmospheric gases. The measuring path is typically a few centimetres in length;
- (b) Transmission of radiation at two wavelengths, one of which is strongly absorbed by water vapour and the other being either not absorbed or only very weakly absorbed: If a single source is used to generate the radiation at both wavelengths, the ratio of their emitted intensities may be accurately known, so that the attenuation at the absorbed wave-

length can be determined by measuring the ratio of their intensities at the receiver. The most widely used source for this technique is a tungsten lamp, filtered to isolate a pair of wavelengths in the infrared region. The measuring path is normally greater than 1 m.

Both types of EMR absorption hygrometers require frequent calibration and are more suitable for measuring changes in vapour concentration than absolute levels. The most widespread application of the EMR absorption hygrometer is to monitor very high frequency variations in humidity, since the method does not require the detector to achieve vapour-pressure equilibrium with the sample. The time-constant of an optical hygrometer is typically just a few milliseconds. The use of optical hygrometers remains restricted to research activities.

4.8 SAFETY

Chemical agents are widely used in the measurement of humidity. The properties of such agents should always be made known to the personnel handling them. All chemicals should be kept in secure and clearly labelled containers and stored in an appropriate environment. Instructions concerning the use of toxic materials may be prescribed by local authorities.

Saturated salt solutions are widely used in the measurement of humidity. The notes that follow give some guidance for the safe use of some commonly used salts:

- (a) Barium chloride (BaCl_2): Colourless crystals; very soluble in water; stable, but may emit toxic fumes in a fire; no hazardous reaction with water, acids, bases, oxidizers or with combustible materials; ingestion causes nausea, vomiting, stomach pains and diarrhoea; harmful if inhaled as dust and if it comes into contact with the skin; irritating to eyes; treat with copious amounts of water and obtain medical attention if ingested;
- (b) Calcium chloride (CaCl_2): Colourless crystals; deliquescent; very soluble in water, dissolves with increase in heat; will initiate exothermic polymerization of methyl vinyl ether; can react with zinc to liberate hydrogen; no hazardous reactions with acids, bases, oxidizers or combustibles; irritating to the skin, eyes and

- respiratory system; ingestion causes gastric irritation; ingestion of large amounts can lead to hypercalcaemia, dehydration and renal damage; treat with copious amounts of water and obtain medical attention;
- (c) Lithium chloride (LiCl): Colourless crystals; stable if kept dry; very soluble in water; may emit toxic fumes in a fire; ingestion may affect ionic balance of blood leading to anorexia, diarrhoea, vomiting, dizziness and central nervous system disturbances; kidney damage may result if sodium intake is low (provide plenty of drinking water and obtain medical attention); no hazardous reactions with water, acids, bases, oxidizers or combustibles;
- (d) Magnesium nitrate ($Mg(NO_3)_2$): Colourless crystals; deliquescent; very soluble in water; may ignite combustible material; can react vigorously with deoxidizers, can decompose spontaneously in dimethylformamide; may emit toxic fumes in a fire (fight the fire with a water spray); ingestion of large quantities can have fatal effects (provide plenty of drinking water and obtain medical attention); may irritate the skin and eyes (wash with water);
- (e) Potassium nitrate (KNO_3): White crystals or crystalline powder; very soluble in water; stable but may emit toxic fumes in a fire (fight the fire with a water spray); ingestion of large quantities causes vomiting, but it is

Table 4.4. Standard instruments for the measurement of humidity

Standard instrument	Dewpoint temperature		Relative humidity (%)	
	Range (°C)	Uncertainty (K)	Range	Uncertainty
<i>Primary standard</i>				
Requirement	-60 to -15	0.3	5 to 100	0.2
	-15 to 40	0.1	5 to 100	0.2
Gravimetric hygrometer	-60 to -35	0.25		
	-35 to 35	0.03		
	35 to 60	0.25		
Standard two-temperature humidity generator	-75 to -15	0.25		
	-15 to 30	0.1		
	30 to 80	0.2		
Standard two-pressure humidity generator	-75 to 30	0.2		
<i>Secondary standard</i>				
Requirement	-80 to -15	0.75	5 to 100	0.5
	-15 to 40	0.25		
Chilled-mirror hygrometer	-60 to 40	0.15		
Reference psychrometer			5 to 100	0.6
<i>Reference standard</i>				
Requirement	-80 to -15	1.0	5 to 100	1.5
	-15 to 40	0.3		
Reference psychrometer			5 to 100	0.6
Chilled-mirror hygrometer	-60 to 40	0.3		
<i>Working standard</i>				
Requirement	-15 to 40	0.5	5 to 100	2
Assmann psychrometer	-10 to 25		40 to 90	1
Chilled-mirror hygrometer	-10 to 30	0.5		

- rapidly excreted in urine (provide plenty of drinking water); may irritate eyes (wash with water); no hazardous reaction with water, acids, bases, oxidizers or combustibles;
- (f) Sodium chloride (NaCl): Colourless crystals or white powder; very soluble in water; stable; no hazardous reaction with water, acids, bases, oxidizers or combustibles; ingestion of large amounts may cause diarrhoea, nausea, vomiting, deep and rapid breathing and convulsions (in severe cases obtain medical attention).

Advice concerning the safe use of mercury is given in Part I, Chapter 3.

4.9 STANDARD INSTRUMENTS AND CALIBRATION

4.9.1 Principles involved in the calibration of hygrometers

Precision in the calibration of humidity sensors entails special problems, to a great extent owing to the relatively small quantity of water vapour which can exist in an air sample at normal temperatures, but also due to the general difficulty of isolating and containing gases and, more particularly, vapour. An ordered hierarchy of international traceability in humidity standards is only now emerging.

An absolute standard for humidity (namely, a realization of the physical definition for the quantity of humidity) can be achieved by gravimetric hygrometry. The reference psychrometer (within its limited range) is also a form of primary standard, in that its performance is calculable. The calibration of secondary, reference and working standards involves several steps. Table 4.4 shows a summary of humidity standard instruments and their performances.

A practical field calibration is most frequently done by means of well-designed aspirated psychrometers and dewpoint sensors as working standards. These specific types of standards must be traceable to the higher levels of standards by careful comparisons. Any instrument used as a standard must be individually calibrated for all variables involved in calculating humidity (air temperature, wet-bulb temperature, dewpoint temperature, and so forth). Other factors affecting performance, such as air-flow, must also be checked.

4.9.2 Calibration intervals and methods

Regular calibration is required for all humidity sensors in the field. For chilled-mirror psychrometers and heated dewpoint hygrometers that use a temperature detector, calibration can be checked whenever a regular maintenance routine is performed. Comparison with a working standard, such as an Assmann psychrometer, should be performed at least once a month.

The use of a standard type of aspirated psychrometer, such as the Assmann, as a working standard has the advantage that its integrity can be verified by comparing the dry- and wet-bulb thermometers, and that adequate aspiration may be expected from a healthy sounding fan. The reference instrument should itself be calibrated at an interval appropriate to its type.

Saturated salt solutions can be applied with sensors that require only a small-volume sample. A very stable ambient temperature is required and it is difficult to be confident about their use in the field. When using salt solutions for control purposes, it should be borne in mind that the nominal humidity value given for the salt solution itself is not traceable to any primary standard.

4.9.3 Laboratory calibration

Laboratory calibration is essential for maintaining accuracy in the following ways:

- (a) Field and working standard instruments: Laboratory calibration of field and working standard instruments should be carried out on the same regular basis as for other operational thermometers. For this purpose, the chilled-mirror sensor device may be considered separately from the control unit. The mirror thermometer should be calibrated independently and the control unit should be calibrated on the same regular basis as other items of precision electronic equipment. The calibration of a field instrument in a humidity generator is not strictly necessary if the components have been calibrated separately, as described previously.

The correct operation of an instrument may be verified under stable room conditions by comparison with a reference instrument, such as an Assmann psychrometer or a standard chilled-mirror hygrometer. If the field instrument incorporates an ice detector, the correct operation of this system should be verified.

(b) Reference and standard instruments: Laboratory calibration of reference and standard instruments requires a precision humidity generator and a suitable transfer standard hygrometer. Two-pressure and two-temperature humidity generators are able to deliver a suitable controlled flow of air at a predetermined temperature and dewpoint. The calibration should be performed at least every 12 months and over the full range of the reference application for the instrument. The calibration of the mirror thermometer and the temperature display system should be performed independently at least once every 12 months.

4.9.4 Primary standards

4.9.4.1 Gravimetric hygrometry

The gravimetric method yields an absolute measure of the water-vapour content of an air sample in terms of its humidity mixing ratio. This is obtained by first removing the water vapour from the sample using a known mass of a drying agent, such as anhydrous phosphorous pentoxide (P_2O_5) or magnesium perchlorate ($Mg(ClO_4)_2$). The mass of the water vapour is determined by weighing the drying agent before and after absorbing the vapour. The mass of the dry sample is determined either by weighing (after liquefaction to render the volume of the sample manageable) or by measuring its volume (and having knowledge of its density).

The complexity of the apparatus required to accurately carry out the procedure described limits the application of this method to the laboratory environment. In addition, a substantial volume sample of air is required for accurate measurements to be taken and a practical apparatus requires a steady flow of the humid gas for a number of hours, depending upon the humidity, in order to remove a sufficient mass of water vapour for an accurate weighing measurement. As a consequence, the method is restricted to providing an absolute calibration reference standard. Such an apparatus is found mostly in national calibration standards laboratories.

4.9.4.2 Dynamic two-pressure standard humidity generator

This laboratory apparatus serves to provide a source of humid gas whose relative humidity is determined on an absolute basis. A stream of the carrier gas is passed through a saturating chamber at pressure P_1

and allowed to expand isothermally in a second chamber at a lower pressure P_2 . Both chambers are maintained at the same temperature in an oil bath. The relative humidity of the water vapour-gas mixture is straightforwardly related to the total pressures in each of the two chambers through Dalton's law of partial pressures; the partial pressure e' of the vapour in the low-pressure chamber will have the same relation to the saturation vapour pressure e'_w as the total pressure in the high-pressure saturator has to the total pressure in the low-pressure chamber. Thus, the relative humidity U_w is given by:

$$U_w = 100 \cdot e'/e'_w = 100 \cdot P_1/P_2 \quad (4.5)$$

The relation also holds for the solid phase if the gas is saturated with respect to ice at pressure P_1 :

$$U_i = 100 \cdot e'/e'_i = 100 \cdot P_1/P_2 \quad (4.6)$$

4.9.4.3 Dynamic two-temperature standard humidity generator

This laboratory apparatus provides a stream of humid gas at temperature T_1 having a dew- or frost-point temperature T_2 . Two temperature-controlled baths, each equipped with heat exchangers and one with a saturator containing either water or ice, are used first to saturate the air-stream at temperature T_1 and then to heat it isobarically to temperature T_2 . In practical designs, the air-stream is continuously circulated to ensure saturation. Test instruments draw off air at temperature T_2 and a flow rate that is small in proportion to the main circulation.

4.9.5 Secondary standards

A secondary standard instrument should be carefully maintained and removed from the calibration laboratory only for the purpose of calibration with a primary standard or for intercomparison with other secondary standards. Secondary standards may be used as transfer standards from the primary standards.

A chilled-mirror hygrometer may be used as a secondary standard instrument under controlled conditions of air temperature, humidity and pressure. For this purpose, it should be calibrated from a recognized accredited laboratory, giving uncertainty limits throughout the operational range of the instrument. This calibration must be directly traceable to a primary standard and should be renewed at an appropriate interval (usually once every 12 months).

General considerations for chilled-mirror hygrometers are discussed in section 4.4. This method presents a fundamental technique for determining atmospheric humidity. Provided that the instrument is maintained and operated correctly, following the manufacturer's instructions, it can provide a primary measurement of dew or frost point within limits of uncertainty determined by the correspondence between the mirror surface temperature at the appropriate point of the condensation/evaporation cycle and the temperature registered by the mirror thermometer at the observation time. The Kelvin and Raoult effects upon the condensation temperature must be taken into consideration, and any change of the air pressure resulting from the sampling technique must be taken into account by using the equations given in section 4.4.1.2.

4.9.6 Working standards (and field reference instruments)

A chilled-mirror hygrometer or an Assmann psychrometer may be used as a working standard for comparisons under ambient conditions in the field or the laboratory. For this purpose, it is necessary to have performed comparisons at least at the reference standard level. The comparisons should be performed at least once every 12 months under stable room conditions. The working standard will require a suitable aspiration device to sample the air.

4.9.7 The WMO reference psychrometer

This type of psychrometer is essentially a primary standard because its performance is calculable. However, its main use is as a highly accurate reference instrument, specifically for type-testing other instrument systems in the field. It is intended for use as a free-standing instrument, alongside the screen or other field instruments, and must be made precisely to its general specification and operated by skilled staff experienced in precise laboratory work; careful attention should be given to aspiration and to preventing the wet bulb from being contaminated by contact with fingers or other objects. There are, however, simple tests by which the readings may be validated at any time, and these should be used

frequently during the operation. The psychrometer's description and operating instructions are given in WMO (1992).

4.9.8 Saturated salt solutions

Vessels containing saturated solutions of appropriate salts may be used to calibrate relative humidity sensors. Commonly used salts and their saturation relative humidities at 25°C are as follows:

Barium chloride (BaCl ₂):	90.3 per cent
Sodium chloride (NaCl):	75.3 per cent
Magnesium nitrate (Mg(NO ₃) ₂):	52.9 per cent
Calcium chloride (CaCl ₂):	29.0 per cent
Lithium chloride (LiCl):	11.1 per cent

It is important that the surface area of the solution is large compared to that of the sensor element and the enclosed volume of air so that equilibrium may be achieved quickly; an airtight access port is required for the test sensor. The temperature of the vessel should be measured and maintained at a constant level as the saturation humidity for most salts has a significant temperature coefficient.

Care should be taken when using saturated salt solutions. The degree of toxicity and corrosivity of salt solutions should be known to the personnel dealing with them. The salts listed above may all be used quite safely, but it is nevertheless important to avoid contact with the skin, and to avoid ingestion and splashing into the eyes. The salts should always be kept in secure and clearly labelled containers which detail any hazards involved. Care should be taken when dissolving calcium chloride crystals in water, as much heat is evolved. Section 4.8 deals with chemical hazards in greater detail.

Although the use of saturated salt solutions provides a simple method to adjust some (relative) humidity sensors, such adjustment cannot be considered as a traceable calibration of the sensors. The (nominal) values of salt solutions have, at the moment, generally no traceability to reference standards. Measurements from sensors adjusted by means of the saturated salt solution method should always be checked by calibration standards after adjustment.

ANNEX 4.A

DEFINITIONS AND SPECIFICATIONS OF WATER VAPOUR
IN THE ATMOSPHERE(adapted from the *Technical Regulations* (WMO-No. 49), Volume I, Appendix B)

(1) **The mixing ratio r** of moist air is the ratio of the mass m_v of water vapour to the mass m_a of dry air with which the water vapour is associated:

$$r = \frac{m_v}{m_a} \quad (4.A.1)$$

(2) **The specific humidity, mass concentration or moisture content q** of moist air is the ratio of the mass m_v of water vapour to the mass $m_v + m_a$ of moist air in which the mass of water vapour m_v is contained:

$$q = \frac{m_v}{m_v + m_a} \quad (4.A.2)$$

(3) **Vapour concentration (density of water vapour in a mixture) or absolute humidity:** For a mixture of water vapour and dry air the vapour concentration ρ_v is defined as the ratio of the mass of vapour m_v to the volume V occupied by the mixture:

$$\rho_v = \frac{m_v}{V} \quad (4.A.3)$$

(4) **Mole fraction of the water vapour of a sample of moist air:** The mole fraction x_v of the water vapour of a sample of moist air, composed of a mass m_a of dry air and a mass m_v of water vapour, is defined by the ratio of the number of moles of water vapour ($n_v = m_v/M_v$) to the total number of moles of the sample $n_v + n_a$, where n_a indicates the number of moles of dry air ($n_a = m_a/M_a$) of the sample concerned. This gives:

$$x_v = \frac{n_v}{n_a + n_v} \quad (4.A.4)$$

or:

$$x_v = \frac{r}{0.62198 + r} \quad (4.A.5)$$

where r is merely the mixing ratio ($r = m_v/m_a$) of the water vapour of the sample of moist air.

(5) **The vapour pressure e'** of water vapour in moist air at total pressure p and with mixing ratio r is defined by:

$$e' = \frac{r}{0.62198 + r} p = x_v \cdot p \quad (4.A.6)$$

(6) **Saturation:** Moist air at a given temperature and pressure is said to be saturated if its mixing ratio is such that the moist air can coexist in neutral equilibrium with an associated condensed phase (liquid or solid) at the same temperature and pressure, the surface of separation being plane.

(7) **Saturation mixing ratio:** The symbol r_w denotes the saturation mixing ratio of moist air with respect to a plane surface of the associated liquid phase. The symbol r_i denotes the saturation mixing ratio of moist air with respect to a plane surface of the associated solid phase. The associated liquid and solid phases referred to consist of almost pure water and almost pure ice, respectively, there being some dissolved air in each.

(8) **Saturation vapour pressure in the pure phase:** The saturation vapour pressure e_w of pure aqueous vapour with respect to water is the pressure of the vapour when in a state of neutral equilibrium with a plane surface of pure water at the same temperature and pressure; similarly for e_i with respect to ice; e_w and e_i are temperature-dependent functions only, namely:

$$e_w = e_w(T) \quad (4.A.7)$$

$$e_i = e_i(T) \quad (4.A.8)$$

(9) **Mole fraction of water vapour in moist air saturated with respect to water:** The mole fraction of water vapour in moist air saturated with respect to water, at pressure p and temperature T , is the mole fraction x_{vw} of the water vapour of a sample of moist air, at the same pressure p and the same temperature T , that is in stable equilibrium in the presence of a plane surface of water

containing the amount of dissolved air corresponding to equilibrium. Similarly, x_{vi} will be used to indicate the saturation mole fraction with respect to a plane surface of ice containing the amount of dissolved air corresponding to equilibrium.

(10) **Saturation vapour pressure of moist air:** The saturation vapour pressure with respect to water e'_w of moist air at pressure p and temperature T is defined by:

$$e'_w = \frac{r_w}{0.62198 + r_w} p = x_{vw} \cdot p \quad (4.A.9)$$

Similarly, the saturation vapour pressure with respect to ice e'_i of moist air at pressure p and temperature T is defined by:

$$e'_i = \frac{r_i}{0.62198 + r_i} p = x_{vi} \cdot p \quad (4.A.10)$$

(11) **Relations between saturation vapour pressures of the pure phase and of moist air:** In the meteorological range of pressure and temperature the following relations hold with an error of 0.5 per cent or less:

$$e'_w = e_w \quad (4.A.11)$$

$$e'_i = e_i \quad (4.A.12)$$

(12) **The thermodynamic dewpoint temperature T_d** of moist air at pressure p and with mixing ratio r is the temperature at which moist air, saturated with respect to water at the given pressure, has a saturation mixing ratio r_w equal to the given mixing ratio r .

(13) **The thermodynamic frost-point temperature T_f** of moist air at pressure p and mixing ratio r is the temperature at which moist air, saturated with respect to ice at the given pressure, has a saturation mixing ratio r_i equal to the given ratio r .

(14) **The dewpoint and frost-point temperatures** so defined are related to the mixing ratio r and pressure p by the respective equations:

$$e'_w(p, T_d) = f(p) \cdot e_w(T_d) = x_v \cdot p = \frac{r \cdot p}{0.62198 + r} \quad (4.A.13)$$

$$e'_i(p, T_f) = f(p) \cdot e_i(T_f) = x_v \cdot p = \frac{r \cdot p}{0.62198 + r} \quad (4.A.14)$$

(15)¹ **The relative humidity U_w with respect to water of moist air** at pressure p and temperature T is the ratio in per cent of the vapour mole fraction x_v to the vapour mole fraction x_{vw} which the air would have if it were saturated with respect to water at the same pressure p and temperature T . Accordingly:

$$\begin{aligned} U_w &= 100 \left(\frac{x_v}{x_{vw}} \right)_{p,T} = 100 \left(\frac{px_v}{px_{vw}} \right)_{p,T} \\ &= 100 \left(\frac{e'}{e'_w} \right)_{p,T} \end{aligned} \quad (4.A.15)$$

where subscripts p, T indicate that each term is subject to identical conditions of pressure and temperature. The last expression is formally similar to the classic definition based on the assumption of Dalton's law of partial pressures.

U_w is also related to the mixing ratio r by:

$$U_w = 100 \frac{r}{r_w} \cdot \frac{0.62198 + r_w}{0.62198 + r} \quad (4.A.16)$$

where r_w is the saturation mixing ratio at the pressure and temperature of the moist air.

(16)¹ **The relative humidity U_i with respect to ice of moist air** at pressure p and temperature T is the ratio in per cent of the vapour mole fraction x_v to the vapour mole fraction x_{vi} which the air would have if it were saturated with respect to ice at the same pressure p and temperature T . Corresponding to the defining equation in paragraph 15:

$$U_i = 100 \left(\frac{x_v}{x_{vi}} \right)_{p,T} = 100 \left(\frac{px_v}{px_{vi}} \right)_{p,T} = \left(\frac{e'}{e'_i} \right)_{p,T} \quad (4.A.17)$$

(17) **Relative humidity at temperatures less than 0°C** is to be evaluated with respect to water. The advantages of this procedure are as follows:

- Most hygrometers which are essentially responsive to the relative humidity indicate relative humidity with respect to water at all temperatures;
- The majority of clouds at temperatures below 0°C consist of water, or mainly of water;
- Relative humidities greater than 100 per cent would in general not be observed. This is of

¹ Equations 4.A.15 and 4.A.17 do not apply to moist air when pressure p is less than the saturation vapour pressure of pure water and ice, respectively, at temperature T .

particular importance in synoptic weather messages, since the atmosphere is often super-saturated with respect to ice at temperatures below 0°C;

- (d) The majority of existing records of relative humidity at temperatures below 0°C are expressed on a basis of saturation with respect to water.

(18) *The thermodynamic wet-bulb temperature of moist air* at pressure p , temperature T and mixing ratio r is the temperature T_w attained by the moist air when brought adiabatically to saturation at pressure p by the evaporation into the moist air of liquid water at pressure p and temperature T_w and containing the amount of dissolved air corresponding to equilibrium with saturated air of the same pressure and temperature. T_w is defined by the equation:

$$\begin{aligned} h(p, T, r) + [r_w(p, T_w) - r] h_w(p, T_w) \\ = h(p, T_w, r_w(p, T_w)) \end{aligned} \quad (4.A.18)$$

where $r_w(p, T_w)$ is the mixing ratio of saturated moist air at pressure p and temperature T_w ; $h_w(p, T_w)$ is the enthalpy² of 1 gram of pure water at pressure p and temperature T_w ; $h(p, T, r)$ is the enthalpy of $1 + r_w$ grams of moist air, composed of 1 gram of dry air and r grams of water vapour, at pressure p and temperature T ; and $h(p, T_w, r_w(p, T_w))$ is the enthalpy of $1 + r_w$ grams of saturated air, composed of 1 gram of dry air and r_w grams of water vapour, at pressure p and temperature T_w . (This is a function of p and T_w only and may appropriately be denoted by $h_{sw}(p, T_w)$.)

If air and water vapour are regarded as ideal gases with constant specific heats, the above equation becomes:

$$T - T_w = \frac{[r_w(p, T_w) - r] L_v(T_w)}{c_{pa} + r c_{pv}} \quad (4.A.19)$$

where $L_v(T_w)$ is the heat of vaporization of water at temperature T_w , c_{pa} is the specific heat of dry air at constant pressure; and c_{pv} is the specific heat of water vapour at constant pressure.

Note: Thermodynamic wet-bulb temperature as here defined has for some time been called "temperature of adiabatic saturation" by air-conditioning engineers.

(19) *The thermodynamic ice-bulb temperature of moist air* at pressure p , temperature T and mixing ratio r is the temperature T_i at which pure ice at pressure p must be evaporated into the moist air in order to saturate it adiabatically at pressure p and temperature T_i . The saturation is with respect to ice. T_i is defined by the equation:

$$\begin{aligned} h(p, T, r) + [r_i(p, T_i) - r] h_i(p, T_i) \\ = h(p, T_i, r_i(p, T_i)) \end{aligned} \quad (4.A.20)$$

where $r_i(p, T_i)$ is the mixing ratio of saturated moist air at pressure p and temperature T_i ; $h_i(p, T_i)$ is the enthalpy of 1 gram of pure ice at pressure p and temperature T_i ; $h(p, T, r)$ is the enthalpy of $1 + r$ grams of moist air, composed of 1 gram of dry air and r grams of water vapour, at pressure p and temperature T ; and $h(p, T_i, r_i(p, T_i))$ is the enthalpy of $1 + r_i$ grams of saturated air, composed of 1 gram of dry air and r_i grams of water vapour, at pressure p and temperature T_i . (This is a function of p and T_i only, and may appropriately be denoted by $h_{si}(p, T_i)$.)

If air and water vapour are regarded as ideal gases with constant specific heats, the above equation becomes:

$$T - T_i = \frac{[r_i(p, T_i) - r] L_s(T_i)}{c_p + r c_{pv}} \quad (4.A.21)$$

where $L_s(T_i)$ is the heat of sublimation of ice at temperature T_i .

The relationship between T_w and T_i as defined and the wet-bulb or ice-bulb temperature as indicated by a particular psychrometer is a matter to be determined by carefully controlled experiment, taking into account the various variables concerned, for example, ventilation, size of thermometer bulb and radiation.

² The enthalpy of a system in equilibrium at pressure p and temperature T is defined as $E + pV$, where E is the internal energy of the system and V is its volume. The sum of the enthalpies of the phases of a closed system is conserved in adiabatic isobaric processes.

ANNEX 4.B

FORMULAE FOR THE COMPUTATION OF MEASURES OF HUMIDITY

(see also section 4.1.2)

Saturation vapour pressure:

$$e_w(t) = 6.112 \exp [17.62 t / (243.12 + t)]$$

$$= f(p) \cdot e_w(t)$$

Water (–45 to 60°C) (pure phase) $e'_w(p, t)$
Moist air

$$e_i(t) = 6.112 \exp [22.46 t / (272.62 + t)]$$

Ice (–65 to 0°C) (pure phase)

$$e'_i(p, t) = f(p) \cdot e_i(t)$$

Moist air

$$f(p) = 1.0016 + 3.15 \cdot 10^{-6} p - 0.074 p^{-1}$$

[see note]

Dew point and frost point:

$$t_d = \frac{243.12 \cdot \ln[e' / 6.112 f(p)]}{17.62 - \ln[e' / 6.112 f(p)]}$$

Water (–45 to 60°C)

$$t_f = \frac{272.62 \cdot \ln[e' / 6.112 f(p)]}{22.46 - \ln[e' / 6.112 f(p)]}$$

Ice (–65 to 0°C)

Psychrometric formulae for the Assmann psychrometer:

$$e' = e'_w(p, t_w) - 6.53 \cdot 10^{-4} \cdot (1 + 0.000 944 t_w) \cdot p \cdot (t - t_w)$$

Water

$$e' = e'_i(p, t_i) - 5.75 \cdot 10^{-4} \cdot p \cdot (t - t_i)$$

Ice

Relative humidity:

$$U = 100 e' / e'_w(p, t) \%$$

$$U = 100 e'_w(p, t_d) / e'_w(p, t) \%$$

Units applied:

 t = air temperature (dry-bulb temperature); t_w = wet-bulb temperature; t_i = ice-bulb temperature; t_d = dewpoint temperature; t_f = frost-point temperature; p = pressure of moist air; $e_w(t)$ = saturation vapour pressure in the pure phase with regard to water at the dry-bulb temperature; $e_w(t_w)$ = saturation vapour pressure in the pure phase with regard to water at the wet-bulb temperature; $e_i(t)$ = saturation vapour pressure in the pure phase with regard to ice at the dry-bulb temperature; $e_i(t_i)$ = saturation vapour pressure in the pure phase with regard to ice at the ice-bulb temperature; $e'_w(t)$ = saturation vapour pressure of moist air with regard to water at the dry-bulb temperature; $e'_w(t_w)$ = saturation vapour pressure of moist air with regard to water at the wet-bulb temperature; $e'_i(t)$ = saturation vapour pressure of moist air with regard to ice at the dry-bulb temperature; $e'_i(t_i)$ = saturation vapour pressure of moist air with regard to ice at the ice-bulb temperature; U = relative humidity.

Note: In fact, f is a function of both pressure and temperature, i.e. $f = f(p, t)$, as explained in WMO (1966) in the introduction to Table 4.10. In practice, the temperature dependency ($\pm 0.1\%$) is much lower with respect to pressure (0 to +0.6%). Therefore, the temperature dependency may be omitted in the formula above (see also WMO (1989a), Chapter 10). This formula, however, should be used only for pressure around 1 000 hPa (i.e. surface measurements) and not for upper-air measurements, for which WMO (1966), Table 4.10 should be used.

REFERENCES AND FURTHER READING

- Bindon, H.H., 1965: A critical review of tables and charts used in psychrometry. In: A. Wexler (ed.), *Humidity and Moisture*, Volume 1, Reinhold, New York, pp. 3-15.
- Sonntag, D., 1990: Important new values of the physical constants of 1986, vapour pressure formulations based on the ITS-90 and psychrometer formulae. *Zeitschrift für Meteorologie*, Volume 40, Number 5, pp. 340-344.
- Sonntag, D., 1994: Advancements in the field of hygrometry. *Zeitschrift für Meteorologie*, Volume 3, Number 2, pp. 51-66.
- Wexler, A. (ed.), 1965: *Humidity and Moisture*. Volumes 1 and 3, Reinhold, New York.
- World Meteorological Organization, 1966: *International Meteorological Tables* (S. Letestu, ed.). WMO-No. 188.TP.94, Geneva.
- World Meteorological Organization, 1988: *Technical Regulations*. Volume I, WMO-No. 49, Geneva.
- World Meteorological Organization, 1989a: *WMO Assmann Aspiration Psychrometer Intercomparison* (D. Sonntag). Instruments and Observing Methods Report No. 34, WMO/TD-No. 289, Geneva.
- World Meteorological Organization, 1989b: *WMO International Hygrometer Intercomparison* (J. Skaar, K. Hegg, T. Moe and K. Smedstud). Instruments and Observing Methods Report No. 38, WMO/TD-No. 316, Geneva.
- World Meteorological Organization, 1992: *Measurement of Temperature and Humidity* (R.G. Wylie and T. Lalas). Technical Note No. 194, WMO-No. 759, Geneva.
-

CHAPTER 5

MEASUREMENT OF SURFACE WIND

5.1 GENERAL

5.1.1 Definitions

The following definitions are used in this chapter (see Mazzarella, 1972, for more details).

Wind velocity is a three-dimensional vector quantity with small-scale random fluctuations in space and time superimposed upon a larger-scale organized flow. It is considered in this form in relation to, for example, airborne pollution and the landing of aircraft. For the purpose of this Guide, however, surface wind will be considered mainly as a two-dimensional vector quantity specified by two numbers representing direction and speed. The extent to which wind is characterized by rapid fluctuations is referred to as gustiness, and single fluctuations are called gusts.

Most users of wind data require the averaged horizontal wind, usually expressed in polar coordinates as speed and direction. More and more applications also require information on the variability or gustiness of the wind. For this purpose, three quantities are used, namely the peak gust and the standard deviations of wind speed and direction.

Averaged quantities are quantities (for example, horizontal wind speed) that are averaged over a period of 10 to 60 min. This chapter deals mainly with averages over 10 min intervals, as used for forecasting purposes. Climatological statistics usually require averages over each entire hour, day and night. Aeronautical applications often use shorter averaging intervals (see Part II, Chapter 2). Averaging periods shorter than a few minutes do not sufficiently smooth the usually occurring natural turbulent fluctuations of wind; therefore, 1 min "averages" should be described as long gusts.

Peak gust is the maximum observed wind speed over a specified time interval. With hourly weather reports, the peak gust refers to the wind extreme in the last full hour.

Gust duration is a measure of the duration of the observed peak gust. The duration is determined by the response of the measuring system. Slowly responding systems smear out the extremes and measure long smooth gusts; fast response systems

may indicate sharp wave-front gusts with a short duration.

For the definition of gust duration an ideal measuring chain is used, namely a single filter that takes a running average over t_0 seconds of the incoming wind signal. Extremes detected behind such a filter are defined as peak gusts with duration t_0 . Other measuring systems with various filtering elements are said to measure gusts with duration t_0 when a running average filter with integration time t_0 would have produced an extreme with the same height (see Beljaars, 1987; WMO, 1987 for further discussion).

Standard deviation is:

$$s_u = \sqrt{(u_i - U)^2} = \sqrt{\left(\frac{\sum (u_i^2) - (\sum u_i)^2 / n}{n} \right)} \quad (5.1)$$

where u is a time-dependent signal (for example, horizontal wind speed) with average U and an overbar indicates time-averaging over n samples u_i . The standard deviation is used to characterize the magnitude of the fluctuations in a particular signal.

Time-constant (of a first-order system) is the time required for a device to detect and indicate about 63 per cent of a step-function change.

Response length is approximately the passage of wind (in metres) required for the output of a wind-speed sensor to indicate about 63 per cent of a step-function change of the input speed.

Critical damping (of a sensor such as a wind vane, having a response best described by a second-order differential equation) is the value of damping which gives the most rapid transient response to a step change without overshoot.

Damping ratio is the ratio of the actual damping to the critical damping.

Undamped natural wavelength is the passage of wind that would be required by a vane to go through one period of an oscillation if there were no damping. It is less than the actual "damped" wavelength by a factor $\sqrt{1 - D^2}$ if D is the damping ratio.

5.1.2 Units and scales

Wind speed should be reported to a resolution of 0.5 m s^{-1} or in knots (0.515 m s^{-1}) to the nearest unit, and should represent, for synoptic reports, an average over 10 min. Averages over a shorter period are necessary for certain aeronautical purposes (see Part II, Chapter 2).

Wind direction should be reported in degrees to the nearest 10° , using a 01 ... 36 code (for example, code 2 means that the wind direction is between 15° and 25°), and should represent an average over 10 min (see Part II, Chapter 2, for synoptical purposes). Wind direction is defined as the direction from which the wind blows, and is measured clockwise from geographical north, namely, true north.

“Calm” should be reported when the average wind speed is less than 1 kn. The direction in this case is coded as 00.

Wind direction at stations within 1° of the North Pole or 1° of the South Pole should be reported according to Code Table 0878 in WMO (1995). The azimuth ring should be aligned with its zero coinciding with the Greenwich 0° meridian.

There are important differences compared to the synoptic requirement for measuring and reporting wind speed and direction for aeronautical purposes at aerodromes for aircraft take-off and landing (see Part II, Chapter 2). Wind direction should be measured, namely, from the azimuth setting, with respect to true north at all meteorological observing stations. At aerodromes the wind direction must be indicated and reported with respect to magnetic north for aeronautical observations and with an averaging time of 2 min. Where the wind measurements at aerodromes are disseminated beyond the aerodrome as synoptic reports, the direction must be referenced to true north and have an averaging time of 10 min.

5.1.3 Meteorological requirements

Wind observations or measurements are required for weather monitoring and forecasting, for wind-load climatology, for probability of wind damage and estimation of wind energy, and as part of the estimation of surface fluxes, for example, evaporation for air pollution dispersion and agricultural applications. Performance requirements are given in Part I, Chapter 1, Annex 1.B. An accuracy for horizontal speed of 0.5 m s^{-1} below 5 m s^{-1} and better than 10 per cent above 5 m s^{-1} is usually sufficient. Wind direction should be measured with an accuracy of 5° .

Apart from mean wind speed and direction, many applications require standard deviations and extremes (see section 5.8.2). The required accuracy is easily obtained with modern instrumentation. The most difficult aspect of wind measurement is the exposure of the anemometer. Since it is nearly impossible to find a location where the wind speed is representative of a large area, it is recommended that estimates of exposure errors be made (see section 5.9).

Many applications require information about the gustiness of the wind. Such applications provide “nowcasts” for aircraft take-off and landing, wind-load climatology, air pollution dispersion problems and exposure correction. Two variables are suitable for routine reading, namely the standard deviation of wind speed and direction and the 3 s peak gust (see Recommendations 3 and 4 (CIMO-X) (WMO, 1990)).

5.1.4 Methods of measurement and observation

Surface wind is usually measured by a wind vane and cup or propeller anemometer. When the instrumentation is temporarily out of operation or when it is not provided, the direction and force of the wind may be estimated subjectively (the table below provides wind speed equivalents in common use for estimations).

The instruments and techniques specifically discussed here are only a few of the more convenient ones available and do not comprise a complete list. The references and further reading at the end of this chapter provide a good literature on this subject.

The sensors briefly described below are cup-rotor and propeller anemometers, and direction vanes. Cup and vane, propeller and vane, and propellers alone are common combinations. Other classic sensors, such as the pitot tube, are less used now for routine measurements but can perform satisfactorily, while new types being developed or currently in use as research tools may become practical for routine measurement with advanced technology.

For nearly all applications, it is necessary to measure the averages of wind speed and direction. Many applications also need gustiness data. A wind-measuring system, therefore, consists not only of a sensor, but also of a processing and recording system. The processing takes care of the averaging and the computation of the standard deviations and extremes. In its simplest form, the processing can be done by writing the wind signal with a pen recorder and estimating the mean and extreme by reading the record.

Wind speed equivalents

Beaufort scale number and description	Wind speed equivalent at a standard height of 10 m above open flat ground				Specifications for estimating speed over land
	(kn)	(m s ⁻¹)	(km h ⁻¹)	(mi h ⁻¹)	
0 Calm	< 1	0 – 0.2	< 1	< 1	Calm; smoke rises vertically
1 Light air	1 – 3	0.3 – 1.5	1 – 5	1 – 3	Direction of wind shown by smoke-drift but not by wind vanes
2 Light breeze	4 – 6	1.6 – 3.3	6 – 11	4 – 7	Wind felt on face; leaves rustle; ordinary vanes moved by wind
3 Gentle breeze	7 – 10	3.4– 5.4	12 – 19	8 – 12	Leaves and small twigs in constant motion; wind extends light flag
4 Moderate breeze	11 – 16	5.5 – 7.9	20 – 28	13 – 18	Raises dust and loose paper; small branches are moved
5 Fresh breeze	17 – 21	8.0 – 10.7	29 – 38	19 – 24	Small trees in leaf begin to sway, crested wavelets form on inland waters
6 Strong breeze	22 – 27	10.8 – 13.8	39 – 49	25 – 31	Large branches in motion; whistling heard in telegraph wires; umbrellas used with difficulty
7 Near gale	28 – 33	13.9 – 17.1	50 – 61	32 – 38	Whole trees in motion; inconvenience felt when walking against the wind
8 Gale	34 – 40	17.2 – 20.7	62 – 74	39 – 46	Breaks twigs off trees; generally impedes progress
9 Strong gale	41 – 47	20.8 – 24.4	75 – 88	47 – 54	Slight structural damage occurs (chimney-pots and slates removed)
10 Storm	48 – 55	24.5 – 28.4	89 – 102	55 – 63	Seldom experienced inland; trees uprooted; considerable structural damage occurs
11 Violent storm	56 – 63	28.5 – 32.6	103 – 117	64 – 72	Very rarely experienced; accompanied by widespread damage
12 Hurricane	64 and over	32.7 and over	118 and over	73 and over	

5.2 ESTIMATION OF WIND

In the absence of equipment for measuring wind, the observations must be made by estimation. The errors in observations made in this way may be large, but, provided that the observations are used with caution, the method may be justified as providing data that would otherwise not be available in any way. If either temporarily or permanently the wind data of some stations are obtained by estimation instead of measurement, this fact should be documented in station records made accessible to data users.

5.2.1 Wind speed

Estimates are based on the effect of the wind on movable objects. Almost anything which is supported so that it is free to move under the influence of the wind can be used, but the descriptive specifications given in the Beaufort scale of wind force, as reproduced in the table, will be found especially useful.

In order to make the estimates, the observer (and the wind-susceptible object) must stand on flat open terrain as far as possible from obstructions.

It must always be remembered that even small obstructions cause serious changes in wind speed and deviations in wind direction, especially at their lee side.

5.2.2 **Wind direction**

In the case of an absence of instruments, or when the instrumental equipment is unserviceable, the direction should be estimated by observing the drift of smoke from an elevated chimney, the movement of leaves, and so on, in an open situation, or a streamer or pennant fixed to a tall flagstaff. In addition, the wind drogue at an airport may be used when the wind speed is sufficient to move such a device.

Whichever of these aids is used, errors due to perspective are liable to be made unless the observer stands vertically below the indicator. Care should be taken to guard against mistaking local eddies caused by buildings, and the like, for the general drift of the wind.

In an open location, the surface wind direction can be estimated rather accurately by facing the wind. The direction of the movement of clouds, however low, should not be taken into account.

5.2.3 **Wind fluctuations**

No attempt should be made to estimate peak gusts or standard deviations without proper instruments and recording devices.

5.3 **SIMPLE INSTRUMENTAL METHODS**

At stations where orthodox anemometers cannot be installed it may be possible to provide some very low-cost, simple instruments that help the observer take measurements that are somewhat more reliable than those obtained by unaided estimation.

5.3.1 **Wind speed**

Simple hand-held anemometers, if they are used, should be set up and read in accordance with the maker's instructions. The measurement should be taken from a point well exposed to the wind, and not in the lee of obstructions such as buildings, trees and hillocks. If this is not possible, the measurement point should be a good distance from obstructions, namely at least 10 times the

obstruction height and upwind or sideways by at least twice the obstruction height.

5.3.2 **Wind direction**

Direction may be estimated from a vane (or banner) mounted on a pole that has pointers indicating the principal points of the compass. The vane is observed from below, and wind direction may be estimated to the nearest of the 16 points of the compass. If the vane oscillates in the wind, the wind direction must be estimated as the average direction about which the oscillations occur.

5.4 **CUP AND PROPELLER SENSORS**

Cup and propeller anemometers are commonly used to determine wind speed and consist of two sub-assemblies: the rotor and the signal generator. In well-designed systems, the angular velocity of the cup or propeller rotor is directly proportional to the wind speed, or, more precisely, in the case of the propeller rotor, to the component of the wind speed parallel to the axis of rotation. Also, in well-designed anemometers, the calibration linearity is independent of air density, has good zero and range stability, and is easily reproduced in a manufacturing process. Near the starting threshold, say for wind speeds of less than 4 m s^{-1} , the calibration of cup anemometers can deviate substantially from linearity, if the arm connecting the cup to the rotation axis is much longer than the diameter of the cup (Patterson, 1926).

The nature of the response of the cup and propeller-type wind-speed sensors to changes in wind speed can be characterized by a response length, the magnitude of which is directly proportional to the moment of inertia of the rotor and, in addition, depends on a number of geometric factors (Busch and Kristensen, 1976; Coppin, 1982).

For almost all cup and propeller-type wind sensors, the response is faster for acceleration than for deceleration, so that the average speed of these rotors overestimates the actual average wind speed. Moreover, vertical velocity fluctuations can cause overspeeding of cup anemometers as a result of reduced cup interference in oblique flow (MacCready, 1966). The total overspeeding can be as much as 10 per cent for some designs

and turbulent wind conditions (cup anemometers at 10 m height with a response length of 5 m over very rough terrain; Coppin, 1982). This effect can be minimized by choosing fast-response anemometers, either cup anemometers of a design verified as having a good cosine response or propeller vanes that have virtually no vertical component of overspeeding. In case that performance cannot be investigated in a wind tunnel, operational anemometers can be compared in the field with a calibrated anemometer (Albers, Klug and Westermann, 2000).

Since both cup and propeller rotors turn with an angular velocity that is directly proportional to speed or to the axial component, they are particularly convenient for driving a wide variety of signal generators. Alternating and direct current generators, optical and magnetic pulse generators, and turn-counting dials and registers have been used (WMO, 2001). The choice of signal generator or transducer depends largely on the type of data processor and read-out to be used. Care should be taken to ensure that the bearings and signal generator have low starting and running frictional torques, and that the moment of inertia of the signal generator does not reduce the response too much. In cases of long-distance transmission, voltage signals decrease due to cable resistance losses and are therefore inferior to pulse frequency signals, which are not so affected during transmission.

The required and achievable characteristics for wind-speed sensors are included in Part I, Chapter 1, Annex 1.B.

5.5 WIND-DIRECTION VANES

For the purpose of obtaining a satisfactory measurement, a wind vane will be suitable if it is well balanced so as not to have a preferred position in case the axis is not vertical. Multiple vane fins should preferably be parallel to the vane axis, because a vane with two fins at angles $> 10^\circ$ to its axis has two equilibrium positions which each differ significantly from the real wind direction (Wieringa and van Lindert, 1971).

The response of the usual underdamped wind vane to a sudden change in wind direction is normally characterized by overshoot and oscillation about its true position, with the amplitude decreasing approximately exponentially. Two variables are

used to define this response: the “undamped natural frequency” or “wavelength” and the “damping ratio”, the ratio of the actual damping to the critical damping (MacCready, 1966; Mazzarella, 1972). A damping ratio between 0.3 and 0.7 is considered to be good and as having not too much overshoot, and a reasonably fast response (Wieringa, 1967). Where a relatively long period average is to be computed from data captured at short intervals, it is self-evident that lower damping ratios may be acceptable.

The signal generator is essentially a shaft-angle transducer, and many varieties have been employed. Potentiometers, alternating and direct current synchros, digital angle-encoder discs, direct reading dials and rotary switches have been used to advantage. The choice of signal generator is largely a matter of the type of data processor and read-out used. Care should be taken to ensure that the bearings and signal generator have low starting and running frictional torques. The simplest recording method is to have a sheet mounted around a cylinder rotating with the vane axis, on which a writing instrument slowly travels downward.

The absolute accuracy of direction measurement also depends on the care with which the instrument has been aligned to true north. The required and achievable characteristics for wind-direction vanes are included in Part I, Chapter 1, Annex 1.B.

5.6 OTHER WIND SENSORS

Many physical principles can be used to measure wind speed and direction, all of which have their own merits and problems. New systems often have been developed for specific purposes, such as small-scale fluctuations and air pollution studies (see for example, Smith (1980)). The following are other types of sensors:

- (a) Pitot tube anemometers, which measure the overpressure in a tube that is kept aligned with the wind vector by means of a direction vane (see Gold (1936) and WMO (1984*a*) for a description of the Dines anemometer). The Dines linearizing recording system deals with the speed averaging problem caused by the quadratic relation between wind speed and pressure, and it also provides useful gustiness records without requiring electrical power;
- (b) Sonic anemometers, which measure the time between emission and reception of an

ultrasonic pulse travelling over a fixed distance (Kaimal, 1980). Because sonic anemometers have no moving parts owing to their principle, they have high durability and little accuracy deterioration. Some types of recent sonic anemometers can measure wind even in rainy conditions. The costs of some types of instruments mentioned above have become comparable to those of the propeller-vane anemometers;

- (c) Hot-disc anemometers are recently developed solid-state instruments which measure the temperature gradient across a chip arrangement. This provides both wind speed and direction at accuracies within the specification of Part I, Chapter 1, Annex 1.B (Van Oudheusden and Huijsing, 1991; Makinwa, Huijsing and Hagedoorn, 2001). They are sturdy, and steady in calibration, but operational experience is limited so far;
- (d) Hot-wire anemometers measure the cooling of thin heated wires. Operationally they are rather unreliable, both because of excessive fragility and because their calibration changes rather fast in unclean or wet surroundings. They are not recommended for use in precipitation;
- (e) Antique swinging-plate vanes are a little better than no instrument at all;
- (f) Remote wind-sensing techniques with sound (sodar), light (lidar) or electromagnetic waves (radar) are uncommon in routine meteorological networks and will not be discussed in this Guide. Details are provided in Lenschow (1986).

5.7 SENSORS AND SENSOR COMBINATIONS FOR COMPONENT RESOLUTION

Propellers which respond only to the wind speed component that is parallel to the axis of rotation of the rotor can be mounted orthogonally to produce two read-outs which are directly proportional to the components in the axis directions. Other sensors, such as twin-axis sonic anemometers, perform the same function at the expense of more sophisticated electronic adjuncts. Orthogonal propellers have the disadvantage that exact cosine response (namely, pure component sensitivity) is difficult to attain. A cup anemometer/vane combination or a propeller vane can also be used as a component device when the velocity components are computed from the measured wind speed and direction.

5.8 DATA-PROCESSING METHODS

Signals from anemometer/vane combinations can be processed and averaged in many different ways. Before considering the aspects of the entire wind-measuring chain (exposure, sensing, transmission, filtering, recording and processing), it is useful to discuss the problem of averaging. This Guide deals with the following outputs: averaged horizontal wind (components or speed/direction), standard deviations and peak gust.

5.8.1 Averaging

The averaging of wind vectors or their components is straightforward in principle, but there are a few problems associated with it. The first is that the mean vector speed in the average wind direction U is less than the average of all instantaneous wind speeds by a small amount, generally a few per cent (MacCready, 1966; Wieringa 1980a). If necessary, this may be corrected if the standard deviation of wind direction s_d is measured; for the ratio of U , and the averaged instantaneous wind speeds is (Frenkiel, 1951):

$$U/\sqrt{(u_i^2 + v_i^2)} = 1 - s_d^2/2 \quad (5.2)$$

This effect of crosswind turbulence is often confused with the overestimation (overspeeding), causing distortion in the standard deviation s_u (see section 5.4).

The second problem is the discontinuity of the wind direction between 0 and 360°. This problem can be solved either by recording on a cylinder or by extending the recorder range (for example to 540° with an automatic device switching the range from 0 to 360 and from 540 to 180), or by a computer algorithm that makes successive samples continuous by adding or subtracting 360° when necessary. The fact that the first-order response of a cup anemometer and the second-order response of a vane cannot be fully matched is a problem of minor importance, because the response differences are reflected only in the high-frequency part of the fluctuations.

From the fundamental point of view, component averaging is preferable over the independent averaging of speed and direction. However, the differences are very small and, for most applications, component averages can easily be derived from average speed and direction. This also applies to the corresponding standard deviations. From the technical point of view, the

independent treatment of speed and direction is preferable for a number of reasons. First of all, the processing of the signal for speed and direction is independent, which implies that the operation of one instrument can continue even when the other drops out. Secondly, this data reduction is simpler than in those cases where components have to be computed. Lastly, the independent treatment of speed and direction is compatible with common usage (including SYNOP and SHIP coding).

The averages of horizontal wind speed can be obtained with a number of both mechanical and electrical devices. Perhaps the simplest example is a mechanical rotation-counting register on a cup anemometer commonly used to measure the passage of wind during a chosen averaging time interval. At the other end of the complexity spectrum, electrical pulse generators drive special-purpose digital processors, which can easily calculate averages, peak gusts and standard deviations.

If wind speed and direction are recorded as continuous graphs, an observer can estimate 10 min averages fairly accurately from a pen recording. The recorded wind trace can also be used to read peak gusts. The reading of dials or meters gives a feel for the wind speed and its variability, but is subject to large errors when averages are needed. Instantaneous read-outs are, therefore, less suitable to obtain 10 min averages for standard weather reports.

5.8.2 **Peak gusts and standard deviations**

The computation or recording of wind fluctuations is extremely sensitive to the dynamic response of all the elements of the measuring chain, including response length and damping ratio of the sensors. Additionally, the dynamic response of the system as a whole determines the duration of peak gusts, as defined in section 5.1.1. Slowly responding systems spread out the extremes and indicate wide gusts with small amplitude, whereas fast-response systems record high and narrow peaks (gusts of short duration). It is clear that the dynamic response of wind systems has to be carefully designed to obtain gusts or standard deviations that are accurate, reliable and compatible between stations.

Before specifying the appropriate response characteristics of wind-measuring systems, it is necessary to define the gust duration as required by the application. Wind extremes are mainly used for warning purposes and for the climatology of extreme loads on buildings, constructions and aircraft. It is important to realize that the shortest gusts have neither

the time nor the horizontal extent to exert their full damaging effect on large constructions. WMO (1987) concludes that a gust duration of about 3 s accommodates most potential users. Gusts that persist for about 3 s correspond to a "wind run" (duration multiplied by the average wind speed) of the order of 50 to 100 m in strong wind conditions. This is sufficient to engulf structures of ordinary suburban/urban size and to expose them to the full load of a potentially damaging gust.

The standard deviation of wind direction and wind speed can easily be computed with microcomputer-based equipment by taking samples of the signals at intervals of about 1 s. Sampling frequencies should not be too great, because the sensor itself provides smoothing over a multiple of its response distance (Wieringa, 1980*b*). A sampling frequency of 0.25 Hz is suitable in most cases, but depends on the response distance of the sensor and the wind speed. Part III, Chapter 2, includes a detailed discussion of the theory of sampling sensor signals.

Simultaneous computation of the standard deviation of the horizontal wind speed over 10 min together with the detection of gusts with a duration of a few seconds gives interesting requirements for electronic filters. The gusts are most critical with regard to filtering, so in practice the system is optimized for them. Any low-pass filter used for the detection of peak gusts measured by fast anemometers, smoothing over a few seconds, may reduce the standard deviation by up to 10 per cent. This can be corrected if the filtering variables in the measuring chain are well documented. Often, in practice, the reduction is less because the standard deviation increases if the average wind speed shows a positive or negative trend. Alternatively, the unfiltered signal can be recorded separately for the purpose of measuring an unbiased standard deviation. In the next section, recommendations are made for wind-measuring systems with exact values for the filter variables.

In order to determine peak gusts accurately, it is desirable to sample the filtered wind signal every 0.25 s (frequency 4 Hz). Lower sampling frequencies can be used, but it should be realized that the estimate of the extreme will generally be lower as the extreme in the filtered signal may occur between samples.

Apart from the wind vane inertial damping, any further filtering should be avoided for wind direction. This means that the standard deviation of wind direction can be determined within 2 per cent with most wind vanes.

Accurate computation of the standard deviation of wind direction requires a minimum resolution of the digitization process, which is often done on the shaft of the vane by means of a digital encoder. A 7 bit resolution is quite sufficient here because then a 5° unit for the standard deviation can still be measured with an accuracy of 1 per cent (WMO, 1987).

5.8.3 Recommendations for the design of wind-measuring systems¹

Wind-measuring systems can be designed in many different ways; it is impossible to cover all design options in this Guide. Two common examples are given here, one with mainly analogue signal treatment and the other with digital signal processing (WMO, 1987).

The first system consists of an anemometer with a response length of 5 m, a pulse generator that generates pulses at a frequency proportional to the rotation rate of the anemometer (preferably several pulses per rotation), a counting device that counts the pulses at intervals of 0.25 s, and a microprocessor that computes averages and standard deviation over 10 min intervals on the basis of 0.25 s samples. The extreme has to be determined from 3 s averages, namely, by averaging over the last 12 samples. This averaging has to be done every 0.25 s (namely, overlapping 3 s averages every 0.25 s). The wind direction is measured with a vane that has an undamped wavelength of 5 m, a damping ratio of 0.3, and a 7 bit digital encoder that is sampled every second. Averages and standard deviations are computed over 10 min intervals, where successive samples are checked for continuity. If two successive samples differ by more than 180°, the difference is decreased by adding or subtracting 360° from the second sample. With response lengths of 5 m for the anemometer and the wind vane (damping ratio 0.3, undamped wavelength 10 m), the standard deviations of wind speed and wind direction are reduced by about 7 and 2 per cent, respectively. The gust duration corresponding to the entire measuring chain (as defined in section 5.1.1) is about 3 s.

The second system consists of an anemometer with a response length of 5 m, a voltage generator producing a voltage proportional to the rotation rate of the anemometer, analogue-to-digital conversion every second, and the digital processing of samples. The wind-direction part consists

of a vane with an undamped wavelength of 5 m and a damping ratio of 0.3, followed by analogue-to-digital conversion every second and digital computation of averages and standard deviations. To determine peak gusts the voltage is filtered with a first-order filter with a time-constant of 1 s and analogue-to-digital conversion every 0.25 s. With regard to filtering, this system is slightly different from the first one in that standard deviations of wind speed and direction are filtered by 12 per cent and 2 per cent, respectively, while again the gust duration is about 3 s. This system can also be operated with a pen recorder connected to the analogue output instead of the analogue-to-digital converter. Only averages and extremes can be read now, and the gust duration is about 3 s, unless the pen recorder responds more slowly than the first-order filter.

The signal-processing procedure, as described above, is in accordance with Recommendation 3 (CIMO-X) (WMO, 1990) and guarantees optimal accuracy. The procedure, however, is fairly complicated and demanding as it involves overlapping averages and a relatively high sampling frequency. For many applications, it is quite acceptable to reduce the sampling rate down to one sample every 3 s, provided that the wind signal has been averaged over 3 s intervals (namely, non-overlapping averaging intervals). The resulting gust duration is about 5 s and the reduction in standard deviation is 12 per cent (Beljaars, 1987; WMO, 1987).

5.9 EXPOSURE OF WIND INSTRUMENTS

5.9.1 General problems

Wind speed increases considerably with height, particularly over rough terrain. For this reason, a standard height of 10 m above open terrain is specified for the exposure of wind instruments. For wind direction, the corresponding shift over such a height interval is relatively small and can be ignored in surface wind measurements. An optimum wind observation location is one where the observed wind is representative of the wind over an area of at least a few kilometres, or can easily be corrected to make it representative.

For terrain that is uneven, contains obstacles, or is non-homogeneous in surface cover, both wind speed and direction can be affected considerably. Corrections are often possible, and the tools to compute such corrections are becoming available.

¹ Recommended by the Commission for Instruments and Methods of Observation at its tenth session (1989).

To improve the applicability of wind data, essential information to perform such corrections should be transmitted to the users in addition to the direct measurements.

5.9.2 Anemometers over land

The standard exposure of wind instruments over level, open terrain is 10 m above the ground. Open terrain is defined as an area where the distance between the anemometer and any obstruction is at least 10 times the height of the obstruction. Wind measurements that are taken in the direct wake of tree rows, buildings or any other obstacle are of little value and contain little information about the unperturbed wind. Since wakes can easily extend downwind to 12 or 15 times the obstacle height, the requirement of 10 obstruction heights is an absolute minimum. In practice, it is often difficult to find a good or even acceptable location for a wind station. The importance of optimizing the location can hardly be overstressed; nonetheless, it is difficult to give universal guidelines.

Two aspects are very important. First, the sensors should be kept away from local obstructions as much as possible. When wind measurements are taken on the side of masts or towers rather than at their top, the instruments should be placed on booms with a length of at least three mast or tower widths (Gill and others, 1967). When wind instruments are placed on top of a building, they should be raised at least one building width above the top. Secondly, the local situation should be well documented (Wieringa, 1983). There should at least be a map of the station surroundings within a radius of 2 km, documenting obstacle and vegetation locations and height, terrain elevation changes, and so forth. Changes in the surroundings, such as the construction of buildings or growth of trees nearby, should be explicitly recorded in station log-books. Station instrumentation should be specified in detail.

Where standard exposure is unobtainable, the anemometer may be installed at such a height that its indications should not be too much affected by local obstructions and represent as far as possible how the wind at 10 m would be if there were no obstructions in the vicinity. If the terrain varies little with azimuth, this may be effected by placing the anemometer at a height exceeding 10 m by an amount depending on the effective surface roughness length z_0 of the surroundings (see the annex): about 13 m if $z_0 = 0.1$ m, and about 19 m if $z_0 = 0.5$ m. Wieringa

(1980*b*) shows that the strategy of anemometer height increase does not work well if local sheltering varies strongly with azimuth. Simple calculation procedures now exist to determine the effect of local topography (Walmsley and others, 1990), and the climatology of the gustiness records can be used to determine exposure corrections in inhomogeneous surroundings (Verkaik, 2000). Evans and Lee (1981) and Grimmond and others (1998) discuss the problem in urban areas (see also Part II, Chapter 11).

In freezing weather, special precautions must be taken to keep the wind sensors free from sleet and ice accumulations. In some localities it may be desirable to provide some form of artificial heating for the exposed parts such as a thermostatically controlled infrared radiator. Sleet and ice shields have been designed for particular types of wind equipment (see Curran and others, 1977).

5.9.3 Anemometers at sea

There is an increasing requirement for instrumental measurements of wind over the sea, especially by means of automatic unattended systems (see also Part II, Chapter 4). This task presents special problems since the standard exposure height of 10 m specified for land use cannot always be achieved in a marine environment owing to the state of the sea and/or tidal height variation. The obvious extrapolation of the exposure criteria for land sites leads to the idea that, on moored buoys, the anemometer should be mounted 10 m above the waterline of the buoy. However, other sources of error are often more significant than those arising from different exposure heights (for a review, see WMO, 1981). On fixed platforms and ships, it is of the utmost importance that wind sensors be exposed sufficiently high above the platform and its superstructure to avoid the often extensive influence of the platform on the local wind structure. In general, it is never safe to assume that a wind sensor is unaffected by the platform structure, even if it is exposed at least 10 m above the height of the tallest obstruction on the platform, unless the platform is relatively small. WMO (1981) concludes that, at sea, good exposure should have higher priority in obtaining accurate and useful measurements than standardization of the measurements at 10 m (WMO, 1989). Despite careful siting, it is often impossible in practice to avoid exposure errors. In order to allow height and flow distortion corrections to be made, it is very important to keep a record and detailed information about anemometer location and platform or ship type (shape, dimension). If wind speed is measured at a height significantly greater than 10 m

(namely, when the appropriate reduction factor would be >1.2), a reduction to the 10 m level should be performed according to the procedures recommended in the following paragraph, and using the constant for “open sea” in the table of the annex.

5.9.4 Exposure correction

Surface wind measurements without exposure problems hardly exist. The requirement of open, level terrain is difficult to meet, and most wind stations over land are perturbed by topographic effects or surface cover, or by both (WMO, 1987; Wieringa, 1996).

It is clear that exposure errors pose problems to users of wind data and often make the data useless. This problem is particularly serious in numerical forecast models where there is a tendency to analyse the wind and pressure fields separately. Surface winds, however, can be used for initialization only if they are representative of a large area. This means that errors due to local exposure and/or non-standard measurement height must be removed.

The correction of wind readings for local exposure can be performed only with measurements of reasonable quality at locations that are not too rough ($z_0 \leq 0.5$ m) and reasonably level. No attempt should be made to correct measurements that have hardly any relation to a regional average. For example, a wind station in a deep valley, where the flow is dominated by katabatic effects, may be important for local forecasts, but cannot be used as a regionally representative wind.

If U is the wind speed measured at height z , the corrected wind speed U_c which would be indicated locally at 10 m above terrain with roughness z_0 follows from:

$$U_c = U \cdot C_F \cdot C_T \cdot \frac{\ln(10/z_{0u})}{\ln(z/z_{0u})} \cdot \frac{\ln(60/z_{0u}) \ln(10/z_0)}{\ln(10/z_{0u}) \ln(60/z_0)} \quad (5.3)$$

where C_F is the flow distortion correction; C_T is the correction factor due to topographic effects z_{0u} is the effective roughness length of the terrain upstream of the measurement station, and z_0 is roughness length in the application (for example, a grid box value in a numerical forecast model). In this expression, z , z_0 and z_{0u} are specified in metres. The different correction terms represent the following:

(a) Flow distortion: The correction factor C_F accounts for flow distortion by nearby big objects. This is particularly important for anemometers on buildings, ships, and platforms

at sea. The best way of finding C_F as a function of wind direction is by means of model simulation in a wind tunnel (Mollo-Christensen and Seesholtz, 1967). Estimates based on potential flow around simple configurations can also be applied (Wyngaard, 1981; WMO, 1984b). For measurements on top of a free-standing mast, flow distortion is negligible ($C_F = 1$).

- (b) Topographic correction: This correction accounts for terrain height effects around the wind station. C_T is the ratio of the regionally averaged wind speed (averaged over ridges and valleys at 10 m above local terrain) and the wind speed measured at the wind station. In the example of an isolated hill with a station at the top of the hill, C_T should be less than 1 to correct for the speed-up induced by the hill, to make the result representative of the area rather than of the hill top only. C_T equals 1 for flat terrain. For isolated hills and ridges, estimates of C_T can be made with the help of simple guidelines (Taylor and Lee, 1984). In more complicated topography, model computations are needed on the basis of detailed height contour maps of the terrain surrounding the wind stations (Walmsley and others, 1990). Such computations are fairly complicated but need to be done only once for a single station and lead to a semi-permanent table of C_T as a function of wind direction.
- (c) Non-standard measurement height: This effect is simply included in the U_c formula by assuming a logarithmic profile combined with the roughness length z_{0u} of the upstream terrain. For stations over sea, this reduction to standard height can be important, but stability corrections are relatively small there, justifying the logarithmic form of the reduction.
- (d) Roughness effects: Upstream roughness effects as well as the effects of surface obstacles can be corrected by extrapolating the wind speed logarithmic profile to a height of 60 m with the station specific effective roughness length z_{0u} and by interpolating back to 10 m with the roughness length z_0 necessary for the application. The roughness length z_{0u} should be representative of a 2 km fetch upwind of the wind station; the value usually depends on wind direction. The annex discusses how to estimate z_{0u} .

If flow distortion and topography problems are negligible or have been corrected, apply the (c) to (d) exposure correction by formula 5.3 towards

$z = 10$ m and $z_0 = 0.03$ m. Corrected wind speeds then will be equivalent to those which would have been measured at a local hypothetical wind station conforming fully with WMO requirements (10 m over open terrain). Wind speeds corrected in this way are called potential wind speeds (WMO, 2001). Two comments are appropriate here. First, the extrapolation height of 60 m should not be seen as a very firm value. Heights between 40 and 80 m would have been acceptable; 60 m is about the correct magnitude in relation to the 2 km fetch for which z_{0u} is representative and has proved to give satisfactory results (Wieringa, 1986). Secondly, stability-related changes in the wind profile cannot be neglected over the height range from 10 to 60 m, but the effect of stability is relatively small in the present formulation because the stability corrections in the transformations upwards and downwards cancel out. A practical example of the application of wind measurement correction in an operational context is given in WMO (2000) and WMO (2001). Although most of the exposure correction can be directly applied to the measurements, both unadjusted (Level I) data and adjusted (Level II) data are to be disseminated.

5.10 CALIBRATION AND MAINTENANCE

A fully reliable calibration of cup, propeller and vane anemometers is possible only in a wind tunnel; the performance of such instruments is now well known

and the manufacturer's calibration can be relied upon for most purposes, when the instrument is in good condition. Wind-tunnel tests are useful for special projects or for type-testing new models.

In the field, anemometers are prone to deterioration and regular inspections are advisable. A change in sensor characteristics leading to a deterioration in wind data quality may occur as a result of physical damage, an increase in bearing friction from the ingress of dust, corrosion, or degradation of the transduction process (for example, a reduction in the output of a cup or propeller generator as a result of brush wear).

The inspection of analogue traces will show faults as indicated by incorrect zero, stepped traces due to friction, noise (which may be evident at low wind speeds), low sensitivity (at low speeds), and irregular or reduced variability of recorded wind.

Instruments should be inspected for physical damage, by checking the zero of the anemometer system by holding the cups or propeller, and by checking vane orientation by holding it fixed in a predetermined position or positions. Repairs to the sensors are usually only practicable in a workshop.

System checks should regularly be carried out on the electrical and electronic components of electrical recording or telemetering instruments. Zero and range checks should be made on both the speed and direction systems.

ANNEX

THE EFFECTIVE ROUGHNESS LENGTH

For the purpose of exposure correction, a roughness length z_0 that represents the terrain over 2 km of upstream fetch is needed as a function of wind direction. The quality of the roughness correction is very much dependent on the accuracy of this roughness length.

Over sea, the task is relatively simple because of the uniform fetch. The so-called Charnock relation can be applied. It expresses the sea surface roughness to the friction velocity u^* and the gravitational acceleration g by means of $z_{0u} = \alpha u^{*2}/g$, where α is an empirical constant approximately equal to 0.014. The friction velocity relates to the neutral wind profile by means of $U(z) = (u^*/\kappa) \ln(z/z_{0u})$, where κ is the Von Karman constant (0.4) and z is the measurement height. These two equations have to be solved iteratively, which can be done by starting with $z_{0u} = 0.0001$, computing u^* from the log-profile, evaluating z_{0u} again, and repeating this a few times.

The surface roughness length over land depends on the surface cover and land use and is often difficult to estimate. A subjective way of determining z_{0u} is by a visual survey of the terrain around the wind station with the help of the table below, the validity of which has been recently corroborated (Davenport and others, 2000). Choosing wind direction sectors of 30° up to a distance of 2 km is most convenient. With very non-homogeneous fetch conditions, an effective roughness should be determined by averaging $\ln(z_{0u})$ rather than z_{0u} itself.

The best way of determining z_{0u} is with the help of about one year of climatology of the standard deviations. The standard deviations of wind speed and wind direction are related to the upstream roughness over a few kilometres and can be used for an objective estimate of z_{0u} . Both the standard deviation of wind speed s_u and the standard deviation of wind direction s_d (in radians) can be employed by means of the following formulae:

$$s_u/U = c_u \kappa [\ln(z/z_{0u})]^{-1} \quad \text{A.1}$$

$$s_d/U = c_v \kappa [\ln(z/z_{0u})]^{-1} \quad \text{A.2}$$

where $c_u = 2.2$ and $c_v = 1.9$ and $\kappa = 0.4$ for unfiltered measurements of s_u and s_d . For the measuring systems

described in section 5.8.3, the standard deviation of wind speed is filtered by about 12 per cent, and that of wind direction by about 2 per cent, which implies that c_u and c_v reduce to 1.94 and 1.86, respectively. In order to apply the above equations, it is necessary to select strong wind cases ($U > 4 \text{ m s}^{-1}$) and to average σ_u/U and/or σ_θ over all available data per wind sector class (30° wide) and per season (surface roughness depends, for example, on tree foliage). The values of z_{0u} can now be determined with the above equations, where comparison of the results from σ_u and σ_θ give some idea of the accuracy obtained.

In cases where no standard deviation information is available, but the maximum gust is determined per wind speed averaging period (either 10 min or 1 h), the ratios of these maximum gusts to the averages in the same period (gust factors) can also be used to determine z_{0u} (Verkaik, 2000). Knowledge of system dynamics, namely, the response length of the sensor and the response time of the recording chain, is required for this approach.

**Terrain classification from Davenport (1960)
adapted by Wieringa (1980b) in terms
of aerodynamic roughness length z_0**

Class	Short terrain description	z_0 (m)
1	Open sea, fetch at least 5 km	0.000 2
2	Mud flats, snow; no vegetation, no obstacles	0.005
3	Open flat terrain; grass, few isolated obstacles	0.03
4	Low crops; occasional large obstacles, $x/H > 20$	0.10
5	High crops; scattered obstacles, $15 < x/H < 20$	0.25
6	Parkland, bushes; numerous obstacles, $x/H \approx 10$	0.5
7	Regular large obstacle coverage (suburb, forest)	1.0
8	City centre with high- and low-rise buildings	≥ 2

Note: Here x is a typical upwind obstacle distance and H is the height of the corresponding major obstacles. For more detailed and updated terrain class descriptions see Davenport and others (2000) (see also Part II, Chapter 11, Table 11.2).

REFERENCES AND FURTHER READING

- Ackermann, G.R., 1983: Means and standard deviations of horizontal wind components. *Journal of Climate and Applied Meteorology*, 22, pp. 959-961.
- Albers, A., H. Klug and D. Westermann, 2000: Outdoor Comparison of Cup Anemometers. *DEWI Magazin*, No. 17, August 2000.
- Beljaars, A.C.M., 1987: The influence of sampling and filtering on measured wind gusts. *Journal of Atmospheric and Oceanic Technology*, 4, pp. 613-626.
- Busch, N.E. and L. Kristensen, 1976: Cup anemometer overspeeding. *Journal of Applied Meteorology*, 15, pp. 1328-1332.
- Coppin, P.A., 1982: An examination of cup anemometer overspeeding. *Meteorologische Rundschau*, 35, pp. 1-11.
- Curran, J.C., G.E. Peckham, D. Smith, A.S. Thom, J.S.G. McCulloch and I.C. Strangeways, 1977: Cairngorm summit automatic weather station. *Weather*, 32, pp. 60-63.
- Davenport, A.G., 1960: Rationale for determining design wind velocities. *Journal of the Structural Division*, American Society of Civil Engineers, 86, pp. 39-68.
- Davenport, A.G., C.S.B. Grimmond, T.R. Oke and J. Wieringa, 2000: Estimating the roughness of cities and sheltered country. *Preprints of the Twelfth American Meteorological Society Conference on Applied Climatology* (Asheville, NC, United States), pp. 96-99.
- Evans, R.A. and B.E. Lee, 1981: The problem of anemometer exposure in urban areas: a wind-tunnel study. *Meteorological Magazine*, 110, pp. 188-189.
- Frenkiel, F.N., 1951: Frequency distributions of velocities in turbulent flow. *Journal of Meteorology*, 8, pp. 316-320.
- Gill, G.C., L.E. Olsson, J. Sela and M. Suda, 1967: Accuracy of wind measurements on towers or stacks. *Bulletin of the American Meteorological Society*, 48, pp. 665-674.
- Gold, E., 1936: Wind in Britain - The Dines and some notable records during the last 40 years. *Quarterly Journal of the Royal Meteorological Society*, 62, pp. 167-206.
- Grimmond, C.S.B., T.S. King, M. Roth and T.R. Oke, 1998: Aerodynamic roughness of urban areas derived from wind observations. *Boundary Layer Meteorology*, 89, pp. 1-24.
- Kaimal, J.C., 1980: Sonic anemometers. *Air-sea Interaction: Instruments and Methods* (F. Dobson, L. Hasse and R. Davis, eds), Plenum Press, New York, pp. 81-96.
- Lenschow, D.H. (ed.), 1986: *Probing the Atmospheric Boundary Layer*. American Meteorological Society, Boston.
- MacCready, P.B., 1966: Mean wind speed measurements in turbulence. *Journal of Applied Meteorology*, 5, pp. 219-225.
- MacCready, P.B. and H.R. Jex, 1964: Response characteristics and meteorological utilization of propeller and vane wind sensors. *Journal of Applied Meteorology*, 3, pp. 182-193.
- Makinwa, K.A.A., J.H. Huijsing and A. Hagedoorn, 2001: Industrial design of a solid-state wind sensor. *Proceedings of the First ISA/IEEE Conference*, Houston, November 2001, pp. 68-71.
- Mazzarella, D.A., 1972: An inventory of specifications for wind-measuring instruments. *Bulletin of the American Meteorological Society*, 53, pp. 860-871.
- Mollo-Christensen, E. and J.R. Seesholtz, 1967: Wind tunnel measurements of the wind disturbance field of a model of the Buzzards Bay Entrance Light Tower. *Journal of Geophysical Research*, 72, pp. 3549-3556.
- Patterson, J., 1926: The cup anemometer. *Transactions of the Royal Society of Canada*, 20, Series III, pp. 1-54.
- Smith, S.D., 1980: Dynamic anemometers. *Air-sea Interaction: Instruments and Methods* (F. Dobson, L. Hasse and R. Davis, eds). Plenum Press, New York, pp. 65-80.
- Taylor, P.A. and R.J. Lee, 1984: Simple guidelines for estimating wind speed variations due to small scale topographic features. *Climatological Bulletin*, Canadian Meteorological and Oceanographic Society, 18, pp. 3-22.
- Van Oudheusden, B.W. and J.H. Huijsing, 1991: Microelectronic thermal anemometer for the measurement of surface wind. *Journal of Atmospheric and Oceanic Technology*, 8, pp. 374-384.
- Verkaik, J.W., 2000: Evaluation of two gustiness models for exposure correction calculations. *Journal of Applied Meteorology*, 39, pp. 1613-1626.
- Walmsley, J.L., I.B. Troen, D.P. Lalas and P.J. Mason, 1990: Surface-layer flow in complex terrain: Comparison of models and full-scale observations. *Boundary-Layer Meteorology*, 52, pp. 259-281.

- Wieringa, J., 1967: Evaluation and design of wind vanes. *Journal of Applied Meteorology*, 6, pp. 1114-1122.
- Wieringa, J., 1980a: A revaluation of the Kansas mast influence on measurements of stress and cup anemometer overspeeding. *Boundary-Layer Meteorology*, 18, pp. 411-430.
- Wieringa, J., 1980b: Representativeness of wind observations at airports. *Bulletin of the American Meteorological Society*, 61, pp. 962-971.
- Wieringa, J., 1983: Description requirements for assessment of non-ideal wind stations, for example Aachen. *Journal of Wind Engineering and Industrial Aerodynamics*, 11, pp. 121-131.
- Wieringa, J., 1986: Roughness-dependent geographical interpolation of surface wind speed averages. *Quarterly Journal of the Royal Meteorological Society*, 112, pp. 867-889.
- Wieringa, J., 1996: Does representative wind information exist? *Journal of Wind Engineering and Industrial Aerodynamics*, 65, pp. 1-12.
- Wieringa, J. and F.X.C.M. van Lindert, 1971: Application limits of double-fin and coupled wind vanes. *Journal of Applied Meteorology*, 10, pp. 137-145.
- World Meteorological Organization, 1981: *Review of Reference Height for and Averaging Time of Surface Wind Measurements at Sea* (F.W. Dobson). Marine Meteorology and Related Oceanographic Activities Report No. 3, Geneva.
- World Meteorological Organization, 1984a: *Compendium of Lecture Notes for Training Class IV Meteorological Personnel* (B.J. Retallack). Volume II - Meteorology (second edition), WMO-No. 266, Geneva.
- World Meteorological Organization, 1984b: Distortion of the wind field by the Cabauw Meteorological Tower (H.R.A. Wessels). *Papers Presented at the WMO Technical Conference on Instruments and Cost-effective Meteorological Observations (TECEMO)*, Instruments and Observing Methods Report No. 15, Geneva.
- World Meteorological Organization, 1987: *The Measurement of Gustiness at Routine Wind Stations: A Review* (A.C.M. Beljaars). Instruments and Observing Methods Report No. 31, Geneva.
- World Meteorological Organization, 1989: *Wind Measurements Reduction to a Standard Level* (R.J. Shearman and A.A. Zelenko). Marine Meteorology and Related Oceanographic Activities Report No. 22, WMO/TD-No 311, Geneva.
- World Meteorological Organization, 1990: *Abridged Final Report of the Tenth Session of the Commission for Instruments and Methods of Observation*. WMO-No. 727, Geneva.
- World Meteorological Organization, 1991: *Guidance on the Establishment of Algorithms for Use in Synoptic Automatic Weather Stations: Processing of Surface Wind Data* (D. Painting). Report of the CIMO Working Group on Surface Measurements, Instruments and Observing Methods Report No. 47, WMO/TD-No. 452, Geneva.
- World Meteorological Organization, 1995: *Manual on Codes*. Volume I.1, WMO-No. 306, Geneva.
- World Meteorological Organization, 2000: Wind measurements: Potential wind speed derived from wind speed fluctuations measurements, and the representativity of wind stations (J.P. van der Meulen). *Papers Presented at the WMO Technical Conference on Meteorological and Environmental Instruments and Methods of Observation (TECO-2000)*, Instruments and Observing Methods Report No. 74, WMO/TD-No. 1028, p. 72, Geneva.
- World Meteorological Organization, 2001: Lecture notes for training agricultural meteorological personnel (second edition; J. Wieringa and J. Lomas). WMO-No. 551, Geneva (sections 5.3.3 and 9.2.4).
- Wyngaard, J.C., 1981: The effects of probe-induced flow distortion on atmospheric turbulence measurements. *Journal of Applied Meteorology*, 20, pp. 784-794.
-

CHAPTER 6

MEASUREMENT OF PRECIPITATION

6.1 GENERAL

This chapter describes the well-known methods of precipitation measurements at ground stations. It does not discuss measurements which attempt to define the structure and character of precipitation, or which require specialized instrumentation, which are not standard meteorological observations (such as drop size distribution). Radar and satellite measurements, and measurements at sea, are discussed in Part II.

Information on precipitation measurements which includes, in particular, more detail on snow cover measurements can also be found in WMO (1992*a*; 1998).

The general problem of representativeness is particularly acute in the measurement of precipitation. Precipitation measurements are particularly sensitive to exposure, wind and topography, and metadata describing the circumstances of the measurements are particularly important for users of the data.

The analysis of precipitation data is much easier and more reliable if the same gauges and siting criteria are used throughout the networks. This should be a major consideration in designing networks.

6.1.1 Definitions

Precipitation is defined as the liquid or solid products of the condensation of water vapour falling from clouds or deposited from air onto the ground. It includes rain, hail, snow, dew, rime, hoar frost and fog precipitation. The total amount of precipitation which reaches the ground in a stated period is expressed in terms of the vertical depth of water (or water equivalent in the case of solid forms) to which it would cover a horizontal projection of the Earth's surface. Snowfall is also expressed by the depth of fresh, newly fallen snow covering an even horizontal surface (see section 6.7).

6.1.2 Units and scales

The unit of precipitation is linear depth, usually in millimetres (volume/area), or kg m^{-2} (mass/area) for liquid precipitation. Daily amounts of precipitation

should be read to the nearest 0.2 mm and, if feasible, to the nearest 0.1 mm; weekly or monthly amounts should be read to the nearest 1 mm (at least). Daily measurements of precipitation should be taken at fixed times common to the entire network or networks of interest. Less than 0.1 mm (0.2 mm in the United States) is generally referred to as a trace. The rate of rainfall (intensity) is similarly expressed in linear measures per unit time, usually millimetres per hour.

Snowfall measurements are taken in units of centimetres and tenths, to the nearest 0.2 cm. Less than 0.2 cm is generally called a trace. The depth of snow on the ground is usually measured daily in whole centimetres.

6.1.3 Meteorological and hydrological requirements

Part I, Chapter 1, Annex 1.B gives a broad statement of the requirements for accuracy, range and resolution for precipitation measurements, and gives 5 per cent as the achievable accuracy (at the 95 per cent confidence level).

The common observation times are hourly, three-hourly and daily, for synoptic, climatological and hydrological purposes. For some purposes, a much greater time resolution is required to measure very high rainfall rates over very short periods. For some applications, storage gauges are used with observation intervals of weeks or months or even a year in mountains and deserts.

6.1.4 Measurement methods

6.1.4.1 Instruments

Precipitation gauges (or raingauges if only liquid precipitation can be measured) are the most common instruments used to measure precipitation. Generally, an open receptacle with vertical sides is used, usually in the form of a right cylinder, with a funnel if its main purpose is to measure rain. Since various sizes and shapes of orifice and gauge heights are used in different countries, the measurements are not strictly comparable (WMO, 1989*a*). The volume or weight of the catch is measured, the latter in particular for solid precipitation. The gauge orifice may be at one of many specified

heights above the ground or at the same level as the surrounding ground. The orifice must be placed above the maximum expected depth of snow cover, and above the height of significant potential in-splashing from the ground. For solid precipitation measurement, the orifice is above the ground and an artificial shield is placed around it. The most commonly used elevation height in more than 100 countries varies between 0.5 and 1.5 m (WMO, 1989*a*).

The measurement of precipitation is very sensitive to exposure, and in particular to wind. Section 6.2 discusses exposure, while section 6.4 discusses at some length the errors to which precipitation gauges are prone, and the corrections that may be applied.

This chapter also describes some other special techniques for measuring other types of precipitation (dew, ice, and the like) and snow cover. Some new techniques which are appearing in operational use are not described here, for example, the optical raingauge, which makes use of optical scattering. Useful sources of information on new methods under development are the reports of recurrent conferences, such as the international workshops on precipitation measurement (Slovak Hydrometeorological Institute and Swiss Federal Institute of Technology, 1993; WMO, 1989*b*) and those organized by the Commission for Instruments and Methods of Observation (WMO, 1998).

Point measurements of precipitation serve as the primary source of data for areal analysis. However, even the best measurement of precipitation at one point is only representative of a limited area, the size of which is a function of the length of the accumulation period, the physiographic homogeneity of the region, local topography and the precipitation-producing process. Radar and, more recently, satellites are used to define and quantify the spatial distribution of precipitation. The techniques are described in Part II of this Guide. In principle, a suitable integration of all three sources of areal precipitation data into national precipitation networks (automatic gauges, radar, and satellite) can be expected to provide sufficiently accurate areal precipitation estimates on an operational basis for a wide range of precipitation data users.

Instruments that detect and identify precipitation, as distinct from measuring it, may be used as present weather detectors, and are referred to in Part I, Chapter 14.

6.1.4.2 Reference gauges and intercomparisons

Several types of gauges have been used as reference gauges. The main feature of their design is that of reducing or controlling the effect of wind on the catch, which is the main reason for the different behaviours of gauges. They are chosen also to reduce the other errors discussed in section 6.4.

Ground-level gauges are used as reference gauges for liquid precipitation measurement. Because of the absence of wind-induced error, they generally show more precipitation than any elevated gauge (WMO, 1984). The gauge is placed in a pit with the gauge rim at ground level, sufficiently distant from the nearest edge of the pit to avoid in-splashing. A strong plastic or metal anti-splash grid with a central opening for the gauge should span the pit. Provision should be made for draining the pit. Pit gauge drawings are given in WMO (1984).

The reference gauge for solid precipitation is the gauge known as the Double Fence Intercomparison Reference. It has octagonal vertical double fences surrounding a Tretyakov gauge, which itself has a particular form of wind-deflecting shield. Drawings and a description are given by Goodison, Sevruk and Klemm (1989), in WMO (1985), and in the final report of the WMO inter-comparison of solid precipitation gauges (WMO, 1998).

Recommendations for comparisons of precipitation gauges against the reference gauges are given in Annex 6.A.¹

6.1.4.3 Documentation

The measurement of precipitation is particularly sensitive to gauge exposure, so metadata about the measurements must be recorded meticulously to compile a comprehensive station history, in order to be available for climate and other studies and quality assurance.

Section 6.2 discusses the site information that must be kept, namely detailed site descriptions, including vertical angles to significant obstacles around the gauge, gauge configuration, height of the gauge orifice above ground and height of the wind speed measuring instrument above ground.

1 Recommended by the Commission for Instruments and Methods of Observation at its eleventh session (1994).

Changes in observational techniques for precipitation, mainly the use of a different type of precipitation gauge and a change of gauge site or installation height, can cause temporal inhomogeneities in precipitation time series (see Part III, Chapter 2). The use of differing types of gauges and site exposures causes spatial inhomogeneities. This is due to the systematic errors of precipitation measurement, mainly the wind-induced error. Since adjustment techniques based on statistics can remove the inhomogeneities relative to the measurements of surrounding gauges, the correction of precipitation measurements for the wind-induced error can eliminate the bias of measured values of any type of gauge.

The following sections (especially section 6.4) on the various instrument types discuss the corrections that may be applied to precipitation measurements. Such corrections have uncertainties, and the original records and the correction formulae should be kept.

Any changes in the observation methods should also be documented.

6.2 SITING AND EXPOSURE

All methods for measuring precipitation should aim to obtain a sample that is representative of the true amount falling over the area which the measurement is intended to represent, whether on the synoptic scale, mesoscale or microscale. The choice of site, as well as the systematic measurement error, is, therefore, important. For a discussion of the effects of the site, see Sevruck and Zahlavova (1994).

The location of precipitation stations within the area of interest is important, because the number and locations of the gauge sites determine how well the measurements represent the actual amount of precipitation falling in the area. Areal representativeness is discussed at length in WMO (1992*a*), for rain and snow. WMO (1994) gives an introduction to the literature on the calculation of areal precipitation and corrections for topography.

The effects on the wind field of the immediate surroundings of the site can give rise to local excesses and deficiencies in precipitation. In general, objects should not be closer to the gauge than a distance of twice their height above the gauge orifice. For each site, the average vertical angle of obstacles should be estimated, and a site

plan should be made. Sites on a slope or the roof of a building should be avoided. Sites selected for measuring snowfall and/or snow cover should be in areas sheltered as much as possible from the wind. The best sites are often found in clearings within forests or orchards, among trees, in scrub or shrub forests, or where other objects act as an effective wind-break for winds from all directions.

Preferably, however, the effects of the wind, and of the site on the wind, can be reduced by using a ground-level gauge for liquid precipitation or by making the air-flow horizontal above the gauge orifice using the following techniques (listed in order of decreasing effectiveness):

- (a) In areas with homogeneous dense vegetation; the height of such vegetation should be kept at the same level as the gauge orifice by regular clipping;
- (b) In other areas, by simulating the effect in (a) through the use of appropriate fence structures;
- (c) By using windshields around the gauge.

The surface surrounding the precipitation gauge can be covered with short grass, gravel or shingle, but hard, flat surfaces, such as concrete, should be avoided to prevent excessive in-splashing.

6.3 NON-RECORDING PRECIPITATION GAUGES

6.3.1 Ordinary gauges

6.3.1.1 Instruments

The commonly used precipitation gauge consists of a collector placed above a funnel leading into a container where the accumulated water and melted snow are stored between observation times. Different gauge shapes are in use worldwide as shown in Figure 6.1. Where solid precipitation is common and substantial, a number of special modifications are used to improve the accuracy of measurements. Such modifications include the removal of the raingauge funnel at the beginning of the snow season or the provision of a special snow fence (see WMO, 1998) to protect the catch from blowing out. Windshields around the gauge reduce the error caused by deformation of the wind field above the gauge and by snow drifting into the gauge. They are advisable for rain and essential for snow. A wide variety of gauges are in use (see WMO, 1989*a*).

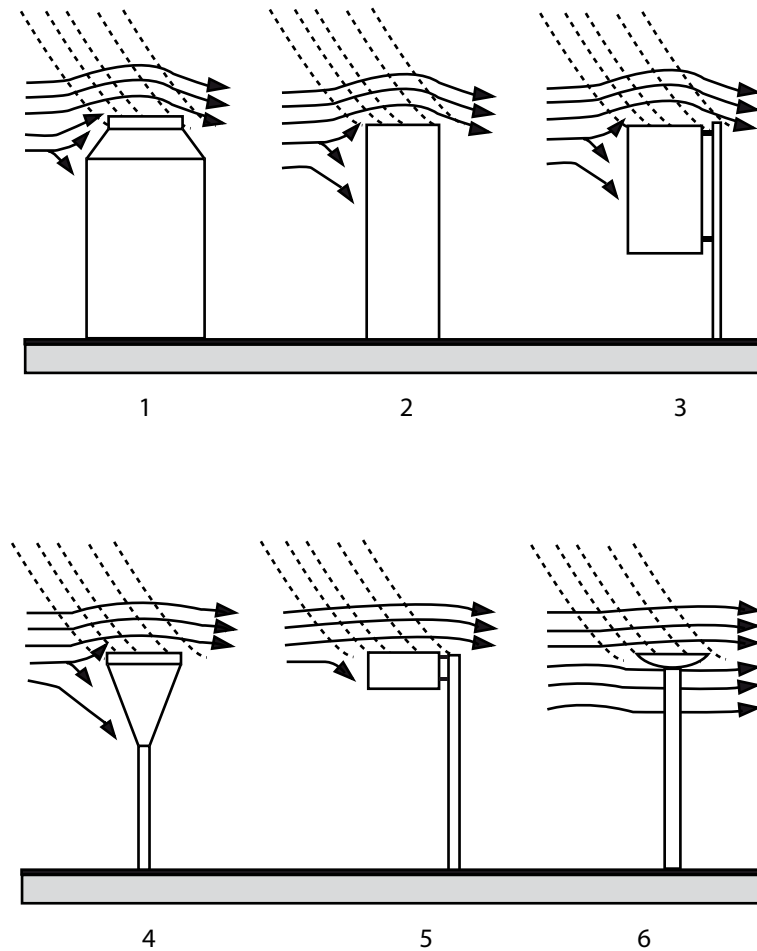

Figure 6.1. Different shapes of standard precipitation gauges. The solid lines show streamlines and the dashed lines show the trajectories of precipitation particles. The first gauge shows the largest wind field deformation above the gauge orifice, and the last gauge the smallest. Consequently, the wind-induced error for the first gauge is larger than for the last gauge (Sevruck and Nespor, 1994).

The stored water is either collected in a measure or poured from the container into a measure, or its level in the container is measured directly with a graduated stick. The size of the collector orifice is not critical for liquid precipitation, but an area of at least 200 cm² is required if solid forms of precipitation are expected in significant quantity. An area of 200 to 500 cm² will probably be found most convenient. The most important requirements of a gauge are as follows:

- (a) The rim of the collector should have a sharp edge and should fall away vertically on the inside, and be steeply bevelled on the outside; the design of gauges used for measuring snow should be such that any narrowing of the orifice caused by accumulated wet snow about the rim is small;
- (b) The area of the orifice should be known to the nearest 0.5 per cent, and the construction should be such that this area remains constant while the gauge is in normal use;
- (c) The collector should be designed to prevent rain from splashing in and out. This can be achieved if the vertical wall is sufficiently deep and the slope of the funnel is sufficiently steep (at least 45 per cent). Suitable arrangements are shown in Figure 6.2;
- (d) The construction should be such as to minimize wetting errors;
- (e) The container should have a narrow entrance and be sufficiently protected from radiation to minimize the loss of water by evaporation. Precipitation gauges used in locations where only weekly or monthly readings are practicable should be similar in design to the type used for daily measurements, but with a container of larger capacity and stronger construction.

The measuring cylinder should be made of clear glass or plastic which has a suitable coefficient of thermal expansion and should be clearly marked to show the size or type of gauge with which it is to be used. Its diameter should be less than 33 per cent of that of the rim of the gauge; the smaller the relative diameter, the greater the precision of measurement. The graduations should be finely engraved; in general, there should be marks at 0.2 mm intervals and clearly figured lines at each whole millimetre. It is also desirable that the line corresponding to 0.1 mm be marked. The maximum error of the graduations should not exceed ± 0.05 mm at or above the 2 mm graduation mark and ± 0.02 mm below this mark.

To measure small precipitation amounts with adequate precision, the inside diameter of the measuring cylinder should taper off at its base. In all measurements, the bottom of the water meniscus should define the water level, and the cylinder should be kept vertical when reading, to avoid parallax errors. Repetition of the main graduation lines on the back of the measure is also helpful for reducing such errors.

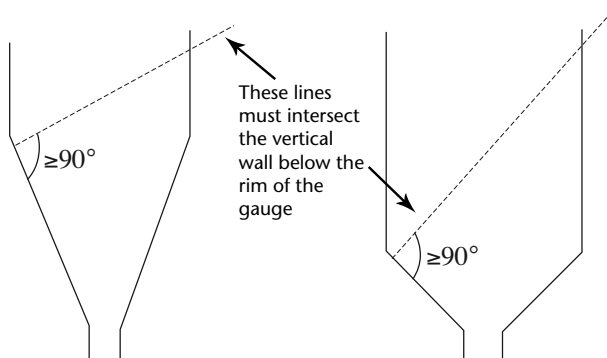

Figure 6.2. Suitable collectors for rain gauges

Dip-rods should be made of cedar wood, or another suitable material that does not absorb water appreciably and possesses only a small capillary effect. Wooden dip-rods are unsuitable if oil has been added to the collector to suppress evaporation. When this is the case, rods made of metal or other materials from which oil can be readily cleaned must be used. Non-metallic rods should be provided with a brass foot to avoid wear and be graduated according to the relative areas of cross-section of the gauge orifice and the collector; graduations should be marked at least every 10 mm and include an allowance for the

displacement caused by the rod itself. The maximum error in the dip-rod graduation should not exceed ± 0.5 mm at any point. A dip-rod measurement should be checked using a volumetric measure, wherever possible.

6.3.1.2 Operation

The measuring cylinder must be kept vertical when it is being read, and the observer must be aware of parallax errors. Snow collected in non-recording precipitation gauges should be either weighed or melted immediately after each observation and then measured using a standard graduated measuring cylinder. It is also possible to measure precipitation catch by accurate weighing, a procedure which has several advantages. The total weight of the can and contents is measured and the known weight of the can is subtracted. There is little likelihood of spilling the water and any water adhering to the can is included in the weight. The commonly used methods are, however, simpler and cheaper.

6.3.1.3 Calibration and maintenance

The graduation of the measuring cylinder or stick must, of course, be consistent with the chosen size of the collector. The calibration of the gauge, therefore, includes checking the diameter of the gauge orifice and ensuring that it is within allowable tolerances. It also includes volumetric checks of the measuring cylinder or stick.

Routine maintenance should include, at all times, keeping the gauge level in order to prevent an out-of-level gauge (see Rinehart, 1983; Sevruk, 1984). As required, the outer container of the gauge and the graduate should be kept clean at all times both inside and outside by using a long-handled brush, soapy water and a clean water rinse. Worn, damaged or broken parts should be replaced, as required. The vegetation around the gauge should be kept trimmed to 5 cm (where applicable). The exposure should be checked and recorded.

6.3.2 Storage gauges

Storage gauges are used to measure total seasonal precipitation in remote and sparsely inhabited areas. Such gauges consist of a collector above a funnel, leading into a container that is large enough to store the seasonal catch (or the monthly catch in wet areas). A layer of no less than 5 mm of a suitable oil or other evaporation

suppressant should be placed in the container to reduce evaporation (WMO, 1972). This layer should allow the free passage of precipitation into the solution below it.

An antifreeze solution may be placed in the container to convert any snow which falls into the gauge into a liquid state. It is important that the antifreeze solution remain dispersed. A mixture of 37.5 per cent by weight of commercial calcium chloride (78 per cent purity) and 62.5 per cent water makes a satisfactory antifreeze solution. Alternatively, aqueous solutions of ethylene glycol or of an ethylene glycol and methanol mixture can be used. While more expensive, the latter solutions are less corrosive than calcium chloride and give antifreeze protection over a much wider range of dilution resulting from subsequent precipitation. The volume of the solution initially placed in the container should not exceed 33 per cent of the total volume of the gauge.

In some countries, this antifreeze and oil solution is considered toxic waste and, therefore, harmful to the environment. Guidelines for the disposal of toxic substances should be obtained from local environmental protection authorities.

The seasonal precipitation catch is determined by weighing or measuring the volume of the contents of the container (as with ordinary gauges; see section 6.3.1). The amount of oil and antifreeze solution placed in the container at the beginning of the season and any contraction in the case of volumetric measurements must be carefully taken into account. Corrections may be applied as with ordinary gauges.

The operation and maintenance of storage gauges in remote areas pose several problems, such as the capping of the gauge by snow or difficulty in locating the gauge for recording the measurement, and so on, which require specific monitoring. Particular attention should be paid to assessing the quality of data from such gauges.

6.4 **PRECIPITATION GAUGE ERRORS AND CORRECTIONS**

It is convenient to discuss at this point the errors and corrections that apply in some degree to most precipitation gauges, whether they are recording or

non-recording gauges. The particular cases of recording gauges are discussed in section 6.5.

Comprehensive accounts of errors and corrections can be found in WMO (1982; 1984; 1986; and, specifically for snow, 1998). Details of the models currently used for adjusting raw precipitation data in Canada, Denmark, Finland, the Russian Federation, Switzerland and the United States are given in WMO (1982). WMO (1989*a*) gives a description of how the errors occur. There are collected conference papers on the topic in WMO (1986; 1989*b*).

The amount of precipitation measured by commonly used gauges may be less than the actual precipitation reaching the ground by up to 30 per cent or more. Systematic losses will vary by type of precipitation (snow, mixed snow and rain, and rain). The systematic error of solid precipitation measurements is commonly large and may be of an order of magnitude greater than that normally associated with liquid precipitation measurements.

For many hydrological purposes it is necessary first to make adjustments to the data in order to allow for the error before making the calculations. The adjustments cannot, of course, be exact (and may even increase the error). Thus, the original data should always be kept as the basic archives both to maintain continuity and to serve as the best base for future improved adjustments if, and when, they become possible.

The true amount of precipitation may be estimated by correcting for some or all of the various error terms listed below:

- (a) Error due to systematic wind field deformation above the gauge orifice: typically 2 to 10 per cent for rain and 10 to 50 per cent for snow;
- (b) Error due to the wetting loss on the internal walls of the collector;
- (c) Error due to the wetting loss in the container when it is emptied: typically 2 to 15 per cent in summer and 1 to 8 per cent in winter, for (b) and (c) together;
- (d) Error due to evaporation from the container (most important in hot climates): 0 to 4 per cent;
- (e) Error due to blowing and drifting snow;
- (f) Error due to the in- and out-splashing of water: 1 to 2 per cent;

- (g) Random observational and instrumental errors, including incorrect gauge reading times.

The first six error components are systematic and are listed in order of general importance. The net error due to blowing and drifting snow and to in- and out-splashing of water can be either negative or positive, while net systematic errors due to the wind field and other factors are negative. Since the errors listed as (e) and (f) above are generally difficult to quantify, the general model for adjusting the data from most gauges takes the following form:

$$P_k = kP_c = k(P_g + \Delta P_1 + \Delta P_2 + \Delta P_3)$$

where P_k is the adjusted precipitation amount; k (see Figure 6.3) is the adjustment factor for the effects of wind field deformation; P_c is the amount of precipitation caught by the gauge collector; P_g is the measured amount of precipitation in the gauge; ΔP_1 is the adjustment for the wetting loss on the internal walls of the collector; ΔP_2 is the adjustment for wetting loss in the container after emptying; and ΔP_3 is the adjustment for evaporation from the container.

The corrections are applied to daily or monthly totals or, in some practices, to individual precipitation events.

In general, the supplementary data needed to make such adjustments include the wind speed at the gauge orifice during precipitation, drop size, precipitation intensity, air temperature and humidity, and the characteristics of the gauge site. Wind speed and precipitation type or intensity may be sufficient variables to determine the corrections. Wind speed alone is sometimes used. At sites where such observations are not made, interpolation between the observations made at adjacent sites may be used for making such adjustments, but with caution, and for monthly rainfall data only.

For most precipitation gauges, wind speed is the most important environmental factor contributing to the under-measurement of solid precipitation. These data must be derived from standard meteorological observations at the site in order to provide daily adjustments. In particular, if wind speed is not measured at gauge orifice height, it can be derived by using a mean wind speed reduction procedure after having

knowledge of the roughness of the surrounding surface and the angular height of surrounding obstacles. A suggested scheme is shown in Annex 6.B.² This scheme is very site-dependent, and estimation requires a good knowledge of the station and gauge location. Shielded gauges catch more precipitation than their unshielded counterparts, especially for solid precipitation. Therefore, gauges should be shielded either naturally (for example, forest clearing) or artificially (for example, Alter, Canadian Nipher type, Tretyakov windshield) to minimize the adverse effect of wind speed on measurements of solid precipitation (refer to WMO, 1994 and 1998, for some information on shield design).

Wetting loss (Sevruk, 1974a) is another cumulative systematic loss from manual gauges which varies with precipitation and gauge type; its magnitude is also a function of the number of times the gauge is emptied. Average wetting loss can be up to 0.2 mm per observation. At synoptic stations where precipitation is measured every 6 h, this can become a very significant loss. In some countries, wetting loss has been calculated to be 15 to 20 per cent of the measured winter precipitation. Correction for wetting loss at the time of observation is a feasible alternative. Wetting loss can be kept low in a well-designed gauge. The internal surfaces should be of a material which can be kept smooth and clean; paint, for example, is unsuitable, but baked enamel is satisfactory. Seams in the construction should be kept to a minimum.

Evaporation losses (Sevruk, 1974b) vary by gauge type, climatic zone and time of year. Evaporation loss is a problem with gauges that do not have a funnel device in the bucket, especially in late spring at mid-latitudes. Losses of over 0.8 mm per day have been reported. Losses during winter are much less than during comparable summer months, ranging from 0.1 to 0.2 mm per day. These losses, however, are cumulative. In a well-designed gauge, only a small water surface is exposed, its ventilation is minimized, and the water temperature is kept low by a reflective outer surface.

It is clear that, in order to achieve data compatibility when using different gauge types and shielding during all weather conditions, corrections to the

2 A wind reduction scheme recommended by the Commission for Instruments and Methods of Observation at its eleventh session (1994).

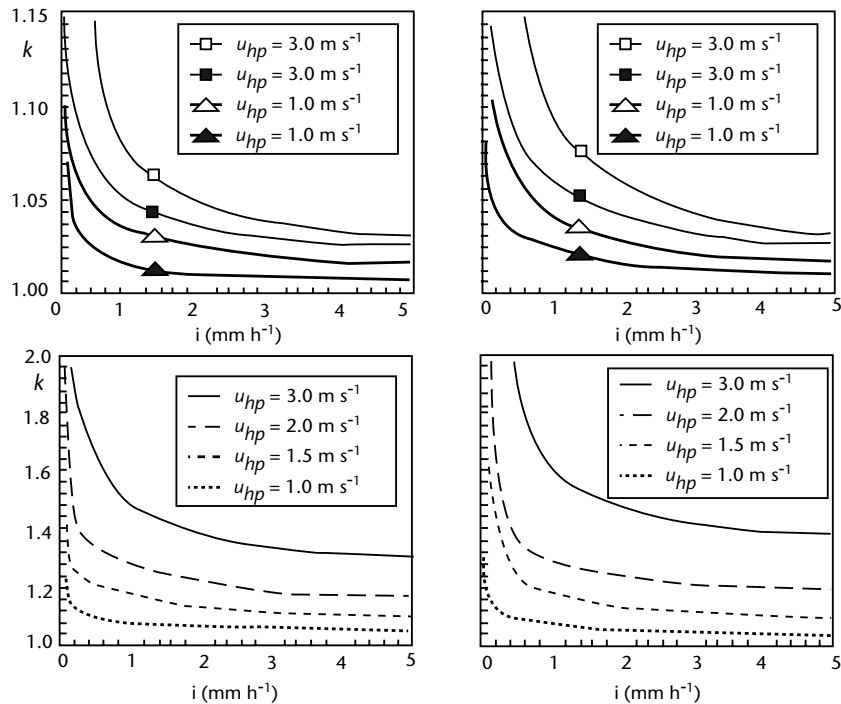

Figure 6.3. Conversion factor k defined as the ratio of “correct” to measured precipitation for rain (top) and snow (bottom) for two unshielded gauges in dependency of wind speed u_{hp} , intensity i and type of weather situation according to Nespor and Sevruk (1999). On the left is the German Hellmann manual standard gauge, and on the right the recording, tipping-bucket gauge by Lambrecht. Void symbols in the top diagrams refer to orographic rain, and black ones to showers. Note the different scales for rain and snow. For shielded gauges, k can be reduced to 50 and 70 per cent for snow and mixed precipitation, respectively (WMO, 1998). The heat losses are not considered in the diagrams (in Switzerland they vary with altitude between 10 and 50 per cent of the measured values of fresh snow).

actual measurements are necessary. In all cases where precipitation measurements are adjusted in an attempt to reduce errors, it is strongly recommended that both the measured and adjusted values be published.

6.5 RECORDING PRECIPITATION GAUGES

Recording precipitation automatically has the advantage that it can provide better time resolution than manual measurements, and it is possible to reduce the evaporation and wetting losses. These readings are of course subject to the wind effects discussed in section 6.4

Three types of automatic precipitation recorders are in general use, namely the weighing-recording type, the tilting or tipping-bucket type, and the float type. Only the weighing type is satisfactory for measuring all kinds of precipitation, the use of the other two types being for the most part

limited to the measurement of rainfall. Some new automatic gauges that measure precipitation without using moving parts are available. These gauges use devices such as capacitance probes, pressure transducers, and optical or small radar devices to provide an electronic signal that is proportional to the precipitation equivalent. The clock device that times intervals and dates the time record is a very important component of the recorder.

6.5.1 Weighing-recording gauge

6.5.1.1 Instruments

In these instruments, the weight of a container, together with the precipitation accumulated therein, is recorded continuously, either by means of a spring mechanism or with a system of balance weights. All precipitation, both liquid and solid, is recorded as it falls. This type of gauge normally has no provision for emptying itself; the capacity (namely, the maximum accumulation between

recharge) ranges from 150 to 750 mm. The gauges must be maintained to minimize evaporation losses, which can be accomplished by adding sufficient oil or other evaporation suppressants inside the container to form a film over the water surface. Any difficulties arising from oscillation of the balance in strong winds can be reduced with an oil damping mechanism or, if recent work is substantiated, by suitably programming a microprocessor to eliminate this effect on the readings. Such weighing gauges are particularly useful for recording snow, hail, and mixtures of snow and rain, since the solid precipitation does not need to be melted before it can be recorded. For winter operation, the catchment container is charged with an antifreeze solution (see section 6.3.2) to dissolve the solid contents. The amount of antifreeze depends on the expected amount of precipitation and the minimum temperature expected at the time of minimum dilution.

The weight of the catchment container, measured by a calibrated spring, is translated from a vertical to an angular motion through a series of levers or pulleys. This angular motion is then communicated mechanically to a drum or strip chart or digitized through a transducer. The accuracy of these types of gauges is related directly to their measuring and/or recording characteristics, which can vary with manufacturer.

6.5.1.2 Errors and corrections

Except for error due to the wetting loss in the container when it is emptied, weighing-recording gauges are susceptible to all of the other sources of error discussed in section 6.4. It should also be noted that automatic recording gauges alone cannot identify the type of precipitation. A significant problem with this type of gauge is that precipitation, particularly freezing rain or wet snow, can stick to the inside of the gauge orifice and not fall into the bucket until some time later. This severely limits the ability of weighing-recording gauges to provide accurate timing of precipitation events. Another common fault with weighing-type gauges is wind pumping. This usually occurs during high winds when turbulent air currents passing over and around the catchment container cause oscillations in the weighing mechanism. By using programmable data-logging systems, errors associated with such anomalous recordings can be minimized by averaging readings over short time intervals, namely, 1 min. Timing errors in the instrument clock may assign the catch to the wrong period or date.

Some potential errors in manual methods of precipitation measurement can be eliminated or at least minimized by using weighing-recording gauges. Random measurement errors associated with human observer error and certain systematic errors, particularly evaporation and wetting loss, are minimized. In some countries, trace observations are officially given a value of zero, thus resulting in a biased underestimate of the seasonal precipitation total. This problem is minimized with weighing-type gauges, since even very small amounts of precipitation will accumulate over time.

The correction of weighing gauge data on an hourly or daily basis may be more difficult than on longer time periods, such as monthly climatological summaries. Ancillary data from automatic weather stations, such as wind at gauge height, air temperature, present weather or snow depth, will be useful in interpreting and correcting accurately the precipitation measurements from automatic gauges.

6.5.1.3 Calibration and maintenance

Weighing-recording gauges usually have few moving parts and, therefore, should seldom require calibration. Calibration commonly involves the use of a series of weights which, when placed in the bucket or catchment container, provide a predetermined value equivalent to an amount of precipitation. Calibrations should normally be done in a laboratory setting and should follow the manufacturer's instructions.

Routine maintenance should be conducted every three to four months, depending on precipitation conditions at the site. Both the exterior and interior of the gauge should be inspected for loose or broken parts and to ensure that the gauge is level. Any manual read-out should be checked against the removable data record to ensure consistency before removing and annotating the record. The bucket or catchment container should be emptied, inspected, cleaned, if required, and recharged with oil for rainfall-only operation or with antifreeze and oil if solid precipitation is expected (see section 6.3.2). The recording device should be set to zero in order to make maximum use of the gauge range. The tape, chart supply or digital memory as well as the power supply should be checked and replaced, if required. A volt-ohmmeter may be required to set the gauge output to zero when a data logger is used or to

check the power supply of the gauge or recording system. Timing intervals and dates of record must be checked.

6.5.2 Tipping-bucket gauge

The tipping-bucket rain gauge is used for measuring accumulated totals and the rate of rainfall, but does not meet the required accuracy because of the large non-linear errors, particularly at high precipitation rates.

6.5.2.1 Instruments

The principle behind the operation of this instrument is simple. A light metal container or bucket divided into two compartments is balanced in unstable equilibrium about a horizontal axis. In its normal position, the bucket rests against one of two stops, which prevents it from tipping over completely. Rain water is conducted from a collector into the uppermost compartment and, after a predetermined amount has entered the compartment, the bucket becomes unstable and tips over to its alternative rest position. The bucket compartments are shaped in such a way that the water is emptied from the lower one. Meanwhile, rain continues to fall into the newly positioned upper compartment. The movement of the bucket as it tips over can be used to operate a relay contact to produce a record consisting of discontinuous steps; the distance between each step on the record represents the time taken for a specified small amount of rain to fall. This amount of rain should not exceed 0.2 mm if detailed records are required.

The bucket takes a small but finite time to tip and, during the first half of its motion, additional rain may enter the compartment that already contains the calculated amount of rainfall. This error can be appreciable during heavy rainfall (250 mm h^{-1}), but it can be controlled. The simplest method is to use a device like a siphon at the foot of the funnel to direct the water to the buckets at a controlled rate. This smoothes out the intensity peaks of very short-period rainfall. Alternatively, a device can be added to accelerate the tipping action; essentially, a small blade is impacted by the water falling from the collector and is used to apply an additional force to the bucket, varying with rainfall intensity.

The tipping-bucket gauge is particularly convenient for automatic weather stations because it lends itself to digital methods. The pulse generated by a contact closure can be monitored by a data logger and totalled over selected periods to

provide precipitation amount. It may also be used with a chart recorder.

6.5.2.2 Errors and corrections

Since the tipping-bucket rain gauge has sources of error which differ somewhat from those of other gauges, special precautions and corrections are advisable. Some sources of error include the following:

- (a) The loss of water during the tipping action in heavy rain can be minimized but not eliminated;
- (b) With the usual bucket design, the exposed water surface is large in relation to its volume, meaning that appreciable evaporation losses can occur, especially in hot regions. This error may be significant in light rain;
- (c) The discontinuous nature of the record may not provide satisfactory data during light drizzle or very light rain. In particular, the time of onset and cessation of precipitation cannot be accurately determined;
- (d) Water may adhere to both the walls and the lip of the bucket, resulting in rain residue in the bucket and additional weight to be overcome by the tipping action. Tests on waxed buckets produced a 4 per cent reduction in the volume required to tip the balance compared with non-waxed buckets. Volumetric calibration can change, without adjustment of the calibration screws, by variation of bucket wettability through surface oxidation or contamination by impurities and variations in surface tension;
- (e) The stream of water falling from the funnel onto the exposed bucket may cause over-reading, depending on the size, shape and position of the nozzle;
- (f) The instrument is particularly prone to bearing friction and to having an improperly balanced bucket because the gauge is not level.

Careful calibration can provide corrections for the systematic parts of these errors. The measurements from tipping-bucket rain gauges may be corrected for effects of exposure in the same way as other types of precipitation gauge.

Heating devices can be used to allow for measurements during the cold season, particularly of solid precipitation. However, the performance of heated tipping-bucket gauges has been found to be very poor as a result of large errors due to both wind and evaporation of melting snow. Therefore, these types of gauges are not recommended for use in winter precipitation measurement in

regions where temperatures fall below 0°C for prolonged periods.

6.5.2.3 Calibration and maintenance

Calibration of the tipping bucket is usually accomplished by passing a known amount of water through the tipping mechanism at various rates and by adjusting the mechanism to the known volume. This procedure should be followed under laboratory conditions.

Owing to the numerous error sources, the collection characteristics and calibration of tipping-bucket raingauges are a complex interaction of many variables. Daily comparisons with the standard raingauge can provide useful correction factors, and is good practice. The correction factors may vary from station to station. Correction factors are generally greater than 1.0 (under-reading) for low-intensity rain, and less than 1.0 (over-reading) for high-intensity rain. The relationship between the correction factor and intensity is not linear but forms a curve.

Routine maintenance should include cleaning the accumulated dirt and debris from funnel and buckets, as well as ensuring that the gauge is level. It is highly recommended that the tipping mechanism be replaced with a newly calibrated unit on an annual basis. Timing intervals and dates of records must be checked.

6.5.3 Float gauge

In this type of instrument, the rain passes into a float chamber containing a light float. As the level of the water within the chamber rises, the vertical movement of the float is transmitted, by a suitable mechanism, to the movement of a pen on a chart or a digital transducer. By suitably adjusting the dimensions of the collector orifice, the float and the float chamber, any desired chart scale can be used.

In order to provide a record over a useful period (24 h are normally required) either the float chamber has to be very large (in which case a compressed scale on the chart or other recording medium is obtained), or a mechanism must be provided for emptying the float chamber automatically and quickly whenever it becomes full, so that the chart pen or other indicator returns to zero. Usually a siphoning arrangement is used. The actual siphoning process should begin precisely at the predetermined level with no tendency for the water to dribble over at either

the beginning or the end of the siphoning period, which should not be longer than 15 s. In some instruments, the float chamber assembly is mounted on knife edges so that the full chamber overbalances; the surge of the water assists the siphoning process, and, when the chamber is empty, it returns to its original position. Other rain recorders have a forced siphon which operates in less than 5 s. One type of forced siphon has a small chamber that is separate from the main chamber and accommodates the rain that falls during siphoning. This chamber empties into the main chamber when siphoning ceases, thus ensuring a correct record of total rainfall.

A heating device (preferably controlled by a thermostat) should be installed inside the gauge if there is a possibility that water might freeze in the float chamber during the winter. This will prevent damage to the float and float chamber and will enable rain to be recorded during that period. A small heating element or electric lamp is suitable where a mains supply of electricity is available, otherwise other sources of power may be employed. One convenient method uses a short heating strip wound around the collecting chamber and connected to a large-capacity battery. The amount of heat supplied should be kept to the minimum necessary in order to prevent freezing, because the heat may reduce the accuracy of the observations by stimulating vertical air movements above the gauge and increasing evaporation losses.

A large undercatch by unshielded heated gauges, caused by the wind and the evaporation of melting snow, has been reported in some countries, as is the case for weighing gauges (see section 6.5.1.2).

Apart from the fact that calibration is performed using a known volume of water, the maintenance procedures for this gauge are similar to those of the weighing-recording gauge (see section 6.5.1.3).

6.6 MEASUREMENT OF DEW, ICE ACCUMULATION AND FOG PRECIPITATION

6.6.1 Measurement of dew and leaf wetness

The deposition of dew is essentially a nocturnal phenomenon and, although relatively small in amount and locally variable, is of much interest in

arid zones; in very arid regions, it may be of the same order of magnitude as the rainfall. The exposure of plant leaves to liquid moisture from dew, fog and precipitation also plays an important role in plant disease, insect activity, and the harvesting and curing of crops.

In order to assess the hydrological contribution of dew, it is necessary to distinguish between dew formed:

- (a) As a result of the downward transport of atmospheric moisture condensed on cooled surfaces, known as dew-fall;
- (b) By water vapour evaporated from the soil and plants and condensed on cooled surfaces, known as distillation dew;
- (c) As water exuded by leaves, known as guttation.

All three forms of dew may contribute simultaneously to the observed dew, although only the first provides additional water to the surface, and the latter usually results in a net loss. A further source of moisture results from fog or cloud droplets being collected by leaves and twigs and reaching the ground by dripping or by stem flow.

The amount of dew deposited on a given surface in a stated period is usually expressed in units of kg m^{-2} or in millimetres depth of dew. Whenever possible, the amount should be measured to the nearest tenth of a millimetre.

Leaf wetness may be described as light, moderate or heavy, but its most important measures are the time of onset or duration.

A review of the instruments designed for measuring dew and the duration of leaf wetness, as well as a bibliography, is given in WMO (1992*b*).

The following methods for the measurement of leaf wetness are considered.

The amount of dew depends critically on the properties of the surface, such as its radiative properties, size and aspect (horizontal or vertical). It may be measured by exposing a plate or surface, which can be natural or artificial, with known or standardized properties, and assessing the amount of dew by weighing it, visually observing it, or making use of some other quantity such as electrical conductivity. The problem lies in the choice of the surface, because the results obtained instrumentally are not necessarily representative of the dew deposit on the surrounding objects. Empirical relationships between the instrumental

measurements and the deposition of dew on a natural surface should, therefore, be established for each particular set of surface and exposure conditions; empirical relationships should also be established to distinguish between the processes of dew formation if that is important for the particular application.

A number of instruments are in use for the direct measurement of the occurrence, amount and duration of leaf wetness and dew. Dew-duration recorders use either elements which themselves change in such a manner as to indicate or record the wetness period, or electrical sensors in which the electrical conductivity of the surface of natural or artificial leaves changes in the presence of water resulting from rain, snow, wet fog or dew. In dew balances, the amount of moisture deposited in the form of precipitation or dew is weighed and recorded. In most instruments providing a continuous trace, it is possible to distinguish between moisture deposits caused by fog, dew or rain by considering the type of trace. The only certain method of measuring net dew-fall by itself is through the use of a very sensitive lysimeter (see Part I, Chapter 10).

In WMO (1992*b*) two particular electronic instruments for measuring leaf wetness are advocated for development as reference instruments, and various leaf-wetting simulation models are proposed. Some use an energy balance approach (the inverse of evaporation models), while others use correlations. Many of them require micrometeorological measurements. Unfortunately, there is no recognized standard method of measurement to verify them.

6.6.2 Measurement of ice accumulation

Ice can accumulate on surfaces as a result of several phenomena. Ice accumulation from freezing precipitation, often referred to as glaze, is the most dangerous type of icing condition. It may cause extensive damage to trees, shrubs and telephone and power lines, and create hazardous conditions on roads and runways. Hoar frost (commonly called frost) forms when air with a dew-point temperature below freezing is brought to saturation by cooling. Hoar frost is a deposit of interlocking ice crystals formed by direct sublimation on objects, usually of small diameter, such as tree branches, plant stems, leaf edges, wires, poles, and so forth. Rime is a white or milky and opaque granular deposit of ice formed by the rapid freezing of supercooled water drops as they come into contact with an exposed object.

6.6.2.1 Measurement methods

At meteorological stations, the observation of ice accumulation is generally more qualitative than quantitative, primarily due to the lack of a suitable sensor. Ice accretion indicators, usually made of anodized aluminium, are used to observe and report the occurrence of freezing precipitation, frost or rime icing.

Observations of ice accumulation can include both the measurement of the dimensions and the weight of the ice deposit as well as a visual description of its appearance. These observations are particularly important in mountainous areas where such accumulation on the windward side of a mountain may exceed the normal precipitation. A system consisting of rods and stakes with two pairs of parallel wires (one pair oriented north-south and the other east-west) can be used to accumulate ice. The wires may be suspended at any level, and the upper wire of each pair should be removable. At the time of observation, both upper wires are removed, placed in a special container, and taken indoors for melting and weighing of the deposit. The cross-section of the deposit is measured on the permanently fixed lower wires.

Recording instruments are used in some countries for continuous registration of rime. A vertical or horizontal rod, ring or plate is used as the sensor, and the increase in the amount of rime with time is recorded on a chart. A simple device called an ice-scope is used to determine the appearance and presence of rime and hoar frost on a snow surface. The ice-scope consists of a round plywood disc, 30 cm in diameter, which can be moved up or down and set at any height on a vertical rod fixed in the ground. Normally, the disc is set flush with the snow surface to collect the rime and hoar frost. Rime is also collected on a 20 cm diameter ring fixed on the rod, 20 cm from its upper end. A wire or thread 0.2 to 0.3 mm in diameter, stretched between the ring and the top end of the rod, is used for the observation of rime deposits. If necessary, each sensor can be removed and weighed.

6.6.2.2 Ice on pavements

Sensors have been developed and are in operation to detect and describe ice on roads and runways, and to support warning and maintenance programmes.

With a combination of measurements, it is possible to detect dry and wet snow and various forms of

ice. One sensor using two electrodes embedded in the road, flush with the surface, measures the electrical conductivity of the surface and readily distinguishes between dry and wet surfaces. A second measurement, of ionic polarizability, determines the ability of the surface, to hold an electrical charge; a small charge is passed between a pair of electrodes for a short time, and the same electrodes measure the residual charge, which is higher when there is an electrolyte with free ions, such as salty water. The polarizability and conductivity measurements together can distinguish between dry, moist and wet surfaces, frost, snow, white ice and some de-icing chemicals. However, because the polarizability of the non-crystalline black ice is indistinguishable from water under some conditions, the dangerous black ice state can still not be detected with the two sensors. In at least one system, this problem has been solved by adding a third specialized capacitive measurement which detects the unique structure of black ice.

The above method is a passive technique. There is an active in situ technique that uses either a heating element, or both heating and cooling elements, to melt or freeze any ice or liquid present on the surface. Simultaneous measurements of temperature and of the heat energy involved in the thaw-freeze cycle are used to determine the presence of ice and to estimate the freezing point of the mixture on the surface.

Most in situ systems include a thermometer to measure the road surface temperature. The quality of the measurement depends critically on the mounting (especially the materials) and exposure, and care must be taken to avoid radiation errors.

There are two remote-sensing methods under development which lend themselves to car-mounted systems. The first method is based on the reflection of infrared and microwave radiation at several frequencies (about 3 000 nm and 3 GHz, respectively). The microwave reflections can determine the thickness of the water layer (and hence the risk of aquaplaning), but not the ice condition. Two infrared frequencies can be used to distinguish between dry, wet and icy conditions. It has also been demonstrated that the magnitude of reflected power at wavelengths around 2 000 nm depends on the thickness of the ice layer.

The second method applies pattern recognition techniques to the reflection of laser light from the pavement, to distinguish between dry and wet surfaces, and black ice.

6.6.3 Measurement of fog precipitation

Fog consists of minute water droplets suspended in the atmosphere to form a cloud at the Earth's surface. Fog droplets have diameters from about 1 to 40 μm and fall velocities from less than 1 to approximately 5 cm s^{-1} . In fact, the fall speed of fog droplets is so low that, even in light winds, the drops will travel almost horizontally. When fog is present, horizontal visibility is usually less than 5 km; it is rarely observed when the temperature and dewpoint differ by more than 2°C.

Meteorologists are generally more concerned with fog as an obstruction to vision than as a form of precipitation. However, from a hydrological standpoint, some forested high-elevation areas experience frequent episodes of fog as a result of the advection of clouds over the surface of the mountain, where the consideration of precipitation alone may seriously underestimate the water input to the watershed (Stadtmuller and Agudelo, 1990). More recently, the recognition of fog as a water supply source in upland areas (Schemenauer and Cereceda, 1994a) and as a wet deposition pathway (Schemenauer and Cereceda, 1991; Vong, Sigmon and Mueller, 1991) has led to the requirement for standardizing methods and units of measurement. The following methods for the measurement of fog precipitation are considered.

Although there have been a great number of measurements for the collection of fog by trees and various types of collectors over the last century, it is difficult to compare the collection rates quantitatively. The most widely used fog-measuring instrument consists of a vertical wire mesh cylinder centrally fixed on the top of a rain-gauge in such a way that it is fully exposed to the free flow of the air. The cylinder is 10 cm in diameter and 22 cm in height, and the mesh is 0.2 cm by 0.2 cm (Grunow, 1960). The droplets from the moisture-laden air are deposited on the mesh and drop down into the gauge collector where they are measured or registered in the same way as rainfall. Some problems with this instrument are its small size, the lack of representativeness with respect to vegetation, the storage of water in the small openings in the mesh, and the ability of precipitation to enter directly into the rain-gauge portion, which confounds the measurement of fog deposition. In addition, the calculation of fog precipitation by simply subtracting the amount of rain in a standard rain-gauge (Grunow, 1963) from that in the fog collector leads to erroneous results whenever wind is present.

An inexpensive, 1 m^2 standard fog collector and standard unit of measurement is proposed by Schemenauer and Cereceda (1994b) to quantify the importance of fog deposition to forested high-elevation areas and to measure the potential collection rates in denuded or desert mountain ranges. The collector consists of a flat panel made of a durable polypropylene mesh and mounted with its base 2 m above the ground. The collector is coupled to a tipping-bucket rain-gauge to determine deposition rates. When wind speed measurements are taken in conjunction with the fog collector, reasonable estimates of the proportions of fog and rain being deposited on the vertical mesh panel can be taken. The output of this collector results in litres of water. Since the surface area is 1 m^2 , this gives a collection in l m^{-2} .

6.7 MEASUREMENT OF SNOWFALL AND SNOW COVER

The authoritative texts on this topic are WMO (1994) and WMO (1992a), which cover the hydrological aspects, including the procedures, for snow surveying on snow courses. The following is a brief account of some simple and well-known methods, and a brief review of the instrumentation.

Snowfall is the depth of freshly fallen snow deposited over a specified period (generally 24 h). Thus, snowfall does not include the deposition of drifting or blowing snow. For the purposes of depth measurements, the term "snow" should also include ice pellets, glaze, hail, and sheet ice formed directly or indirectly from precipitation. Snow depth usually means the total depth of snow on the ground at the time of observation.

The water equivalent of a snow cover is the vertical depth of the water that would be obtained by melting the snow cover.

6.7.1 Snowfall depth

Direct measurements of the depth of fresh snow on open ground are taken with a graduated ruler or scale. A sufficient number of vertical measurements should be made in places where drifting is considered absent in order to provide a representative average. Where the extensive drifting of snow has occurred, a greater number of measurements are needed to obtain a representative depth. Special precautions should be taken so as not to measure

any previously fallen snow. This can be done by sweeping a suitable patch clear beforehand or by covering the top of the old snow surface with a piece of suitable material (such as wood with a slightly rough surface, painted white) and measuring the depth accumulated on it. On a sloping surface (to be avoided, if possible) measurements should still be taken with the measuring rod vertical. If there is a layer of old snow, it would be incorrect to calculate the depth of the new snow from the difference between two consecutive measurements of total depth of snow since lying snow tends to become compressed and to suffer ablation.

6.7.2 **Direct measurements of snow cover depth**

Depth measurements of snow cover or snow accumulated on the ground are taken with a snow ruler or similar graduated rod which is pushed down through the snow to the ground surface. It may be difficult to obtain representative depth measurements using this method in open areas since the snow cover drifts and is redistributed under the effects of the wind, and may have embedded ice layers that limit penetration with a ruler. Care should be taken to ensure that the total depth is measured, including the depth of any ice layers which may be present. A number of measurements are taken and averaged at each observing station.

A number of snow stakes, painted with rings of alternate colours or another suitable scale, provide a convenient means of measuring the total depth of snow on the ground, especially in remote regions. The depth of snow at the stake or marker may be observed from distant ground points or from aircraft by means of binoculars or telescopes. The stakes should be painted white to minimize the undue melting of the snow immediately surrounding them. Aerial snow depth markers are vertical poles (of variable length, depending on the maximum snow depth) with horizontal cross-arms mounted at fixed heights on the poles and oriented according to the point of observation.

The development of an inexpensive ultrasonic ranging device to provide reliable snow depth measurements at automatic stations has provided a feasible alternative to the standard observation, both for snow depth and fresh snowfall (Goodison and others, 1988). This sensor can be utilized to control the quality of automatic recording gauge measurements by providing additional details on

the type, amount and timing of precipitation. It is capable of an uncertainty of ± 2.5 cm.

6.7.3 **Direct measurements of snow water equivalent**

The standard method of measuring water equivalent is by gravimetric measurement using a snow tube to obtain a sample core. This method serves as the basis for snow surveys, a common procedure in many countries for obtaining a measure of water equivalent. The method consists of either melting each sample and measuring its liquid content or by weighing the frozen sample. A measured quantity of warm water or a heat source can be used to melt the sample.

Cylindrical samples of fresh snow may be taken with a suitable snow sampler and either weighed or melted. Details of the available instruments and sampling techniques are described in WMO (1994). Often a standard raingauge overflow can be used for this method.

Snowgauges measure snowfall water equivalent directly. Essentially, any non-recording precipitation gauges can also be used to measure the water equivalent of solid precipitation. Snow collected in these types of gauges should be either weighed or melted immediately after each observation, as described in section 6.3.1.2. The recording-weighing gauge will catch solid forms of precipitation as well as liquid forms, and record the water equivalent in the same manner as liquid forms (see section 6.5.1).

The water equivalent of solid precipitation can also be estimated using the depth of fresh snowfall. This measurement is converted to water equivalent by using an appropriate specific density. Although the relationship stating that 1 cm of fresh snow equals the equivalent of 1 mm of water may be used with caution for long-term average values, it may be highly inaccurate for a single measurement, as the specific density ratio of snow may vary between 0.03 and 0.4.

6.7.4 **Snow pillows**

Snow pillows of various dimensions and materials are used to measure the weight of the snow that accumulates on the pillow. The most common pillows are flat circular containers (with a diameter of 3.7 m) made of rubberized material and filled with an antifreeze mixture of methyl alcohol and water or a methanol-glycol-water solution. The pillow is installed on the surface of the ground,

flush with the ground, or buried under a thin layer of soil or sand. In order to prevent damage to the equipment and to preserve the snow cover in its natural condition, it is recommended that the site be fenced in. Under normal conditions, snow pillows can be used for 10 years or more.

Hydrostatic pressure inside the pillow is a measure of the weight of the snow on the pillow. Measuring the hydrostatic pressure by means of a float-operated liquid-level recorder or a pressure transducer provides a method of continuous measurement of the water equivalent of the snow cover. Variations in the accuracy of the measurements may be induced by temperature changes. In shallow snow cover, diurnal temperature changes may cause expansion or contraction of the fluid in the pillow, thus giving spurious indications of snowfall or snow melt. In deep mountain areas, diurnal temperature fluctuations are unimportant, except at the beginning and end of the snow season. The access tube to the measurement unit should be installed in a temperature-controlled shelter or in the ground to reduce the temperature effects.

In situ and/or telemetry data-acquisition systems can be installed to provide continuous measurements of snow water equivalent through the use of charts or digital recorders.

Snow pillow measurements differ from those taken with standard snow tubes, especially during the snow-melt period. They are most reliable when the snow cover does not contain ice layers, which can cause "bridging" above the pillows.

A comparison of the water equivalent of snow determined by a snow pillow with measurements taken by the standard method of weighing shows that these may differ by 5 to 10 per cent.

6.7.5 **Radioisotope snowgauges**

Nuclear gauges measure the total water equivalent of the snow cover and/or provide a density profile. They are a non-destructive method of sampling and are adaptable to in situ recording and/or telemetry systems. Nearly all systems operate on the principle that water, snow or ice attenuates radiation. As with other methods of point measurement, siting in a representative location is critical for interpreting and applying point measurements as areal indices.

The gauges used to measure total water content consist of a radiation detector and a source, which

is either natural or artificial. One part (for example, the detector/source) of the system is located at the base of the snowpack, and the other at a height greater than the maximum expected snow depth. As snow accumulates, the count rate decreases in proportion to the water equivalent of the snowpack. Systems using an artificial source of radiation are used at fixed locations to obtain measurements only for that site. A system using naturally occurring uranium as a ring source around a single pole detector has been successfully used to measure packs of up to 500 mm of water equivalent, or a depth of 150 cm.

A profiling radioactive snowgauge at a fixed location provides data on total snow water equivalent and density and permits an accurate study of the water movements and density changes that occur with time in a snowpack (Armstrong, 1976). A profiling gauge consists of two parallel vertical access tubes, spaced approximately 66 cm apart, which extend from a cement base in the ground to a height above the maximum expected depth of snow. A gamma ray source is suspended in one tube, and a scintillation gamma-ray detector, attached to a photomultiplier tube, in the other. The source and detector are set at equal depths within the snow cover and a measurement is taken. Vertical density profiles of the snow cover are obtained by taking measurements at depth increments of about 2 cm. A portable gauge (Young, 1976) which measures the density of the snow cover by backscatter, rather than transmission of the gamma rays, offers a practical alternative to digging deep snow pits, while instrument portability makes it possible to assess areal variations of density and water equivalent.

6.7.6 **Natural gamma radiation**

The method of gamma radiation snow surveying is based on the attenuation by snow of gamma radiation emanating from natural radioactive elements in the top layer of the soil. The greater the water equivalent of the snow, the more the radiation is attenuated. Terrestrial gamma surveys can consist of a point measurement at a remote location, a series of point measurements, or a selected traverse over a region (Loijens, 1975). The method can also be used on aircraft. The equipment includes a portable gamma-ray spectrometer that utilizes a small scintillation crystal to measure the rays in a wide spectrum and in three spectral windows (namely, potassium, uranium and thorium emissions). With this method, measurements of

gamma levels are required at the point, or along the traverse, prior to snow cover. In order to obtain absolute estimates of the snow water equivalent, it is necessary to correct the readings for soil moisture changes in the upper 10 to 20 cm of soil for variations in background radiation resulting from cosmic rays, instrument drift and the washout of radon gas (which is a source of gamma radiation) in precipitation with subsequent build-up in the soil or snow. Also, in order to determine the relationship between spectrometer count rates and

water equivalent, supplementary snow water equivalent measurements are initially required. Snow tube measurements are the common reference standard.

The natural gamma method can be used for snowpacks which have up to 300 mm water equivalent; with appropriate corrections, its precision is ± 20 mm. The advantage of this method over the use of artificial radiation sources is the absence of a radiation risk.

ANNEX 6.A

PRECIPITATION INTERCOMPARISON SITES

The Commission for Instruments and Methods of Observation, at its eleventh session, held in 1994, made the following statement regarding precipitation intercomparison sites:

The Commission recognized the benefits of national precipitation sites or centres where past, current and future instruments and methods of observation for precipitation can be assessed on an ongoing basis at evaluation stations. These stations should:

- (a) Operate the WMO recommended gauge configurations for rain (pit gauge) and snow (Double Fence Intercomparison Reference (DFIR)). Installation and operation will follow specifications of the WMO precipitation intercomparisons. A DFIR installation is not required when only rain is observed;
 - (b) Operate past, current and new types of operational precipitation gauges or other methods of observation according to standard operating procedures and evaluate the accuracy and performance against WMO recommended reference instruments;
 - (c) Take auxiliary meteorological measurements which will allow the development and tests for the application of precipitation correction procedures;
 - (d) Provide quality control of data and archive all precipitation intercomparison data, including the related meteorological observations and the metadata, in a readily acceptable format, preferably digital;
 - (e) Operate continuously for a minimum of 10 years;
 - (f) Test all precipitation correction procedures available (especially those outlined in the final reports of the WMO intercomparisons) on the measurement of rain and solid precipitation;
 - (g) Facilitate the conduct of research studies on precipitation measurements. It is not expected that the centres provide calibration or verification of instruments. They should make recommendations on national observation standards and should assess the impact of changes in observational methods on the homogeneity of precipitation time series in the region. The site would provide a reference standard for calibrating and validating radar or remote-sensing observations of precipitation.
-

ANNEX 6.B

SUGGESTED CORRECTION PROCEDURES FOR
PRECIPITATION MEASUREMENTS

The Commission for Instruments and Methods of Observation, at its eleventh session, held in 1994, made the following statement regarding the correction procedures for precipitation measurements:

The correction methods are based on simplified physical concepts as presented in the *Instruments Development Inquiry* (Instruments and Observing Methods Report No. 24, WMO/TD-No. 231). They depend on the type of precipitation gauge applied. The effect of wind on a particular type of gauge has been assessed by using intercomparison measurements with the WMO reference gauges — the pit gauge for rain and the Double Fence Intercomparison Reference (DFIR) for snow as is shown in the *International Comparison of National Precipitation Gauges with a Reference Pit Gauge* (Instruments and Observing Methods Report No. 17, WMO/TD-No. 38) and by the preliminary results of the WMO Solid Precipitation Measurement Intercomparison. The reduction of wind speed to the level of the gauge orifice should be made according to the following formula:

$$u_{hp} = (\log h z_0^{-1}) \cdot (\log H z_0^{-1})^{-1} \cdot (1 - 0.024\alpha) u_H$$

where u_{hp} is the wind speed at the level of the gauge orifice; h is the height of the gauge orifice above ground; z_0 is the roughness length (0.01 m for winter and 0.03 m for summer); H is the height of the wind speed measuring instrument above ground; u_H is the wind speed measured at the height H above ground; and α is the average vertical angle of obstacles around the gauge.

The latter depends on the exposure of the gauge site and can be based either on the average value of direct measurements, on one of the eight main

directions of the wind rose of the vertical angle of obstacles (in 360°) around the gauge, or on the classification of the exposure using metadata as stored in the archives of Meteorological Services. The classes are as follows:

<i>Class</i>	<i>Angle</i>	<i>Description</i>
Exposed site	0–5	Only a few small obstacles such as bushes, group of trees, a house
Mainly exposed site	6–12	Small groups of trees or bushes or one or two houses
Mainly protected site	13–19	Parks, forest edges, village centres, farms, group of houses, yards
Protected site	20–26	Young forest, small forest clearing, park with big trees, city centres, closed deep valleys, strongly rugged terrain, leeward of big hills

Wetting losses occur with the moistening of the inner walls of the precipitation gauge. They depend on the shape and the material of the gauge, as well as on the type and frequency of precipitation. For example, for the Hellmann gauge they amount to an average of 0.3 mm on a rainy and 0.15 mm on a snowy day; the respective values for the Tretyakov gauge are 0.2 mm and 0.1 mm. Information on wetting losses for other types of gauges can be found in *Methods of Correction for Systematic Error in Point Precipitation Measurement for Operational Use* (WMO-No. 589).

REFERENCES AND FURTHER READING

- Armstrong, R.L., 1976: The application of isotopic profiling snow-gauge data to avalanche research. *Proceedings of the Forty-fourth Annual Western Snow Conference*, Atmospheric Environment Service, Canada, pp. 12–19.
- Goodison, B.E., J.R. Metcalfe, R.A. Wilson and K. Jones, 1988: The Canadian automatic snow depth sensor: A performance update. *Proceedings of the Fifty-sixth Annual Western Snow Conference*, Atmospheric Environment Service, Canada, pp. 178–181.
- Goodison, B.E., B. Sevruk, and S. Klemm, 1989: WMO solid precipitation measurement inter-comparison: Objectives, methodology and analysis. In: International Association of Hydrological Sciences, 1989: *Atmospheric deposition. Proceedings*, Baltimore Symposium (May, 1989) IAHS Publication No. 179, Wallingford.
- Grunow, J., 1960: The productiveness of fog precipitation in relation to the cloud droplet spectrum. In: American Geophysical Union, 1960, *Physics of precipitation*. Geophysical Monograph No. 5, *Proceedings of the Cloud Physics Conference* (3–5 June 1959, Woods Hole, Massachusetts), Publication No. 746, pp. 110–117.
- Grunow, J., 1963: *Weltweite Messungen des Nebelniederschlags nach der Hohenpeissenberger Methode*. In: International Union of Geodesy and Geophysics, General Assembly (Berkeley, California, 19–31 August 1963), International Association of Scientific Hydrology Publication No. 65, 1964, pp. 324–342.
- Loijens, H.S., 1975: Measurements of snow water equivalent and soil moisture by natural gamma radiation. *Proceedings of the Canadian Hydrological Symposium-75* (11–14 August 1975, Winnipeg), pp. 43–50.
- Nespor, V. and B. Sevruk, 1999: Estimation of wind-induced error of rainfall gauge measurements using a numerical simulation. *Journal of Atmospheric and Oceanic Technology*, Volume 16, Number 4, pp. 450–464.
- Rinehart, R.E., 1983: Out-of-level instruments: Errors in hydrometeor spectra and precipitation measurements. *Journal of Climate and Applied Meteorology*, 22, pp. 1404–1410.
- Schemenauer, R.S. and P. Cereceda, 1991: Fog water collection in arid coastal locations. *Ambio*, Volume 20, Number 7, pp. 303–308.
- Schemenauer, R.S. and P. Cereceda, 1994a: Fog collection's role in water planning for developing countries. *Natural Resources Forum*, Volume 18, Number 2, pp. 91–100.
- Schemenauer, R.S. and P. Cereceda, 1994b: A proposed standard fog collector for use in high-elevation regions. *Journal of Applied Meteorology*, Volume 33, Number 11, pp. 1313–1322.
- Sevruk, B., 1974a: Correction for the wetting loss of a Hellman precipitation gauge. *Hydrological Sciences Bulletin*, Volume 19, Number 4, pp. 549–559.
- Sevruk, B., 1974b: Evaporation losses from containers of Hellman precipitation gauges. *Hydrological Sciences Bulletin*, Volume 19, Number 2, pp. 231–236.
- Sevruk, B., 1984: Comments on “Out-of-level instruments: Errors in hydrometeor spectra and precipitation measurements”. *Journal of Climate and Applied Meteorology*, 23, pp. 988–989.
- Sevruk, B. and V. Nespor, 1994: The effect of dimensions and shape of precipitation gauges on the wind-induced error. In: M. Desbois and F. Desalmand (eds.): *Global Precipitation and Climate Change*, NATO ASI Series, I26, Springer Verlag, Berlin, pp. 231–246.
- Sevruk, B. and L. Zahlavova, 1994: Classification system of precipitation gauge site exposure: Evaluation and application. *International Journal of Climatology*, 14(b), pp. 681–689.
- Slovak Hydrometeorological Institute and Swiss Federal Institute of Technology, 1993: Precipitation measurement and quality control. *Proceedings of the International Symposium on Precipitation and Evaporation* (B. Sevruk and M. Lapin, eds) (Bratislava, 20–24 September 1993), Volume I, Bratislava and Zurich.
- Smith, J.L., H.G. Halverson, and R.A. Jones, 1972: *Central Sierra Profiling Snowgauge: A Guide to Fabrication and Operation*. USAEC Report TID-25986, National Technical Information Service, U.S. Department of Commerce, Washington DC.
- Stadtmuller, T. and N. Agudelo, 1990: Amount and variability of cloud moisture input in a tropical cloud forest. In: *Proceedings of the Lausanne Symposia* (August/November), IAHS Publication No. 193, Wallingford.

- Vong, R.J., J.T. Sigmon and S.F. Mueller, 1991: Cloud water deposition to Appalachian forests. *Environmental Science and Technology*, 25(b), pp. 1014–1021.
- World Meteorological Organization, 1972: Evaporation losses from storage gauges (B. Sevruk) *Distribution of Precipitation in Mountainous Areas*, Geilo Symposium (Norway, 31 July–5 August 1972), Volume II, technical papers, WMO-No. 326, Geneva, pp. 96–102.
- World Meteorological Organization, 1982: *Methods of Correction for Systematic Error in Point Precipitation Measurement for Operational Use* (B. Sevruk). Operational Hydrology Report No. 21, WMO-No. 589, Geneva.
- World Meteorological Organization, 1984: *International Comparison of National Precipitation Gauges with a Reference Pit Gauge* (B. Sevruk and W.R. Hamon). Instruments and Observing Methods Report No. 17, WMO/TD-No. 38, Geneva.
- World Meteorological Organization, 1985: *International Organizing Committee for the WMO Solid Precipitation Measurement Intercomparison*. Final report of the first session (distributed to participants only), Geneva.
- World Meteorological Organization, 1986: *Papers Presented at the Workshop on the Correction of Precipitation Measurements* (B. Sevruk, ed.) (Zurich, Switzerland, 1–3 April 1985). Instruments and Observing Methods Report No. 25, WMO/TD-No. 104, Geneva.
- World Meteorological Organization, 1989a: *Catalogue of National Standard Precipitation Gauges* (B. Sevruk and S. Klemm). Instruments and Observing Methods Report No. 39, WMO/TD-No. 313, Geneva.
- World Meteorological Organization, 1989b: *International Workshop on Precipitation Measurements* (B. Sevruk, ed.) (St Moritz, Switzerland, 3–7 December 1989). Instruments and Observing Methods Report No. 48, WMO/TD-No. 328, Geneva.
- World Meteorological Organization, 1992a: *Snow Cover Measurements and Areal Assessment of Precipitation and Soil Moisture* (B. Sevruk, ed.). Operational Hydrology Report No. 35, WMO-No. 749, Geneva.
- World Meteorological Organization, 1992b: *Report on the Measurement of Leaf Wetness* (R.R. Getz). Agricultural Meteorology Report No. 38, WMO/TD-No. 478, Geneva.
- World Meteorological Organization, 1994: *Guide to Hydrological Practices*. Fifth edition, WMO-No. 168, Geneva.
- World Meteorological Organization, 1998: *WMO Solid Precipitation Measurement Intercomparison: Final Report* (B.E. Goodison, P.Y.T. Louie and D. Yang) Instruments and Observing Methods Report No. 67, WMO/TD-No. 872, Geneva.
- Young, G.J., 1976: A portable profiling snow-gauge: Results of field tests on glaciers. *Proceedings of the Forty-fourth Annual Western Snow Conference*, Atmospheric Environment Service, Canada, pp. 7–11.
-

CHAPTER 7

MEASUREMENT OF RADIATION

7.1 GENERAL

The various fluxes of radiation to and from the Earth's surface are among the most important variables in the heat economy of the Earth as a whole and at any individual place at the Earth's surface or in the atmosphere. Radiation measurements are used for the following purposes:

- (a) To study the transformation of energy within the Earth-atmosphere system and its variation in time and space;
- (b) To analyse the properties and distribution of the atmosphere with regard to its constituents, such as aerosols, water vapour, ozone, and so on;
- (c) To study the distribution and variations of incoming, outgoing and net radiation;
- (d) To satisfy the needs of biological, medical, agricultural, architectural and industrial activities with respect to radiation;
- (e) To verify satellite radiation measurements and algorithms.

Such applications require a widely distributed regular series of records of solar and terrestrial surface radiation components and the derivation of representative measures of the net radiation. In addition to the publication of serial values for individual observing stations, an essential objective must be the production of comprehensive radiation climatologies, whereby the daily and seasonal variations of the various radiation constituents of the general thermal budget may be more precisely evaluated and their relationships with other meteorological elements better understood.

A very useful account of radiation measurements and the operation and design of networks of radiation stations is contained in WMO (1986a). This manual describes the scientific principles of the measurements and gives advice on quality assurance, which is most important for radiation measurements. The *Baseline Surface Radiation Network (BSRN) Operations Manual* (WMO, 1998) gives an overview of the latest state of radiation measurements.

Following normal practice in this field, errors and uncertainties are expressed in this chapter as a 66 per cent confidence interval of the difference from the true quantity, which is similar to a standard

deviation of the population of values. Where needed, specific uncertainty confidence intervals are indicated and uncertainties are estimated using the International Organization for Standardization method (ISO, 1995). For example, 95 per cent uncertainty implies that the stated uncertainty is for a confidence interval of 95 per cent.

7.1.1 Definitions

Annex 7.A contains the nomenclature of radiometric and photometric quantities. It is based on definitions recommended by the International Radiation Commission of the International Association of Meteorology and Atmospheric Sciences and by the International Commission on Illumination (ICI). Annex 7.B gives the meteorological radiation quantities, symbols and definitions.

Radiation quantities may be classified into two groups according to their origin, namely solar and terrestrial radiation. In the context of this chapter, "radiation" can imply a process or apply to multiple quantities. For example, "solar radiation" could mean solar energy, solar exposure or solar irradiance (see Annex 7.B).

Solar energy is the electromagnetic energy emitted by the sun. The solar radiation incident on the top of the terrestrial atmosphere is called extraterrestrial solar radiation; 97 per cent of which is confined to the spectral range 290 to 3 000 nm is called solar (or sometimes short-wave) radiation. Part of the extra-terrestrial solar radiation penetrates through the atmosphere to the Earth's surface, while part of it is scattered and/or absorbed by the gas molecules, aerosol particles, cloud droplets and cloud crystals in the atmosphere.

Terrestrial radiation is the long-wave electromagnetic energy emitted by the Earth's surface and by the gases, aerosols and clouds of the atmosphere; it is also partly absorbed within the atmosphere. For a temperature of 300 K, 99.99 per cent of the power of the terrestrial radiation has a wavelength longer than 3 000 nm and about 99 per cent longer than 5 000 nm. For lower temperatures, the spectrum is shifted to longer wavelengths.

Since the spectral distributions of solar and terrestrial radiation overlap very little, they can very often be treated separately in measurements and computations. In meteorology, the sum of both types is called total radiation.

Light is the radiation visible to the human eye. The spectral range of visible radiation is defined by the spectral luminous efficiency for the standard observer. The lower limit is taken to be between 360 and 400 nm, and the upper limit between 760 and 830 nm (ICI, 1987). Thus, 99 per cent of the visible radiation lies between 400 and 730 nm. The radiation of wavelengths shorter than about 400 nm is called ultraviolet (UV), and longer than about 800 nm, infrared radiation. The UV range is sometimes divided into three sub-ranges (IEC, 1987):

UV-A:	315–400 nm
UV-B:	280–315 nm
UV-C:	100–280 nm

7.1.2 Units and scales

7.1.2.1 Units

The International System of Units (SI) is to be preferred for meteorological radiation variables. A general list of the units is given in Annexes 7.A and 7.B.

7.1.2.2 Standardization

The responsibility for the calibration of radiometric instruments rests with the World, Regional and National Radiation Centres, the specifications for which are given in Annex 7.C. Furthermore, the World Radiation Centre (WRC) at Davos is responsible for maintaining the basic reference, the World Standard Group (WSG) of instruments, which is used to establish the World Radiometric Reference (WRR). During international comparisons, organized every five years, the standards of the regional centres are compared with the WSG, and their calibration factors are adjusted to the WRR. They, in turn, are used to transmit the WRR periodically to the national centres, which calibrate their network instruments using their own standards.

Definition of the World Radiometric Reference

In the past, several radiation references or scales have been used in meteorology, namely the Ångström scale of 1905, the Smithsonian scale of 1913, and the international pyr heliometric scale of 1956 (IPS 1956). The developments in absolute radiometry in recent years have very much reduced

the uncertainty of radiation measurements. With the results of many comparisons of 15 individual absolute pyr heliometers of 10 different types, a WRR has been defined. The old scales can be transferred into the WRR using the following factors:

$$\frac{\text{WRR}}{\text{Ångström scale 1905}} = 1.026$$

$$\frac{\text{WRR}}{\text{Smithsonian scale 1913}} = 0.977$$

$$\frac{\text{WRR}}{\text{IPS 1956}} = 1.026$$

The WRR is accepted as representing the physical units of total irradiance within 0.3 per cent (99 per cent uncertainty of the measured value).

Realization of the World Radiometric Reference: World Standard Group

In order to guarantee the long-term stability of the new reference, a group of at least four absolute pyr heliometers of different design is used as the WSG. At the time of incorporation into this group, the instruments are given a reduction factor to correct their readings to the WRR. To qualify for membership of this group, a radiometer must fulfil the following specifications:

- Long-term stability must be better than 0.2 per cent of the measured value;
- The 95 per cent uncertainty of the series of measurements with the instrument must lie within the limits of the uncertainty of the WRR;
- The instrument has to have a different design from the other WSG instruments.

To meet the stability criteria, the instruments of the WSG are the subjects of an inter-comparison at least once a year, and, for this reason, WSG is kept at the WRC Davos.

Computation of world radiometric reference values

In order to calibrate radiometric instruments, the reading of a WSG instrument, or one that is directly traceable to the WSG, should be used. During international pyr heliometer comparisons (IPCs), the WRR value is calculated from the mean of at least three participating instruments of the WSG. To yield WRR values, the readings of the WSG instruments are always corrected with the individual reduction factor, which is determined at the time of their

incorporation into the WSG. Since the calculation of the mean value of the WSG, serving as the reference, may be jeopardized by the failure of one or more radiometers belonging to the WSG, the Commission for Instruments and Methods of Observation resolved¹ that at each IPC an ad hoc group should be established comprising the Rapporteur on Meteorological Radiation Instruments (or designate) and at least five members, including the chairperson. The director of the comparison must participate in the group's meetings as an expert. The group should discuss the preliminary results of the comparison, based on criteria defined by the WRC, evaluate the reference and recommend the updating of the calibration factors.

7.1.3 Meteorological requirements

7.1.3.1 Data to be recorded

Irradiance and radiant exposure are the quantities most commonly recorded and archived, with averages and totals of over 1 h. There are also many requirements for data over shorter periods, down to 1 min or even tens of seconds (for some energy applications). Daily totals of radiant exposure are frequently used, but these are expressed as a mean daily irradiance. For climatological purposes, measurements of direct solar radiation shorter than a day are needed at fixed true solar hours, or at fixed air-mass values. Measurements of atmospheric extinction must be made with very short response times to reduce the uncertainties arising from variations in air mass.

For radiation measurements, it is particularly important to record and make available information about the circumstances of the observations. This includes the type and traceability of the instrument, its calibration history, and its location in space and time, spatial exposure and maintenance record.

7.1.3.2 Uncertainty

Statements of uncertainty for net radiation are given in Part I, Chapter 1. The required 66 per cent uncertainty for radiant exposure for a day, stated by WMO for international exchange, is 0.4 MJ m^{-2} for $\leq 8 \text{ MJ m}^{-2}$ and 5 per cent for $> 8 \text{ MJ m}^{-2}$.

There are no formally agreed statements of required uncertainty for other radiation quantities, but uncertainty is discussed in the sections of this chapter dealing with the various types of measurements,

and best practice uncertainties are stated for the Global Climate Observing System's Baseline Surface Radiation Network (see WMO, 1998). It may be said generally that good quality measurements are difficult to achieve in practice, and for routine operations they can be achieved only with modern equipment and redundant measurements. Some systems still in use fall short of best practice, the lesser performance having been acceptable for many applications. However, data of the highest quality are increasingly in demand.

7.1.3.3 Sampling and recording

The uncertainty requirements can best be satisfied by making observations at a sampling period less than the $1/e$ time-constant of the instrument, even when the data to be finally recorded are integrated totals for periods of up to 1 h, or more. The data points may be integrated totals or an average flux calculated from individual samples. Digital data systems are greatly to be preferred. Chart recorders and other types of integrators are much less convenient, and the resultant quantities are difficult to maintain at adequate levels of uncertainty.

7.1.3.4 Times of observation

In a worldwide network of radiation measurements, it is important that the data be homogeneous not only for calibration, but also for the times of observation. Therefore, all radiation measurements should be referred to what is known in some countries as local apparent time, and in others as true solar time. However, standard or universal time is attractive for automatic systems because it is easier to use, but is acceptable only if a reduction of the data to true solar time does not introduce a significant loss of information (that is to say, if the sampling and storage rates are high enough, as indicated in section 7.1.3.3 above). See Annex 7.D for useful formulae for the conversion from standard to solar time.

7.1.4 Measurement methods

Meteorological radiation instruments are classified using various criteria, namely the type of variable to be measured, the field of view, the spectral response, the main use, and the like. The most important types of classifications are listed in Table 7.1. The quality of the instruments is characterized by items (a) to (h) below. The instruments and their operation are described in sections 7.2 to 7.4 below. WMO (1986a) provides a detailed account of instruments and the principles according to which they operate.

¹ Recommended by the Commission for Instruments and Methods of Observation at its eleventh session (1994).

Absolute radiometers are self-calibrating, meaning that the irradiance falling on the sensor is replaced by electrical power, which can be accurately measured. The substitution, however, cannot be perfect; the deviation from the ideal case determines the uncertainty of the radiation measurement.

Most radiation sensors, however, are not absolute and must be calibrated against an absolute instrument. The uncertainty of the measured value, therefore, depends on the following factors, all of which should be known for a well-characterized instrument:

- (a) Resolution, namely, the smallest change in the radiation quantity which can be detected by the instrument;
- (b) Long-term drifts of sensitivity (the ratio of electrical output signal to the irradiance applied),

namely, the maximum possible changeover, for example, one year;

- (c) Changes in sensitivity owing to changes of environmental variables, such as temperature, humidity, pressure and wind;
- (d) Non-linearity of response, namely, changes in sensitivity associated with variations in irradiance;
- (e) Deviation of the spectral response from that postulated, namely the blackness of the receiving surface, the effect of the aperture window, and so on;
- (f) Deviation of the directional response from that postulated, namely cosine response and azimuth response;
- (g) Time-constant of the instrument or the measuring system;
- (h) Uncertainties in the auxiliary equipment.

Table 7.1. Meteorological radiation instruments

<i>Instrument classification</i>	<i>Parameter to be measured</i>	<i>Main use</i>	<i>Viewing angle (sr) (see Figure 7.1)</i>
Absolute pyrheliometer	Direct solar radiation	Primary standard	5×10^{-3} (approx. 2.5° half angle)
Pyrheliometer	Direct solar radiation	(a) Secondary standard for calibrations (b) Network	5×10^{-3} to 2.5×10^{-2}
Spectral pyrheliometer	Direct solar radiation in broad spectral bands (e.g., with OG 530, RG 630, etc. filters)	Network	5×10^{-3} to 2.5×10^{-2}
Sunphotometer	Direct solar radiation in narrow spectral bands (e.g., at 500 ± 2.5 nm, 368 ± 2.5 nm)	(a) Standard (b) Network	1×10^{-3} to 1×10^{-2} (approx. 2.3° full angle)
Pyranometer	(a) Global (solar) radiation (b) Diffuse sky (solar) radiation (c) Reflected solar radiation	(a) Working standard (b) Network	2π
Spectral pyranometer	Global (solar) radiation in broadband spectral ranges (e.g., with OG 530, RG 630, etc. filters)	Network	2π
Net pyranometer	Net global (solar) radiation	(a) Working standard (b) Network	4π
Pyrgeometer	(a) Upward long-wave radiation (downward-looking) (b) Downward long-wave radiation (upward-looking)	Network	2π
Pyrradiometer	Total radiation	Working standard	2π
Net pyrradiometer	Net total radiation	Network	4π

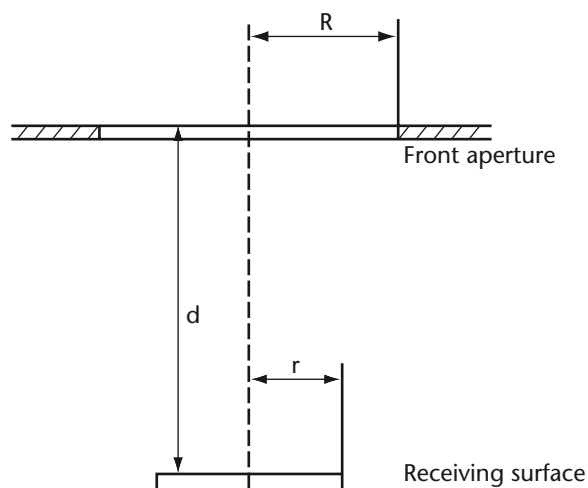

Figure 7.1. View-limiting geometry: The opening half-angle is $\arctan R/d$; the slope angle is $\arctan (R-r)/d$

Instruments should be selected according to their end-use and the required uncertainty of the derived quantity. Certain instruments perform better for particular climates, irradiances and solar positions

7.2 MEASUREMENT OF DIRECT SOLAR RADIATION

Direct solar radiation is measured by means of pyrheliometers, the receiving surfaces of which are arranged to be normal to the solar direction. By means of apertures, only the radiation from the sun and a narrow annulus of sky is measured, the latter radiation component is sometimes referred to as circumsolar radiation or aureole radiation. In modern instruments, this extends out to a half-angle of about 2.5° on some models, and to about 5° from the sun's centre (corresponding, respectively, to $5 \cdot 10^{-3}$ and $5 \cdot 10^{-2}$ sr). The construction of the pyrheliometer mounting must allow for the rapid and smooth adjustment of the azimuth and elevation angles. A sighting device is usually included in which a small spot of light or solar image falls upon a mark in the centre of the target when the receiving surface is exactly normal to the direct solar beam. For continuous recording, it is advisable to use automatic sun-following equipment (sun tracker).

As to the view-limiting geometry, it is recommended that the opening half-angle be 2.5° ($5 \cdot 10^{-3}$ sr) and the slope angle 1° for all new designs of direct solar radiation instruments. For

the definition of these angles refer to Figure 7.1. During the comparison of instruments with different view-limiting geometries, it should be kept in mind that the aureole radiation influences the readings more significantly for larger slope and aperture angles. The difference can be as great as 2 per cent between the two apertures mentioned above for an air mass of 1.0. In order to enable climatological comparison of direct solar radiation data during different seasons, it may be necessary to reduce all data to a mean sun-Earth distance:

$$E_N = E/R^2 \quad (7.1)$$

where E_N is the solar radiation, normalized to the mean sun-Earth distance, which is defined to be one astronomical unit (AU) (see Annex 7.D); E is the measured direct solar radiation; and R is the sun-Earth distance in astronomical units.

7.2.1 Direct solar radiation

Some of the characteristics of operational pyrheliometers (other than primary standards) are given in Table 7.2 (adapted from ISO, 1990a), with indicative estimates of the uncertainties of measurements made with them if they are used with appropriate expertise and quality control. Cheaper pyrheliometers are available (see ISO, 1990a), but without effort to characterize their response the resulting uncertainties reduce the quality of the data, and, given that a sun tracker is required, in most cases the incremental cost for a good pyrheliometer is minor. The estimated uncertainties are based on the following assumptions:

- Instruments are well-maintained, correctly aligned and clean;
- 1 min and 1 h figures are for clear-sky irradiances at solar noon;
- Daily exposure values are for clear days at mid-latitudes.

7.2.1.1 Primary standard pyrheliometers

An absolute pyrheliometer can define the scale of total irradiance without resorting to reference sources or radiators. The limits of uncertainty of the definition must be known; the quality of this knowledge determines the reliability of an absolute pyrheliometer. Only specialized laboratories should operate and maintain primary standards. Details of their construction and operation are given in WMO (1986a). However, for the sake of completeness, a brief account is given here.

All absolute pyrheliometers of modern design use cavities as receivers and electrically calibrated, differential heat-flux meters as sensors. At present, this combination has proved to yield the lowest uncertainty possible for the radiation levels encountered in solar radiation measurements (namely, up to 1.5 kW m^{-2}).

Normally, the electrical calibration is performed by replacing the radiative power by electrical power, which is dissipated in a heater winding as close as possible to where the absorption of solar radiation takes place.

The uncertainties of such an instrument's measurements are determined by a close examination of the physical properties of the instrument and by performing laboratory measurements and/or model calculations to determine the deviations from ideal behaviour, that is, how perfectly the electrical substitution can be achieved. This procedure is called characterization of the instrument.

The following specification should be met by an absolute pyrheliometer (an individual instrument, not a type) to be designated and used as a primary standard:

- (a) At least one instrument out of a series of manufactured radiometers has to be fully characterized. The 95 per cent uncertainty of this characterization should be less than 2 W m^{-2} under the clear-sky conditions suitable for calibration (see ISO, 1990a). The 95 per cent uncertainty (for all components of the uncertainty) for a series of measurements should not exceed 4 W m^{-2} for any measured value;
- (b) Each individual instrument of the series must be compared with the one which has been characterized, and no individual instrument should deviate from this instrument by more than the characterization uncertainty as determined in (a) above;
- (c) A detailed description of the results of such comparisons and of the characterization of the instrument should be made available upon request;
- (d) Traceability to the WRR by comparison with the WSG or some carefully established reference with traceability to the WSG is needed in order to prove that the design is within the state of the art. The latter is fulfilled if the 95 per cent uncertainty for a series of measurements traceable to the WRR is less than 1 W m^{-2} .

Table 7.2. Characteristics of operational pyrheliometers

<i>Characteristic</i>	<i>High quality^a</i>	<i>Good quality^b</i>	
Response time (95 per cent response)	< 15 s	< 30 s	
Zero offset (response to 5 K h^{-1} change in ambient temperature)	2 W m^{-2}	4 W m^{-2}	
Resolution (smallest detectable change in W m^{-2})	0.51	1	
Stability (percentage of full scale, change/year)	0.1	0.5	
Temperature response (percentage maximum error due to change of ambient temperature within an interval of 50 K)	1	2	
Non-linearity (percentage deviation from the responsivity at 500 W m^{-2} due to the change of irradiance within 100 W m^{-2} to $1\,100 \text{ W m}^{-2}$)	0.2	0.5	
Spectral sensitivity (percentage deviation of the product of spectral absorptance and spectral transmittance from the corresponding mean within the range 300 to 3 000 nm)	0.5	1.0	
Tilt response (percentage deviation from the responsivity at 0° tilt (horizontal) due to change in tilt from 0° to 90° at $1\,000 \text{ W m}^{-2}$)	0.2	0.5	
Achievable uncertainty, 95 per cent confidence level (see above)			
1 min totals	per cent	0.9	1.8
	kJ m^{-2}	0.56	1
1 h totals	per cent	0.7	1.5
	kJ m^{-2}	21	54
Daily totals	per cent	0.5	1.0
	kJ m^{-2}	200	400

Notes:

- ^a Near state of the art; suitable for use as a working standard; maintainable only at stations with special facilities and staff.
- ^b Acceptable for network operations.

7.2.1.2 Secondary standard pyrheliometers

An absolute pyrheliometer which does not meet the specification for a primary standard or which

is not fully characterized can be used as a secondary standard if it is calibrated by comparison with the WSG with a 95 per cent uncertainty for a series of measurements less than 1 W m^{-2} .

Other types of instruments with measurement uncertainties similar or approaching those for primary standards may be used as secondary standards.

The Ångström compensation pyrheliometer has been, and still is, used as a convenient secondary standard instrument for the calibration of pyranometers and other pyrheliometers. It was designed by K. Ångström as an absolute instrument, and the Ångström scale of 1905 was based on it; now it is used as a secondary standard and must be calibrated against a standard instrument.

The sensor consists of two platinized manganin strips, each of which is about 18 mm long, 2 mm wide and about 0.02 mm thick. They are blackened with a coating of candle soot or with an optical matt black paint. A thermo-junction of copper-constantan is attached to the back of each strip so that the temperature difference between the strips can be indicated by a sensitive galvanometer or an electrical micro-voltmeter. The dimensions of the strip and front diaphragm yield opening half-angles and slope angles as listed in Table 7.3.

Table 7.3. View-limiting geometry of Ångström pyrheliometers

Angle	Vertical	Horizontal
Opening half-angle	$5^\circ - 8^\circ$	$\sim 2^\circ$
Slope angle	$0.7^\circ - 1.0^\circ$	$1.2^\circ - 1.6^\circ$

The measurement set consists of three or more cycles, during which the left- or right-hand strip is alternately shaded from or exposed to the direct solar beam. The shaded strip is heated by an electric current, which is adjusted in such a way that the thermal electromagnetic force of the thermocouple and, hence, the temperature difference between the two strips approximate zero. Before and after a measuring sequence, the zero is checked either by shading or by exposing both strips simultaneously. Depending on which of these methods is used and on the operating instructions of the manufacturer, the irradiance calculation differs slightly. The method adopted for the IPCs uses the following formula:

$$E = K \cdot i_L \cdot i_R \quad (7.2)$$

where E is the irradiance in W m^{-2} ; K is the calibration constant determined by comparison with a primary standard ($\text{W m}^{-2} \text{ A}^{-2}$); and i_L , i_R is the current in amperes measured with the left- or right-hand strip exposed to the direct solar beam, respectively.

Before and after each series of measurements, the zero of the system is adjusted electrically by using either of the foregoing methods, the zeros being called “cold” (shaded) or “hot” (exposed), as appropriate. Normally, the first reading, say i_R , is excluded and only the following i_L - i_R pairs are used to calculate the irradiance. When comparing such a pyrheliometer with other instruments, the irradiance derived from the currents corresponds to the geometric mean of the solar irradiances at the times of the readings of i_L and i_R .

The auxiliary instrumentation consists of a power supply, a current-regulating device, a nullmeter and a current monitor.

The sensitivity of the nullmeter should be about $0.05 \cdot 10^{-6} \text{ A}$ per scale division for a low-input impedance ($< 10 \Omega$), or about $0.5 \mu\text{V}$ with a high-input impedance ($> 10 \text{ K}\Omega$). Under these conditions, a temperature difference of about 0.05 K between the junction of the copper-constantan thermocouple causes a deflection of one scale division, which indicates that one of the strips is receiving an excess heat supply amounting to about 0.3 per cent.

The uncertainty of the derived direct solar irradiance is highly dependent on the qualities of the current-measuring device, whether a moving-coil milliammeter or a digital multi-meter which measures the voltage across a standard resistor, and on the operator’s skill. The fractional error in the output value of irradiance is twice as large as the fractional error in the reading of the electric current. The heating current is directed to either strip by means of a switch and is normally controlled by separate rheostats in each circuit. The switch can also cut the current off so that the zero can be determined. The resolution of the rheostats should be sufficient to allow the nullmeter to be adjusted to within one half of a scale division.

7.2.1.3 Field and network pyrheliometers

These pyrheliometers generally make use of a thermopile as the detector. They have similar view-limiting geometry as standard pyrheliometers. Older models tend to have larger fields of view and slope angles. These design features were primarily designed to reduce the need for accurate sun

tracking. However, the larger the slope (and opening) angle, the larger the amount of aureole radiation sensed by the detector; this amount may reach several per cent for high optical depths and large limiting angles. With new designs of sun trackers, including computer-assisted trackers in both passive and active (sun-seeking) configurations, the need for larger slope angles is unnecessary. However, a slope angle of 1° is still required to ensure that the energy from the direct solar beam is distributed evenly on the detector; and allows for minor sun tracker pointing errors of the order of 0.1° .

The intended use of the pyrheliometer may dictate the selection of a particular type of instrument. Some manually oriented models, such as the Linke Fuessner Actinometer, are used mainly for spot measurements, while others such as the EKO, Eppley, Kipp and Zonen, and Middleton types are designed specifically for the long-term monitoring of direct irradiance. Before deploying an instrument, the user must consider the significant differences found among operational pyrheliometers as follows:

- (a) The field of view of the instrument;
- (b) Whether the instrument measures both the long-wave and short-wave portion of the spectrum (namely, whether the aperture is open or covered with a glass or quartz window);
- (c) The temperature compensation or correction methods;
- (d) The magnitude and variation of the zero irradiance signal;
- (e) If the instrument can be installed on an automated tracking system for long-term monitoring;
- (f) If, for the calibration of other operational pyrheliometers, differences (a) to (c) above are the same, and if the pyrheliometer is of the quality required to calibrate other network instruments.

7.2.1.4 Calibration of pyrheliometers

All pyrheliometers, other than absolute pyrheliometers, must be calibrated by comparison using the sun as the source with a pyrheliometer that has traceability to the WSG and a likely uncertainty of calibration equal to or better than the pyrheliometer being calibrated.

As all solar radiation data must be referred to the WRR, absolute pyrheliometers also use a factor determined by comparison with the WSG and not their individually determined one. After such a compari-

son (for example, during the periodically organized IPCs) such a pyrheliometer can be used as a standard to calibrate, again by comparison with the sun as a source, secondary standards and field pyrheliometers. Secondary standards can also be used to calibrate field instruments, but with increased uncertainty.

The quality of sun-source calibrations may depend on the aureole influence if instruments with different view-limiting geometries are compared. Also, the quality of the results will depend on the variability of the solar irradiance, if the time-constants and zero irradiance signals of the pyrheliometers are significantly different. Lastly, environmental conditions, such as temperature, pressure and net long-wave irradiance, can influence the results. If a very high quality of calibration is required, only data taken during very clear and stable days should be used.

The procedures for the calibration of field pyrheliometers are given in an ISO standard (ISO, 1990*b*).

From recent experience at IPCs, a period of five years between traceable calibrations to the WSG should suffice for primary and secondary standards. Field pyrheliometers should be calibrated every one to two years; the more prolonged the use and the more rigorous the conditions, the more often they should be calibrated.

7.2.2 Spectral direct solar irradiance and measurement of optical depth

Spectral measurements of the direct solar irradiance are used in meteorology mainly to determine optical depth (see Annex 7.B) in the atmosphere. They are used also for medical, biological, agricultural and solar-energy applications.

The aerosol optical depth represents the total extinction, namely, scattering and absorption by aerosols in the size range 100 to 10 000 nm radius, for the column of the atmosphere equivalent to unit optical air mass. Particulate matter, however, is not the only influencing factor for optical depth. Other atmospheric constituents such as air molecules (Rayleigh scatterers), ozone, water vapour, nitrogen dioxide and carbon dioxide also contribute to the total extinction of the beam. Most optical depth measurements are taken to understand better the loading of the atmosphere by aerosols. However, optical depth measurements of other constituents, such as water vapour, ozone and nitrogen dioxide, can be obtained if appropriate wavebands are selected.

Table 7.4. Specification of idealized Schott glass filters

Schott type	Typical 50% cut-off wavelength (nm)		Mean transmission (3 mm thickness)	Approximate temperature coefficient of short-wave cut-off (nm K ⁻¹)
	Short	Long		
OG 530	526 ± 2	2 900	0.92	0.12
RG 630	630 ± 2	2 900	0.92	0.17
RG 700	702 ± 2	2 900	0.92	0.18

The temperature coefficients for Schott filters are as given by the manufacturer. The short-wave cut-offs are adjusted to the standard filters used for calibration. Checks on the short and long wavelength cut-offs are required for reducing uncertainties in derived quantities.

The aerosol optical depth $\delta_a(\lambda)$ at a specific wavelength λ is based on the Bouguer-Lambert law (or Beer's law for monochromatic radiation) and can be determined by:

$$\delta_a(\lambda) = \frac{\ln(E_0(\lambda)/E(\lambda)) - \sum(\delta_i(\lambda) \cdot m_i)}{m_a} \quad (7.3)$$

where $\delta_a(\lambda)$ is the aerosol optical depth at a waveband centred at wavelength λ ; m_a is the air mass for aerosols (unity for the vertical beam); δ_i is the optical depth for species i , other than aerosols at a waveband centred at wavelength λ ; m_i is the air mass for extinction species i , other than aerosols; $E_0(\lambda)$ is the spectral solar irradiance outside the atmosphere at wavelength λ ; and $E(\lambda)$ is the spectral solar irradiance at the surface at wavelength λ .

Optical thickness is the total extinction along the path through the atmosphere, that is, the air mass multiplied by the optical depth $m\delta$.

Turbidity τ is the same quantity as optical depth, but using base 10 rather than base e in Beer's Law, as follows:

$$\tau(\lambda)m = \log(E_0(\lambda)/E(\lambda)) \quad (7.4)$$

accordingly:

$$\tau(\lambda) = 2.301\delta(\lambda) \quad (7.5)$$

In meteorology, two types of measurements are performed, namely broadband pyrheliometry and narrowband sun radiometry (sometimes called sun photometry). Since the aerosol optical depth is defined only for monochromatic radiation or for a very narrow wavelength range, it can be applied

directly to the evaluation of sun photometer data, but not to broadband pyrheliometer data.

Aerosol optical depth observations should be made only when no visible clouds are within 10° of the sun. When sky conditions permit, as many observations as possible should be made in a day and a maximum range of air masses should be covered, preferably in intervals of Δm less than 0.2.

Only instantaneous values can be used for the determination of aerosol optical depth; instantaneous means that the measurement process takes less than 1 s.

7.2.2.1 Broadband pyrheliometry

Broadband pyrheliometry makes use of a carefully calibrated pyrheliometer with broadband glass filters in front of it to select the spectral bands of interest. The specifications of the classical filters used are summarized in Table 7.4.

The cut-off wavelengths depend on temperature, and some correction of the measured data may be needed. The filters must be properly cleaned before use. In operational applications, they should be checked daily and cleaned if necessary.

The derivation of aerosol optical depth from broadband data is very complex, and there is no standard procedure. Use may be made both of tables which are calculated from typical filter data and of some assumptions on the state of the atmosphere. The reliability of the results depends on how well the filter used corresponds to the filter in the calculations and how good the atmospheric assumptions are. Details of the evaluation and the corresponding tables can be found in WMO (1978). A discussion of the techniques is given by Kuhn (1972) and Lal (1972).

7.2.2.2 Sun radiometry (photometry) and aerosol optical depth

A narrowband sun radiometer (or photometer) usually consists of a narrowband interference filter and a photovoltaic detector, usually a silicon photodiode. The full field of view of the instrument is 2.5° with a slope angle of 1° (see Figure 7.1). Although the derivation of optical depth using these devices is conceptually simple, many early observations from these devices have not produced useful results. The main problems have been the shifting of the instrument response because of changing filter transmissions and detector characteristics over short periods, and poor operator training for manually operated devices. Accurate results can be obtained with careful operating procedures and frequent checks of instrument stability. The instrument should be calibrated frequently, preferably using in situ methods or using reference devices maintained by a radiation centre with expertise in optical depth determination.

Detailed advice on narrowband sun radiometers and network operations is given in WMO (1993a).

To calculate aerosol optical depth from narrowband sun radiometer data with small uncertainty, the station location, pressure, temperature, column ozone amount, and an accurate time of measurement must be known (WMO, 2005). The most accurate calculation of the total and aerosol optical depth from spectral data at wavelength λ (the centre wavelength of its filter) makes use of the following:

$$\delta_a(\lambda) = \frac{\ln\left(\frac{S_0(\lambda)}{S(\lambda)R^2}\right) - \frac{P}{P_0}\delta_R(\lambda)m_R - \delta_{O_3}(\lambda)m_{O_3}\dots}{m_a} \quad (7.6)$$

where $S(\lambda)$ is the instrument reading (for example, in volts or counts), $S_0(\lambda)$ is the hypothetical reading corresponding to the top of the atmosphere spectral solar irradiance at 1 AU (this can be established by extrapolation to air-mass zero by various Langley methods, or from the radiation centre which calibrated the instrument); R is the sun-Earth distance (in astronomical units; see Annex 7.D); P is the atmospheric pressure; P_0 is the standard atmospheric pressure, and the second, third and subsequent terms in the top line are the contributions of Rayleigh, ozone and other extinctions. This can be simplified for less accurate work by assuming that the relative air masses for each of the components are equal.

For all wavelengths, Rayleigh extinction must be considered. Ozone optical depth must be considered at wavelengths of less than 340 nm and throughout the Chappius band. Nitrogen dioxide optical depths should be considered for all wavelengths less than 650 nm, especially if measurements are taken in areas that have urban influences. Although there are weak water vapour absorption bands even within the 500 nm spectral region, water vapour absorption can be neglected for wavelengths less than 650 nm. Further references on wavelength selection can be found in WMO (1986b).

A simple algorithm to calculate Rayleigh-scattering optical depths is a combination of the procedure outlined by Fröhlich and Shaw (1980), and the Young (1981) correction. For more precise calculations the algorithm by Bodhaine and others (1999) is also available. Both ozone and nitrogen dioxide follow Beer's law of absorption. The WMO World Ozone Data Centre recommends the ozone absorption coefficients of Bass and Paur (1985) in the UV region and Vigroux (1953) in the visible region. Nitrogen dioxide absorption coefficients can be obtained from Schneider and others (1987). For the reduction of wavelengths influenced by water vapour, the work of Frouin, Deschamps and Lecomte (1990) may be considered. Because of the complexity of water vapour absorption, bands that are influenced significantly should be avoided unless deriving water vapour amount by spectral solar radiometry.

7.2.3 Exposure

For continuous recording and reduced uncertainties, an accurate sun tracker that is not influenced by environmental conditions is essential. Sun tracking to within 0.2° is required, and the instruments should be inspected at least once a day, and more frequently if weather conditions so demand (with protection against adverse conditions).

The principal exposure requirement for a recording instrument is the same as that for a pyrliometer namely, freedom from obstructions to the solar beam at all times and seasons of the year. Furthermore, the site should be chosen so that the incidence of fog, smoke and airborne pollution is as typical as possible of the surrounding area.

For continuous recording, protection is needed against rain, snow, and so forth. The optical window, for instance, must be protected as it is usually made of quartz and is located in front of the instrument. Care must be taken to ensure that such a window is kept clean and that

condensation does not appear on the inside. For successful derivation of aerosol optical depth such attention is required, as a 1 per cent change in transmission at unit air mass translates into a 0.010 change in optical depth. For example, for transmission measurements at 500 nm at clean sea-level sites, a 0.010 change represents between 20 to 50 per cent of the mean winter aerosol optical depth.

7.3 MEASUREMENT OF GLOBAL AND DIFFUSE SKY RADIATION

The solar radiation received from a solid angle of 2π sr on a horizontal surface is referred to as global radiation. This includes radiation received directly from the solid angle of the sun's disc, as well as diffuse sky radiation that has been scattered in traversing the atmosphere.

The instrument needed for measuring solar radiation from a solid angle of 2π sr into a plane surface and a spectral range from 300 to 3 000 nm is the pyranometer. The pyranometer is sometimes used to measure solar radiation on surfaces inclined in the horizontal and in the inverted position to measure reflected global radiation. When measuring the diffuse sky component of solar radiation, the direct solar component is screened from the pyranometer by a shading device (see section 7.3.3.3).

Pyranometers normally use thermo-electric, photoelectric, pyro-electric or bimetallic elements as sensors. Since pyranometers are exposed continually in all weather conditions they must be robust in design and resist the corrosive effects of humid air (especially near the sea). The receiver should be hermetically sealed inside its casing, or the casing must be easy to take off so that any condensed moisture can be removed. Where the receiver is not permanently sealed, a desiccator is usually fitted in the base of the instrument. The properties of pyranometers which are of concern when evaluating the uncertainty and quality of radiation measurement are: sensitivity, stability, response time, cosine response, azimuth response, linearity, temperature response, thermal offset, zero irradiance signal and spectral response. Further advice on the use of pyranometers is given in ISO (1990c) and WMO (1998).

Table 7.5 (adapted from ISO, 1990a) describes the characteristics of pyranometers of various levels of performance, with the uncertainties that may be

achieved with appropriate facilities, well-trained staff and good quality control under the sky conditions outlined in 7.2.1.

7.3.1 Calibration of pyranometers

The calibration of a pyranometer consists of the determination of one or more calibration factors and the dependence of these on environmental conditions, such as:

- (a) Temperature;
- (b) Irradiance level;
- (c) Spectral distribution of irradiance;
- (d) Temporal variation;
- (e) Angular distribution of irradiance;
- (f) Inclination of instrument;
- (g) The net long-wave irradiance for thermal offset correction;
- (h) Calibration methods.

Normally, it is necessary to specify the test environmental conditions, which can be quite different for different applications. The method and conditions must also be given in some detail in the calibration certificate.

There are a variety of methods for calibrating pyranometers using the sun or laboratory sources. These include the following:

- (a) By comparison with a standard pyrhelimeter for the direct solar irradiance and a calibrated shaded pyranometer for the diffuse sky irradiance;
- (b) By comparison with a standard pyrhelimeter using the sun as a source, with a removable shading disc for the pyranometer;
- (c) With a standard pyrhelimeter using the sun as a source and two pyranometers to be calibrated alternately measuring global and diffuse irradiance;
- (d) By comparison with a standard pyranometer using the sun as a source, under other natural conditions of exposure (for example, a uniform cloudy sky and direct solar irradiance not statistically different from zero);
- (e) In the laboratory, on an optical bench with an artificial source, either normal incidence or at some specified azimuth and elevation, by comparison with a similar pyranometer previously calibrated outdoors;
- (f) In the laboratory, with the aid of an integrating chamber simulating diffuse sky radiation, by comparison with a similar type of pyranometer previously calibrated outdoors.

These are not the only methods; (a), (b) and (c) and (d) are commonly used. However, it is essential that,

Table 7.5. Characteristics of operational pyranometers

<i>Characteristic</i>	<i>High quality^a</i>	<i>Good quality^b</i>	<i>Moderate quality^c</i>
Response time (95 per cent response)	< 15 s	< 30 s	< 60 s
Zero offset:			
(a) Response to 200 W m ⁻² net thermal radiation (ventilated)	7 W m ⁻²	15 W m ⁻²	30 W m ⁻²
(b) Response to 5 K h ⁻¹ change in ambient temperature	2 W m ⁻²	4 W m ⁻²	8 W m ⁻²
Resolution (smallest detectable change)	1 W m ⁻²	5 W m ⁻²	10 W m ⁻²
Stability (change per year, percentage of full scale)	0.8	1.5	3.0
Directional response for beam radiation (the range of errors caused by assuming that the normal incidence responsivity is valid for all directions when measuring, from any direction, a beam radiation whose normal incidence irradiance is 1 000 W m ⁻²)	10 W m ⁻²	20 W m ⁻²	30 W m ⁻²
Temperature response (percentage maximum error due to any change of ambient temperature within an interval of 50 K)	2	4	8
Non-linearity (percentage deviation from the responsivity at 500 W m ⁻² due to any change of irradiance within the range 100 to 1 000 W m ⁻²)	0.5	1	3
Spectral sensitivity (percentage deviation of the product of spectral absorptance and spectral transmittance from the corresponding mean within the range 300 to 3 000 nm)	2	5	10
Tilt response (percentage deviation from the responsivity at 0° tilt (horizontal) due to change in tilt from 0° to 90° at 1 000 W m ⁻²)	0.5	2	5
Achievable uncertainty (95 per cent confidence level):			
Hourly totals	3%	8%	20%
Daily totals	2%	5%	10%

Notes:

^a Near state of the art; suitable for use as a working standard; maintainable only at stations with special facilities and staff.

^b Acceptable for network operations.

^c Suitable for low-cost networks where moderate to low performance is acceptable.

except for (b), either the zero irradiance signals for all instruments are known or pairs of identical model pyranometers in identical configurations are used. Ignoring these offsets and differences can bias the results significantly.

Method (c) is considered to give very good results without the need for a calibrated pyranometer.

It is difficult to determine a specific number of measurements on which to base the calculation of the pyranometer calibration factor. However, the standard error of the mean can be calculated and should be less than the desired limit when sufficient readings have been taken under the desired conditions. The principal variations (apart from

fluctuations due to atmospheric conditions and observing limitations) in the derived calibration factor are due to the following:

- (a) Departures from the cosine law response, particularly at solar elevations of less than 10° (for this reason it is better to restrict calibration work to occasions when the solar elevation exceeds 30°);
- (b) The ambient temperature;
- (c) Imperfect levelling of the receiver surface;
- (d) Non-linearity of instrument response;
- (e) The net long-wave irradiance between the detector and the sky.

The pyranometer should be calibrated only in the position of use.

When using the sun as the source, the apparent solar elevation should be measured or computed (to the nearest 0.01°) for this period from solar time (see Annex 7.D). The mean instrument or ambient temperature should also be noted.

7.3.1.1 By reference to a standard pyrheliometer and a shaded reference pyranometer

In this method, described in ISO (1993), the pyranometer's response to global irradiance is calibrated against the sum of separate measurements of the direct and diffuse components. Periods with clear skies and steady radiation (as judged from the record) should be selected. The vertical component of the direct solar irradiance is determined from the pyrheliometer output, and the diffuse sky irradiance is measured with a second pyranometer that is continuously shaded from the sun. The direct component is eliminated from the diffuse sky pyranometer by shading the whole outer dome of the instrument with a disc of sufficient size mounted on a slender rod and held some distance away. The diameter of the disc and its distance from the receiver surface should be chosen in such a way that the screened angle approximately equals the aperture angles of the pyrheliometer. Rather than using the radius of the pyranometer sensor, the radius of the outer dome should be used to calculate the slope angle of the shading disc and pyranometer combination. This shading arrangement occludes a close approximation of both the direct solar beam and the circumsolar sky irradiance as sensed by the pyrheliometer.

On a clear day, the diffuse sky irradiance is less than 15 per cent of the global irradiance; hence, the calibration factor of the reference pyranometer does not need to be known very accurately. However, care must be taken to ensure that the zero irradiance signals from both pyranometers are accounted for, given that for some pyranometers under clear sky conditions the zero irradiance signal can be as high as 15 per cent of the diffuse sky irradiance.

The calibration factor is then calculated according to:

$$E \cdot \sin h + V_s k_s = V \cdot k \quad (7.7)$$

or:

$$k = (E \sin h + V_s k_s) / V \quad (7.8)$$

where E is the direct solar irradiance measured with the pyrheliometer (W m^{-2}), V is the global irradiance output of the pyranometer to be calibrated (μV); V_s is the diffuse sky irradiance output of the shaded reference pyranometer (μV), h is the apparent solar elevation at the time of reading; k is the calibration factor of the pyranometer to be calibrated ($\text{W m}^{-2} \mu\text{V}^{-1}$); and k_s is the calibration factor of the shaded reference pyranometer ($\text{W m}^{-2} \mu\text{V}^{-1}$), and all the signal measurements are taken simultaneously.

The direct, diffuse and global components will change during the comparison, and care must be taken with the appropriate sampling and averaging to ensure that representative values are used.

7.3.1.2 By reference to a standard pyrheliometer

This method, described in ISO (1993a), is similar to the method of the preceding paragraph, except that the diffuse sky irradiance signal is measured by the same pyranometer. The direct component is eliminated temporarily from the pyranometer by shading the whole outer dome of the instrument as described in section 7.3.1.1. The period required for occulting depends on the steadiness of the radiation flux and the response time of the pyranometer, including the time interval needed to bring the temperature and long-wave emission of the glass dome to equilibrium; 10 times the thermopile $1/e$ time-constant of the pyranometer should generally be sufficient.

The difference between the representative shaded and unshaded outputs from the pyranometer is due to the vertical component of direct solar irradiance E measured by the pyrheliometer. Thus:

$$E \cdot \sin h = (V_{\text{un}} - V_s) \cdot k \quad (7.9)$$

or:

$$k = (S \cdot \sin h) / (V_{\text{un}} - V_s) \quad (7.10)$$

where E is the representative direct solar irradiance at normal incidence measured by the pyrheliometer (W m^{-2}); V_{un} is the representative output signal of the pyranometer (μV) when in unshaded (or global) irradiance mode; V_s is the representative output signal of the pyranometer (μV) when in shaded (or diffuse sky) irradiance mode; h is the apparent solar elevation, and k is the calibration factor ($\text{W m}^{-2} \mu\text{V}^{-1}$), which is the inverse of the sensitivity ($\mu\text{V W}^{-1} \text{m}^2$).

Both the direct and diffuse components will change during the comparison, and care must be taken with the appropriate sampling and averaging to ensure that representative values of the shaded and unshaded outputs are used for the calculation. To reduce uncertainties associated with representative signals, a continuous series of shade and un-shade cycles should be performed and time-interpolated values used to reduce temporal changes in global and diffuse sky irradiance. Since the same pyranometer is being used in differential mode, and the difference in zero irradiance signals for global and diffuse sky irradiance is negligible, there is no need to account for zero irradiances in equation 7.10.

7.3.1.3 Alternate calibration using a pyr heliometer

This method uses the same instrumental set-up as the method described in section 7.3.1.1, but only requires the pyr heliometer to provide calibrated irradiance data (E), and the two pyranometers are assumed to be un-calibrated (Forgan, 1996). The method calibrates both pyranometers by solving a pair of simultaneous equations analogous to equation 7.7. Irradiance signal data are initially collected with the pyr heliometer and one pyranometer (pyranometer A) measures global irradiance signals (V_{gA}) and the other pyranometer (pyranometer B) measures diffuse irradiance signals (V_{dB}) over a range of solar zenith angles in clear sky conditions. After sufficient data have been collected in the initial configuration, the pyranometers are exchanged so that pyranometer A, which initially measured the global irradiance signal, now measures the diffuse irradiance signal (V_{dA}), and vice versa with regard to pyranometer B. The assumption is made that for each pyranometer the diffuse (k_d) and global (k_g) calibration coefficients are equal, and the calibration coefficient for pyranometer A is given by:

$$k_A = k_{gA} = k_{dA} \quad (7.11)$$

with an identical assumption for pyranometer B coefficients. Then for a time t_0 in the initial period a modified version of equation 7.7 is:

$$E(t_0)\sin(h(t_0)) = k_A V_{gA}(t_0) - k_B V_{dB}(t_0) \quad (7.12)$$

For time t_1 in the alternate period when the pyranometers are exchanged:

$$E(t_1)\sin(h(t_1)) = k_B V_{gB}(t_1) - k_A V_{dA}(t_1) \quad (7.13)$$

As the only unknowns in equations 7.12 and 7.13 are k_A and k_B , these can be solved for any pair of times (t_0, t_1). Pairs covering a range of solar elevations

provide an indication of the directional response. The resultant calibration information for both pyranometers is representative of the global calibration coefficients and produces almost identical information to method 7.3.1.1, but without the need for a calibrated pyranometer.

As with method 7.3.1.1, to produce coefficients with minimum uncertainty this alternate method requires that the irradiance signals from the pyranometers be adjusted to remove any estimated zero irradiance offset. To reduce uncertainties due to changing directional response it is recommended to use a pair of pyranometers of the same model and observation pairs when $\sin h(t_0) \sim \sin h(t_1)$.

The method is ideally suited to automatic field monitoring situations where three solar irradiance components (direct, diffuse and global) are monitored continuously. Experience suggests that the data collection necessary for the application of this method may be conducted during as little as one day with the exchange of instruments taking place around solar noon. However, at a field site, the extended periods and days either side of the instrument change may be used for data selection, provided that the pyr heliometer has a valid calibration.

7.3.1.4 By comparison with a reference pyranometer

As described in ISO (1992b), this method entails the simultaneous operation of two pyranometers mounted horizontally, side by side, outdoors for a sufficiently long period to acquire representative results. If the instruments are of the same model and monitoring configuration, only one or two days should be sufficient. The more pronounced the difference between the types of pyranometer configurations, the longer the period of comparison required. A long period, however, could be replaced by several shorter periods covering typical conditions (clear, cloudy, overcast, rainfall, snowfall, and so on). The derivation of the instrument factor is straightforward, but, in the case of different pyranometer models, the resultant uncertainty is more likely to be a reflection of the difference in model, rather than the stability of the instrument being calibrated. Data selection should be carried out when irradiances are relatively high and varying slowly. Each mean value of the ratio R of the response of the test instrument to that of the reference instrument may be used to calculate $k = R \cdot k_r$, where k_r is the calibration factor of the reference, and k is the calibration factor being derived. During a sampling period,

provided that the time between measurements is less than the $1/e$ time-constant of the pyranometers, data collection can occur during times of fluctuating irradiance.

The mean temperature of the instruments or the ambient temperature should be recorded during all outdoor calibration work to allow for any temperature effects, for.

7.3.1.5 By comparison in the laboratory

There are two methods which involve laboratory-maintained artificial light sources providing either direct or diffuse irradiance. In both cases, the test pyranometer and a reference standard pyranometer are exposed under the same conditions.

In one method, the pyranometers are exposed to a stabilized tungsten-filament lamp installed at the end of an optical bench. A practical source for this type of work is a 0.5 to 1.0 kW halogen lamp mounted in a water-cooled housing with forced ventilation and with its emission limited to the solar spectrum by a quartz window. This kind of lamp can be used if the standard and the instrument to be calibrated have the same spectral response. For general calibrations, a high-pressure xenon lamp with filters to give an approximate solar spectrum should be used. When calibrating pyranometers in this way, reflection effects should be excluded from the instruments by using black screens. The usual procedure is to install the reference instrument and measure the radiant flux. The reference is then removed and the measurement repeated using the test instrument. The reference is then replaced and another determination is made. Repeated alternation with the reference should produce a set of measurement data of good precision (about 0.5 per cent).

In the other method, the calibration procedure uses an integrating light system, such as a sphere or hemisphere illuminated by tungsten lamps, with the inner surface coated with highly reflective diffuse-white paint. This offers the advantage of simultaneous exposure of the reference pyranometer and the instrument to be calibrated. Since the sphere or hemisphere simulates a sky with an approximately uniform radiance, the angle errors of the instrument at 45° dominate. As the cosine error at these angles is normally low, the repeatability of integrating-sphere measurements is generally within 0.5 per cent. As for the source used to illuminate the sphere, the same considerations apply as for the first method.

7.3.1.6 Routine checks on calibration factors

There are several methods for checking the constancy of pyranometer calibration, depending upon the equipment available at a particular station. Every opportunity to check the performance of pyranometers in the field must be seized.

At field stations where carefully preserved standards (either pyrhemometers or pyranometers) are available, the basic calibration procedures described above may be employed. Where standards are not available, other techniques can be used. If there is a simultaneous record of direct solar radiation, the two records can be examined for consistency by the method used for direct standardization, as explained in section 7.3.1.2. This simple check should be applied frequently.

If there are simultaneous records of global and diffuse sky radiation, the two records should be frequently examined for consistency. In periods of total cloud the global and diffuse sky radiation should be identical, and these periods can be used when a shading disc is used for monitoring diffuse sky radiation. When using shading bands it is recommended that the band be removed so that the diffuse sky pyranometer is measuring global radiation and its data can be compared to simultaneous data from the global pyranometer.

The record may be verified with the aid of a traveling working standard sent from the central station of the network or from a nearby station. Lastly, if calibrations are not performed at the site, the pyranometer can be exchanged for a similar one sent from the calibration facility. Either of the last two methods should be used at least once a year. Pyranometers used for measuring reflected solar radiation should be moved into an upright position and checked using the methods described above.

7.3.2 Performance of pyranometers

Considerable care and attention to details are required to attain the desirable standard of uncertainty. A number of properties of pyranometers and measurement systems should be evaluated so that the uncertainty of the resultant data can be estimated. For example, it has been demonstrated that, for a continuous record of global radiation without ancillary measurements of diffuse sky and direct radiation, an uncertainty better than 5 per cent in daily totals represents the result of good and careful work. Similarly, when a protocol similar to that proposed by WMO (1998) is used, uncertainties for daily total can be of the order of 2 per cent.

7.3.2.1 Sensor levelling

For accurate global radiation measurements with a pyranometer it is essential that the spirit level indicate when the plane of the thermopile is horizontal. This can be tested in the laboratory on an optical levelling table using a collimated lamp beam at about a 20° elevation. The levelling screws of the instrument are adjusted until the response is as constant as possible during rotation of the sensor in the azimuth. The spirit-level is then readjusted, if necessary, to indicate the horizontal plane. This is called radiometric levelling and should be the same as physical levelling of the thermopile. However, this may not be true if the quality of the thermopile surface is not uniform.

7.3.2.2 Change of sensitivity due to ambient temperature variation

Thermopile instruments exhibit changes in sensitivity with variations in instrument temperature. Some instruments are equipped with integrated temperature compensation circuits in an effort to maintain a constant response over a large range of temperatures. The temperature coefficient of sensitivity may be measured in a temperature-controlled chamber. The temperature in the chamber is varied over a suitable range in 10° steps and held steady at each step until the response of the pyranometers has stabilized. The data are then fitted with a smooth curve. If the maximum percentage difference due to temperature response over the operational ambient range is 2 per cent or more, a correction should be applied on the basis of the fit of the data.

If no temperature chamber is available, the standardization method with pyrhemometers (see section 7.3.1.1, 7.3.1.2 or 7.3.1.3) can be used at different ambient temperatures. Attention should be paid to the fact that not only the temperature, but also, for example, the cosine response (namely, the effect of solar elevation) and non-linearity (namely, variations of solar irradiance) can change the sensitivity.

7.3.2.3 Variation of response with orientation

The calibration factor of a pyranometer may very well be different when the instrument is used in an orientation other than that in which it was calibrated. Inclination testing of pyranometers can be conducted in the laboratory or with the standardization method described in section 7.3.1.1 or 7.3.1.2. It is recommended that the pyranometer be

calibrated in the orientation in which it will be used. A correction for tilting is not recommended unless the instrument's response has been characterized for a variety of conditions.

7.3.2.4 Variation of response with angle of incidence

The dependence of the directional response of the sensor upon solar elevation and azimuth is usually known as the Lambert cosine response and the azimuth response, respectively. Ideally, the solar irradiance response of the receiver should be proportional to the cosine of the zenith angle of the solar beam, and constant for all azimuth angles. For pyranometers, it is recommended that the cosine error (or percentage difference from ideal cosine response) be specified for at least two solar elevation angles, preferably 30° and 10°. A better way of prescribing the directional response is given in Table 7.5, which specifies the permissible error for all angles.

Only lamp sources should be used to determine the variation of response with the angle of incidence, because the spectral distribution of the sun changes with the angle of elevation. Using the sun as a source, an apparent variation of response with solar elevation angle could be observed which, in fact, is a variation due to non-homogeneous spectral response.

7.3.2.5 Uncertainties in hourly and daily totals

As most pyranometers in a network are used to determine hourly or daily exposures (or exposures expressed as mean irradiances), it is evident that the uncertainties in these values are important.

Table 7.5 lists the expected maximum deviation from the true value, excluding calibration errors. The types of pyranometers in the third column of Table 7.5 (namely, those of moderate quality) are not suitable for hourly or daily totals, although they may be suitable for monthly and yearly totals.

7.3.3 Installation and maintenance of pyranometers

The site selected to expose a pyranometer should be free from any obstruction above the plane of the sensing element and, at the same time, should be readily accessible. If it is impracticable to obtain such an exposure, the site must be as free as possible of obstructions that may shadow it at any time

in the year. The pyranometer should not be close to light-coloured walls or other objects likely to reflect solar energy onto it; nor should it be exposed to artificial radiation sources.

In most places, a flat roof provides a good location for mounting the radiometer stand. If such a site cannot be obtained, a stand placed some distance from buildings or other obstructions should be used. If practicable, the site should be chosen so that no obstruction, in particular within the azimuth range of sunrise and sunset over the year, should have an elevation exceeding 5° . Other obstructions should not reduce the total solar angle by more than 0.5 sr. At stations where this is not possible, complete details of the horizon and the solid angle subtended should be included in the description of the station.

A site survey should be carried out before the initial installation of a pyranometer whenever its location is changed or if a significant change occurs with regard to any surrounding obstructions. An excellent method of doing this is to use a survey camera that provides azimuthal and elevation grid lines on the negative. A series of exposures should be made to identify the angular elevation above the plane of the receiving surface of the pyranometer and the angular range in azimuth of all obstructions throughout the full 360° around the pyranometer. If a survey camera is not available, the angular outline of obscuring objects may be mapped out by means of a theodolite or a compass and clinometer combination.

The description of the station should include the altitude of the pyranometer above sea level (that is, the altitude of the station plus the height of pyranometer above the ground), together with its geographical longitude and latitude. It is also most useful to have a site plan, drawn to scale, showing the position of the recorder, the pyranometer, and all connecting cables.

The accessibility of instrumentation for frequent inspection is probably the most important single consideration when choosing a site. It is most desirable that pyranometers and recorders be inspected at least daily, and preferably more often.

The foregoing remarks apply equally to the exposure of pyranometers on ships, towers and buoys. The exposure of pyranometers on these platforms is a very difficult and sometimes hazardous undertaking. Seldom can an instrument be mounted where it is not affected by at least one significant obstruction (for example, a tower). Because of platform

motion, pyranometers are subject to wave motion and vibration. Precautions should be taken, therefore, to ensure that the plane of the sensor is kept horizontal and that severe vibration is minimized. This usually requires the pyranometer to be mounted on suitably designed gimbals.

7.3.3.1 Correction for obstructions to a free horizon

If the direct solar beam is obstructed (which is readily detected on cloudless days), the record should be corrected wherever possible to reduce uncertainty.

Only when there are separate records of global and diffuse sky radiation can the diffuse sky component of the record be corrected for obstructions. The procedure requires first that the diffuse sky record be corrected, and the global record subsequently adjusted. The fraction of the sky itself which is obscured should not be computed, but rather the fraction of the irradiance coming from that part of the sky which is obscured. Radiation incident at angles of less than 5° makes only a very small contribution to the total. Since the diffuse sky radiation limited to an elevation of 5° contributes less than 1 per cent to the diffuse sky radiation, it can normally be neglected. Attention should be concentrated on objects subtending angles of 10° or more, as well as those which might intercept the solar beam at any time. In addition, it must be borne in mind that light-coloured objects can reflect solar radiation onto the receiver.

Strictly speaking, when determining corrections for the loss of diffuse sky radiation due to obstacles, the variance in sky radiance over the hemisphere should be taken into account. However, the only practical procedure is to assume that the radiance is isotropic, that is, the same from all parts of the sky. In order to determine the relative reduction in diffuse sky irradiance for obscuring objects of finite size, the following expression may be used:

$$\Delta E_{\text{sky}} = \pi^{-1} \int_{\phi} \int_{\theta} \sin \theta \cos \theta d\theta d\phi \quad (7.14)$$

where θ is the angle of elevation; ϕ is the azimuth angle, Θ is the extent in elevation of the object; and Φ is the extent in azimuth of the object.

The expression is valid only for obstructions with a black surface facing the pyranometer. For other objects, the correction has to be multiplied by a reduction factor depending on the reflectivity of the object. Snow glare from a low sun may even lead to an opposite sign for the correction.

7.3.3.2 Installation of pyranometers for measuring global radiation

A pyranometer should be securely attached to whatever mounting stand is available, using the holes provided in the tripod legs or in the baseplate. Precautions should always be taken to avoid subjecting the instrument to mechanical shocks or vibration during installation. This operation is best effected as follows. First, the pyranometer should be oriented so that the emerging leads or the connector are located poleward of the receiving surface. This minimizes heating of the electrical connections by the sun. Instruments with Moll-Gorcynski thermopiles should be oriented so that the line of thermo-junctions (the long side of the rectangular thermopile) points east-west. This constraint sometimes conflicts with the first, depending on the type of instrument, and should have priority since the connector could be shaded, if necessary. When towers are nearby, the instrument should be situated on the side of the tower towards the Equator, and as far away from the tower as practical.

Radiation reflected from the ground or the base should not be allowed to irradiate the instrument body from underneath. A cylindrical shading device can be used, but care should be taken to ensure that natural ventilation still occurs and is sufficient to maintain the instrument body at ambient temperature.

The pyranometer should then be secured lightly with screws or bolts and levelled with the aid of the levelling screws and spirit-level provided. After this, the retaining screws should be tightened, taking care that the setting is not disturbed so that, when properly exposed, the receiving surface is horizontal, as indicated by the spirit-level.

The stand or platform should be sufficiently rigid so that the instrument is protected from severe shocks and the horizontal position of the receiver surface is not changed, especially during periods of high winds and strong solar energy.

The cable connecting the pyranometer to its recorder should have twin conductors and be waterproof. The cable should be firmly secured to the mounting stand to minimize rupture or intermittent disconnection in windy weather. Wherever possible, the cable should be properly buried and protected underground if the recorder is located at a distance. The use of shielded cable is recommended; the pyranometer, cable and recorder being connected by a very low resistance conductor to a

common ground. As with other types of thermoelectric devices, care must be exercised to obtain a permanent copper-to-copper junction between all connections prior to soldering. All exposed junctions must be weatherproof and protected from physical damage. After identification of the circuit polarity, the other extremity of the cable may be connected to the data-collection system in accordance with the relevant instructions.

7.3.3.3 Installation of pyranometers for measuring diffuse sky radiation

For measuring or recording separate diffuse sky radiation, the direct solar radiation must be screened from the sensor by a shading device. Where continuous records are required, the pyranometer is usually shaded either by a small metal disc held in the sun's beam by a sun tracker, or by a shadow band mounted on a polar axis.

The first method entails the rotation of a slender arm synchronized with the sun's apparent motion. If tracking is based on sun synchronous motors or solar almanacs, frequent inspection is essential to ensure proper operation and adjustment, since spurious records are otherwise difficult to detect. Sun trackers with sun-seeking systems minimize the likelihood of such problems. The second method involves frequent personal attention at the site and significant corrections to the record on account of the appreciable screening of diffuse sky radiation by the shading arrangement. Assumptions about the sky radiance distribution and band dimensions are required to correct for the band and increase the uncertainty of the derived diffuse sky radiation compared to that using a sun-seeking disc system. Annex 7.E provides details on the construction of a shading ring and the necessary corrections to be applied.

A significant error source for diffuse sky radiation data is the zero irradiance signal. In clear sky conditions the zero irradiance signal is the equivalent of 5 to 10 W m⁻² depending on the pyranometer model, and could approach 15 per cent of the diffuse sky irradiance. The *Baseline Surface Radiation Network (BSRN) Operations Manual* (WMO, 1998) provides methods to minimize the influence of the zero irradiance signal.

The installation of a diffuse sky pyranometer is similar to that of a pyranometer which measures global radiation. However, there is the complication of an equatorial mount or shadow-band stand. The distance to a neighbouring pyranometer should be sufficient to guarantee that the shading ring or disc

never shadows it. This may be more important at high latitudes where the sun angle can be very low.

Since the diffuse sky radiation from a cloudless sky may be less than one tenth of the global radiation, careful attention should be given to the sensitivity of the recording system.

7.3.3.4 Installation of pyranometers for measuring reflected radiation

The height above the surface should be 1 to 2 m. In summer-time, the ground should be covered by grass that is kept short. For regions with snow in winter, a mechanism should be available to adjust the height of the pyranometer in order to maintain a constant separation between the snow and the instrument. Although the mounting device is within the field of view of the instrument, it should be designed to cause less than 2 per cent error in the measurement. Access to the pyranometer for leveling should be possible without disturbing the surface beneath, especially if it is snow.

7.3.3.5 Maintenance of pyranometers

Pyranometers in continuous operation should be inspected at least once a day and perhaps more frequently, for example when meteorological observations are being made. During these inspections, the glass dome of the instrument should be wiped clean and dry (care should be taken not to disturb routine measurements during the daytime). If frozen snow, glazed frost, hoar frost or rime is present, an attempt should be made to remove the deposit very gently (at least temporarily), with the sparing use of a de-icing fluid, before wiping the glass clean. A daily check should also ensure that the instrument is level, that there is no condensation inside the dome, and that the sensing surfaces are still black.

In some networks, the exposed dome of the pyranometer is ventilated continuously by a blower to avoid or minimize deposits in cold weather, and to cool the dome in calm weather situations. The temperature difference between the ventilating air and the ambient air should not be more than about 1 K. If local pollution or sand forms a deposit on the dome, it should be wiped very gently, preferably after blowing off most of the loose material or after wetting it a little, in order to prevent the surface from being scratched. Such abrasive action can appreciably alter the original transmission properties of the material. Desiccators should be kept charged with active material (usually a colour-indicating silica gel).

7.3.3.6 Installation and maintenance of pyranometers on special platforms

Very special care should be taken when installing equipment on such diverse platforms as ships, buoys, towers and aircraft. Radiation sensors mounted on ships should be provided with gimbals because of the substantial motion of the platform.

If a tower is employed exclusively for radiation equipment, it may be capped by a rigid platform on which the sensors can be mounted. Obstructions to the horizon should be kept to the side of the platform farthest from the Equator, and booms for holding albedometers should extend towards the Equator.

Radiation sensors should be mounted as high as is practicable above the water surface on ships, buoys and towers, in order to keep the effects of water spray to a minimum.

Radiation measurements have been taken successfully from aircraft for a number of years. Care must be exercised, however, in selecting the correct pyranometer and proper exposure.

Particular attention must be paid during installation, especially for systems that are difficult to access, to ensure the reliability of the observations. It may be desirable, therefore, to provide a certain amount of redundancy by installing duplicate measuring systems at certain critical sites.

7.4 MEASUREMENT OF TOTAL AND LONG-WAVE RADIATION

The measurement of total radiation includes both short wavelengths of solar origin (300 to 3 000 nm) and longer wavelengths of terrestrial and atmospheric origin (3 000 to 100 000 nm). The instruments used for this purpose are pyrrometers. They may be used for measuring either upward or downward radiation flux components, and a pair of them may be used to measure the differences between the two, which is the net radiation. Single-sensor pyrrometers, with an active surface on both sides, are also used for measuring net radiation. Pyrrometer sensors must have a constant sensitivity across the whole wavelength range from 300 to 100 000 nm.

The measurement of long-wave radiation can be accomplished either indirectly, by subtracting the measured global radiation from the total radiation

measured, or directly, by using pyrgeometers. Most pyrgeometers eliminate the short wavelengths by means of filters which have a constant transparency to long wavelengths while being almost opaque to the shorter wavelengths (300 to 3 000 nm).

Some pyrgeometers can be used only during the night as they have no means for eliminating solar short-wave radiation.

7.4.1 Instruments for the measurement of total radiation

One problem with instruments for measuring total radiation is that there are no absorbers which have a completely constant sensitivity over the extended range of wavelengths concerned.

The use of thermally sensitive sensors requires a good knowledge of the heat budget of the sensor. Otherwise, it is necessary to reduce sensor convective heat losses to near zero by protecting the sensor from the direct influence of the wind. The technical difficulties linked with such heat losses are largely responsible for the fact that net radiative fluxes are determined less precisely than global radiation fluxes. In fact, different laboratories have developed their own pyrrometers on technical bases which they consider to be the most effective for reducing the convective heat transfer in the sensor. During the last few decades, pyrrometers have been built which, although not perfect, embody good measurement principles. Thus, there is a great variety of pyrrometers employing different methods for eliminating, or allowing for, wind effects, as follows:

- (a) No protection, in which case empirical formulae are used to correct for wind effects;
- (b) Determination of wind effects by the use of electrical heating;
- (c) Stabilization of wind effects through artificial ventilation;
- (d) Elimination of wind effects by protecting the sensor from the wind.

Table 7.6 provides an analysis of the sources of error arising in pyrrometric measurements and proposes methods for determining these errors.

It is difficult to determine the precision likely to be obtained in practice. In situ comparisons at different sites between different designs of pyrrometer yield results manifesting differences of up to 5 to 10 per cent under the best conditions. In order to improve such results, an exhaustive laboratory study should precede the in situ comparison in order to determine the different effects separately.

Table 7.7 lists the characteristics of pyrrometers of various levels of performance, and the uncertainties to be expected in the measurements obtained from them.

7.4.2 Calibration of pyrrometers and net pyrrometers

Pyrrometers and net pyrrometers can be calibrated for short-wave radiation using the same methods as those used for pyranometers (see section 7.3.1) using the sun and sky as the source. In the case of one-sensor net pyrrometers, the downward-looking side must be covered by a cavity of known and steady temperature.

Long-wave radiation calibration is best done in the laboratory with black body cavities. However, it is possible to perform field calibrations. In the case of a net pyrrometer, the downward flux $L\downarrow$ is measured separately by using a pyrrometer; or the upper receiver may be covered as above with a cavity, and the temperature of the snow or water surface T_s is measured directly. In which case, the radiative flux received by the instrument amounts to:

$$L^* = L\downarrow - \varepsilon\sigma T_s^4 \quad (7.15)$$

and:

$$V = L^* \cdot K \text{ or } K = V/L^* \quad (7.16)$$

where ε is the emittance of the water or snow surface (normally taken as 1); σ is the Stefan-Boltzmann constant ($5.6704 \cdot 10^{-8} \text{ W m}^{-2} \text{ K}^{-1}$); T_s is the underlying surface temperature (K); $L\downarrow$ is the irradiance measured by the pyrrometer or calculated from the temperature of the cavity capping the upper receiver (W m^{-2}); L^* is the radiative flux at the receiver (W m^{-2}); V is the output of the instrument (μV); and K is sensitivity ($\mu\text{V}/(\text{W m}^{-2})$).

The instrument sensitivities should be checked periodically in situ by careful selection of well-described environmental conditions with slowly varying fluxes.

The symmetry of net pyrrometers requires regular checking. This is done by inverting the instrument, or the pair of instruments, in situ and noting any difference in output. Differences of greater than 2 per cent of the likely full scale between the two directions demand instrument recalibration because either the ventilation rates or absorption factors have become significantly different for the two sensors. Such tests should also be carried out during calibration or installation.

Table 7.6. Sources of error in pyrradiometric measurements

<i>Elements influencing the measurements</i>	<i>Nature of influence on pyrradiometers</i>		<i>Effects on the precision of measurements</i>	<i>Methods for determining these characteristics</i>
	<i>with domes</i>	<i>without domes</i>		
Screening properties	Spectral characteristics of transmission	None	(a) Spectral variations in calibration coefficient (b) The effect of reduced incident radiation on the detector due to short-wave diffusion in the domes (depends on thickness) (c) Ageing and other variations in the sensors	(a) Determine spectrally the extinction in the screen (b) Measure the effect of diffuse sky radiation or measure the effect with a varying angle of incidence (c) Spectral analysis: compare with a new dome; determine the extinction of the dome
Convection effects	Changes due to non-radiative energy exchanges: sensor-dome environment (thermal resistance)	Changes due to non-radiative energy exchanges: sensor-air (variation in areal exchange coefficient)	Uncontrolled changes due to wind gusts are critical in computing the radiative flux divergence in the lowest layer of the atmosphere	Study the dynamic behaviour of the instrument as a function of temperature and speed in a wind tunnel
Effects of hydrometeors (rain, snow, fog, dew, frost) and dust	Variation of the spectral transmission plus the non-radiative heat exchange by conduction and change	Variation of the spectral character of the sensor and of the dissipation of heat by evaporation	Changes due to variations in the spectral characteristics of the sensor and to non-radiative energy transfers	Study the influence of forced ventilation on the effects
Properties of the sensor surface (emissivity)	Depends on the spectral absorption of the blackening substance on the sensor		Changes in calibration coefficient (a) As a function of spectral response (b) As a function of intensity and azimuth of incident radiation (c) As a function of temperature effects	(a) Spectrophotometric analysis of the calibration of the absorbing surfaces (b) Measure the sensor's sensitivity variability with the angle of incidence
Temperature effects	Non-linearity of the sensor as a function of temperature		A temperature coefficient is required	Study the influence of forced ventilation on these effects
Asymmetry effects	(a) Differences between the thermal capacities and resistance of the upward- and downward-facing sensors (b) Differences in ventilation of the upward- and downward-facing sensors (c) Control and regulation of sensor levelling		(a) Influence on the time-constant of the instrument (b) Error in the determination of the calibration factors for the two sensors	(a) Control the thermal capacity of the two sensor surfaces (b) Control the time-constant over a narrow temperature range

Table 7.7. Characteristics of operational pyrradiometers

<i>Characteristic</i>	<i>High quality^a</i>	<i>Good quality^b</i>	<i>Moderate quality^c</i>
Resolution ($W m^{-2}$)	1	5	10
Stability (annual change; per cent of full scale)	2%	5%	10%
Cosine response error at 10° elevation	3%	7%	15%
Azimuth error at 10° elevation (additional to	3%	5%	10%
Temperature dependence (-20 to 40°C)	1%	2%	5%
Non-linearity (deviation from mean)	0.5%	2%	5%
Variation in spectral sensitivity integrated over	2%	5%	10%

Notes:

^a Near state of the art; maintainable only at stations with special facilities and specialist staff.^b Acceptable for network operations.^c Suitable for low-cost networks where moderate to low performance is acceptable.

7.4.3 Instruments for the measurement of long-wave radiation

Over the last decade, significant advances have been made in the measurement of terrestrial radiation by pyrgeometers, which block out solar radiation. Early instruments of this type had significant problems with premature ageing of the materials used to block the short-wave portion of the spectrum, while being transparent to the long-wave portion. However, with the advent of the silicon domed pyrgeometer, this stability problem has been greatly reduced. Nevertheless, the measurement of terrestrial radiation is still more difficult and less understood than the measurement of solar irradiance. Pyrgeometers are subject to the same errors as pyrradiometers (see Table 7.6).

Pyrgeometers have developed in two forms. In the first form, the thermopile receiving surface is covered with a hemispheric dome inside which an interference filter is deposited. In the second form, the thermopile is covered with a flat plate on which the interference filter is deposited. In both cases, the surface on which the interference filter is deposited is made of silicon. The first style of instrument provides a full hemispheric field of view, while for the second a 150° field of view is typical and the hemispheric flux is modelled using the manufacturer's procedures. The argument used for the latter method is that the deposition of filters on the inside of a hemisphere has greater imprecisions than the modelling of the flux below 30° elevations. Both types of instruments are operated on the principle that the measured output signal is the difference between the irradiance emitted from the source

and the black-body radiative temperature of the instrument. In general, this can be approximated by the following equation:

$$L_{\downarrow i} = \frac{V}{K} + 5.6704 \cdot 10^{-8} \cdot T_d^4 \quad (7.17)$$

where $L_{\downarrow i}$ is the infrared terrestrial irradiance ($W m^{-2}$); V is the voltage output from the sensing element (μV); K is the instrument sensitivity to infrared irradiance ($\mu V/(W m^{-2})$); and T_d is the detector temperature (K).

Several recent comparisons have been made using instruments of similar manufacture in a variety of measurement configurations. These studies have indicated that, following careful calibration, fluxes measured at night agree to within 2 per cent, but in periods of high solar energy the difference between instruments may reach 13 per cent. The reason for the differences is that the silicon dome and the associated interference filter do not have a sharp and reproducible cut-off between solar and terrestrial radiation, and it is not a perfect reflector of solar energy. Thus, solar heating occurs. By shading the instrument, ventilating it as recommended by ISO (1990a), and measuring the temperature of the dome and the instrument case, this discrepancy can be reduced to less than 5 per cent of the thermopile signal (approximately $15 W m^{-2}$). Based upon these and other comparisons, the following recommendations should be followed for the measurement of long-wave radiation:

- (a) When using pyrgeometers that have a built-in battery circuit to emulate the black-body condition of the instrument, extreme care must be taken to ensure that the battery is

well maintained. Even a small change in the battery voltage will significantly increase the measurement error. If at all possible, the battery should be removed from the instrument, and the case and dome temperatures of the instrument should be measured according to the manufacturer's instructions;

- (b) Where possible, both the case and dome temperatures of the instrument should be measured and used in the determination of irradiance;
- (c) The instrument should be ventilated;
- (d) For best results, the instrument should be shaded from direct solar irradiance by a small sun-tracking disc as used for diffuse sky radiation measurement.

These instruments should be calibrated at national or regional calibration centres by using black-body calibration units. Experiments using near-black-body radiators fashioned from large hollowed blocks of ice have also met with good success. The calibration centre should provide information on the best method of determining the atmospheric irradiance from a pyrgeometer depending upon which of the above recommendations are being followed.

7.4.4 **Installation of pyrradiometers and pyrgeometers**

Pyrradiometers and pyrgeometers are generally installed at a site which is free from obstructions, or at least has no obstruction with an angular size greater than 5° in any direction, and which has a low sun angle at all times during the year.

A daily check of the instruments should ensure that:

- (a) The instrument is level;
- (b) Each sensor and its protection devices are kept clean and free from dew, frost, snow and rain;
- (c) The domes do not retain water (any internal condensation should be dried up);
- (d) The black receiver surfaces have emissivities very close to 1.

Additionally, where polythene domes are used, it is necessary to check from time to time that UV effects have not changed the transmission characteristics. A half-yearly exchange of the upper dome is recommended.

Since it is not generally possible to directly measure the reflected solar radiation and the upward long-wave radiation exactly at the surface

level, it is necessary to place the pyranometers and pyrradiometers at a suitable distance from the ground to measure these upward components. Such measurements integrate the radiation emitted by the surface beneath the sensor. For pyranometers and pyrradiometers which have an angle of view of 2π sr and are installed 2 m above the surface, 90 per cent of all the radiation measured is emitted by a circular surface underneath having a diameter of 12 m (this figure is 95 per cent for a diameter of 17.5 m and 99 per cent for one of 39.8 m), assuming that the sensor uses a cosine detector.

This characteristic of integrating the input over a relatively large circular surface is advantageous when the terrain has large local variations in emittance, provided that the net pyrradiometer can be installed far enough from the surface to achieve a field of view which is representative of the local terrain. The output of a sensor located too close to the surface will show large effects caused by its own shadow, in addition to the observation of an unrepresentative portion of the terrain. On the other hand, the readings from a net pyrradiometer located too far from the surface can be rendered unrepresentative of the fluxes near that surface because of the existence of undetected radiative flux divergences. Usually a height of 2 m above short homogeneous vegetation is adopted, while in the case of tall vegetation, such as a forest, the height should be sufficient to eliminate local surface heterogeneities adequately.

7.4.5 **Recording and data reduction**

In general, the text in section 7.1.3 applies to pyrradiometers and pyrgeometers. Furthermore, the following effects can specifically influence the readings of these radiometers, and they should be recorded:

- (a) The effect of hydrometeors on non-protected and non-ventilated instruments (rain, snow, dew, frost);
- (b) The effect of wind and air temperature;
- (c) The drift of zero of the data system. This is much more important for pyrradiometers, which can yield negative values, than for pyranometers, where the zero irradiance signal is itself a property of the net irradiance at the sensor surface.

Special attention should be paid to the position of instruments if the derived long-wave radiation requires subtraction of the solar irradiance component measured by a pyranometer; the

pyrriadiometer and pyrriometer should be positioned within 5 m of each other and in such a way that they are essentially influenced in the same way by their environment.

7.5 MEASUREMENT OF SPECIAL RADIATION QUANTITIES

7.5.1 Measurement of daylight

Illuminance is the incident flux of radiant energy that emanates from a source with wavelengths between 380 and 780 nm and is weighted by the response of the human eye to energy in this wavelength region. The ICI has defined the response of the human eye to photons with a peak responsivity at 555 nm. Figure 7.2 and Table 7.8 provide the relative response of the human eye normalized to this frequency. Luminous efficacy is defined as the relationship between radiant emittance ($W\ m^{-2}$) and luminous emittance (lm). It is a function of the relative luminous sensitivity $V(\lambda)$ of the human eye and a normalizing factor K_m (683) describing the number of lumens emitted per watt of electromagnetic radiation from a monochromatic source of 555.19 nm (the freezing point of platinum), as follows:

$$\Phi_v = K_m \int_{380}^{780} \Phi(\lambda) V(\lambda) d\lambda \quad (7.18)$$

where Φ_v is the luminous flux ($lm\ m^{-2}$ or lux); $\Phi(\lambda)$ is the spectral radiant flux ($W\ m^{-2}\ nm^{-1}$); $V(\lambda)$ is the sensitivity of the human eye; and K_m is the normalizing constant relating luminous to radiation quantities.

Quantities and units for luminous variables are given in Annex 7.A.

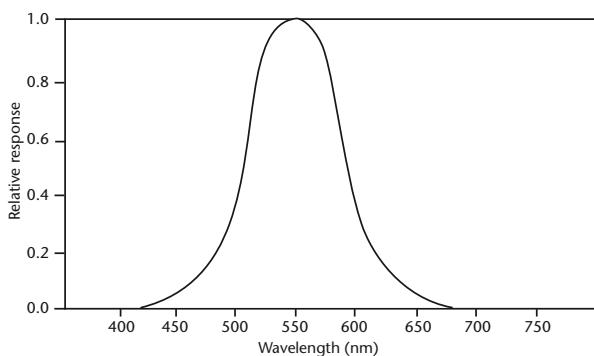

Figure 7.2. Relative luminous sensitivity $V(\lambda)$ of the human eye for photopic vision

Table 7.8. Photopic spectral luminous efficiency values (unity at wavelength of maximum efficacy)

Wavelength (nm)	Photopic $V(\lambda)$	Wavelength (nm)	Photopic $V(\lambda)$
380	0.000 04	590	0.757
390	0.000 12	600	0.631
400	0.000 4	610	0.503
410	0.001 2	620	0.381
420	0.004 0	630	0.265
430	0.011 6	640	0.175
440	0.023	650	0.107
450	0.038	660	0.061
460	0.060	670	0.032
470	0.091	680	0.017
480	0.139	690	0.008 2
490	0.208	700	0.004 1
500	0.323	710	0.002 1
510	0.503	720	0.001 05
520	0.710	730	0.000 52
530	0.862	740	0.000 25
540	0.954	750	0.000 12
550	0.995	760	0.000 06
560	0.995	770	0.000 03
570	0.952	780	0.000 015
580	0.870		

7.5.1.1 Instruments

Illuminance meters comprise a photovoltaic detector, one or more filters to yield sensitivity according to the $V(\lambda)$ curve, and often a temperature control circuit to maintain signal stability. The ICI has developed a detailed guide to the measurement of daylight (ICI, 1994) which describes expected practices in the installation of equipment, instrument characterization, data-acquisition procedures and initial quality control.

The measurement of global illuminance parallels the measurement of global irradiance. However, the standard illuminance meter must be temperature controlled or corrected from at least -10 to $40^\circ C$. Furthermore, it must be ventilated to prevent condensation and/or frost from coating the outer surface of the sensing element. Illuminance meters should normally be able to measure fluxes over the range 1 to 20 000 lx. Within this range, uncertainties should remain within the limits of Table 7.9. These values are

Table 7.9. Specification of illuminance meters

Specification	Uncertainty percentage
V(λ) match	2.5
UV response	0.2
IR response	0.2
Cosine response	1.5
Fatigue at 10 klx	0.1
Temperature coefficient	0.1 K ⁻¹
Linearity	0.2
Settling time	0.1 s

based upon ICI recommendations (ICI, 1987), but only for uncertainties associated with high-quality illuminance meters specifically intended for external daylight measurements.

Diffuse sky illuminance can be measured following the same principles used for the measurement of diffuse sky irradiance. Direct illuminance measurements should be taken with instruments having a field of view whose open half-angle is no greater than 2.85° and whose slope angle is less than 1.76°.

7.5.1.2 Calibration

Calibrations should be traceable to a Standard Illuminant A following the procedures outlined in ICI (1987). Such equipment is normally available only at national standards laboratories. The calibration and tests of specification should be performed yearly. These should also include tests to determine ageing, zero setting drift, mechanical stability and climatic stability. It is also recommended that a field standard be used to check calibrations at each measurement site between laboratory calibrations.

7.5.1.3 Recording and data reduction

The ICI has recommended that the following climatological variables be recorded:

- Global and diffuse sky daylight illuminance on horizontal and vertical surfaces;
- Illuminance of the direct solar beam;
- Sky luminance for 0.08 sr intervals (about 10° · 10°) all over the hemisphere;
- Photopic albedo of characteristic surfaces such as grass, earth and snow.

Hourly or daily integrated values are usually needed. The hourly values should be referenced to true solar

time. For the presentation of sky luminance data, stereographic maps depicting isolines of equal luminance are most useful.

7.6 MEASUREMENT OF UV RADIATION

Measurements of solar UV radiation are in demand because of its effects on the environment and human health, and because of the enhancement of radiation at the Earth's surface as a result of ozone depletion (Kerr and McElroy, 1993). The UV spectrum is conventionally divided into three parts, as follows:

- UV-A is the band with wavelengths of 315 to 400 nm, namely, just outside the visible spectrum. It is less biologically active and its intensity at the Earth's surface does not vary with atmospheric ozone content;
- UV-B is defined as radiation in the 280 to 315 nm band. It is biologically active and its intensity at the Earth's surface depends on the atmospheric ozone column, to an extent depending on wavelength. A frequently used expression of its biological activity is its erythemal effect, which is the extent to which it causes the reddening of white human skin;
- UV-C, in wavelengths of 100 to 280 nm, is completely absorbed in the atmosphere and does not occur naturally at the Earth's surface.

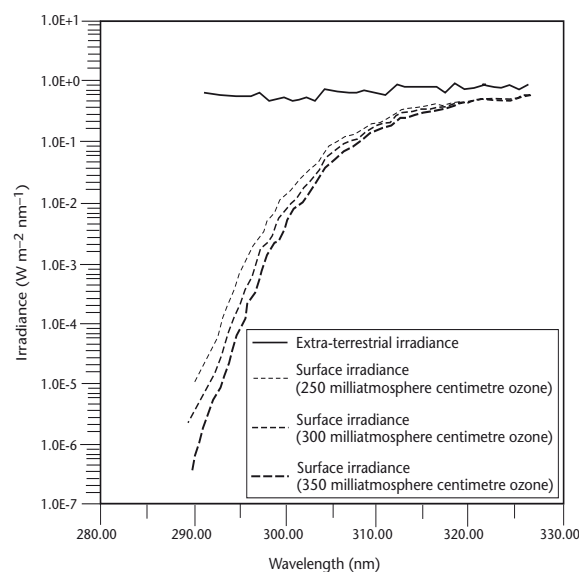

Figure 7.3. Model results illustrating the effect of increasing ozone levels on the transmission of UV-B radiation through the atmosphere

Table 7.10. Requirements for UV-B global spectral irradiance measurements

UV-B	
1.	Wavelength resolution – 1.0 nm or better
2.	Temporal resolution – 10 min or better
3.	Directional (angular) – separation into direct and diffuse components or better; radiances
4.	Meticulous calibration strategy
Ancillary data	
(a) <i>Required</i>	
1.	Total column ozone (within 100 km)
2.	Aerosol optical depth
3.	Ground albedo
4.	Cloud cover
(b) <i>Highly recommended</i>	
1.	Aerosol; profile using LIDAR
2.	Vertical ozone distribution
3.	Sky brightness
4.	Global solar irradiance
5.	Polarization of zenith radiance
6.	Column water amount

UV-B is the band on which most interest is centred for measurements of UV radiation. An alternative, but now non-standard, definition of the boundary between UV-A and UV-B is 320 nm rather than 315 nm.

Measuring UV radiation is difficult because of the small amount of energy reaching the Earth's surface, the variability due to changes in stratospheric ozone levels, and the rapid increase in the magnitude of the flux with increasing wavelength. Figure 7.3 illustrates changes in the spectral irradiance between 290 and 325 nm at the top of the atmosphere and at the surface in $W m^{-2} nm^{-1}$. Global UV irradiance is strongly affected by atmospheric phenomena such as clouds, and to a lesser extent by atmospheric aerosols.

The influence of surrounding surfaces is also significant because of multiple scattering. This is especially the case in snow-covered areas.

Difficulties in the standardization of UV radiation measurement stem from the variety of uses to which the measurements are put. Unlike most meteorological measurements, standards based upon global needs have not yet been reached. In many countries, measurements of UV radiation are not taken by Meteorological Services, but by health or environmental protection authorities.

This leads to further difficulties in the standardization of instruments and methods of observation.

Guidelines and standard procedures have been developed on how to characterize and calibrate UV spectroradiometers and UV filter radiometers used to measure solar UV irradiance (see WMO, 1996; 1999a; 1999b; 2001). Application of the recommended procedures for data quality assurance performed at sites operating instruments for solar UV radiation measurements will ensure a valuable UV radiation database. This is needed to derive a climatology of solar UV irradiance in space and time for studies of the Earth's climate. Requirements for measuring sites and instrument specifications are also provided in these documents. Requirements for UV-B measurements were put forward in the WMO Global Ozone Research and Monitoring Project (WMO, 1993b) and are reproduced in Table 7.10.

The following instrument descriptions are provided for general information and for assistance in selecting appropriate instrumentation.

7.6.1 Instruments

Three general types of instruments are available commercially for the measurement of UV radiation. The first class of instruments use broadband filters. These instruments integrate over either the UV-B or UV-A spectrum or the entire broadband UV region responsible for affecting human health. The second class of instruments use one or more interference filters to integrate over discrete portions of the UV-A and/or UV-B spectrum. The third class of instruments are

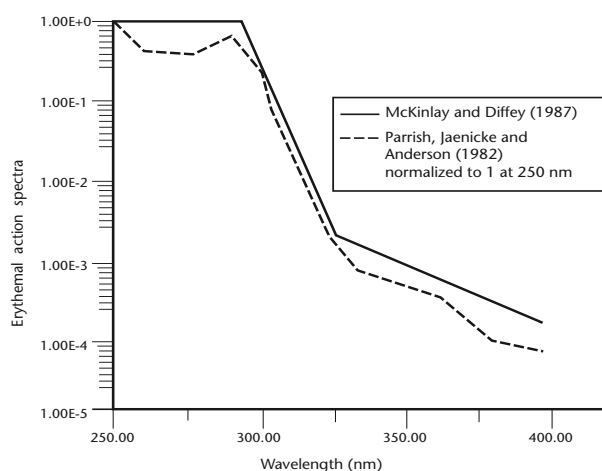

Figure 7.4. Erythemal curves as presented by Parrish, Jaenicke and Anderson (1982) and McKinlay and Diffey (1987)

spectroradiometers that measure across a pre-defined portion of the spectrum sequentially using a fixed passband.

7.6.1.1 Broadband sensors

Most, but not all, broadband sensors are designed to measure a UV spectrum that is weighted by the erythemal function proposed by McKinlay and Diffey (1987) and reproduced in Figure 7.4. Another action spectrum found in some instruments is that of Parrish, Jaenicke and Anderson (1982). Two methods (and their variations) are used to accomplish this hardware weighting.

One of the means of obtaining erythemal weighting is to first filter out nearly all visible wavelength light using UV-transmitting, black-glass blocking filters. The remaining radiation then strikes a UV-sensitive phosphor. In turn, the green light emitted by the phosphor is filtered again by using coloured glass to remove any non-green visible light before impinging on a gallium arsenic or a gallium arsenic phosphorus photodiode. The quality of the instrument is dependent on such items as the quality of the outside protective quartz dome, the cosine response of the instrument, the temperature stability, and the ability of the manufacturer to match the erythemal curve with a combination of glass and diode characteristics. Instrument temperature stability is crucial, both with respect to the electronics and the response of the phosphor to incident UV radiation. Phosphor efficiency decreases by approximately 0.5 per cent K^{-1} and its wavelength response curve is shifted by approximately 1 nm longer every 10 K. This latter effect is particularly important because of the steepness of the radiation curve at these wavelengths.

More recently, instruments have been developed to measure erythemally weighted UV irradiance using thin film metal interference filter technology and specially developed silicon photodiodes. These overcome many problems associated with phosphor technology, but must contend with very low photodiode signal levels and filter stability.

Other broadband instruments use one or the other measurement technology to measure the complete spectra by using either a combination of glass filters or interference filters. The bandpass is as narrow as 20 nm full-width half-maximum (FWHM) to as wide as 80 nm FWHM for instruments measuring a combination of UV-A and UV-B radiation. Some manufacturers of these

instruments provide simple algorithms to approximate erythemal dosage from the unweighted measurements.

The maintenance of these instruments consists of ensuring that the domes are cleaned, the instrument is level, the desiccant (if provided) is active, and the heating/cooling system is working correctly, if so equipped. Otherwise, the care they require is similar to that of a pyranometer.

7.6.1.2 Narrowband sensors

The definition of narrowband for this classification of instrument is vague. The widest bandwidth for instruments in this category is 10 nm FWHM. The narrowest bandwidth at present for commercial instruments is of the order of 2 nm FWHM.

These sensors use one or more interference filters to obtain information about a portion of the UV spectra. The simplest instruments consist of a single filter, usually at a wavelength that can be measured by a good-quality, UV enhanced photodiode. Wavelengths near 305 nm are typical for such instruments. The out-of-band rejection of such filters should be equal to, or greater than, 10^{-6} throughout the sensitive region of the detector. Higher quality instruments of this type either use Peltier cooling to maintain a constant temperature near 20°C or heaters to increase the instrument filter and diode temperatures to above normal ambient temperatures, usually 40°C. However, the latter alternative markedly reduces the life of interference filters. A modification of this type of instrument uses a photomultiplier tube instead of the photodiode. This allows the accurate measurement of energy from shorter wavelengths and lower intensities at all measured wavelengths.

Manufacturers of instruments that use more than a single filter often provide a means of reconstructing the complete UV spectrum through modelled relationships developed around the measured wavelengths. Single wavelength instruments are used similarly to supplement the temporal and spatial resolution of more sophisticated spectrometer networks or for long-term accurate monitoring of specific bands to detect trends in the radiation environment.

The construction of the instruments must be such that the radiation passes through the filter close to normal incidence so that wavelength shifting to shorter wavelengths is avoided. For

example, a 10° departure from normal incidence may cause a wavelength shift of 1.5 nm, depending on the refractive index of the filter. The effect of temperature can also be significant in altering the central wavelength by about 0.012 nm K^{-1} on very narrow filters ($< 1 \text{ nm}$).

Maintenance for simple one-filter instruments is similar to that of the broadband instruments. For instruments that have multiple filters in a moving wheel assembly, maintenance will include determining whether or not the filter wheel is properly aligned. Regular testing of the high-voltage power supply for photomultiplier-equipped instruments and checking the quality of the filters are also recommended.

7.6.1.3 Spectroradiometers

The most sophisticated commercial instruments are those that use either ruled or holographic gratings to disperse the incident energy into a spectrum. The low energy of the UV radiation compared with that in the visible spectrum necessitates a strong out-of-band rejection. This is achieved by using a double monochromator or by blocking filters, which transmit only UV radiation, in conjunction with a single monochromator. A photomultiplier tube is most commonly used to measure the output from the monochromator. Some less expensive instruments use photodiode or charge-coupled detector arrays. These instruments are unable to measure energy in the shortest wavelengths of the UV-B radiation and generally have more problems associated with stray light.

Monitoring instruments are now available with several self-checking features. Electronic tests include checking the operation of the photomultiplier and the analogue to digital conversion. Tests to determine whether the optics of the instrument are functioning properly include testing the instrument by using internal mercury lamps and standard quartz halogen lamps. While these do not give absolute calibration data, they provide the operator with information on the stability of the instrument both with respect to spectral alignment and intensity.

Commercially available instruments are constructed to provide measurement capabilities from approximately 290 nm to the mid-visible wavelengths, depending upon the type of construction and configuration. The bandwidth

of the measurements is usually between 0.5 and 2.0 nm. The time required to complete a full scan across the grating depends upon both the wavelength resolution and the total spectrum to be measured. Scan times to perform a spectral scan across the UV region and part of the visible region (290 to 450 nm) with small wavelength steps range from less than 1 min per scan with modern fast scanning spectroradiometers to about 10 min for some types of conventional high-quality spectroradiometers.

For routine monitoring of UV radiation it is recommended that the instrument either be environmentally protected or developed in such a manner that the energy incident on a receiver is transmitted to a spectrometer housed in a controlled climate. In both cases, care must be taken in the development of optics so that uniform responsivity is maintained down to low solar elevations.

The maintenance of spectroradiometers designed for monitoring UV-B radiation requires well-trained on-site operators who will care for the instruments. It is crucial to follow the manufacturer's maintenance instructions because of the complexity of this instrument.

7.6.2 Calibration

The calibration of all sensors in the UV-B is both very important and difficult. Guidelines on the calibration of UV spectroradiometers and UV filter radiometers have been given in WMO (1996; 1999*a*; 1999*b*; 2001) and in the relevant scientific literature. Unlike pyranometers, which can be traced back to a standard set of instruments maintained at the WRR, these sensors must be either calibrated against light sources or against trap detectors. The latter, while promising in the long-term calibration of narrowband filter instruments, are still not readily available. Therefore, the use of standard lamps that are traceable to national standards laboratories remains the most common means of calibrating sensors measuring in the UV-B. Many countries do not have laboratories capable of characterizing lamps in the UV. In these countries, lamps are usually traceable to the National Institute of Standards and Technology in the United States or to the Physikalisch-Technische Bundesanstalt in Germany.

It is estimated that a 5 per cent uncertainty in spot measurements at 300 nm can be achieved only under the most rigorous conditions at the present

time. The uncertainty of measurements of daily totals is about the same, using best practice. Fast changes in cloud cover and/or cloud optical depths at the measuring site require fast spectral scans and small sampling time steps between subsequent spectral scans, in order to obtain representative daily totals of spectral UV irradiance. Measurements of erythemal irradiance would have uncertainties typically in the range 5 to 20 per cent, depending on a number of factors, including the quality of the procedures and the equipment. The sources of error are discussed in the following paragraphs and include:

- (a) Uncertainties associated with standard lamps;
- (b) The stability of instruments, including the stability of the spectral filter and, in older instruments, temperature coefficients;
- (c) Cosine error effects;
- (d) The fact that the calibration of an instrument varies with wavelength, and that:
 - (i) The spectrum of a standard lamp is not the same as the spectrum being measured;
 - (ii) The spectrum of the UV-B irradiance being measured varies greatly with the solar zenith angle.

The use of standard lamps as calibration sources leads to large uncertainties at the shortest wavelengths, even if the transfer of the calibration is perfect. For example, at 250 nm the uncertainty associated with the standard irradiance is of the order of 2.2 per cent. When transferred to a standard lamp, another 1 per cent uncertainty is added. At 350 nm, these uncertainties decrease to approximately 1.3 and 0.7 per cent, respectively. Consideration must also be given to the set-up and handling of standard lamps. Even variations as small as 1 per cent in the current, for example, can lead to errors in the UV flux of 10 per cent or more at the shortest wavelengths. Inaccurate distance measurements between the lamp and the instrument being calibrated can also lead to errors in the order of 1 per cent as the inverse square law applies to the calibration. Webb, and others (1994) discuss various aspects of uncertainty as related to the use of standard lamps in the calibration of UV or visible spectroradiometers.

While broadband instruments are the least expensive to purchase, they are the most difficult to characterize. The problems associated with these instruments stem from: (a) the complex set of filters used to integrate the incoming radiation into the erythemal signal; and (b) the fact that the spectral nature of the atmosphere changes with air

mass, ozone amount and other atmospheric constituents that are probably unknown to the instrument user. Even if the characterization of the instrument by using calibrated lamp sources is perfect, the changing spectral properties between the atmosphere and the laboratory would affect the uncertainty of the final measurements. The use of high-output deuterium lamps, a double monochromator and careful filter selection will help in the characterization of these instruments, but the number of laboratories capable of calibrating these devices is extremely limited.

Narrowband sensors are easier to characterize than broadband sensors because of the smaller variation in calibrating source intensities over the smaller wavelength pass-band. Trap detectors could potentially be used effectively for narrowband sensors, but have been used only in research projects to date. In recalibrating these instruments, whether they have a single filter or multiple filters, care must be taken to ensure that the spectral characteristics of the filters have not shifted over time.

Spectrometer calibration is straightforward, assuming that the instrument has been maintained between calibrations. Once again, it must be emphasized that the transfer from the standard lamp is difficult because of the care that must be taken in setting up the calibration (see above). The instrument should be calibrated in the same position as that in which the measurements are to be taken, as many spectroradiometers are adversely affected by changes in orientation. The calibration of a spectrometer should also include testing the accuracy of the wavelength positioning of the monochromator, checking for any changes in internal optical alignment and cleanliness, and an overall test of the electronics. Periodic testing of the out-of-band rejection, possibly by scanning a helium cadmium laser ($\lambda = 325$ nm), is also advisable.

Most filter instrument manufacturers indicate a calibration frequency of once a year. Spectroradiometers should be calibrated at least twice a year and more frequently if they do not have the ability to perform self-checks on the photomultiplier output or the wavelength selection. In all cases, absolute calibrations of the instruments should be performed by qualified technicians at the sites on a regular time schedule. The sources used for calibration must guarantee that the calibration can be traced back to absolute

radiation standards kept at certified national metrological institutes. If the results of quality assurance routines applied at the sites indicate a significant change in an instrument's performance or changes of its calibration level over time, an additional calibration may be needed in between two regular calibrations. All calibrations should be based on expertise and documentation available at

the site and on the guidelines and procedures such as those published in WMO (1996; 1999*a*; 1999*b*; 2001). In addition to absolute calibrations of instruments, inter-comparisons between the sources used for calibration, for example, calibration lamps, and the measuring instruments are useful to detect and remove inconsistencies or systematic differences between station instruments at different sites.

ANNEX 7.A

NOMENCLATURE OF RADIOMETRIC AND PHOTOMETRIC QUANTITIES

(1) Radiometric quantities

<i>Name</i>	<i>Symbol</i>	<i>Unit</i>	<i>Relation</i>	<i>Remarks</i>
Radiant energy	$Q, (W)$	$J=W s$	–	–
Radiant flux	$\Phi, (P)$	W	$\Phi = \frac{dQ}{dt}$	Power
Radiant flux density	$(M), (E)$	$W m^{-2}$	$\frac{d\Phi}{dA} = \frac{d^2Q}{dA \cdot dt}$	Radiant flux of any origin crossing an area element
Radiant exitance	M	$W m^{-2}$	$M = \frac{d\Phi}{dA}$	Radiant flux of any origin emerging from an area element
Irradiance	E	$W m^{-2}$	$E = \frac{d\Phi}{dA}$	Radiant flux of any origin incident onto an area element
Radiance	L	$W m^{-2} sr^{-1}$	$L = \frac{d^2\Phi}{d\Omega \cdot dA \cdot \cos\theta}$	The radiance is a conservative quantity in an optical system
Radiant exposure	H	$J m^{-2}$	$H = \frac{dQ}{dA} = \int_{t_1}^{t_2} E dt$	May be used for daily sums of global radiation, etc.
Radiant intensity	I	$W sr^{-1}$	$I = \frac{d\Phi}{d}$	May be used only for radiation outgoing from "point sources"

(2) Photometric quantities

<i>Name</i>	<i>Symbol</i>	<i>Unit</i>
Quantity of light	Q_v	$lm \cdot s$
Luminous flux	Φ_v	lm
Luminous exitance	M_v	$lm m^{-2}$
Illuminance	E_v	$lm m^{-2} = lx$
Light exposure	H_v	$lm m^{-2} s = lx \cdot s$
Luminous intensity	I_v	$lm sr^{-1} = cd$
Luminance	L_v	$lm m^{-2} sr^{-1} = cdm^{-2}$
Luminous flux density	$(M_v; E_v)$	$lm m^{-2}$

(3) Optical characteristics

<i>Characteristic</i>	<i>Symbol</i>	<i>Definition</i>	<i>Remarks</i>
Emissivity	ε	$\varepsilon = \frac{M_\varepsilon}{M_{\varepsilon=1}}$	$\varepsilon = 1$ for a black body
Absorptance	α	$\alpha = \frac{\Phi_a}{\Phi_i}$	Φ_a and Φ_i are the absorbed and incident radiant flux, respectively
Reflectance	ρ	$\rho = \frac{\Phi_r}{\Phi_i}$	Φ_r is the reflected radiant flux
Transmittance	τ	$\tau = \frac{\Phi_t}{\Phi_i}$	Φ_t is the radiant flux transmitted through a layer or a surface
Optical depth	δ	$\tau = e^{-\delta}$	In the atmosphere, δ is defined in the vertical. Optical thickness equals $\delta / \cos \theta$, where θ is the apparent zenith angle

ANNEX 7.B

METEOROLOGICAL RADIATION QUANTITIES, SYMBOLS AND DEFINITIONS

Quantity	Symbol	Relation	Definitions and remarks	Units
Downward radiation	Φ_{\downarrow}^a	$\Phi_{\downarrow} = \Phi_{g\downarrow} + \Phi_{l\downarrow}$	Downward radiant flux	W
	Q_{\downarrow}	$Q_{\downarrow} = Q_{g\downarrow} + Q_{l\downarrow}$	" radiant energy	J (W s)
	M_{\downarrow}	$M_{\downarrow} = M_{g\downarrow} + M_{l\downarrow}$	" radiant exitance ^b	W m ⁻²
	E_{\downarrow}	$E_{\downarrow} = E_{g\downarrow} + E_{l\downarrow}$	" irradiance	W m ⁻²
	L_{\downarrow}	$L_{\downarrow} = L_{g\downarrow} + L_{l\downarrow}$	" radiance	W m ⁻² sr ⁻¹
	H_{\downarrow}	$H_{\downarrow} = H_{g\downarrow} + H_{l\downarrow}$ (<i>g</i> = global) (<i>l</i> = long wave)	" radiant exposure for a specified time interval	J m ⁻² per time interval
	Upward radiation	Φ_{\uparrow}^a	$\Phi_{\uparrow} = \Phi_{r\uparrow} + \Phi_{l\uparrow}$	Upward radiant flux
Q_{\uparrow}		$Q_{\uparrow} = Q_{r\uparrow} + Q_{l\uparrow}$	" radiant energy	J (W s)
M_{\uparrow}		$M_{\uparrow} = M_{r\uparrow} + M_{l\uparrow}$	" radiant exitance	W m ⁻²
E_{\uparrow}		$E_{\uparrow} = E_{r\uparrow} + E_{l\uparrow}$	" irradiance	W m ⁻²
L_{\uparrow}		$L_{\uparrow} = L_{r\uparrow} + L_{l\uparrow}$	" radiance	W m ⁻² sr ⁻¹
H_{\uparrow}		$H_{\uparrow} = H_{r\uparrow} + H_{l\uparrow}$	" radiant energy per unit area for a specified time interval	J m ⁻² per time interval
Global radiation		$E_{g\downarrow}$	$E_{g\downarrow} =$ $E \cos \theta_{\odot} + E_d \downarrow$	Hemispherical irradiance on a horizontal surface (θ_{\odot} = <i>apparent</i> <i>solar zenith angle</i>) ^c
Sky radiation: downward diffuse solar radiation	$\Phi_d \downarrow$		Subscript <i>d</i> = diffuse	As for downward radiation
	$Q_d \downarrow$			
	$M_d \downarrow$			
	$E_d \downarrow$			
	$L_d \downarrow$			
Upward/downward long-wave radiation	$\Phi_{l\uparrow}, \Phi_{l\downarrow}$		Subscript <i>l</i> = long wave. If only atmospheric radiation is considered, the subscript <i>a</i> may be added, e.g., $\Phi_{l,a\uparrow} \sigma \sigma$	As for downward radiation
	$Q_{l\uparrow}, Q_{l\downarrow}$			
	$M_{l\uparrow}, M_{l\downarrow}$			
	$E_{l\uparrow}, E_{l\downarrow}$			
	$H_{l\uparrow}, H_{l\downarrow}$			
Reflected solar radiation	$\Phi_{r\uparrow}$		Subscript <i>r</i> = reflected (the subscript <i>s</i> (specular) and <i>d</i> (diffuse) may be used, if a distinction is to be made between these two components)	As for downward radiation
	$Q_{r\uparrow}$			
	$M_{r\uparrow}$			
	$E_{r\uparrow}$			
	$H_{r\uparrow}$			
Net radiation	Φ^*	$\Phi^* = \Phi_{\downarrow} - \Phi_{\uparrow}$	The subscript <i>g</i> or <i>l</i> is to be added to each of the symbols if only short-wave or long-wave net radiation quantities are considered	As for downward radiation
	Q^*	$Q^* = Q_{\downarrow} - Q_{\uparrow}$		
	M^*	$M^* = M_{\downarrow} - M_{\uparrow}$		
	E^*	$E^* = E_{\downarrow} - E_{\uparrow}$		
	L^*	$L^* = L_{\downarrow} - L_{\uparrow}$		
	H^*	$H^* = H_{\downarrow} - H_{\uparrow}$		

Quantity	Symbol	Relation	Definitions and remarks	Units
Direct solar radiation	E	$E = E_0 \tau e^{-\delta/\cos\theta_{\odot}}$	τ = atmospheric transmittance δ = optical depth (vertical)	W m^{-2}
Solar constant	E_0		Solar irradiance, normalized to mean sun-Earth distance	W m^{-2}

^a The symbols – or + could be used instead of ↓ or ↑ (e.g., $\Phi^+ = \Phi\uparrow$).

^b Exitance is radiant flux emerging from the unit area; irradiance is radiant flux received per unit area. For flux density in general, the symbol M or E can be used. Although not specifically recommended, the symbol F , defined as Φ/area , may also be introduced.

^c In the case of inclined surfaces, θ_{\odot} is the angle between the normal to the surface and the direction to the sun.

ANNEX 7.C

SPECIFICATIONS FOR WORLD, REGIONAL AND NATIONAL RADIATION CENTRES

World Radiation Centres

The World Radiation Centres were designated by the Executive Committee at its thirtieth session in 1978 through Resolution 11 (EC-XXX) to serve as centres for the international calibration of meteorological radiation standards within the global network and to maintain the standard instruments for this purpose.

A World Radiation Centre shall fulfil the following requirements. It should either:

1. (a) Possess and maintain a group of at least three stable absolute pyrheliometers, with a traceable 95 per cent uncertainty of less than 1 W m^{-2} to the World Radiometric Reference, and in stable, clear sun conditions with direct irradiances above 700 W m^{-2} , 95 per cent of any single measurements of direct solar irradiance will be expected to be within 4 W m^{-2} of the irradiance. The World Radiation Centre Davos is requested to maintain the World Standard Group for realization of the World Radiometric Reference;
 - (b) It shall undertake to train specialists in radiation;
 - (c) The staff of the centre should provide for continuity and include qualified scientists with wide experience in radiation;
 - (d) It shall take all steps necessary to ensure, at all times, the highest possible quality of its standards and testing equipment;
 - (e) It shall serve as a centre for the transfer of the World Radiometric Reference to the regional centres;
 - (f) It shall have the necessary laboratory and outdoor facilities for the simultaneous comparison of large numbers of instruments and for data reduction;
 - (g) It shall follow closely or initiate developments leading to improved standards and/or methods in meteorological radiometry;
 - (h) It shall be assessed an international agency or by CIMO experts, at least every five years, to verify traceability of the direct solar radiation measurements; or
2. (a) Provide and maintain an archive for solar radiation data from all the Member States of WMO;
 - (b) The staff of the centre should provide for continuity and include qualified scientists with wide experience in radiation;
 - (c) It shall take all steps necessary to ensure, at all times, the highest possible quality of, and access to, its database;
 - (d) It shall be assessed by an international agency or by CIMO experts, at least every five years.

Regional Radiation Centres

A Regional Radiation Centre is a centre designated by a regional association to serve as a centre for intraregional comparisons of radiation instruments within the Region and to maintain the standard instrument necessary for this purpose.

A Regional Radiation Centre shall satisfy the following conditions before it is designated as such and shall continue to fulfil them after being designated:

- (a) It shall possess and maintain a standard group of at least three stable pyrheliometers, with a traceable 95 per cent uncertainty of less than 1 W m^{-2} to the World Standard Group, and in stable, clear sun conditions with direct irradiances above 700 W m^{-2} , 95 per cent of any single measurements of direct solar irradiance will be expected to be within 6 W m^{-2} of the irradiance;
- (b) One of the radiometers shall be compared through a WMO/CIMO sanctioned comparison, or calibrated, at least once every five years against the World Standard Group;
- (c) The standard radiometers shall be intercompared at least once a year to check the stability of the individual instruments. If the mean ratio, based on at least 100 measurements, and with a 95 per cent, uncertainty less than 0.1 per cent, has changed by more than 0.2 per cent, and if the erroneous instrument cannot be identified, a recalibration at one of the World Radiation Centres must be performed prior to further use as a standard;
- (d) It shall have, or have access to, the necessary facilities and laboratory equipment for checking and maintaining the accuracy of the auxiliary measuring equipment;

- (e) It shall provide the necessary outdoor facilities for simultaneous comparison of national standard radiometers from the Region;
- (f) The staff of the centre should provide for continuity and include a qualified scientist with wide experience in radiation;
- (g) It shall be assessed by a national or international agency or by CIMO experts, at least every five years, to verify traceability of the direct solar radiation measurements.

National Radiation Centres

A National Radiation Centre is a centre designated at the national level to serve as a centre for the calibration, standardization and checking of the instruments used in the national network of radiation stations and for maintaining the national standard instrument necessary for this purpose.

A National Radiation Centre shall satisfy the following requirements:

- (a) It shall possess and maintain at least two pyrhemeters for use as a national reference for the calibration of radiation instruments in the national network of radiation stations with a traceable 95 per cent uncertainty of less than 4 W m^{-2} to the regional representation of the World Radiometric Reference, and in stable, clear sun conditions with direct irradiances above 700 W m^{-2} , 95 per cent of any single measurements of direct solar irradiance will be expected to be within 20 W m^{-2} of the irradiance;
- (b) One of the national standard radiometers shall be compared with a regional standard at least once every five years;
- (c) The national standard radiometers shall be intercompared at least once a year to check the stability of the individual instruments. If the mean ratio, based on at least 100 measurements, and with a 95 per cent uncertainty less than 0.2 per cent, has changed by more than 0.6 per cent and if the erroneous instrument cannot be identified, a recalibration at one of the Regional Radiation Centres must be performed prior to further use as a standard;
- (d) It shall have or, have access to, the necessary facilities and equipment for checking the performance of the instruments used in the national network;
- (e) The staff of the centre should provide for continuity and include a qualified scientist with experience in radiation.

National Radiation Centres shall be responsible for preparing and keeping up to date all necessary

technical information for the operation and maintenance of the national network of radiation stations.

Arrangements should be made for the collection of the results of all radiation measurements taken in the national network of radiation stations, and for the regular scrutiny of these results with a view to ensuring their accuracy and reliability. If this work is done by some other body, the National Radiation Centre shall maintain close liaison with the body in question.

List of World and Regional Radiation Centres

WORLD RADIATION CENTRES

Davos	(Switzerland)
St Petersburg ²	(Russian Federation)

REGIONAL RADIATION CENTRES

Region I (Africa):

Cairo	(Egypt)
Khartoum	(Sudan)
Kinshasa	(Democratic Republic of the Congo)
Lagos	(Nigeria)
Tamanrasset	(Algeria)
Tunis	(Tunisia)

Region II (Asia):

Pune	(India)
Tokyo	(Japan)

Region III (South America):

Buenos Aires	(Argentina)
Santiago	(Chile)
Huayao	(Peru)

Region IV (North America, Central America and the Caribbean):

Toronto	(Canada)
Boulder	(United States)
Mexico City/Colima	(Mexico)

Region V (South-West Pacific):

Melbourne	(Australia)
-----------	-------------

Region VI (Europe):

Budapest	(Hungary)
Davos	(Switzerland)
St Petersburg	(Russian Federation)
Norrköping	(Sweden)
Trappes/Carpentras	(France)
Uccle	(Belgium)
Lindenberg	(Germany)

² Mainly operated as a World Radiation Data Centre under the Global Atmosphere Watch Strategic Plan.

ANNEX 7.D

USEFUL FORMULAE

General

All astronomical data can be derived from tables in the nautical almanacs or ephemeris tables. However, approximate formulae are presented for practical use. Michalsky (1988*a, b*) compared several sets of approximate formulae and found that the best are the equations presented as convenient approximations in the *Astronomical Almanac* (United States Naval Observatory, 1993). They are reproduced here for convenience.

The position of the sun

To determine the actual location of the sun, the following input values are required:

- (a) Year;
- (b) Day of year (for example, 1 February is day 32);
- (c) Fractional hour in universal time (UT) (for example, hours + minute/60 + number of hours from Greenwich);
- (d) Latitude in degrees (north positive);
- (e) Longitude in degrees (east positive).

To determine the Julian date (JD), the *Astronomical Almanac* determines the present JD from a prime JD set at noon 1 January 2000 UT. This JD is 2 451 545.0. The JD to be determined can be found from:

$$JD = 2\,432\,916.5 + \delta \cdot 365 + \text{leap} + \text{day} + \text{hour}/24$$

where: $\delta = \text{year} - 1949$

$$\text{leap} = \text{integer portion of } (\delta/4)$$

The constant 2 432 916.5 is the JD for 0000 1 January 1949 and is simply used for convenience.

Using the above time, the ecliptic coordinates can be calculated according to the following steps (L , g and l are in degrees):

- (a) $n = JD - 2\,451\,545$;
- (b) L (mean longitude) = $280.460 + 0.985\,647\,4 \cdot n$ ($0 \leq L < 360^\circ$);
- (c) g (mean anomaly) = $357.528 + 0.985\,600\,3 \cdot n$ ($0 \leq g < 360^\circ$);
- (d) l (ecliptic longitude) = $L + 1.915 \cdot \sin(g) + 0.020 \cdot \sin(2g)$ ($0 \leq l < 360^\circ$);

- (e) ep (obliquity of the ecliptic) = $23.439 - 0.000\,000\,4 \cdot n$ (degrees).

It should be noted that the specifications indicate that all multiples of 360° should be added or subtracted until the final value falls within the specified range.

From the above equations, the celestial coordinates can be calculated – the right ascension (ra) and the declination (dec) – by:

$$\tan(ra) = \cos(ep) \cdot \sin(l) / \cos(l)$$

$$\sin(dec) = \sin(ep) \cdot \sin(l)$$

To convert from celestial coordinates to local coordinates, that is, right ascension and declination to azimuth (A) and altitude (a), it is convenient to use the local hour angle (h). This is calculated by first determining the Greenwich mean sidereal time (GMST, in hours) and the local mean sidereal time (LMST, in hours):

$$GMST = 6.697\,375 + 0.065\,709\,824\,2 \cdot n + \text{hour (UT)}$$

where: $0 \leq GMST < 24\text{h}$

$$LMST = GMST + (\text{east longitude}) / (15^\circ \text{ h}^{-1})$$

From the LMST, the hour angle (ha) is calculated as (ha and ra are in degrees):

$$ha = LMST - 15 \cdot ra \quad (-12 \leq ha < 12\text{h})$$

Before the sun reaches the meridian, the hour angle is negative. Caution should be observed when using this term, because it is opposite to what some solar researchers use.

The calculations of the solar elevation (el) and the solar azimuth (az) follow (az and el are in degrees):

$$\sin(el) = \sin(dec) \cdot \sin(lat) + \cos(dec) \cdot \cos(lat) \cdot \cos(ha)$$

and:

$$\sin(az) = -\cos(dec) \cdot \sin(ha) / \cos(el)$$

$$\cos(az) = \frac{(\sin(dec) - \sin(el) \cdot \sin(lat))}{(\cos(el) \cdot \cos(lat))}$$

where the azimuth is from 0° north, positive through east.

To take into account atmospheric refraction, and derive the apparent solar elevation (h) or the apparent solar zenith angle, the *Astronomical Almanac* proposes the following equations:

- (a) A simple expression for refraction R for zenith angles less than 75° :

$$r = 0^\circ.004\ 52\ P \tan z / (273 + T)$$

where z is the zenith distance in degrees; P is the pressure in hectopascals; and T is the temperature in $^\circ\text{C}$.

- (b) For zenith angles greater than 75° and altitudes below 15° , the following approximate formula is recommended:

$$r = \frac{P(0.159\ 4 + 0.019\ 6a + 0.000\ 02a^2)}{[(273 + T)(1 + 0.505a + 0.084\ 5a^2)]}$$

where a is the elevation ($90^\circ - z$) where $h = el + r$ and the apparent solar zenith angle $z_0 = z + r$.

Sun-Earth distance

The present-day eccentricity of the orbit of the Earth around the sun is small but significant to the extent that the square of the sun-Earth distance R and, therefore, the solar irradiance at the Earth, varies by 3.3 per cent from the mean. In astronomical units (AU), to an uncertainty of 10^{-4} :

$$R = 1.000\ 14 - 0.016\ 71 \cdot \cos(g) - 0.000\ 14 \cdot \cos(2g)$$

where g is the mean anomaly and is defined above. The solar eccentricity is defined as the mean sun-Earth distance (1 AU, R_0) divided by the actual sun-Earth distance squared:

$$E_0 = (R_0/R)^2$$

Air mass

In calculations of extinction, the path length through the atmosphere, which is called the absolute optical air mass, must be known. The relative air mass for an arbitrary atmospheric constituent, m , is the ratio of the air mass along the slant path to the air mass in the vertical direction; hence, it is a normalizing factor. In a plane parallel, non-refracting atmosphere m is equal to $1/\sin h_0$ or $1/\cos z_0$.

Local apparent time

The mean solar time, on which our civil time is based, is derived from the motion of an imaginary body called the mean sun, which is considered as moving at uniform speed in the celestial equator at a rate equal to the average rate of movement of the true sun. The difference between this fixed time reference and the variable local apparent time is called the equation of time, Eq , which may be positive or negative depending on the relative position of the true mean sun. Thus:

$$LAT = LMT + Eq = CT + LC + Eq$$

where LAT is the local apparent time (also known as TST , true solar time), LMT is the local mean time; CT is the civil time (referred to a standard meridian, thus also called standard time); and LC is the longitude correction (4 min for every degree). LC is positive if the local meridian is east of the standard and vice versa.

For the computation of Eq , in minutes, the following approximation may be used:

$$Eq = 0.017\ 2 + 0.428\ 1 \cos \theta_0 - 7.351\ 5 \sin \theta_0 - 3.349\ 5 \cos 2\theta_0 - 9.361\ 9 \sin 2\theta_0$$

where $\theta_0 = 2\pi d_n/365$ in radians or $\theta_0 = 360 d_n/365$ in degrees, and where d_n is the day number ranging from 0 on 1 January to 364 on 31 December for a normal year or to 365 for a leap year. The maximum error of this approximation is 35 s (which is excessive for some purposes, such as air-mass determination).

ANNEX 7.E

DIFFUSE SKY RADIATION – CORRECTION FOR A SHADING RING

The shading ring is mounted on two rails oriented parallel to the Earth’s axis, in such a way that the centre of the ring coincides with the pyranometer during the equinox. The diameter of the ring ranges from 0.5 to 1.5 m and the ratio of the width to the radius b/r ranges from 0.09 to 0.35. The adjustment of the ring to the solar declination is made by sliding the ring along the rails. The length of the shading band and the height of the mounting of the rails relative to the pyranometer are determined from the solar position during the summer solstice; the higher the latitude, the longer the shadow band and the lower the rails.

Several authors, for example, Drummond (1956), Dehne (1980) and Le Baron, Peterson and Dirmhirn (1980), have proposed formulae for operational corrections to the sky radiation accounting for the part not measured due to the shadow band. For a ring with $b/r < 0.2$, the radiation D_v lost during a day can be expressed as:

$$D_v \approx \frac{b}{r} \cos^3 \delta \int_{t_{rise}}^{t_{set}} L(t) \cdot \sin h_{\odot}(t) dt$$

where δ is the declination of the sun; t is the hour angle of the sun; t_{rise} and t_{set} are the hour angle at sunrise and sunset, respectively, for a mathematical horizon (Φ being the geographic latitude, $t_{rise} = -t_{set}$ and $\cos t_{rise} = -\tan \Phi \cdot \tan \delta$); $L(t)$ is the sky radiance during the day; and h_{\odot} is the solar elevation.

With this expression and some assumptions on the sky radiance, a correction factor f can be determined:

$$f = \frac{1}{1 - \frac{D_v}{D}}$$

D being the unobscured sky radiation. In the figure below, an example of this correction factor is given for both a clear and an overcast sky, compared with the corresponding empirical curves. It is evident that the deviations from the theoretical curves depend on climatological factors of the station and should be determined experimentally by comparing the instrument equipped with a shading ring with an instrument shaded by a continuously traced disc. If no experimental data are available for the station, data computed for the overcast case with the corresponding b/r should be used. Thus:

$$\frac{D_v}{D_{overcast}} = \frac{b}{r} \cos^3 \delta (t_{set} - t_{rise}) \cdot \sin \Phi \cdot \sin \delta + \cos \Phi \cdot \cos \delta \cdot (\sin t_{set} - \sin t_{rise})$$

where δ is the declination of the sun; Φ is the geographic latitude; and t_{rise} and t_{set} are the solar hour angle for set and rise, respectively (for details, see above).

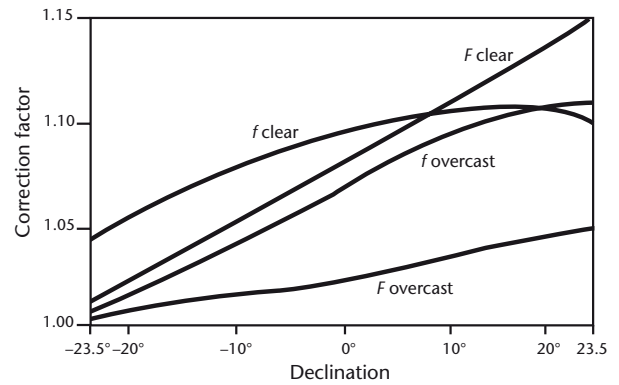

Comparison of calculated and empirically determined correction factors for a shading ring, with $b/r = 0.169$; f indicates calculated curves and F indicates empirical ones (after Dehne, 1980).

REFERENCES AND FURTHER READING

- Bass, A.M. and R.J. Paur, 1985: The ultraviolet cross-sections of ozone: I. The Measurements. *Atmospheric Ozone* (C.S. Zerefos and A. Ghazi, eds.), Reidel, Dordrecht, pp. 606–610.
- Bodhaine, B.A., N.B. Wood, E.G. Dutton and J.R. Slusser, 1999: On Rayleigh optical depth calculations. *Journal of Atmospheric Oceanic Technology*, 16, pp. 1854–1861.
- Dehne, K., 1980: Vorschlag zur standardisierten Reduktion der Daten verschiedener nationaler Himmelsstrahlungs-Messnetze. *Annalen der Meteorologie* (Neue Folge), 16, pp. 57–59.
- Drummond, A.J., 1956: On the measurement of sky radiation. *Archiv für Meteorologie, Geophysik und Bioklimatologie*, Serie B, 7, pp. 413–436.
- Forgan, B.W., 1996: A new method for calibrating reference and field pyranometers. *Journal of Atmospheric and Oceanic Technology*, 13, pp. 638–645.
- Fröhlich, C. and G.E. Shaw, 1980: New determination of Rayleigh scattering in the terrestrial atmosphere. *Applied Optics*, Volume 19, Issue 11, pp. 1773–1775.
- Frouin, R., P.-Y. Deschamps, and P. Lecomte, 1990: Determination from space of atmospheric total water vapour amounts by differential absorption near 940 nm: Theory and airborne verification. *Journal of Applied Meteorology*, 29, pp. 448–460.
- International Commission on Illumination, 1987: *Methods of Characterizing Illuminance Meters and Luminance Meters*. ICI-No. 69-1987.
- International Commission on Illumination, 1994: *Guide to Recommended Practice of Daylight Measurement*. ICI No. 108-1994.
- International Electrotechnical Commission, 1987: *International Electrotechnical Vocabulary*. Chapter 845: Lighting, IEC 60050-845.
- International Organization for Standardization, 1990a: *Solar Energy – Specification and Classification of Instruments for Measuring Hemispherical Solar and Direct Solar Radiation*. ISO 9060.
- International Organization for Standardization, 1990b: *Solar Energy – Calibration of Field Pyrheliometers by Comparison to a Reference Pyrheliometer*. ISO 9059.
- International Organization for Standardization, 1990c: *Solar Energy – Field Pyranometers – Recommended Practice for Use*. ISO/TR 9901.
- International Organization for Standardization, 1992: *Solar Energy – Calibration of field pyranometers by comparison to a reference pyranometer*. ISO 9847.
- International Organization for Standardization, 1993: *Solar Energy – Calibration of a pyranometer using a pyrhelimeter*. ISO 9846.
- International Organization for Standardization, 1995: *Guide to the Expression of Uncertainty in Measurement*, Geneva.
- Kerr, J.B. and T.C. McElroy, 1993: Evidence for large upward trends of ultraviolet-B radiation linked to ozone depletion. *Science*, 262, pp. 1032–1034.
- Kuhn, M., 1972: Die spektrale Transparenz der antarktischen Atmosphäre. Teil I: Meßinstrumente und Rechenmethoden. *Archiv für Meteorologie, Geophysik und Bioklimatologie*, Serie B, 20, pp. 207–248.
- Lal, M., 1972: On the evaluation of atmospheric turbidity parameters from actinometric data. *Geofísica Internacional*, Volume 12, Number 2, pp. 1–11.
- Le Baron, B.A., W.A. Peterson, and I. Dirmhirn, 1980: Corrections for diffuse irradiance measured with shadowbands. *Solar Energy*, 25, pp. 1–13.
- Michalsky, J.J., 1988a: The astronomical almanac's algorithm for approximate solar position (1950–2050). *Solar Energy*, Volume 40, Number 3, pp. 227–235.
- Michalsky, J.J., 1988b: Errata. The astronomical almanac's algorithm for approximate solar position (1950–2050). *Solar Energy*, Volume 41, Number 1.
- McKinlay A.F. and B.L. Diffey, 1987: A reference action spectrum for ultraviolet induced erythema in human skin. In: W.F. Passchier, and B.F.M. Bosnjakovic (eds), *Human Exposure to Ultraviolet Radiation: Risks and Regulations*, Elsevier, Amsterdam, pp. 83–87.
- Parrish, J.A., K.F. Jaenicke and R.R. Anderson, 1982: Erythema and melanogenesis action spectra of normal human skin. *Photochemistry and Photobiology*, 36, pp. 187–191.
- Rüedi, I., 2001: *International Pyrheliometer Comparison IPC-IX, Results and Symposium*. MeteoSwiss Working Report No. 197, Davos and Zurich.
- Schneider, W., G.K. Moortgat, G.S. Tyndall and J.P. Burrows, 1987: Absorption cross-sections of NO₂ in the UV and visible region (200–700 nm) at 298 K. *Journal of Photochemistry and Photobiology, A: Chemistry*, 40, pp. 195–217.

- United States Naval Observatory, 1993: *The Astronomical Almanac*, Nautical Almanac Office, Washington DC.
- Vigroux, E., 1953: Contribution à l'étude expérimentale de l'absorption de l'ozone. *Annales de Physique*, 8, pp. 709–762.
- Webb, A.R., B.G. Gardiner, M. Blumthaler and P. Foster, 1994: A laboratory investigation of two ultraviolet spectroradiometers. *Photochemistry and Photobiology*, Volume 60, No. 1, pp. 84–90.
- World Meteorological Organization, 1978: *International Operations Handbook for Measurement of Background Atmospheric Pollution*. WMO-No. 491, Geneva.
- World Meteorological Organization, 1986a: *Revised Instruction Manual on Radiation Instruments and Measurements*. World Climate Research Programme Publications Series No. 7, WMO/TD-No. 149, Geneva.
- World Meteorological Organization, 1986b: *Recent Progress in Sunphotometry: Determination of the Aerosol Optical Depth*. Environmental Pollution Monitoring and Research Programme Report No. 43, WMO/TD-No. 143, Geneva.
- World Meteorological Organization, 1993a: *Report of the WMO Workshop on the Measurement of Atmospheric Optical Depth and Turbidity* (Silver Spring, United States, 6–10 December 1993). Global Atmosphere Watch Report No. 101, WMO/TD-No. 659, Geneva.
- World Meteorological Organization, 1993b: *Report of the Second Meeting of the Ozone Research Managers of the Parties to the Vienna Convention for the Protection of the Ozone Layer* (Geneva, 10–12 March, 1993). WMO Global Ozone Research and Monitoring Project Report No. 32, Geneva.
- World Meteorological Organization, 1996: *WMO/UMAP Workshop on Broad-band UV Radiometers* (Garmisch-Partenkirchen, Germany, 22–23 April 1996). Global Atmosphere Watch Report No. 120, WMO/TD-No. 894, Geneva.
- World Meteorological Organization, 1998: *Baseline Surface Radiation Network (BSRN): Operations Manual*. WMO/TD-No. 879, Geneva.
- World Meteorological Organization, 1999a: *Guidelines for Site Quality Control of UV Monitoring*. Global Atmosphere Watch Report No. 126, WMO/TD-No. 884, Geneva.
- World Meteorological Organization, 1999b: *Report of the LAP/COST/WMO Intercomparison of Erythral Radiometers*. (Thessaloniki, Greece, 13–23 September 1999). WMO Global Atmosphere Watch Report No. 141, WMO/TD-No. 1051, Geneva.
- World Meteorological Organization, 2001: *Instruments to Measure Solar Ultraviolet Radiation*. Part 1: Spectral instruments, Global Atmosphere Watch Report No. 125, WMO/TD-No. 1066, Geneva.
- World Meteorological Organization, 2005: *WMO/GAW Experts Workshop on a Global Surface-Based Network for Long Term Observations of Column Aerosol Optical Properties* (Davos, Switzerland, 8–10 March 2004). Global Atmosphere Watch Report No. 162, WMO/TD-No. 1287, Geneva.
- Young, A.T., 1981: On the Rayleigh-scattering optical depth of the atmosphere. *Journal of Applied Meteorology*, 20, pp. 328–330.
-

CHAPTER 8

MEASUREMENT OF SUNSHINE DURATION

8.1 GENERAL

The term “sunshine” is associated with the brightness of the solar disc exceeding the background of diffuse sky light, or, as is better observed by the human eye, with the appearance of shadows behind illuminated objects. As such, the term is related more to visual radiation than to energy radiated at other wavelengths, although both aspects are inseparable. In practice, however, the first definition was established directly by the relatively simple Campbell-Stokes sunshine recorder (see section 8.2.3), which detects sunshine if the beam of solar energy concentrated by a special lens is able to burn a special dark paper card. This recorder was already introduced in meteorological stations in 1880 and is still used in many networks. Since no international regulations on the dimensions and quality of the special parts were established, applying different laws of the principle gave different sunshine duration values.

In order to homogenize the data of the worldwide network for sunshine duration, a special design of the Campbell-Stokes sunshine recorder, the so-called interim reference sunshine recorder (IRSR), was recommended as the reference (WMO, 1962). The improvement made by this “hardware definition” was effective only during the interim period needed for finding a precise physical definition allowing for both designing automatic sunshine recorders and approximating the “scale” represented by the IRSR as near as possible. With regard to the latter, the settlement of a direct solar threshold irradiance corresponding to the burning threshold of the Campbell-Stokes recorders was strongly advised. Investigations at different stations showed that the threshold irradiance for burning the card varied between 70 and 280 W m⁻² (Bider, 1958; Baumgartner, 1979). However, further investigations, especially performed with the IRSR in France, resulted in a mean value of 120 W m⁻², which was finally proposed as the threshold of direct solar irradiance to distinguish bright sunshine.¹ With regard to the spread of test results, a threshold accuracy of 20 per cent in instrument specifications is accepted. A pyrheliometer was

recommended as the reference sensor for the detection of the threshold irradiance. For future refinement of the reference, the settlement of the field-of-view angle of the pyrheliometer seems to be necessary (see Part I, Chapter 7, sections 7.2 and 7.2.1.3).

8.1.1 Definition

According to WMO (2003),² sunshine duration during a given period is defined as the sum of that sub-period for which the direct solar irradiance exceeds 120 W m⁻².

8.1.2 Units and scales

The physical quantity of sunshine duration (*SD*) is, evidently, time. The units used are seconds or hours. For climatological purposes, derived terms such as “hours per day” or “daily sunshine hours” are used, as well as percentage quantities, such as “relative daily sunshine duration”, where *SD* may be related to the extra-terrestrial possible, or to the maximum possible, sunshine duration (*SD*₀ and *SD*_{max}, respectively). The measurement period (day, decade, month, year, and so on) is an important addendum to the unit.

8.1.3 Meteorological requirements

Performance requirements are given in Part I, Chapter 1. Hours of sunshine should be measured with an uncertainty of ±0.1 h and a resolution of 0.1 h.

Since the number and steepness of the threshold transitions of direct solar radiation determine the possible uncertainty of sunshine duration, the meteorological requirements on sunshine recorders are essentially correlated with the climatological cloudiness conditions (WMO, 1985).

In the case of a cloudless sky, only the hourly values at sunrise or sunset constellations can (depending on the amount of dust) be erroneous because of an imperfectly adjusted threshold or spectral dependencies.

1 Recommended by the Commission for Instruments and Methods of Observation at its eighth session (1981) through Recommendation 10 (CIMO-VIII).

2 Recommended by the Commission for Instruments and Methods of Observation at its tenth session (1989) through Recommendation 16 (CIMO-X).

In the case of scattered clouds (cumulus, stratocumulus), the steepness of the transition is high and the irradiance measured from the cloudy sky with a pyrheliometer is generally lower than 80 W m^{-2} ; that means low requirements on the threshold adjustment. But the field-of-view angle of the recorder can influence the result if bright cloud clusters are near the sun.

The highest precision is required if high cloud layers (cirrus, altostratus) with small variations of the optical thickness attenuate the direct solar irradiance around the level of about 120 W m^{-2} . The field-of-view angle is effective as well as the precision of the threshold adjustment.

The requirements on sunshine recorders vary, depending on site and season, according to the dominant cloud formation. The latter can be roughly described by three ranges of relative daily sunshine duration SD/SD_0 (see section 8.1.2), namely "cloudy sky" by ($0 \leq SD/SD_0 < 0.3$), "scattered clouds" by ($0.3 \leq SD/SD_0 < 0.7$) and "fair weather" by ($0.7 \leq SD/SD_0 \leq 1.0$). The results for dominant clouded sky generally show the highest percentage of deviations from the reference.

8.1.3.1 Application of sunshine duration data

One of the first applications of SD data was to characterize the climate of sites, especially of health resorts. This also takes into account the psychological effect of strong solar light on human well-being. It is still used by some local authorities to promote tourist destinations.

The description of past weather conditions, for instance of a month, usually contains the course of daily SD data.

For these fields of application, an uncertainty of about 10 per cent of mean SD values seemed to be acceptable over many decades.

8.1.3.2 Correlations to other meteorological variables

The most important correlation between sunshine duration and global solar radiation G is described by the so-called Ångström formula:

$$G/G_0 = a + b \cdot (SD/SD_0) \quad (8.1)$$

where G/G_0 is the so-called clearness index (related to the extra-terrestrial global irradiation), SD/SD_0 is the corresponding sunshine duration (related to

the extra-terrestrial possible SD value), and a and b are constants which have to be determined monthly. The uncertainty of the monthly means of daily global irradiation derived in this way from Campbell-Stokes data was found to be lower than 10 per cent in summer, and rose up to 30 per cent in winter, as reported for German stations (Golchert, 1981).

The Ångström formula implies the inverse correlation between cloud amount and sunshine duration. This relationship is not fulfilled for high and thin cloudiness and obviously not for cloud fields which do not cover the sun, so that the degree of inverse correlation depends first of all on the magnitude of the statistical data collected (Stanghellini, 1981; Angell, 1990). The improvement of the accuracy of SD data should reduce the scattering of the statistical results, but even perfect data can generate sufficient results only on a statistical basis.

8.1.3.3 Requirement of automated records

Since electrical power is available in an increasing number of places, the advantage of the Campbell-Stokes recorder of being self-sufficient is of decreasing importance. Furthermore, the required daily maintenance requirement of replacing the burn card makes the use of Campbell-Stokes recorders problematic at either automatic weather stations or stations with reduced numbers of personnel. Another essential reason to replace Campbell-Stokes recorders by new automated measurement procedures is to avoid the expense of visual evaluations and to obtain more precise results on data carriers permitting direct computerized data processing.

8.1.4 Measurement methods

The principles used for measuring sunshine duration and the pertinent types of instruments are briefly listed in the following methods:

- (a) Pyrheliometric method: Pyrheliometric detection of the transition of direct solar irradiance through the 120 W m^{-2} threshold (according to Recommendation 10 (CIMO-VIII)). Duration values are readable from time counters triggered by the appropriate upward and downward transitions.

Type of instrument: pyrheliometer combined with an electronic or computerized threshold discriminator and a time-counting device.

- (b) Pyranometric method:
- (i) Pyranometric measurement of global (G) and diffuse (D) solar irradiance to derive the direct solar irradiance as the WMO threshold discriminator value and further as in (a) above.

Type of instrument: Radiometer systems of two fitted pyranometers and one sunshade device combined with an electronic or computerized threshold discriminator and a time-counting device.

- (ii) Pyranometric measurement of global (G) solar irradiance to roughly estimate sunshine duration.

Type of instrument: a pyranometer combined with an electronic or computerized device which is able to deliver 10 min means as well as minimum and maximum global (G) solar irradiance within those 10 min.

- (c) Burn method: Threshold effect of burning paper caused by focused direct solar radiation (heat effect of absorbed solar energy). The duration is read from the total burn length.

Type of instrument: Campbell-Stokes sunshine recorders, especially the recommended version, namely the IRSR (see section 8.2).

- (d) Contrast method: Discrimination of the isolation contrasts between some sensors in different positions to the sun with the aid of a specific difference of the sensor output signals which corresponds to an equivalent of the WMO recommended threshold (determined by comparisons with reference SD values) and further as in (b) above.

Type of instrument: Specially designed multi-sensor detectors (mostly equipped with photovoltaic cells) combined with an electronic discriminator and a time counter.

- (e) Scanning method: Discrimination of the irradiance received from continuously scanned, small sky sectors with regard to an equivalent of the WMO recommended irradiance threshold (determined by comparisons with reference SD values).

Type of instrument: One-sensor receivers equipped with a special scanning device

(rotating diaphragm or mirror, for instance) and combined with an electronic discriminator and a time-counting device.

The sunshine duration measurement methods described in the following paragraphs are examples of ways to achieve the above-mentioned principles. Instruments using these methods, with the exception of the Foster switch recorder, participated in the WMO Automatic Sunshine Duration Measurement Comparison in Hamburg from 1988 to 1989 and in the comparison of pyranometers and electronic sunshine duration recorders of Regional Association VI in Budapest in 1984 (WMO, 1986).

The description of the Campbell-Stokes sunshine recorder in section 8.2.3 is relatively detailed since this instrument is still widely used in national networks, and the specifications and evaluation rules recommended by WMO should be considered (however, note that this method is no longer recommended,³ since the duration of bright sunshine is not recorded with sufficient consistency).

A historical review of sunshine recorders is given in Coulson (1975), Hameed and Pittalwala (1989) and Sonntag and Behrens (1992).

8.2 INSTRUMENTS AND SENSORS

8.2.1 Pyrheliometric method

8.2.1.1 General

This method, which represents a direct consequence of the WMO definition of sunshine (see section 8.1.1) and is, therefore, recommended to obtain reference values of sunshine duration, requires a weatherproof pyrheliometer and a reliable solar tracker to point the radiometer automatically or at least semi-automatically to the position of the sun. The method can be modified by the choice of pyrheliometer, the field-of-view angle of which influences the irradiance measured when clouds surround the sun.

The sunshine threshold can be monitored by the continuous comparison of the pyrheliometer output with the threshold equivalent voltage $V_{th} = 120 \text{ W m}^{-2} \cdot R \mu \text{ V W}^{-1} \text{ m}^2$, which is calculable

³ See Recommendation 10 (CIMO-VIII).

from the responsivity R of the pyrheliometer. A threshold transition is detected if $\Delta V = V - V_{th}$ changes its sign. The connected time counter is running when $\Delta V > 0$.

8.2.1.2 Sources of error

The field-of-view angle is not yet settled by agreed definitions (see Part I, Chapter 7, sections 7.2 and 7.2.1.3). Greater differences between the results of two pyrheliometers with different field-of-view angles are possible, especially if the sun is surrounded by clouds. Furthermore, typical errors of pyrheliometers, namely tilt effect, temperature dependence, non-linearity and zero-offset, depend on the class of the pyrheliometer. Larger errors appear if the alignment to the sun is not precise or if the entrance window is covered by rain or snow.

8.2.2 Pyranometric method

8.2.2.1 General

The pyranometric method to derive sunshine duration data is based on the fundamental relationship between the direct solar radiation (I) and the global (G) and diffuse (D) solar radiation:

$$I \cdot \cos \zeta = G - D \quad (8.2)$$

where ζ is the solar zenith angle and $I \cdot \cos \zeta$ is the horizontal component of I . To fulfil equation 8.2 exactly, the shaded field-of-view angle of the pyranometer for measuring D must be equal to the field-of-view angle of the pyrheliometer (see Part I, Chapter 7). Furthermore, the spectral ranges, as well as the time-constants of the pyrheliometers and pyranometers, should be as similar as possible.

In the absence of a sun-tracking pyrheliometer, but where computer-assisted pyranometric measurements of G and D are available, the WMO sunshine criterion can be expressed according to equation 8.2 by:

$$(G-D)/\cos \zeta > 120 \text{ W m}^{-2} \quad (8.3)$$

which is applicable to instantaneous readings.

The modifications of this method in different stations concern first of all:

- (a) The choice of pyranometer;
- (b) The shading device applied (shade ring or shade disc with solar tracker) and its shade geometry (shade angle);

- (c) The correction of shade-ring losses.

As a special modification, the replacement of the criterion in equation 8.3 by a statistically derived parameterization formula (to avoid the determination of the solar zenith angle) for applications in more simple data-acquisition systems should be mentioned (Sonntag and Behrens, 1992).

The pyranometric method using only one pyranometer to estimate sunshine duration is based on two assumptions on the relation between irradiance and cloudiness as follows:

- (a) A rather accurate calculation of the potential global irradiance at the Earth's surface based on the calculated value of the extra-terrestrial irradiation (G_0) by taking into account diminishing due to scattering in the atmosphere. The diminishing factor depends on the solar elevation h and the turbidity T of the atmosphere. The ratio between the measured global irradiance and this calculated value of the clear sky global irradiance is a good measure for the presence of clouds;
- (b) An evident difference between the minimum and maximum value of the global irradiance, measured during a 10 min interval, presumes a temporary eclipse of the sun by clouds. On the other hand, in the case of no such difference, there is no sunshine or sunshine only during the 10 min interval (namely, $SD = 0$ or $SD = 10$ min).

Based on these assumptions, an algorithm can be used (Slob and Monna, 1991) to calculate the daily SD from the sum of 10 min SD . Within this algorithm, SD is determined for succeeding 10 min intervals (namely, $SD_{10'} = f \cdot 10$ min, where f is the fraction of the interval with sunshine, $0 \leq f \leq 1$). The diminishing factor largely depends on the optical path of the sunlight travelling through the atmosphere. Because this path is related to the elevation of the sun, $h = 90^\circ - z$, the algorithm discriminates between three time zones. Although usually $f = 0$ or $f = 1$, special attention is given to $0 < f < 1$. This algorithm is given in the annex. The uncertainty is about 0.6 h for daily sums.

8.2.2.2 Sources of error

According to equation 8.3, the measuring errors in global and diffuse solar irradiance are propagated by the calculation of direct solar irradiance and are strongly amplified with increasing solar zenith angles. Therefore, the accuracy of corrections for

losses of diffuse solar energy by the use of shade rings (WMO, 1984a) and the choice of pyranometer quality is of importance to reduce the uncertainty level of the results.

8.2.3 The Campbell-Stokes sunshine recorder (burn method)

The Campbell-Stokes sunshine recorder consists essentially of a glass sphere mounted concentrically in a section of a spherical bowl, the diameter of which is such that the sun's rays are focused sharply on a card held in grooves in the bowl. The method of supporting the sphere differs according to whether the instrument is operated in polar, temperate or tropical latitudes. To obtain useful results, both the spherical segment and the sphere should be made with great precision, the mounting being so designed that the sphere can be accurately centred therein. Three overlapping pairs of grooves are provided in the spherical segment so that the cards can be suitable for different seasons of the year (one pair for both equinoxes), their length and shape being selected to suit the geometrical optics of the system. It should be noted that the aforementioned problem of burns obtained under variable cloud conditions indicates that this instrument, and indeed any instrument

using this method, does not provide accurate data of sunshine duration.

The table below summarizes the main specifications and requirements for a Campbell-Stokes sunshine recorder of the IRSR grade. A recorder to be used as an IRSR should comply with the detailed specifications issued by the UK Met Office, and IRSR record cards should comply with the detailed specifications issued by Météo-France.

8.2.3.1 Adjustments

In installing the recorder, the following adjustments are necessary:

- The base must be levelled;
- The spherical segment should be adjusted so that the centre line of the equinoctial card lies in the celestial Equator (the scale of latitude marked on the bowl support facilitates this task);
- The vertical plan through the centre of the sphere and the noon mark on the spherical segment must be in the plane of the geographic meridian (north-south adjustment).

Campbell-Stokes recorder (IRSR grade) specifications

<i>Glass sphere</i>		<i>Spherical segment</i>		<i>Record cards</i>	
Shape:	Uniform	Material:	Gunmetal or equivalent durability	Material:	Good quality pasteboard not affected appreciably by moisture
Diameter:	10 cm	Radius:	73 mm	Width:	Accurate to within 0.3 mm
Colour:	Very pale or colourless	Additional specifications:	(a) Central noon line engraved transversely across inner surface	Thickness:	0.4 ± 0.05 mm
Refractive index:	1.52 ± 0.02		(b) Adjustment for inclination of segment to horizontal according to latitude	Moisture effect:	Within 2 per cent
Focal length:	75 mm for sodium "D" light		(c) Double base with provision for levelling and azimuth setting	Colour:	Dark, homogeneous, no difference detected in diffuse daylight
				Graduations:	Hour-lines printed in black

A recorder is best tested for (c) above by observing the image of the sun at the local apparent noon; if the instrument is correctly adjusted, the image should fall on the noon mark of the spherical segment or card.

8.2.3.2 Evaluation

In order to obtain uniform results from Campbell-Stokes recorders, it is especially important to conform closely to the following directions for measuring the IRSR records. The daily total duration of bright sunshine should be determined by marking off on the edge of a card of the same curvature the lengths corresponding to each mark and by measuring the total length obtained along the card at the level of the recording to the nearest tenth of an hour. The evaluation of the record should be made as follows:

- (a) In the case of a clear burn with round ends, the length should be reduced at each end by an amount equal to half the radius of curvature of the end of the burn; this will normally correspond to a reduction of the overall length of each burn by 0.1 h;
- (b) In the case of circular burns, the length measured should be equal to half the diameter of the burn. If more than one circular burn occurs on the daily record, it is sufficient to consider two or three burns as equivalent to 0.1 h of sunshine; four, five, six burns as equivalent to 0.2 h of sunshine; and so on in steps of 0.1 h;
- (c) Where the mark is only a narrow line, the whole length of this mark should be measured, even when the card is only slightly discoloured;
- (d) Where a clear burn is temporarily reduced in width by at least a third, an amount of 0.1 h should be subtracted from the total length for each such reduction in width, but the maximum subtracted should not exceed one half of the total length of the burn.

In order to assess the random and systematic errors made while evaluating the records and to ensure the objectivity of the results of the comparison, it is recommended that the evaluations corresponding to each one of the instruments compared be made successively and independently by two or more persons trained in this type of work.

8.2.3.3 Special versions

Since the standard Campbell-Stokes sunshine recorder does not record all the sunshine received during the summer months at stations with lati-

tudes higher than about 65°, some countries use modified versions.

One possibility is to use two Campbell-Stokes recorders operated back to back, one of them being installed in the standard manner, while the other should be installed facing north.

In many climates, it may be necessary to heat the device to prevent the deposition of frost and dew. Comparisons in climates like that of northern Europe between heated and normally operated instruments have shown that the amount of sunshine not measured by a normal version, but recorded by a heat device, is about 1 per cent of the monthly mean in summer and about 5 to 10 per cent of the monthly mean in winter.

8.2.3.4 Sources of error

The errors of this recorder are mainly generated by the dependence on the temperature and humidity of the burn card as well as by the overburning effect, especially in the case of scattered clouds (Ikeda, Aoshima and Miyake, 1986).

The morning values are frequently disturbed by dew or frost at middle and high latitudes.

8.2.4 Contrast-evaluating devices

The Foster sunshine switch is an optical device that was introduced operationally in the network of the United States in 1953 (Foster and Foskett, 1953). It consists of a pair of selenium photocells, one of which is shielded from direct sunshine by a shade ring. The cells are corrected so that in the absence of the direct solar beam no signal is produced. The switch is activated when the direct solar irradiance exceeds about 85 W m⁻² (Hameed and Pittalwala, 1989). The position of the shade ring requires adjustments only four times a year to allow for seasonal changes in the sun's apparent path across the sky.

8.2.5 Contrast-evaluating and scanning devices

8.2.5.1 General

A number of different opto-electronic sensors, namely contrast-evaluating and scanning devices (see, for example, WMO, 1984*b*), were compared during the WMO Automatic Sunshine Duration Measurement Comparison at the Regional Radiation Centre of Regional Association VI in Hamburg (Germany) from 1988 to 1989. The report of this

comparison contains detailed descriptions of all the instruments and sensors that participated in this event.

8.2.5.2 Sources of error

The distribution of cloudiness over the sky or solar radiation reflected by the surroundings can influence the results because of the different procedures to evaluate the contrast and the relatively large field-of-view angles of the cells in the arrays used. Silicon photovoltaic cells without filters typically have the maximum responsivity in the near-infrared, and the results, therefore, depend on the spectrum of the direct solar radiation.

Since the relatively small, slit-shaped, rectangular field-of-view angles of this device differ considerably from the circular-symmetrical one of the reference pyrheliometer, the cloud distribution around the sun can cause deviations from the reference values.

Because of the small field of view, an imperfect glass dome may be a specific source of uncertainty. The spectral responsivity of the sensor should also be considered in addition to solar elevation error. At present, only one of the commercial recorders using a pyroelectric detector is thought to be free of spectral effects.

8.3 EXPOSURE OF SUNSHINE DETECTORS

The three essential aspects for the correct exposure of sunshine detectors are as follows:

- (a) The detectors should be firmly fixed to a rigid support. This is not required for the SONI (WMO, 1984*b*) sensors that are designed also for use on buoys;
- (b) The detector should provide an uninterrupted view of the sun at all times of the year throughout the whole period when the sun is more than 3° above the horizon. This recommendation can be modified in the following cases:
 - (i) Small antennas or other obstructions of small angular width ($\leq 2^\circ$) are acceptable if no alternative site is available. In this case, the position, elevation and angular width of obstructions should be well documented and the potential loss of sunshine hours during particular hours and days should be estimated by the astronomical calculation of the apparent solar path;
 - (ii) In mountainous regions (valleys, for instance), natural obstructions are acceptable

as a factor of the local climate and should be well documented, as mentioned above;

- (c) The site should be free of surrounding surfaces that could reflect a significant amount of direct solar radiation to the detector. Reflected radiation can influence mainly the results of the contrast-measuring devices. To overcome this interference, white paint should be avoided and nearby surfaces should either be kept free of snow or screened.

The adjustment of the detector axis is mentioned above. For some detectors, the manufacturers recommend tilting the axis, depending on the season.

8.4 GENERAL SOURCES OF ERROR

The uncertainty of sunshine duration recorded using different types of instrument and methods was demonstrated as deviations from reference values in WMO for the weather conditions of Hamburg (Germany) in 1988–1989.

The reference values are also somewhat uncertain because of the uncertainty of the calibration factor of the pyrheliometer used and the dimensions of its field-of-view angle (dependency on the aureole). For single values, the time constant should also be considered.

General sources of uncertainty are as follows:

- (a) The calibration of the recorder (adjustment of the irradiance threshold equivalent (see section 8.5));
- (b) The typical variation of the recorder response due to meteorological conditions (for example, temperature, cloudiness, dust) and the position of the sun (for example, errors of direction, solar spectrum);
- (c) The poor adjustment and instability of important parts of the instrument;
- (d) The simplified or erroneous evaluation of the values measured;
- (e) Erroneous time-counting procedures;
- (f) Dirt and moisture on optical and sensing surfaces;
- (g) Poor quality of maintenance.

8.5 CALIBRATION

The following general remarks should be made before the various calibration methods are described:

- (a) No standardized method to calibrate *SD* detectors is available;
- (b) For outdoor calibrations, the pyrheliometric method has to be used to obtain reference data;
- (c) Because of the differences between the design of the *SD* detectors and the reference instrument, as well as with regard to the natural variability of the measuring conditions, calibration results must be determined by long-term comparisons (some months);
- (d) Generally the calibration of *SD* detectors requires a specific procedure to adjust their threshold value (electronically for opto-electric devices, by software for pyranometric systems);
- (e) For opto-electric devices with an analogue output, the duration of the calibration period should be relatively short;
- (f) The indoor method (using a lamp) is recommended primarily for regular testing of the stability of field instruments.

8.5.1 Outdoor methods

8.5.1.1 Comparison of sunshine duration data

Reference values SD_{ref} have to be measured simultaneously with the sunshine duration values SD_{cal} of the detector to be calibrated. The reference instrument used should be a pyrheliometer on a solar tracker combined with an irradiance threshold discriminator (see section 8.1.4). Alternatively, a regularly recalibrated sunshine recorder of selected precision may be used. Since the accuracy requirement of the sunshine threshold of a detector varies with the meteorological conditions (see section 8.1.3), the comparison results must be derived statistically from data sets covering long periods.

If the method is applied to the total data set of a period (with typical cloudiness conditions), the first calibration result is the ratio

$$q_{tot} = \frac{\sum_{tot} SD_{ref}}{\sum_{tot} SD_{cal}}$$

For $q > 1$ or $q < 1$, the threshold equivalent voltage has to be adjusted to lower and higher values, respectively. Since the amount of the required adjustment is not strongly correlated to q_{tot} , further comparison periods are necessary to validate iteratively the approach to the ideal threshold by approximation of $q_{tot} = 1$. The duration of a total calibration period may be three to

six months at European mid-latitudes. Therefore, the facilities to calibrate network detectors should permit the calibration of several detectors simultaneously. (The use of q_{tot} as a correction factor for the ΣSD values gives reliable results only if the periods to be evaluated have the same cloud formation as during the calibration period. Therefore, this method is not recommended.)

If the method is applied to data sets which are selected according to specific measurement conditions (for example, cloudiness, solar elevation angle, relative sunshine duration, daytime), it may be possible, for instance, to find factors $q_{sel} = \frac{\sum_{sel} SD_{ref}}{\sum_{sel} SD_{cal}}$ statistically for different types of cloudiness. The factors could also be used to correct data sets for which the cloudiness is clearly specified.

On the other hand, an adjustment of the threshold equivalent voltage is recommended, especially if q_{sel} values for worse cloudiness conditions (such as cirrus and altostratus) are considered. An iterative procedure to validate the adjustment is also necessary; depending on the weather, some weeks or months of comparison may be needed.

8.5.1.2 Comparison of analogue signals

This method is restricted to *SD* detectors which have an analogue output that responds linearly to the received direct solar irradiance, at least in the range $< 500 \text{ W m}^{-2}$. The comparison between the reference irradiance measured by a pyrheliometer and the simultaneously measured analogue output should be performed at cloudless hours or other intervals with slowly variable direct solar irradiance below 500 W m^{-2} .

The linear regression analysis of such a data set generates a best-fit line from which the threshold equivalent voltage at 120 W m^{-2} can be derived. If this calibration result deviates from the certified voltage by more than ± 20 per cent, the threshold of the detector should be adjusted to the new value.

For detectors with a pronounced spectral response, the measured data at low solar elevation angles around 120 W m^{-2} should be eliminated because of the stronger non-linearity caused by the spectrum, unless the threshold voltage at sunrise and sunset is of special interest. The threshold equivalent voltage has to be extrapolated from higher irradiance values.

8.5.1.3 Mean effective irradiance threshold method

The so-called mean effective irradiance threshold (MEIT) method is based on the determination of an hourly mean effective irradiance threshold I_m for the detector to be calibrated.

As a first step of this method, SD values $SD_{ref}(h_k, I(n))$ have to be determined from computer-controlled pyrheliometric measurements for hours h_k and fictitious threshold irradiances $I(n)$ between 60 and 240 $W\ m^{-2}$ (this means that $I(n) = (60 + n)\ W\ m^{-2}$ with $n = 0, 1, 2, \dots, 180$). As a second step, the hourly SD value $SD(h_k)$ of the detector must be compared with the $SD_{ref}(h_k, I(n))$ to find the $n = n_k$ for which $SD(h_k)$ equals $SD_{ref}(h_k, I(n_k))$. $I(n_k)$ represents the MEIT value of the hour h_k : $I_m(h_k) = (60 + n_k)\ W\ m^{-2}$. If n_k is not found directly, it has to be interpolated from adjacent values.

The third step is the adjustment of the threshold equivalent voltage of the recorder if the relative deviation between a MEIT value I_m and the ideal threshold 120 $W\ m^{-2}$ is larger than ± 20 per cent. The mean value should be a monthly average, for instance, because of the large spread of the deviations of hourly MEIT values.

The method is not applicable to hours with dominant fast threshold transitions; the average gradient of an hour should be lower than 5 $W\ m^{-2}\ s^{-1}$. The MEIT values are not representative of the total data set of the calibration period.

8.5.2 Indoor method

Since the simulation of the distribution of direct and diffuse solar fluxes is difficult indoors, only a “spare calibration” can be recommended which is applicable for SD detectors with an adjustable threshold equivalent voltage. The laboratory test equipment consists of a stabilized radiation source (preferably with an approximated solar spectrum) and a stand for a precise local adjustment of the

SD detector as well as of an SD detector (carefully calibrated outdoors) which is used as reference. Reference and test detectors should be of the same model.

At the beginning of the test procedure, the reference detector is positioned precisely in the beam of the lamp so that 120 $W\ m^{-2}$ is indicated by an analogue output or by the usual “sunshine switch”. Afterwards, the reference device is replaced precisely by the test device, whose threshold voltage must be adjusted to activate the switch, or to get a 120 $W\ m^{-2}$ equivalent. The repeatability of the results should be tested by further exchanges of the instruments.

8.6 MAINTENANCE

The required maintenance routine for technicians consists of the following:

- (a) Cleaning: The daily cleaning of the respective entrance windows is necessary for all detectors, especially for scanning devices with small field-of-view angles. Instruments without equipment to prevent dew and frost should be cleared more than once on certain days;
- (b) Checking: The rotation of special (scanning) parts as well as the data-acquisition system should be checked daily;
- (c) Exchange of record: In Campbell-Stokes sunshine recorders, the burn card must be exchanged daily; in other devices, the appropriate data carriers have to be replaced regularly;
- (d) Adjustments: Adjustments are required if a seasonal change of the tilt of the detector is recommended by the manufacturer, or possibly after severe storms.

Special parts of the detectors and of the data-acquisition systems used should undergo maintenance by trained technicians or engineers according to the appropriate instruction manuals.

ANNEX

ALGORITHM TO ESTIMATE SUNSHINE DURATION FROM DIRECT GLOBAL IRRADIANCE MEASUREMENTS
(See Slob and Monna, 1991)

The estimation of the daily *SD* is based on the sum of the fractions *f* of 10 min intervals, namely, $SD = \sum SD_{10}$, where $SD_{10} = f \leq 10$ min. In practice $f = 0$ (no sunshine at all, overcast) or 1 (only sunshine, no clouds), but special attention is given to $0 < f < 1$ (partly sunshine, part clouded). Because the correlation between *SD* and the global irradiation, measured horizontally, depends on the elevation of the sun (*h*), discrimination is made in the first place in terms of $\sin(h)$.

The following variables are applicable:

- h* Elevation angle of the sun in degrees
- G* Global irradiance on a horizontal surface in $W\ m^{-2}$
- I* Direct irradiance on a surface perpendicular to the direction of the sun in $W\ m^{-2}$
- D* Diffuse radiation on a horizontal surface in $W\ m^{-2}$
- T_L "Linke"—turbidity (dimensionless)

For the measured values of *G* it holds that:

- G* represents a 10 min average of the measured global irradiance
- G_{min} represents the minimum value of the global irradiance, measured during the 10 min interval
- G_{max} represents the maximum value of the global irradiance, measured during the 10 min interval ($G_{min} \leq G \leq G_{max}$)

Equations used:

$$G_0 = I_0 \sin(h), I_0 = 1367\ W\ m^{-2} \quad (\text{for extra-terrestrial irradiance})$$

$$I = I_0 \exp(-T_L / (0.9 + 9.4 \sin(h))), I_0 = 1367\ W\ m^{-2}$$

$$c = (G - D) / (I \sin(h)), \text{ where}$$

$$T_L = 4 \text{ and}$$

$$D^L = 1.2\ G_{min} \text{ if } (1.2\ G_{min} < 0.4) \text{ else}$$

$$D = 0.4$$

Sun elevation	$\sin(h) < 0.1, h < 5.7^\circ$	$0.1 \leq \sin(h) \leq 0.3, 5.7^\circ \leq h \leq 17.5^\circ$		$\sin(h) \geq 0.3, h \geq 17.5^\circ$					
Other criteria	No further decision criteria	Is $G/G_0 \leq \{0.2 + \sin(h)/3 + \exp(-T_L / (0.9 + 9.4 \sin(h)))\}$ with $T_L = 6$?		Is $G_{max}/G_0 < 0.4$?					
				If "yes"	If "no"	Is $G_{min}/G_0 > \{0.3 + \exp(-T_L / (0.9 + 9.4 \sin(h)))\}$ with $T_L = 10$?			
		If "yes"	If "no"	If "yes"	If "no"				
					Is $G_{max}/G_0 > \{0.3 + \exp(-T_L / (0.9 + 9.4 \sin(h)))\}$ and $G_{max} - G_{min} < 0.1\ G_0$ with $T_L = 10$?				
			If "yes"	If "no"					
				$c < 0$	$0 \leq c \leq 1$	$c > 1$			
Result	$f = 0$	$f = 0$	$f = 1$	$f = 0$	$f = 1$	$f = 1$	$f = 0$	$f = c$	$f = 1$

REFERENCES AND FURTHER READING

- Angell, J.K., 1990: Variation in United States cloudiness and sunshine duration between 1950 and the drought year of 1988. *Journal of Climate*, 3, pp. 296–308.
- Baumgartner, T., 1979: Die Schwellenintensität des Sonnenscheinautographen Campbell-Stokes an wolkenlosen Tagen. *Arbeitsberichte der Schweizerischen Meteorologischen Zentralanstalt*, No. 84, Zürich.
- Bider, M., 1958: Über die Genauigkeit der Registrierungen des Sonnenscheinautographen Campbell-Stokes. *Archiv für Meteorologie, Geophysik und Bioklimatologie*, Serie B, Volume 9, No. 2, pp. 199–230.
- Coulson, K.L., 1975: *Solar and Terrestrial Radiation. Methods and Measurements*. Academic Press, New York, pp. 215–233.
- Foster, N.B. and L.W. Foskett, 1953: A photoelectric sunshine recorder. *Bulletin of the American Meteorological Society*, 34, pp. 212–215.
- Golchert, H.J., 1981: Mittlere Monatliche Globalstrahlungsverteilungen in der Bundesrepublik Deutschland. *Meteorologische Rundschau*, 34, pp. 143–151.
- Hameed, S. and I. Pittalwala, 1989: An investigation of the instrumental effects on the historical sunshine record of the United States. *Journal of Climate*, 2, pp. 101–104.
- Ikeda, K., T. Aoshima and Y. Miyake, 1986: Development of a new sunshine-duration meter. *Journal of the Meteorological Society of Japan*, Volume 64, Number 6, pp. 987–993.
- Jaenicke, R. and F. Kasten, 1978: Estimation of atmospheric turbidity from the burned traces of the Campbell-Stokes sunshine recorder. *Applied Optics*, 17, pp. 2617–2621.
- Painter, H.E., 1981: The performance of a Campbell-Stokes sunshine recorder compared with a simultaneous record of normal incidence irradiance. *The Meteorological Magazine*, 110, pp. 102–109.
- Slob, W.H. and W.A.A. Monna, 1991: *Bepaling van een directe en diffuse straling en van zonneshijnduur uit 10-minuutwaarden van de globale straling*. KNMI TR136, de Bilt.
- Sonntag, D. and K. Behrens, 1992: Ermittlung der Sonnenscheindauer aus pyranometrisch gemessenen Bestrahlungsstärken der Global- und Himmelsstrahlung. *Berichte des Deutschen Wetterdienstes*, No. 181.
- Stanghellini, C., 1981: A simple method for evaluating sunshine duration by cloudiness observations. *Journal of Applied Meteorology*, 20, pp. 320–323.
- World Meteorological Organization, 1962: *Abridged Final Report of the Third Session of the Commission for Instruments and Methods of Observation*. WMO-No. 116 R.P. 48, Geneva.
- World Meteorological Organization, 1982: *Abridged Final Report of the Eighth Session of the Commission for Instruments and Methods of Observation*. WMO-No. 590, Geneva.
- World Meteorological Organization, 1984a: Diffuse solar radiation measured by the shade ring method improved by a new correction formula (K. Dehne). *Papers Presented at the WMO Technical Conference on Instruments and Cost-effective Meteorological Observations (TECIMO)*. Instruments and Observing Methods Report No. 15, Geneva, pp. 263–267.
- World Meteorological Organization, 1984b: A new sunshine duration sensor (P. Lindner). *Papers Presented at the WMO Technical Conference on Instruments and Cost-effective Meteorological Observations (TECIMO)*. Instruments and Observing Methods Report No. 15, Geneva, pp. 179–183.
- World Meteorological Organization, 1985: Dependence on threshold solar irradiance of measured sunshine duration (K. Dehne). *Papers Presented at the Third WMO Technical Conference on Instruments and Methods of Observation (TECIMO III)*. Instruments and Observing Methods Report No. 22, WMO/TD-No. 50, Geneva, pp. 263–271.
- World Meteorological Organization, 1986: *Radiation and Sunshine Duration Measurements: Comparison of Pyranometers and Electronic Sunshine Duration Recorders of RA VI* (G. Major). WMO Instruments and Observing Methods Report No. 16, WMO/TD-No. 146, Geneva.
- World Meteorological Organization, 1990: *Abridged Final Report of the Tenth Session of the Commission for Instruments and Methods of Observation*. WMO-No. 727, Geneva.
- World Meteorological Organization, 2003: *Manual on the Global Observing System*. WMO-No. 544, Geneva.

CHAPTER 9

MEASUREMENT OF VISIBILITY

9.1 GENERAL

9.1.1 Definitions

Visibility was first defined for meteorological purposes as a quantity to be estimated by a human observer, and observations made in that way are widely used. However, the estimation of visibility is affected by many subjective and physical factors. The essential meteorological quantity, which is the transparency of the atmosphere, can be measured objectively and is represented by the meteorological optical range (MOR).

The *meteorological optical range* is the length of path in the atmosphere required to reduce the luminous flux in a collimated beam from an incandescent lamp, at a colour temperature of 2 700 K, to 5 per cent of its original value, the luminous flux being evaluated by means of the photometric luminosity function of the International Commission on Illumination.

*Visibility, meteorological visibility (by day) and meteorological visibility at night*¹ are defined as the greatest distance at which a black object of suitable dimensions (located on the ground) can be seen and recognized when observed against the horizon sky during daylight or could be seen and recognized during the night if the general illumination were raised to the normal daylight level (WMO, 1992a; 2003).

Visual range (meteorological): Distance at which the contrast of a given object with respect to its background is just equal to the contrast threshold of an observer (WMO, 1992a).

Airlight is light from the sun and the sky which is scattered into the eyes of an observer by atmospheric suspensoids (and, to a slight extent, by

air molecules) lying in the observer's cone of vision. That is, airlight reaches the eye in the same manner as diffuse sky radiation reaches the Earth's surface. Airlight is the fundamental factor limiting the daytime horizontal visibility for black objects, because its contributions, integrated along the cone of vision from eye to object, raise the apparent luminance of a sufficiently remote black object to a level which is indistinguishable from that of the background sky. Contrary to subjective estimates, most of the airlight entering observers' eyes originates in portions of their cone of vision lying rather close to them.

The following four photometric qualities are defined in detail in various standards, such as by the International Electrotechnical Commission (IEC, 1987):

- (a) *Luminous flux* (symbol: F (or Φ); unit: lumen) is a quantity derived from radiant flux by evaluating the radiation according to its action upon the International Commission on Illumination standard photometric observer;
- (b) *Luminous intensity* (symbol: I ; unit: candela or lm sr^{-1}) is luminous flux per unit solid angle;
- (c) *Luminance* (symbol: L ; unit: cd m^{-2}) is luminous intensity per unit area;
- (d) *Illuminance* (symbol: E , unit: lux or lm m^{-2}) is luminous flux per unit area.

The *extinction coefficient* (symbol σ) is the proportion of luminous flux lost by a collimated beam, emitted by an incandescent source at a colour temperature of 2 700 K, while travelling the length of a unit distance in the atmosphere. The coefficient is a measure of the attenuation due to both absorption and scattering.

The *luminance contrast* (symbol C) is the ratio of the difference between the luminance of an object and its background and the luminance of the background.

The *contrast threshold* (symbol ε) is the minimum value of the luminance contrast that the human eye can detect, namely, the value which allows an object to be distinguished from its background. The contrast threshold varies with the individual.

¹ To avoid confusion, visibility at night should not be defined in general as "the greatest distance at which lights of specified moderate intensity can be seen and identified" (see the *Abridged Final Report of the Eleventh Session of the Commission for Instruments and Methods of Observation* (WMO-No. 807)). If visibility should be reported based on the assessment of light sources, it is recommended that a visual range should be defined by specifying precisely the appropriate light intensity and its application, like runway visual range. Nevertheless, at its eleventh session CIMO agreed that further investigations were necessary in order to resolve the practical difficulties of the application of this definition.

The *illuminance threshold* (symbol E_p) is the smallest illuminance, required by the eye, for the detection of point sources of light against a background of specified luminance. The value of E_p , therefore, varies according to lighting conditions.

The *transmission factor* (symbol T) is defined, for a collimated beam from an incandescent source at a colour temperature of 2 700 K, as the fraction of luminous flux which remains in the beam after traversing an optical path of a given length in the atmosphere. The transmission factor is also called the transmission coefficient. The terms transmittance or transmissive power of the atmosphere are also used when the path is defined, that is, of a specific length (for example, in the case of a transmissometer). In this case, T is often multiplied by 100 and expressed in per cent.

9.1.2 Units and scales

The meteorological visibility or MOR is expressed in metres or kilometres. The measurement range varies according to the application. While for synoptic meteorological requirements, the scale of MOR readings extends from below 100 m to more than 70 km, the measurement range may be more restricted for other applications. This is the case for civil aviation, where the upper limit may be 10 km. This range may be further reduced when applied to the measurement of runway visual range representing landing and take-off conditions in reduced visibility. Runway visual range is required only between 50 and 1 500 m (see Part II, Chapter 2). For other applications, such as road or sea traffic, different limits may be applied according to both the requirements and the locations where the measurements are taken.

The errors of visibility measurements increase in proportion to the visibility, and measurement scales take this into account. This fact is reflected in the code used for synoptic reports by the use of three linear segments with decreasing resolution, namely, 100 to 5 000 m in steps of 100 m, 6 to 30 km in steps of 1 km, and 35 to 70 km in steps of 5 km. This scale allows visibility to be reported with a better resolution than the accuracy of the measurement, except when visibility is less than about 1 000 m.

9.1.3 Meteorological requirements

The concept of visibility is used extensively in meteorology in two distinct ways. First, it is one of the elements identifying air-mass characteristics, especially for the needs of synoptic meteorology and

climatology. Here, visibility must be representative of the optical state of the atmosphere. Secondly, it is an operational variable which corresponds to specific criteria or special applications. For this purpose, it is expressed directly in terms of the distance at which specific markers or lights can be seen.

One of the most important special applications is found in meteorological services to aviation (see Part II, Chapter 2).

The measure of visibility used in meteorology should be free from the influence of extra-meteorological conditions; it must be simply related to intuitive concepts of visibility and to the distance at which common objects can be seen under normal conditions. MOR has been defined to meet these requirements, as it is convenient for the use of instrumental methods by day and night, and as the relations between MOR and other measures of visibility are well understood. MOR has been formally adopted by WMO as the measure of visibility for both general and aeronautical uses (WMO, 1990a). It is also recognized by the International Electrotechnical Commission (IEC, 1987) for application in atmospheric optics and visual signalling.

MOR is related to the intuitive concept of visibility through the contrast threshold. In 1924, Koschmieder, followed by Helmholtz, proposed a value of 0.02 for ϵ . Other values have been proposed by other authors. They vary from 0.007 7 to 0.06, or even 0.2. The smaller value yields a larger estimate of the visibility for given atmospheric conditions. For aeronautical requirements, it is accepted that ϵ is higher than 0.02, and it is taken as 0.05 since, for a pilot, the contrast of an object (runway markings) with respect to the surrounding terrain is much lower than that of an object against the horizon. It is assumed that, when an observer can just see and recognize a black object against the horizon, the apparent contrast of the object is 0.05, and, as explained below, this leads to the choice of 0.05 as the transmission factor adopted in the definition of MOR.

Accuracy requirements are discussed in Part I, Chapter 1.

9.1.4 Measurement methods

Visibility is a complex psycho-physical phenomenon, governed mainly by the atmospheric extinction coefficient associated with solid and liquid particles held in suspension in the atmosphere; the extinction is caused primarily by

scattering rather than by absorption of the light. Its estimation is subject to variations in individual perception and interpretative ability, as well as the light source characteristics and the transmission factor. Thus, any visual estimate of visibility is subjective.

When visibility is estimated by a human observer it depends not only on the photometric and dimensional characteristics of the object which is, or should be, perceived, but also on the observer's contrast threshold. At night, it depends on the intensity of the light sources, the background illuminance and, if estimated by an observer, the adaptation of the observer's eyes to darkness and the observer's illuminance threshold. The estimation of visibility at night is particularly problematic. The first definition of visibility at night in section 9.1.1 is given in terms of equivalent daytime visibility in order to ensure that no artificial changes occur in estimating the visibility at dawn and twilight. The second definition has practical applications especially for aeronautical requirements, but it is not the same as the first and usually gives different results. Both are evidently imprecise.

Instrumental methods measure the extinction coefficient from which the MOR may be calculated. The visibility may then be calculated from knowledge of the contrast and illuminance thresholds, or by assigning agreed values to them. It has been pointed out by Sheppard (1983) that:

“strict adherence to the definition (of MOR) would require mounting a transmitter and receiver of appropriate spectral characteristics on two platforms which could be separated, for example along a rail-road, until the transmittance was 5 per cent. Any other approach gives only an estimate of MOR.”

However, fixed instruments are used on the assumption that the extinction coefficient is independent of distance. Some instruments measure attenuation directly and others measure the scattering of light to derive the extinction coefficient. These are described in section 9.3. The brief analysis of the physics of visibility in this chapter may be useful for understanding the relations between the various measures of the extinction coefficient, and for considering the instruments used to measure it.

Visual perception — photopic and scotopic vision

The conditions of visual perception are based on the measurement of the photopic efficiency of the human eye with respect to monochromatic

radiation in the visible light spectrum. The terms *photopic vision* and *scotopic vision* refer to daytime and night-time conditions, respectively.

The adjective *photopic* refers to the state of accommodation of the eye for daytime conditions of ambient luminance. More precisely, the photopic state is defined as the visual response of an observer with normal sight to the stimulus of light incident on the retinal fovea (the most sensitive central part of the retina). The fovea permits fine details and colours to be distinguished under such conditions of adaptation.

In the case of photopic vision (vision by means of the fovea), the relative luminous efficiency of the eye varies with the wavelength of the incident light. The luminous efficiency of the eye in photopic vision is at a maximum for a wavelength of 555 nm. The response curve for the relative efficiency of the eye at the various wavelengths of the visible spectrum may be established by taking the efficiency at a wavelength of 555 nm as a reference value. The curve in Figure 9.1, adopted by the International Commission on Illumination for an average normal observer, is therefore obtained.

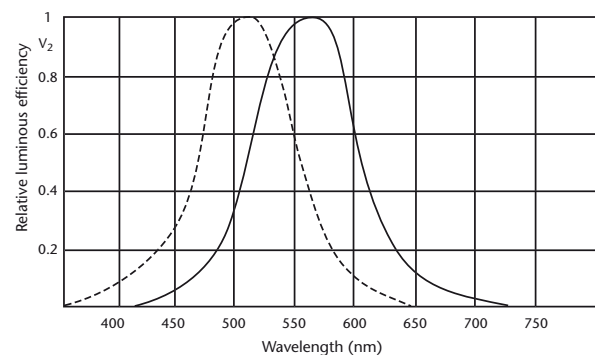

Figure 9.1. Relative luminous efficiency of the human eye for monochromatic radiation. The continuous line indicates daytime vision, while the broken line indicates night-time vision.

Night-time vision is said to be scotopic (vision involving the rods of the retina instead of the fovea). The rods, the peripheral part of the retina, have no sensitivity to colour or fine details, but are particularly sensitive to low light intensities. In scotopic vision, maximum luminous efficiency corresponds to a wavelength of 507 nm.

Scotopic vision requires a long period of accommodation, up to 30 min, whereas photopic vision requires only 2 min.

Basic equations

The basic equation for visibility measurements is the Bouguer-Lambert law:

$$F = F_0 e^{-\sigma x} \tag{9.1}$$

where F is the luminous flux received after a length of path x in the atmosphere and F_0 is the flux for $x = 0$. Differentiating, we obtain:

$$\sigma = \frac{-dF}{F} \cdot \frac{1}{dx} \tag{9.2}$$

Note that this law is valid only for monochromatic light, but may be applied to a spectral flux to a good approximation. The transmission factor is:

$$T = F/F_0 \tag{9.3}$$

Mathematical relationships between MOR and the different variables representing the optical state of the atmosphere may be deduced from the Bouguer-Lambert law.

From equations 9.1 and 9.3 we may write:

$$T = F/F_0 = e^{-\sigma x} \tag{9.4}$$

If this law is applied to the MOR definition $T = 0.05$, then $x = P$ and the following may be written:

$$T = 0.05 = e^{-\sigma P} \tag{9.5}$$

Hence, the mathematical relation of MOR to the extinction coefficient is:

$$P = (1/\sigma) \cdot \ln (1/0.05) \approx 3/\sigma \tag{9.6}$$

where \ln is the log to base e or the natural logarithm. When combining equation 9.4, after being deduced from the Bouguer-Lambert law, and equation 9.6, the following equation is obtained:

$$P = x \cdot \ln (0.05)/\ln (T) \tag{9.7}$$

This equation is used as a basis for measuring MOR with transmissometers where x is, in this case, equal to the transmissometer baseline a in equation 9.14.

Meteorological visibility in daylight

The contrast of luminance is:

$$C = \frac{L_b - L_h}{L_h} \tag{9.8}$$

where L_h is the luminance of the horizon, and L_b is the luminance of the object.

The luminance of the horizon arises from the airlight scattered from the atmosphere along the observer's line of sight.

It should be noted that, if the object is darker than the horizon, C is negative, and that, if the object is black ($L_b = 0$), $C = -1$.

In 1924, Koschmieder established a relationship, which later became known as Koschmieder's law, between the apparent contrast (C_x) of an object, seen against the horizon sky by a distant observer, and its inherent contrast (C_0), namely, the contrast that the object would have against the horizon when seen from very short range. Koschmieder's relationship can be written as:

$$C_x = C_0 e^{-\sigma x} \tag{9.9}$$

This relationship is valid provided that the scatter coefficient is independent of the azimuth angle and that there is uniform illumination along the whole path between the observer, the object and the horizon.

If a black object is viewed against the horizon ($C_0 = -1$) and the apparent contrast is -0.05 , equation 9.9 reduces to:

$$0.05 = e^{-\sigma x} \tag{9.10}$$

Comparing this result with equation 9.5 shows that when the magnitude of the apparent contrast of a black object, seen against the horizon, is 0.05, that object is at MOR (P).

Meteorological visibility at night

The distance at which a light (a night visibility marker) can be seen at night is not simply related to MOR. It depends not only on MOR and the intensity of the light, but also on the illuminance at the observer's eye from all other light sources.

In 1876, Allard proposed the law of attenuation of light from a point source of known intensity (I) as a function of distance (x) and extinction coefficient (σ). The illuminance (E) of a point light source is given by:

$$E = I \cdot x^{-2} \cdot e^{-\sigma x} \tag{9.11}$$

When the light is just visible, $E = E_t$ and the following may be written:

$$\sigma = (1/x) \cdot \ln \{I/(E_t \cdot x^2)\} \tag{9.12}$$

Noting that $P = (1/\sigma) \cdot \ln (1/0.05)$ in equation 9.6, we may write:

$$P = x \cdot \ln (1/0.05) / \ln (I/(E_t \cdot x^2)) \quad (9.13)$$

The relationship between MOR and the distance at which lights can be seen is described in section 9.2.3, while the application of this equation to visual observations is described in section 9.2.

9.2 VISUAL ESTIMATION OF METEOROLOGICAL OPTICAL RANGE

9.2.1 General

A meteorological observer can make a visual estimation of MOR using natural or man-made objects (groups of trees, rocks, towers, steeples, churches, lights, and so forth).

Each station should prepare a plan of the objects used for observation, showing their distances and bearings from the observer. The plan should include objects suitable for daytime observations and objects suitable for night-time observations. The observer must also give special attention to significant directional variations of MOR.

Observations should be made by observers who have "normal" vision and have received suitable training. The observations should normally be made without any additional optical devices (binoculars, telescope, theodolite, and the like) and, preferably, not through a window, especially when objects or lights are observed at night. The eye of the observer should be at a normal height above the ground (about 1.5 m); observations should, thus, not be made from the upper storeys of control towers or other high buildings. This is particularly important when visibility is poor.

When visibility varies in different directions, the value recorded or reported may depend on the use to be made of the report. In synoptic messages, the lower value should be reported, but in reports for aviation the guidance in WMO (1990a) should be followed.

9.2.2 Estimation of meteorological optical range by day

For daytime observations, the visual estimation of visibility gives a good approximation of the true value of MOR.

Provided that they meet the following requirements, objects at as many different distances as possible should be selected for observation during the day. Only black, or nearly black, objects which stand out on the horizon against the sky should be chosen. Light-coloured objects or objects located close to a terrestrial background should be avoided as far as possible. This is particularly important when the sun is shining on the object. Provided that the albedo of the object does not exceed about 25 per cent, no error larger than 3 per cent will be caused if the sky is overcast, but it may be much larger if the sun is shining. Thus, a white house would be unsuitable, but a group of dark trees would be satisfactory, except when brightly illuminated by sunlight. If an object against a terrestrial background has to be used, it should stand well in front of the background, namely, at a distance at least half that of the object from the point of observation. A tree at the edge of a wood, for example, would not be suitable for visibility observations.

For observations to be representative, they should be made using objects subtending an angle of no less than 0.5° at the observer's eye. An object subtending an angle less than this becomes invisible at a shorter distance than would large objects in the same circumstances. It may be useful to note that a hole of 7.5 mm in diameter, punched in a card and held at arm's length, subtends this angle approximately; a visibility object viewed through such an aperture should, therefore, completely fill it. At the same time, however, such an object should not subtend an angle of more than 5° .

9.2.3 Estimation of meteorological optical range at night

Methods which may be used to estimate MOR at night from visual observations of the distance of perception of light sources are described below.

Any source of light may be used as a visibility object, provided that the intensity in the direction of observation is well defined and known. However, it is generally desirable to use lights which can be regarded as point sources, and whose intensity is not greater in any one more favoured direction than in another and not confined to a solid angle which is too small. Care must be taken to ensure the mechanical and optical stability of the light source.

A distinction should be made between sources known as point sources, in the vicinity of which there is no other source or area of light, and clusters

of lights, even though separated from each other. In the latter case, such an arrangement may affect the visibility of each source considered separately. For measurements of visibility at night, only the use of suitably distributed point sources is recommended.

It should be noted that observations at night, using illuminated objects, may be affected appreciably by the illumination of the surroundings, by the physiological effects of dazzling, and by other lights, even when these are outside the field of vision and, more especially, if the observation is made through a window. Thus, an accurate and reliable observation can be made only from a dark and suitably chosen location.

Furthermore, the importance of physiological factors cannot be overlooked, since these are an important source of measurement dispersion. It is essential that only qualified observers with normal vision take such measurements. In addition, it is necessary to allow a period of adaptation (usually from 5 to 15 min) during which the eyes become accustomed to the darkness.

For practical purposes, the relationship between the distance of perception of a light source at night and the value of MOR can be expressed in two different ways, as follows:

- (a) For each value of MOR, by giving the value of luminous intensity of the light, so that there is a direct correspondence between the distance where it is barely visible and the value of MOR;
- (b) For a light of a given luminous intensity, by giving the correspondence between the distance of perception of the light and the value of MOR.

The second relationship is easier and also more practical to use since it would not be an easy matter to install light sources of differing intensities at different distances. The method involves using light sources which either exist or are installed around the station and replacing I , x and E_t in equation 9.13 by the corresponding values of the available light sources. In this way, the Meteorological Services can draw up tables giving values of MOR as a function of background luminance and the light sources of known intensity. The values to be assigned to the illuminance threshold E_t vary considerably in accordance with the ambient luminance. The following values, considered as average observer values, should be used:

- (a) $10^{-6.0}$ lux at twilight and at dawn, or when there is appreciable light from artificial

sources;

- (b) $10^{-6.7}$ lux in moonlight, or when it is not yet quite dark;
- (c) $10^{-7.5}$ lux in complete darkness, or with no light other than starlight.

Tables 9.1 and 9.2 give the relations between MOR and the distance of perception of light sources for each of the above methods for different observation conditions. They have been compiled to guide Meteorological Services in the selection or installation of lights for night visibility observations and in the preparation of instructions for their observers for the computation of MOR values.

Table 9.1. Relation between MOR and intensity of a just-visible point source for three values of E_t

MOR	Luminous intensity (candela) of lamps only just visible at distances given in column P			
	P (m)	Twilight ($E_t = 10^{-6.0}$)	Moonlight ($E_t = 10^{-6.7}$)	Complete darkness ($E_t = 10^{-7.5}$)
100		0.2	0.04	0.006
200		0.8	0.16	0.025
500		5	1	0.16
1 000		20	4	0.63
2 000		80	16	2.5
5 000		500	100	16
10 000		2 000	400	63
20 000		8 000	1 600	253
50 000		50 000	10 000	1 580

Table 9.2. Relation between MOR and the distance at which a 100 cd point source is just visible for three values of E_t

MOR	Distance of perception (metres) of a lamp of 100 cd as a function of MOR value			
	P (m)	Twilight ($E_t = 10^{-6.0}$)	Moonlight ($E_t = 10^{-6.7}$)	Complete darkness ($E_t = 10^{-7.5}$)
100		250	290	345
200		420	500	605
500		830	1 030	1 270
1 000		1 340	1 720	2 170
2 000		2 090	2 780	3 650
5 000		3 500	5 000	6 970
10 000		4 850	7 400	10 900
20 000		6 260	10 300	16 400
50 000		7 900	14 500	25 900

An ordinary 100 W incandescent bulb provides a light source of approximately 100 cd.

In view of the substantial differences caused by relatively small variations in the values of the visual illuminance threshold and by different conditions

of general illumination, it is clear that Table 9.2 is not intended to provide an absolute criterion of visibility, but indicates the need for calibrating the lights used for night-time estimation of MOR so as to ensure as far as possible that night observations made in different locations and by different Services are comparable.

9.2.4 **Estimation of meteorological optical range in the absence of distant objects**

At certain locations (open plains, ships, and so forth), or when the horizon is restricted (valley or cirque), or in the absence of suitable visibility objects, it is impossible to make direct estimations, except for relatively low visibilities. In such cases, unless instrumental methods are available, values of MOR higher than those for which visibility points are available have to be estimated from the general transparency of the atmosphere. This can be done by noting the degree of clarity with which the most distant visibility objects stand out. Distinct outlines and features, with little or no fuzziness of colours, are an indication that MOR is greater than the distance between the visibility object and the observer. On the other hand, indistinct visibility objects are an indication of the presence of haze or of other phenomena reducing MOR.

9.2.5 **Accuracy of visual observations**

General

Observations of objects should be made by observers who have been suitably trained and have what is usually referred to as normal vision. This human factor has considerable significance in the estimation of visibility under given atmospheric conditions, since the perception and visual interpretation capacity vary from one individual to another.

Accuracy of daytime visual estimates of meteorological optical range

Observations show that estimates of MOR based on instrumental measurements are in reasonable agreement with daytime estimates of visibility. Visibility and MOR should be equal if the observer's contrast threshold is 0.05 (using the criterion of recognition) and the extinction coefficient is the same in the vicinity of both the instrument and the observer.

Middleton (1952) found, from 1000 measurements, that the mean contrast ratio threshold for a group

of 10 young airmen trained as meteorological observers was 0.033 with a range, for individual observations, from less than 0.01 to more than 0.2. Sheppard (1983) has pointed out that when the Middleton data are plotted on a logarithmic scale they show good agreement with a Gaussian distribution. If the Middleton data represent normal observing conditions, we must expect daylight estimates of visibility to average about 14 per cent higher than MOR with a standard deviation of 20 per cent of MOR. These calculations are in excellent agreement with the results from the First WMO Intercomparison of Visibility Measurements (WMO, 1990*b*), where it was found that, during daylight, the observers' estimates of visibility were about 15 per cent higher than instrumental measurements of MOR. The interquartile range of differences between the observer and the instruments was about 30 per cent of the measured MOR. This corresponds to a standard deviation of about 22 per cent, if the distribution is Gaussian.

Accuracy of night-time visual estimates of meteorological optical range

From table 9.2 in section 9.2.3, it is easy to see how misleading the values of MOR can be if based simply on the distance at which an ordinary light is visible, without making due allowance for the intensity of the light and the viewing conditions. This emphasizes the importance of giving precise, explicit instructions to observers and of providing training for visibility observations.

Note that, in practice, the use of the methods and tables described above for preparing plans of luminous objects is not always easy. The light sources used as objects are not necessarily well located or of stable, known intensity, and are not always point sources. With respect to this last point, the lights may be wide- or narrow-beam, grouped, or even of different colours to which the eye has different sensitivity. Great caution must be exercised in the use of such lights.

The estimation of the visual range of lights can produce reliable estimates of visibility at night only when lights and their background are carefully chosen; when the viewing conditions of the observer are carefully controlled; and when considerable time can be devoted to the observation to ensure that the observer's eyes are fully accommodated to the viewing conditions. Results from the First WMO Intercomparison of Visibility Measurements (WMO, 1990*b*) show that, during the hours of darkness, the observer's estimates of visibility were about 30 per

cent higher than instrumental measurements of MOR. The interquartile range of differences between the observer and the instruments was only slightly greater than that found during daylight (about 35 to 40 per cent of the measured MOR).

9.3 INSTRUMENTAL MEASUREMENT OF THE METEOROLOGICAL OPTICAL RANGE

9.3.1 General

The adoption of certain assumptions allows the conversion of instrumental measurements into MOR. It is not always advantageous to use an instrument for daytime measurements if a number of suitable visibility objects can be used for direct observations. However, a visibility-measuring instrument is often useful for night observations or when no visibility objects are available, or for automatic observing systems. Instruments for the measurement of MOR may be classified into one of the following two categories:

- (a) Those measuring the extinction coefficient or transmission factor of a horizontal cylinder of air: Attenuation of the light is due to both scattering and absorption by particles in the air along the path of the light beam;
- (b) Those measuring the scatter coefficient of light from a small volume of air: In natural fog, absorption is often negligible and the scatter coefficient may be considered as being the same as the extinction coefficient.

Both of the above categories include instruments used for visual measurements by an observer and instruments using a light source and an electronic device comprising a photoelectric cell or a photodiode to detect the emitted light beam. The main disadvantage of visual measurements is that substantial errors may occur if observers do not allow sufficient time for their eyes to become accustomed to the conditions (particularly at night).

The main characteristics of these two categories of MOR-measuring instruments are described below.

9.3.2 INSTRUMENTS MEASURING THE EXTINCTION COEFFICIENT

Telephotometric instruments

A number of telephotometers have been designed for daytime measurement of the extinction coefficient by comparing the apparent luminance of a

distant object with that of the sky background (for example, the Lohle telephotometer), but they are not normally used for routine measurements since, as stated above, it is preferable to use direct visual observations. These instruments may, however, be useful for extrapolating MOR beyond the most distant object.

Visual extinction meters

A very simple instrument for use with a distant light at night takes the form of a graduated neutral filter, which reduces the light in a known proportion and can be adjusted until the light is only just visible. The meter reading gives a measure of the transparency of the air between the light and the observer, and, from this, the extinction coefficient can be calculated. The overall accuracy depends mainly on variations in the sensitivity of the eye and on fluctuations in the radiant intensity of the light source. The error increases in proportion to MOR.

The advantage of this instrument is that it enables MOR values over a range from 100 m to 5 km to be measured with reasonable accuracy, using only three well-spaced lights, whereas without it a more elaborate series of lights would be essential if the same degree of accuracy were to be achieved. However, the method of using such an instrument (determining the point at which a light appears or disappears) considerably affects the accuracy and homogeneity of the measurements.

Transmissometers

The use of a transmissometer is the method most commonly used for measuring the mean extinction coefficient in a horizontal cylinder of air between a transmitter, which provides a modulated flux light source of constant mean power, and a receiver incorporating a photodetector (generally a photodiode at the focal point of a parabolic mirror or a lens). The most frequently used light source is a halogen lamp or xenon pulse discharge tube. Modulation of the light source prevents disturbance from sunlight. The transmission factor is determined from the photodetector output and this allows the extinction coefficient and the MOR to be calculated.

Since transmissometer estimates of MOR are based on the loss of light from a collimated beam, which depends on scatter and absorption, they are closely related to the definition of MOR. A good, well-maintained transmissometer

working within its range of highest accuracy provides a very good approximation to the true MOR.

There are two types of transmissometer:

- (a) Those with a transmitter and a receiver in different units and at a known distance from each other, as illustrated in Figure 9.2;

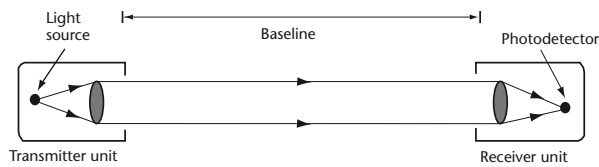

Figure 9.2. Double-ended transmissometer

- (b) Those with a transmitter and a receiver in the same unit, with the emitted light being reflected by a remote mirror or retroreflector (the light beam travelling to the reflector and back), as illustrated in Figure 9.3.

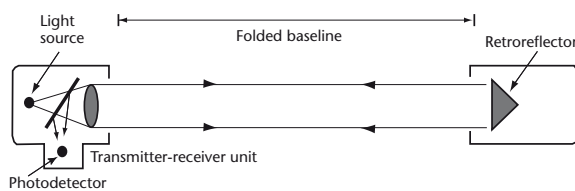

Figure 9.3. Single-ended transmissometer

The distance covered by the light beam between the transmitter and the receiver is commonly referred to as the baseline and may range from a few metres to 150 m (or even 300 m) depending on the range of MOR values to be measured and the applications for which these measurements are to be used.

As seen in the expression for MOR in equation 9.7, the relation:

$$P = a \cdot \ln(0.05) / \ln(T) \quad (9.14)$$

where a is the transmissometer baseline, is the basic formula for transmissometer measurements. Its validity depends on the assumptions that the application of the Koschmieder and Bouguer-Lambert laws is acceptable and that the extinction coefficient along the transmissometer baseline is the same as that in the path between an observer and an object at MOR. The relationship between the transmission factor and MOR is valid for fog droplets, but when visibility is reduced by other

hydrometeors (such as rain, or snow) or lithometeors (such as blowing sand) MOR values must be treated with circumspection.

If the measurements are to remain acceptable over a long period, the luminous flux must remain constant during this same period. When halogen light is used, the problem of lamp filament ageing is less critical and the flux remains more constant. However, some transmissometers use feedback systems (by sensing and measuring a small portion of the emitted flux) giving greater homogeneity of the luminous flux with time or compensation for any change.

As will be seen in the section dealing with the accuracy of MOR measurements, the value adopted for the transmissometer baseline determines the MOR measurement range. It is generally accepted that this range is between about 1 and 25 times the baseline length.

A further refinement of the transmissometer measurement principle is to use two receivers or retroreflectors at different distances to extend both the lower limit (short baseline) and the upper limit (long baseline) of the MOR measurement range. These instruments are referred to as "double baseline" instruments.

In some cases of very short baselines (a few metres), a photodiode has been used as a light source, namely, a monochromatic light close to infrared. However, it is generally recommended that polychromatic light in the visible spectrum be used to obtain a representative extinction coefficient.

Visibility lidars

The lidar (*light detection and ranging*) technique as described for the laser ceilometer in Part I, Chapter 15, may be used to measure visibility when the beam is directed horizontally. The range-resolved profile of the backscattered signal S depends on the output signal S_0 , the distance x , the back scatter coefficient β , and transmission factor T , such that:

$$S(x) \sim S_0 \cdot 1/x^2 \cdot \beta(x) \cdot T^2 \text{ where } T = \int_0^x -\sigma(x) dx \quad (9.15)$$

Under the condition of horizontal homogeneity of the atmosphere, β and σ are constant and the extinction coefficient σ is determined from only two points of the profile:

$$\ln(S(x) \cdot x^2 / S_0) \sim \ln \beta - 2 \sigma x \quad (9.16)$$

In an inhomogeneous atmosphere the range-dependent quantities of $\beta(x)$ and $\sigma(x)$ may be separated with the Klett Algorithm (Klett, 1985).

As MOR approaches 2 000 m, the accuracy of the lidar method becomes poor.

9.3.3 Instruments measuring the scatter coefficient

The attenuation of light in the atmosphere is due to both scattering and absorption. The presence of pollutants in the vicinity of industrial zones, ice crystals (freezing fog) or dust may make the absorption term significant. However, in general, the absorption factor is negligible and the scatter phenomena due to reflection, refraction, or diffraction on water droplets constitute the main factor reducing visibility. The extinction coefficient may then be considered as equal to the scatter coefficient, and an instrument for measuring the latter can, therefore, be used to estimate MOR.

Measurements are most conveniently taken by concentrating a beam of light on a small volume of air and by determining, through photometric means, the proportion of light scattered in a sufficiently large solid angle and in directions which are not critical. Provided that it is completely screened from interference from other sources of light, or that the light source is modulated, an instrument of this type can be used during both the day and night. The scatter coefficient b is a function that may be written in the following form:

$$b = \frac{2\pi}{\Phi_v} \int_0^\pi I(\phi) \sin(\phi) d\phi \quad (9.17)$$

where Φ_v is the flux entering the volume of air V and $I(\phi)$ is the intensity of the light scattered in direction ϕ with respect to the incident beam.

Note that the accurate determination of b requires the measurement and integration of light scattered out of the beam over all angles. Practical instruments measure the scattered light over a limited angle and rely on a high correlation between the limited integral and the full integral.

Three measurement methods are used in these instruments: back scatter, forward scatter, and scatter integrated over a wide angle.

(a) *Back scatter:* In these instruments (Figure 9.4), a light beam is concentrated on a small volume of air in front of the transmitter, the receiver being

located in the same housing and below the light source where it receives the light backscattered by the volume of air sampled. Several researchers have tried to find a relationship between visibility and the coefficient of back scatter, but it is generally accepted that that correlation is not satisfactory.

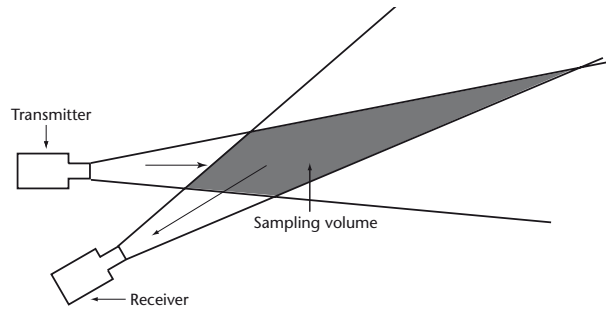

Figure 9.4. Visibility meter measuring back scatter

(b) *Forward scatter:* Several authors have shown that the best angle is between 20 and 50°. The instruments, therefore, comprise a transmitter and a receiver, the angle between the beams being 20 to 50°. Another arrangement involves placing either a single diaphragm half-way between a transmitter and a receiver or two diaphragms each a short distance from either a transmitter or a receiver. Figure 9.5 illustrates the two configurations that have been used.

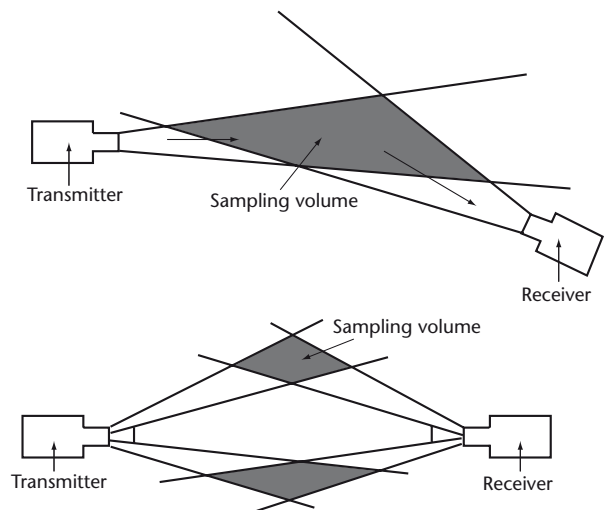

Figure 9.5. Two configurations of visibility meters measuring forward scatter

(c) *Scatter over a wide angle:* Such an instrument, illustrated in Figure 9.6, which is usually known as an integrating nephelometer, is based on the principle of measuring scatter

over as wide an angle as possible, ideally 0 to 180°, but in practice about 0 to 120°. The receiver is positioned perpendicularly to the axis of the light source which provides light over a wide angle. Although, in theory, such an instrument should give a better estimate of the scatter coefficient than an instrument measuring over a small range of scattering angles, in practice it is more difficult to prevent the presence of the instrument from modifying the extinction coefficient in the air sampled. Integrating nephelometers are not widely used for measuring MOR, but this type of instrument is often used for measuring pollutants.

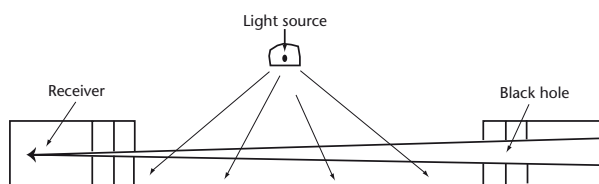

Figure 9.6. Visibility meter measuring scattered light over a wide angle

In all the above instruments, as for most transmissometers, the receivers comprise photodetector cells or photodiodes. The light used is pulsed (for example, high-intensity discharge into xenon).

These types of instruments require only limited space (1 to 2 m in general). They are, therefore, useful when no visibility objects or light sources are available (onboard ships, by roadsides, and so forth). Since the measurement relates only to a very small volume of air, the representativeness of measurements for the general state of the atmosphere at the site may be open to question. However, this representativeness can be improved by averaging a number of samples or measurements. In addition, smoothing of the results is sometimes achieved by eliminating extreme values.

The use of these types of instruments has often been limited to specific applications (for example, highway visibility measurements, or to determine whether fog is present) or when less precise MOR measurements are adequate. These instruments are now being used in increasing numbers in automatic meteorological observation systems because of their ability to measure MOR over a wide range and their relatively low susceptibility to pollution compared with transmissometers.

9.3.4 Instrument exposure and siting

Measuring instruments should be located in positions which ensure that the measurements are representative for the intended purpose. Thus, for general synoptic purposes, the instruments should be installed at locations free from local atmospheric pollution, for example, smoke, industrial pollution, dusty roads.

The volume of air in which the extinction coefficient or scatter coefficient is measured should normally be at the eye level of an observer, about 1.5 m above the ground.

It should be borne in mind that transmissometers and instruments measuring the scatter coefficient should be installed in such a way that the sun is not in the optical field at any time of the day, either by mounting with a north-south optical axis (to $\pm 45^\circ$) horizontally, for latitudes up to 50° , or by using a system of screens or baffles.

For aeronautical purposes, measurements are to be representative of conditions at the airport. These conditions, which relate more specifically to airport operations, are described in Part II, Chapter 2.

The instruments should be installed in accordance with the directions given by the manufacturers. Particular attention should be paid to the correct alignment of transmissometer transmitters and receivers and to the correct adjustment of the light beam. The poles on which the transmitter/receivers are mounted should be mechanically firm (while remaining frangible when installed at airports) to avoid any misalignment due to ground movement during freezing and, particularly, during thawing. In addition, the mountings must not distort under the thermal stresses to which they are exposed.

9.3.5 Calibration and maintenance

In order to obtain satisfactory and reliable observations, instruments for the measurement of MOR should be operated and maintained under the conditions prescribed by the manufacturers, and should be kept continuously in good working order. Regular checks and calibration in accordance with the manufacturer's recommendations should ensure optimum performance.

Calibration in very good visibility (over 10 to 15 km) should be carried out regularly. Atmospheric conditions resulting in erroneous calibration

must be avoided. When, for example, there are strong updraughts, or after heavy rain, considerable variations in the extinction coefficient are encountered in the layer of air close to the ground; if several transmissometers are in use on the site (in the case of airports), dispersion is observed in their measurements. Calibration should not be attempted under such conditions.

Note that in the case of most transmissometers, the optical surfaces must be cleaned regularly, and daily servicing must be planned for certain instruments, particularly at airports. The instruments should be cleaned during and/or after major atmospheric disturbances, since rain or violent showers together with strong wind may cover the optical systems with a large number of water droplets and solid particles resulting in major MOR measurement errors. The same is true for snowfall, which could block the optical systems. Heating systems are often placed at the front of the optical systems to improve instrument performance under such conditions. Air-blowing systems are sometimes used to reduce the above problems and the need for frequent cleaning. However, it must be pointed out that these blowing and heating systems may generate air currents warmer than the surrounding air and may adversely affect the measurement of the extinction coefficient of the air mass. In arid zones, sandstorms or blowing sand may block the optical system and even damage it.

9.3.6 Sources of error in the measurement of meteorological optical range and estimates of accuracy

General

All practical operational instruments for the measurement of MOR sample a relatively small region of the atmosphere compared with that scanned by a human observer. Instruments can provide an accurate measurement of MOR only when the volume of air that they sample is representative of the atmosphere around the point of observation out to a radius equal to MOR. It is easy to imagine a situation, with patchy fog or a local rain or snow storm, in which the instrument reading is misleading. However, experience has shown that such situations are not frequent and that the continuous monitoring of MOR using an instrument will often lead to the detection of changes in MOR before they are recognized by an unaided observer. Nevertheless, instrumental measurements of MOR must be interpreted with

caution.

Another factor that must be taken into account when discussing representativeness of measurements is the homogeneity of the atmosphere itself. At all MOR values, the extinction coefficient of a small volume of the atmosphere normally fluctuates rapidly and irregularly, and individual measurements of MOR from scatter meters and short baseline transmissometers, which have no in-built smoothing or averaging system, show considerable dispersion. It is, therefore, necessary to take many samples and to smooth or average them to obtain a representative value of MOR. The analysis of the results from the First WMO Intercomparison of Visibility Measurements (WMO, 1990*b*) indicates that, for most instruments, no benefit is gained by averaging over more than 1 min, but for the “noisiest” instruments an averaging time of 2 min is preferable.

Accuracy of telephotometers and visual extinction meters

Visual measurements based on the extinction coefficient are difficult to take. The main source of error is the variability and uncertainty of the performance of the human eye. These errors have been described in the sections dealing with the methods of visual estimation of MOR.

Accuracy of transmissometers

The sources of error in transmissometer measurements may be summarized as follows:

- (a) Incorrect alignment of transmitters and receivers;
- (b) Insufficient rigidity and stability of transmitter/receiver mountings (freezing and thawing of the ground, thermal stress);
- (c) Ageing and incorrect centring of lamps;
- (d) Calibrating error (visibility too low or calibration carried out in unstable conditions affecting the extinction coefficient);
- (e) Instability of system electronics;
- (f) Remote transmission of the extinction coefficient as a low-current signal subject to interference from electromagnetic fields (particularly at airports). It is preferable to digitize the signals;
- (g) Disturbance due to rising or setting of the sun, and poor initial orientation of the transmissometers;
- (h) Atmospheric pollution dirtying the optical systems;
- (i) Local atmospheric conditions (for example,

rain showers and strong winds, snow) giving unrepresentative extinction coefficient readings or diverging from the Koschmieder law (snow, ice crystals, rain, and so forth).

The use of a transmissometer that has been properly calibrated and well maintained should give good representative MOR measurements if the extinction coefficient in the optical path of the instrument is representative of the extinction coefficient everywhere within the MOR. However, a transmissometer has only a limited range over which it can provide accurate measurements of MOR. A relative error curve for MOR may be plotted by differentiating the basic transmissometer formula (see equation 9.7). Figure 9.7 shows how the relative error varies with transmission, assuming that the measurement accuracy of the transmission factor T is 1 per cent.

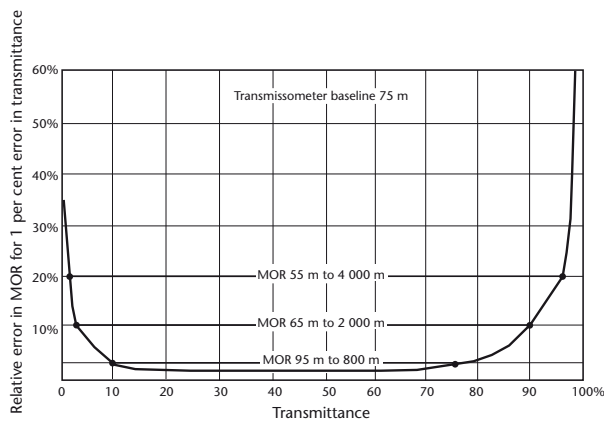

Figure 9.7. Error in measurements of meteorological optical range as a function of a 1 per cent error in transmittance

This 1 per cent value of transmission error, which may be considered as correct for many older instruments, does not include instrument drift, dirt on optical components, or the scatter of measurements due to the phenomenon itself. If the accuracy drops to around 2 to 3 per cent (taking the other factors into account), the relative error values given on the vertical axis of the graph must be multiplied by the same factor of 2 or 3. Note also that the relative MOR measurement error increases exponentially at each end of the curve, thereby setting both upper and lower limits to the MOR measurement range. The example shown by the curve indicates the limit of the measuring range if an error of 5, 10 or 20 per cent is accepted at each end of the range measured, with a baseline of 75 m. It may also be deduced that, for MOR measurements between the limits

of 1.25 and 10.7 times the baseline length, the relative MOR error should be low and of the order of 5 per cent, assuming that the error of T is 1 per cent. The relative error of MOR exceeds 10 per cent when MOR is less than 0.87 times the baseline length or more than 27 times this length. When the measurement range is extended further, the error increases rapidly and becomes unacceptable.

However, results from the First WMO Intercomparison of Visibility Measurements (WMO, 1990b) show that the best transmissometers, when properly calibrated and maintained, can provide measurements of MOR with a standard error of about 10 per cent when MOR is up to 60 times their baseline.

Accuracy of scatter meters

The principal sources of error in measurements of MOR taken with scatter meters are as follows:

- Calibration error (visibility too low or calibration carried out in unstable conditions affecting the extinction coefficient);
- Lack of repeatability in terms of procedure or materials when using opaque scatterers for calibration;
- Instability of system electronics;
- Remote transmission of the scatter coefficient as a low-current or voltage signal subject to interference from electromagnetic fields (particularly at airports). It is preferable to digitize the signals;
- Disturbance due to rising or setting of the sun, and poor initial orientation of the instrument;
- Atmospheric pollution dirtying the optical systems (these instruments are much less sensitive to dirt on their optics than transmissometers, but heavy soiling does have an effect);
- Atmospheric conditions (for example, rain, snow, ice crystals, sand, local pollution) giving a scatter coefficient that differs from the extinction coefficient.

Results from the First WMO Intercomparison of Visibility Measurements (WMO, 1990b) show that scatter meters are generally less accurate than transmissometers at low values of MOR and show greater variability in their readings. There was also evidence that scatter meters, as a class, were more affected by precipitation than transmissometers. However, the best scatter meters showed little or no susceptibility to precipitation and provided estimates of MOR with

standard deviation of about 10 per cent over a range of MOR from about 100 m to 50 km. Almost all the scatter meters in the intercomparison exhibited significant systematic error over part of their measurement range. Scatter meters showed very

low susceptibility to contamination of their optical systems.

An overview of the differences between scatter meters and transmissometers is given by WMO (1992*b*).

REFERENCES AND FURTHER READING

- International Electrotechnical Commission, 1987: *International Electrotechnical Vocabulary*. Chapter 845: Lighting, IEC 50.
- Middleton, W.E.K., 1952: *Vision Through the Atmosphere*. University of Toronto Press, Toronto.
- Sheppard, B.E., 1983: Adaptation to MOR. *Preprints of the Fifth Symposium on Meteorological Observations and Instrumentation* (Toronto, 11–15 April 1983), pp. 226–269.
- Klett, J.D., 1985: Lidar inversion with variable backscatter/extinction ratios. *Applied Optics*, 24, pp. 1638–1643.
- World Meteorological Organization, 1989: *Guide on the Global Observing System*. WMO-No. 488, Geneva.
- World Meteorological Organization, 1990a: *Guide on Meteorological Observation and Information Distribution Systems at Aerodromes*. WMO-No. 731, Geneva.
- World Meteorological Organization, 1990b: *The First WMO Intercomparison of Visibility Measurements: Final Report* (D.J. Griggs, D.W. Jones, M. Ouldridge and W.R. Sparks). Instruments and Observing Methods Report No. 41, WMO/TD-No. 401, Geneva.
- World Meteorological Organization, 1992a: *International Meteorological Vocabulary*. WMO-No. 182, Geneva.
- World Meteorological Organization, 1992b: Visibility measuring instruments: Differences between scatterometers and transmissometers (J.P. van der Meulen). *Papers Presented at the WMO Technical Conference on Instruments and Methods of Observation (TECO-92)* (Vienna, Austria, 11–15 May 1992), Instruments and Observing Methods Report No. 49, WMO/TD-No. 462, Geneva.
- World Meteorological Organization, 2003: *Manual on the Global Observing System*. WMO-No. 544, Geneva.
-

CHAPTER 10

MEASUREMENT OF EVAPORATION

10.1 GENERAL

10.1.1 Definitions

The *International Glossary of Hydrology* (WMO/UNESCO, 1992) and the *International Meteorological Vocabulary* (WMO, 1992) present the following definitions (but note some differences):

(Actual) evaporation: Quantity of water evaporated from an open water surface or from the ground.

Transpiration: Process by which water from vegetation is transferred into the atmosphere in the form of vapour.

(Actual) evapotranspiration (or effective evapotranspiration): Quantity of water vapour evaporated from the soil and plants when the ground is at its natural moisture content.

Potential evaporation (or evaporativity): Quantity of water vapour which could be emitted by a surface of pure water, per unit surface area and unit time, under existing atmospheric conditions.

Potential evapotranspiration: Maximum quantity of water capable of being evaporated in a given climate from a continuous expanse of vegetation covering the whole ground and well supplied with water. It includes evaporation from the soil and transpiration from the vegetation from a specific region in a specific time interval, expressed as depth of water.

If the term *potential evapotranspiration* is used, the types of evaporation and transpiration occurring must be clearly indicated. For more details on these terms refer to WMO (1994).

10.1.2 Units and scales

The rate of evaporation is defined as the amount of water evaporated from a unit surface area per unit of time. It can be expressed as the mass or volume of liquid water evaporated per area in unit of time, usually as the equivalent depth of liquid water evaporated per unit of time from the whole area. The unit of time is normally a day. The amount of evaporation should be read in millimetres (WMO, 2003). Depending on the type of instrument, the usual measuring accuracy is 0.1 to 0.01 mm.

10.1.3 Meteorological requirements

Estimates both of evaporation from free water surfaces and from the ground and of evapotranspiration from vegetation-covered surfaces are of great importance to hydrological modelling and in hydrometeorological and agricultural studies, for example, for the design and operation of reservoirs and irrigation and drainage systems.

Performance requirements are given in Part I, Chapter 1. For daily totals, an extreme outer range is 0 to 100 mm, with a resolution of 0.1 mm. The uncertainty, at the 95 per cent confidence level, should be ± 0.1 mm for amounts of less than 5 mm, and ± 2 per cent for larger amounts. A figure of 1 mm has been proposed as an achievable accuracy. In principle, the usual instruments could meet these accuracy requirements, but difficulties with exposure and practical operation cause much larger errors (WMO, 1976).

Factors affecting the rate of evaporation from any body or surface can be broadly divided into two groups, meteorological factors and surface factors, either of which may be rate-limiting. The meteorological factors may, in turn, be subdivided into energy and aerodynamic variables. Energy is needed to change water from the liquid to the vapour phase; in nature, this is largely supplied by solar and terrestrial radiation. Aerodynamic variables, such as wind speed at the surface and vapour pressure difference between the surface and the lower atmosphere, control the rate of transfer of the evaporated water vapour.

It is useful to distinguish between situations where free water is present on the surface and those where it is not. Factors of importance include the amount and state of the water and also those surface characteristics which affect the transfer process to the air or through the body surface. Resistance to moisture transfer to the atmosphere depends, for example, on surface roughness; in arid and semi-arid areas, the size and shape of the evaporating surface is also extremely important. Transpiration from vegetation, in addition to the meteorological and surface factors already noted, is largely determined by plant characteristics and responses. These include, for example, the number

and size of stomata (openings in the leaves), and whether these are open or closed. Stomatal resistance to moisture transfer shows a diurnal response but is also considerably dependent upon the availability of soil moisture to the rooting system.

The availability of soil moisture for the roots and for the evaporation from bare soil depends on the capillary supply, namely, on the texture and composition of the soil. Evaporation from lakes and reservoirs is influenced by the heat storage of the water body.

Methods for estimating evaporation and evapotranspiration are generally indirect; either by point measurements by an instrument or gauge, or by calculation using other measured meteorological variables (WMO, 1997).

10.1.4 Measurement methods

Direct measurements of evaporation or evapotranspiration from extended natural water or land surfaces are not practicable at present. However, several indirect methods derived from point measurements or other calculations have been developed which provide reasonable results.

The water loss from a standard saturated surface is measured with evaporimeters, which may be classified as atmometers and pan or tank evaporimeters. These instruments do not directly measure either evaporation from natural water surfaces, actual evapotranspiration or potential evapotranspiration. The values obtained cannot, therefore, be used without adjustment to arrive at reliable estimates of lake evaporation or of actual and potential evapotranspiration from natural surfaces.

An evapotranspirometer (lysimeter) is a vessel or container placed below the ground surface and filled with soil, on which vegetation can be cultivated. It is a multi-purpose instrument for the study of several phases of the hydrological cycle under natural conditions. Estimates of evapotranspiration (or evaporation in the case of bare soil) can be made by measuring and balancing all the other water budget components of the container, namely, precipitation, underground water drainage, and change in water storage of the block of soil. Usually, surface runoff is eliminated. Evapotranspirometers can also be used for the estimation of the potential evaporation of the soil or of the potential evapotranspiration of plant-covered soil, if the soil moisture is kept at field capacity.

For reservoirs or lakes, and for plots or small catchments, estimates may be made by water budget, energy budget, aerodynamic and complementarity approaches. The latter techniques are discussed in section 10.5.

It should also be emphasized that different evaporimeters or lysimeters represent physically different measurements. The adjustment factors required for them to represent lake or actual or potential evaporation and evapotranspiration are necessarily different. Such instruments and their exposure should, therefore, always be described very carefully and precisely, in order to understand the measuring conditions as fully as possible.

More details on all methods are found in WMO (1994).

10.2 ATMOMETERS

10.2.1 Instrument types

An atmometer is an instrument that measures the loss of water from a wetted, porous surface. The wetted surfaces are either porous ceramic spheres, cylinders, plates, or exposed filter-paper discs saturated with water. The evaporating element of the livingstone atmometer is a ceramic sphere of about 5 cm in diameter, connected to a water reservoir bottle by a glass or metal tube. The atmospheric pressure on the surface of the water in the reservoir keeps the sphere saturated with water. The Bellani atmometer consists of a ceramic disc fixed in the top of a glazed ceramic funnel, into which water is conducted from a burette that acts as a reservoir and measuring device. The evaporating element of the Piche evaporimeter is a disc of filter paper attached to the underside of an inverted graduated cylindrical tube, closed at one end, which supplies water to the disc. Successive measurements of the volume of water remaining in the graduated tube will give the amount lost by evaporation in any given time.

10.2.2 Measurement taken by atmometers

Although atmometers are frequently considered to give a relative measure of evaporation from plant surfaces, their measurements do not, in fact, bear any simple relation to evaporation from natural surfaces.

Readings from Piche evaporimeters with carefully standardized shaded exposures have been used with some success to derive the aerodynamic term, a multiplication of a wind function and the saturation vapour pressure deficit, required for evaporation estimation by, for example, Penman's combination method after local correlations between them were obtained.

While it may be possible to relate the loss from atmometers to that from a natural surface empirically, a different relation may be expected for each type of surface and for differing climates. Atmometers are likely to remain useful in small-scale surveys. Their great advantages are their small size, low cost and small water requirements. Dense networks of atmometers can be installed over a small area for micrometeorological studies. The use of atmometers is not recommended for water resource surveys if other data are available.

10.2.3 Sources of error in atmometers

One of the major problems in the operation of atmometers is keeping the evaporating surfaces clean. Dirty surfaces will affect significantly the rate of evaporation, in a way comparable to the wet bulb in psychrometry.

Furthermore, the effect of differences in their exposure on evaporation measurements is often remarkable. This applies particularly to the exposure to air movement around the evaporating surface when the instrument is shaded.

10.3 EVAPORATION PANS AND TANKS

Evaporation pans or tanks have been made in a variety of shapes and sizes and there are different modes of exposing them. Among the various types of pans in use, the United States Class A pan, the Russian GGI-3000 pan and the Russian 20 m² tank are described in the following subsections. These instruments are now widely used as standard network evaporimeters and their performance has been studied under different climatic conditions over fairly wide ranges of latitude and elevation. The pan data from these instruments possess stable, albeit complicated and climate-zone-dependent, relationships with the meteorological elements determining evaporation, when standard construction and exposure instructions have been carefully followed.

The adoption of the Russian 20 m² tank as the international reference evaporimeter has been recommended.

10.3.1 United States Class A pan

The United States Class A pan is of cylindrical design, 25.4 cm deep and 120.7 cm in diameter. The bottom of the pan is supported 3 to 5 cm above the ground level on an open-frame wooden platform, which enables air to circulate under the pan, keeps the bottom of the pan above the level of water on the ground during rainy weather, and enables the base of the pan to be inspected without difficulty. The pan itself is constructed of 0.8 mm thick galvanized iron, copper or monel metal, and is normally left unpainted. The pan is filled to 5 cm below the rim (which is known as the reference level).

The water level is measured by means of either a hookgauge or a fixed-point gauge. The hookgauge consists of a movable scale and vernier fitted with a hook, the point of which touches the water surface when the gauge is correctly set. A stilling well, about 10 cm across and about 30 cm deep, with a small hole at the bottom, breaks any ripples that may be present in the tank, and serves as a support for the hookgauge during an observation. The pan is refilled whenever the water level, as indicated by the gauge, drops by more than 2.5 cm from the reference level.

10.3.2 Russian GGI-3000 pan

The Russian GGI-3000 pan is of cylindrical design, with a surface area of 3 000 cm² and a depth of 60 cm. The bottom of the pan is cone-shaped. The pan is set in the soil with its rim 7.5 cm above the ground. In the centre of the tank is a metal index tube upon which a volumetric burette is set when evaporation observations are made. The burette has a valve, which is opened to allow its water level to equalize that in the pan. The valve is then closed and the volume of water in the burette is accurately measured. The height of the water level above the metal index tube is determined from the volume of water in, and the dimensions of, the burette. A needle attached to the metal index tube indicates the height to which the water level in the pan should be adjusted. The water level should be maintained so that it does not fall more than 5 mm or rise more than 10 mm above the needle point. A GGI-3000 raingauge with a collector that has an area of 3 000 cm² is usually installed next to the GGI-3000 pan.

10.3.3 **RUSSIAN 20 M² TANK**

This tank has a surface of 20 m² and a diameter of about 5 m; it is cylindrical with a flat bottom and is 2 m deep. It is made of 4 to 5 mm thick welded iron sheets and is installed in the soil with its rim 7.5 cm above the ground. The inner and exposed outer surfaces of the tank are painted white. The tank is provided with a replenishing vessel and a stilling well with an index pipe upon which the volumetric burette is set when the water level in the tank is measured. Inside the stilling well, near the index pipe, a small rod terminating in a needle point indicates the height to which the water level is to be adjusted. The water level should always be maintained so that it does not fall more than 5 mm below or rise more than 10 mm above the needle point. A graduated glass tube attached laterally to the replenishing tank indicates the amount of water added to the tank and provides a rough check of the burette measurement.

10.3.4 **Measurements taken by evaporation pans and tanks**

The rate of evaporation from a pan or tank evaporimeter is measured by the change in level of its free water surface. This may be done by such devices as described above for Class A pans and GGI-3000 pans.

Several types of automatic evaporation pans are in use. The water level in such a pan is kept constant by releasing water into the pan from a storage tank or by removing water from the pan when precipitation occurs. The amount of water added to, or removed from, the pan is recorded. In some tanks or pans, the level of the water is also recorded continuously by means of a float in the stilling well. The float operates a recorder.

Measurements of pan evaporation are the basis of several techniques for estimating evaporation and evapotranspiration from natural surfaces whose water loss is of interest. Measurements taken by evaporation pans are advantageous because they are, in any case, the result of the impact of the total meteorological variables, and because pan data are available immediately and for any period required. Pans are, therefore, frequently used to obtain information about evaporation on a routine basis within a network.

10.3.5 **Exposure of evaporation pans and tanks**

Three types of exposures are mainly used for pans and tanks as follows:

- (a) Sunken, where the main body of the tank is below ground level, the evaporating surface being at or near the level of the surrounding surface;
- (b) Above ground, where the whole of the pan and the evaporation surface are at some small height above the ground;
- (c) Mounted on moored floating platforms on lakes or other water bodies.

Evaporation stations should be located at sites that are fairly level and free from obstructions such as trees, buildings, shrubs or instrument shelters. Such single obstructions, when small, should not be closer than 5 times their height above the pan; for clustered obstructions, this becomes 10 times. Plots should be sufficiently large to ensure that readings are not influenced by spray drift or by upwind edge effects from a cropped or otherwise different area. Such effects may extend to more than 100 m. The plot should be fenced off to protect the instruments and to prevent animals from interfering with the water level; however, the fence should be constructed in such a way that it does not affect the wind structure over the pan.

The ground cover at the evaporation station should be maintained as similar as possible to the natural cover common to the area. Grass, weeds, and the like should be cut frequently to keep them below the level of the pan rim with regard to sunken pans (7.5 cm). Preferably this same grass height of below 7.5 cm applies also to Class A pans. Under no circumstance should the instrument be placed on a concrete slab or asphalt, or on a layer of crushed rock. This type of evaporimeter should not be shaded from the sun.

10.3.6 **Sources of error in evaporation pans and tanks**

The mode of pan exposure leads both to various advantages and to sources of measurement errors.

Pans installed above the ground are inexpensive and easy to install and maintain. They stay cleaner than sunken tanks as dirt does not, to any large extent, splash or blow into the water from the surroundings. Any leakage that develops after installation is relatively easy to detect and rectify. However, the amount of water evaporated is greater than that from sunken pans, mainly because of the additional radiant energy intercepted by the sides. Adverse side-wall effects can be largely eliminated by using an insulated pan, but this adds to the cost,

would violate standard construction instructions and would change the “stable” relations mentioned in section 10.3.

Sinking the pan into the ground tends to reduce objectionable boundary effects, such as radiation on the side walls and heat exchange between the atmosphere and the pan itself. But the disadvantages are as follows:

- (a) More unwanted material collects in the pan, with the result that it is difficult to clean;
- (b) Leaks cannot easily be detected and rectified;
- (c) The height of the vegetation adjacent to the pan is somewhat more critical. Moreover, appreciable heat exchange takes place between the pan and the soil, and this depends on many factors, including soil type, water content and vegetation cover.

A floating pan approximates more closely evaporation from the lake than from an onshore pan exposed either above or at ground level, even though the heat-storage properties of the floating pan are different from those of the lake. It is, however, influenced by the particular lake in which it floats and it is not necessarily a good indicator of evaporation from the lake. Observational difficulties are considerable and, in particular, splashing frequently renders the data unreliable. Such pans are also costly to install and operate.

In all modes of exposure it is most important that the tank should be made of non-corrosive material and that all joints be made in such a way as to minimize the risk of the tank developing leaks.

Heavy rain and very high winds are likely to cause splash-out from pans and may invalidate the measurements.

The level of the water surface in the evaporimeter is important. If the evaporimeter is too full, as much as 10 per cent (or more) of any rain falling may splash out, leading to an overestimate of evaporation. Too low a water level will lead to a reduced evaporation rate (of about 2.5 per cent for each centimetre below the reference level of 5 cm, in temperate regions) due to excessive shading and sheltering by the rim. If the water depth is allowed to become very shallow, the rate of evaporation rises due to increased heating of the water surface.

It is advisable to restrict the permitted water-level range either by automatic methods, by adjusting the level at each reading, or by taking action to

remove water when the level reaches an upper-limit mark, and to add water when it reaches a lower-limit mark.

10.3.7 **Maintenance of evaporation pans and tanks**

An inspection should be carried out at least once a month, with particular attention being paid to the detection of leaks. The pan should be cleaned out as often as necessary to keep it free from litter, sediment, scum and oil films. It is recommended that a small amount of copper sulphate, or of some other suitable algicide, be added to the water to restrain the growth of algae.

If the water freezes, all the ice should be broken away from the sides of the tank and the measurement of the water level should be taken while the ice is floating. Provided that this is done, the fact that some of the water is frozen will not significantly affect the water level. If the ice is too thick to be broken the measurement should be postponed until it can be broken, the evaporation should then be determined for the extended period.

It is often necessary to protect the pan from birds and other small animals, particularly in arid and tropical regions. This may be achieved by the use of the following:

- (a) Chemical repellents: In all cases where such protection is used, care must be taken not to change significantly the physical characteristics of the water in the evaporimeter;
- (b) A wire-mesh screen supported over the pan: Standard screens of this type are in routine use in a number of areas. They prevent water loss caused by birds and animals, but also reduce the evaporation loss by partly shielding the water from solar radiation and by reducing wind movement over the water surface. In order to obtain an estimate of the error introduced by the effect of the wire-mesh screen on the wind field and the thermal characteristics of the pan, it is advisable to compare readings from the protected pan with those of a standard pan at locations where interference does not occur. Tests with a protective cylinder made of 25 mm hexagonal-mesh steel wire netting supported by an 8 mm steel-bar framework showed a consistent reduction of 10 per cent in the evaporation rate at three different sites over a two-year period.

10.4 **EVAPOTRANSPIROMETERS (LYSIMETERS)**

Several types of lysimeters have been described in the technical literature. Details of the design of some instruments used in various countries are described in WMO (1966; 1994).

In general, a lysimeter consists of the soil-filled inner container and retaining walls or an outer container, as well as special devices for measuring percolation and changes in the soil-moisture content.

There is no universal international standard lysimeter for measuring evapotranspiration. The surface area of lysimeters in use varies from 0.05 to some 100 m² and their depth varies from 0.1 to 5 m. According to their method of operation, lysimeters can be classified into non-weighable and weighable instruments. Each of these devices has its special merits and drawbacks, and the choice of any type of lysimeter depends on the problem to be studied.

Non-weighable (percolation-type) lysimeters can be used only for long-term measurements, unless the soil-moisture content can be measured by some independent and reliable technique. Large-area percolation-type lysimeters are used for water budget and evapotranspiration studies of tall, deep-rooting vegetation cover, such as mature trees. Small, simple types of lysimeters in areas with bare soil or grass and crop cover could provide useful results for practical purposes under humid conditions. This type of lysimeter can easily be installed and maintained at a low cost and is, therefore, suitable for network operations.

Weighable lysimeters, unless of a simple micro-lysimeter-type for soil evaporation, are much more expensive, but their advantage is that they secure reliable and precise estimates of short-term values of evapotranspiration, provided that the necessary design, operation and siting precautions have been taken.

Several weighing techniques using mechanical or hydraulic principles have been developed. The simpler, small lysimeters are usually lifted out of their sockets and transferred to mechanical scales by means of mobile cranes. The container of a lysimeter can be mounted on a permanently installed mechanical scale for continuous recording. The design of the weighing and recording system can be considerably simplified by using load cells with strain gauges of variable electrical resistance. The hydraulic weighing systems use the

principle of fluid displacement resulting from the changing buoyancy of a floating container (so-called floating lysimeter), or the principle of fluid pressure changes in hydraulic load cells.

The large weighable and recording lysimeters are recommended for precision measurements in research centres and for standardization and parameterization of other methods of evapotranspiration measurement and the modelling of evapotranspiration. Small weighable types of lysimeters are quite useful and suitable for network operation. Microlysimeters for soil evaporation are a relatively new phenomenon.

10.4.1 **Measurements taken by lysimeters**

The rate of evapotranspiration may be estimated from the general equation of the water budget for the lysimeter containers. Evapotranspiration equals precipitation/irrigation minus percolation minus change in water storage.

Hence, the observational programme on lysimeter plots includes precipitation/irrigation, percolation and change in soil water storage. It is useful to complete this programme through observations of plant growth and development.

Precipitation – and irrigation, if any – is preferably measured at ground level by standard methods. Percolation is collected in a tank and its volume may be measured at regular intervals or recorded. For precision measurements of the change in water storage, the careful gravimetric techniques described above are used. When weighing, the lysimeter should be sheltered to avoid wind-loading effects.

The application of the volumetric method is quite satisfactory for estimating long-term values of evapotranspiration. With this method, measurements are taken of the amount of precipitation and percolation. It is assumed that a change in water storage tends to zero over the period of observation. Changes in the soil moisture content may be determined by bringing the moisture in the soil up to field capacity at the beginning and at the end of the period.

10.4.2 **Exposure of evapotranspirometers**

Observations of evapotranspiration should be representative of the plant cover and moisture conditions of the general surroundings of the station (WMO, 2003). In order to simulate representative evapotranspiration rates, the soil and

plant cover of the lysimeter should correspond to the soil and vegetation of the surrounding area, and disturbances caused by the existence of the instrument should be minimized. The most important requirements for the exposure of lysimeters are given below.

In order to maintain the same hydromechanical properties of the soil, it is recommended that the lysimeter be placed into the container as an undisturbed block (monolith). In the case of light, rather homogenous soils and a large container, it is sufficient to fill the container layer by layer in the same sequence and with the same density as in the natural profile.

In order to simulate the natural drainage process in the container, restricted drainage at the bottom must be prevented. Depending on the soil texture, it may be necessary to maintain the suction at the bottom artificially by means of a vacuum supply.

Apart from microlysimeters for soil evaporation, a lysimeter should be sufficiently large and deep, and its rim as low as practicable, to make it possible to have a representative, free-growing vegetation cover, without restriction to plant development.

In general, the siting of lysimeters is subject to fetch requirements, such as that of evaporation pans, namely, the plot should be located beyond the zone of influence of buildings, even single trees, meteorological instruments, and so on. In order to minimize the effects of advection, lysimeter plots should be located at a sufficient distance from the upwind edge of the surrounding area, that is, not less than 100 to 150 m. The prevention of advection effects is of special importance for measurements taken at irrigated land surfaces.

10.4.3 Sources of error in lysimeter measurements

Lysimeter measurements are subject to several sources of error caused by the disturbance of the natural conditions by the instrument itself. Some of the major effects are as follows:

- (a) Restricted growth of the rooting system;
- (b) Change of eddy diffusion by discontinuity between the canopy inside the lysimeter and in the surrounding area. Any discontinuity may be caused by the annulus formed by the containing and retaining walls and by discrepancies in the canopy itself;
- (c) Insufficient thermal equivalence of the lysimeter to the surrounding area caused by:

- (i) Thermal isolation from the subsoil;
- (ii) Thermal effects of the air rising or descending between the container and the retaining walls;
- (iii) Alteration of the thermal properties of the soil through alteration of its texture and its moisture conditions;
- (d) Insufficient equivalence of the water budget to that of the surrounding area caused by:
 - (i) Disturbance of soil structure;
 - (ii) Restricted drainage;
 - (iii) Vertical seepage at walls;
 - (iv) Prevention of surface runoff and lateral movement of soil water.

Some suitable arrangements exist to minimize lysimeter measurement errors, for example, regulation of the temperature below the container, reduction of vertical seepage at the walls by flange rings, and so forth. In addition to the careful design of the lysimeter equipment, sufficient representativeness of the plant community and the soil type of the area under study is of great importance. Moreover, the siting of the lysimeter plot must be fully representative of the natural field conditions.

10.4.4 Lysimeters maintenance

Several arrangements are necessary to maintain the representativeness of the plant cover inside the lysimeter. All agricultural and other operations (sowing, fertilizing, mowing, and the like) in the container and surrounding area should be carried out in the same way and at the same time. In order to avoid errors due to rainfall catch, the plants near and inside the container should be kept vertical, and broken leaves and stems should not extend over the surface of the lysimeter.

The maintenance of the technical devices is peculiar to each type of instrument and cannot be described here.

It is advisable to test the evapotranspirometer for leaks at least once a year by covering its surface to prevent evapotranspiration and by observing whether, over a period of days, the volume of drainage equals the amount of water added to its surface.

10.5 ESTIMATION OF EVAPORATION FROM NATURAL SURFACES

Consideration of the factors which affect evaporation, as outlined in section 10.1.3, indicates that the rate of evaporation from a natural surface

will necessarily differ from that of an evaporimeter exposed to the same atmospheric conditions, because the physical characteristics of the two evaporating surfaces are not identical.

In practice, evaporation or evapotranspiration rates from natural surfaces are of interest, for example, reservoir or lake evaporation, crop evaporation, as well as areal amounts from extended land surfaces such as catchment areas.

In particular, accurate areal estimates of evapotranspiration from regions with varied surface characteristics and land-use patterns are very difficult to obtain (WMO, 1966; 1997).

Suitable methods for the estimation of lake or reservoir evaporation are the water budget, energy budget and aerodynamic approaches, the combination method of aerodynamic and energy-balance equations, and the use of a complementarity relationship between actual and potential evaporation. Furthermore, pan evaporation techniques exist which use pan evaporation for the establishment of a lake-to-pan relation. Such relations are specific to each pan type and mode of exposure. They also depend on the climatic conditions (see WMO, 1985; 1994 (Chapter 37)).

The water non-limiting point or areal values of evapotranspiration from vegetation-covered land surfaces may be obtained by determining such potential (or reference crop) evapotranspiration with the same methods as those indicated above for lake applications, but adapted to vegetative conditions. Some methods use additional growth stage-dependent coefficients for each type of vegetation, such as crops, and/or an integrated crop stomatal resistance value for the vegetation as a whole.

The Royal Netherlands Meteorological Institute employs the following procedure established by G.F. Makkink (Hooghart, 1971) for calculating the daily (24 h) reference vegetation evaporation from the averaged daily air temperature and the daily amount of global radiation as follows:

Saturation vapour pressure at air temperature T :

$$e_s(T) = 6.107 \cdot 10^{7.5 \cdot \frac{T}{237.3+T}} \quad \text{hPa}$$

Slope of the curve of saturation water vapour pressure versus temperature at T :

$$\Delta(T) = \frac{7.5 \cdot 237.3}{(237.3 + T)^2} \cdot \ln(10) \cdot e_s(T) \quad \text{hPa/}^\circ\text{C}$$

Psychrometric constant:

$$\Delta(T) = 0.646 + 0.0006T \quad \text{hPa/}^\circ\text{C}$$

Specific heat of evaporation of water:

$$\lambda(T) = 1\,000 \cdot (2\,501 - 2.38 \cdot T) \quad \text{J/kg}$$

Density of water:

$$\rho = 1\,000 \quad \text{kg/m}^3$$

Global radiation (24 h amount):

$$Q \quad \text{J/m}^2$$

Air temperature (24 h average):

$$T \quad ^\circ\text{C}$$

Daily reference vegetation evaporation:

$$E_r = \frac{1\,000 \cdot 0.65 \cdot \delta(T)}{\{\delta(T) + \gamma(T)\} \cdot \rho \cdot \lambda(T)} \cdot Q \quad \text{mm}$$

Note: The constant 1 000 is for conversion from metres to millimetres; the constant 0.65 is a typical empirical constant.

By relating the measured rate of actual evapotranspiration to estimates of the water non-limiting potential evapotranspiration and subsequently relating this normalized value to the soil water content, soil water deficits, or the water potential in the root zone, it is possible to devise coefficients with which the actual evapotranspiration rate can be calculated for a given soil water status.

Point values of actual evapotranspiration from land surfaces can be estimated more directly from observations of the changes in soil water content measured by sampling soil moisture on a regular basis. Evapotranspiration can be measured even more accurately using a weighing lysimeter. Further methods make use of turbulence measurements (for example, eddy-correlation method) and profile measurements (for example, in boundary-layer data methods and, at two heights, in the Bowen-ratio energy-balance method). They are much more expensive and require special instruments and sensors for humidity, wind speed and temperature. Such estimates, valid for the type of soil and canopy under study, may be used as reliable independent reference values in the development of empirical relations for evapotranspiration modelling.

The difficulty in determining basin evapotranspiration arises from the discontinuities in surface characteristics which cause variable evapotranspiration rates within the area under consideration. When considering short-term values, it is necessary to estimate evapotranspiration by using empirical relationships. Over a long period (in order to minimize storage effects) the water-budget approach can be used to estimate basin evapotranspiration (see WMO, 1971). One approach, suitable for estimates from extended areas, refers to the atmospheric water balance and derives areal evapotranspiration from radiosonde data. WMO (1994, Chapter 38) describes the above-mentioned methods, their advantages and their application limits.

The measurement of evaporation from a snow surface is difficult and probably no more accurate than the computation of evaporation from water.

Evaporimeters made of polyethylene or colourless plastic are used in many countries for the measurement of evaporation from snow-pack surfaces; observations are made only when there is no snowfall.

Estimates of evaporation from snow cover can be made from observations of air humidity and wind speed at one or two levels above the snow surface and at the snow-pack surface, using the turbulent diffusion equation. The estimates are most reliable when evaporation values are computed for periods of five days or more.

REFERENCES AND FURTHER READING

- Hooghart, J.C. (ed.), 1971: *Evaporation and Weather*. TNO Committee of Hydrological Research, Technical Meeting 44, Proceedings and Information No. 39, TNO, The Hague.
- World Meteorological Organization, 1966: *Measurement and Estimation of Evaporation and Evapotranspiration*. Technical Note No. 83, WMO-No. 201.TP.105, Geneva.
- World Meteorological Organization, 1971: *Problems of Evaporation Assessment in the Water Balance* (C.E. Hounam). WMO/IHD Report No. 13, WMO-No. 285, Geneva.
- World Meteorological Organization, 1973: *Atmospheric Vapour Flux Computations for Hydrological Purposes* (J.P. Peixoto). WMO/IHD Report No. 20, WMO-No. 357, Geneva.
- World Meteorological Organization, 1976: *The CIMO International Evaporimeter Comparisons*. WMO-No. 449, Geneva.
- World Meteorological Organization, 1977: *Hydrological Application of Atmospheric Vapour-Flux Analyses* (E.M. Rasmusson). Operational Hydrology Report No. 11, WMO-No. 476, Geneva.
- World Meteorological Organization, 1985: *Casebook on Operational Assessment of Areal Evaporation*. Operational Hydrology Report No. 22, WMO-No. 635, Geneva.
- World Meteorological Organization, 1992: *International Meteorological Vocabulary*. Second edition, WMO-No. 182, Geneva.
- World Meteorological Organization/United Nations Educational, Scientific and Cultural Organization, 1992: *International Glossary of Hydrology*. WMO-No. 385, Geneva.
- World Meteorological Organization, 1994: *Guide to Hydrological Practices*. Fifth edition, WMO-No. 168, Geneva.
- World Meteorological Organization, 1997: *Estimation of Areal Evapotranspiration*. Technical Reports in Hydrology and Water Resources No. 56, WMO/TD-No. 785, Geneva.
- World Meteorological Organization, 2003: *Manual on the Global Observing System*. Volume I, WMO-No. 544, Geneva.
-

CHAPTER 11

MEASUREMENT OF SOIL MOISTURE

11.1 GENERAL

Soil moisture is an important component in the atmospheric water cycle, both on a small agricultural scale and in large-scale modelling of land/atmosphere interaction. Vegetation and crops always depend more on the moisture available at root level than on precipitation occurrence. Water budgeting for irrigation planning, as well as the actual scheduling of irrigation action, requires local soil moisture information. Knowledge of the degree of soil wetness helps to forecast the risk of flash floods, or the occurrence of fog.

Nevertheless, soil moisture has been seldom observed routinely at meteorological stations. Documentation of soil wetness was usually restricted to the description of the “state of the ground” by means of WMO Code Tables 0901 and 0975, and its measurement was left to hydrologists, agriculturalists and other actively interested parties. Around 1990 the interest of meteorologists in soil moisture measurement increased. This was partly because, after the pioneering work by Deardorff (1978), numerical atmosphere models at various scales became more adept at handling fluxes of sensible and latent heat in soil surface layers. Moreover, newly developed soil moisture measurement techniques are more feasible for meteorological stations than most of the classic methods.

To satisfy the increasing need for determining soil moisture status, the most commonly used methods and instruments will be discussed, including their advantages and disadvantages. Some less common observation techniques are also mentioned.

11.1.1 Definitions

Soil moisture determinations measure either the soil water content or the soil water potential.

Soil water content

Soil water content is an expression of the mass or volume of water in the soil, while the soil water potential is an expression of the soil water energy status. The relation between content and potential is not universal and depends on the characteristics of the local soil, such as soil density and soil texture.

Soil water content on the basis of mass is expressed in the gravimetric soil moisture content, θ_g , defined by:

$$\theta_g = M_{\text{water}}/M_{\text{soil}} \quad (11.1)$$

where M_{water} is the mass of the water in the soil sample and M_{soil} is the mass of dry soil that is contained in the sample. Values of θ_g in meteorology are usually expressed in per cent.

Because precipitation, evapotranspiration and solute transport variables are commonly expressed in terms of flux, volumetric expressions for water content are often more useful. The volumetric soil moisture content of a soil sample, θ_v , is defined as:

$$\theta_v = V_{\text{water}}/V_{\text{sample}} \quad (11.2)$$

where V_{water} is the volume of water in the soil sample and V_{sample} is the total volume of dry soil + air + water in the sample. Again, the ratio is usually expressed in per cent. The relationship between gravimetric and volumetric moisture contents is:

$$\theta_v = \theta_g (\rho_b/\rho_w) \quad (11.3)$$

where ρ_b is the dry soil bulk density and ρ_w is the soil water density.

The basic technique for measuring soil water content is the gravimetric method, described below in section 11.2. Because this method is based on direct measurements, it is the standard with which all other methods are compared. Unfortunately, gravimetric sampling is destructive, rendering repeat measurements on the same soil sample impossible. Because of the difficulties of accurately measuring dry soil and water volumes, volumetric water contents are not usually determined directly.

Soil water potential

Soil water potential describes the energy status of the soil water and is an important parameter for water transport analysis, water storage estimates and soil-plant-water relationships. A difference in water potential between two soil locations indicates a tendency for water flow, from high to low potential. When the soil is drying, the water potential becomes more negative and the work that must be

done to extract water from the soil increases. This makes water uptake by plants more difficult, so the water potential in the plant drops, resulting in plant stress and, eventually, severe wilting.

Formally, the water potential is a measure of the ability of soil water to perform work, or, in the case of negative potential, the work required to remove the water from the soil. The total water potential ψ_t , the combined effect of all force fields, is given by:

$$\psi_t = \psi_z + \psi_m + \psi_o + \psi_p \quad (11.4)$$

where ψ_z is the gravitational potential, based on elevation above the mean sea level; m is the matric potential, suction due to attraction of water by the soil matrix; o is the osmotic potential, due to energy effects of solutes in water; and p is the pressure potential, the hydrostatic pressure below a water surface.

The potentials which are not related to the composition of water or soil are together called hydraulic potential, ψ_h . In saturated soil, this is expressed as $\psi_h = \psi_z + \psi_p$, while in unsaturated soil, it is expressed as $\psi_h = \psi_z + \psi_m$. When the phrase "water potential" is used in studies, maybe with the notation ψ_w , it is advisable to check the author's definition because this term has been used for $\psi_m + \psi_z$ as well as for $\psi_m + \psi_o$.

The gradients of the separate potentials will not always be significantly effective in inducing flow. For example, ψ_o requires a semi-permeable membrane to induce flow, and ψ_p will exist in saturated or ponded conditions, but most practical applications are in unsaturated soil.

11.1.2 Units

In solving the mass balance or continuity equations for water, it must be remembered that the components of water content parameters are not dimensionless. Gravimetric water content is the weight of soil water contained in a unit weight of soil (kg water/kg dry soil). Likewise, volumetric water content is a volume fraction (m^3 water/ m^3 soil).

The basic unit for expressing water potential is energy (in joules, $\text{kg m}^2 \text{s}^{-2}$) per unit mass, J kg^{-1} . Alternatively, energy per unit volume (J m^{-3}) is equivalent to pressure, expressed in pascals ($\text{Pa} = \text{kg m}^{-1} \text{s}^{-2}$). Units encountered in older literature are bar (= 100 kPa), atmosphere (= 101.32 kPa), or pounds per square inch (= 6.895 kPa). A third

class of units are those of pressure head in (centi)metres of water or mercury, energy per unit weight. The relation of the three potential unit classes is:

$$\psi (\text{J kg}^{-1}) = \gamma \times \psi (\text{Pa}) = [\psi (\text{m})] / g \quad (11.5)$$

where $\gamma = 10^3 \text{ kg m}^{-3}$ (density of water) and $g = 9.81 \text{ m s}^{-2}$ (gravity acceleration). Because the soil water potential has a large range, it is often expressed logarithmically, usually in pressure head of water. A common unit for this is called pF, and is equal to the base⁻¹⁰ logarithm of the absolute value of the head of water expressed in centimetres.

11.1.3 Meteorological requirements

Soil consists of individual particles and aggregates of mineral and organic materials, separated by spaces or pores which are occupied by water and air. The relative amount of pore space decreases with increasing soil grain size (intuitively one would expect the opposite). The movement of liquid water through soil depends upon the size, shape and generally the geometry of the pore spaces.

If a large quantity of water is added to a block of otherwise "dry" soil, some of it will drain away rapidly by the effects of gravity through any relatively large cracks and channels. The remainder will tend to displace some of the air in the spaces between particles, the larger pore spaces first. Broadly speaking, a well-defined "wetting front" will move downwards into the soil, leaving an increasingly thick layer retaining all the moisture it can hold against gravity. That soil layer is then said to be at "field capacity", a state that for most soils occurs about $\psi \approx 10 \text{ kPa}$ ($\text{pF} \approx 2$). This state must not be confused with the undesirable situation of "saturated" soil, where all the pore spaces are occupied by water. After a saturation event, such as heavy rain, the soil usually needs at least 24 h to reach field capacity. When moisture content falls below field capacity, the subsequent limited movement of water in the soil is partly liquid, partly in the vapour phase by distillation (related to temperature gradients in the soil), and sometimes by transport in plant roots.

Plant roots within the block will extract liquid water from the water films around the soil particles with which they are in contact. The rate at which this extraction is possible depends on the soil moisture potential. A point is reached at which the forces holding moisture films to soil particles cannot be overcome by root suction plants are starved of

water and lose turgidity: soil moisture has reached the “wilting point”, which in most cases occurs at a soil water potential of -1.5 MPa ($pF = 4.2$). In agriculture, the soil water available to plants is commonly taken to be the quantity between field capacity and the wilting point, and this varies highly between soils: in sandy soils it may be less than 10 volume per cent, while in soils with much organic matter it can be over 40 volume per cent.

Usually it is desirable to know the soil moisture content and potential as a function of depth. Evapotranspiration models concern mostly a shallow depth (tens of centimetres); agricultural applications need moisture information at root depth (order of a metre); and atmospheric general circulation models incorporate a number of layers down to a few metres. For hydrological and water-balance needs – such as catchment-scale runoff models, as well as for effects upon soil properties such as soil mechanical strength, thermal conductivity and diffusivity – information on deep soil water content is needed. The accuracy needed in water content determinations and the spatial and temporal resolution required vary by application. An often-occurring problem is the inhomogeneity of many soils, meaning that a single observation location cannot provide absolute knowledge of the regional soil moisture, but only relative knowledge of its change.

11.1.4 Measurement methods

The methods and instruments available to evaluate soil water status may be classified in three ways. First, a distinction is made between the determination of water content and the determination of water potential. Second, a so-called direct method requires the availability of sizeable representative terrain from which large numbers of soil samples can be taken for destructive evaluation in the laboratory. Indirect methods use an instrument placed in the soil to measure some soil property related to soil moisture. Third, methods can be ranged according to operational applicability, taking into account the regular labour involved, the degree of dependence on laboratory availability, the complexity of the operation and the reliability of the result. Moreover, the preliminary costs of acquiring instrumentation must be compared with the subsequent costs of local routine observation and data processing.

Reviews such as WMO (1968; 1989; 2001) and Schmutge, Jackson and McKim (1980) are very useful for learning about practical problems, but

dielectric measurement methods were only developed well after 1980, so too-early reviews should not be relied on much when choosing an operational method.

There are four operational alternatives for the determination of soil water content. First, there is classic gravimetric moisture determination, which is a simple direct method. Second, there is lysimetry, a non-destructive variant of gravimetric measurement. A container filled with soil is weighed either occasionally or continuously to indicate changes in total mass in the container, which may in part or totally be due to changes in soil moisture (lysimeters are discussed in more detail in Part I, Chapter 10). Third, water content may be determined indirectly by various radiological techniques, such as neutron scattering and gamma absorption. Fourth, water content can be derived from the dielectric properties of soil, for example, by using time-domain reflectometry.

Soil water potential measurement can be performed by several indirect methods, in particular using tensiometers, resistance blocks and soil psychrometers. None of these instruments is effective at this time over the full range of possible water potential values. For extended study of all methods of various soil moisture measurements, up-to-date handbooks are provided by Klute (1986), Dirksen (1999), and Smith and Mullins (referenced here as Gardner and others, 2001, and Mullins, 2001).

11.2 GRAVIMETRIC DIRECT MEASUREMENT OF SOIL WATER CONTENT

The gravimetric soil moisture content θ_g is typically determined directly. Soil samples of about 50 g are removed from the field with the best available tools (shovels, spiral hand augers, bucket augers, perhaps power-driven coring tubes), disturbing the sample soil structure as little as possible (Dirksen, 1999). The soil sample should be placed immediately in a leak-proof, seamless, pre-weighed and identified container. As the samples will be placed in an oven, the container should be able to withstand high temperatures without melting or losing significant mass. The most common soil containers are aluminium cans, but non-metallic containers should be used if the samples are to be dried in microwave ovens in the laboratory. If soil samples are to be transported for a considerable distance, tape should be used to seal the container to avoid moisture loss by evaporation.

The samples and container are weighed in the laboratory both before and after drying, the difference being the mass of water originally in the sample. The drying procedure consists in placing the open container in an electrically heated oven at 105°C until the mass stabilizes at a constant value. The drying times required usually vary between 16 and 24 h. Note that drying at 105±5°C is part of the usually accepted definition of "soil water content", originating from the aim to measure only the content of "free" water which is not bound to the soil matrix (Gardner and others, 2001).

If the soil samples contain considerable amounts of organic matter, excessive oxidation may occur at 105°C and some organic matter will be lost from the sample. Although the specific temperature at which excessive oxidation occurs is difficult to specify, lowering the oven temperature from 105 to 70°C seems to be sufficient to avoid significant loss of organic matter, but this can lead to water content values that are too low. Oven temperatures and drying times should be checked and reported.

Microwave oven drying for the determination of gravimetric water contents may also be used effectively (Gee and Dodson, 1981). In this method, soil water temperature is quickly raised to boiling point, then remains constant for a period due to the consumption of heat in vaporizing water. However, the temperature rapidly rises as soon as the energy absorbed by the soil water exceeds the energy needed for vaporizing the water. Caution should be used with this method, as temperatures can become high enough to melt plastic containers if stones are present in the soil sample.

Gravimetric soil water contents of air-dry (25°C) mineral soil are often less than 2 per cent, but, as the soil approaches saturation, the water content may increase to values between 25 and 60 per cent, depending on soil type. Volumetric soil water content, θ_v , may range from less than 10 per cent for air-dry soil to between 40 and 50 per cent for mineral soils approaching saturation. Soil θ_v determination requires measurement of soil density, for example, by coating a soil clod with paraffin and weighing it in air and water, or some other method (Campbell and Henshall, 2001).

Water contents for stony or gravelly soils can be grossly misleading. When rocks occupy an appreciable volume of the soil, they modify direct measurement of soil mass, without making a similar contribution to the soil porosity. For example, gravimetric water content may be 10 per cent for a soil sample with a bulk density of 2 000 kg m⁻³;

however, the water content of the same sample based on finer soil material (stones and gravel excluded) would be 20 per cent, if the bulk density of fine soil material was 1 620 kg m⁻³.

Although the gravimetric water content for the finer soil fraction, $\theta_{g, \text{fines}}$, is the value usually used for spatial and temporal comparison, there may also be a need to determine the volumetric water content for a gravelly soil. The latter value may be important in calculating the volume of water in a root zone. The relationship between the gravimetric water content of the fine soil material and the bulk volumetric water content is given by:

$$\theta_{v, \text{stony}} = \theta_{g, \text{fines}} (\rho_b / \rho_v) (1 + M_{\text{stones}} / M_{\text{fines}}) \quad (11.6)$$

where $\theta_{v, \text{stony}}$ is the bulk volumetric water content of soil containing stones or gravel and M_{stones} and M_{fines} are the masses of the stone and fine soil fractions (Klute, 1986).

11.3 SOIL WATER CONTENT: INDIRECT METHODS

The capacity of soil to retain water is a function of soil texture and structure. When removing a soil sample, the soil being evaluated is disturbed, so its water-holding capacity is altered. Indirect methods of measuring soil water are helpful as they allow information to be collected at the same location for many observations without disturbing the soil water system. Moreover, most indirect methods determine the volumetric soil water content without any need for soil density determination.

11.3.1 Radiological methods

Two different radiological methods are available for measuring soil water content. One is the widely used neutron scatter method, which is based on the interaction of high-energy (fast) neutrons and the nuclei of hydrogen atoms in the soil. The other method measures the attenuation of gamma rays as they pass through soil. Both methods use portable equipment for multiple measurements at permanent observation sites and require careful calibration, preferably with the soil in which the equipment is to be used.

When using any radiation-emitting device, some precautions are necessary. The manufacturer will provide a shield that must be used at all times. The only time the probe leaves the shield is when it is lowered into the soil access tube. When the guidelines and regulations regarding radiation hazards stipulated by the manufacturers and health

authorities are followed, there is no need to fear exposure to excessive radiation levels, regardless of the frequency of use. Nevertheless, whatever the type of radiation-emitting device used, the operator should wear some type of film badge that will enable personal exposure levels to be evaluated and recorded on a monthly basis.

11.3.1.1 Neutron scattering method

In neutron soil moisture detection (Visvalingam and Tandy, 1972; Greacen, 1981), a probe containing a radioactive source emitting high-energy (fast) neutrons and a counter of slow neutrons is lowered into the ground. The hydrogen nuclei, having about the same mass as neutrons, are at least 10 times as effective for slowing down neutrons upon collision as most other nuclei in the soil. Because in any soil most hydrogen is in water molecules, the density of slow "thermalized" neutrons in the vicinity of the neutron probe is nearly proportional to the volumetric soil water content.

Some fraction of the slowed neutrons, after a number of collisions, will again reach the probe and its counter. When the soil water content is large, not many neutrons are able to travel far before being thermalized and ineffective, and then 95 per cent of the counted returning neutrons come from a relatively small soil volume. In wet soil, the "radius of influence" may be only 15 cm, while in dry soil that radius may increase to 50 cm. Therefore, the measured soil volume varies with water content, and thin layers cannot be resolved. This method is hence less suitable to localize water-content discontinuities, and it cannot be used effectively in the top 20 cm of soil on account of the soil air discontinuity.

Several source and detector arrangements are possible in a neutron probe, but it is best to have a probe with a double detector and a central source, typically in a cylindrical container. Such an arrangement allows for a nearly spherical zone of influence and leads to a more linear relation of neutron count to soil water content.

A cable is used to attach a neutron probe to the main instrument electronics, so that the probe can be lowered into a previously installed access tube. The access tube should be seamless and thick enough (at least 1.25 mm) to be rigid, but not so thick that the access tube itself slows neutrons down significantly. The access tube must be made of non-corrosive material, such as stainless steel, aluminium or plastic, although polyvinylchloride should be avoided as it absorbs slow neutrons.

Usually, a straight tube with a diameter of 5 cm is sufficient for the probe to be lowered into the tube without a risk of jamming. Care should be taken in installing the access tube to ensure that no air voids exist between the tube and the soil matrix. At least 10 cm of the tube should extend above the soil surface, in order to allow the box containing the electronics to be mounted on top of the access tube. All access tubes should be fitted with a removable cap to keep rainwater from entering the tubes.

In order to enhance experimental reproducibility, the soil water content is not derived directly from the number of slow neutrons detected, but rather from a count ratio (CR), given by:

$$CR = C_{\text{soil}}/C_{\text{background}} \quad (11.7)$$

where C_{soil} is the count of thermalized neutrons detected in the soil and $C_{\text{background}}$ is the count of thermalized neutrons in a reference medium. All neutron probe instruments now come with a reference standard for these background calibrations, usually against water. The standard in which the probe is placed should be at least 0.5 m in diameter so as to represent an "infinite" medium. Calibration to determine $C_{\text{background}}$ can be done by a series of ten 1 min readings, to be averaged, or by a single 1 h reading. C_{soil} is determined from averaging several soil readings at a particular depth/location. For calibration purposes, it is best to take three samples around the access tube and to average the water contents corresponding to the average CR calculated for that depth. A minimum of five different water contents should be evaluated for each depth. Although some calibration curves may be similar, a separate calibration for each depth should be conducted. The lifetime of most probes is more than 10 years.

11.3.1.2 Gamma-ray attenuation

Whereas the neutron method measures the volumetric water content in a large sphere, gamma-ray absorption scans a thin layer. The dual-probe gamma device is nowadays mainly used in the laboratory since dielectric methods became operational for field use. Another reason for this is that gamma rays are more dangerous to work with than neutron scattering devices, as well as the fact that the operational costs for the gamma rays are relatively high.

Changes in gamma attenuation for a given mass absorption coefficient can be related to changes in total soil density. As the attenuation of gamma rays is due to mass, it is not possible to determine water content unless the attenuation of gamma rays due

to the local dry soil density is known and remains unchanged with changing water content. Determining accurately the soil water content from the difference between the total and dry density attenuation values is therefore not simple.

Compared to neutron scattering, gamma-ray attenuation has the advantage of allowing accurate measurements at a few centimetres below the air-surface interface. Although the method has a high degree of resolution, the small soil volume evaluated will exhibit more spatial variation due to soil heterogeneities (Gardner and Calissendorff, 1967).

11.3.2 Soil water dielectrics

When a medium is placed in the electric field of a capacitor or waveguide, its influence on the electric forces in that field is expressed as the ratio between the forces in the medium and the forces which would exist in vacuum. This ratio, called permittivity or "dielectric constant", is for liquid water about 20 times larger than that of average dry soil, because water molecules are permanent dipoles. The dielectric properties of ice, and of water bound to the soil matrix, are comparable to those of dry soil. Therefore, the volumetric content of free soil water can be determined from the dielectric characteristics of wet soil by reliable, fast, non-destructive measurement methods, without the potential hazards associated with radioactive devices. Moreover, such dielectric methods can be fully automated for data acquisition. At present, two methods which evaluate soil water dielectrics are commercially available and used extensively, namely time-domain reflectometry and frequency-domain measurement.

11.3.2.1 Time-domain reflectometry

Time-domain reflectometry is a method which determines the dielectric constant of the soil by monitoring the travel of an electromagnetic pulse, which is launched along a waveguide formed by a pair of parallel rods embedded in the soil. The pulse is reflected at the end of the waveguide and its propagation velocity, which is inversely proportional to the square root of the dielectric constant, can be measured well by actual electronics.

The most widely used relation between soil dielectrics and soil water content was experimentally summarized by Topp, Davis and Annan (1980) as follows:

$$\theta_v = -0.053 + 0.029 \varepsilon - 5.5 \cdot 10^{-4} \varepsilon^2 + 4.3 \cdot 10^{-6} \varepsilon^3 \quad (11.8)$$

where ε is the dielectric constant of the soil water system. This empirical relationship has proved to be applicable in many soils, roughly independent of texture and gravel content (Drungil, Abt and Gish, 1989). However, soil-specific calibration is desirable for soils with low density or with a high organic content. For complex soil mixtures, the De Loor equation has proved useful (Dirksen and Dasberg, 1993).

Generally, the parallel probes are separated by 5 cm and vary in length from 10 to 50 cm; the rods of the probe can be of any metallic substance. The sampling volume is essentially a cylinder of a few centimetres in radius around the parallel probes (Knight, 1992). The coaxial cable from the probe to the signal-processing unit should not be longer than about 30 m. Soil water profiles can be obtained from a buried set of probes, each placed horizontally at a different depth, linked to a field data logger by a multiplexer.

11.3.2.2 Frequency-domain measurement

While time-domain reflectometry uses microwave frequencies in the gigahertz range, frequency-domain sensors measure the dielectric constant at a single microwave megahertz frequency. The microwave dielectric probe utilizes an open-ended coaxial cable and a single reflectometer at the probe tip to measure amplitude and phase at a particular frequency. Soil measurements are referenced to air, and are typically calibrated with dielectric blocks and/or liquids of known dielectric properties. One advantage of using liquids for calibration is that a perfect electrical contact between the probe tip and the material can be maintained (Jackson, 1990).

As a single, small probe tip is used, only a small volume of soil is ever evaluated, and soil contact is therefore critical. As a result, this method is excellent for laboratory or point measurements, but is likely to be subject to spatial variability problems if used on a field scale (Dirksen, 1999).

11.4 SOIL WATER POTENTIAL INSTRUMENTATION

The basic instruments capable of measuring matric potential are sufficiently inexpensive and reliable to be used in field-scale monitoring programmes. However, each instrument has a limited accessible water potential range. Tensiometers work well only in wet soil, while resistance blocks do better in moderately dry soil.

11.4.1 Tensiometers

The most widely used and least expensive water potential measuring device is the tensiometer. Tensiometers are simple instruments, usually consisting of a porous ceramic cup and a sealed plastic cylindrical tube connecting the porous cup to some pressure-recording device at the top of the cylinder. They measure the matric potential, because solutes can move freely through the porous cup.

The tensiometer establishes a quasi-equilibrium condition with the soil water system. The porous ceramic cup acts as a membrane through which water flows, and therefore must remain saturated if it is to function properly. Consequently, all the pores in the ceramic cup and the cylindrical tube are initially filled with de-aerated water. Once in place, the tensiometer will be subject to negative soil water potentials, causing water to move from the tensiometer into the surrounding soil matrix. The water movement from the tensiometer will create a negative potential or suction in the tensiometer cylinder which will register on the recording device. For recording, a simple U-tube filled with water and/or mercury, a Bourdon-type vacuum gauge or a pressure transducer (Marthaler and others, 1983) is suitable.

If the soil water potential increases, water moves from the soil back into the tensiometer, resulting in a less negative water potential reading. This exchange of water between the soil and the tensiometer, as well as the tensiometer's exposure to negative potentials, will cause dissolved gases to be released by the solution, forming air bubbles. The formation of air bubbles will alter the pressure readings in the tensiometer cylinder and will result in faulty readings. Another limitation is that the tensiometer has a practical working limit of $\psi \approx -85$ kPa. Beyond -100 kPa (≈ 1 atm), water will boil at ambient temperature, forming water vapour bubbles which destroy the vacuum inside the tensiometer cylinder. Consequently, the cylinders occasionally need to be de-aired with a hand-held vacuum pump and then refilled.

Under drought conditions, appreciable amounts of water can move from the tensiometer to the soil. Thus, tensiometers can alter the very condition they were designed to measure. Additional proof of this process is that excavated tensiometers often have accumulated large numbers of roots in the proximity of the ceramic cups. Typically, when the tensiometer acts as an "irrigator", so much water is lost through the ceramic cups that a vacuum in the cylinder cannot be maintained, and the tensiometer gauge will be inoperative.

Before installation, but after the tensiometer has been filled with water and degassed, the ceramic cup must remain wet. Wrapping the ceramic cup in wet rags or inserting it into a container of water will keep the cup wet during transport from the laboratory to the field. In the field, a hole of the appropriate size and depth is prepared. The hole should be large enough to create a snug fit on all sides, and long enough so that the tensiometer extends sufficiently above the soil surface for de-airing and refilling access. Since the ceramic cup must remain in contact with the soil, it may be beneficial in stony soil to prepare a thin slurry of mud from the excavated site and to pour it into the hole before inserting the tensiometer. Care should also be taken to ensure that the hole is backfilled properly, thus eliminating any depressions that may lead to ponded conditions adjacent to the tensiometer. The latter precaution will minimize any water movement down the cylinder walls, which would produce unrepresentative soil water conditions.

Only a small portion of the tensiometer is exposed to ambient conditions, but its interception of solar radiation may induce thermal expansion of the upper tensiometer cylinder. Similarly, temperature gradients from the soil surface to the ceramic cup may result in thermal expansion or contraction of the lower cylinder. To minimize the risk of temperature-induced false water potential readings, the tensiometer cylinder should be shaded and constructed of non-conducting materials, and readings should be taken at the same time every day, preferably in the early morning.

A new development is the osmotic tensiometer, where the tube of the meter is filled with a polymer solution in order to function better in dry soil. For more information on tensiometers see Dirksen (1999) and Mullins (2001).

11.4.2 Resistance blocks

Electrical resistance blocks, although insensitive to water potentials in the wet range, are excellent companions to the tensiometer. They consist of electrodes encased in some type of porous material that within about two days will reach a quasi-equilibrium state with the soil. The most common block materials are nylon fabric, fibreglass and gypsum, with a working range of about -50 kPa (for nylon) or -100 kPa (for gypsum) up to -1500 kPa. Typical block sizes are $4 \text{ cm} \times 4 \text{ cm} \times 1 \text{ cm}$. Gypsum blocks last a few years, but less in very wet or saline soil (Perrier and Marsh, 1958).

This method determines water potential as a function of electrical resistance, measured with an alternating current bridge (usually $\approx 1\,000$ Hz) because direct current gives polarization effects. However, resistance decreases if soil is saline, falsely indicating a wetter soil. Gypsum blocks are less sensitive to soil saltiness effects because the electrodes are consistently exposed to a saturated solution of calcium sulphate. The output of gypsum blocks must be corrected for temperature (Aggelides and Londra, 1998).

Because resistance blocks do not protrude above the ground, they are excellent for semi-permanent agricultural networks of water potential profiles, if installation is careful and systematic (WMO, 2001). When installing the resistance blocks it is best to dig a small trench for the lead wires before preparing the hole for the blocks, in order to minimize water movement along the wires to the blocks. A possible field problem is that shrinking and swelling soil may break contact with the blocks. On the other hand, resistance blocks do not affect the distribution of plant roots.

Resistance blocks are relatively inexpensive. However, they need to be calibrated individually. This is generally accomplished by saturating the blocks in distilled water and then subjecting them to a predetermined pressure in a pressure-plate apparatus (Wellings, Bell and Raynor, 1985), at least at five different pressures before field installation. Unfortunately, the resistance is less on a drying curve than on a wetting curve, thus generating hysteresis errors in the field because resistance blocks are slow to equilibrate with varying soil wetness (Tanner and Hanks, 1952). As resistance-block calibration curves change with time, they need to be calibrated before installation and to be checked regularly afterwards, either in the laboratory or in the field.

11.4.3 Psychrometers

Psychrometers are used in laboratory research on soil samples as a standard for other techniques (Mullins, 2001), but a field version is also available, called the Spanner psychrometer (Rawlins and Campbell, 1986). This consists of a miniature thermocouple placed within a small chamber with a porous wall. The thermocouple is cooled by the Peltier effect, condensing water on a wire junction. As water evaporates from the junction, its temperature decreases and a current is produced which is measured by a meter. Such measurements are quick to respond to changes in soil water potential, but are very sensitive to temperature and salinity (Merrill and Rawlins, 1972).

The lowest water potential typically associated with active plant water uptake corresponds to a relative humidity of between 98 and 100 per cent. This implies that, if the water potential in the soil is to be measured accurately to within 10 kPa, the temperature would have to be controlled to better than 0.001 K. This means that the use of field psychrometers is most appropriate for low matric potentials, of less than -300 kPa. In addition, the instrument components differ in heat capacities, so diurnal soil temperature fluctuations can induce temperature gradients in the psychrometer (Brunini and Thurtell, 1982). Therefore, Spanner psychrometers should not be used at depths of less than 0.3 m, and readings should be taken at the same time each day, preferably in the early morning. In summary, soil psychrometry is a difficult and demanding method, even for specialists.

11.5 REMOTE SENSING OF SOIL MOISTURE

Earlier in this chapter it was mentioned that a single observation location cannot provide absolute knowledge of regional soil moisture, but only relative knowledge of its change, because soils are often very inhomogeneous. However, nowadays measurements from space-borne instruments using remote-sensing techniques are available for determining soil moisture in the upper soil layer. This allows interpolation at the mesoscale for estimation of evapotranspiration rates, evaluation of plant stress and so on, and also facilitates moisture balance input in weather models (Jackson and Schmugge, 1989; Saha, 1995). The usefulness of soil moisture determination at meteorological stations has been increased greatly thereby, because satellite measurements need “ground truth” to provide accuracy in the absolute sense. Moreover, station measurements are necessary to provide information about moisture in deeper soil layers, which cannot be observed from satellites or aircraft. Some principles of the airborne measurement of soil moisture are briefly given here; for more details see Part II, Chapter 8.

Two uncommon properties of the water in soil make it accessible to remote sensing. First, as already discussed above in the context of time-domain reflectometry, the dielectric constant of water is of an order of magnitude larger than that of dry soils at microwave lengths. In remote sensing, this feature can be used either passively or actively (Schmugge, Jackson and McKim, 1980). Passive sensing analyses the natural microwave emissions from the Earth’s surface, while active sensing refers to evaluating back scatter of a satellite-sent signal.

The microwave radiometer response will range from an emissivity of 0.95 to 0.6 or lower for passive microwave measurements. For the active satellite radar measurements, an increase of about 10 db in return is observed as soil goes from dry to wet. The microwave emission is referred to as brightness temperature T_b and is proportional to the emissivity β and the temperature of the soil surface, T_{soil} , or:

$$T_b = \beta T_{\text{soil}} \quad (11.9)$$

where T_{soil} is in kelvin and β depends on soil texture, surface roughness and vegetation. Any vegetation canopy will influence the soil component. The volumetric water content is related to the total active backscatter S_t by:

$$\theta_v = L (S_t - S_v) (RA)^{-1} \quad (11.10)$$

where L is a vegetation attenuation coefficient; S_v is the back scatter from vegetation; R is a soil surface roughness term; and A is a soil moisture sensitivity term.

As a result, microwave response to soil water content can be expressed as an empirical relationship. The sampling depth in the soil is of the order of 5 to 10 cm. The passive technique is robust, but its pixel resolution is limited to not less than 10 km because satellite antennas have a limited size. The active satellite radar pixel resolution is more than a factor of 100 better, but active sensing is very sensitive to surface roughness and requires calibration against surface data.

The second remote-sensing feature of soil water is its relatively large heat capacity and thermal conductivity. Therefore, moist soils have a large thermal inertia. Accordingly, if cloudiness does not interfere, remote sensing of the diurnal range of surface temperature can be used to estimate soil moisture (Idso and others, 1975; Van de Griend, Camillo and Gurney, 1985).

11.6 SITE SELECTION AND SAMPLE SIZE

Standard soil moisture observations at principal stations should be made at several depths between

10 cm and 1 m, and also lower if there is much deep infiltration. Observation frequency should be approximately once every week. Indirect measurement should not necessarily be carried in the meteorological enclosure, but rather near it, below a sufficiently horizontal natural surface which is typical of the uncultivated environment.

Representativity of any soil moisture observation point is limited because of the high probability of significant variations, both horizontally and vertically, of soil structure (porosity, density, chemical composition). Horizontal variations of soil water potential tend to be relatively less than such variations of soil water content. Gravimetric water content determinations are only reliable at the point of measurement, making a large number of samples necessary to describe adequately the soil moisture status of the site. To estimate the number of samples n needed at a local site to estimate soil water content at an observed level of accuracy (L), the sample size can be estimated from:

$$n = 4 (\sigma^2/L^2) \quad (11.11)$$

where σ^2 is the sample variance generated from a preliminary sampling experiment. For example, suppose that a preliminary sampling yielded a (typical) σ^2 of 25 per cent and the accuracy level needed to be within 3 per cent, 12 samples would be required from the site (if it can be assumed that water content is normally distributed across the site).

A regional approach divides the area into strata based on the uniformity of relevant variables within the strata, for example, similarity of hydrological response, soil texture, soil type, vegetative cover, slope, and so on. Each stratum can be sampled independently and the data recombined by weighing the results for each stratum by its relative area. The most critical factor controlling the distribution of soil water in low-sloping watersheds is topography, which is often a sufficient criterion for subdivision into spatial units of homogeneous response. Similarly, sloping rangeland will need to be more intensely sampled than flat cropland. However, the presence of vegetation tends to diminish the soil moisture variations caused by topography.

REFERENCES AND FURTHER READING

- Aggelides, S.M. and P.A. Londra, 1998: Comparison of empirical equations for temperature correction of gypsum sensors. *Agronomy Journal*, 90, pp. 441-443.
- Brunini, O. and G.W. Thurtell, 1982: An improved thermocouple hygrometer for in situ measurements of soil water potential. *Soil Science Society of America Journal*, 46, pp. 900-904.
- Campbell, D.J. and J.K. Henshall, 2001: Bulk density. In: K.A. Smith and C.E. Mullins, *Soil and Environmental Analysis: Physical Methods*, Marcel Dekker, New York, pp. 315-348.
- Deardorff, J.W., 1978: Efficient prediction of ground surface temperature and moisture, with inclusion of a layer of vegetation. *Journal of Geophysical Research*, 83, pp. 1889-1904.
- Dirksen, C., 1999: *Soil Physics Measurements*. Catena Verlag, Reiskirchen, Germany, 154 pp.
- Dirksen, C. and S. Dasberg, 1993: Improved calibration of time domain reflectometry soil water content measurements. *Soil Science Society of America Journal*, 57, pp. 660-667.
- Drungil, C.E.C., K. Abt and T.J. Gish, 1989: Soil moisture determination in gravelly soils with time domain reflectometry. *Transactions of the American Society of Agricultural Engineering*, 32, pp. 177-180.
- Gardner, W.H. and C. Calissendorff, 1967: Gamma-ray and neutron attenuation measurement of soil bulk density and water content. *Proceedings of the Symposium on the Use of Isotope and Radiation Techniques in Soil Physics and Irrigation Studies* (Istanbul, 12-16 June 1967). International Atomic Energy Agency, Vienna, pp. 101-112.
- Gardner, C.M.K., D.A. Robinson, K. Blyth and J.D. Cooper, 2001: Soil water content. In: K.A. Smith, and C.E. Mullins, *Soil and Environmental Analysis: Physical Methods*, Marcel Dekker, New York, pp. 1-64.
- Gee, G.W. and M.E. Dodson, 1981: Soil water content by microwave drying: A routine procedure. *Soil Science Society of America Journal*, 45, pp. 1234-1237.
- Greacen, E.L., 1981: *Soil Water Assessment by the Neutron Method*. CSIRO, Australia, 140 pp.
- Idso, S.B., R.D. Jackson, R.J. Reginato and T.J. Schmugge, 1975: The utility of surface temperature measurements for the remote sensing of sun for soil water status. *Journal of Geophysical Research*, 80, pp. 3044-3049.
- Jackson, T.J., 1990: Laboratory evaluation of a field-portable dielectric/soil moisture probe. *IEEE Transactions on Geoscience and Remote Sensing*, 28, pp. 241-245.
- Jackson, T.J. and T.J. Schmugge, 1989: Passive microwave remote sensing system for soil moisture: Some supporting research. *IEEE Transactions on Geoscience and Remote Sensing*, 27, pp. 225-235.
- Klute, A. (ed.), 1986: *Methods of Soil Analysis, Part 1: Physical and Mineralogical Methods*. American Society of Agronomy, Madison, Wisconsin, United States, 1188 pp.
- Knight, J.H., 1992: Sensitivity of time domain reflectometry measurements to lateral variations in soil water content. *Water Resources Research*, 28, pp. 2345-2352.
- Marthaler, H.P., W. Vogelsanger, F. Richard and J.P. Wierenga, 1983: A pressure transducer for field tensiometers. *Soil Science Society of America Journal*, 47, pp. 624-627.
- Merrill, S.D. and S.L. Rawlins, 1972: Field measurement of soil water potential with thermocouple psychrometers. *Soil Science*, 113, pp. 102-109.
- Mullins, C.E., 2001: Matric potential. In: K.A. Smith, and C.E. Mullins, *Soil and Environmental Analysis: Physical Methods*. Marcel Dekker, New York, pp. 65-93.
- Perrier, E.R. and A.W. Marsh, 1958: Performance characteristics of various electrical resistance units and gypsum materials. *Soil Science*, 86, pp. 140-147.
- Rawlins, S.L. and G.S. Campbell, 1986: Water potential: Thermocouple psychrometry. In: A. Klute, (ed.), *Methods of Soil Analysis - Part 1: Physical and Mineralogical Methods*. American Society of Agronomy, Madison, Wisconsin, United States, pp. 597-618.
- Saha, S.K., 1995: Assessment of regional soil moisture conditions by coupling satellite sensor data with a soil-plant system heat and moisture balance model. *International Journal of Remote Sensing*, 16, pp. 973-980.
- Schmugge, T.J., T.J. Jackson, and H.L. McKim, 1980: Survey of methods for soil moisture determination. *Water Resources Research*, 16, pp. 961-979.
- Tanner, C.B. and R.J. Hanks, 1952: Moisture hysteresis in gypsum moisture blocks. *Soil Science Society of America Proceedings*, 16, pp. 48-51.
- Topp, G.C., J.L. Davis and A.P. Annan, 1980: Electromagnetic determination of soil water

- content: Measurement in coaxial transmission lines. *Water Resources Research*, 16, pp. 574-582.
- Van de Griend, A.A., P.J. Camillo and R.J. Gurney, 1985: Discrimination of soil physical parameters, thermal inertia and soil moisture from diurnal surface temperature fluctuations. *Water Resources Research*, 21, pp. 997-1009.
- Visvalingam, M. and J.D. Tandy, 1972: The neutron method for measuring soil moisture content: A review. *European Journal of Soil Science*, 23, pp. 499-511.
- Wellings, S.R., J.P. Bell and R.J. Raynor, 1985: *The Use of Gypsum Resistance Blocks for Measuring Soil Water Potential in the Field*. Report No. 92, Institute of Hydrology, Wallingford, United Kingdom.
- World Meteorological Organization, 1968: *Practical Soil Moisture Problems in Agriculture*. Technical Note No. 97, WMO-No. 235.TP.128, Geneva.
- World Meteorological Organization, 1989: *Land Management in Arid and Semi-arid Areas*. Technical Note No. 186, WMO-No. 662, Geneva.
- World Meteorological Organization, 2001: *Lecture Notes for Training Agricultural Meteorological Personnel* (J. Wieringa and J. Lomas). Second edition, WMO-No. 551, Geneva.
-

CHAPTER 12

MEASUREMENT OF UPPER-AIR PRESSURE, TEMPERATURE AND HUMIDITY

12.1 GENERAL

12.1.1 Definitions

The following definitions from WMO (1992; 2003a) are relevant to upper-air measurements using a radiosonde:

Radiosonde: Instrument intended to be carried by a balloon through the atmosphere, equipped with devices to measure one or several meteorological variables (pressure, temperature, humidity, etc.), and provided with a radio transmitter for sending this information to the observing station.

Radiosonde observation: An observation of meteorological variables in the upper air, usually atmospheric pressure, temperature and humidity, by means of a radiosonde.

Note: The radiosonde may be attached to a balloon, or it may be dropped (dropsonde) from an aircraft or rocket.

Radiosonde station: A station at which observations of atmospheric pressure, temperature and humidity in the upper air are made by electronic means.

Upper-air observation: A meteorological observation made in the free atmosphere, either directly or indirectly.

Upper-air station, upper air synoptic station, aerological station: A surface location from which upper-air observations are made.

Sounding: Determination of one or several upper-air meteorological variables by means of instruments carried aloft by balloon, aircraft, kite, glider, rocket, and so on.

This chapter will primarily deal with radiosonde systems. Measurements using special platforms or specialized equipment, or made indirectly by remote-sensing methods will be discussed in various chapters of Part II of this Guide. Radiosonde systems are normally used to measure pressure, temperature and relative humidity. At most operational sites, the radiosonde system is also used for upper-wind determination (see Part I, Chapter 13). In addition, some radiosondes are flown with sensing systems

for atmospheric constituents, such as ozone concentration or radioactivity. These additional measurements are not discussed in any detail in this chapter.

12.1.2 Units used in upper-air measurements

The units of measurement for the meteorological variables of radiosonde observations are hectopascals for pressure, degrees Celsius for temperature, and per cent for relative humidity. Relative humidity is reported relative to saturated vapour pressure over a water surface, even at temperatures less than 0°C.

The unit of geopotential height used in upper-air observations is the standard geopotential metre, defined as 0.980 665 dynamic metres. In the troposphere, the value of the geopotential height is approximately equal to the geometric height expressed in metres.

The values of the physical functions and constants adopted by WMO (1988) should be used in radiosonde computations.

12.1.3 Meteorological requirements

12.1.3.1 Radiosonde data for meteorological operations

Upper-air measurements of temperature and relative humidity are two of the basic measurements used in the initialization of the analyses of numerical weather prediction models for operational weather forecasting. Radiosondes provide most of the in situ temperature and relative humidity measurements over land, while radiosondes launched from remote islands or ships provide a limited coverage over the oceans. Temperatures with resolution in the vertical similar to radiosondes can be observed by aircraft either during ascent, descent, or at cruise levels. The aircraft observations are used to supplement the radiosonde observations, particularly over the sea. Satellite observations of temperature and water vapour distribution have lower vertical resolution than radiosonde or aircraft measurements. Satellite observations have greatest impact on numerical weather prediction analyses over

the oceans and other areas of the globe where radiosonde and aircraft observations are sparse or unavailable.

Accurate measurements of the vertical structure of temperature and water vapour fields in the troposphere are extremely important for all types of forecasting, especially regional and local forecasting. The measurements indicate the existing structure of cloud or fog layers in the vertical. Furthermore, the vertical structure of temperature and water vapour fields determines the stability of the atmosphere and, subsequently, the amount and type of cloud that will be forecast. Radiosonde measurements of the vertical structure can usually be provided with sufficient accuracy to meet most user requirements. However, negative systematic errors in radiosonde relative humidity measurements of high humidity in clouds cause problems in numerical weather prediction analyses, if the error is not compensated.

High-resolution measurements of the vertical structure of temperature and relative humidity are important for environmental pollution studies (for instance, identifying the depth of the atmospheric boundary layer). High resolution in the vertical is also necessary for forecasting the effects of atmospheric refraction on the propagation of electromagnetic radiation or sound waves.

Civil aviation, artillery and other ballistic applications, such as space vehicle launches, have operational requirements for measurements of the density of air at given pressures (derived from radiosonde temperature and relative humidity measurements).

Radiosonde observations are vital for studies of upper-air climate change. Hence, it is important to keep adequate records of the systems used for measurements and also of any changes in the operating or correction procedures used with the equipment. In this context, it has proved necessary to establish the changes in radiosonde instruments and practices that have taken place since radiosondes were used on a regular basis (see for instance WMO, 1993*a*). Climate change studies based on radiosonde measurements require extremely high stability in the systematic errors of the radiosonde measurements. However, the errors in early radiosonde measurements of some meteorological variables, particularly relative humidity and pressure, were too high to provide acceptable long-term references at all heights reported by the radiosondes. Thus, improvements to and changes in radiosonde design were necessary. Furthermore,

expenditure limitations on meteorological operations require that radiosonde consumables remain cheap if widespread radiosonde use is to continue. Therefore, certain compromises in system measurement accuracy have to be accepted by users, taking into account that radiosonde manufacturers are producing systems that need to operate over an extremely wide range of meteorological conditions:

- 1 050 to 5 hPa for pressure
- 50 to -90°C for temperature
- 100 to 1 per cent for relative humidity

with the systems being able to sustain continuous reliable operation when operating in heavy rain, in the vicinity of thunderstorms, and in severe icing conditions.

12.1.3.2 Relationships between satellite and radiosonde upper-air measurements

Nadir-viewing satellite observing systems do not measure vertical structure with the same accuracy or degree of confidence as radiosonde or aircraft systems. The current satellite temperature and water vapour sounding systems either observe upwelling radiances from carbon dioxide or water vapour emissions in the infrared, or alternatively oxygen or water vapour emissions at microwave frequencies (see Part II, Chapter 8). The radiance observed by a satellite channel is composed of atmospheric emissions from a range of heights in the atmosphere. This range is determined by the distribution of emitting gases in the vertical and the atmospheric absorption at the channel frequencies. Most radiances from satellite temperature channels approximate mean layer temperatures for a layer at least 10 km thick. The height distribution (weighting function) of the observed temperature channel radiance will vary with geographical location to some extent. This is because the radiative transfer properties of the atmosphere have a small dependence on temperature. The concentrations of the emitting gas may vary to a small extent with location and cloud; aerosol and volcanic dust may also modify the radiative heat exchange. Hence, basic satellite temperature sounding observations provide good horizontal resolution and spatial coverage worldwide for relatively thick layers in the vertical, but the precise distribution in the vertical of the atmospheric emission observed may be difficult to specify at any given location.

Most radiances observed by nadir-viewing satellite water vapour channels in the troposphere originate from layers of the atmosphere about 4 to 5 km

thick. The pressures of the atmospheric layers contributing to the radiances observed by a water vapour channel vary with location to a much larger extent than for the temperature channels. This is because the thickness and central pressure of the layer observed depend heavily on the distribution of water vapour in the vertical. For instance, the layers observed in a given water vapour channel will be lowest when the upper troposphere is very dry. The water vapour channel radiances observed depend on the temperature of the water vapour. Therefore, water vapour distribution in the vertical can be derived only once suitable measurements of vertical temperature structure are available.

Limb-viewing satellite systems can provide measurements of atmospheric structure with higher vertical resolution than nadir-viewing systems; an example of this type of system is temperature and water vapour measurement derived from global positioning system (GPS) radio occultation. In this technique, vertical structure is measured along paths in the horizontal of at least 200 km (Kursinski and others, 1997).

Thus, the techniques developed for using satellite sounding information in numerical weather prediction models incorporate information from other observing systems, mainly radiosondes and aircraft. This information may be contained in an initial estimate of vertical structure at a given location, which is derived from forecast model fields or is found in catalogues of possible vertical structure based on radiosonde measurements typical of the geographical location or air mass type. In addition, radiosonde measurements are used to cross-reference the observations from different satellites or the observations at different view angles from a given satellite channel. The comparisons may be made directly with radiosonde observations or indirectly through the influence from radiosonde measurements on the vertical structure of numerical forecast fields.

Hence, radiosonde and satellite sounding systems are complementary observing systems and provide a more reliable global observation system when used together.

12.1.3.3 Maximum height of radiosonde observations

Radiosonde observations are used regularly for measurements up to heights of about 35 km. However, many observations worldwide will not be made to heights greater than about 25 km, because

of the higher cost of the balloons and gas necessary to lift the equipment to the lowest pressures. Temperature errors in many radiosonde systems increase rapidly at low pressures. Therefore, some of the available radiosonde systems are unsuitable for observing at the lowest pressures.

The problems associated with the contamination of sensors during flight and very long time-constants of sensor response at low temperatures and pressures limit the usefulness of radiosonde relative humidity measurements to the troposphere.

12.1.3.4 Accuracy requirements

This section and the next summarize the requirements for radiosonde accuracy and compare them with operational performance. A detailed discussion of performance and sources of errors is given in later sections.

The practical accuracy requirements for radiosonde observations are included in Annex 12.A. WMO (1970) describes a very useful approach to the consideration of the performance of instrument systems, which bears on the system design. Performance is based on observed atmospheric variability. Two limits are defined as follows:

- (a) The limit of performance beyond which improvement is unnecessary for various purposes;
- (b) The limit of performance below which the data obtained would be of negligible value for various purposes.

The performance limits derived by WMO (1970) for upper-wind and for radiosonde temperature, relative humidity and geopotential height measurements are contained in Tables 1 to 4 of Annex 12.B.

12.1.3.5 Temperature: Requirements and performance

Most modern radiosonde systems measure temperature in the troposphere with a standard error of between 0.1 and 0.5 K. This performance is usually within a factor of three of the optimum performance suggested in Table 2 of Annex 12.B. Unfortunately, standard errors larger than 1 K are still found in some radiosonde networks in tropical regions. The measurements at these stations fall outside the lower performance limit found in Table 2 of Annex 12.B, and are in the category where the measurements have negligible value for the stated purpose.

At pressures higher than about 30 hPa in the stratosphere, the measurement accuracy of most modern radiosondes is similar to the measurement accuracy in the troposphere. Thus, in this part of the stratosphere, radiosonde measurement errors are about twice the stated optimum performance limit. At pressures lower than 30 hPa, the errors in older radiosonde types increase rapidly with decreasing pressure and in some cases approach the limit where they cease to be useful for the stated purpose. The rapid escalation in radiosonde temperature measurement errors at very low pressure results from an increase in temperature errors associated with infrared and solar radiation coupled with a rapid increase in errors in the heights assigned to the temperatures. At very low pressures, even relatively small errors in the radiosonde pressure measurements will produce large errors in height and, hence, reported temperature (see section 12.1.3.7).

12.1.3.6 Relative humidity

Errors in modern radiosonde relative humidity measurements are at least a factor of two or three larger than the optimum performance limit for high relative humidity suggested in Table 3 of Annex 12.B, for the troposphere above the convective boundary layer. Furthermore, the errors in radiosonde relative humidity measurements increase as temperature decreases. For some sensor

types, errors at temperatures lower than -40°C may exceed the limit where the measurements have no value for the stated purpose.

12.1.3.7 Geopotential heights

Errors in geopotential height determined from radiosonde observations differ according to whether the height is for a specified pressure level or for the height of a given turning point in the temperature or relative humidity structure, such as the tropopause. The error, $\epsilon_z(t_1)$, in the geopotential height at a given time into flight is given by:

$$\epsilon_z(t_1) = \frac{R}{g} \int_{p_0}^{p_1} [\epsilon_T(p) - \frac{\delta T}{\delta p} \epsilon_p(p)] \frac{dp}{p} + \frac{R}{g} \int_{p_1}^{p_1 + \epsilon_p(p_1)} [T_v(p) + \epsilon_T(p) - \frac{\delta T}{\delta p} \epsilon_p(p)] \frac{dp}{p} \quad (12.1)$$

where p_0 is the surface pressure; p_1 is the true pressure at time t_1 ; $p_1 + \epsilon_p(p_1)$ is the actual pressure indicated by the radiosonde at time t_1 ; $\epsilon_T(p)$ and $\epsilon_p(p)$ are the errors in the radiosonde temperature and pressure measurements, respectively, as a function of pressure; $T_v(p)$ is the virtual temperature at pressure p ; and R and g are the gas and gravitational constants as specified in WMO (1988).

Table 12.1. Errors in geopotential height (m)

(Typical errors in standard levels, $\epsilon_z(p_s)$, and significant levels, $\epsilon_z(t_1)$, for given temperature and pressure errors, at or near specified levels. Errors are similar in northern and southern latitudes.)

	300 hPa	100 hPa	30 hPa	10 hPa
<i>Temperature error $\epsilon_T = 0.25$ K, pressure error $\epsilon_p = 0$ hPa</i>				
Standard and significant levels	9	17	26	34
<i>Temperature error $\epsilon_T = 0$ K, pressure error $\epsilon_p = -1$ hPa</i>				
25°N				
Standard level	3	12	-2	-24
Significant level	27	72	211	650
50°N summer				
Standard level	3	5	1	-20
Significant level	26	72	223	680
50°N winter				
Standard level	3	5	6	-4
Significant level	26	70	213	625

For a specified standard pressure level, p_s , the pressure of the upper integration limit in the height computation is specified and is not subject to the radiosonde pressure error. Hence, the error in the standard pressure level geopotential height reduces to:

$$\varepsilon_z(p_s) = \frac{R p_s}{g p_0} \left[\varepsilon_T(p) - \frac{\delta T}{\delta p} \varepsilon_p(p) \right] \frac{dp}{p} \quad (12.2)$$

Table 12.1 shows, the errors in geopotential height that are caused by radiosonde sensor errors for typical atmospheres. It shows that the geopotentials of given pressure levels can be measured quite well, which is convenient for the synoptic and numerical analysis of constant pressure surfaces. However, large errors may occur in the heights of significant levels such as the tropopause and other turning points, and other levels may be calculated between the standard levels.

Large height errors in the stratosphere resulting from pressure sensor errors of 2 or 3 hPa are likely to be of greatest significance in routine measurements in the tropics, where there are always significant temperature gradients in the vertical throughout the stratosphere. Ozone concentrations in the stratosphere also have pronounced gradients in the vertical, and height assignment errors will introduce significant errors into the ozonesonde reports at all latitudes.

The optimum performance requirements for the heights of isobaric surfaces in a synoptic network, as stated in Table 4 of Annex 12.B, place extremely stringent requirements on radiosonde measurement accuracy. For instance, the best modern radiosondes would do well if height errors were only a factor of five higher than the optimum performance in the troposphere and an order of magnitude higher than the optimum performance in the stratosphere.

12.1.4 Measurement methods

This section discusses radiosonde methods in general terms. Details of instrumentation and procedures are given in other sections.

12.1.4.1 Constraints on radiosonde design

Certain compromises are necessary when designing a radiosonde. Temperature measurements are found to be most reliable when sensors are exposed unprotected above the top of the radiosonde, but this also leads to direct exposure to

solar radiation. In most modern radiosondes, coatings are applied to the temperature sensor to minimize solar heating. Software corrections for the residual solar heating are then applied during data processing. Nearly all relative humidity sensors require some protection from rain. A protective cover or duct reduces the ventilation of the sensor and hence the speed of response of the sensing system as a whole. The cover or duct also provides a source of contamination after passing through cloud. However, in practice, the requirement for protection for relative humidity sensors from rain or ice is usually more important than perfect exposure to the ambient air. Thus, protective covers or ducts are usually used with a relative humidity sensor. Pressure sensors are usually mounted internally to minimize the temperature changes in the sensor during flight and to avoid conflicts with the exposure of the temperature and relative-humidity sensors.

Other important features required in radiosonde design are reliability, robustness, light weight and small dimensions. With modern electronic multiplexing readily available, it is also important to sample the radiosonde sensors at a high rate. If possible, this rate should be about once per second, corresponding to a minimum sample separation of about 5 m in the vertical. Since radiosondes are generally used only once, or not more than a few times, they must be designed for mass production at low cost. Ease and stability of calibration is very important, since radiosondes must often be stored for long periods (more than a year) prior to use. (Many of the most important Global Climate Observing System stations, for example, in Antarctica, are on sites where radiosondes cannot be delivered more than once per year.)

A radiosonde should be capable of transmitting an intelligible signal to the ground receiver over a slant range of at least 200 km. The voltage of the radiosonde battery varies with both time and temperature. Therefore, the radiosonde must be designed to accept battery variations without a loss of measurement accuracy or an unacceptable drift in the transmitted radio frequency.

12.1.4.2 Radio frequency used by radiosondes

The radio frequency spectrum bands currently used for most radiosonde transmissions are shown in Table 12.2. These correspond to the meteorological aids allocations specified by the International Telecommunication Union (ITU) Radiocommunication Sector radio regulations.

Table 12.2. Primary frequencies used by radiosondes in the meteorological aids bands

<i>Radio frequency band (MHz)</i>	<i>Status</i>	<i>ITU regions</i>
400.15 – 406	Primary	All
1 668.4 – 1 700	Primary	All

Note: Most secondary radar systems manufactured and deployed in the Russian Federation operate in a radio frequency band centred at 1 780 MHz.

The radio frequency actually chosen for radiosonde operations in a given location will depend on various factors. At sites where strong upper winds are common, slant ranges to the radiosonde are usually large and balloon elevations are often very low. Under these circumstances, the 400-MHz band will normally be chosen for use since a good communication link from the radiosonde to the ground system is more readily achieved at 400 MHz than at 1680 MHz. When upper winds are not so strong, the choice of frequency will, on average, be usually determined by the method of upper-wind measurement used (see Part I, Chapter 13). The frequency band of 400 MHz is usually used when navigational aid windfinding is chosen, and 1680 MHz when radiotheodolites or a tracking antenna are to be used with the radiosonde system.

The radio frequencies listed in Table 12.2 are allocated on a shared basis with other services. In some countries, the national radiocommunication authority has allocated part of the bands to other users, and the whole of the band is not available for radiosonde operations. In other countries, where large numbers of radiosonde systems are deployed in a dense network, there are stringent specifications on radio frequency drift and bandwidth occupied by an individual flight.

Any organization proposing to fly radiosondes should check that suitable radio frequencies are available for their use and should also check that they will not interfere with the radiosonde operations of the National Meteorological Service.

There is now strong pressures, supported by government radiocommunication agencies, to improve the efficiency of radio frequency use. Therefore, radiosonde operations will have to share with a greater range of users in the future. Wideband radiosonde systems occupying most of the available spectrum of the meteorological aids bands will become impracticable in many coun-

tries. Therefore, preparations for the future in most countries should be based on the principle that radiosonde transmitters and receivers will have to work with bandwidths of much less than 1 MHz in order to avoid interfering signals. Transmitter stability may have to be better than ± 5 kHz in countries with dense radiosonde networks, and not worse than about ± 200 kHz in most of the remaining countries.

National Meteorological Services need to maintain contact with national radiocommunication authorities in order to keep adequate radio frequency allocations and to ensure that their operations are protected from interference. Radiosonde operations will also need to avoid interference with, or from, data collection platforms transmitting to meteorological satellites between 401 and 403 MHz, with the downlinks from meteorological satellites between 1 690 and 1 700 MHz and with the command and data acquisition operations for meteorological satellites at a limited number of sites between 1 670 and 1 690 MHz.

12.2 RADIOSONDE ELECTRONICS

12.2.1 General features

A basic radiosonde design usually comprises three main parts as follows:

- (a) The sensors plus references;
- (b) An electronic transducer, converting the output of the sensors and references into electrical signals;
- (c) The radio transmitter.

In rawinsonde systems (see Part I, Chapter 13), there are also electronics associated with the reception and retransmission of radionavigation signals, or transponder system electronics for use with secondary radars.

Radiosondes are usually required to measure more than one meteorological variable. Reference signals are used to compensate for instability in the conversion between sensor output and transmitted telemetry. Thus, a method of switching between various sensors and references in a predetermined cycle is required. Most modern radiosondes use electronic switches operating at high speed with one measurement cycle lasting typically between 1 and 2 s. This rate of sampling allows the meteorological variables to be sampled at height intervals of between 5 and 10 m at normal rates of ascent.

12.2.2 Power supply for radiosondes

Radiosonde batteries should be of sufficient capacity to power the radiosonde for the required flight time in all atmospheric conditions. For radiosonde ascents to 5 hPa, radiosonde batteries should be of sufficient capacity to supply the required currents for up to three hours, given that ascents may often be delayed and that flight times may be as long as two hours. Three hours of operation would be required if descent data from the radiosonde were to be used. Batteries should be as light as practicable and should have a long storage life. They should also be environmentally safe following use. Many modern radiosondes can tolerate significant changes in output voltage during flight. Two types of batteries are in common use, the dry-cell type and water-activated batteries.

Dry batteries have the advantage of being widely available at very low cost because of the high volume of production worldwide. However, they may have the disadvantage of having limited shelf life. Also, their output voltage may vary more during discharge than that of water-activated batteries.

Water-activated batteries usually use a cuprous chloride and sulphur mixture. The batteries can be stored for long periods. The chemical reactions in water-activated batteries generate internal heat, reducing the need for thermal insulation and helping to stabilize the temperature of the radiosonde electronics during flight. These batteries are not manufactured on a large scale for other users. Therefore, they are generally manufactured directly by the radiosonde manufacturers.

Care must be taken to ensure that batteries do not constitute an environmental hazard once the radiosonde falls to the ground after the balloon has burst.

12.2.3 Methods of data transmission

12.2.3.1 Radio transmitter

A wide variety of transmitter designs are in use. Solid-state circuitry is mainly used up to 400 MHz and valve (cavity) oscillators may be used at 1 680 MHz. Modern transmitter designs are usually crystal-controlled to ensure a good frequency stability during the sounding. Good frequency stability during handling on the ground prior to launch and during flight are important. At 400 MHz, widely used radiosonde types are expected to have a trans-

mitter power output lower than 250 mW. At 1 680 MHz the most widely used radiosonde type has a power output of about 330 mW. The modulation of the transmitter varies with radiosonde type. It would be preferable in future that radiosonde manufacturers standardize the transmission of data from the radiosonde to the ground station. In any case, the radiocommunication authorities in many regions of the world will require that radiosonde transmitters meet certain specifications in future, so that the occupation of the radiofrequency spectrum is minimized and other users can share the nominated meteorological aids radiofrequency bands (see section 12.1.4.2).

12.3 TEMPERATURE SENSORS

12.3.1 General requirements

The best modern temperature sensors have a speed of response to changes of temperature which is fast enough to ensure that systematic bias from thermal lag during an ascent remains less than 0.1 K through any layer of depth of 1 km. At typical radiosonde rates of ascent, this is achieved in most locations with a sensor time-constant with a response faster than 1 s in the early part of the ascent. In addition, the temperature sensors should be designed to be as free as possible from radiation errors introduced by direct or backscattered solar radiation or heat exchange in the infrared. Infrared errors can be avoided by using sensor coatings that have low emissivity in the infrared. In the past, the most widely used white sensor coatings had high emissivity in the infrared. Measurements by these sensors were susceptible to significant errors from infrared heat exchange (see section 12.8.3.3).

Temperature sensors also need to be sufficiently robust to withstand buffeting during launch and sufficiently stable to retain accurate calibration over several years. Ideally, the calibration of temperature sensors should be sufficiently reproducible to make individual sensor calibration unnecessary. The main types of temperature sensors in routine use are thermistors (ceramic resistive semiconductors), capacitive sensors, bimetallic sensors and thermocouples.

The rate of response of the sensor is usually measured in terms of the time-constant of response, τ . This is defined (as in section 1.6.3 in Part I, Chapter 1) by:

$$dT_e/dt = 1/\tau \cdot (T_e - T) \quad (12.3)$$

where T_e is the temperature of the sensor and T is the true air temperature.

Thus, the time-constant is defined as the time required to respond by 63 per cent to a sudden change of temperature. The time-constant of the temperature sensor is proportional to thermal capacity and inversely proportional to the rate of heat transfer by convection from the sensor. Thermal capacity depends on the volume and composition of the sensor, whereas the heat transfer from the sensor depends on the sensor surface area, the heat transfer coefficient and the rate of the air mass flow over the sensor. The heat transfer coefficient has a weak dependence on the diameter of the sensor. Thus, the time-constants of response of temperature sensors made from a given material are approximately proportional to the ratio of the sensor volume to its surface area. Consequently, thin sensors of large surface area are the most effective for obtaining a fast response. The variation of the time-constant of response with the mass rate of air flow can be expressed as:

$$\tau = \tau_0 \cdot (\rho \cdot v)^{-n} \tag{12.4}$$

where ρ is the air density, v the air speed over the sensor, and n a constant.

Note: For a sensor exposed above the radiosonde body on an outrigger, v would correspond to the rate of ascent, but the air speed over the sensor may be lower than the rate of ascent if the sensor were mounted in an internal duct.

The value of n varies between 0.4 and 0.8, depending on the shape of the sensor and on the nature of the airflow (laminar or turbulent). Representative values of the time-constant of response of the older types of temperature sensors are shown in Table 12.3 at pressures of 1 000, 100 and 10 hPa, for a rate of ascent of 5 m s⁻¹. These values were

Table 12.3. Typical time-constants of response of radiosonde temperature sensors

Temperature sensor	<i>T</i> at	<i>T</i> at	<i>T</i> at
	1 000 hPa(s)	100 hPa (s)	10 hPa (s)
Rod thermistor, diameter 1.3 mm	3	8	21
Modern bead thermistor (general values)	< 1	< 3	< 7
Bead thermocapacitor, diameter 1.2 mm	2.5	6	15
Wire thermocapacitor, diameter 0.1 mm	0.4	1	2.5
Bimetallic sensor	5 – 8	12 – 20	Not available

derived from a combination of laboratory testing and comparisons with very-fast response sensors during ascent in radiosonde comparison tests. As noted above, modern capacitive sensors and bead thermistors have time-constants of response faster than 1 s at 1 000 hPa.

12.3.2 Thermistors

Thermistors are usually made of a ceramic material whose resistance changes with temperature. The sensors have a high resistance that decreases with absolute temperature. The relationship between resistance, R , and temperature, T , can be expressed approximately as:

$$R = A \cdot \exp (B/T) \tag{12.5}$$

where A and B are constants. Sensitivity to temperature changes is very high, but the response to temperature changes is far from linear since the sensitivity decreases roughly with the square of the absolute temperature. As thermistor resistance is very high, typically tens of thousands of ohms, self-heating from the voltage applied to the sensor is negligible. It is possible to manufacture very small thermistors and, thus, fast rates of response can be obtained. Solar heating of a modern chip thermistor is around 1°C at 10 hPa.

12.3.3 Thermocapacitors

Thermocapacitors are usually made of a ceramic material whose permittivity varies with temperature. The ceramic used is usually barium-strontium titanate. This ferro-electric material has a temperature coefficient of permittivity of the order of 10⁻² per °C. The temperature coefficient is positive at temperatures below the Curie point and negative at temperatures above the Curie point. Sensors can now have a diameter of about 0.1 mm. This measures the change in capacitance between two fine platinum wires separated by a glass ceramic (see Turtiainen, Tammela and Stuns, 1995). This sensor gives improved speed of response, and solar heating errors are less than 1°C at 10 hPa.

12.3.4 Thermocouples

Copper-constantan thermocouple junctions are also used as a temperature sensor in one national radiosonde (WMO, 1989a). Wires of 0.05 mm in diameter are used to form the external thermocouple junction and these provide a sensor with a very fast response. The relationship between the

thermal electromotive force and the temperature difference between the sensor and its reference is an established physical relationship. The thermocouple reference is mounted internally within the radiosonde in a relatively stable temperature environment. A copper resistor is used to measure this reference temperature. In order to obtain accurate temperatures, stray electromotive force introduced at additional junctions between the sensor and the internal references must also be compensated.

12.3.5 Exposure

Radiosonde temperature sensors are best exposed in a position above the main body of the radiosonde (below the body of a dropsonde). Thus, air heated or cooled by contact with the radiosonde body or sensor supports cannot subsequently flow over the sensor. This is usually achieved by mounting the sensor on an arm or outrigger that holds the sensor in the required position during flight. For long-term stability of operation, this position needs to be reproducible and must not vary from flight to flight. For good exposure at low pressures, the supports and electrical connections to the sensor should be thin enough so that heating or cooling errors from thermal conduction along the connections are negligible.

With this method of exposure, the radiosonde temperature sensors are exposed directly to solar radiation and to the infrared environment in the atmosphere. The sensors receive solar radiation during daytime soundings and will exchange long-wave radiation with the ground and the sky at all times. The magnitude of radiation errors is only weakly dependent on the size and shape of the sensors, since convective heat transfer coefficients are only weakly dependent on sensor size. Thus, small radiation errors may be obtained with small sensors, but only when the sensor coating is chosen to provide low absorption for both solar and long-wave radiation. The required coating can be achieved by the deposition of a suitable thin metallic layer. Many white paints have high absorption in the infrared and are not an ideal coating for a radiosonde sensor.

An additional consequence of exposing the temperature sensor above the radiosonde body is that, when ascending during precipitation or through cloud, the sensor may become coated with water or ice. It is extremely important that the sensor design sheds water and ice efficiently. First, evaporation of water or ice from the sensor when emerging from a cloud into drier layers will

cool the sensor below true ambient temperature. Secondly, the absorptivity in the infrared of a temperature sensor that remains coated with ice throughout a flight differs from usual. Thus, an abnormal systematic bias from infrared heat exchange will be introduced into the iced sensor measurements, particularly at low pressures.

Bimetallic sensors and associated supports absorb too much radiation in daylight to be exposed unprotected above the radiosonde. Thus, this type of sensor has to be protected by a radiation shield. The shield should not allow radiation to reach the sensor directly or after multiple reflections. The internal surfaces of the shield should remain at temperatures close to the true atmospheric temperature and should not influence the temperature of the air incident on the sensor. The shielding should not reduce the ventilation of the temperature sensor to any extent and should not trap water or ice when ascending through cloud and precipitation.

While acceptable radiation shield performance may be achieved at high pressures, it becomes increasingly difficult to fulfil all these requirements at low pressure. Good absorption of incoming radiation requires a blackened internal surface on the shield, but this leads to strong coupling of these surfaces to external solar and infrared radiation fields. At low pressures, this results in substantial heating or cooling of the internal surfaces of the shields relative to the ambient atmospheric temperature. Therefore, reliable temperature measurements using radiation shields rapidly become impracticable at the lowest pressures. A compromise shield design might consist of two polished, thin aluminium cylinders arranged coaxially with a spacing of 1 or 2 cm.

12.4 PRESSURE SENSORS

12.4.1 General aspects

Radiosonde pressure sensors must sustain accuracy over a very large dynamic range from 3 to 1 000 hPa, with a resolution of 0.1 hPa over most of the range and a resolution of 0.01 hPa for pressures less than 100 hPa. Changes in pressure are usually identified by a small electrical or mechanical change. For instance, the typical maximum deflection of an aneroid capsule is about 5 mm, so that the transducer used with the sensor has to resolve a displacement of about 0.5 μm . Changes

in calibration caused by sensor temperature changes during the ascent must also be compensated. These temperature changes may be as large as several tens of degrees, unless the pressure sensor is mounted in a stabilized environment.

Thus, pressure sensors are usually mounted internally within the radiosonde body to minimize the temperature changes that occur. In some cases, the sensor is surrounded by water bags to reduce cooling. When water-activated batteries are used, the heat generated by the chemical reaction in the battery is used to compensate the internal cooling of the radiosonde. However, even in this case, the radiosonde design needs to avoid generating temperature gradients across the sensor and its associated electrical components. If a pressure sensor has an actively controlled temperature environment, the sensor assembly should be mounted in a position on the radiosonde where heat contamination from the pressure sensor assembly cannot interfere with the temperature or relative humidity measurements.

The pressure sensor and its transducer are usually designed so that sensitivity increases as pressure decreases. The time-constant of response of radiosonde pressure sensors is generally very small, and errors from sensor lag are not significant.

12.4.2 Aneroid capsules

Aneroid capsules have been used as the pressure sensor in the majority of radiosondes. In the older radiosonde designs, the capsules were usually about 50 to 60 mm in diameter. The sensors are made from a metal with an elastic coefficient that is independent of temperature. The measurement of the deflection of the aneroid capsule can be achieved either by an external device requiring a mechanical linkage between the capsule and the radiosonde transducer or by an internal device (see section 12.4.3).

Aneroid sensitivity depends mainly on the effective surface area of the capsule and its elasticity. Capsules can be designed to give a deflection that is linearly proportional to the pressure or to follow some other law, for example, close to a logarithmic dependence on pressure. The long-term stability of the capsule calibration is usually improved by seasoning the capsules. This is achieved by exercising the capsules through their full working range over a large number of cycles in pressure and temperature.

When the aneroid is used with a mechanical linkage to a transducer, the sensor usually suffers from a hysteresis effect of about 1 to 2 hPa. This hysteresis must be taken into account during the sensor calibration. The change in pressure during calibration must be of the same sense as that found in actual sounding conditions. The mechanical linkage to the radiosonde transducer often consists of a system amplifying the movement of the capsule to a pointer operating switch contacts or resistive contacts. A successful operation requires that friction be minimized to avoid both discontinuous movements of the pointer and hysteresis in the sensor system.

12.4.3 Aneroid capsule (capacitive)

Many modern radiosonde designs use aneroid capsules of smaller diameter (30 mm or less in diameter) with the deflection of the capsule directly measured by an internal capacitor. A parallel plate capacitor used for this purpose is formed by two plates each fixed directly to one side of the capsule. The capacitance, C , is then:

$$C = \epsilon \cdot S/e \quad (12.6)$$

where S is the surface area of each plate, e is the distance between the plates and ϵ is the dielectric constant. As e is a direct function of the deflection of the capsule, the capacitance C is a direct electrical measurement of the deflection. In many radiosonde sensors, each capacitor plate is fixed to the opposite side of the capsule by mounts passing through holes in the other plate. With this configuration, e decreases when the pressure lowers. The sensitivity of the capacitive sensor is:

$$- \epsilon \cdot S/e^2 \cdot de/dp \quad (12.7)$$

This will be greatest when e is small and the pressure is smallest. The capacitive sensor described is more complicated to manufacture but is best suited for upper-air measurements, as the sensitivity can be 10 times greater at 10 hPa than at 1 000 hPa. The value of the capacitance is usually close to 6 pF.

Capacitive aneroid capsules are usually connected to a resistance-capacitance electronic oscillator with associated reference capacitors. This arrangement needs to measure very small variations of capacity (for example, 0.1 per cent change in a maximum of 6 pF) without any significant perturbation of the oscillator from changes in temperature, power supply or ageing. Such high stability in an oscillator is difficult to achieve at a low price. However, one solution is to multiplex the input to the oscillator

between the pressure sensor and two reference capacitors. A reference capacitor C_1 is connected alone to the oscillator, then in parallel with C_p , the pressure sensor capacitor, and then in parallel with a second reference C_2 to provide a full-scale reference.

The calibration of an aneroid capacitive sensor will usually have significant temperature dependence. This can be compensated either by referencing to an external capacitor which has a temperature coefficient of similar magnitude or during data processing in the ground system using calibration coefficients from factory calibrations. The correction applied during processing will depend on the internal temperature measured close to the pressure sensor. In practice, both of these compensation techniques may be necessary to achieve the required accuracy.

12.4.4 Silicon sensors

Following rapid developments in the use of silicon, reliable pressure sensors can now be made with this material. A small cavity is formed from a hole in a thick semiconductor layer. This hole is covered with a very thin layer of silicon, with the cavity held at a very low pressure. The cavity will then perform as a pressure sensor, with atmospheric pressure sensed from the deflection of the thin silicon cover.

A method of detecting the deflection of the silicon is to use a capacitive sensor. In this case, the thin silicon layer across the cavity is coated with a thin metallic layer, and a second metallic layer is used as a reference plate. The deflection of the silicon cover is measured by using the variation in the capacitance between these two layers. This type of sensor has a much lower temperature dependence than the strain gauge sensor and is now in widespread use. Because the sensor is very small, it is possible to avoid the calibration errors of the larger capacitive aneroid sensors introduced by changes in temperature gradients across the aneroid sensor and associated electronics during an ascent.

12.4.5 Use of geometric height observations instead of pressure sensor observations

12.4.5.1 General

Geometric height observations can now be provided by the types of GPS radiosondes that decode global positioning satellite signals, as

opposed to early GPS radiosondes that did not decode the signals. The geometric height observations are accurate enough (between 10 and 20 m) to be used to compute pressure at a given time into flight, using surface pressure and temperature and relative humidity observations. The computed pressures will be more accurate than measurements provided by the best radiosonde pressure sensors in the stratosphere.

When a radar is in use for windfinding, radar height measurements may also provide an alternative to the use of a radiosonde pressure sensor, but these heights will not be as accurate as those obtainable from the GPS radiosondes. The errors in radar height data depend upon the installation and calibration of individual radars. Thus, it is much more difficult to obtain consistency from station to station in geopotential height and pressure measurements in a national upper-air network that depends on radar height measurements than if the national network uses GPS heights or pressure sensors. The elimination of the pressure sensor from GPS radiosondes should provide a considerable saving in terms of the cost of the radiosondes, but it is also necessary to check user requirements for the non-hydrostatic numerical weather prediction models that are being introduced, since direct measurements of pressure and geopotential height in the troposphere may be of some advantage when hydrostatic balance does not represent atmospheric conditions.

12.4.5.2 Method of calculation

The algorithms for computing geometric height from windfinding radar observations of slant range and elevation and for the conversion of geometric heights to geopotential heights are included in WMO (1986). The actual algorithm used with secondary radar systems in the Russian Federation can be found in WMO (1991). If radar height observations are used as a replacement for pressure sensor observations, the heights need to be corrected for the effects of the Earth's curvature and radio-wave refraction before pressure is computed. Corrections for refraction can be made using seasonal averages of atmospheric profiles, but optimum pressure accuracy might require height corrections for the conditions encountered in individual flights.

12.4.5.3 Sources of radar height errors

The effect of radar observational errors upon windfinding is considered in Part I, Chapter 13. However, for radar heights, (random and systematic) errors in

elevation are much more significant than for winds. Systematic bias in slant range is also more critical for height than for wind measurements. Therefore, radars providing satisfactory wind measurements often have errors in elevation and slant range that prevent best quality height (and hence pressure) measurements.

Small but significant systematic errors in elevation may arise from a variety of sources as follows:

- (a) Misalignment of the axes of rotation of azimuth and elevation of the radar during manufacture. If this is to be avoided, the procurement specification must clearly state the accuracy required;
- (b) Errors in levelling the radar during installation and in establishing the zero elevation datum in the horizontal;
- (c) Differences between the electrical and mechanical axes of the tracking aerials, possibly introduced when electrical components of the radar are repaired or replaced.

Errors may arise from errors introduced by the transducer system measuring the radar elevation angle from the mechanical position of the tracking aerial.

Systematic errors in slant range may arise from the following:

- (a) A delay in triggering the range-timing circuit or incorrect compensation for signal delay in the radar detection electronics;
- (b) Error in the frequency of the range calibrator.

Thus, radiosonde systems operating without pressure sensors and relying solely on radar height measurements require frequent checks and adjustments of the radars as part of routine station maintenance. These systems are not suitable for use in countries where technical support facilities are limited.

12.5 RELATIVE HUMIDITY SENSORS

12.5.1 General aspects

The successful operation of a radiosonde relative humidity sensor relies on a rapid exchange of water molecules between the sensor and the atmosphere. If a relative humidity sensor is to provide reliable measurements throughout the troposphere it must be able to resolve to 1 per cent of saturated water vapour pressures from 46 hPa at 30°C down to at least 0.06 hPa at –50°C. At temperatures below 0°C, relative humidity sensors should be calibrated to report relative humidity with respect to a water surface.

Newly developed relative humidity sensors agree fairly closely at temperatures higher than about –70°C and show a similar relative humidity structure in the vertical. Satisfactory relative humidity sensor operation is often extremely difficult to obtain at very low temperatures and pressures. If the free exchange of water molecules between the sensor and the atmosphere is hampered as the temperature falls during an ascent, contamination of the sensor from high water vapour concentrations earlier in the ascent may cause substantial systematic bias in sensor measurements at the lowest temperatures.

The time-constant of response of a relative humidity sensor increases much more rapidly during a radiosonde ascent than the time-constant of response of the temperature sensor. Table 12.4 provides approximate values of the time-constant of response for three sensor types. These values represent the time-constant of response for changes between about 70 and 30 per cent relative humidity. The time-constants of response of the goldbeater's skin sensors for a given temperature are much larger when exposed to very high or very low relative humidity.

Table 12.4. Time-constant of response of relative humidity sensor, τ (in seconds), for a range of temperatures

Sensor	τ at 20°C	τ at 0°C	τ at –20°C	τ at –30°C	τ at –60°C
Goldbeater's skin	6	20	100	200	Not usable
Carbon hygistor	0.3	1.5	9	20	Not reliable
Thin-film capacitor	0.3	1.5	9	20	60 – 200 ^a

^a See results in Miloshevich and others (2004).

Carbon hygistor sensors are usually mounted in a protective duct in the radiosonde, and thin-film sensors are usually mounted on an outrigger from the radiosonde and protected with a cover against precipitation. Recent radiosonde comparison tests did not identify any significant difference in the time-constants of response of the most widely used thin-film capacitor sensors at temperatures higher than -70°C .

Thin-film capacitors usually have much shorter time-constants of response than the carbon hygistors at temperatures lower than -40°C and are becoming the most common relative humidity sensor type in nearly all modern radiosondes. The thin-film capacitors may have a time-constant of response of a couple of minutes at temperatures as low as -60°C .

The calibration of most relative humidity sensors is temperature dependent. The correction for this dependence must be applied during data processing by the ground system if the accuracy claimed for the sensor at room temperatures in the laboratory is to be obtained throughout most of the troposphere.

Most relative humidity sensors require protection from contamination by precipitation early in the ascent. The evaporation of contamination from protective covers, internal duct surfaces or sensor supports early in flight may also cause errors in the reported relative humidity.

None of the operational radiosonde relative humidity sensors are reliable enough for good-quality relative humidity measurements at low temperatures and low pressures in the stratosphere.

12.5.2 Thin-film capacitors

Capacitive thin-film sensors are now used by most modern radiosonde designs. The first widely used sensor relied on the variation of the dielectric constant of a polymer film with ambient water vapour pressure. The lower electrode of the capacitor was formed by etching a metal-coated glass plate (typically 4 mm square and 0.2 mm thick) and then coating this with an active polymer approximately $1\ \mu\text{m}$ thick. The upper electrode was vacuum-evaporated onto the polymer surface and was permeable to water vapour. Sensor capacitance was a nearly linear function of relative humidity; temperature dependence of calibration was small. Subsequent laboratory investigations of the sensor performance showed that hysteresis was relatively small (less than 3 per cent relative humidity) as long as the sensor was not contaminated by precipitation on the electrodes.

After several years of operational use, a thin coating was added to the upper electrode to improve stability of performance in wet ascents. The calibration of the A-Humicap used with the Vaisala RS80 radiosonde gave a low bias at very low temperatures because the non-linearity of the true calibration curve became significant at these temperatures. Corrections for this effect have been proposed by Miloshevich and others (2001) and Leiterer and others (2005).

A newer sensor (H-Humicap) used a different polymer that was more stable when used in wet conditions. This sensor required a higher order polynomial calibration than the earlier design, but this data processing can now be accommodated by operational radiosonde ground systems that are mostly fully automated. Although this sensor was more stable in wet conditions, it still suffered from contamination after passing through thick cloud at low levels.

In the most recent Vaisala relative humidity sensor design, the contamination from cloud is eliminated by heating the relative humidity sensor periodically during flight (Paukkunen, 1995). Optimum performance from thin-film sensors requires careful calibration of sensor performance in the factory over the whole range of temperatures encountered in the troposphere where measurements will be reported. Some details of the differences in response of these sensors were published in Miloshevich and others (2004). The differences are most readily noted at very low temperatures near the tropopause.

Since 1995 users have recognized that the two main capacitive sensors in use (Vaisala A-Humicap and Vaisala H-Humicap) could have significant dry bias because of chemical contamination of the sensors, for example, see Wang and others (2002). Radiosondes used shortly after having been delivered from the factory would have correct calibration, but if stored for a year would often show a large dry bias when used. This could be as large as 11 per cent low at high relative humidity. The chemical contamination originated from styrene gas emitted from the radiosonde body. Monitoring showed that the rate of contamination varied from time to time in the radiosondes used operationally. This chemical contamination continued to a varying extent even after Vaisala redesigned the packaging of the RS80 radiosonde. With new Vaisala sensors which can be pulse heated, any chemical contamination is driven off by heating the sensor during the ground check procedures before the radiosonde is launched.

12.5.3 Carbon hygristors

Carbon hygristor sensors are made by suspending finely divided carbon particles in a hygroscopic film. A modern version of the sensor consists of a polystyrene strip (of approximately 1 mm thick, 60 mm long and 18 mm wide) coated with a thin hygroscopic film containing carbon particles. Electrodes are coated along each side of the sensor. Changes in the ambient relative humidity lead to dimensional changes in the hygroscopic film such that the resistance increases progressively with humidity. The resistance at 90 per cent relative humidity is about 100 times as large as the resistance at 30 per cent relative humidity. Corrections can be applied for temperature dependence during data processing. The sensors are usually mounted on a duct within the radiosonde body to minimize the influence of precipitation wash and to prevent direct solar heating of the sensor.

The successful implementation of this sensor type requires a manufacturing process that is well controlled so that the temperature dependence of the sensors does not have to be determined individually. The hygristors will normally be subjected to many seasoning cycles over a range of relative humidity at room temperatures in the factory to reduce subsequent hysteresis in the sensor during the radiosonde ascent. The resistance of the sensor can be adjusted to a standard value during manufacture by scratching part of the carbon film. In this case, the variables can be issued with the appropriate standard resistance value for the specified conditions, and the sensors can be made interchangeable between radiosondes without further calibration. The sensor must be kept sealed until just before it is used, and the hygroscopic surface must not be handled during insertion into the sensor mount on the radiosonde. It is difficult to make sensors that have stable calibration at high humidity, and the reproducibility of the sensor measurements at low humidity is often poor.

12.5.4 Goldbeater's skin sensors

Goldbeater's skin (beef peritoneum) is still used in major networks. The length of a piece of goldbeater's skin changes by between 5 to 7 per cent for a change in humidity from 0 to 100 per cent. While useful measurements can be obtained at temperatures higher than -20°C , sensor response becomes extremely slow at temperatures lower than this (see Table 12.4). Goldbeater's skin sensors also suffer

from significant hysteresis following exposure to low humidities.

The goldbeater's skin used for humidity variables should be single-ply and unvarnished, with a thickness of about 0.03 mm. The skin should be mounted with a tension of about 20 g cm^{-1} width and should be seasoned for several hours, in a saturated atmosphere, while subjected to this tension. To minimize hysteresis, it is advisable to condition the variable by keeping it in a saturated atmosphere for 20 min both before calibration and before use. Calibration should be carried out during a relative humidity cycle from damp to dry conditions. The variable must be protected from rain during flight.

The time-constant of response of the sensor is much higher than the values quoted in Table 12.4 at very high and very low humidities (McIlveen and Ludlam, 1969). Thus, it is difficult to avoid bias in goldbeater's skin measurements during an ascent (low bias at high humidity, high bias at low humidity) even in the lower troposphere.

12.5.5 Exposure

Rapid changes in relative humidity of an amplitude greater than 25 per cent are common during radiosonde ascents. Accurate measurements of these changes are significant for users. Accurate measurements require that the humidity sensor is well ventilated, but the sensor also needs to be protected as far as possible from the deposition of water or ice onto the surface of the sensor or its supports, and also from solar heating.

Thus, the smaller relative humidity sensors, such as thin-film capacitors, are mounted on an external outrigger. The sensor may be covered by a small protective cap, or the sensors may be heated periodically to drive off contamination from water or ice in cloud or fog. The design of the protective cap may be critical, and it is essential to ensure that the cap design is such that the humidity sensor is well ventilated during the radiosonde ascent.

The larger sensors are usually mounted in an internal duct or a large protective duct on the top or side of the radiosonde body. The duct design should be checked to ensure that air flow into the duct guarantees adequate sensor ventilation during the ascent. The duct should also be designed to shed ice or water, encountered in cloud or heavy precipitation, as quickly as

possible. The duct should protect the sensor from incident solar radiation and should not allow significant backscattering of solar radiation onto the sensor. Particular care is required in duct design if contamination in upper cloud is to be avoided. Protective covers or duct coatings should not be hygroscopic.

12.6 GROUND STATION EQUIPMENT

12.6.1 General features

The detailed design of the ground equipment of a radiosonde station will depend on the type of radiosonde that is used. However, the ground station will always include the following:

- (a) An aerial and radio receiver for receiving the signals from the radiosonde;
- (b) Equipment to decode the modulation of the radiosonde signals and to convert the signals to meteorological units;
- (c) Equipment to present the meteorological measurements to the operator so that the necessary messages can be transmitted to users, as required.

Other equipment may be added to provide wind measurements when required (for example, radar interface, Loran-C or GPS trackers).

The output of the decoder should usually be input to a computer for archiving and subsequent data processing and correction.

Modern ground station systems can be either purchased as an integrated system from a given manufacturer, or may be built up from individual modules supplied from a variety of sources. If maintenance support will mainly be provided by the manufacturer or its agents, and not by the operators, an integrated system may be the preferred choice. A system composed of individual modules may be more readily adapted to different types of radiosonde. This could be achieved by adding relevant decoders, without the extra cost of purchasing the remainder of the integrated ground system offered by each manufacturer. A modular type of system may be the preferred option for operators with their own technical and software support capability, independent of a given radiosonde manufacturer. Systems built from modules have encountered problems in the last 10 years because of the complexity of testing such systems and the problems introduced when

adapting manufacturers' standard correction software to non-standard use by another processing system.

Note: The rate of development in modern electronics is such that it will prove difficult for manufacturers to provide in-depth support to particular integrated systems for longer than 10 to 15 years. Thus replacement cycles for integrated ground systems should be taken as about 10 years when planning long-term expenditure.

12.6.2 Software for data processing

Satisfactory software for a radiosonde ground system is much more complicated than that needed merely to evaluate, for example, standard level geopotential heights from accurate data. Poor quality measurements need to be rejected and interpolation procedures developed to cope with small amounts of missing data. There is a serious risk that programmers not thoroughly versed in radiosonde work will make apparently valid simplifications that introduce very significant errors under some circumstances. For instance, if reception from the radiosonde is poor, it is dangerous to allow too much interpolation of data using mathematical techniques that will become unstable when data quality is generally poor, but will be quite stable when data quality is generally good. Furthermore, certain problems with signal reception and pressure errors near the launch are often compensated by adjusting the time associated with incoming data. This may not cause significant errors to reported measurements, but can make it almost impossible to check radiosonde sensor performance in radiosonde comparison tests.

Thus, it is essential to use the services of a radiosonde specialist or consultant to provide overall control of the software design.¹ The specialist skills of a professional programmer will usually be necessary to provide efficient software. This software will include the display and interactive facilities for the operator which are required for operational use. The software must be robust and not easily crashed by inexpert operators. In the last decade, most software for commercial radiosonde ground systems has required at least two or three years of development in collaboration with testing by National Meteorological Services. This testing was performed by highly skilled operators and test

1 As recommended by the Commission for Instruments and Methods of Observation at its twelfth session (1998), through Recommendation 2 (CIMO-XII).

staff, until the software had become thoroughly reliable in operation. The ground system software was then suitable for use by operators without any significant specialized computing skills.

The software in the ground system should be well documented and should include clear descriptions of the algorithms in use.² The overall system should be designed to allow sounding simulations for testing and comparison purposes. It is proposed that sets of known raw pressure, temperature and humidity data records should be used to check the reliability of newly developed software. Software errors are often the limiting factors in the accuracy of data reports from the better radiosonde types.

12.7 RADIOSONDE OPERATIONS

12.7.1 Control corrections immediately before use

It is recommended that radiosonde measurement accuracy should always be checked in a controlled environment before the radiosonde is launched. These control checks should be made when the radiosonde is ready for flight, and should take place a few minutes before release. The aim is to prevent the launch of faulty radiosondes. A further aim is to improve calibration accuracy by adjusting for small changes in calibration that may have occurred when the radiosonde was transported to the launch site and during storage.

These control checks are usually performed indoors. They can be conducted in a ventilated chamber with a reference temperature and relative humidity sensors of suitable accuracy to meet user specifications. Relative humidity can then be checked at ambient humidity and lower and higher humidities, if necessary. If no reference psychrometer is available, known humidity levels can be generated by saturated saline solutions or silica gel.

The differences between the radiosonde measurements and the control readings can be used to adjust the calibration curves of the sensors prior to flight. The sensors used for controlling the radiosonde must be checked regularly in order to avoid long-term drifts in calibration errors. A suitable software adjustment of radiosonde calibration normally improves the

reproducibility of the radiosonde measurements in flight to some extent. The type of adjustment required will depend on the reasons for calibration shift following the initial calibration during manufacture and will vary with radiosonde type.

If there are large discrepancies relative to the control measurements, the radiosonde may have to be rejected as falling outside the manufacturer's specification and returned for replacement. Maximum tolerable differences in ground checks need to be agreed upon with the manufacturer when purchasing the radiosondes.

It is also wise to monitor the performance of the radiosonde when it is taken to the launch area. The reports from the radiosonde should be checked for compatibility with the surface observations at the station immediately before launch.

In view of the importance of this stage of the radiosonde operation, the Commission for Instruments and Methods of Observation recommends that:³

- (a) The performance of the radiosonde pressure, temperature and relative humidity sensors should be checked in a controlled environment, such as a calibration cabinet or baseline check facility prior to launch;
- (b) The baseline check should be automated as far as possible to eliminate the possibility of operator error;
- (c) The temperature and relative humidity observations should also be checked against the standard surface temperature and relative humidity observations at the station immediately before the launch;
- (d) The sensors used as the reference should be at least as accurate as the radiosonde sensors and be calibrated regularly according to the manufacturer's instructions.

12.7.2 Deployment methods

Radiosondes are usually carried by balloons rising with a rate of ascent of between 5 and 8 m s⁻¹, depending on the specifications and characteristics of the balloon in use (see Part II, Chapter 10). These rates of ascent allow the measurements to be completed in a timely fashion – i.e. about 40 min to reach 16 km and about 90 min to reach heights above 30 km – so that the information can be relayed quickly to the forecast centres. The designs

² See Recommendation 2 (CIMO-XII).

³ As recommended by the Commission for Instruments and Methods of Observation at its eleventh session, held in 1994, through Recommendation 9 (CIMO-XI).

and positioning of the temperature and relative humidity sensors on the radiosonde are usually intended to provide adequate ventilation at an ascent rate of about 6 m s^{-1} . Corrections applied to temperature for solar heating errors will usually only be valid for the specified rates of ascent.

A radiosonde transmits information to a ground station that is usually at a fixed location. However, advances in modern technology mean that fully automated radiosonde ground systems are now very small. Therefore, the ground systems are easily deployed as mobile systems on ships or in small vans or trailers on land.

Dropsondes deployed from research aircraft use parachutes to slow the rate of descent. Temperature sensors are mounted at the bottom of the dropsonde. Rates of descent are often about 12 m s^{-1} to allow the dropsonde measurement to be completed in about 15 min. The high descent rate allows one aircraft to deploy sufficient dropsondes at a suitable spacing in the horizontal for mesoscale research (less than 50 km). The dropsonde transmissions will be received and processed on the aircraft. Systems under development will be able to take and transmit direct readings and operate automatically under programme control. Systems are also under development to use remotely piloted vehicles to deploy dropsondes.

12.7.3 Radiosonde launch procedures

Once a radiosonde is prepared for launch, the meteorological measurements should be checked against surface measurements either in an internal calibration chamber or externally against surface observations in a ventilated screen. This is necessary since the radiosonde may have been damaged during shipment from the factory, manufacture may have been faulty, or sensor calibrations may have drifted during storage. Radiosondes producing measurements with errors larger than the limits specified in the procurement contract should be returned to the manufacturer for replacement.

Radiosondes are usually launched by hand or using a launch aid from a shed or shelter. The complexity of the shed and the launch procedures will depend on the gas used to fill the balloon (see Part II, Chapter 10) and on the strength and direction of the surface winds at the site. In strong winds the launching procedure is aided by the use of unwinders that allow the suspension cord for the radiosonde to deploy

slowly following the launch. Very strong surface winds require unwinders that deploy the suspension cord at rates as low as 0.5 to 1 m s^{-1} .

Automatic launch systems for radiosondes are commercially available. These may offer cost advantages at radiosonde stations where staff are used solely for radiosonde operations. These systems may not be suitable for operations in very exposed conditions where very strong surface winds are common.

If users require accurate vertical structure in the atmospheric boundary layer, the surface observations incorporated in the upper-air report should be obtained from a location close to the radiosonde launch site. The launch site should also be representative of the boundary layer conditions relevant to the surface synoptic network in the area. It is preferable that the operator (or automated system) should make the surface observation immediately after the balloon release rather than prior to the release. The operator should be aware of inserting surface observations into the ground system prior to launch, as meteorological conditions may change before the launch actually takes place when a significant delay in the launch procedure occurs (for instance, a balloon burst prior to launch, or air traffic control delay).

As the radiosonde sensors will function reliably only when correctly ventilated, radiosondes must be well ventilated prior to launch if the correct vertical structure in the atmospheric boundary layer is to be measured. When it is raining, it will be necessary to provide some protection for the radiosonde sensors prior to launch. In this case, a ventilated screen may be useful in helping to condition the radiosonde for launch.

12.7.4 Radiosonde suspension during flight

The radiosonde must not be suspended too close to the balloon when in flight. This is because the balloon is a source of contamination for the temperature and relative humidity measurements. A wake of air, heated from contact with the balloon surface during the day, and cooled to some extent during the night, is left behind the balloon as it ascends. The balloon wake may also be contaminated with water vapour from the balloon surface after ascent through clouds. The length of suspension needed to prevent the radiosonde measurements from suffering significant

contamination from the balloon wake varies with the maximum height of observation. This is because the balloon wake is heated or cooled more strongly at the lowest pressures. A suspension length of 20 m may be sufficient to prevent significant error for balloons ascending only to 20 km. However, for balloons ascending to 30 km or higher, a suspension length of about 40 m is more appropriate (see, for instance, WMO, 1994a).

Note: When investigating the influence of the balloon wake on radiosonde measurements, it is vital to ensure that the sensors on the radiosonde used for the investigation are correctly exposed. The sensors must be mounted so that it is impossible for air that has had contact with other surfaces on the radiosonde to flow over the radiosonde sensor during ascent. Possible sources of heat or water vapour contamination from the radiosondes are the internal surfaces of protective ducts, the mounts used for the sensor, or the external surfaces of the radiosonde body.

12.7.5 Public safety

The radiosonde design must fall well within existing air traffic safety regulations as to size, weight and density. These should ensure that the radiosonde should not cause significant damage if it collides with an aircraft or if ingested by the aircraft engine. In many countries, the national air traffic authority issues regulations governing the use of free flight balloons. Balloon launch sites must often be registered officially with the air traffic control authorities. Balloon launches may be forbidden or possible only with specific authorization from the air traffic controllers in certain locations. The situation with respect to flight authorization must be checked before new balloon launch locations are established.

In some countries, safety regulations require that a parachute or other means of reducing the rate of descent after a balloon burst must also be attached to the radiosonde suspension. This is to protect the general public from injury. The parachute must reduce the rate of descent near the surface to less than about 6 m s^{-1} . The remains of the balloon following a burst usually limit the rate of descent at lower levels. However, on occasion, most of the balloon will be detached from the flight rig following a burst and the rates of descent will be too high unless a parachute is used.

It is important that radiosondes should be environmentally safe after returning to Earth or after falling in the sea, whether picked up by the public or by an animal, or left to decay.

12.8 RADIOSONDES ERRORS

12.8.1 General considerations

12.8.1.1 Types of error and possible references

This section contains a detailed discussion of the errors encountered with radiosonde sensors. The consequential errors in calculated geopotential heights were discussed in section 12.1.3.7.

Measurement errors by radiosondes may be classified into three types (WMO, 1975):

- (a) Systematic errors characteristic of the type of radiosonde in general;
- (b) Sonde error, representing the variation in errors that persist through thick layers in the vertical for a particular type of radiosonde from one flight to the next;
- (c) Random errors in individual observations, producing the scatter superimposed on the sonde error through a given ascent.

At present, it is still difficult to compare radiosonde data with absolute references. However, high-precision tracking radar measurements, or GPS height measurements, allow systematic errors in geopotential height measurements to be quantified. These results can then be used to identify systematic errors in radiosonde pressure sensor measurements, given that errors in temperature measurements are known to be relatively small.

Most newly developed radiosondes measure temperatures at night which fall within a range of $\pm 0.2 \text{ K}$ at a height of 30 km (WMO, 2005a). Thus, at night, it is possible to identify systematic errors that bias radiosonde measurements away from this consensus. Daytime temperature comparisons with the same certainty are still not feasible. For instance, the average temperatures in the same test fall within about $\pm 0.5 \text{ K}$ at a height of 30 km. However, the development of the National Aeronautics and Space Administration accurate temperature measuring three-thermistor technique offers a way forward in testing daytime measurements (Schmidlin, Sang Lee and Ranganayakamma, 1995).

Relative humidity measurements can be checked at high humidities when the radiosondes pass through clouds at temperatures higher than 0°C . The vertical structure in relative humidity reported by radiosondes, including the presence of very dry layers, can be validated by comparison with Raman lidar measurements.

In most radiosonde comparison tests, the results from one radiosonde design are compared with those of another to provide an estimate of their systematic differences. The values of sonde error and random errors can usually be estimated from the appropriate method of computing the standard deviations of the differences between the two radiosonde types. The most extensive series of comparison tests performed since 1984 have been those of the WMO International Radiosonde Comparison (WMO, 1987; 1991; 1996*a*), and the tests performed in Brazil (2001) and in Mauritius (2005). The results from these and other tests to the same standards in the United Kingdom, United States and Switzerland will be quoted in the subsequent sections.

12.8.1.2 Sources of error other than sensor design, calibration and exposure

It is extremely important to perform pre-flight radiosonde checks very carefully, since mistakes in measuring values for control data used to adjust calibrations can produce significant errors in measurement during the ascent. Observation errors in the surface data obtained from a standard screen and then included in the radiosonde message must also be avoided. An error in surface pressure will affect all the computed geopotential heights. For the same reason, it is important that the surface pressure observation should correspond to the official station height.

Random errors in modern radiosonde measurements are now generally small. This is the result of improved radiosonde electronics and multiplexing,

more reliable data telemetry links between the ground station, and reliable automated data processing in the ground station. Thus, the random errors are usually less significant than systematic radiosonde errors and flight-to-flight variation in sensor performance and calibration (sonde error). However, random errors may become large if there is a partial radiosonde failure in flight, if interference is caused by another radiosonde using a similar transmission frequency, or if the radiosondes are at long slant ranges and low elevations that are incompatible with the specifications of the ground system receiver and aeriels.

Thus, errors in radiosonde measurements may be caused not only by the radiosonde sensor design, and problems with calibration in the factory during manufacture, but also by problems in the reception of the radiosonde signal at the ground and the effect on subsequent data processing. When signal reception is poor, data-processing software will often interpolate values between the occasional measurements judged to be valid. Under this circumstance, it is vital that the operator is aware of the amount of data interpolation occurring. Data quality may be so poor that the flight should be terminated and a replacement radiosonde launched.

Software errors in automated systems often occur in special circumstances that are difficult to identify without extensive testing. Usually, the errors result from an inadvertent omission of a routine procedure necessary to deal with a special situation or combination of events normally dealt with instinctively by an expert human operator.

Table 12.5. Estimates of the systematic error and radiosonde error (flight-to-flight) in pressure of selected radiosonde systems from the WMO International Radiosonde Comparison and associated tests

<i>Radiosonde type</i>	<i>System error at 850 hPa (hPa)</i>	<i>System error at 100 hPa (hPa)</i>	<i>System error at 10 hPa (hPa)</i>	<i>Sonde error at 850 hPa (hPa)</i>	<i>Sonde error at 100 hPa (hPa)</i>	<i>Sonde error at 10 hPa (hPa)</i>
Vaisala RS80	1.0 to 0.5	–1 to –0.5	–0.5 to 0	1	0.6	0.4
Vaisala RS92	< 0.5	< 0.3	< 0.2	0.8	0.4	0.2
VIZ MKII	0 to 1	0.7 to 1.1	0.3 to 0.7	1.6	0.6	0.4
Meisei RS2-91	0.2 to 1	–0.1 to 0.5	–0.2 to 0.2	1	0.6	0.6
Graw DFM-97	<± 1	< 0.3	< 0.2	2	0.8	0.4
VIZ 1392	–0.1 to 0.5	–0.5 to 0.1	–0.5 to –0.2	3.6	1.6	1
SMG (China)	–3.3 to –1.8	–2.5 to –0.8	–1.3 to 0.5	5	3	2.6
MRZ (Russian Federation)	–1.5 to –0.5	–1.2 to –0.8	0 to 0.2	7	3.5	0.5
GPS height	–2 to 0	–0.4 to 0	–0.2 to 0	1 to 2	0.4 to 1	0.1 to 0.3

12.8.2 Pressure errors

Systematic errors and the radiosonde error (flight-to-flight variation at two standard deviations) have been estimated from the WMO International Radiosonde Comparison for selected radiosonde types and from associated tests where radars have been used to check pressure sensor performance. The results are shown in Table 12.5. The range of values of systematic error usually represents the spread of results from several tests. However, in those cases when a test was performed without a radar to cross-check the pressure sensor performance, this may be an indication of uncertainty in the error estimate.

Aneroid capsules were liable to change calibration unless they had been well seasoned through many pressure cycles over their working range before

use. Software corrections applied during data processing, but based on ground control readings before launch, went some way toward reducing these errors. Nevertheless, corrections based on ground checks relied on a fixed error correction pattern across the working range. In practice, the change in pressure sensor calibration was more variable over the working range. This was found to be the case in one widely used system where the software corrections eliminated only about half the variation found in the ground control checks before flight.

Hysteresis errors during ascent should be eliminated largely by calibration, but they become important if observations during descent are used, in which case appropriate corrections should be applied. Errors due to backlash in mechanical linkages should be reduced as far as possible. Systematic errors will

Table 12.6. Estimates of systematic error and sonde error (two standard deviations) for selected temperature sensors at night from the WMO International Radiosonde Comparison and associated tests (using the performance of the NASA-ATM three-thermistor reference as an arbitrary reference for systematic error estimates)

<i>Temperature sensor</i>	<i>System error at 300 hPa (K)</i>	<i>System error at 100 hPa (K)</i>	<i>System error at 30 hPa (K)</i>	<i>System error at 10 hPa (K)</i>	<i>Sonde error at 30 hPa (K)</i>	<i>Sonde error at 10 hPa (K)</i>
Thermocapacitor, aluminized Vaisala RS80	0.2 to 0.5 ^a 0.2 to 0.5 ^b 0.9 to 1.2 ^c	0.2 to 0.5 ^a 0.2 to 0.5 ^b 1.0 to 1.3 ^c	0.2 to 0.5 ^a 0.5 to 0.8 ^b 1.0 to 1.3 ^c	0.3 to 0.8 ^a 0.7 to 1.2 ^b 1 to 1.5 ^c	0.2	0.4
Wire thermocapacitor, aluminized Vaisala RS92	< 0.2	< 0.3	< 0.2	< 0.3	0.2	0.2
Rod thermistor, white paint VIZ	-0.3 to 0.2	-0.4 to 0.3	-0.7 to 0.3	-2.2 to -0.6	0.4	0.6
NASA-ATM three-thermistor, VIZ calibration	Reference (arbitrary)	Reference (arbitrary)	Reference (arbitrary)	Reference (arbitrary)	0.2	0.2
Chip thermistor, aluminized Sippican MKII	< 0.2	< 0.3	< 0.2	< 0.3	0.2	0.4
Small rod thermistor, aluminized, Meisei RS2-91	-0.3 to 0	±0.2	±0.2	-0.4 to 0	0.2	0.4
Rod thermistor, white paint, MRZ (Russian Federation)	0.2	0.2	-0.3	-0.8	1	1
Small bead thermistor, white paint, MODEM (Tropics)	-0.4 to 0	±0.2	-0.5 to -0.8	-1.6 to -1.8	0.5	0.9
Bimetallic spiral + radiation shield, SMG (China)	0.2	0.2	-0.3	-1.8	0.8	2

a RS80 temperatures unmodified during data processing, as in V93 correction scheme.

b RS80 temperatures modified during data processing using V86 correction scheme.

c RS80 temperatures modified during data processing using V80 correction scheme.

arise in the application of temperature corrections if the pressure unit is not at the assumed temperature.

The basic aneroid systems represented in Table 12.5 are the VIZ 1392 (baroswitch), included as a historical reference, and the Chinese SMG (mechanical linkage to code-sending radiosonde). Systematic biases for all aneroid sensors were not always small for a variety of reasons, including poor factory calibrations, difficulties in ground checking certain types of radiosonde, and inadequate temperature compensation during the ascent. Sonde errors for pressure were generally in the range of 1 to 4 hPa. Evidence from comparisons with radar heights suggests that earlier radiosondes of similar sensor type had larger errors than those shown here.

The Vaisala RS80, VIZ MKII, Graw DFM-97 and Meisei RS2-91 radiosondes all have capacitive aneroid sensors, but of differing design. The sonde errors for the capacitive aneroids are significantly smaller than for the other aneroid types, with values usually lower than 1 hPa at most pressures. However, capacitive aneroid capsules may have significant systematic errors, particularly when the internal temperature of the radiosonde changes and temperature gradients develop across the sensor and its associated electronics. The resultant systematic error may be larger than the flight-to-flight variation in sensor performance. Systematic error with capacitive aneroids is usually not larger than ± 1.5 hPa at high pressures and ± 1.0 hPa at very low pressures. However, errors may be larger if the pressure sensors experience very large thermal shock during the launch. This might occur in polar conditions if the radiosonde is not allowed to acclimatize to external conditions before launch.

The Vaisala RS92 has a silicon chip sensor and does not suffer from thermal shock effects, hence its low systematic errors.

The errors for the MRZ system in Table 12.5 are for pressure measurements derived from secondary radar heights rather than from pressure sensor measurements. The Russian radars compared were in an optimum state of repair. GPS height indicates the quality of pressures found at the WMO Radiosonde Comparison in Mauritius from GPS radiosondes able to measure heights using the GPS signals. The improvement in pressure measurement observation achievable with GPS compared to a secondary radar system is very clear.

The consequences of the pressure errors in Table 12.5 on reported temperatures can be judged from the fact that a 1 hPa pressure error will produce a temperature error, on average, of -0.1 K at 900 hPa, -0.3 K in the upper troposphere (at 200 hPa in the tropics), ± 0.5 K at 30 hPa (varying between summer and winter conditions at about 55°N) and up to at least 1 K for most situations at 10 hPa.

12.8.3 Temperature errors

12.8.3.1 Calibration

Table 12.6 summarizes the relative performance of temperature sensors at night as measured in the WMO International Radiosonde Comparison and associated tests. The results represent the typical performance averaged over a minimum of at least 15 test flights. NASA-ATM 3-thermistor measurements, using rod thermistors calibrated by VIZ Inc., were used as an arbitrary reference. The absolute uncertainty of this reference is probably about 0.2 K. Where a range of systematic errors has been attributed to a sensor type, the range represents the spread in systematic difference found in a number of tests.

Errors in temperature sensor calibration during an ascent may result from errors in factory calibration. Small changes in the sensor or in the electrical contacts to the sensor and instabilities in the radiosonde transducer system and references during storage or during the ascent may also occur. Sensor or transducer drift during storage can usually be partially corrected during data processing, using adjustments based on pre-flight ground checks. In Table 12.6, the differences between the aluminized sensors (i.e. Vaisala RS80 without software correction, Vaisala RS92, Meisei RS2-91, Sippican MKII) and the reference are expected to be purely the result of calibration errors or small instabilities in the electrical connections to the sensors.

Sonde errors are only quoted for pressures of 30 hPa and 10 hPa in Table 12.6 since, for most modern temperature sensors, sonde errors show little variation between the surface and 30 hPa.

12.8.3.2 Thermal lag

Most current radiosonde temperature sensors (except thin wire-resistors, thermocouples and very small thermistor or thermocapacitor variables) have time-constants of response that are large enough to require correction if the optimum accuracy is

required. Errors from thermal lag, ϵ_τ , for a rate of ascent, V , in a uniform temperature gradient, dT/dz , will be given for a sensor with the time-constant of response, τ , by:

$$\epsilon_\tau = -\tau \cdot V \cdot dT/dz \quad (12.8)$$

In the lower troposphere, $V \cdot dT/dz$ is often around -0.03 K s^{-1} so that a time-constant of response of 3 s will lead to lag errors of around 0.1 K. In the upper troposphere, $V \cdot dT/dz$ is often around -0.05 K s^{-1} so that a time-constant of response of 5 s will lead to lag errors of around 0.25 K. At much lower pressures, near 10 hPa, $V \cdot dT/dz$ in a 1-km layer thick may be about 0.015 K s^{-1} so that a time-constant of response of 18 s for the temperature sensor will then lead to lag errors in mean layer temperature of about -0.3 K . In strong temperature inversions, temperature gradients may exceed 4 K per 100 m. So for short periods during an ascent, temperature errors may be very much larger than the values quoted above for 1 km thick layers.

The time-constants of response used in the examples above are typical of widely used radiosonde sensors. Bimetallic sensors and the thermistors used by the Russian Federation in the WMO Radiosonde Comparison have time-constants of response that may be at least twice as large as these.

12.8.3.3 Radiative heat exchange in the infrared

Many white paints used on radiosonde sensors have relatively high emissivity in the infrared (> 0.8). Heat exchange with the infrared background is then capable of producing significant errors in temperature measurements. The upward infrared flux incident on the sensor is composed of emissions from the surface and the atmospheric layers below the radiosonde. The downwards infrared flux is often much smaller and is composed of atmospheric emissions from the layers above the radiosonde. The infrared fluxes change as the radiosonde ascends. For a given vertical temperature structure, the infrared fluxes will also vary significantly from flight to flight depending on the cloud present in the vicinity of the ascent.

If the infrared radiation emitted by the sensor is balanced by the absorption of infrared fluxes from the atmospheric environment, the sensor is in radiative equilibrium and will provide a correct reading. The equilibrium temperatures in situations where cloud amount is small decrease as the radiosonde ascends. In the stratosphere, radiative equilibrium temperatures are often around -60°C

in conditions with low amounts of upper and middle cloud, although the precise values will change with surface temperature, surface state and humidity in the troposphere. Thus, when stratospheric temperatures are close to -60°C , infrared errors will usually be small.

Infrared errors affect both day and night observations, although the examples considered here will be restricted to night-time measurements to facilitate the identification of the errors. The systematic errors of white thermistors in climatological averages will depend on the average air temperature and, hence, will change with latitude and average cloud cover in the larger national networks. The effects of infrared heat exchange errors at night can be seen in the measurements of the VIZ, MODEM and Russian thermistors in Table 12.6. At high pressures, these sensors give temperatures close to the reference, but at low pressures the temperatures reported are much colder than the reference. At pressures lower than 30 hPa in the tests considered, the radiative equilibrium temperature at night was usually significantly lower than the actual atmospheric temperatures. Therefore, the infrared radiation emitted by the temperature sensor exceeded the infrared radiation absorbed by the sensor from the atmospheric environment and the sensor cooled to a temperature lower than truth.

When atmospheric temperatures are very low, the radiative equilibrium temperature at night can be higher than the atmospheric temperature. The temperature sensor then emits less radiation than it absorbs from the atmospheric environment and the sensor will give readings higher than truth. In the tropics, positive errors of at least 0.5 K can be expected when temperatures fall below -80°C in layers around the tropopause, especially when the amounts of upper cloud are low. In tests in the British Isles, positive temperature errors larger than 0.5 K were found at pressures lower than 30 hPa on flights where air temperatures were lower than -75°C . Similar sensors had errors of about -1.7 K at 10 hPa for temperatures of -40°C at 10 hPa.

Table 12.6 shows that white rod thermistors and MODEM thermistors had more variation in systematic errors at night and larger sonde errors than the Vaisala RS92, RS80 and Sippican MKII sensors. This was mostly the result of variation in infrared heat exchange errors from test to test, rather than larger variations in the respective factory calibrations. White rod thermistor errors were changed by up to 0.5 K by changes in upper cloud in a test in the United Kingdom when the atmospheric temperature structure showed little

variation with time (WMO, 1994b). The infrared environment varies so much from flight to flight with cloud cover and surface temperature that the errors in an individual flight are extremely difficult to correct without a full radiative transfer model.

Infrared heat exchange also influences the measurements taken by sensors mounted in ducts or radiation shields when the internal surfaces of the ducts are painted black. The black duct surfaces are cooled or heated by infrared radiation in a similar fashion to the white painted sensors described above. The temperature of the air passing through the duct is altered by contact with the black surfaces. Some of this air then flows over the temperature sensor. The resultant temperature error appears to be of similar sign and magnitude to the errors of the white rod thermistors (for example, see the errors for the bimetallic sensor for SMG (China) in Table 12.6).

12.8.3.4 Heating by solar radiation

All radiosonde temperature sensors will have heating errors in daytime flights caused by incident solar radiation. Completely effective radiation shields and reflective coatings have not been achieved in practice. Thus, systematic errors due to solar radiation reaching the sensor either directly or

after multiple reflection inside a radiation shield cannot be ignored. In most modern systems, software corrections are applied during data processing to compensate for the heating. These correction schemes are usually derived from special investigations of day-night differences in temperature (taking into account real diurnal variation in temperature caused by atmospheric tides) coupled with solar heating models. The correction is then expressed as a function of solar elevation during the ascent. The correction may also take into account the actual rates of ascent, since ventilation and heating errors will change if the rate of ascent differs from the standard test conditions. At low solar elevations (less than 10°) the heating errors are extremely sensitive to changes in solar elevation. Thus, if the correction software does not update solar elevation during flight, significant errors will be generated when correcting sunrise or sunset flights.

A simple correction scheme will work effectively only for certain cloud and surface conditions and cannot provide adequate correction for all flight conditions that might be encountered. For instance, in many ascents from coastal sites the radiosonde proceeds out to sea. In clear sky conditions, the low surface albedo of the sea will reduce backscattered solar radiation by a factor of two or three compared with average atmospheric conditions during flight.

Table 12.7. Day-night temperature differences for selected radiosonde sensor types and estimates of daytime sonde temperature errors (two standard deviations) for solar elevations higher than 20°

<i>Temperature sensor</i>	<i>Day-night system differences at 300 hPa (K)</i>	<i>Day-night system differences at 100 hPa (K)</i>	<i>Day-night system differences at 30 hPa (K)</i>	<i>Day-night system differences at 10 hPa (K)</i>	<i>Daytime sonde error at 30 hPa (K)</i>	<i>Daytime sonde error at 10 hPa (K)</i>
Thermocapacitor, aluminized, Vaisala RS92	0.15	0.3	0.4	0.6	0.3	0.6
Thermocapacitor, aluminized, Vaisala RS80	0.9	1.3	2.2	2.8 ^b	0.6	1
Sippican chip thermistor, aluminized	0.5	0.7	1.1	1.3	0.3	0.6
Rod thermistor, white paint, VIZ ^a	0.4	1	1.6	2.5	0.8	1.2
Small rod thermistor, aluminized, Meisei RS2-91	0.6 ^b	1.3 ^b	2.0 ^b	2.5 ^b	0.9	1.3
Rod thermistor, white paint, MRZ (Russian Federation)	1 ^b	1.8 ^b	3.3	5.1	1.2	1.4
Bimetallic spiral radiation + shield, SMG (China)	0.8 ^b	1.3 ^b	3.4 ^b	9.9 ^b	1.4	3

a Measurements are not usually software corrected before being issued to users (as of May 1996).

b Values used in software correction scheme during the WMO International Radiosonde Comparison; other values are estimated from direct comparisons with NASA-ATM three-thermistor measurements.

In such circumstances, software corrections based on average conditions will be at least 20 per cent too large. On the other hand, in ascents over thick upper cloud with very high albedo, backscattering may be much larger than usual and the software correction will underestimate the required correction.

Table 12.7 contains a review of the day-night errors in the most commonly used radiosonde types. These are either the values used in software correction schemes or the actual values derived in radiosonde comparison tests that included comparisons with NASA-ATM three-thermistor measurements. The actual values referenced to NASA measurements are likely to have an uncertainty of 0.2 K at high pressures and 0.3 K at the lowest pressures.

Standardized software correction schemes as described above have an expected uncertainty of 20 per cent. This results from possible variation in backscattered radiation caused by changes in cloud and surface albedo. The associated uncertainty in the systematic errors of temperatures corrected for solar heating will be at least 0.2 K at 100 hPa and at least 0.5 K at 10 hPa for the majority of the older sensors in Table 12.7. The solar heating of Vaisala RS92 and Sippican chip thermistor sensors is two to four times smaller than the best older sensors in Table 12.7. This has been achieved by producing smaller sensors with faster response while retaining the low absorptivity in the visible of the present sensors.

The corrections required by the Russian and Chinese systems at lower pressures are much higher than for the other systems. Many of the radiosonde types in use prior to 1980 had error characteristics similar to the Chinese sensor. The larger heating errors in the older radiosondes were caused by using sensors and supports with higher absorption at visible wavelengths than in most modern sensors. Thus, these older sensors required radiation shields. During ascent, radiosondes swing and rotate like a pendulum suspended from the balloon, so air heated by contact with either the sensor supports, the internal surfaces of the radiation shields or the radiosonde body flows over the sensor mounted in the radiation shield from time to time. This indirect heating increases rapidly as pressure decreases in the stratosphere.

The solar heating of most of the sensors also varies significantly with the orientation of the sensor with respect to the sun. Orientation variations

from flight to flight, as well as variations in the backscattered radiation from flight to flight, produce sonde errors for all the radiosondes which are larger for daytime than for night-time periods. In addition, many manufacturers do not mount the temperature sensor above the surrounding supports. If this is not done, when the radiosonde moves around in flight, in certain positions the air passes over the supports and then onto the sensor, producing positive pulses in the reported temperature. These pulses can be as large as 1°C at 10 hPa. The heating pulses can be readily recognized when flying radiosondes on the rigs used in WMO radiosonde comparisons since the radiosondes rotate in a very regular fashion during the flight. In this situation, suitable raw data filtering can remove the positive pulses to some extent.

12.8.3.5 Deposition of ice or water on the sensor

Another source of temperature error is the deposition of water or ice on the temperature sensor. This will lead to psychrometric cooling (from the wet-bulb effect) of the temperature sensor, once atmospheric relative humidity drops to less than 100 per cent later in the ascent. If the sensor tends to collect water or ice, rather than rapidly shed the precipitation, large parts of the temperature measurements during the ascent may be corrupted. At night, a coating of ice will cause an aluminized sensor to act like a black sensor in the infrared, leading to large cooling at low pressures in commonly encountered conditions.

Furthermore, if water deposited on the sensor freezes as the sensor moves into colder air, the latent heat released will raise the temperature towards 0°C. If a sensor becomes coated with ice and then moves into a warmer layer, the temperature will not rise above 0°C until the ice has melted. Thus, isothermal layers reported close to 0°C in wet conditions should be treated with some caution.

12.8.4 Relative humidity errors

12.8.4.1 Calibration

Errors in relative humidity measurements may occur because of changes in calibration during storage. This problem is likely to be more acute with relative humidity sensors than for temperature or pressure sensors. The manufacturer's instructions regarding the storage of the sensors and preparations for use must be applied carefully.

During manufacture, calibrations on individual sensors are often performed only at a few (less than three) pre-set relative humidity points, and possibly only at one temperature (see, for example, Wade, 1995). In many cases, the temperature dependence of the sensor calibration is not checked individually, or in batches, but is again assumed to follow curves determined in a limited number of tests. Sensor calibrations often vary by several per cent in relative humidity from batch to batch, as can be seen from measurements in low-level cloud (Nash, Elms and Oakley, 1995). This may be a consequence of faulty calibration procedures during manufacture. For instance, actual sensor performance in a given batch may differ from the standardized calibration curves fitted to the pre-set humidity checks. On the other hand, it could be the result of batch variation in the stability of the sensors during storage.

Table 12.8 summarizes the systematic differences between the most widely used sensors tested during the WMO International Radiosonde Comparison. More detailed results on the earlier tests may be

found in Nash, Elms and Oakley (1995). In the tests performed before 2000, the data used were limited to flights where the radiosondes had not passed through low-level cloud. These sensors would not have become wet or contaminated by precipitation. In more recent tests, since the majority of the sensors have displayed improved stability and protection against contamination in cloud, the results from most conditions can be combined. The results shown have also been limited to night flights to eliminate complications caused by solar heating.

The comparisons in Table 12.8 have been limited to temperatures above -20°C . Here, the time-constants of response of the thin-film capacitor and the carbon hygistor are similar and fast enough to avoid significant systematic bias from slow sensor response. Goldbeater's skin is able to respond reasonably well to rapid changes in relative humidity at these temperatures. Nonetheless, the very slow sensor response at high and low humidities will have contributed to the systematic differences shown in Table 12.8.

Table 12.8. Systematic differences and sonde error (two standard deviations) for various relative humidity sensors, at night (ascents through low cloud excluded) for temperatures higher than -20°C , taken from the WMO International Radiosonde Comparison and other associated tests

<i>Humidity sensor</i>	<i>Systematic differences (80–90 per cent RH) (% RH)</i>	<i>Systematic differences (40–60 per cent RH) (% RH)</i>	<i>Systematic differences (10–20 per cent RH) (% RH)</i>	<i>Sonde error (80–90 per cent RH) (% RH)</i>	<i>Sonde error (40–60 per cent RH) (% RH)</i>	<i>Sonde error (10–20 per cent RH) (% RH)</i>
Thin-film capacitor, Vaisala RS80, A-Humicap (dry conditions)	–2 (assumed)	–1 (assumed)	2 (assumed)	6	6	4
Thin-film capacitor, Vaisala RS80, H-Humicap (dry conditions)	–1	0	0	6	6	4
Thin-film capacitor, Vaisala RS92, pulsed heating (all conditions)	0 to –2	0	0	2 to 4	2 to 6	3
Thin-film capacitor, Meisei RS2-91 (all conditions)	–9 to 2	–2 to 5	–2	6	6 to 8	6
Carbon hygistor, VIZ MKII (all conditions)	4 to 10	–4 to 4	–20 to 10	10	4 to 16	6 to 20
Thin film capacitor, MODEM (all conditions)	0 to 8	0 to 7	0 to 5	4 to 8	3 to 8	4 to 6
Carbon hygistor, VIZ 1392 (dry conditions)	4	–3	12	8	8	12
Goldbeater's skin sensor, Russian Federation + UK (dry conditions)	–8	–1	9	12	18	16

The performance of the Vaisala RS80 A-Humicap was used as an arbitrary reference linking the earlier tests in Table 12.8, and more recent tests in Brazil and Mauritius have also utilized the Meteolabor “Snow White” chilled-mirror hygrometer as a working standard. The errors for the RS80-A were deduced from the laboratory tests of a limited number of sensors and operational measurement quality in low-level clouds. It would be unwise to assume that the assumed average performance for the arbitrary reference fell closer than ± 3 per cent relative humidity to the actual absolute errors of the radiosonde measurements.

The VIZ MKII carbon hygistor sensor is smaller than the carbon hygistor used in the VIZ 1392 radiosonde. The two sensors use different algorithms to describe the calibration of the sensors, as issued by the manufacturer.

The results given in Table 12.8 illustrated that for several widely used sensors, the typical calibration curves used for many years needed to be reviewed, particularly at high and low humidities (see also Garand and others, 1992). Many algorithms used to describe sensor performance could be revised (see, for example, Wade, 1994), since automated data processing allows the use of more complex algorithms to represent sensor calibration. In the case of Sippican, a capacitive sensor is being developed to replace the carbon hygistor, and this was evaluated in the WMO Radiosonde Comparison in Mauritius.

With regard to the Meisei thin-film capacitor, following the WMO Radiosonde Comparison in Japan, the thin-film capacitor was redesigned to eliminate low bias at high humidity, and the new sensor was put into operation in 1999.

In Mauritius, the aluminium protective cap might have been a cause of low bias, owing to its high thermal conductivity and obstruction to ventilation around the sensor. In April 2006, the aluminium cap was replaced by a plastic one with low thermal conductivity in order to prevent inward heat conduction, and the inner diameter of the cap was increased to enable better sensor ventilation.

Accurate calibration at high humidity is essential for users who wish to input radiosonde information into numerical weather prediction models. Calibration accuracy at low relative humidity is of greater importance for climatology and scientific research.

In order to obtain good-quality operational measurements, operators need to carefully check the operational performance of relative humidity sensors while preparing for launch. With thin-film capacitor sensors it is important to drive off chemical contamination before use, unless it can be assumed that the sensors have remained uncontaminated during storage since being delivered by the manufacturer. Operators should also keep records of the relative humidity reported when radiosondes pass through cloud layers at low levels. This information needs to be fed back to the suppliers so that corrective action can be taken if sensor calibration is clearly deficient at high humidity.

Humidity sonde errors are often not constant over the whole relative humidity range. Vaisala sensor calibration used during flight is adjusted by using a ground check at very low humidity just before launch. Therefore, the Vaisala measurements are more reproducible from flight to flight at low relative humidity. On the other hand, the calibration procedures followed with carbon hygristors tend to ensure optimum accuracy at close to 30 per cent relative humidity. Sonde errors for VIZ carbon hygristors are often larger at very low relative humidity than at medium and high humidities. The sonde errors of goldbeater’s skin sensors are larger than the other sensors, partly because of the slow speeds of response and hysteresis errors considered in the next section.

12.8.4.2 Slow sensor response and sensor hysteresis

Table 12.4 illustrates that the speed of response of nearly all humidity-sensing materials is less than optimum at low temperatures in the upper troposphere. At higher temperatures in the troposphere, the response speeds of sensors, such as goldbeater’s skin and lithium chloride, are also too slow to avoid systematic bias in dry or wet layers. However, slow time-constants of response may only start to introduce a significant systematic bias in measurements by thin-film capacitors and carbon hygristors at temperatures lower than about -20°C . The carbon hygistor response becomes extremely slow at temperatures lower than -40°C .

Thin-film capacitors can sustain useful measurement capability to temperatures lower than -70°C , even though calibration reliability deteriorates to some extent at the lowest temperatures. For instance, for a relative humidity between 30 and 70 per cent, the Vaisala RS92 thin-film capacitor sensors at -60°C reported relative humidity values

that were 14 per cent higher than the Vaisala A-type thin-film capacitors, as demonstrated by the WMO Radiosonde Comparison in Brazil. The same sensors agreed within a few per cent at higher temperatures (see Table 12.8). The standard deviation of the differences between the measurements taken by the two types of sensors at -60°C for this relative humidity range was found to be around 4 per cent. Corrections for the calibration error in the A-Humicap have been proposed by Miloshevich and others (2001) and Leiterer and others (2005).

Given that relative humidity can rise to very high values and then fall to low values several times during an ascent, sensor hysteresis is also more of a problem with humidity sensors than it is with pressure or temperature sensors. In many sensors, hysteresis errors are limited to a few per cent of relative humidity, but errors may be larger for a sensor, such as goldbeater's skin. Hysteresis errors are only partially alleviated by thoroughly seasoning the sensors during manufacture.

12.8.4.3 Differences between sensor temperature and true atmospheric temperature

The dewpoint reported in the radiosonde TEMP message is derived from the water vapour pressure at a given time into flight. This water vapour pressure is usually obtained by multiplying the saturated vapour pressure computed from the radiosonde temperature by the radiosonde relative humidity measurement. If the temperature of the relative humidity sensor does not correspond to the temperature reported by the radiosonde, the reported dewpoint will be in error. This will occur, either during the day or at night, if the thermal lag of the relative humidity sensor is significantly larger than that of the temperature sensor. If the sensor temperature lags the true atmospheric temperature by 0.5 K at a temperature close to 20°C , the relative humidity reported by the sensor will be about 97 per cent of the true relative humidity. This will result in an error of -1.5 per cent at a relative humidity of 50 per cent. As temperature decreases to -10°C and then to -30°C , the same temperature lag in the sensor causes the reported relative humidity to decrease to 96 per cent and then to 95 per cent of the true value.

During daytime flights, direct heating by solar radiation can also produce significant heating of the relative humidity sensor. In addition, the sensor may be heated indirectly by air that has previously flown over contact protective covers or duct walls

heated directly by solar radiation. Brousides and Morrissey (1974) quantified the errors that could occur with VIZ radiosondes. Cole and Miller (1995) investigated the errors that could occur when Vaisala RS80 radiosondes were launched from poorly ventilated shelters in the tropics.

The daytime differences between carbon hygistor and thin-film capacitor measurements obtained in the early phases of the WMO Radiosonde Comparison were very close to the values obtained at night. Thus, while both sensor types must have some negative error caused by the direct or indirect solar heating of the relative humidity sensor, the errors were of similar magnitude for both types of sensors.

A recent comparison with collocated remote-sensing observations (microwave radiometers or GPS water vapour) has confirmed that there is a day-night difference in modern radiosonde relative humidity measurements, for example, see Turner and others (2003) and WMO (2005*b*). The day-night difference can also be deduced from recent comparisons with the Snow White hygrometer, as Snow White measurements are relatively consistent between day and night at temperatures higher than -50°C . In the tropics, the day-night differences in Vaisala RS80-A and RS90 relative humidity measurements in high humidity shortly after launch were about 5 per cent relative humidity (WMO Radiosonde Comparison, Brazil, 2002). In the WMO Intercomparison of High Quality Radiosonde Systems in Mauritius (2005*a*), the coatings of the surfaces around the Vaisala RS92 sensor were modified to reduce solar heating, and the solar heating error was only 2 to 3 per cent near the surface and about 5 per cent at 6 km. At 11 km, at a temperature of -40°C , the day-night difference of Vaisala with respect to Snow White had increased to about 9 per cent.

12.8.4.4 Wetting or icing in cloud

When the performance of the older relative humidity sensors was compared after passing through low cloud or fog (where the external temperature sensors have clearly become wet), the systematic differences between the sensor measurements were not close to those shown in Table 12.8. In particular, the systematic differences between the Vaisala thin-film capacitor and VIZ carbon hygistor measurements at a relative humidity from 0 to 70 per cent increase the relative humidity by at least 10 per cent on average (Nash, Elms and Oakley, 1995). Both of these sensor types had possible additional errors in wet conditions, although the mechanisms causing the additional errors were quite different for the two types.

Vaisala thin-film capacitors, together with the protective covers for the sensor, usually became contaminated to some extent in low cloud. On emerging from cloud in severe icing conditions, the sensors may report a relative humidity that is up to 30 per cent high. Positive errors resulting from sensor contamination are more usually in the range of 1 to 20 per cent relative humidity. In some cases, the contamination may last for only a few minutes, but in others, the contamination can continue to affect measurements into the upper stratosphere. Heating the sensors during the ascent does eliminate the contamination more quickly with the Vaisala RS92, although the RS92 versions that only heat down to -40°C become contaminated in upper cloud, and the versions heating to -60°C do not experience so much contamination. At temperatures below -70°C , the saturation vapour pressure of water is very low, and more work needs to be carried out to check whether decontamination of the sensors at these very low temperatures is necessary to obtain reliable measurements.

The VIZ carbon hygistor calibrations are not very stable when the sensors are exposed to high relative humidity for long periods of time in the laboratory. If the sensors become wet during an ascent, or if they are exposed to very moist conditions, it appears that the calibration often changes on emerging from the cloud. The effect of the change in calibration causes the relative humidity reported in the remainder of the flight to fall by between 1 and 15 per cent, on average, compared to relative humidity reports in dry conditions.

Hence, relative humidity measurements in the upper troposphere after ascents have passed through cloud layers in the lower troposphere need to be treated with more caution than measurements made in dry conditions.

12.8.5 **Software errors**

A large number of software errors or omissions can be made in a radiosonde ground system. Extensive testing must be conducted before amended or new software is introduced into operational service.⁴

Operators at radiosonde stations should be on the alert for indications of wrong results. Some errors may occur only during certain meteorological

circumstances. Thus, it may be necessary to gather evidence over many ascents before the nature of the errors or omissions becomes apparent. Comprehensive interactive data displays for the operator and comprehensive archives of the incoming radiosonde information are essential if fault-finding is to be efficient.

12.9 **COMPARISON, CALIBRATION AND MAINTENANCE**

12.9.1 **Comparisons**

The overall quality of operational measurements of geopotential height by radiosonde (and hence temperature measurements averaged through thick layers) is monitored at particular forecast centres by comparison to geopotential heights at standard pressures with short-term (6 h) forecasts from global numerical weather prediction models for the same location. The statistics are summarized into monthly averages that are used to identify both substandard measurement quality and significant systematic changes in radiosonde performance. The European Centre for Medium-Range Weather Forecasts, in Reading (United Kingdom), is the lead centre currently designated by the Commission for Basic Systems for this work, but other national forecast centres also produce similar statistics.

Random errors in geopotential height (and hence temperature) measurements can also be identified at individual stations from analyses of the changes in the time series of measurements of geopotential height, at 100 hPa or lower pressures, where atmospheric variability is usually small from day to day. The compatibility between the results from this method and those from comparison with short-term forecast fields is provided in WMO (1989*b*).

The performance of radiosondes or radiosonde sensors can be investigated in the laboratory with suitably equipped test chambers, where temperature and pressure can be controlled to simulate radiosonde flight conditions.

Detailed investigations of temperature, pressure and relative humidity sensor performance in flight are best performed using radiosonde comparison tests, where several radiosonde types are flown together on the same balloon ascent. Annex 12.C gives guidelines for organizing

⁴ See Recommendation 4 (CIMO-XII) of the twelfth session of the Commission for Instruments and Methods of Observation, held in 1998.

radiosonde intercomparisons and for the establishment of test sites. When testing a new radiosonde development, it is advisable to have at least two other types of radiosonde with which to compare the newly developed design. The error characteristics of the other radiosondes should have been established in earlier tests. An ideal comparison test site would have an independent method of measuring the heights of the radiosondes during flight. This can be achieved by using measurements taken with a high-precision radar (or a GPS receiver and processor capable of accurate height measurements when flown with the radiosondes). A reliable height measurement allows reliable estimates of the systematic bias in pressure sensor measurements. This is an advantage since the systematic errors of many widely used pressure sensors vary to some extent with the conditions during ascent and with the age of the sensors.

12.9.1.1 Quality evaluation using short-term forecasts

For the better global numerical weather prediction models, the random error in short-term (6 h) forecasts of 100 hPa geopotential heights is between 10 and 20 m in most areas of the world. These errors correspond to a mean layer temperature error from the surface to 100 hPa of between 0.15 and 0.3 K. Thus, the comparison with the forecast fields provides good sensitivity in detecting sonde errors in temperature, if sonde errors are greater than about 0.3 K. Forecast fields, rather than analysis fields, are used as the reference in this comparison. Forecast fields provide a reference that is less influenced by the systematic errors in geopotential heights of the radiosonde measurements in the area than the meteorological analysis fields. However, 6 h forecast fields will have small systematic errors and should not be considered as an absolute reference. Uncertainty in the systematic error of the forecast field is at least 10 m at 100 hPa. The systematic differences of forecasts from the measurements of a given radiosonde station vary between forecast centres by at least this amount. In addition, systematic errors in forecast fields may also change with time by similar amounts, when forecast models and data assimilation techniques are improved. Nonetheless, comparisons with the forecast fields at the lead centres for operational monitoring give clear indications of those radiosonde stations and radiosonde types where there are large systematic

errors in the radiosonde reports. Reference WMO (2003*b*) provides the most recent review of radiosonde errors in the global network for heights up to 30 hPa.

12.9.1.2 Quality evaluation using atmospheric time series

Random errors in radiosonde measurements can be estimated from the time series of closely spaced measurements of geopotential heights, at pressure levels where the geopotential heights change only slowly with time. Suitable pressure levels are 100, 50, or 30 hPa. For radiosonde observations made at 12 h intervals, this is achieved by computing the difference between the observation at +12 h, and a linear interpolation in time between the observations at 0 and +24 h. Further differences are subsequently computed by incrementing in steps of 24 h through the time series. An estimate of the random errors in the radiosonde measurements can then be derived from the standard deviation of the differences. For much of the year, the sensitivity of this procedure is similar to the comparison made with forecast fields. One exception may be during winter conditions at middle and high latitudes, when the geopotential heights at 100 hPa will sometimes change very rapidly over a short time.

The average values of the differences from the time series may provide information on the day-night differences in radiosonde temperature measurements. The interpretation of day-night differences must allow for real daily variation in geopotential height caused by diurnal and semidiurnal tides. Real day-night differences at mid-latitudes for 100 hPa geopotential heights can be as large as 30 m between observations at 1800 and 0600 local time (Nash, 1984), whereas real day-night differences between observations at 1200 and 0000 local time will usually be in the range 0 ± 10 m.

It is beneficial if individual radiosonde stations keep records of the variation in the time-series of geopotential height measurements at 100 hPa and in the geopotential height increment (100–30) hPa. This allows the operators to check for large anomalies in measurements as the ascent is in progress.

12.9.1.3 Radiosonde comparison tests

Radiosonde comparison tests allow the performance of the pressure, temperature and relative humidity sensors on the radiosonde to be compared independently as a function of time.

Laboratory tests should be performed in facilities similar to those required for the detailed calibration of the radiosondes by the manufacturer. These tests can be used to check the adequacy of radiosonde calibration, for example, the dependence of calibration on sensor temperature. However, in the laboratory, it is difficult to simulate real atmospheric conditions for radiative errors and wetting or icing of sensors. Errors from these sources are best examined in comparisons made during actual ascents.

In order to compare measurements taken during actual ascents, the timing of the samples for the different systems must be synchronized as accurately as possible, ideally to better than ± 1 s. In recent years, software packages have been developed to support WMO radiosonde comparison tests (WMO, 1996*b*). These allow all the radiosonde samples to be stored in a comparison database and to be compared by the project scientists immediately following a test flight. It is important that comparison samples are reviewed very quickly during a test. Any problem with the samples caused by test procedures (for example, interference between radiosondes) or faults in the radiosondes can then be identified very quickly and suitable additional investigations initiated. The software also allows the final radiosonde comparison statistics to be generated in a form that is suitable for publication.

Initial tests for new radiosonde designs may not merit large numbers of comparison flights, since the main faults can be discovered in a small number of flights. However, larger scale investigations can be justified once systems are more fully developed. As the reproducibility of the measurements of most modern radiosondes has improved, it has become possible to obtain useful measurements of systematic bias in temperature and pressure from about 10 to 15 flights for one given flight condition (i.e., one time of day). Since it is unwise to assume that daytime flights at all solar elevations will have the same bias, it is preferable to organize tests that produce at least 10 to 15 comparison flights at a similar solar elevation. The measurements of temperature sensor performance are best linked to other test results by comparisons performed at night. The link should be based on measurements from radiosondes with wire or aluminized sensors and not from sensors with significant infrared heat exchange errors. If a continuous series of comparison flights (alternating between day and night) can be sustained, it is possible to use the

atmospheric time-series technique to estimate the magnitude of day-night differences in temperature measurements.

As noted earlier, the most extensive series of comparison tests performed in recent years were those of the WMO International Radiosonde Comparison. Initial results have been published in WMO (1987; 1991; 1996*a*; 2003*c*; 2005*a*). The results from these tests were the basis of the information provided in Tables 12.5 to 12.8.

The first international comparison of radiosondes was held at Payerne (Switzerland) in 1950. Average systematic differences between radiosonde pressures and temperatures were 4 hPa and 0.7 K, with random errors (two standard deviations) of 14 hPa and 2 K. These values should be compared with the results for modern systems shown in Tables 12.5 to 12.7. The results from a second comparison carried out at the same site in 1956 showed that accuracy needed to be improved by the application of radiation corrections to the temperature readings. The errors in pressure and temperature at the 50-hPa level were quite large for most radiosondes and increased rapidly at higher levels, especially during daylight. In 1973, a regional comparison was held in Trappes (France). This identified significant calibration errors in some radiosondes, with one bimetallic temperature sensor having a radiation error as large as 10 K.

12.9.2 Calibration

The calibration methods used by manufacturers should be identified before purchasing radiosondes in large numbers. The quality control procedures used to ensure that measurement accuracy will be sustained in mass production must also be checked for adequacy. Purchasers should bear in mind that certain specified levels of error and product failure may have to be tolerated if the cost of the radiosonde is to remain acceptable. However, the in-flight failure rate of radiosondes from reliable manufacturers should not be higher than 1 or 2 per cent.

Unless radiosonde sensors can be produced in large batches to give the reproducibility and accuracy required by users, it is necessary to calibrate the instruments and sensors individually. Even if the sensors can be produced in large batches to meet an agreed set of standardized performance checks, it is necessary for representative samples, selected at random, to be checked in more detail. The calibration process should, as far as possible,

simulate flight conditions of pressure and temperature. Calibrations should normally be performed with falling pressure and temperature. Relative humidity will probably be checked in a separate facility. The reference sensors used during calibration should be traceable to national standards and checked at suitable intervals in standards laboratories. The references should be capable of performing over the full temperature range required for radiosonde measurements.

The design of the calibration apparatus depends largely on whether the complete radiosonde must be calibrated as a unit or on whether the meteorological units can be tested while separated from the radiosonde transmitter. In the latter case, a much smaller apparatus can be used. The calibration facility should be able to cover the range of pressures and temperatures likely to be encountered in actual soundings. It should be possible to maintain the conditions in the calibration chamber stable at any desired value better than ± 0.2 hPa min^{-1} for pressure, ± 0.25 K min^{-1} for temperature and 1 per cent relative humidity per minute. The conditions in the calibration chamber should be measured with systematic errors less than ± 0.2 hPa for pressure, ± 0.1 K for temperature and ± 1 per cent relative humidity. Reference thermometers should be positioned in the calibration chamber in order to identify the range of temperatures in the space occupied by the sensors under calibration. The range of temperatures should not exceed 0.5 K. Sufficient measurements should be taken to ensure that the calibration curves represent the performance of the sensors to the accuracy required by the users. Pressure sensors which are not fully compensated for temperature variations must be calibrated at more than one temperature. Thus, it may be an advantage if the temperature calibration chamber is also suitable for the evaluation of the pressure units.

Humidity calibration is usually carried out in a separate apparatus. This can take place in a chamber in which a blower rapidly circulates air past a ventilated psychrometer or dewpoint hygrometer and then through one of four vessels containing, respectively, warm water, saturated solutions of sodium nitrate and calcium chloride, and silica gel. Any one of these vessels can be introduced into the circulation system by means of a multiple valve, so that relative humidities of 100, 70, 40 and 10 per cent are readily obtained. The standard deviation of the variation in relative humidity should not exceed 1 per cent in the space occupied by the units under calibration.

An alternative arrangement for humidity calibration is a duct or chamber ventilated with a mixture of air from two vessels, one of which is kept saturated with water while the other is dried by silica gel, with the relative humidity of the mixture being manually controlled by a valve which regulates the relative amounts passing into the duct.

Because of the importance of the type or batch calibration of radiosondes, the Commission for Instruments and Methods of Observation urges Members to test, nationally or regionally, selected samples of radiosondes under laboratory conditions in order to ensure that the calibrations supplied by the manufacturer are valid.⁵

12.9.3 Maintenance

Failure rates in the ground system should be low for radiosonde systems based on modern electronics, as long as adequate protection is provided against lightning strikes close to the aerials. The manufacturer should be able to advise on a suitable set of spares for the system. A faulty module in the ground system would normally be replaced by a spare module while it is returned to the manufacturer for repair.

The maintenance requirements for radiosonde systems relying on radar height measurements to replace radiosonde pressure measurements are quite different. In this case, local maintenance should be readily available throughout the network from staff with good technical capabilities (both mechanical and electrical). This will be essential if accurate tracking capability is to be retained and if long-term drifts in systematic height errors are to be avoided.

12.10 COMPUTATIONS AND REPORTING

There are no prescribed standardized procedures for the computation of radiosonde observations. The main issue is the selection of levels to reproduce accurately and efficiently the temperature and humidity profile against geopotential from the radiosonde data. Guidance is given in WMO (1986) and in the coding procedures agreed by WMO (1995) (Code FM 35-X Ext. TEMP).

⁵ As recommended by the Commission for Instruments and Methods of Observation at its eleventh session held in 1994, through Recommendation 9 (CIMO-XI).

12.10.1 Radiosonde computations and reporting procedures

Upper-air measurements are usually input into numerical weather forecasts as a series of layer averages, with the thickness of the layers depending on the scales of atmospheric motion relevant to the forecast. The layers will not necessarily be centred at standard pressures or heights, but will often be centred at levels that vary as the surface pressure changes. Thus, the variation in temperature and relative humidity between the standard levels in the upper-air report must be reported to sufficient accuracy to ensure that the layer averages used in numerical forecasts are not degraded in accuracy by the reporting procedure.

Prior to 1980, most radiosonde measurements were processed manually by the operators by using various computational aids. These methods were based on the selection of a limited number of significant levels to represent the radiosonde measurement, possibly about 30 significant levels for a flight up to 30 km. The WMO codes reflected the difficulties of condensing a large amount of information on vertical structure into a short message by manual methods. The coding rules allowed linear interpolations in height between significant levels to differ from the original measurements by up to ± 1 K for temperature and up to ± 15 per cent for relative humidity in the troposphere and up to ± 2 K for temperature in the stratosphere. It was expected that operators would not allow large interpolation errors to persist over deep layers in the vertical.

In modern radiosonde ground systems, the use of cheap but powerful computing systems means that much higher sampling rates can be used for archiving and processing the radiosonde measurements than is possible with manual computations. The manual processing of radiosonde measurements nearly always introduces unnecessary errors in upper-air computations and should be eliminated as soon as possible.

However, the automation of the selection procedure for significant levels for TEMP messages is not straightforward. The available algorithms for automated upper-air message generation often have significant flaws. For instance, when there are few pronounced variations in relative humidity in the vertical, automated systems often allow large temperature interpolation errors to extend over several kilometres in the vertical. Furthermore, the algorithms often allow large systematic bias between the reported relative

humidity structure and the original measurements over layers as thick as 500 m. This is unacceptable to users, particularly in the atmospheric boundary layer and when the radiosonde passes through clouds. Interpolation between significant cloud levels must fit close to the maximum relative humidity observed in the cloud.

Therefore, reports from automated systems need to be checked by operators to establish whether coding procedures are introducing significant systematic bias between the upper-air report and the original radiosonde measurements. Additional significant levels may have to be inserted by the operator to eliminate unnecessary bias. TEMP messages with acceptable systematic errors are often produced more easily by adopting a national practice of reducing the WMO temperature fitting limits to half the magnitude cited above. Alternatively, the advent of improved meteorological communications should allow the approximation in reporting upper-air observations to be reduced by reporting measurements using the appropriate BUFR code message.

12.10.2 Corrections

It should be clear from earlier sections that the variation in radiosonde sensor performance caused by the large range of conditions encountered during a radiosonde ascent is too large to be represented by a simple calibration obtained at a given temperature. Modern data processing allows more complex calibration algorithms to be used. These have provided measurements of better accuracy than that achieved with manual systems. It is vital that these algorithms are adequately documented. Users should be informed of any significant improvements or modifications to the algorithms. Records archived in radiosonde stations should include the model numbers of radiosondes in use and an adequate reference to the critical algorithms used for data processing.

All radiosonde temperature measurements have radiation errors. In most cases, these errors cannot be compensated perfectly because they depend on cloud distribution, surface state, the orientation of the radiosonde during the ascent and solar elevation. Most users outside the Meteorological Services are unaware of the usual error characteristics of the national radiosonde sensors in use. Therefore, it is recommended that a radiation correction (based on expected sensor performance in usual conditions) should always be applied during data processing. The details of this radiation correction should be recorded and kept with the station archive, along with an

adequate archive of the original raw radiosonde observations, if required by national practice.

Errors from infrared heat exchange pose a particular problem for correction, since these errors are not independent of atmospheric temperature. Solar heating errors for metallic (for example, aluminized) sensors and white-painted sensors are similar (see Table 12.7). Thus, it is preferable to eliminate as soon as possible the use of white paint with high emissivity in the infrared as a sensor coating, rather than to develop very complex correction schemes for infrared heat exchange errors.

Similarly, it is unwise to attempt to correct abnormally high solar radiation heating errors using software, rather than to eliminate the additional sources of heating by positioning the sensor

correctly with respect to its supports, connecting leads and radiosonde body.

Considering the importance of the ways in which corrections are applied, the Commission for Instruments and Methods of Observation⁶ urges Members to:

- (a) To correct and make available the corrected upper air data from the various Global Observing System upper-air stations;
- (b) To make users of the data aware of changes in the methodology used to correct reports, so that they may be adjusted, if desired;
- (c) To archive both the corrected and uncorrected upper-air observations and produce records for climatological applications of the correction applied. The method used should be determined nationally;
- (d) To inform WMO of the method of correction applied.

⁶ As recommended by the Commission for Instruments and Methods of Observation at its eleventh session, held in 1994, through Recommendation 8 (CIMO-XI).

ANNEX 12.A

**ACCURACY REQUIREMENTS (STANDARD ERROR) FOR UPPER-AIR
MEASUREMENTS FOR SYNOPTIC METEOROLOGY, INTERPRETED FOR
CONVENTIONAL UPPER-AIR AND WIND MEASUREMENTS**

<i>Variable</i>	<i>Range</i>	<i>Accuracy requirement</i>
Pressure	From surface to 100 hPa 100 to 10 hPa	1 hPa to 2 hPa near 100 hPa 2 per cent
Temperature	From surface to 100 hPa 100 to 10 hPa	0.5 K 1 K
Relative humidity	Troposphere	5 per cent (RH)
Wind direction	From surface to 100 hPa	5°, for less than 15 m s ⁻¹ 2.5° at higher speeds
	From 100 to 10 hPa	5°
Wind speed	From surface to 100 hPa	1 m s ⁻¹
	From 100 to 10 hPa	2 m s ⁻¹
Geopotential height of significant level	From surface to 100 hPa	1 per cent near the surface decreasing to 0.5 per cent at 100 hPa

ANNEX 12.B

PERFORMANCE LIMITS FOR UPPER WIND AND RADIOSONDE TEMPERATURE, RELATIVE HUMIDITY AND GEOPOTENTIAL HEIGHT

Table 1. Summary of performance limits for wind-sounding equipment

For the study of mesoscale systems at all levels and locations a lower limit (a) of 0.5 m s ⁻¹ seems appropriate											
Region	Pressure level (hPa)	height (km)	Local use		Synoptic use		Climatological use		Wind strength in which sounding equipment must be able to operate		Remarks
			(a)	(b)	(a)	(b)	(a)	(b)	(a)	(b)	
Extratropical troposphere			0.8 increasing to 1.5 near the tropopause	6 10 ^a	1 increasing to 2 near the tropopause	4 7 ^b	1 increasing to 2 near the tropopause	5 ^c 10 ^c	40 ^d increasing to 80 ^d near the tropopause	18 ^d 37 ^d	In particular localities, operation in winds of 50 m s ⁻¹ in the lower troposphere and 150 m s ⁻¹ near the tropopause may be called for
Extratropical troposphere			0.8 increasing to 1.5 ^e near the tropopause	4 7 ^f	1 increasing to 2 near the tropopause	3 6 ^g	1 increasing to 2 near the tropopause	5 ^h 5 ^h	20 increasing to 60 near the tropopause	10 40	Ignores requirement for soundings in tropical cyclones
Extratropical stratosphere	50 30	20 24	0.7 0.7	3 ⁱ 2	0.7 0.7	5 ⁱ 3.6	0.7 0.7	Very variable with season, altitude and location	75 ^k 100 ^k 200	Not specified	
Extratropical troposphere	50 31	20 24	0.7 0.7	5	7.7 0.7	5	0.7 0.7	5	40 ^l	Not specified	For research purposes, there is a need for wind profiles with high vertical resolution and as small observational errors as practical
	11	31	1	5	1	5	1	5	45 ^l		
	5 0.7	36 50	1 1.5	2 10	1.2 1.5	10	1.2 1.5	10	100 ^l		

^a Least stringent limit (b) is 30 m s⁻¹ (winter, North Atlantic).

^b Least stringent limit (b) is 20 m s⁻¹ (winter, North Atlantic).

^c These limits relate to least stringent limits (b) for the systematic part of the error. Corresponding values for the standard vector deviation of the random part of the error are 10 m s⁻¹ increasing to 15 m s⁻¹, near the tropopause. More stringent limits (b) are appropriate in many areas where large quantities of good-quality data already exist.

- ^d For mean wind 0–40 000 feet (0–12 km) in winter; over southern England limit (*a*) is 60 m s⁻¹ and limit (*b*) is 27 m s⁻¹; over southern Japan, where the most severe conditions occur, limit (*a*) is 80 m s⁻¹ and limit (*b*) is 50 m s⁻¹.
- ^e Perhaps little or no increase with height occurs over substantial areas, giving a limit (*a*) of 1 m s⁻¹ in the high troposphere.
- ^f Least stringent limit (*b*) is 15 m s⁻¹ (mostly in winter near the boundary of the tropics).
- ^g Least stringent limit (*b*) is 12 m s⁻¹ (mostly in winter near the boundary of the tropics).
- ^h These are the least stringent limits (*b*) for the systematic part of the error. Corresponding values for the standard vector deviation of the random part are 5 m s⁻¹, increasing to 10 m s⁻¹ in the upper troposphere.
- ⁱ Least stringent limits (*b*) in winter are 11 and 13 m s⁻¹ at 50 and 30 hPa, respectively, 20 to 25 m s⁻¹ at 10 to 5 hPa and even larger values at 1 hPa. These values relate to short-period (single-month) means; still larger values relate to long-period means (for example, periods involving several winters), but distributions in such samples are likely to be multi-model.
- ^j Least stringent limits (*b*) in winter are 6, 7, 10, 12 and 16 m s⁻¹ at 50, 30, 10, 5 and 0.7 hPa, respectively.
- ^k For mean wind 0–100 000 feet (0–30 km) in the worst season (winter) over southern England, limit (*a*) is 45 m s⁻¹ and limit (*b*) is 26 m s⁻¹.
- ^l These maximum winds at individual levels do not occur simultaneously at all levels. These values are estimates of the strongest individual winds likely to be encountered during the periods when the “26-month” and annual oscillations combine to yield the strongest average winds. Mean winds through deep layers will be substantially less than these values because of low inter-level correlations over deep layers.

Notes:

Limit (*a*) — The limit of error beyond which improvement is unnecessary for the stated purpose.

Limit (*b*) — The limit of error beyond which the data obtained will have negligible value for the stated purpose.

(Values vary substantially with season and location; errors are standard vector errors in m s⁻¹ except where otherwise noted.)

Unless otherwise specified, values refer to wind measurements averaged over a layer 300 to 400 m thick in the troposphere and 600 to 800 m thick in the stratosphere, centred on the reporting level.

Table 2. Summary of performance limits for aerological temperature sounding

Region	Pressure level (hPa)	Height (km)	Local use		Synoptic use		Climatological use		Range of temperature	Remarks
			(a)	(b)	(a)	(b)	(a)	(b)		
Extratropical troposphere			0.15	3.0 ^a (2.0 from 30° to 40° latitude)	0.15	2.0	0.15	2.0 ^b	-80 to +40	
Equatorial troposphere	Lower troposphere		0.15	1.0	0.15	0.7	0.15	1.0 ^b	-100 to +40	
	Upper troposphere		0.15	1.5	0.15	1.0	0.15	1.5 ^b		
Extratropical stratosphere	200		0.3	4 ^c	0.3	3.8	0.3	1.5 ^f	-100 to +50	
	100		0.3	3	0.3	1.4	0.3	1.5		
	50		0.3	1.5	0.3	0.7	0.3	1.5		
	10		0.3	1.5	0.3	0.7	0.3	1.5		
	5		0.3	2 ^d	0.3	0.9	0.3	2 ^c		
	(5)	35	0.3	4 ^d	0.3		0.3	4 ^c		
Equatorial stratosphere		50	0.3	6 ^e	0.3	2.0	0.3	6 ^d	-100 to +20	The 26-month cycle of temperature in the middle stratosphere has been considered to be climatology, rather than climate change
	100		0.3	2 ^g	0.3	1	0.3	2 ^h		
	50		0.3	2	0.3	1	0.3	2		
	10		0.3	3	0.3	1.5	0.3	3		
		35	0.3	3.5	0.3	1.5	0.3	3.5		
		50	0.3	4.5	0.3	2	0.3	4.5		

^a The highest limit (*b*) is 7°C (over continents in winter).

^b These values relate to the systematic part of the error.

^c All values in this column are subject to substantial increase in winter.

^d Note that two limits (*b*) are indicated for the same level by a different series of observations. Both values may be too large because of instrumental errors in the observations on which they are based.

^e This value for 50 km compares with that given for 35 km. Again, the indicated value may well be too large. A value between 4 and 5°C is probably more realistic.

^f All values in this column relate to standard deviations of random errors. Somewhat larger errors in the low stratosphere and substantially larger errors in the high stratosphere would provide information of some value in winter. Values for limit (*b*) relating to the systematic part of the error are very variable (see paragraph 5.4.6 in WMO (1970)).

^g All values in this column are based upon apparent variability of the atmosphere as measured. Such variability includes contributions from those instrumental errors of observation which are random from sounding to sounding. These contributions may well be substantial for the instruments involved here (see paragraph 5.5.3 in WMO (1970)).

^h All values in this column relate to standard deviations of random errors. In the base case systematic error in temperature measurements for climatological use should be zero.

Notes:

Limit (*a*) — The standard error of temperature below which improvement is unnecessary for the stated purpose.

Limit (*b*) — The limit of error beyond which the data obtained will have negligible value for the stated purpose.

(Most values vary substantially with location and season; errors are standard errors in °C except where otherwise indicated.)

Unless otherwise specified, values refer to temperature measurements averaged over a layer 30 to 40 m thick in the stratosphere, centred on the reporting level.

Table 3. Summary of performance limits for aerological instruments measuring humidity

Layer	For local use				For synoptic use				For climatological use				Remarks
	(a)		(b)		(a)		(b)		(a)		(b)		
	°C	RH (%)	°C	RH (%)	°C	RH (%)	°C	RH (%)	°C	RH (%)	°C	RH (%)	
The convective and turbulent layer near the ground	0.5	3	5	30	0.5	3	5	30	0.5	3	1.5 ^a	10 ^a	Systematic errors on a single sounding should be below 0.15°C (1 % RH) if possible, so that average water content of a column of air can be specified with greater accuracy than the water content at a specific level
The troposphere above the convective layer	0.2 ^b	1 ^b	10	30	0.2 ^b	1 ^b	10	30	0.5	3	1.5 ^a	10 ^a	Additional requirement for measurement of very steep humidity gradients for radio meteorology
	2.5 ^c	10 ^c	10	30	2.5 ^c	10 ^c	10	30	0.5	3	1.5 ^a	10 ^a	
	at high humidities				at low humidities								
	at low humidities				at low humidities								

^a These values relate to the systematic parts of the error, which are constant from sounding to sounding at particular levels.

^b A direct determination of the presence of water seems more feasible.

^c Systematic errors on a single sounding should not exceed 1.5°C (5 per cent RH).

Notes:

Limit (a) — The limit of error in frost point or dewpoint or relative humidity below which improvement is unnecessary for the stated purpose.

Limit (b) — The limit of error in frost point or relative humidity or dew point beyond which the observation would have negligible value for the stated purpose.

(Associated values of relative humidity are alternative suggestions and not strict conversions.)

Table 4. Summary of performance requirements in determining the heights of isobaric surfaces and significant points

Region	Pressure level(hPa)	Local use		Synoptic use		Climatological use		Remarks
		(a)	(b)	(a)	(b)	(a)	(b)	
Middle and high latitudes	Lower troposphere	5	45 ^a	1.5 ^d	25 ^e	1.5 ^f		Limits for isobaric surfaces in the mesosphere not assessed in detail (see paragraph 7.3.5 in WMO (1970)) Random height errors of standard deviation 85 m at each station at any level would be associated with root-mean-square wind component errors of 10 m s ⁻¹ at the level at middle latitudes assuming 1 000 km between stations
	300	10	80 ^b	1.5	70		Large ^g	
	100	10	45 ^c	1.5	35	1.5	Even	
	50	10	30 ^c	1.5	10			
	30	10	30 ^c	1.5	20	1.5	Very large	
	10		30 ^c	1.5	40	1.5		
	5		40 ^c	1.5	60	1.5		
1		50 ^c	1.5	110	1.5			
Equatorial belt	Lower troposphere	5	20	1.5	12 ⁱ	1.5 ^f	20 ^j	
	700	5	10	1.5	12	1.5	20	
	300	10	25	1.5	12	1.5	20	
	100	10	50 ^h	1.5	12	1.5	20	
	10		50 ^h	1.5	12	1.5	20	
	1		50 ^h	1.5	12	1.5		
All latitudes				Height of significant levels				
				15	600			

^a The lowest value (*b*) in low latitudes (20°) in summer is about 15 m.

^b The highest value (*b*) is 240 m (winter, North Atlantic). The lowest value (*b*) is about 25 m (low latitude 20° in summer).

^c These values are much larger in winter; of the order of 100 m at 50 hPa, increasing to 500 m at 5 hPa and 650 m at 1 hPa.

^d Values in this column probably vary with latitude from about 1.5 m at low latitudes to 3 m at high latitudes.

^e Values in this column are typical values for a distance between stations of 300 km in middle latitudes in a direction normal to the wind. They vary with latitude as indicated in Table XXVIII in WMO (1970). Values in the stratosphere are for conditions in summer; they increase considerably in winter, for example, to 50 m at 50 hPa (see paragraph 7.3.5 in WMO (1970)). Limits appropriate to the standard deviation of random errors at single stations are the tabulated values divided by $\sqrt{2}$, when the standard deviations at the stations are equal.

^f Values in this column relate to systematic errors, or to the standard errors of mean values of large numbers of soundings.

^g Provided that sufficiently large samples are available, limit (*b*) is controlled by factors other than the instrumental errors of observation affecting geopotential height determinations (see paragraph 7.3.6 in WMO (1970)).

^h These values vary substantially with circumstances; at different times they can be decreased, or increased, by factors of up to about 3.

ⁱ Random errors with standard deviations of 25 m at any level have some value but degrade the effective network spacing.

^j Values in this column relate to the standard error of short-period (for example, monthly) mean values. Corresponding values for the standard deviation of the instrumental errors which are random from sounding to sounding are $20\sqrt{n}$ m, where *n* is the number of observations available to form a mean.

Notes:

Limit (*a*) — The limit of error beyond which improvement is unnecessary for the stated purpose.

Limit (*b*) — The limit of error beyond which the data obtained will have negligible value for the stated purpose.

(Values are standard deviations of random errors except where otherwise noted; units are geopotential metres.)

ANNEX 12.C

GUIDELINES FOR ORGANIZING RADIOSONDE INTERCOMPARISONS AND FOR THE ESTABLISHMENT OF TEST SITES⁷**PART I — GUIDELINES FOR ORGANIZING RADIOSONDE INTERCOMPARISONS****1. Introduction**

1.1 These guidelines assume that procedures that may be established by various test facilities are consistent with procedures established by other national and international organizations. They also assume that an Organizing Committee will be formed of participants (Members) interested in comparing radiosondes and that at least one non-participant will be included with ability to provide guidance for conducting the intercomparison. The involvement of an independent non-participant is important in order to avoid bias during the planning of the intercomparison. Consideration must also be given to whether radiosonde manufacturers' personnel should actively participate or whether independent operational personnel of the host should prepare and launch such radiosondes.

1.2 All intercomparisons differ from each other to some extent; therefore, these guidelines are to be construed only as a generalized checklist of tasks needing to be accomplished. Modifications should be made by the Organizing Committee, as required, but the validity of the results and scientific evaluation should not be compromised.

1.3 Final reports of previous intercomparisons and organizational meeting reports of other Organizing Committees may serve as an example of the methods that can be adopted for the intercomparison. These previous reports should be maintained and made available by the WMO Secretariat.

2. Objectives of intercomparisons

2.1 The intercomparison objectives must be clear, must list what is expected from the intercomparisons and identify how results will be disseminated. The Organizing Committee is tasked to examine the achievements to be expected from the radiosonde intercomparison

and to identify and anticipate any potential problem. The Organizing Committee's role is to provide guidance, but it must also prepare clear and detailed statements of the main objectives and agree on the criteria to be used in evaluating the results. The Organizing Committee should also determine how best to guarantee the success of the intercomparison by drawing on background knowledge and accumulated experience from previous intercomparisons.

3. Place, date and duration of intercomparison

3.1 The host facility should provide to the Organizing Committee and to the participants a description of the proposed intercomparison site and facilities (locations, etc.), environmental and climatological conditions, and site topography. The host facility should also name a Project Leader or Project Manager who will be responsible for the day-to-day operation and act as the facility point of contact.

3.2 The Organizing Committee should visit the proposed site to determine the suitability of its facilities and to propose changes, as necessary. After the Organizing Committee agrees that the site and facilities are adequate, a site and environmental description should be prepared by the Project Leader for distribution to the participants. The Project Leader, who is familiar with his facility's schedule, must decide the date for the start of the intercomparison, as well as its duration. A copy of this schedule shall be delivered to the Organizing Committee.

3.3 In addition to the starting date of the intercomparisons, the Project Leader should propose a date when his facility will be available for the installation of the participant's equipment and arrange for connections to the data acquisition system. Time should be allowed for all of the participants to check and test equipment prior to starting the intercomparison and to allow additional time to familiarize the operators with the procedures of the host facility.

⁷ Abridged Final Report with Resolutions and Recommendations of the Twelfth Session of the Commission for Instruments and Methods of Observation (WMO-No. 881), Annex II.

4. Participation

4.1 As required, the Project Leader and/or Organizing Committee should invite, through the Secretary-General of WMO, participation of Members. However, once participants are identified, the Project Leader should handle all further contacts.

4.2 The Project Leader should draft a detailed questionnaire to be sent by the Secretary-General to each participant in order to obtain information on each instrument type proposed to be intercompared. Participants are expected to provide information on their space, communication, unique hardware connection requirements, and software characteristics. They also should provide adequate documentation describing their ground and balloon-borne instrumentation.

4.3 It is important that participants provide information about their radiosonde calibration procedures against recognized standards. Although it is expected that operational radiosondes will be intercompared, this may not always be the case; new or research-type radiosondes may be considered for participation with the agreement of all of the participants, the Project Leader, and the Organizing Committee.

5. Responsibilities

5.1 Participants

5.1.1 The participants shall be responsible for the transportation of their own equipment and costs associated with this transportation.

5.1.2 The participants should install and remove their own equipment with the cognizance of the Project Leader. The host facility shall assist with unpacking and packing, as appropriate.

5.1.3 The participants shall provide all necessary accessories, mounting hardware for ground equipment, signal and power cables, spare parts and expendables unique to their system. The participants shall have available (in the event that assistance from the host facility should become necessary) detailed instructions and manuals needed for equipment installation, operation, maintenance and, if applicable, calibration.

5.2 Host facility

5.2.1 The host facility should assist participants in the unpacking and installation of equipment as necessary, and provide storage capability to house

items such as expendables, spare parts and manuals.

5.2.2 The host facility should provide auxiliary equipment as necessary, if available.

5.2.3 The host facility should assist the participants with connections to the host facility's data acquisition equipment, as necessary.

5.2.4 The host shall insure that all legal obligations relating to upper-air measurements (for example, the host country's aviation regulations and frequency utilization) are properly met.

5.2.5 The host facility may provide information on items such as accommodation, local transportation and daily logistics support, but is not obligated to subsidize costs associated with personnel accommodation.

6. Rules during the intercomparison

6.1 The Project Leader shall exercise control of all tests and will keep a record of each balloon launch, together with all the relevant information on the radiosondes used in the flight and the weather conditions.

6.2 Changes in equipment or software will be permitted with the cognizance and concurrence of the Project Leader. Notification to the other participants is necessary. The Project Leader shall maintain a log containing a record of all the equipment participating in the comparison and any changes that occur.

6.3 Minor repairs (for example, fuse replacement, etc.) not affecting instrumentation performance are allowed. The Project Leader should be made aware of these minor repairs and also submit the information to the record log.

6.4 Calibration checks and equipment servicing by participants requiring a specialist or specific equipment will be permitted after notification to the Project Leader.

6.5 Any problem that compromises the intercomparison results or the performance of any equipment shall be addressed by the Project Leader.

7. Data acquisition

7.1 The Organizing Committee should agree on appropriate data acquisition procedures such as

measurement frequency, sampling intervals, data averaging, data reduction (this may be limited to an individual participant's capability), data formats, real-time quality control, post-analysis quality control and data reports.

7.2 All data acquisition hardware and software provided by the host facility should be well tested before commencement of the intercomparison.

7.3 The time delay between observation and delivery of data to the Project Leader shall be established by the Project Leader and agreed by the participants. One hour after the end of the observation (balloon burst) should be considered adequate.

7.4 The responsibility for checking data prior to analysis, the quality control steps to follow, and delivery of the final data rests with the Project Leader.

7.5 Data storage media shall be the Project Leader's decision after taking into consideration the capability of the host facility, but the media used to return final test data to participants may vary in accordance with each of the participant's computer ability. The Project Leader should be cognizant of these requirements.

7.6 The Project Leader has responsibility for providing final data to all participants and, therefore, the host facility must be able to receive all individual data files from each participant.

8. Data processing and analysis

8.1 Data analysis

8.1.1 A framework for data analysis should be encouraged and decided upon even prior to beginning the actual intercomparison. This framework should be included as part of the experimental plan.

8.1.2 There must be agreement among the participants as to methods of data conversion, calibration and correction algorithms, terms and abbreviations, constants, and a comprehensive description of proposed statistical analysis methods.

8.1.3 The Organizing Committee should verify the appropriateness of the analysis procedures selected.

8.1.4 The results of the intercomparisons should be reviewed by the Organizing Committee, who should consider the contents and recommendations given in the final report.

8.2 Data processing and database availability

8.2.1 All essential meteorological and environmental data shall be stored in a database for further use and analysis by the participants. The Project Leader shall exercise control of these data.

8.2.2 After completion of the intercomparison, the Project Leader shall provide a complete set of all of the participants' data to each participant.

9. Final report of the intercomparison

9.1 The Project Leader shall prepare the draft final report which shall be submitted to the Organizing Committee and to the participating members for their comments and amendments. A time limit for reply should be specified.

9.2 Comments and amendments should be returned to the Project Leader with copies also going to the Organizing Committee.

9.3 When the amended draft final report is ready, it should be submitted to the Organizing Committee, who may wish to meet for discussions, if necessary, or who may agree to the final document.

9.4 After the Organizing Committee approves the final document for publication, it should be sent to the Secretariat for publication and distribution by WMO.

10. Final comments

10.1 The Organizing Committee may agree that intermediate results may be presented only by the Project Leader, and that participants may present limited data at technical conferences, except that their own test data may be used without limitation. Once the WMO Secretariat has scheduled the final report for publication, WMO shall make the data available to all Members who request them. The Members are then free to analyse the data and present the results at meetings and in publications.

PART II — GUIDELINES FOR THE ESTABLISHMENT OF TEST SITES

1. Introduction

1.1 In order to support the long-term stability of the global upper-air observing system, it is essential to retain the capability of performing quantitative radiosonde comparisons. Current and new operational radiosonde systems must be checked against references during flight on a regular basis. Members must ensure that a minimum number of test sites with the necessary infrastructure for performing radiosonde comparison tests are retained.

1.2 Experience with the series of WMO Radiosonde Intercomparisons since 1984 has shown that it is necessary to have a range of sites in order to compare the radiosondes over a variety of flight conditions.

1.3 Relative humidity sensor performance is particularly dependent on the conditions during a test, for example, the amount of cloud and rain encountered during ascents, or whether surface humidity is high or low.

1.4 Daytime temperature errors depend on the solar albedo, and hence the surface albedo and cloud cover. Thus, temperature errors found at coastal sites may differ significantly from continental sites. Infrared errors on temperature sensors will not only depend on surface conditions and cloud distribution, but also on atmospheric temperature. Thus, infrared temperature errors in the tropics (for instance near the tropopause) will be quite different from those at mid-latitudes.

1.5 The errors of many upper-wind observing systems depend on the distance the balloon travels from the launch site (and also the elevation of the balloon from the launch site). Thus, comparison tests must cover situations with weak upper winds and also strong upper winds.

2. Facilities required at locations

2.1 Locations suitable for testing should have enough buildings/office space to provide work areas to support the operations of at least four different systems.

2.2 The site should have good quality surface measurements of temperature, relative humidity, pressure and wind, measured near the radiosonde launch sites. Additional reference quality measurements of temperature pressure and relative humidity would be beneficial.

2.3 The test site should have a method of providing absolute measurements of geopotential height during test flights (either using a tracking radar or a Global Positioning System (GPS) radiosonde capable of producing accurate heights).

2.4 Supplementary observing systems, such as laser ceilometers, aerosol lidars, relative humidity lidars, ground-based radiometers and interferometers, may also prove useful.

2.5 The site must be cleared by the national air traffic control authorities for launching larger balloons (3 000 g) with payloads of up to 5 kg. Balloon sheds must be able to cope with launching these large balloons.

3. Suggested geographical locations

3.1 In order to facilitate testing by the main manufacturers, it is suggested that test sites should be retained or established in mid-latitudes in North America, Europe and Asia. Ideally, each of these regions would have a minimum of two sites, one representing coastal (marine) conditions, and another representing conditions in a mid-continent location.

3.2 In addition, it is suggested that a minimum of two test locations should be identified in tropical locations, particularly for tests of relative humidity sensors.

3.3 If the main test sites noted above do not provide adequate samples of extreme conditions for relative humidity sensors (for example, very dry low-level conditions), it may be necessary to identify further test sites in an arid area, or where surface temperatures are very cold (below -30°C in winter).

REFERENCES AND FURTHER READING

- Brousailles, F.J. and J.F. Morrissey, 1974: Residual temperature-induced humidity errors in the National Weather Service radiosonde. *Final Report AFCRL-TR-74-0111*, Instrument Paper No. 215.
- Cole, H. L. and E. Miller, 1995: A correction for low-level radiosonde temperature and relative humidity Measurements. *Ninth AMS Symposium on Meteorological Observations and Instrumentation*, Charlotte, North Carolina, pp. 32–36.
- Garand, L., C. Grassotti, J. Hallé and G.L. Klein, 1992: On differences in radiosonde humidity-reporting practices and their implications for numerical weather prediction and remote sensing. *Bulletin of the American Meteorological Society*, Volume 73, pp. 1417–1423.
- Kursinski, E.R., G.A. Hajj, J.T. Schofield, R.P. Linfield and K.R. Hardy, 1997: Observing Earth's atmosphere with radio occultation measurements using the Global Positioning System. *Journal of Geophysical Research*, Volume 102, pp. 23429–23466.
- Leiterer, U., H. Dier, D. Nagel, T. Naebert, D. Althausen, K. Franke, A. Kats and F. Wagner, 2005: Correction method for RS80-A Humicap humidity profiles and their validation by Lidar backscattering profiles in tropical cirrus clouds. *Journal of Atmospheric and Oceanic Technology*, Volume 22, pp. 18–29.
- McIlveen, J.F.R. and F.H. Ludlam, 1969: The lag of the humidity sensor in the British radiosonde. *Meteorological Magazine*, Volume 98, pp. 233–246.
- Miloshevich, L.M., H. Vömel, A. Paukkunen, A.J. Heymsfield and S.J. Oltmans, 2001: Characterization and correction of relative humidity measurements from Vaisala RS80-A radiosondes at cold temperatures. *Journal of Atmospheric and Oceanic Technology*, Volume 18, pp. 135–156.
- Miloshevich, L.M. A. Paukkunen, H. Vomel and S.J. Oltmans, 2004: Development and validation of a time-lag correction for Vaisala radiosonde humidity measurements. *Journal of Atmospheric and Oceanic Technology*, Volume 21, pp. 1305–1327.
- Nash, J., 1984: *Compatibility of Radiosonde Measurements in the Upper Troposphere and Lower Stratosphere for the Period 1 November 1981 to 31 October 1982*. Meteorological Office, Bracknell, O.S.M. No. 24.
- Nash, J., J.B. Elms and T.J. Oakley, 1995: *Relative humidity sensor performance observed in recent international radiosonde comparisons*. *Ninth AMS Symposium on Meteorological Observations and Instrumentation*, Charlotte, North Carolina, pp. 43–48.
- Paukkunen, A., 1995: *Sensor heating to enhance reliability of radiosonde humidity measurement*. *Ninth AMS Symposium on Meteorological Observations and Instrumentation*, Charlotte, North Carolina, pp. 65–69.
- Richner, H., J. Joss and P. Ruppert, 1996: A water hypsometer utilizing high-precision thermocouples. *Journal of Atmospheric and Oceanic Technology*, Volume 13, pp. 175–182.
- Schmidlin, F.J., H. Sang Lee and B. Ranganayakamma, 1995: *Deriving the accuracy of different radiosonde types using the three-thermistor radiosonde technique*. *Ninth AMS Symposium on Meteorological Observations and Instrumentation*, Charlotte, North Carolina, pp. 27–31.
- Turner, D.D., B.M. Lesht, S.A. Clough, J.C. Liljegren, H.E. Revercomb and D.C. Tobon, 2003: Dry bias and variability in Vaisala RS80-H radiosondes: The ARM experience. *Journal of Atmospheric and Oceanic Technology*, Volume 20, pp. 117–132.
- Turtiainen, H., S. Tammela and I. Stuns, 1995: *A new radiosonde temperature sensor with fast response time and small radiation error*. *Ninth AMS Symposium on Meteorological Observations and Instrumentation*, Charlotte, North Carolina, pp. 60–64.
- Wade, C.G., 1994: An evaluation of problems affecting the measurement of low relative humidity on the United States radiosonde. *Journal of Atmospheric and Oceanic Technology*, Volume 11, pp. 687–700.
- Wade, C.G., 1995: *Calibration and data reduction problems affecting national weather service radiosonde humidity measurements*. *Ninth AMS Symposium on Meteorological Observations and Instrumentation*, Charlotte, North Carolina, pp. 37–42.
- Wang, J., H.L. Cole, D.J. Carlson, E.R. Miller, K. Beierle, A. Paukkunen and T.K. Laine, 2002: Corrections of humidity measurement errors from the Vaisala RS80 radiosonde: Application to TOGA-COARE data. *Journal of Atmospheric and Oceanic Technology*, Volume 19, pp. 981–1002.

- World Meteorological Organization, 1970: *Performance Requirements of Aerological Instruments* (C.L. Hawson). Technical Note No. 112, WMO-No. 267.TP.151, Geneva.
- World Meteorological Organization, 1975: *Upper-Air Sounding Studies. Volume I: Studies on Radiosonde Performance* (A.H. Hooper), Technical Note No. 140, WMO-No. 394, Geneva.
- World Meteorological Organization, 1986: *Algorithms for Automatic Aerological Soundings* (A.H. Hooper). Instruments and Observing Methods Report No. 21, WMO/TD-No. 175, Geneva.
- World Meteorological Organization, 1987: *WMO International Radiosonde Comparison (UK 1984, USA 1985): Final Report* (J. Nash and F.J. Schmidlin). Instruments and Observing Methods Report No. 30, WMO/TD-No. 195, Geneva.
- World Meteorological Organization, 1988: Values of some physical functions and constants used in meteorology. *Technical Regulations*, Volume I, Appendix A, WMO-No. 49, Geneva.
- World Meteorological Organization, 1989a: SRS-400: The new Swiss radiosonde (B. Hoegger, A. Heimo, G. Levrat and J. Rieker). *Papers Presented at the Fourth WMO Technical Conference on Instruments and Methods of Observation (TECIMO-IV)* (Brussels), Instruments and Observing Methods Report No. 35, WMO/TD-No. 303, Geneva, pp. 197–202.
- World Meteorological Organization, 1989b: *Compatibility of Radiosonde Geopotential Measurements* (M. Kitchen). Instruments and Observing Methods Report No. 36, WMO/TD-No. 344, Geneva.
- World Meteorological Organization, 1991: *WMO International Radiosonde Comparison – Phase III, Dzhambul (USSR), 1989: Final Report* (A. Ivanov, A. Kats, S. Kurnosenko, J. Nash and N. Zaitseva). Instruments and Observing Methods Report No. 40, WMO/TD-No. 451, Geneva.
- World Meteorological Organization, 1992: *International Meteorological Vocabulary*. Second edition, WMO-No. 182, Geneva.
- World Meteorological Organization, 1993a: *Historical Changes in Radiosonde Instruments and Practices* (D.J. Gaffen). Instruments and Observing Methods Report No. 50, WMO/TD-No. 541, Geneva.
- World Meteorological Organization, 1993b: *Report by the Rapporteur on Radiosonde Compatibility Monitoring*. Part A: WMO Catalogue of Radiosondes and Upper-air Wind Systems in Use by Members (1993), Part B: Compatibility of Radiosonde Geopotential Measurements 1990, 1991 and 1992 (T. Oakley), Instruments and Observing Methods Report No. 56, WMO/TD-No. 587, Geneva.
- World Meteorological Organization, 1994a: The difference in observed temperatures from radiosondes suspended 10 m and 40 m beneath a 1400 g balloon (J.B. Elms, J. Nash and G. Williams). *Papers Presented at the WMO Technical Conference on Instruments and Methods of Observation (TECO-94)*, Instruments and Observing Methods Report No. 57, WMO/TD-No. 588, Geneva, pp. 121–126.
- World Meteorological Organization, 1994b: Comparison of potential reference radiosonde observations – Results from PREFRS-92 (J. Nash). *Papers Presented at the WMO Technical Conference on Instruments and Methods of Observation (TECO-94)*, Instruments and Observing Methods Report No. 57, WMO/TD-No. 588, Geneva, pp. 115–120.
- World Meteorological Organization, 1995: *Manual on Codes*. Volume I.1, WMO-No. 306, Geneva.
- World Meteorological Organization, 1996a: *WMO International Radiosonde Comparison – Phase IV: Final Report* (S. Yagi, A. Mita and N. Inoue). Instruments and Observing Methods Report No. 59, WMO/TD-No. 742, Geneva.
- World Meteorological Organization, 1996b: *Description and User Guide for the Radiosonde Comparison and Evaluation Software Package (RSKOMP – Version 3/Version 4)* (S. Kurnosenko and T. Oakley). Instruments and Observing Methods Report No. 60, WMO/TD-No. 771, Geneva.
- World Meteorological Organization, 1998: *Report by the Rapporteur on Radiosonde Compatibility Monitoring*. Part A: WMO Catalogue of Radiosondes and Upper-air Wind Systems in Use by Members (1998), Part B: Compatibility of Radiosonde Geopotential Measurements 1995, 1996 and 1997 (T. Oakley), Instruments and Observing Methods Report No. 72, WMO/TD-No. 886, Geneva.
- World Meteorological Organization, 2003a: *Manual on the Global Observing System*. Volume I, WMO-No. 544, Geneva.
- World Meteorological Organization, 2003b: *WMO Catalogue of Radiosondes and Upper-air Wind Systems in Use by Members in 2002 and Compatibility of Radiosonde Geopotential Measurements for Period from 1998 to 2001* (J. Elms). Instruments and Observing Methods Report No. 80, WMO/TD-No. 1197, Geneva.
- World Meteorological Organization, 2003c: *Executive Summary of the WMO Intercomparison of GPS*

Radiosondes (Alcantâra, Maranhão, Brazil, 20 May–10 June 2001). Instruments and Observing Methods Report No. 76, WMO/TD-No. 1153, Geneva.

World Meteorological Organization, 2005a: Preliminary results of WMO intercomparison of high quality radiosonde systems, Mauritius, February 2005 (B. Pathack, J. Nash, R. Smout and S. Kurnosenko). *Papers Presented at the WMO Technical Conference on Meteorological and Environmental Instruments and Methods of*

Observation (TECO-2005), Instruments and Observing Methods Report No. 82, WMO/TD-No. 1265, Geneva.

World Meteorological Organization, 2005b: Results of the RS92 acceptance test performed by the Met Office (UK) (R. Smout, J. Nash, T. Hewison and M. Smees). *Papers Presented at the WMO Technical Conference on Meteorological and Environmental Instruments and Methods of Observation (TECO-2005)*, Instruments and Observing Methods Report No. 82, WMO/TD-No. 1265, Geneva.

CHAPTER 13

MEASUREMENT OF UPPER WIND

13.1 GENERAL

13.1.1 Definitions

The following definitions are taken from the *Manual on the Global Observing System* (WMO, 2003a):

Pilot-balloon observation: A determination of upper winds by optical tracking of a free balloon.

Radiowind observation: A determination of upper winds by tracking of a free balloon by electronic means.

Rawinsonde observation: A combined radiosonde and radiowind observation.

Upper-air observation: A meteorological observation made in the free atmosphere either directly or indirectly.

Upper-wind observation: An observation at a given height or the result of a complete sounding of wind direction and speed in the atmosphere.

This chapter will deal primarily with the pilot-balloon and radiowind observations. Balloon techniques, and measurements using special platforms, specialized equipment, or made indirectly by remote-sensing methods are discussed in various chapters of Part II.

13.1.2 Units of measurement of upper wind

The speed of upper winds is usually reported in metres per second or knots, but kilometres per hour are also used. The direction from which the airflow arrives is reported in degrees from north. In TEMP reports, the wind direction is rounded to the nearest 5°. Reporting to this resolution degrades the accuracy achievable by the best modern windfinding systems, particularly when upper winds are strong. A more accurate wind-direction report, as possible with BUFR code, must be used when the highest accuracy is required.

The geopotential unit used to assign the location in the vertical of upper-air observations is the standard geopotential metre (symbol: m). This is defined as 0.980 665 dynamic metres. In the troposphere, the value of geopotential height is a close approximation to the height expressed in metres. The geopotential heights used in upper-wind reports are

reckoned from sea level, although in many systems the computations of geopotential height will initially be performed in terms of height above the station level.

13.1.3 Meteorological requirements

13.1.3.1 Uses in meteorological operations

Observations of upper winds are essential for operational weather forecasting on all scales and at all latitudes, and are usually used in conjunction with measurements of mass field (temperature and relative humidity). They are vital to the safety and economy of aircraft operations. Uncertainties in upper winds are the limiting factor in the accuracy of modern artillery and are, therefore, important for safety in military operations. Accurate upper wind and vertical wind shear measurements are critical for the launching of space vehicles and other types of rocket. In the boundary layer, upper winds with reliable measurements of vertical wind shear are essential for environmental pollution forecasting.

13.1.3.2 Improvements in reporting procedures

Upper winds are normally input into numerical weather forecasts as layer averages, the thickness of the layers depending on the scales of atmospheric motion relevant to the forecast. The values will not necessarily be input at standard pressures or heights, but will often be centred at pressure heights that vary as the surface pressure changes at the location of the observation. Thus, it is important that the variation in winds between standard levels is accurately represented in upper-wind reports. This is in addition to ensuring that accurate winds are reported at the standard levels.

In earlier years, upper winds were generally processed manually or with a small calculator, and it was impractical to produce detailed reports of the vertical wind structure. However, the advent of cheap computing systems has ensured that all the detailed structure relevant to meteorological operations and scientific research can be processed and reported. The upper-wind reports should contain enough information to define the vertical wind shear across the boundaries between the various layers in the mass fields. For instance, wind shear across

temperature inversions or significant wind shear associated with large changes in relative humidity in the vertical should be reported whenever possible.

When upper winds are reported using either the FM 35-X Ext. TEMP code or the FM 32-IX PILOT code (WMO, 1995), wind speeds are allowed to deviate by as much as 5 m s^{-1} from the linear interpolation between significant levels. The use of automated algorithms with this fitting limit can produce errors in reported messages which are larger than the observational errors. On occasion, the coding procedure may also degrade the accuracy outside the accuracy requirements outlined in Part I, Chapter 12. This can be avoided by a variety of methods. A fitting limit for a wind speed of 3 m s^{-1} instead of 5 m s^{-1} can be implemented as a national practice for TEMP and PILOT messages. The tightening of the fitting limit should lead, on average, to about one significant level wind report per kilometre in the vertical. The TEMP or PILOT report should be visually checked against the detailed upper-wind measurement, and the reported messages should be edited to eliminate unacceptable fitting errors before issue. Reports submitted by using a suitable BUFR code could eliminate the current necessity of choosing significant levels.

13.1.3.3 Accuracy requirements

Accuracy requirements for upper-wind measurements are presented in terms of wind speed and direction in Part I, Chapter 12, Annex 12.A. A summary of performance limits for upper-wind measurements in terms of standard vector errors is found in Part I, Chapter 12, Annex 12.B, Table 1. In addition, systematic errors in wind direction must be kept as small as possible and certainly much less than 5° , especially at locations where upper winds are usually strong. In practice, most well-maintained operational windfinding systems provide upper winds with a standard vector error (2σ) that is greater than or equal to 3 m s^{-1} in the lower troposphere and 5 to 6 m s^{-1} in the upper troposphere and stratosphere (Nash, 1994).

The range of wind speeds likely to be encountered at various locations can also be found in Part I, Chapter 12, Annex 12.B, Table 1. Most upper-wind systems should be capable of measuring winds over a range from 0 to 100 m s^{-1} . Systems primarily used for winds at low levels may not need to cope with such a large range.

The vertical resolution quoted for upper-wind measurements in Part I, Chapter 12, Annex 12.B, Table 1 is 300 to 400 m in the troposphere and 600 to

800 m in the stratosphere. A higher vertical resolution (50 to 150 m) can prove beneficial for general meteorological operations in the atmospheric boundary layer (up to 2 km above the surface). However, the tracking system used must be able to sustain acceptable wind measurement accuracy at the higher vertical resolution if the increased resolution is to be useful.

In Part I, Chapter 12, Annex 12.A, the most stringent requirements for upper-wind measurements are associated with observations of mesoscale atmospheric motions. In addition, very high accuracy upper-wind measurements are often specified for range operations such as rocket launches. The observing schedules required to meet a very high accuracy specification need careful planning since the observations must be located close to the required site and within a given time frame. The following characteristic of atmospheric variability should be noted. The root mean square vector differences between two error-free upper-wind observations at the same height (sampled at the 300 m vertical resolution) will usually be less than 1.5 m s^{-1} if the measurements are simultaneous and separated by less than about 5 km in the horizontal. This will also be the case if the measurements are at the same location, but separated by an interval of less than about 10 min .

13.1.3.4 Maximum height requirements

Upper winds measured from balloon-borne equipment, as considered in this chapter, can be required at heights up to and above 35 km at some sites, especially those designated as part of the Global Climate Observing System. The balloons necessary to reach these heights may be more expensive than the cheap, small balloons that will lift the rawinsonde systems to heights between 20 and 25 km .

An ideal upper-wind observing network must adequately sample all scales of motion, from planetary scale to mesoscale, in the troposphere and lower stratosphere. The observing network will also identify significant small-scale wind structures using high temporal resolution remote-sensing systems. However, in the middle and upper stratosphere, the predominant scales of motion observed for meteorological operations are larger, primarily the planetary scale and larger synoptic scales. Thus, all the upper-air observing sites in a national network with network spacing being optimized for tropospheric observations may not need to measure to heights above 25 km . Overall operating costs may be less if a mix of the observing systems described in this chapter with the sensing

systems described in Part II is used. If this is the case, national technical infrastructure must be able to provide adequate maintenance for the variety of systems deployed.

13.1.4 Measurement methods

Data on upper winds are mainly acquired by using rawinsonde techniques, although pilot-balloon and radiowind observations may be used when additional upper winds data are required without the expense of launching a radiosonde. Observations from the upper-air stations in the Global Observing System are supplemented over land by measurements from aircraft, wind profilers and Doppler weather radars. Over the sea, upper winds are mainly produced by civilian aircraft at aircraft cruise levels. These are supplemented with vertical profiles from rawinsondes launched from ships or remote islands, and also by tracking clouds or water vapour structures observed from geostationary meteorological satellites. In the future, wind measurements from satellite-borne lidars (light detection and ranging) and radars are expected to improve the global coverage of the current observing systems. Sodars (sound detection and ranging), lidars and kite anemometers are also used to provide high temporal resolution winds for specific applications. Low-cost pilotless aircraft technology is being developed for meteorological applications.

The rawinsonde methods for measuring the speed and direction of the wind in the upper air generally depend upon the observation of either the movement of a free balloon ascending at a more or less uniform rate or an object falling under gravity, such as a dropsonde on a parachute. Given that the horizontal motion of the air is to be measured, the target being tracked should not have any significant horizontal motion relative to the air under observation. The essential information required from direct tracking systems includes the height of the target and the measurements of its plan position or, alternatively, its horizontal velocity at known time intervals. The accuracy requirements in Part I, Chapter 12, Annex 12.A, include the effect of errors in the height or pressure assigned to the wind measurement. It is unlikely that the usual operational

accuracy requirements can be met for levels above the atmospheric boundary layer with any tracking method that needs to assume a rate of ascent for the balloon, rather than using a measurement of height from the tracking system or from the radiosonde attached to the target.

Remote-sensing systems measure the motion of the atmosphere by scattering electromagnetic radiation or sound from one or more of the following targets: hydrometeors, dust, aerosol, or inhomogeneities in the refractive index caused by small-scale atmospheric turbulence or the air molecules themselves.

The direct windfinding methods considered in this chapter use targets whose position can be tracked continuously. While the targets can be tracked by a large number of methods, only two widely used types of methods will be considered here.

13.1.4.1 Tracking using a directional aerial

The ground system tracks the target with a directional aerial measuring azimuth, plus any two of the following parameters: elevation angle, slant range, and height. Measurements can be achieved using a primary radar (see section 13.2.4) to track a reflecting target carried by the balloon, a radiotheodolite or secondary radar (see section 13.2.4.2) tracking a radiosonde carried by a balloon, or an optical theodolite tracking a balloon. Radar and radiotheodolite systems usually have a tracking accuracy for elevation and azimuth of about 0.1° , while for radar systems, the range error should normally be less than 30 m.

Modern radiotheodolite systems with antenna dimensions of less than 2 m are best suited for upper-wind measurements when balloon elevations stay above 10 to 15° . Primary radars require skilled staff for successful maintenance and have higher initial capital costs. However, primary radars allow cheap radiowind measurements when radiosonde measurements are not required. Primary radars can also satisfy very high accuracy requirements for upper wind in all conditions. Secondary radar systems are a possible alternative when available from a suitable manufacturer, but successful

Table 13.1. Proportion of occasions when certain slant ranges were exceeded (balloon at 30 km altitude)

Slant range exceeded (km)	140	160	175	190
Proportion of occasions (per cent)	5	2	1	0.5

operation may require too wide a radio-frequency spectrum in the “Meteorological aids bands” to be practical in many countries.

The choice between using a primary radar or a radioteodolite for upper-wind measurements will be partly influenced by the maximum slant range expected at the observation site. A primary radar system or navigational aid (navaid) windfinding system is essential for good measurement accuracy at the longer ranges. The maximum range varies considerably with latitude, with 70 km being adequate in equatorial and polar regions, but with ranges of up to at least 200 km being possible in some mid-latitude temperate zones. Table 13.1 shows the proportion of occasions when certain slant ranges were exceeded for a balloon at 30 km. The data are for stations located in Europe between 50°N and 60°N. The proportions are given for a whole year, but it should be noted that the soundings which exceeded the limits were centred in the winter season.

13.1.4.2 Tracking using radionavigational signals

A radiosonde with the capability of receiving signals from a system of navigational radio transmitters is attached to a target (either an ascending balloon or dropsonde parachute). The changes in either phase (as well as the Doppler shift) or time of arrival of the radionavigation signals received at the radiosonde are used to compute the horizontal motion of the target. The method using surface-based radio beacons, such as Loran, is described in WMO (1985). Radiosonde manufacturers have been offering radiosondes with a satellite-based global positioning system (GPS) since 1995 (WMO, 1994 and Kaisti, 1995). Reliable operations took some time to achieve, but most of the major problems were resolved by the time of the WMO GPS Radiosonde Comparison in Brazil (WMO, 2003*b*). Height measurements with code-correlating GPS systems are now sufficiently accurate to replace pressure sensors in modern radiosondes.

The use of navaid tracking has increased in routine meteorological operations because of the high degree of automation that can be achieved with this type of windfinding system. The level of maintenance required by navaid ground equipment is also very low.

Navaid wind measurement accuracy using terrestrial transmitters depends on the geometry, phase, stability and signal-to-noise ratio of the radionavigational signals available at a given location.

Accuracy will not usually vary too much during flight provided that the reception of the navaid signals by the radiosonde and the reception of the navaid data transmitted from the radiosonde to the ground processing system remain adequate. Navaid radiosondes often experience difficulties in receiving reliable navigation signals immediately after launch.

The quality of navaid measurements may degrade if upper winds are very strong and if reception from the radiosonde by the ground system becomes poor. The build-up of electrostatic charge on the radiosonde navaid aerial during thunderstorms or charged ice clouds often causes long periods of signal loss during flights using Loran navaid systems. The static on the radiosonde aerial will normally discharge later in the flight when satisfactory measurements will again become possible. Radiosonde systems that rely on GPS do not suffer from this problem.

13.2 UPPER-WIND SENSORS AND INSTRUMENTS

13.2.1 Optical theodolite

Optical theodolites may be used for tracking balloons when the expense of radiowind measurements is not justified. Operators need significant training and skill if upper-wind measurement errors are not to increase rapidly as the balloon ascends above the boundary layer.

The optical system of the pilot balloon theodolite should be such that the axis of the eyepiece remains horizontal irrespective of the direction in which the telescope is pointed. A pentagonal prism is preferable to a right-angled prism since a slight displacement of the former does not affect the perpendicularity of the two parts of the optical axis.

The focusing eyepiece of the telescope should be fitted with cross-wires or a graticule and should have a magnification of between 20 and 25 times and a field of view of no less than 2°. The mounting of the theodolite should be of robust construction. It should be possible to turn the theodolite rapidly by hand or slowly by friction or worm gearing on the azimuth and elevation circles. These circles should be subdivided into sections no larger than 1° and should be provided with verniers or micrometer hand wheels allowing the angles to be read to 0.05°, with estimation possible to 0.01°. The scales

should be arranged and illuminated so that readings can be taken by day and night. Backlash in the gearing of the circles should not exceed 0.025° . Errors in horizontal and vertical collimation should not exceed 0.1° .

The theodolite should be fitted with open sights to facilitate the tracking of a rapidly moving balloon. A secondary telescope with a wide field of view of no less than 8° is also useful for this purpose.

The base of the theodolite should be designed to fit into a standard tripod or other support and should incorporate some means of adjustment to allow accurate levelling. It should be possible to adjust the supports to suit the height of the observer. The theodolite should be of robust construction and should be protected against corrosion.

13.2.2 Radiowind systems in general

Radiowind systems were originally introduced to allow measurements of upper wind in the presence of clouds. The systems were also capable of high measurement accuracy at long ranges when balloons were tracked up to heights of 30 km. The use of these systems is now essential to satisfy the majority of modern upper-wind accuracy requirements. The high degree of automation possible with most modern rawinsonde systems has eliminated the need for operator intervention in most of the measurement cycle. This has major advantages in reducing costs for meteorological operations.

13.2.3 Radiotheodolite

Radiotheodolite windfinding is best suited to situations where the balloon elevations from the ground station remain high throughout the flight. If the balloon elevations remain above about 16° , most of the upper-wind accuracy requirements in Part I, Chapter 12, can be met with relatively small tracking aerials. At low balloon elevations, the measurement errors with radiotheodolites increase rapidly with decreasing elevation, even with larger tracking aerials (see section 13.5.3). It is extremely difficult to satisfy the accuracy requirements of Part I, Chapter 12, with a radiotheodolite if upper winds are consistently very strong, unless a transponder is used to provide a measurement of the slant range (see section 13.2.4.2).

A radiotheodolite will usually track the emissions from a radiosonde suspended beneath a weather balloon. A directional aerial coupled to a radio receiver is rotated around the vertical and horizontal axes to determine maximum signal strength using

suitable servo-mechanisms. The radio-frequency employed is usually 1680 MHz. A good aerial design with a diameter of about 2 m should have low sensitivity in its sidelobes relative to the main beam; with this size, angular tracking of 0.1° accuracy can be achieved. If this is the case, the radiotheodolite should be able to track at elevations as low as 6 to 10° without interference between signals received directly from the radiosondes and those received by reflection from adjacent surfaces. Interference between direct and reflected signals is termed multipath interference and is usually the limiting factor in radiotheodolite tracking capability at low elevations. The amount of multipath interference depends very critically on the positioning of the antenna relative to adjacent reflecting surfaces, whether the radiotheodolite is positioned on a roof or on the ground.

Detailed descriptions of the radiotheodolite aerial performance, detection system, servo-controls, and data-processing algorithms should be obtained from the manufacturer prior to purchase. Modern portable radiotheodolites with aerial dimensions of less than 2 m can encounter multipath interference problems at elevations as high as 16° . When multipath interference occurs, the maximum signal will not usually be found in the direction of the balloon. The elevation error varies with time as the multipath interference conditions change as the radiosonde moves; this can lead to large systematic errors in wind data (greater than 10 m s^{-1}).

While the radiotheodolite is tracking the radiosonde, the observed azimuth and elevation angles are transmitted from the radiotheodolite to the ground system computer. The incoming radiosonde measurements give, with time, the variation of geopotential height corresponding to the observed directions. The rates for the change in the position of the balloon can then be derived. The computer should display the upper-wind measurements in tabular or graphical form. The continuity of winds in the vertical will allow the operator to check for faulty tracking. Once the operator is satisfied that tracking is adequate, a suitable upper-wind report can be issued to users.

Balloons will sometimes move in a reverse direction, depending on surface winds, and fly back over the radiotheodolite shortly after launch, even though the balloon is launched upwind of the radiotheodolite. If the radiotheodolite is to sustain accurate automated tracking when this happens, it must be capable of very high scan rates in azimuth and elevation. This leads to a more demanding mechanical specification than is necessary for the

majority of the flights when the balloon is at longer ranges. In order to reduce the mechanical specification needed for accurate tracking, several modern radiotheodolite designs incorporate interferometric tracking. In these systems, the interferometer compares the phase of the signals arriving at different sections of its tracking aerial in order to determine the position of the transmitting source relative to the aerial orientation. In practice, the phase data are sampled at a high rate using micro-processors, while a simple servo-mechanism orientates the aerial approximately in the direction of the radiosonde. The approximate orientation of the aerial is necessary to provide a good signal to noise ratio for the interferometer and to minimize the reflections received from the ground. The elevation and azimuth are then derived from a combination of aerial positions, while the direction to the source is deduced by the interferometer from the phase measurements. The measurement accuracy achieved is similar to that of the better standard radiotheodolites. The interferometric radiotheodolite systems are expected to be more reliable and, thus, cheaper to maintain.

13.2.4 Radar

The essential feature of the radar-tracking technique compared to the radiotheodolite method is that slant range is measured directly together with azimuth and elevation. A primary radar relies on the detection of pulses of ultra-short radio waves reflected from a suitable target carried by the balloon. With a reliable primary radar, the accuracy requirements for upper winds outlined in Part I, Chapter 12, can be met in almost all circumstances. Very high accuracy specifications for upper winds can be met with high-precision tracking radars. For measurement accuracy better than about 1 m^{-1} it is essential to use balloons with sculptured surfaces (which are very expensive) rather than standard meteorological balloons.

A radiosonde does not have to be used in order to determine winds with a primary radar. Substantial savings from minimizing expenditure on radiosondes are possible as long as there is a technical support structure to maintain the radar and staff costs are very low. However, in many countries, the high costs of replacing and operating radars compared with the costs of navaid windfinding systems have led to a decreasing use of primary radar systems for routine meteorological operations.

Most windfinding radar systems comprise a modulator, a radio-frequency oscillator, a direction-finding aerial system, a receiver, and a data-processing unit

to supply slant range, azimuth and elevation to a ground system computer. The modulator produces sharp voltage pulses of about $1 \mu\text{s}$ duration at a rate usually of between 400 and 1 000 pulses per second. These pulses drive a magnetron, causing it to produce bursts of power of several hundred kilowatts, at ultra-high frequency. This energy is transmitted through a wave-guide to the focus of a paraboloidal reflector. When the latter is directed towards the balloon target, pulses are reflected back to the same aerial system and converted by the receiver. The time interval between the emission of the pulse by the magnetron and the reception of the signal back from the balloon target is measured. This is converted into slant range to the target after compensation for signal delays in the detection electronics.

Wavelengths of 3.2, 5.7 and 10.6 cm are used. Those of 3.2 cm allow a smaller aerial to be used for the desired tracking accuracy and, hence, the resultant radar tends to be cheaper. However, signal attenuation in heavy rainfall is much greater at 3.2 cm than at 10.6 cm. Where heavy rainfall is common, the longer wavelengths may have to be used to ensure all-weather observing capability to long ranges.

13.2.4.1 Radar reflectors

The most efficient form of target for the wavelengths indicated above is the corner reflector, consisting essentially of three mutually perpendicular electrically conducting planes. In one design, the top plane – which is horizontal in flight – is a square. A model for longer ranges uses a three-gabled construction with provision to make the reflector rotate. This avoids the possibility of a “null” point lasting for any appreciable time in the target reflectivity observed by the radar. The weight and drag of the target during flight should be as small as possible. The target needs to be collapsible to facilitate storage and transport.

The energy intercepted by a corner in the radar beam is directly proportional to the square of the linear size of the reflector. General radar theory indicates that the ratio of energy received to the energy transmitted by the radar is directly proportional to the square of the reflector size and inversely proportional to the fourth power of the slant range from the radar to the reflector. The reflector used should be large enough to ensure accurate tracking to the largest ranges under the expected meteorological conditions. When upper winds are weak, smaller, cheaper targets may be used.

The performance of corner reflectors depends, to some extent, on the radar wavelength. Short-wavelength radars (3 cm) return more energy from a given target, making low-power systems practicable, but attenuation and immersion of the target in rain are more problematic at short wavelengths.

Corner reflectors of 0.5 to 1 m in size are suitable for most applications. Here, "size" is taken as the length of the outside (hypotenuse) of the triangles forming the corner reflectors. Metal foil glued to paper or expanded polystyrene, or metallized fabric net with a mesh size of about 0.5 cm, or metallized mylar have been successfully used to construct suitable conducting planes. These planes need to be good electrical conductors. For instance, planes with a resistance lower than 20Ω between points 30 cm apart were found to give a satisfactory result. When the reflector is assembled, the target surfaces should be flat planes to within 0.6 cm and the planes should be perpendicular to within 1° .

13.2.4.2 Transponder systems

In secondary radar systems, pulses of energy transmitted from the ground station are received by a responder system carried by the balloon. This can either be a separate transponder package or a feature that is incorporated in the basic radiosonde design. The frequency of the return signal does not necessarily have to be the same as that of the outgoing signal. The time taken between the transmission of the pulse and the response from the responder allows the slant range to be measured directly.

The advantage of this technique over a primary radar is that tracking can be sustained to longer ranges for a given power output from the ground transmitter. This is because the energy transmitted by the responder is independent and usually larger than the energy received from the ground transmitter. Thus, the energy received at the ground receiver is inversely proportional to the square of the slant range of the target. The energy received is inversely proportional to the fourth power of the slant range in the case of a primary radar.

However, if significant numbers of radiowind measurements without simultaneous radiosonde measurements are required at a given location, the cost of operational consumables will be higher with a secondary radar than with a primary radar, and the primary radar may prove to be the most suitable choice.

The complexity of the system and the maintenance requirements of a secondary radar system usually fall between that of radiotheodolites and primary radars.

13.2.5 Navaid tracking systems

In navaid tracking systems, the radiosonde incorporates an aerial system which receives the signals from a radionavigation system. This radionavigation system will be operated by agencies independent of the national weather Services. The primary purpose of the system will usually be the operational navigation of aircraft or ships or navigation in support of military purposes. The navaid systems currently used operationally for windfinding are the Loran systems using ground-based transmitters and the satellite-based GPS.

In order to keep the costs of signal processing in the radiosonde to a minimum, the majority of the processing to produce wind measurements from the navaid signals is performed after the radiosonde has relayed the navaid signals back to the ground system. Thus, good reception from the radiosonde is essential for this windfinding system; the siting of the ground system aerials must provide a good line of sight to the radiosondes in all directions. The radiosonde radio-frequency design must also ensure that faulty modulation of the radiosonde carrier frequency with the navaid signals does not lead to a break-up of the carrier frequency transmitted from the radiosonde to the station.

The accuracy of upper-wind measurements which can be achieved with navaid tracking will vary with the geographical location and navigational signals used. GPS wind measurements are more accurate than wind measurements by most other operational systems.

One of the main advantages of navaid systems is the simplicity of the ground system, which does not consist of moving parts and does not need very accurate alignment of tracking aerials. This makes the systems suitable for deployment from aircraft and ships, as well as from land-based sites.

In the ground-based systems, height is assigned to upper-wind measurements using the radiosonde geopotential height measurements. It is vital that time stamping of the processed navaid wind data by the ground system is accurately aligned with the time stamping of the radiosonde height measurements.

13.2.5.1 Availability of navaid signals in the future

A major change in the availability of navaid signals has occurred. The very low frequency (VLF) Omega system has been decommissioned. International navigational operations have mainly moved to navigation using signals from the array of GPS navigational satellites orbiting the Earth. These satellite signals have largely replaced reliance on signals from fixed terrestrial transmitters. However, for various reasons, some countries have chosen to persist with terrestrial navigational systems for regional or national navigational networks. Navigation authorities must be consulted as to the future availability of signals before any long-term investment in a given system is considered.

The computation of winds using GPS navigation is more complex than with navaid signals from terrestrial transmitters because the satellites move continuously relative to the radiosondes, and the windfinding system must be able to determine at all times the satellite signals received and the position and movement of the satellites. The GPS signals are of a much higher radio-frequency than Loran-C. Thus, GPS signals must be pre-processed to a much higher degree on the radiosonde before transmission to the ground receiver. Hence, GPS radiosondes must incorporate a higher processing capability than has generally been used in radiosondes up to this time. The resultant GPS wind measurement accuracy is better than that of good primary radars.

13.2.5.2 Very low frequency networks

The Russian Alpha navigation network operates at VLF. There are also a limited number of additional regular VLF transmissions of sufficient stability which can also be exploited for wind measurements. The availability of the additional VLF signals on a daily routine basis over a number of years would have to be assured before investing in equipment that could utilize the additional VLF signals.

At the chosen frequencies (wavelengths 22 to 30 km) the ionosphere and the Earth's surface act as a waveguide. The VLF transmitters excite various modes of propagation whose amplitudes and phase velocities vary with the height of the ionosphere, direction of propagation and range from the transmitter. As a result of the presence of many high order modes, the signal phase is difficult to predict and exploit within about 1 000 km of a transmitter. Beyond this range, the phase is a useful linear func-

tion of distance. The height of the ionosphere has a diurnal variation. This produces variations in phase received at a given location from a stationary transmitter, especially if either sunset or sunrise is occurring along most of the path from the transmitter to the receiver. Sporadic signal propagation anomalies occur when the ionosphere is disturbed by X-rays and particle fluxes from the sun, with the most frequent problems linked to the period towards the end of the 11-year cycle in sunspot activity.

The VLF signals received by the radiosonde aerial are used to modulate the radiosonde carrier frequency. The VLF signals are then stripped from the carrier after reception by the radiosonde receiver and fed to the tracker in the ground system. The rates of change of phase of the VLF signals received by the radiosondes are computed relative to an internal reference signal. When using standard hyperbolic computations, the required stability of the reference is only moderate, and a high-quality crystal oscillator proves satisfactory.

13.2.5.3 Loran-C chains

The Loran-C system is a relatively high-accuracy long-range navaid operating in the low frequency band centred on 100 kHz (wavelength 3 km). Because its primary purpose was for marine navigation, particularly in coastal and continental shelf areas, Loran-C coverage was provided only in certain parts of the world. These were mostly in maritime areas of the northern hemisphere. In recent years, ownership of most of the transmitters outside the coastal areas of North America has either changed hands or the stations have been closed. Some of the chains have been refurbished under new ownership to provide regional marine navigational networks. In North America, the Loran-C chains are being modernized and automated.

A Loran-C transmission consists of groups of eight or nine pulses of the 100 kHz carrier, each being some 150 μ s in duration. Each chain of transmitters consists of one master station and two or more slaves. In principle, chain coherence is established by reference to the master transmission. Each slave transmits its groups of pulses at fixed intervals after the master, at a rate that is specific to a given chain. Typically this rate is once every 100 ms.

The Loran-C signals propagate both as ground and sky waves reflected from the ionosphere. The ground waves are relatively stable in propagation. There are only very small phase corrections which are

dependent on whether the signals are propagating across land or sea. The rate of change of the phase corrections as the radiosonde position changes is not usually large enough to affect wind measurement accuracy. Sky wave propagation is more variable since it depends on the position of the ionosphere and will change with time of day. Ground wave signals from the transmitter are much stronger than sky waves, but sky waves attenuate much less rapidly than ground waves. Thus, the best situation for Loran-C windfinding is obtained when the signals received at the radiosonde from all the transmitters are dominated by ground waves. This can be achieved in parts of the Loran-C service areas, but not at all locations within the theoretical coverage.

The Loran-C radiosonde receives the signals through its own aerial and then modulates the radiosonde carrier frequency in order to transmit the signals to the radiosonde receiver. The Loran tracker used to detect the times of arrival of the Loran pulses should be able to differentiate between ground and sky wave signals to some extent. This is achieved by detecting the time of arrival from the leading sections of the pulses. Modern Loran trackers are able to operate in cross-chain mode, so that signals from more than one Loran chain can be used together. This facility is essential for good-quality wind measurements in many parts of the Loran-C service areas. Winds are computed from the rates of change in the time of arrival differences between pairs of Loran-C transmitters. The computations use all the reliable Loran-C signals available, rather than a bare minimum of three.

Loran-C windfinding systems have been used extensively for meteorological research in North America and Europe and for meteorological operations in north-west Europe. Changes in Loran-C chain configurations as transmitter systems, which had been refurbished, have highlighted the requirement that the operational Loran trackers used should be able to adapt to new chain configurations through software adjustments rather than through hardware replacement.

13.2.5.4 Global positioning system

The GPS is a very high-accuracy radionavigation system based on radio signals transmitted from a constellation of 25 satellites orbiting the Earth in six planes. Each of the orbital planes intersects the Equator at a spacing of 60° , with the orbit planes inclined at 55° to the polar axis. An individual satellite orbits during a period of about 11 h and 58 min. The constellation of satellites is configured so that

in any location worldwide a minimum of four satellites appear above the horizon at all times, but, in some situations, up to eight satellites may be visible from the ground.

The signals transmitted from the satellites are controlled by atomic frequency standards intended to provide a frequency stability of better than $1 \cdot 10^{-13}$. Each satellite transmits two unique pseudo-random digital ranging codes, along with other information including constellation almanac, ephemeris, UTC time and satellite performance. The ranging codes and system data are transmitted using biphasic digital spread spectrum technology. The power level of the ranging code signals is -130 dBm, well below thermal background noise.

The following codes are taken into consideration:

- (a) The coarse acquisition code is transmitted on a carrier at 1 575.42 MHz. This is modulated by a satellite-specific pseudo-random noise code with a chipping rate of 1.023 MHz. This modulation effectively spreads the coarse acquisition spectrum width to 2 MHz;
- (b) The precision code may be replaced by a military controlled Y-code during periods when anti-spoofing is active. The precision code and system data are transmitted coherently on carriers L1 (1 575 MHz) and L2 (1 228 MHz).

The wavelengths of the GPS signals are very much shorter than for Loran. The much smaller aerial used for receiving the GPS signals has to be positioned at the top of the radiosonde body and should be free of obstructions in all directions towards the horizon. The small aerial is better protected from the damaging effects of atmospheric electricity than Loran aerials. However, the siting of the GPS aerial may cause a conflict with siting of the temperature sensor on the radiosonde. The temperature sensor also needs to be held above the top of the radiosonde body. (This is to prevent problems in daylight when air heated from flowing over the top of the radiosonde body can then flow over the temperature sensor if it is not held above the top of the radiosonde body.)

The bandwidth of the ranging codes is too wide for the GPS signals to be retransmitted to the ground station from the radiosonde in the manner used for Loran signals. The GPS signals need to be pre-processed on the radiosonde to reduce the GPS information to signals that can be transmitted to the ground station on the radiosonde carrier frequency (either as analogue information, as used for Loran, or as a digital data stream). The

pre-processing can be carried out by a variety of techniques. The first practical radiosonde GPS systems that have been developed use the coarse acquisition code in a differential mode. This requires simultaneous reception of the GPS signals by a receiver at the ground station as well as the receiver on the radiosonde. The satellite almanac and other GPS information are stored in the ground station GPS processor. Accurate wind computations require signals from a minimum of four satellites. In a differential mode, the phase or Doppler shift of the signals received at the radiosonde is referenced to those received at the ground station. This is especially beneficial when the radiosonde is near the ground station, since location errors introduced by propagation delays from the spacecraft to the receivers or by anti-spoofing are similar in both receivers and can be eliminated to a large extent.

GPS tracking systems are able to track accurately at a very high sample rate compared to Loran. Thus, it is possible to measure the modulation of apparent horizontal velocity since the radiosonde swings as a pendulum under the balloon during a period of about 10 s. Upper winds at a very high vertical resolution (50 m) are not required for most purposes, except in the atmospheric boundary layer, and the swinging motions are best filtered out before the upper winds are reported.

Early GPS radiosondes were quite susceptible to external radio-frequency interference, since the radiosonde navaid receiver sensitivity was designed to be adequate for the weak GPS signal strengths. In more recent designs, protection against external radio-frequency interference has been optimized in the radiosonde design.

GPS radiosondes are now used in more than a quarter of the global radiosonde network. The majority of the systems in use since 2005 identify the GPS signals by decoding the coarse acquisition code. These radiosondes are able to provide accurate positions in three dimensions throughout the radiosonde ascent.

The main practical consideration with GPS radiosondes is the time taken for the GPS tracker on the radiosonde to synchronize with the signals being received from the satellite. It is unwise to launch the radiosonde before this synchronization has been achieved. This may require placing the radiosonde outside for several minutes before launch or, alternatively, a method for transmitting GPS signals to the radiosonde at the location where it is being prepared.

13.3 MEASUREMENT METHODS

13.3.1 General considerations concerning data processing

Modern tracking sensors can take readings much more frequently than at the 1 min intervals commonly used with earlier manual systems. The processing of the winds will normally be fully automated using an associated ground system computer. The upper winds will be archived and displayed by the operator for checking before the information is issued to users.

Thus, the sampling of tracking data is optimal at intervals of 10 s or less. Sampling should be at the highest rate considered useful from the tracking system. High sampling rates make it easier to control the quality of the data with automated algorithms. After editing, the tracking data can then be smoothed by statistical means and used to determine the variation in position with time, if required. The smoothing applied will determine the thickness of the atmospheric layer to which the upper-wind measurement applies. The smoothing will often be changed for different parts of the flight to account for the differing user requirements at different heights and the tracking limitations of the upper-wind system used. If measurement accuracy drops too low at higher levels, the vertical resolution of the measurement may have to be reduced below the optimum requirement to keep the wind measurement errors within acceptable limits.

Effective algorithms for editing and smoothing may use low-order polynomials (Acheson, 1970), or cubic splines (de Boor, 1978). Algorithms for computing winds from radar and radiotheodolite observations can be found in WMO (1986). In general, winds may either be derived from differentiating positions derived from the tracking data, or from the rates of change of the smoothed engineering variables from the tracking system (see Passi, 1978). Many modern systems use this latter technique, but the algorithms must then be able to cope with some singularities in the engineering variables, for instance when a balloon transits back over the tracking site at high elevation.

When the winds computed from the tracking data are displayed for checking, it is important to indicate those regions of the flight where tracking data were missing or judged too noisy for use. Some of the algorithms used for interpolation may not be very stable when there are gaps in the tracking data. It is important to differentiate between reliable measurements of vertical wind shear and shears that are artefacts of the automated data processing when

tracking data are absent. Tracking data are often of poor quality early in a balloon ascent. If the upper-wind system is unable to produce a valid wind measurement shortly after launch, it is preferable to leave a gap in the reported winds until valid tracking data are obtained. This is because interpolation between the surface and the first levels of valid data often requires interpolation across layers of marked wind shear in the vertical. The automated algorithms rarely function adequately in these circumstances.

It has been suggested that upper-wind systems should use more than one tracking method to improve the quality assurance of the observations. In these circumstances, an optimum solution for dealing with the positional information could be found through the least-squares method applied to the overdetermined system of non-linear equations (see Lange, 1988, and Passi, 1978). This type of analysis could also be applied for the interpretation of tests where a balloon is tracked simultaneously by more than one system.

13.3.2 Pilot-balloon observations

The accurate levelling and orientation of the optical theodolite with respect to the true north are an essential preliminary to observing the azimuth and elevation of the moving balloon. Readings of azimuth and elevation should be taken at intervals of no less than 1 min. Azimuth angles should be read to the nearest tenth of a degree. In a pilot-balloon ascent, the elevation angles should be read to the nearest tenth of a degree whenever the angles are 15° or greater. It is necessary to measure elevation to the nearest 0.05° whenever the angles are less than 15° .

If a radiosonde ascent is being followed by optical theodolite, a higher upper-wind measurement accuracy can be achieved at lower elevations. Thus, the elevation angles should be read to the nearest tenth of a degree whenever the angles are greater than 20° , to the nearest 0.05° whenever the angles are 20° or less, but greater than 15° , and to the nearest 0.01° whenever the angles are 15° or less. Timing may be accomplished by either using a stop-watch or a single alarm clock which rings at the desired intervals.

In single-theodolite ascents, the evaluation of wind speed and direction involves the trigonometric computation of the minute-to-minute changes in the plane position of the balloon. This is best achieved by using a pocket calculator.

If higher accuracy is required, the double-theodolite technique should be used. The baseline between the instruments should be at least 2 km long,

preferably in a direction nearly at right angles to that of the wind prevailing at the time. Computations are simplified if the two tracking sites are at the same level. Communication between the two sites by radio or land-line should help to synchronize the observations from the two sites. Synchronization is essential if good measurement accuracy is to be achieved. Recording theodolites, with the readings logged electronically, will be helpful in improving the measurement accuracy achieved.

For multiple-theodolite tracking, alternative evaluation procedures can be used. The redundancy provided by all the tracking data allows improved measurement accuracy, but with the added complication that the calculations must be performed on a personal computer (see Lange, 1988, and Passi, 1978).

13.3.3 Observations using a directional aerial

Windfinding systems that track using directional aeriels require very careful installation and maintenance procedures. Every effort must be made to ensure the accuracy of elevation and azimuth measurements. This requires accurate levelling of the installation and careful maintenance to ensure that the orientation of the electrical axis of the aerial remains close to the mechanical axis. This may be checked by various methods, including tracking the position of local transmitters or targets of known position. Poor alignment of the azimuth has caused additional errors in wind measurement at many upper air stations in recent years.

The calibration of the slant range of a primary radar may be checked against known stationary targets, if suitable targets exist. The tracking of the radar in general may be checked by comparing radar geopotential heights with simultaneous radiosonde measurements. The corrections to the radar height measurements for tracking errors introduced by atmospheric refraction are discussed in section 13.7.

At heights up to about 24 km, the comparison of radar height measurements with radiosonde geopotential heights may be used to identify radar tracking which fails to meet the standards. Furthermore, if the radar slant range measurements are known to be reliable, it is possible to identify small systematic biases in elevation by comparing radar heights with radiosonde heights as a function of the cotangent of elevation. The typical errors in radiosonde geopotential height were established

for the most widely used radiosondes by WMO (1987).

Both radar and radiotheodolite systems can encounter difficulties when attempting to follow a target at close ranges. This is because the signal strength received by a sidelobe of the aerial may be strong enough to sustain automated tracking at short ranges; however, when tracking on a sidelobe, the signal strength received will then drop rapidly after a few minutes and the target will apparently be lost. Following target loss, it may be difficult to recover tracking with some systems when low cloud, rain or fog is present at the launch site. Thus, it is necessary to have a method to check that the target is centred in the main beam early in flight. This check could be performed by the operator using a bore-sight, telescope or video camera aligned with the axis of the aerial. The tracking alignment is more difficult to check with an interferometric radiotheodolite, where the mechanical tracking of the radiotheodolite will not necessarily coincide exactly with the observed direction of travel of the balloon.

13.3.4 **Observations using radionavigational systems**

In order to derive satisfactory upper-wind measurements from ground-based radionavigation systems, it is necessary for the radiosonde to receive signals from at least three stations. The difference in the time of arrival of the navigation signals received by the radiosonde, after coherent transmission from two locations, defines a locus or line of position (see WMO, 1985). This will have the shape of a hyperbola on a plane (but becomes an ellipse on the surface of a sphere). Thus, navigational systems using this technique are termed hyperbolic systems. Two intersecting lines of position are sufficient to define plan positions. However, there may be a large error in position associated with a small error in time of arrival if the lines of position are close to parallel when they intersect. With navaid upper-wind systems, it has been clearly demonstrated that all available navaid signals of a given type (usually at least four or five) should be used to improve tracking reliability. One type of algorithm used to exploit all the navaid signals available was outlined in Karhunen (1983).

The geometry for using satellite navigation signals is such that GPS windfinding algorithms seem to work most reliably when signals are received from at least eight satellites during the ascent. The GPS almanac can be used to identify times when satellite geometry is weak for windfinding. In

practice, this does not occur very often with the current satellite configuration.

When making upper-wind measurements with navaid tracking systems, the ground system navaid tracker should be accurately synchronized to the navaid transmissions prior to launch. Synchronization is usually achieved by using signals received by a local aerial connected to the ground system receiver. This aerial should be capable of receiving adequate signals for synchronization in all the weather conditions experienced at the site.

The ground system must also provide clear indications to the operator of the navaid signals available for windfinding prior to launch and also during the radiosonde flight.

Once launched, the navaid windfinding systems are highly automated. However, estimates of the expected measurement errors based on the configuration and quality of the navaid signals received would be helpful to the operators. During flight, the operator must be able to identify faulty radiosondes with poor receiver or transmitter characteristics which are clearly providing below-standard observations. These observations need to be suppressed and a re-flight attempted, where necessary.

13.4 **EXPOSURE OF GROUND EQUIPMENT**

An appropriate site for a radiotheodolite or radar is on high ground, with the horizon being as free from obstructions as possible. There should be no extensive obstructions subtending an angle exceeding 6° at the observation point. An ideal site would be a symmetrical hill with a downward slope of about 6° for a distance of 400 m, in a hollow surrounded by hills rising to a 1° or 2° elevation.

The tracking system should be provided with a firm foundation on which the equipment can be mounted. Good reception of signals by a local navaid aerial and by the ground system aerial for the radiosonde is essential if the navaid measurements are to be successful. These aerials should be mounted in positions on the upper-air site where there is a good horizon for reception in all directions.

Upper-wind measurements are usually reported in association with surface-wind measurements. It is preferable that surface wind be obtained from a site close to the balloon launch site. The launch site should be chosen to provide winds that are appropriate to the purpose of the upper-wind

measurement. For example, if the upper-wind measurement is required to detect a localized effect influencing an airfield, the optimum location might differ from a site needed to observe meso-scale and synoptic scale motions over a larger area.

13.5 SOURCES OF ERROR

13.5.1 General

Errors in upper-wind measurements are a combination of the errors resulting from imperfect tracking of the horizontal motion of the target, the errors in the height assigned to the target, and the differences between the movement of the target and the actual atmospheric motion.

13.5.1.1 Target tracking errors

The relationship between wind errors and tracking errors differs according to the method of observation. For some systems, such as radiotheodolites, the wind errors vary markedly with range, azimuth and elevation, even when the errors of these tracking parameters remain constant with time. On the other hand, wind errors from systems using navaid tracking do not usually vary too much with range or height.

The uncertainties caused by the manual computation of wind were evaluated in WMO (1975). It was concluded that the risks of introducing significant errors by using manual methods for wind computations (such as plotting tables, slide rules, etc.) were too great, and that upper-wind computations should be automated as far as possible.

The measurement accuracy of all upper-wind systems varies from time to time. This variation may occur for short periods during a given target flight, when tracking temporarily degrades, or during an entire flight, for instance if the transmitted signals from a navaid radiosonde are faulty. At some locations, the accuracy of upper-wind tracking may gradually degrade with time over several months because of either instability in the tracking capability or the set-up of the ground system. In all cases, it would be helpful if estimates of wind measurement accuracy were derived by the upper-wind systems in real time to supplement the reported upper-wind measurements. The reported errors would allow poorer quality measurements to be identified and less weight would be given in numerical analyses. The reporting of errors could be

achieved in practice by using the appropriate TEMP or PILOT codes and BUFR tables (WMO, 1995).

When errors in target tracking start to introduce unacceptable wind errors at a given vertical resolution, the situation is usually compensated by computing the winds at a lower vertical resolution. For much of the time, upper winds do not change very rapidly in the vertical. It is often difficult to find any large difference between an upper-wind measurement made at a 150 m vertical resolution and a measurement made at a 1.2 km vertical resolution.

The practice of reducing the vertical resolution of upper-wind measurements in steps through the upper troposphere and lower stratosphere was mainly adopted to overcome the tracking limitations of radiotheodolites. This practice is not justified by the actual vertical structure observed in the atmosphere. Many of the larger vertical wind shears are found in the upper levels of jet streams at heights between 10 and 18 km (see, for instance, the detailed vertical wind profiles presented in Nash, 1994).

13.5.1.2 Height assignment errors

Height assignment errors are not usually significant unless the height is derived from time into flight and an assumed rate of ascent for the balloon.

However, the testing of fully automated upper-wind systems has often revealed discrepancies between the times assigned to wind observations and those assigned to the associated radiosonde measurements. In some cases, the wind timing was not initiated at the same time as that of the radiosonde, in others synchronization was lost during flight for a variety of reasons. In several other systems, the times assigned to the reported winds were not those corresponding to the data sample used to compute the wind, but rather to the time at the beginning or end of the sample. All types of timing error could produce large errors in the heights assigned to wind measurements and need to be eliminated in reliable operational systems.

13.5.1.3 Target motion relative to the atmosphere

The motion of the target relative to the air will be most significant for systems with the highest tracking accuracy and highest vertical resolution. For instance, the swinging of the GPS radiosonde under a balloon is clearly visible in the GPS tracking measurements and must be filtered out as far as possible.

The balloon motion relative to the atmosphere, introduced by the shedding of vortices by the balloon wake, may result in errors as large as 1 to 2 m s⁻¹ (2σ level) when tracking small pilot balloons (50 g weight) at vertical resolutions of 50 m. Balloon motion errors are less significant in routine operational measurements (vertical resolutions of about 300 m) where measurements are obtained by tracking larger balloons (weight exceeding 350 g).

The horizontal slip of the dropsonde parachutes relative to the atmosphere may also be the limiting factor in the accuracy of GPS dropsonde measurements. The descent rates used in dropsonde deployments are usually about twice the ascent rate of operational radiosonde balloons.

13.5.2 Errors in pilot-balloon observations

The instrumental errors of a good optical theodolite are not likely to exceed ±0.05°. The errors may vary slowly with azimuth or elevation but are small compared with the errors introduced by the observer. Errors of reading scales should not exceed 0.1°. These errors become increasingly important at long ranges and when working at low elevations.

In single-theodolite ascents, the largest source of error is the uncertainty in the balloon rate of ascent. This uncertainty arises from variations in filling the balloon with gas, in the shape of the balloon, and in the vertical velocity of the atmosphere through which the balloon ascends. A given proportional error in the rate of ascent results in a proportional error in the height of the balloon and, hence, as modified by elevation angle, a proportional error in wind speed.

In double-theodolite ascents, the effect of system errors depends upon the method of evaluation adopted. Error analyses have been provided by Schaefer and Doswell (1978).

13.5.3 Errors of systems using a directional aerial

The relationship between vector wind errors and the errors of the actual tracking measurements can be expressed as an approximate function of height and mean wind (or ratio of the latter to the mean rate of ascent of the balloon). The relationships for random errors in primary radar and radiotheodolite wind measurements are as follows:

- (a) Primary or secondary radar measuring slant range, azimuth and elevation:

$$\varepsilon_v^2 = 2 \times [\varepsilon_r^2 \times Q^2 / (Q^2 + 1) + \varepsilon_\theta^2 \times h^2 + \varepsilon_\phi^2 \times h^2 \times Q^2] / t^2 \quad (13.1)$$

- (b) Optical theodolite or radiotheodolite and radiosonde measuring azimuth, elevation angle and height:

$$\varepsilon_v^2 = 2 \times [\varepsilon_h^2 \times Q^2 + \varepsilon_\theta^2 \times h^2 \times (Q^2 + 1)^2 + \varepsilon_\phi^2 \times h^2 \times Q^2] / t^2 \quad (13.2)$$

where ε_v is the vector error in computed wind; ε_r is the random error in the measurement of slant range; ε_θ is the random error in the measurement of elevation angle; ε_ϕ is the random error in the measurement of azimuth; ε_h is the random error in height (derived from pressure measurement); Q is the magnitude of mean vector wind up to height h divided by the mean rate of ascent of the balloon up to height h ; and τ is the time interval between samples.

Table 13.2 illustrates the differences in vector wind accuracy obtained with these two methods of upper-wind measurement. The mean rate of ascent used in upper-wind measurements will usually be in the range of 5 to 8 m s⁻¹. The vector wind error values are derived from equations 13.1 and 13.2 for various heights and values of Q , for a system tracking with the following characteristics: ε_r 20 m; ε_θ 0.1°; ε_ϕ 0.1°; ε_h height error equivalent to a pressure error of 1 hPa; τ 1 m.

Table 13.2 demonstrates that measurements with a radio (or optical) theodolite clearly produce less accurate winds for a given tracking accuracy than primary or secondary radars.

In the expressions for vector error in the computed winds in equations 13.1 and 13.2, the first two terms within the square brackets represent the radial error and the error in the winds observed with the same azimuth as the tracking aerial. The third term in the square brackets represents the tangential error, the error in winds observed at right angles to the azimuth of the tracking aerial. With these types of upper-wind systems, the error distribution is not independent of the directions and cannot be adequately represented by a single parameter. Thus, the values in Table 13.2 indicate the size of the errors but not the direction in which they act.

When the tangential and radial errors are very different in size, the error distribution is highly elliptic and the combined errors tend to concentrate either parallel to the axis of the tracking antenna or perpendicular to the axis.

Table 13.3 shows the ratio of some of the tangential and radial errors that are combined to give the vector errors in Table 13.2. Values above 3 in Table 13.3 indicate situations where the tangential error component dominates. Thus, in radar windfinding, the tangential errors dominate at longer ranges (high mean winds and hence high Q values, plus largest heights). With radiotheodolite windfinding, the radial errors dominate at longer ranges and the ratios become

very much smaller than 1. Errors in elevation angle produce the major contribution to the radiotheodolite radial errors. However, random errors in the radiosonde height make the most significant contribution at high altitudes when values of Q are low.

The results in Tables 13.2 and 13.3 are based on a theoretical evaluation of the errors from the different types of systems. However, it is assumed

Table 13.2. 90 per cent vector error ($m s^{-1}$) as a function of height and ratio Q of mean wind to rate of ascent

Q	Radar						Radiotheodolite					
	ε_v 5 km	ε_v 10 km	ε_v 15 km	ε_v 20 km	ε_v 25 km	ε_v 30 km	ε_v 5 km	ε_v 10 km	ε_v 15 km	ε_v 20 km	ε_v 25 km	ε_v 30 km
1	1	1	1.5	1.5	2.5	2.5	1	1.5	3	5.5	9	25
2	1	1.5	2.5	3	4	4	5	4	6.5	11	19	49
3	1.5	2.5	3	4	5	6	4	7	11	19	30	76
5	1.5	3	5	6	2.5	10	9	18	27	42	59	131
7	2.5	5	7	9	11	13	18	34	51	72	100	194
10	3	6.5	10	13	16	19	34	67	100	139	182	310

Notes: This table does not include the additional errors introduced by multipath interference on radiotheodolite observations. Additional errors can be expected from these effects for values of Q between 7 and 10.

In practice, radiotheodolite wind observations are smoothed over thicker layers than indicated in these calculations at all heights apart from 5 km. Thus, at heights of 15 km and above, the radiotheodolite errors should be divided by at least a factor of four to correspond to operational practice.

Table 13.3. Ratio of upper-wind error components ($\alpha_{\varepsilon v}$ = tangential error/radial error α)

Q	Radar						Radiotheodolite					
	$\alpha_{\varepsilon v}$ 5 km	$\alpha_{\varepsilon v}$ 10 km	$\alpha_{\varepsilon v}$ 15 km	$\alpha_{\varepsilon v}$ 20 km	$\alpha_{\varepsilon v}$ 25 km	$\alpha_{\varepsilon v}$ 30 km	$\alpha_{\varepsilon v}$ 5 km	$\alpha_{\varepsilon v}$ 10 km	$\alpha_{\varepsilon v}$ 15 km	$\alpha_{\varepsilon v}$ 20 km	$\alpha_{\varepsilon v}$ 25 km	$\alpha_{\varepsilon v}$ 30 km
1	1/2	1	1	1	1	1	1/3	1/2	1/3	1/4	1/5	1/13
2	1	1	2	2	2	2	1/3	1/3	1/3	1/4	1/6	1/13
3	1	2	2	3	3	3	1/4	1/4	1/4	1/5	1/6	1/13
5	1	3	4	4	5	5	1/5	1/5	1/6	1/6	1/7	1/14
7	3	5	5	6	6	7	1/7	1/7	1/7	1/7	1/9	1/14
10	4	7	8	9	9	9	1/10	1/10	1/10	1/11	1/11	1/16

that winds are computed from a simple difference between two discrete samples of tracking data. The computations take no account of the possible improvements in accuracy from deriving rates of change of position from large samples of tracking information obtained at high temporal resolution. Table 13.4 contains estimates of the actual measurement accuracy achieved by a variety of radars and radiotheodolites in the four phases of the WMO International Radiosonde Comparison (see section 13.6.1.2 for references to the tests).

Of the three radiotheodolites tested in the WMO International Radiosonde Comparison, the Japanese system coped best with high Q situations, but this system applied a large amount of smoothing to elevation measurements and did not measure vertical wind very accurately in the upper layers of the jet streams. The smaller portable radiotheodolite deployed by the United

States in Japan had the largest wind errors at high Q because of problems with multipath interference.

The ellipticity of the error distributions for radar and radiotheodolite observations showed the tendencies predicted at high values of Q . However, the ellipticity in the errors was not as high as that shown in Table 13.3, probably because the random errors in the rates of change of the azimuth and elevation were, in practice, smaller than those taken for Table 13.3.

13.5.4 Errors in ground-based radionavigational systems

Navaid system errors depend on the phase stability of navaid signals received at the radiosonde and upon the position of the radiosonde relative to the navaid network transmitters. However, the quality of the telemetry link between the radiosonde and

Table 13.4. Estimates of the typical random vector errors (2σ level, unit: m s^{-1}) in upper-wind measurements obtained during the WMO International Radiosonde Comparison (estimates of typical values of Q and α_{ε_v} for each of the four phases are included)

<i>System</i>	ε_v 3 km	α_{ε_v} 3 km	Q 3 km	ε_v 18 km	α_{ε_v} 18 km	Q 18 km	ε_v 28 km	α_{ε_v} 28 km	Q 28 km	Test site
Primary radar (United Kingdom)	1.1	1	3.5	2.1	1.3	5	2.7	1.6	5	United Kingdom ^a
Radiotheodolite (United States)	2.1	≈ 1	1.5	4.8	≈ 1	2.5	5.2	≈ 1	1	United Kingdom
Radiotheodolite (United States)	2.8	≈ 1	2.5	10.4	0.4	6	9	0.33	4	United States
Radiotheodolite, portable	1.5	≈ 1	< 1	4.8	≈ 1	3	5.8	≈ 1	1.5	Kazakhstan
Radiotheodolite, portable	2.2	≈ 1	1.5	12	0.31	5.5	9	0.23	4	Japan
Radiotheodolite (Japan)	1.7	≈ 1	1.5	6.4	0.48	5.5	4.7	0.48	4	Japan
Secondary radar (AVK, Russian Federation)	1.5	≈ 1	< 1	2.6	≈ 1	3	2.6	≈ 1	1.5	Kazakhstan
Secondary radar (China)	1.5	≈ 1	< 1	3.8	≈ 1	3	3.4	≈ 1	1.5	Kazakhstan

^a Data obtained in the United Kingdom test following Phase I of the WMO International Radiosonde Comparison (see Edge and others, 1986).

the ground receiver cannot be ignored. In tests where radiosondes have moved out to longer ranges (at least 50 to 100 km), wind errors from the navaid windfinding systems are found to increase at the longer ranges, but usually at a rate similar to or less than the increase in the range for a primary radar. Signal reception from a radiosonde immediately after launch is not always reliable. Loran-C wind measurements have larger errors immediately after launch than when the radiosonde has settled down to a stable motion several minutes into flight.

Navaid wind measurement accuracy is mainly limited by the signal-to-noise ratios in the signals received at the radiosonde. Integration times used in practice to achieve reliable windfinding vary, from 30 s to 2 min for Loran-C signals and less than 1 min for GPS signals. Signal strength received at a given location from some Loran-C transmitters may fluctuate significantly during the day. This is usually because, under some circumstances, the diurnal variations in the height and orientation of the ionospheric layers have a major influence on signal strength. The fluctuations in signal strength and stability can be so large that, in some locations, successful wind measurement with Loran-C may not be possible at all times of the day.

A second major influence on measurement accuracy is the geometric dilution of precision of the navigation system accuracy, which depends on the location of the radiosonde receiver relative to the navaid transmitters. When the radiosonde is near the centre of the baseline between the two transmitters, a given random error in the time of arrival difference from two transmitters will result in a small random positional error in a direction that is parallel to the baseline between the transmitters. However, the same random error in the time of arrival difference will produce a very large positional error in the same direction if the radiosonde is located on the extension of the baseline beyond either transmitter. The highest accuracy for horizontal wind measurements in

two dimensions requires at least two pairs of navaid transmitters with their baselines being approximately at right angles, with the radiosonde located towards the centre of the triangle defined by the three transmitters. In practice, signals from more than two pairs of navaid transmitters are used to improve wind measurement accuracy whenever possible. Techniques using least squares solutions to determine the consistency of the wind measurements obtained prove useful in determining estimates of the wind errors.

Disturbance in the propagation of the signals from the navaid network transmitters is another source of error.

13.5.4.1 Loran-C windfinding systems

Commercially available systems produce wind data of good quality, as illustrated in Table 13.5. The measurement quality obtained when working with mainly ground-wave signals was derived from installation tests in the British Isles as reported by Nash and Oakley (1992). The measurement quality obtained when working with transmitters at longer ranges, where sky waves are significant, was estimated from the results of Phase IV of the WMO International Radiosonde Comparison in Japan (see WMO, 1996).

13.5.5 Errors in the global positioning system windfinding systems

In theory, GPS windfinding systems using coarse acquisition ranging codes in a differential mode should be capable of measuring winds to an uncertainty of 0.2 m s^{-1} . The estimates of accuracy in Table 13.5 were made on the basis of recent WMO tests of GPS radiosondes. The main difference between systems comes from the filtering applied to the winds to remove the pendulum motion of the radiosonde. GPS wind measurements are at least as reliable as the very best primary radar measurements in the long term.

Table 13.5. Random error (2 level) and systematic bias expected from navaid windfinding systems in areas where the coverage of navaid signals is close to optimum

<i>System</i>	<i>Averaging time (s)</i>	<i>Systematic bias (m s^{-1})</i>	<i>Random error (m s^{-1})</i>
Loran-C (ground wave)	30 – 60	up to ± 0.2	0.6 – 3
Loran-C (sky wave)	60 – 120	up to ± 0.2	1.6 – 4
GPS	5	up to ± 0.1	0.2 – 0.6

13.6 **COMPARISON, CALIBRATION AND MAINTENANCE**

13.6.1 **Comparison**

Upper-wind systems are usually fairly complex, with a number of different failure modes. It is not uncommon for the systems to suffer a partial failure, while still producing a vertical wind structure that appears plausible to the operators. Many of the systems need careful alignment and maintenance to maintain tracking accuracy.

The wind measurement accuracy of operational systems can be checked by reference to observation monitoring statistics produced by numerical weather prediction centres. The monitoring statistics consist of summaries of the differences between the upper-wind measurements from each site and the short-term forecast (background) fields for the same location. With current data assimilation and analysis techniques, observation errors influence the meteorological analysis fields to some extent. Thus, it has been shown that observation errors are detected most reliably by using a short-term forecast from an analysis performed 6 h before the observation time.

The performance of upper-wind systems can also be compared with other systems of known measurement quality in special tests. These tests can allow tracking errors to be evaluated independently of height assignment errors.

Both types of comparisons may be interpreted using the statistical methods proposed in WMO (1989).

13.6.1.1 **Operational monitoring by comparison with forecast fields**

The statistics for daily comparisons between operational wind measurements and short-term forecast fields of numerical weather prediction models can be made available to system operators through the lead centres designated by the WMO Commission for Basic Systems.

Interpretation of the monitoring statistics for upper winds is not straightforward. The random errors in the forecast fields are of similar magnitude or larger than those in the upper-wind system if it is functioning correctly. The forecast errors vary with geographical location, and guidance for their interpretation from the numerical weather prediction centre may be necessary. However, it is relatively easy to identify upper-wind systems

where the random errors are much larger than normal. In recent years, about 6 per cent of the upper-wind systems in the global network have been identified as faulty. The system types associated with faulty performance have mainly been radiotheodolites and secondary radar systems.

Summaries of systematic biases between observations and forecast fields over several months or for a whole year are also helpful in identifying systematic biases in wind speed and wind direction for a given system. Small misalignments of the tracking aerials of radiotheodolites or radars are a relatively common fault.

13.6.1.2 **Comparison with other windfinding systems**

Special comparison tests between upper-wind systems have provided a large amount of information on the actual performance of the various upper-wind systems in use worldwide. In these tests, a variety of targets are suspended from a single balloon and tracked simultaneously by a variety of ground systems. The timing of the wind reports from the various ground stations is synchronized to better than 1 s. The wind measurements can then be compared as a function of time into flight, and the heights assigned to the winds can also be compared independently. The interpretation of the comparison results will be more reliable if at least one of the upper-wind systems produces high-accuracy wind measurements with established error characteristics.

A comprehensive series of comparison tests was performed between 1984 and 1993 as part of the WMO International Radiosonde Comparison. Phases I and II of the tests were performed in the United Kingdom and United States, respectively (WMO, 1987). Phase III was performed by the Russian Federation at a site in Kazakhstan (WMO, 1991), and Phase IV was performed in Japan (WMO, 1996).

The information in Tables 13.4 and 13.5 was primarily based on results from the WMO International Radiosonde Comparison and additional tests performed on the same standard as the WMO tests.

Once the development of GPS windfinding systems is complete, it is hoped that these systems will be useful as reliable travelling standards for upper-wind comparison tests in more remote areas of the world.

13.6.2 Calibration

The calibration of slant range should be checked for radars using signal returns from a distant object whose location is accurately known. Azimuth should also be checked in a similar fashion.

The orientation of the tracking aerials of radiotheodolites or radars should be checked regularly by comparing the readings taken with an optical theodolite. If the mean differences between the theodolite and radar observations of elevation exceed 0.1° , the adjustment of the tracking aerial should be checked. When checking azimuth using a compass, the conversion from geomagnetic north to geographical north must be performed accurately.

With navaid systems, it is important to check that the ground system location is accurately recorded in the ground system computer. The navaid tracking system needs to be configured correctly according to the manufacturer's instructions and should be in stable operation prior to the radiosonde launch.

13.6.3 Maintenance

Radiotheodolites and radars are relatively complex and usually require maintenance by an experienced technician. The technician will need to cope with both electrical and mechanical maintenance and repair tasks. The level of skill and frequency of maintenance required will vary with the system design. Some modern radiotheodolites have been engineered to improve mechanical reliability compared with the earlier types in use. The cost and feasibility of maintenance support must be considered important factors when choosing the type of upper-wind system to be used.

Electrical faults in most modern navaid tracking systems are repaired by the replacement of faulty modules. Such modules would include, for

instance, the radiosonde receivers or navaid tracker systems. There are usually no moving parts in the navaid ground system and mechanical maintenance is negligible, though antenna systems, cables and connectors should be regularly inspected for corrosion and other weathering effects. Provided that sufficient spare modules are purchased with the system, maintenance costs can be minimal.

13.7 CORRECTIONS

When radiowind observations are produced by a radar system, the radar tracking information is used to compute the height assigned to the wind measurements. These radar heights need to be corrected for the curvature of the Earth using the following:

$$\Delta z_{\text{curvature}} = 0.5 (r_s \times \cos\theta)^2 / (R_c + r_s \sin\theta) \quad (13.3)$$

where r_s is the slant range to the target; θ is the elevation angle to the target; and R_c is the radius of the Earth curvature at the ground station.

In addition, the direction of propagation of the radar beam changes since the refractive index of air decreases on average with height, as temperature and water vapour also decrease with height. The changes in refractive index cause the radar wave to curve back towards the Earth. Thus, atmospheric refraction usually causes the elevation angle observed at the radar to be larger than the true geometric elevation of the target.

Typical magnitudes of refraction corrections, $\Delta z_{\text{refraction}}$, are shown in Table 13.6. These were computed by Hooper (1986). With recent increases in available processing power for ground system computers, algorithms for computing refractive index corrections are more readily available for applications with high-

Table 13.6. Examples of corrections for Earth curvature and refraction to observed radar height

Plan range (km)	Altitude (km)	$\Delta z_{\text{curvature}}$	$\Delta z_{\text{refraction}}$		
			$60^\circ\text{N } 01^\circ\text{W}$	$36^\circ\text{N } 14^\circ\text{E}$	$1^\circ\text{S } 73^\circ\text{E}$
25	10	49	-9	-10	-12
50	15	196	-31	-34	-39
100	20	783	-106	-117	-133
150	25	1760	-211	-231	-262
200	30	3126	-334	-363	-427

precision tracking radars. The corrections in Table 13.6 were computed from five-year climatological averages of temperature and water vapour for a variety of locations. On days when

refraction errors are largest, the correction required could be larger than the climatological averages in Table 13.6 by up to 30 per cent at some locations.

REFERENCES AND FURTHER READING

- Acheson, D.T., 1970: *Loran-C Windfinding Capabilities: Wallops Island Experiments*. United States Department of Commerce, Weather Bureau, ESSA Technical Memorandum WBTM EDL 11.
- de Boor, C., 1978: *A Practical Guide to Splines*. Springer Verlag, New York.
- Edge, P., M. Kitchen, J. Harding and J. Stancombe, 1986: *The Reproducibility of RS3 Radiosonde and Cossor WF Mk IV Radar Measurements*. Meteorological Office, Bracknell, OSM 35.
- Elms, J.B. and J. Nash, 1996: Personal communication of results from a comparison of pre-production GPS radiosonde wind measurements with Loran-C and radar winds. Camborne, United Kingdom, 15–19 January 1996.
- Hooper, A.H., 1986: *The Calculation of Radio-wave Refraction, with Special Reference to Data from Height-finding Radars*. Meteorological Office, Bracknell, OSM 17.
- Kaisti, K., 1995: New low-cost GPS solution for upper-air windfinding. *Proceedings of the Ninth Symposium on Meteorological Observations and Instrumentation*, Charlotte, North Carolina (27–31 March 1995), American Meteorological Society, pp. 16–20.
- Karhunen, P., 1983: Automated windfinding developments. Preprints of the Fifth AMS Symposium on Meteorological Observations and Instrumentation, (Toronto, 11–15 April 1983), pp. 110–115.
- Lange, A.A., 1988: *A high-pass filter for optimum calibration of observing systems with applications*. In: *Simulation and Optimization of Large Systems* (A.J. Osiadacz, ed.). Clarendon Press, Oxford, pp. 311–327.
- Nash, J., 1994: Upper wind observing systems used for meteorological operations. *Annales Geophysicae*, Volume 12, pp. 691–710.
- Nash, J. and T. J. Oakley, 1992: Experience in the use of Loran-C windfinding in the United Kingdom. *Proceedings of the Twenty-first Annual Technical Symposium*, Wild Goose Association, Birmingham, England, pp. 81–88.
- Passi, R.M., 1978: Overdetermined windfinding systems. *Atmospheric Technology*, Number 10, Winter 1978–1979, pp. 65–75.
- Passi, R.M. and C. Morel, 1987: Wind errors using the worldwide Loran network. *Journal of Atmospheric and Oceanic Technology*, Volume 4, pp. 690–700.
- Schaefer, J.T. and C.A. Doswell, 1978: The inherent position errors in double-theodolite pibal measurements. *Journal of Applied Meteorology*, Volume 17, pp. 911–915.
- Stickland, J.J., 1996: Personal communication of results of trials of GPS radiosondes. Bureau of Meteorology, Australia.
- World Meteorological Organization, 1975: *Upper-air Sounding Studies*. Volume II: *Manual Computation of Radiowinds* (R.E. Vockeroth). Technical Note No. 140, WMO-No. 394, Geneva.
- World Meteorological Organization, 1985: *Meteorological Observations Using Navaid Methods* (A.A. Lange). Technical Note No. 185, WMO-No. 641, Geneva.
- World Meteorological Organization, 1986: *Algorithms for Automatic Aerological Soundings* (A.H. Hooper). Instruments and Observing Methods Report No. 21, WMO/TD-No. 175, Geneva.
- World Meteorological Organization, 1987: *WMO International Radiosonde Comparison (U.K. 1984, U.S.A. 1985): Final Report* (J. Nash and F.J. Schmidlin). Instruments and Observing Methods Report No. 30, WMO/TD-No. 195, Geneva.
- World Meteorological Organization, 1989: An algorithmic approach for improving and controlling the quality of upper-air data (A.A. Lange). *Papers Presented at the Fourth WMO Technical Conference on Instruments and Methods of Observation (TECIMO-IV)* (Brussels, 4–8 September 1989). Instruments and Observing Methods Report No. 35, WMO/TD-No. 303, Geneva, pp. 87–92.
- World Meteorological Organization, 1991: *WMO International Radiosonde Comparison – Phase III – Dzhambul, USSR, 1989: Final Report* (A. Ivanov, A. Kats, S. Kurnosenko, J. Nash and N. Zaitseva). Instruments and Observing Methods Report No. 40, WMO/TD-No. 451, Geneva.
- World Meteorological Organization, 1994: A new GPS rawinsonde system (D.B. Call). *Papers Presented at the WMO Technical Conference on Instruments and Methods of Observation (TECO-94)* (Geneva, 28 February–2 March 1994), Instruments and Observing Methods Report No. 57, WMO/TD-No. 588, Geneva, pp. 159–163.
- World Meteorological Organization, 1995: *Manual on Codes*. WMO-No. 306, Geneva.
- World Meteorological Organization, 1996: *WMO International Radiosonde Comparison – Phase IV –*

Tsukuba, Japan, 1993: Final Report (S. Yagi, A. Mita and N. Inoue). Instruments and Observing Methods Report No. 59, WMO/TD-No. 742, Geneva.

World Meteorological Organization, 2003a: *Manual on the Global Observing System*. Volume I, WMO-No. 544, Geneva.

World Meteorological Organization, 2003b: *Executive Summary of the WMO Intercomparison of GPS Radiosondes* (Alcantara, Maranhão, Brazil, 20 May–10 June 2001). Instruments and Observing Methods Report No. 76, WMO/TD-No. 1153, Geneva.

CHAPTER 14

PRESENT AND PAST WEATHER; STATE OF THE GROUND

14.1 GENERAL

14.1.1 Definitions

In observational practice the term *weather* is regarded as covering those observations of the state of the atmosphere, and of phenomena associated with it, which were initially not intended to be measured quantitatively. These observations are qualitative descriptions of phenomena observed in the atmosphere or on the Earth's surface, such as precipitation (hydrometeor falling through the atmosphere), suspended or blowing particles (hydrometeors and lithometeors), or other specially designated optical phenomena (photometeor) or electrical manifestations (electrometeor). Detailed descriptions can be found in WMO (1975).

A *hydrometeor* is an ensemble of liquid or solid water particles suspended in, or falling through, the atmosphere, blown by the wind from the Earth's surface, or deposited on objects on the ground or in free air.

A *lithometeor* is an ensemble of particles most of which are solid and non-aqueous. The particles are more or less suspended in the air, or lifted by the wind from the ground.

A *photometeor* is a luminous phenomenon produced by the reflection, refraction, diffraction or interference of light from the sun or the moon.

An *electrometeor* is a visible or audible manifestation of atmospheric electricity.

A special class of weather phenomena are localized weather events. Definitions of such events can be found in WMO (1992). Specific events such as dust whirls and funnel clouds are defined and described in section 14.2.3.

In meteorological observations, weather is reported in two forms. *Present weather* is a description of the weather phenomena present at the time of observation. *Past weather* is used to describe significant weather events occurring during the previous hour, but not occurring at the time of observation.

This chapter also describes the methods of observing a related item, namely the state of the ground. *State of the ground* refers to the condition of the Earth's surface resulting from the recent climate and weather events, in terms of the amount of moisture or description of any layers of solid, or aqueous or non-aqueous particles covering the normal surface.

14.1.2 Units and scales

At manned stations, the observations identified as present weather, past weather and state of ground are reported together with quantitative data. Such observations have been standardized on scales that enable the observer to select an appropriate term from a large number of descriptions derived from the perceptions of human observers and laid down in WMO (1995).

Since 1990, the introduction of automated weather stations has created the need to quantify the functions previously performed by observers. In order to accommodate the varying levels of sophistication and effectiveness of automated meteorological stations in observing present and past weather, specific coding directives have been included in WMO (1995). Because of the complexity of reporting data on present and past weather determined by sophisticated present weather systems, such data should be reported as quantities in binary code format given that the alphanumeric code format suffers from many restrictions in comprehensive reporting.¹

14.1.3 Meteorological requirements

Present and past weather, as well as the state of the ground, are primarily meant to serve as a qualitative description of weather events. They are required basically because of their impact on human activities and transport safety, as well as for their significance for understanding and forecasting synoptic weather systems. Several other chapters in this Guide deal with related topics. The quantitative measurement of precipitation amounts is

¹ Recommendation 3 (CBS-XII) refers to the requirement "to report observed quantities rather than qualitative parameters for present weather in observation from automatic stations in FM 94 BUFR and FM 95 CREX".

described in Part I, Chapter 6, and cloud observations are described in Part I, Chapter 15. Part II addresses topics that are specific to aeronautical and marine observations, automated systems, radar and atmospheric.

In this chapter, weather observations of interest in the determination of present and past weather are categorized into three types, namely precipitation (falling hydrometeors), atmospheric obscurity and suspensoids (lithometeors and suspended or blowing hydrometeors), and other weather events (such as funnel clouds, squalls and lightning). Liquid precipitation or fog which leave frozen deposits on surfaces are included in the appropriate precipitation and suspended hydrometeor category.

Other phenomena, such as those of an optical nature (photometeors) or electrometeors other than lightning, are indicators of particular atmospheric conditions and may be included in the running record maintained at each station of the weather sequence experienced. However, they are of no significance in the determination of present and past weather when coding standard meteorological observations, and are included here only for completeness.

14.1.4 **Observation methods**

The only current capability for observing all of the different forms of weather are the visual and auditory observations of a trained human observer. However, given the high cost of maintaining a significant staff of trained observers, a number of Services are increasing their use of automated observing systems in primary observing networks, as well as continuing their use for supplementing manned networks with observations from remote areas.

Basic research (Bespalov, and others, 1983) has confirmed the possibility that weather phenomena may be determined by the logical analysis of a group of data variables. No single sensor is currently available which classifies present weather; rather, data from a variety of sensors are used (such as visibility, temperature, dew point, wind speed and the differentiation of rain versus snow) to make such determinations. Computerized automated observing systems have the capability to perform this logical analysis, but they vary in their ability to observe the required weather phenomenon, based on the instrumentation included in the system and the sophistication of the algorithms. While automated systems cannot observe all types of weather event, those of significance can be observed, making such systems

cost-effective alternatives to the fully trained human observer.

14.2 **OBSERVATION OF PRESENT AND PAST WEATHER**

The observations to be recorded under the present weather and past weather headings include the phenomena of precipitation (rain, drizzle, snow, ice pellets, snow grains, diamond dust and hail), atmospheric obscurity and suspensoids (haze, dust, smoke, mist, fog, drifting and blowing snow, dust or sandstorms, dust devils), funnel clouds, squalls and lightning.

When observing present weather, it is necessary to note the various phenomena occurring at the station or in sight of the station at the time of observation. In synoptic reports, if there is no precipitation at the time of observation, account is taken of the conditions during the last hour in selecting the code figure.

14.2.1 **Precipitation**

14.2.1.1 **Objects of observation**

The character of precipitation can be defined as being one of three forms, namely showers, intermittent precipitation and continuous precipitation. Showers are the precipitation events associated with physically separated convective clouds. Observers (or instruments replacing humans) also have to classify precipitation into the three intensity categories, namely light, moderate and heavy, according to the rates of precipitation fall or other related factors (such as visibility).

The precipitation character (intermittent, continuous, showery) and type (rain, drizzle, snow, hail) affect the definition of scales of precipitation intensity. Several combined Commission for Instruments and Methods of Observation/ Commission for Basic Systems expert team meetings have developed tables to obtain a more universal relation between the qualitative and subjective interpretation by an observer and the measured quantities obtained by a present-weather system. For an example of these tables and other relations, see the annex.

Observations of rain or drizzle at low temperatures should distinguish whether or not the precipitation is freezing. By definition, frozen rain or drizzle

causes glazed frost by freezing on coming into contact with solid objects.

Solid precipitation can occur in the form of diamond dust, snow grains, isolated star-like snow crystals, ice pellets and hail, full descriptions of which are given in WMO (1975).

14.2.1.2 Instruments and measuring devices

One major area of instrumentation involves the identification of the type of precipitation. Systems which are currently under evaluation, or in operational use, involve either optical methods or radar (Van der Meulen, 2003). Recent field tests (WMO, 1998) have shown that all of these systems are capable of detecting most precipitation – except for the very lightest snow or drizzle – in over 90 per cent of occurrences. The percentage of detection of very light precipitation is usually much lower.² Sophisticated algorithms are required to differentiate between several of the precipitation types. For example, wet or melting snow is difficult to distinguish from rain.

A precipitation occurrence sensor system (Wiggins and Sheppard, 1991; WMO, 1985a) using Doppler radar has been found to distinguish snow from rain or from hail by measuring the falling speed. The amount is estimated from the total backscattered power. The precipitation-occurrence sensor system detects the start of most precipitation – except for the very lightest snow or drizzle – and can recognize the end of precipitation.

Optical present weather sensors detect precipitation occurrence, the type of precipitation and, in some cases, amount. These instruments are based on a variety of techniques which measure the effects of precipitation particles on light emitted from a transmitter. One such instrument analyses the fluctuation of an infrared light beam while precipitation is falling (WMO, 1989). Others use either forward-scattering or backscattering of light (Gaumet, Salomon and Paillisse, 1991a), similar to methods used for measuring visibility. In all of the optical devices, the size, shape, fall-speed and concentration of precipitation particles result in different characteristics. These characteristics are usually related to signal strength and signal variability or frequency. The precipitation type determined by these instruments is often compared with the measurements from other sensors, such as of temperature and dew point, to determine the precipitation type

when the instrument output is indeterminate, and as a form of quality control. The instruments require periodic calibration and/or alignment, as well as more frequent lens cleaning.

Optical devices using laser technology have proved to be more expensive to install and difficult to maintain. Alignment drift problems are characteristic of these instruments, which have longer baselines between the transmitting and receiving apparatus.

A sensor specifically designed to detect freezing rain or glaze is in operational use (Starr and Cauwenberghe, 1991). It senses the amount of ice accumulation on a probe. The probe vibrates at a frequency that is proportional to the mass of the probe. When ice freezes on the probe, its mass changes and the vibration frequency decreases. A heater is built into the sensor to de-ice the probe when required. The sensor has also been found effective for identifying wet snow.

See Van der Meulen (2003) for an overview of the current technologies to measure or determine present weather.

To determine present weather characteristics and quantities, observing systems use a variety of sensors in combination with algorithms. This multi-sensor approach creates a constraint on the techniques involved. Typical observations also involved are the measurement of precipitation, visibility, air temperature, dew point and cloud base. The algorithms are characterized by filtering (for example, liquid precipitation only if the air temperature is above 6°C). For more details, refer to Part I, Chapter 1.

14.2.2 Atmospheric obscurity and suspensoids

14.2.2.1 Objects of observation

In reports that take into account the atmospheric conditions during the last hour, haze should be distinguished from mist or water fog. With haze, the air is relatively dry, whereas with mist or water fog, there is usually evidence of high humidity in the form of water droplets or rime on grass, leaves, etc. If the station is equipped with measuring instruments, it is fairly safe to assume that the obscurity is haze if the relative humidity is less than a certain percentage, for example, 80 per cent, and if the visibility is within certain limit values, for example, greater than 1 km in the horizontal, and greater than 2 km in the vertical. Mist is to be reported at high humidity values and at a visibility of 1 km or

² The threshold for the detection of rain is 0.02 mm h⁻¹ (see Part I, Chapter 6, Annex 1.B).

more. In synoptic reporting, fog is regarded as applying to water or ice fogs, generally reducing the horizontal visibility at the Earth's surface to less than 1 km.

Rime deposit is caused by the solidification into ice of water droplets in fog on coming into contact with solid objects at a temperature below freezing point. The present and past weather codes do not distinguish between different types of rime. Wherever the term "fog" occurs in present weather and past weather codes it should be read in this sense. In climatological summaries, however, all occasions of visibility of less than 1 km are regarded as fog.

Drifting or blowing snow is snow blown off the ground into the air after it has already fallen. In the present weather code, drifting and blowing snow are distinguished separately, the former referring to snow not raised above the observer's eye level.

Other meteorological phenomena to be identified include widespread dust in suspension in the air, dust or sand raised by wind, a duststorm and sandstorm caused by turbulent winds raising large quantities of dust or sand into the air and reducing visibility severely, dust whirls or sand whirls and, occasionally, funnel clouds.

WMO (1975) should be at the observer's disposal as an auxiliary means.

14.2.2.2 Instruments and measuring devices for obscurity and suspensoid characteristics

A possible approach for the identification of obscurity and suspensoid characteristics is the complex processing of measured values which can act as predictors. This approach requires researching the meteorological quantities that accompany the formation, intensification and disappearance of the phenomenon, as well as determining the limiting conditions. The problem of identifying fog, mist, haze, snowstorms and duststorms is reported in Goskomgidromet (1984) and WMO (1985*b*). The meteorological visual range serves as the most important indicating element. Of the remaining variables, wind velocity, humidity, temperature and dew point have proved to be important identifying criteria.

Optical devices measuring the backscattering of light, similar to those which measure visibility, have also been shown to be effective in identifying fog (Gaumet, Salomon and Paillisse, 1991*a*). The

light scattering by fog droplets produces a signal of high-intensity and low-intensity variance.

14.2.3 Other weather events

14.2.3.1 Objects of observation

One event of critical importance in the protection of life and property is the recognition and observation of funnel clouds.

Funnel cloud (tornado or waterspout): A phenomenon consisting of an often violent whirlwind, revealed by the presence of a cloud column or inverted cloud cone (funnel cloud), protruding from the base of a cumulonimbus. The cloud may extend all the way down to the Earth's surface, but not necessarily reaching the ground, in which case water, dust, sand or litter may be raised, producing a "bush" around the tip of the funnel. The diameter can vary from a few metres to some hundreds of metres. A funnel cloud is considered well developed if the violent rotating column of air touches the ground or water surface. A well-developed funnel cloud is considered a tornado when over ground, and a waterspout when over water. The most violent tornadoes can have associated wind speeds of up to 150 m s⁻¹.

Dust/sand whirls (dust devils): A rapidly rotating column of air usually over dry and dusty or sandy ground which carries dust and other light material picked up from the ground. Dust or sand whirls are a few metres in diameter. Normally, in the vertical they extend no higher than 60 to 90 m (dust devils). Well-developed dust/sand whirls in very hot desert regions may reach 600 m.

Squall: A strong wind that rises suddenly, lasts for a few minutes, then passes away. Squalls are frequently associated with the passage of cold fronts. In such circumstances, they occur in a line and are typically accompanied by a sharp fall in temperature, veering wind, a rise in relative humidity, and a roll-shaped cloud with a horizontal axis (line squall).

The definition of a thunderstorm (see WMO, 1992) is an example of deriving the description exclusively from the perception of human observers. The event should be considered as a thunderstorm when thunder is heard (even if lightning is not observed).

14.2.3.2 Instruments and measuring devices

The presence of funnel clouds, or tornadoes, can often be determined with the use of weather radar (see Part II, Chapter 9). Modern Doppler weather

radars have become quite effective in the recognition of mesocyclones, thus providing more detailed and advanced information about this severe weather phenomenon than visual observation alone.

Squalls can be determined from the discrete succession of measured values of wind velocity. If the output of a wind velocity measuring device is combined with that of a wind direction sensor, a thermometer or a humidity sensor, the identification of a line squall seems to be possible.

Thunderstorms are mainly detected through the use of lightning counters. On the basis of the instructions provided to observers and issued by different Services, a certain number of lightning strokes per interval of time must be selected which can be used in combination with precipitation rates or wind speeds to define slight, moderate and heavy thunderstorms (see Part II, Chapter 7).

14.2.4 State of the sky

14.2.4.1 Objects of observation

The specifications of the state of the sky are used to describe the progressive changes that have occurred in the sky during a given time. Changes in the total amount of clouds, in the height of the cloud base and in the type of cloud are to be considered likewise.

14.2.4.2 Instruments and measuring devices

Cloud amount characteristics (total cloud cover in oktas, height of cloud base, and total cloud cover in various cloud layers) can be approximated from the variation of cloud-base height measured by a cloud-base optical measuring system by the application of statistical methods. Obviously, this is limited to cloud layers within the vertical range of the cloud-base measuring system (Persin, 1987; US NOAA, 1988; ICEAWS, 1999).

14.3 STATE OF THE GROUND

14.3.1 Objects of observation

Observations of the state of the ground (symbolic letters E and E') should be made in accordance with the specifications given in Code tables 0901 and 0975 in WMO (1995), which are self-explanatory.

14.3.2 Instruments and measuring devices

Research has shown that it is possible to discriminate main states of soil by means of reflecting and scattering phenomena (dry, humid, wet, snow-covered, rimed or iced) (Gaumet, Salomon and Paillisse, 1991*b*).

14.4 SPECIAL PHENOMENA

14.4.1 Electrical phenomena (electrometeors)

Electrometeors either correspond to discontinuous electrical discharges (lightning, thunder) or occur as more or less continuous phenomena (Saint Elmo's fire, polar aurora). Full descriptions of electrometeors are given in WMO (1975).

Special records of lightning should include information regarding its type and intensity, the frequency of flashes and the range of azimuth over which discharges are observed; the lapse of time between lightning and the corresponding thunder should be noted. Care should be taken to distinguish between the actual lightning flash and its possible reflection on clouds or haze. Automatic detection systems for lightning location are in operational use in many countries. Part II, Chapter 7 contains more information on this topic.

Exceptional polar aurora should be described in detail. Light filters, where available, may be used as a means of increasing the sensitivity of the observations, and theodolites or clinometers (alidades) may be used to increase the accuracy of the angular measurements.

14.4.2 Optical phenomena (photometeors)

A photometeor is a luminous phenomenon produced by the reflection, refraction, diffraction or interference of light from the sun or moon. Photometeors may be observed in more or less clear air (mirage, shimmer, scintillation, green flash, twilight colours), on or inside clouds (halo phenomena, corona, irisation, glory) and on or inside certain hydrometeors or lithometeors (glory, rainbow, fog bow, Bishop's ring, crepuscular rays).

Observers should take careful note of any optical phenomena that occur. A written description should be accompanied by drawings and photographs, if possible. Full descriptions of these phenomena are

given in WMO (1975). Concise instructions for observing the more common phenomena are given in some observers' handbooks, for example, the United Kingdom Meteorological Office (1982).

A theodolite is a very suitable instrument for precise measurements. However, when one is not

available, a graduated stick held at arm's length is useful; with the occurrence of a mock sun, the position may be determined by noting its relation to fixed landmarks. The diameter of a corona may be estimated by taking the angular diameter of the sun or moon as approximately half a degree.

ANNEX

CRITERIA FOR LIGHT, MODERATE AND HEAVY PRECIPITATION INTENSITY¹

(Light, moderate and heavy precipitation defined with respect to the type of precipitation and to intensity, i)²

Variable	Range	Intensity
Drizzle	$i < 0.1 \text{ mm h}^{-1}$	Light
	$0.1 \leq i < 0.5 \text{ mm h}^{-1}$	Moderate
	$i \geq 0.5 \text{ mm h}^{-1}$	Heavy
Rain (also showers)	$i < 2.5 \text{ mm h}^{-1}$	Light
	$2.5 \leq i < 10.0 \text{ mm h}^{-1}$	Moderate
	$10.0 \leq i < 50.0 \text{ mm h}^{-1}$	Heavy
	$\geq 50.0 \text{ mm h}^{-1}$	Violent ³
Snow	$i < 1.0 \text{ mm h}^{-1}$ (water equivalent)	Light

Mixed precipitation of rain and snow

The same as for snow (since the rain/snow ratio is not subject to any measurement, a simple choice should be made).

Hail: The same as for rain.

Ice pellets: The same as for snow.

Freezing phenomena: The same as for the non-freezing phenomena.

Guide for approximating the intensity of snow

Light: Snowflakes small and sparse; in the absence of other obscuring phenomena, snow at this intensity generally reduces visibility, but to no less than 1 000 m.

Moderate: Larger, more numerous flakes generally reducing visibility to between 400 and 1 000 m.

Heavy: Numerous flakes of all sizes generally reducing visibility to below 400 m.

Showers or intermittent precipitation

Automated systems should report showers or intermittent precipitation. Intermittent can be defined as no precipitation within 10 min of two consecutive precipitation events, i.e. if there is period of 10 min of no precipitation in a running 10 min average of precipitation within the last hour, it should be reported as intermittent.

Representativeness of present weather events

A present weather event may be well defined by a 3 min observing period. The highest running 3 min average in the 10 min period should be reported for present weather.

1 Recommended by the WMO Expert Meeting on Automation of Visual and Subjective Observations (Trappes/Paris, France, 14-16 May 1997) and the Working Group on Surface Measurements (Geneva, Switzerland, 27-31 August 2001).

2 Intensity values based on a 3 min measurement period.

3 The term "violent", as it pertains to precipitation rate, is inconsistent with the other categories and confusing. A term such as "intense" or "extreme" may be more appropriate.

REFERENCES AND FURTHER READING

- Bespalov, S.M. and others, 1983: *Osnovnyje voprosy razrabotki setevoj avtomaticheskij gidrometeorologicheskij stancii* (Main aspects of designing a network of automatic hydrometeorological stations). *Trudy GGO*, 473, pp. 3–12, Gidrometeoizdat, Leningrad.
- Gaumet, J.L., P. Salomon and R. Paillisse, 1991a: Present weather determination by an optical method. *Preprints of the Seventh Symposium on Meteorological Observations and Instrumentation: Special Session on Laser Atmospheric Studies*, American Meteorological Society (New Orleans, 14–18 January 1991), pp. 327–331.
- Gaumet, J.L., P. Salomon and R. Paillisse, 1991b: Automatic observations of the state of the soil for meteorological applications. *Preprints of the Seventh Symposium on Meteorological Observations and Instrumentation: Special Sessions on Laser Atmospheric Studies*, American Meteorological Society (New Orleans, 14–18 January 1991), pp. J191–J193.
- Goskomgidromet, 1984: *Opredelenije atmosferynych javlenij po dannym avtomaticheskich stancij, soveqanije gruppy ekspertov GMS/MS socialisticheskich stran po teme 9.1. KR GMS/MS* (Identification of atmospheric phenomena from the data from automatic weather stations: Meeting of the panel of socialist countries HMS/MS on theme 9.1.), Obninsk 24–28 August 1984, Moscow.
- ICEAWS, 1999: *Second International Conference on Experiences with Automatic Weather Stations* (Vienna, 27–29 September). *Österreichische Beiträge zu Meteorologie und Geophysik*, No. 20 (available on CD-ROM only), ZAMG, Vienna, Austria.
- Persin, S.M., 1987: *Izmerenije vysoty niznej granicy oblakov i charakteristika oblacnosti kak zadaca paspoznavanija obrazov* (Measuring cloud ceiling and characterizing cloudiness as a task of image identification). *Trudy GGO*, 512, pp. 49–91, Gidrometeoizdat, Leningrad.
- Starr, K.M. and R. van Cauwenberghe, 1991: The development of a freezing rain sensor for automated surface observing systems. *Preprints of the Seventh Symposium on Meteorological Observations and Instrumentation: Special Sessions on Laser Atmospheric Studies*, American Meteorological Society (New Orleans, 13–18 January 1991), pp. 338–343.
- United Kingdom Meteorological Office, 1982: *Observer's Handbook*. Fourth edition, Her Majesty's Stationery Office, London.
- United States National Oceanic and Atmospheric Administration, 1988: *Federal Standard Algorithms for Automated Weather Observing Systems Used for Aviation Purposes*. Office of the Federal Coordinator for Meteorological Services and Supporting Research, United States Department of Commerce, FCM-S5-1988, Washington, D.C.
- Van der Meulen, J.P., 2003: *Present Weather – Science: Exploratory Actions on Automatic Present Weather Observations*. Final Report, E-PWS-SCI, KNMI, de Bilt, Netherlands, EUMETNET (available at: http://www.knmi.nl/~samenw/geoss/eumetnet/E-PWS-Sci/report/PWS-Sci_final_report.pdf).
- Wiggins, W.L. and B.E. Sheppard, 1991: Field test results on a precipitation occurrence and identification sensor. *Preprints of the Seventh Symposium on Meteorological Observations and Instrumentation: Special Sessions on Laser Atmospheric Studies*, American Meteorological Society (New Orleans, 13–18 January 1991), pp. 348–351.
- World Meteorological Organization, 1975: *International Cloud Atlas: Manual on the Observation of Clouds and Other Meteors*. Volume I, WMO-No. 407, Geneva.
- World Meteorological Organization, 1985a: An improved AES precipitation occurrence sensor system (B.E. Sheppard and K.K. Wu). *Papers Presented at the Third WMO Technical Conference on Instruments and Methods of Observation (TECIMO-III)* (Ottawa, 8–12 July 1985), Instruments and Observing Methods Report No. 22, WMO/TD-No. 50, Geneva, pp. 103–108.
- World Meteorological Organization, 1985b: Algorithms for automatic coding of the present and past weather by unmanned meteorological stations (M. Mezösi, A. Simon, P. Hanák and O. Szenn.). *Papers Presented at the Third WMO Technical Conference on Instruments and Methods of Observation (TECIMO-III)* (Ottawa, 8–12 July 1985), Instruments and Observing Methods Report No. 22, WMO/TD-No. 50, Geneva, pp. 255–259.
- World Meteorological Organization, 1987: *International Cloud Atlas*, Volume II, WMO-No. 407, Geneva.
- World Meteorological Organization, 1989: The next generation of sensors of ASOS (F.W. Gallagher). *Papers Presented at the Fourth WMO Technical Conference on Instruments and Methods of Observation (TECIMO-IV)* (Brussels, 4–8 September 1989), Instruments and Observing Methods Report No. 35, WMO/TD-No. 303, Geneva, pp. 105–109.

- World Meteorological Organization, 1992: *International Meteorological Vocabulary*, WMO-No. 182 Geneva.
- World Meteorological Organization, 1995: *Manual on Codes*. Volumes I.1 and I.2, WMO-No. 306, Geneva.
- World Meteorological Organization, 1998: *WMO Intercomparison of Present Weather Sensors/Systems: Final Report* (Canada and France, 1993-1995) (M. Leroy, C. Bellevaux and J.P. Jacob). Instruments and Observing Methods Report No. 73, WMO/TD-No. 887, Geneva.
-

OBSERVATION OF CLOUDS

15.1 GENERAL

The observation of clouds and the estimation or measurement of the height of their bases above the Earth's surface are important for many purposes, especially for aviation and other operational applications of meteorology. This chapter describes the methods in widespread use. Important further information is to be found in WMO (1975; 1987), which contain scientific descriptions of clouds and illustrations to aid in the identification of cloud types. Information on the practices specific to aeronautical meteorology is given in WMO (1990).

15.1.1 Definitions

Cloud: An aggregate of very small water droplets, ice crystals, or a mixture of both, with its base above the Earth's surface, which is perceivable from the observation location. The limiting liquid particle diameter is of the order of 200 μm ; drops larger than this comprise drizzle or rain.

With the exception of certain rare types (for example, nacreous and noctilucent) and the occasional occurrence of cirrus in the lower stratosphere, clouds are confined to the troposphere. They are formed mainly as the result of the vertical motion of air, in convection, in forced ascent over high ground, or in the large-scale vertical motion associated with depressions and fronts. Clouds may result, in suitable lapse-rate and moisture conditions, from low-level turbulence and from other minor causes.

At temperatures below 0°C, cloud particles frequently consist entirely of water droplets supercooled down to about -10°C in the case of layer clouds and to about -25°C in the case of convective clouds. At temperatures below these very approximate limits and above about -40°C, many clouds are "mixed", with ice crystals predominating in the lower part of the temperature range.

Cloud amount: The amount of sky estimated to be covered by a specified cloud type (partial cloud amount), or by all cloud types (total cloud amount). In either case, the estimate is made to the nearest okta (eighth) and is reported on a scale which is essentially one of the nearest eighth, except that figures 0 and 8 on the scale signify a completely clear

and cloudy sky, respectively, with consequent adjustment to other figures near either end of the scale.

Cloud base: The lowest zone in which the obscuration corresponding to a change from clear air or haze to water droplets or ice crystals causes a significant change in the profile of the backscatter extinction coefficient. In the air below the cloud, the particles causing obscuration show some spectral selectivity, while in the cloud itself, there is virtually no selectivity; the difference is due to the different droplet sizes involved. The height of the cloud base is defined as the height above ground level. For an aviation station, the ground (surface) level is defined as the official aerodrome elevation.

Cloud type (classification): Various methods of cloud classification are used, as follows:

- (a) In WMO (1975), division is made into cloud genera with 10 basic characteristic forms, with further subdivision, as required, into:
 - (i) Cloud species (cloud shape and structure);
 - (ii) Cloud varieties (cloud arrangement and transparency);
 - (iii) Supplementary features and accessory clouds (for example, incus, mamma, virga, praecipitatio, arcus, tuba, pileus, velum and pannus);
 - (iv) Growth of a new cloud genus from a mother-cloud, indicated by the addition of "genitus" to the new cloud and mother-cloud genera – in that order, if a minor part of the mother-cloud is affected – and of "mutatus" if much or all of the mother-cloud is affected, for example, stratocumulus cumulogenitus, or stratus stratocumulomutatus;
- (b) A classification is made in terms of the level – high, middle or low – at which the various cloud genera are usually encountered. In temperate regions, the approximate limits are: high, 6–12 km (20 000–40 000 ft); middle, surface–6 km (0–20 000 ft); and low, surface–1.5 km (0–5 000 ft). The high clouds are cirrus, cirrocumulus and cirrostratus; the middle clouds are altocumulus and altostratus (the latter often extending higher) and nimbostratus (usually extending both higher and lower); and the low clouds are stratocumulus, stratus, cumulus and cumulonimbus

(the last two often also reaching middle and high levels).

For synoptic purposes, a nine-fold cloud classification is made in each of these three latter divisions of cloud genera, the corresponding codes being designated C_H , C_M and C_L , respectively. The purpose is to report characteristic states of the sky rather than individual cloud types;

- (c) Less formal classifications are made as follows:
- (i) In terms of the physical processes of cloud formation, notably into heap clouds and layer clouds (or "sheet clouds");
 - (ii) In terms of cloud composition, namely ice-crystal clouds, water-droplet clouds and mixed clouds.

Most of these forms of cloud are illustrated with photographs in WMO (1987).

Vertical visibility: The maximum distance at which an observer can see and identify an object on the same vertical as him/herself, above or below. Vertical visibility can be calculated from the measured extinction profile, $\sigma(h)$, as stated by WMO (2003). The relationship, however, is less simple than for horizontal visibility, because σ may not be regarded as a constant value. Nevertheless, the $I(h=VV)/I_{10}=5$ per cent rule can be applied. Taking into account this assumption, the vertical visibility can be expressed in a relation with $\sigma(h)$, in which VV is represented intrinsically, i.e.

$$\int_{h=0}^{h=VV} \sigma(h) dh = -\ln(5\%) \oplus 3 \quad (15.1)$$

15.1.2 Units and scales

The unit of measurement of cloud height is the metre or, for some aeronautical applications, the foot. The unit of cloud amount is the okta, which is an eighth of the sky dome covered by cloud, as seen by the observer.

15.1.3 Meteorological requirements

For meteorological purposes, observations are required for cloud amount, cloud type and height of cloud base. For synoptic observations, specific coding requirements are stated in WMO (1995), which is designed to give an optimum description of the cloud conditions from the surface to high levels. From space, observations are made of cloud amount and temperature (from which the height of

the cloud top is inferred). Measurements from space can also be used to follow cloud and weather development.

Accuracy requirements have been stated for synoptic, climatological and aeronautical purposes. These requirements are summarized in Part I, Chapter 1, Annex 1.B and with respect to cloud height, are most stringent for aeronautical purposes.

15.1.4 Observation and measurement methods

15.1.4.1 Cloud amount

Most measurements of cloud amount are made by visual observation. Instrumental methods are under development and are used operationally in some applications for estimation of low cloud amount. Estimates of cloud amount in each identified layer and total cloud amount in view of the observation point are made.

The total cloud amount, or total cloud cover, is the fraction of the celestial dome covered by all clouds visible. The assessment of the total amount of cloud, therefore, consists in estimating how much of the total apparent area of the sky is covered with clouds.

The partial cloud amount is the amount of sky covered by each type or layer of clouds as if it were the only cloud type in the sky. The sum of the partial cloud amounts may exceed both the total cloud amount and eight oktas.

The scale for recording the amount of cloud is that given in Code table 2700 in WMO (1995), which is reproduced below:

Code figure		
0	0	0
1	1 okta or less, but not zero	1/10 or less, but not zero
2	2 oktas	2/10-3/10
3	3 oktas	4/10
4	4 oktas	5/10
5	5 oktas	6/10
6	6 oktas	7/10-8/10
7	7 oktas or more, but not 8 oktas	9/10 or more, but not 10/10
8	8 oktas	10/10
9	Sky obscured by fog and/or other meteorological phenomena	
/	Cloud cover is indiscernible for reasons other than fog or other meteorological phenomena, or observation is not made.	

15.1.4.2 Cloud base (height)

The height of the cloud base lends itself to instrumental measurement, which is now widely used at places where cloud height is operationally important. However, the estimation of cloud height by observer is still widespread.

Several types of instruments are in routine operational use, as described in this chapter. An international comparison of several types of instruments was conducted by WMO in 1986, and is reported in WMO (1988). The report contains a useful account of the accuracy of the measurements and the performance of the instruments.

Instrumental measurement of cloud height is widespread and important for aeronautical meteorological services. This is discussed further in Part II, Chapter 2.

15.1.4.3 Cloud type

At present, the only method for observing cloud type is visual. Pictorial guides and coding information are available from many sources, such as WMO (1975; 1987), as well as from publications of National Meteorological Services.

15.2 ESTIMATION AND OBSERVATION OF CLOUD AMOUNT, HEIGHT AND TYPE

15.2.1 Making effective estimations

The site used when estimating cloud variables should be one which commands the widest possible view of the sky, and it should not be affected by fixed lighting which would interfere with observations at night. In making observations at night, it is very important that the observer should allow sufficient time for the eyes to adjust to the darkness.

There are, of course, occasions when it is very difficult to estimate cloud amount, especially at night. The previous observation of cloud development and general knowledge of cloud structure will help the observer to achieve the best possible result. Access to reports from aircraft, if available, can also be of assistance.

15.2.2 Estimation of cloud amount

The observer should give equal emphasis to the areas overhead and those at the lower angular elevations. On occasions when the clouds are very irregularly

distributed, it is useful to consider the sky in separate quadrants divided by diameters at right angles to each other. The sum of the estimates for each quadrant is then taken as the total for the whole sky.

Code figure 9 is reported when the sky is invisible owing to fog, falling snow, etc. or when the observer cannot estimate cloud amount owing to darkness or extraneous lighting. During moonless nights, it should usually be possible to estimate the total amount by reference to the proportion of the sky in which the stars are dimmed or completely hidden by clouds, although haze alone may blot out stars near the horizon.

The observer must also estimate the partial cloud amount. There are times, for example, when a higher layer of cloud is partially obscured by lower clouds. In these cases, an estimate of the extent of the upper cloud can be made with comparative assurance in daylight by watching the sky for a short time. Movement of the lower cloud relative to the higher cloud should reveal whether the higher layer is completely covering the sky or has breaks in it.

It should be noted that the estimation of the amount of each different type of cloud is made independently of the estimate of total cloud amount. The sum of separate estimates of partial cloud amounts often exceeds both the total cloud amount, as well as eight eighths.

15.2.3 Estimation of cloud height

At stations not provided with measuring equipment, the values of cloud height can only be estimated. In mountainous areas, the height of any cloud base which is lower than the tops of the hills of the mountains around the station can be estimated by comparison with the heights of well-marked topographical features as given in a contour map of the district. It is useful to have, for permanent display, a diagram detailing the heights and bearings of hills and the landmarks which might be useful in estimating cloud height. Owing to perspective, the cloud may appear to be resting on distant hills, and the observer must not necessarily assume that this reflects the height of the cloud over the observation site. In all circumstances, the observer must use good judgment, taking into consideration the form and general appearance of the cloud.

The range of cloud-base heights above ground level which are applicable to various genera of clouds in temperate regions is given in the table below and

refers to a station level of not more than 150 m (500 ft) above mean sea level. For observing sites at substantially greater heights, or for stations on mountains, the height of the base of the low cloud above the stations will often be less than indicated in the tables below.

In other climatic zones, and especially under dry tropical conditions, cloud heights may depart substantially from the given ranges. The differences may introduce problems of cloud classification and increase the difficulty of estimating the height. For instance, when reports on tropical cumulus clouds of an obviously convective origin, with a base well above 2 400 m (8 000 ft) or even as high as 3 600 m (12 000 ft), have been confirmed by aircraft observations. It is noteworthy that, in such cases, surface observers frequently underestimate cloud heights to a very serious degree. These low estimates may be due to two factors, namely either the observer

expects the cumulus cloud to be a "low cloud" with its base below 2 000 m (6 500 ft) and usually below 1 500 m (5 000 ft), or the atmospheric conditions and the form of the cloud combine to produce an optical illusion.

When a direct estimate of cloud height is made at night, success depends greatly on the correct identification of the form of the cloud. General meteorological knowledge and close observation of the weather are very important in judging whether a cloud base has remained substantially unchanged or has risen or fallen. A most difficult case, calling for great care and skill, occurs when a sheet of altostratus covers the sky during the evening. Any gradual lowering of such a cloud sheet may be very difficult to detect, but, as it descends, the base is rarely quite uniform and small contrasts can often be discerned on all but the darkest nights.

Cloud-base height genera above ground level in temperate regions

Cloud genera	Usual range of height of base ^a		Wider range of height of base sometimes observed, and other remarks	
	(m)	(ft)	(m)	(ft)
Low				
Stratus	Surface-600	Surface-2 000	Surface-1 200	Surface-4 000
Stratocumulus	300-1 350	1 000-4 500	300-2 000	1 000-6 500
Cumulus	300-1 500	1 000-5 000	300-2 000	1 000-6 500
Cumulonimbus	600-1 500	2 000-5 000	300-2 000	1 000-6 500
Middle				
	(km)			
Nimbostratus	} Surface-3	Surface-10 000	Nimbostratus is considered a middle cloud for synoptic purposes, although it can extend to other levels Altostratus may thicken with progressive lowering of the base to become nimbostratus	
Altostratus				
Altostratus				
Altostratus	2-6	6 500-20 000		
High				
Cirrus	} 6-12	20 000-40 000	Cirrus from dissipating cumulonimbus may occur well below 6 km (20 000 ft) in winter Cirrostratus may develop into altostratus	
Cirrostratus				
Cirrocumulus				

^a For stations over 150 m above sea level, the base of low-level clouds will often be less than indicated.

15.3 INSTRUMENTAL MEASUREMENTS OF CLOUD AMOUNT

No completely satisfactory ground-based operational sensors are available to measure total cloud amount. Measurements from space-borne radiometers in the visible band, supplemented by infrared images, can be used to estimate cloud amounts over wide areas, even though difficulties are often experienced, for example, the inability to distinguish between low stratus and fog. Amounts of low cloud within the range of a ceilometer can be estimated by measuring the proportion of elapsed time occupied by well-identified layers and assuming that these time-averaged results are representative of the spatial conditions around the observing site. For synoptic meteorology, this technique is satisfactory in many cases but for airfield observations it can lead to significant errors in the estimation of cloud amount over the airfield. For automatic weather stations in the United States, a “clustering” technique has been developed using data from ceilometers. Other countries, like Sweden (Larsson and Esbjörn, 1995) and the Netherlands (Wauben, 2002), have introduced similar techniques in their operational observations.

15.3.1 The ASOS sky condition algorithm

In the United States National Weather Service’s Automated Surface Observing System (ASOS), the cloud height indicator (laser ceilometer — see section 15.7) compiles samples of backscatter return signals every 30 s and determines the height of valid cloud “hits”. Every minute, the last 30 min of 30 s data are processed to give double weighting to the last 10 min in order to be more responsive to recent changes in sky condition. The data are then sorted into height “bins”.

Each minute, if more than five height bin values have been recorded (during the last 30 min), the cloud heights are clustered into layers using a least-square statistical procedure until there are only five bins remaining (each bin may have many hits in it). These bins, or clusters, are then ordered from lowest to highest height. Following this clustering, the ASOS determines whether clusters can be combined and rounded, depending on height, into meteorologically significant height groups. The resulting bins now are called “layers” and the algorithm selects up to three of these layers to be reported in the METAR/SPECI in accordance with the national cloud layer reporting priority.

The amount of sky cover is determined by adding the total number of hits in each layer and computing the ratio of those hits to the total possible. If there is more than one layer, the hits in the first layer are added to the second (and third) to obtain overall coverage. For reporting purposes, the ASOS-measured cloud amount for each layer is then converted to a statistical function equivalent to a human observation.

The algorithm also tests for total sky obscuration based on criteria of low surface visibility and a high percentage of “unknown hits” at low levels.

A sky condition algorithm has also been developed for use where cloud formation (or advection) typically occurs in (or from) a known location and results in significant concurrent differences in sky conditions over an airport. This meteorological discontinuity algorithm uses input from two cloud-height indicator sensors. The primary sensor is sited near the touchdown zone of the primary instrument runway. The second sensor is typically sited 3 to 6 km (2 to 4 miles) from the primary sensor, upwind in the most likely direction of the advection, or closer to the fixed source of the unique sky condition. The second cloud-height indicator serves to detect operationally significant differences in sky conditions.

Further details on the sky condition algorithm and its verification are provided by NOAA (1988) and the United States Government (1999).

15.4 MEASUREMENT OF CLOUD HEIGHT USING A SEARCHLIGHT

15.4.1 Measurement method

Using this method, illustrated in Figure 15.1, the angle of elevation, E , of a patch of light formed on the base of the cloud by a vertically-directed searchlight beam is measured by an alidade from a distant point. If L is the known horizontal distance in metres (feet) between the searchlight and the place of observation, the height, h , in metres (feet) of the cloud base above the point of observation is given as the following:

$$h = L \tan E \quad (15.2)$$

The optimum distance of separation between the searchlight and the place of observation is about 300 m (1 000 ft). If the distance is much greater than this, then the spot of light may be difficult to see; if

it is much less, the accuracy of measuring a height above about 600 m (2 000 ft) suffers. A distance of 250–550 m (800–1 800 ft) is usually acceptable.

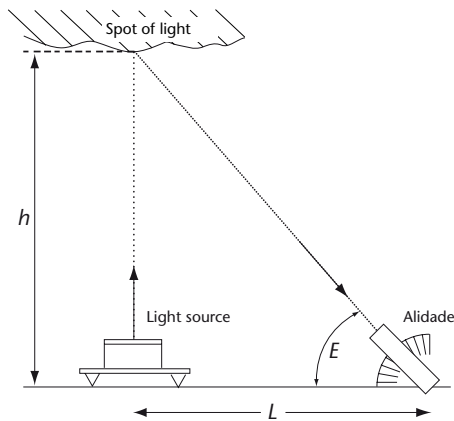

Figure 15.1. Principle of the cloud searchlight method

15.4.2 Exposure and installation

It is desirable to have a clear line of sight between the searchlight and the alidade, both of which should be mounted on firm, stable stands. Where there is a difference in the height above the ground between the searchlight and the alidade, a correction must be incorporated in the calculated heights. If a clear line of sight is not possible, any obstruction between the searchlight beam and the alidade should not be higher than 100 feet.

15.4.3 Sources of error

The largest source of error is due to uncertainty in the measured angle of elevation. Height errors due to small errors of verticality are insignificant.

The absolute error Δh in the derived cloud height due to an error ΔE in the measured elevation is given by the following (L is assumed to be an accurately measured constant):

$$\Delta h = L \cdot (1/\cos^2 E) \cdot \Delta E = L \sec^2 E \cdot \Delta E \quad (15.3)$$

with E in radians ($1^\circ = \pi/180$ rad). Note that Δh tends to infinity when $E \rightarrow 90^\circ$. If $L = 1\,000$ ft (300 m) and $\Delta E = 1^\circ$, the value of Δh is 17 ft (6 m) when $h = 1\,000$ ft (300 m), and Δh is about 450 ft (140 m) when $h = 5\,000$ ft (1 500 m). The relative error in h is given by:

$$\Delta h/h = 1/(\sin E \cdot \cos E) \cdot \Delta E \quad (15.4)$$

with E in radians. $\Delta h/h$ is minimal when $E = 45^\circ$ (or $h = L$).

15.4.4 Calibration and maintenance

The focusing and verticality of the beam, should, if possible, be checked about once a month because the lamp filament is liable to undergo slight changes in shape with time. When a lamp is replaced, the adjustment for lamp position should be carried out since not all lamps are identical.

The verticality of the beam should be checked during an overcast night with the aid of a theodolite. The check should be made from two positions, one near the alidade and the other at about the same distance away from the searchlight in a direction at right angles to the line joining the searchlight and the alidade (Figure 15.2). The azimuths of the searchlight and of the spot of light on the cloud should be measured as accurately as possible, together with the elevation of the spot of light. If the difference between the azimuth readings is A and the angle of elevation is E , the deviation ϕ of the beam from the vertical is given by:

$$\phi = \arctan(\tan A/\tan E) \approx A/\tan E \quad (15.5)$$

(for $A \approx 1^\circ$ or less)

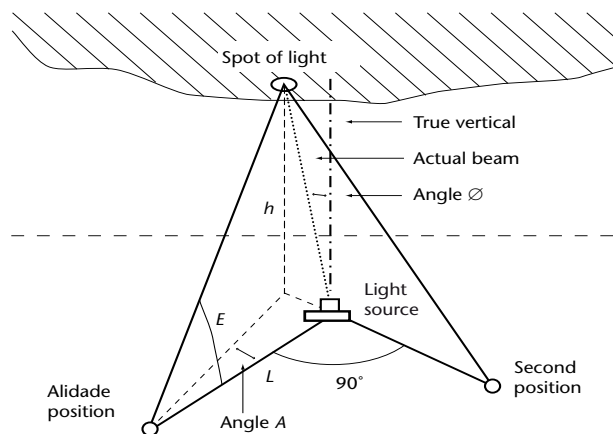

Figure 15.2. Checking the verticality of the searchlight beam

If the value of ϕ is more than 1° when viewed from the alidade, or more than 0.5° in the other position, these adjustments should be repeated until the necessary accuracy is obtained.

Focusing can be checked and adjusted on an overcast night by observing the diameter of the light spot on the highest cloud above the instrument. If

necessary, the focus should be adjusted to minimize the spot diameter.

15.5 MEASUREMENT OF CLOUD HEIGHT USING A BALLOON

15.5.1 Measurement method

Cloud height may be measured in daylight by determining the time taken by a small rubber balloon, inflated with hydrogen or helium, to rise from ground level to the base of the cloud. The base of the cloud should be taken as the point at which the balloon appears to enter a misty layer before finally disappearing.

The rate of ascent of the balloon is determined mainly by the free lift of the balloon and can be adjusted by controlling the amount of hydrogen or helium in the balloon. The time of travel between the release of the balloon and its entry into the cloud is measured by means of a stop-watch. If the rate of ascent is n metres per minute and the time of travel is t minutes, the height of the cloud above ground is $n \cdot t$ metres, but this rule must not be strictly followed. Eddies near the launch site may prevent the balloon from rising until some time after it is released. Normally the stop-watch is started on the release of the balloon and, therefore, the elapsed time between when the balloon is released and the moment when it is observed to have left the eddies will need to be subtracted from the total time before determining the cloud height. Apart from eddy effects, the rate of ascent in the lowest 600 m (2 000 ft) or so is very variable.

Although the height of the base of a cloud at middle altitude is sometimes obtained as a by-product of upper wind measurements taken by pilot balloons, the balloon method is mainly applicable to low clouds. Where no optical assistance is available in the form of binoculars, telescope or theodolite, the measurement should not be attempted if the cloud base is judged to be higher than about 900 m (3 000 ft), unless the wind is very light. In strong winds, the balloon may pass beyond the range of unaided vision before it enters the cloud.

Precipitation reduces the rate of ascent of a balloon and measurements of cloud height taken by a pilot balloon should not be attempted in other than light precipitation.

This method can be used at night by attaching an electric light to the balloon. For safety reasons, the use of candle lanterns is strongly discouraged.

15.5.2 Sources of error

Measurements of cloud-base taken using a height balloon must be used with caution, since the mean rate of ascent of a balloon, especially in the first few hundred metres, may differ appreciably from the assumed rate of ascent (owing to the effects of vertical currents, the shape of the balloon, precipitation and turbulence).

15.6 ROTATING-BEAM CEILOMETER

15.6.1 Measurement method

The rotating-beam ceilometer (RBC) involves the measurement of the angle of elevation of a light beam scanning in the vertical plane, at the instant at which a proportion of the light scattered by the base of the cloud is received by a photoelectric cell directed vertically upwards at a known distance from the light source (see Figure 15.3). The equipment comprises a transmitter, a receiver and a recording unit.

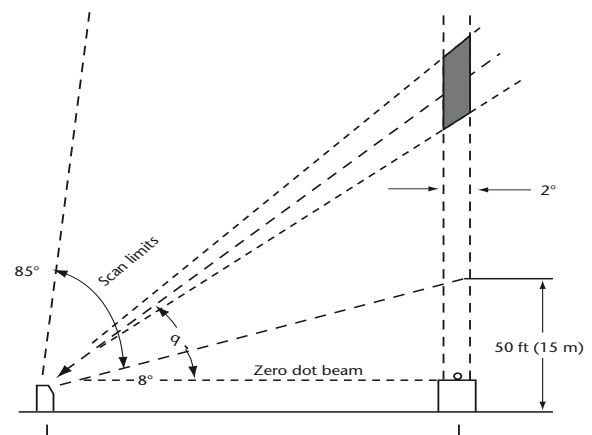

Figure 15.3. A typical rotating-beam ceilometer

The transmitter emits a narrow light beam of a 2° divergence, with most of the emitted radiation on the near infrared wavelengths, i.e. from 1 to 3 μm . Thus, the wavelength used is small in comparison with the size of the water droplets in clouds. The light beam is swept in a vertical arc extending typically from 8 to 85° and is modulated at approximately 1 kHz so that, through the use of phase-sensitive detection methods, the signal-to-noise ratio in the receiver is improved.

The receiving unit comprises a photoelectric cell and an angle-of-view restrictor; the restrictor ensures that only light vertically downwards can reach the photoelectric cell. A pen in the recording unit, moving simultaneously with the transmitter beam, records when a cloud signal is received.

15.6.2 Exposure and installation

The transmitter and receiver should be sited on open, level ground separated by some 100 to 300 m and mounted on firm and stable plinths. It is extremely important that the transmitter scans in the same plane as the receiver. This is achieved by the accurate alignment of the optics and by checking the plane of the transmitter beam in suitable conditions at night.

15.6.3 Sources of error

Errors in the measurement of cloud-base height using an RBC may be due to the following:

- Beamwidth;
- Optical misalignment;
- Mechanical tolerances in moving parts;
- Receiver response.

Since in most designs the volume of intersection of the transmitter and receiver cone is very significant with a cloud height above 500 m, beamwidth-induced errors are generally the most serious. The definition of cloud base given in section 15.1.1 is not an adequate basis for the objective design of ceilometers, thus the algorithms in current use are based on experimental results and comparisons with other methods of estimation. Some RBCs use a "threshold" technique to determine the presence of cloud, while others use a "peak" signal detection scheme. In either case, receiver sensitivity will affect reported cloud heights, giving rise to large errors in excess of stated operational requirements in some circumstances (Douglas and Offiler, 1978). These errors generally increase with indicated height.

RBCs are very sensitive to the presence of precipitation. In moderate or heavy precipitation, the instrument can either indicate low cloud erroneously or fail to detect clouds at all. In foggy conditions, the light beam may be dissipated at a low level and the ceilometer can fail to give any useful indication of clouds, even when a low cloud sheet is present.

Comparisons of RBCs and laser ceilometers have been carried out and widely reported (WMO, 1988). These have shown good agreement between the

two types of ceilometers at indicated heights up to some 500 m, but the detection efficiency of the RBC in precipitation is markedly inferior.

15.6.4 Calibration and maintenance

The only maintenance normally undertaken by the user is that of cleaning the transmitter and receiver windows and changing the chart. The outside of the plastic windows of the transmitter and receiver should be cleaned at weekly intervals. A soft, dry cloth should be used and care should be taken not to scratch the window. If the transmitter lamp is replaced, the optical alignment must be checked. The transmitter and receiver levelling should be checked and adjusted, as necessary, at intervals of about one year.

15.7 LASER CEILOMETER

15.7.1 Measurement method

With the laser ceilometer, the height of the cloud base is determined by measuring the time taken for a pulse of coherent light to travel from a transmitter to the cloud base and to return to a receiver (principle: light detection and ranging, LIDAR). The output from a laser is directed vertically upwards to where, if there is cloud above the transmitter, the radiation is scattered by the hydrometeors forming the cloud. The major portion of the radiation is scattered upward but some is scattered downward and is focused in the receiver onto a photoelectric detector. The radiant flux backscattered to the receiver decreases with range according to an inverse-square law. The ceilometer (Figure 15.4)

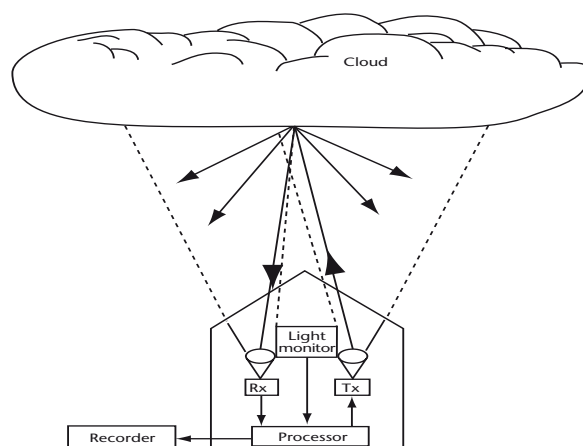

Figure 15.4. Typical laser ceilometer

comprises two units, a transmitter-receiver assembly and a recording unit.

The transmitter and receiver are mounted side by side in a single housing, together with signal detection and processing electronics. The light source is a gallium arsenide semiconductor laser that produces typically 75 W pulses of light of 110 ns duration at a rate of about 1 kHz. The wavelength of the laser radiation is 900 nm. The optics of the transmitter are arranged to place the laser source and receiver detector at the focus of a conventional or Newtonian telescope system. The surfaces of the lens are given a suitable quarter-wavelength coating to reduce reflection and to provide high transmission of light with a 900-nm wavelength. The transmitter aperture is sealed by a glass window, which is anti-reflection, coated on its inner surface and angled at approximately 20° to the horizontal so that rain will run off it.

The receiver is of similar construction to the transmitter except that the light source is replaced by a photodiode and a narrow-band optical filter is incorporated. The filter excludes most of the background diffuse solar radiation, thus improving the detection of the scattered laser radiation by day.

The transmitter beam has a divergence of typically 8 min of arc and the receiver has a field of view of typically 13 min of arc. The transmitter and receiver are mounted side by side so that the transmitter beam and the receiver field of view begin to overlap at about 5 m above the assembly and are fully overlapped at some 300 m.

The housing is provided with thermostatically controlled heaters to prevent condensation from forming on the optical surfaces, and the humidity within the housing is reduced by the use of a desiccator. The top of the housing is fitted with a cover hood incorporating optical baffles that exclude direct sunlight.

The output from the detector is separated by an electronic processing unit into sequential "range gates", each range gate representing the minimum detectable height increment. Each laser firing provides either a "cloud" or a "no-cloud" decision in each range gate; during one scan, the laser is fired many times. A threshold is incorporated so that the probability of the instrument not "seeing" cloud, or "seeing" non-existent cloud, is remote.

Some laser ceilometers provide an estimate of vertical visibility based on the integrated reflected energy within range. Comparisons carried out during the WMO International Ceilometer Intercomparison (WMO, 1988) showed that, on many occasions, values reported were unreliable and that further development of this capability would be necessary before estimates could be used with confidence.

15.7.2 Exposure and installation

The unit should be mounted on a firm, level base with a clear view overhead within a cone of approximately 30° about the vertical. If necessary, a rooftop site can be used with suitable adjustment of reported heights to ground level. Although laser ceilometers in operational use are designed to be "eye-safe", care should be taken to prevent the casual observer from looking directly into the transmitted beam.

15.7.3 Sources of error

There are three main sources of error as follows:

- (a) Ranging errors: These can occur if the main timing oscillator circuits develop faults, but, in normal operation, error due to this source can be neglected;
- (b) Verticality of the transmitted/received beams: Provided that the instrument is aligned with the beam at better than 5° from the vertical, errors from this source can be neglected;
- (c) Errors due to the signal-processing system: Because a cloud base is generally diffuse and varies greatly in time and distance, complex algorithms have been developed to estimate a representative cloud base from the returned cloud signal. In conditions of fog (with or without cloud above) and during precipitation, serious errors can be generated. Thus, it is important to have knowledge of visibility and precipitation conditions to assess the value of ceilometer information. In conditions of well-defined stratiform cloud (for example, low stratocumulus), measurement errors are controlled solely by the cloud threshold algorithms and can be assumed to be consistent for a particular make of ceilometer.

In operational use and conditions of uniform cloud base, laser ceilometer measurements can be compared routinely with pilot balloon ascents, aircraft measurements and, at night, with cloud

searchlight measurements. Intercomparisons of laser ceilometers of different manufacturers have been carried out extensively. During the WMO International Ceilometer Intercomparison (WMO, 1988), for example, several designs of ceilometer were intercompared and comparisons made with RBCs and pilot-balloon observations. Although some early comparisons between RBC and newly developed laser ceilometers indicated that the RBC had a superior performance during moderate rain, the international intercomparison revealed that, using current technology, laser ceilometers provided the most accurate, reliable and efficient means of measuring cloud base from the ground when compared with alternative equipment.

15.7.4 **Calibration and maintenance**

Most laser ceilometers are provided with built-in capability to monitor transmitted output power and guard against serious timing errors. Calibration checks are normally confined to checking both the master oscillator frequency and stability using external high-quality frequency standards, and the output power of the transmitter. Calibration may also be performed by intercomparison (WMO, 1988). Routine maintenance consists typically of cleaning the exposed optics and external covers, and of replacing air filters when cooling blowers are provided.

REFERENCES AND FURTHER READING

- Douglas, H.A. and D. Offiler, 1978: The Mk 3 cloud base recorder: A report on some of the potential accuracy limitations of this instrument. *Meteorological Magazine*, 107, pp. 23-32.
- Larsson, B. and E. Esbjörn, 1995: *Cloud Cover Algorithm*. SMHI IO-BN 1995-01-11, SMHI, Norrköping, Sweden.
- National Oceanic and Atmospheric Administration, 1988: *Federal Standard Algorithms for Automated Weather Observing Systems Used for Aviation Purposes*. Office of the Federal Coordinator for Meteorological Services and Supporting Research, United States Department of Commerce, FCM-S5-1988, Silver Spring, MD, United States.
- United States Government, 1999: *Automated Surface Observing System*. Air Force Operational Test and Evaluation Center: Final Assessment Report for the Federal Aviation Administration, California, United States.
- Wauben, W.M.F., 2002: *Automation of visual observations at KNMI: (II) Comparison of automated cloud reports with routine visual observations*. In: *Symposium on Observations, Data Assimilation and Probabilistic Prediction*. AMS Annual Meeting, 2002 Report, Orlando, FL, United States.
- World Meteorological Organization, 1975: *International Cloud Atlas: Manual on the Observation of Clouds and Other Meteors*, Volume I, WMO-No. 407, Geneva.
- World Meteorological Organization, 1987: *International Cloud Atlas*. Volume II, WMO-No. 407, Geneva.
- World Meteorological Organization, 1988: *WMO International Ceilometer Intercomparison* (D.W. Jones, M. Ouldridge and D.J. Painting). Instruments and Observing Methods Report No. 32, WMO/TD-No. 217, Geneva.
- World Meteorological Organization, 1990: *Guide on Meteorological Observation and Information Distribution Systems at Aerodromes*. WMO-No. 731, Geneva.
- World Meteorological Organization, 1995: *Manual on Codes*. WMO-No. 306, Geneva.
- World Meteorological Organization, 2003: *Manual on the Global Observing System*. Volume I, WMO-No. 544, Geneva.
-

MEASUREMENT OF OZONE

16.1 GENERAL

Ozone is a molecule made up of three oxygen atoms which is naturally formed by the photolysis of normal oxygen by ultraviolet solar radiation at wavelengths below 242.5 nm in the stratosphere. A certain amount of ozone is also produced in the troposphere in a chain of chemical reactions involving hydrocarbons and nitrogen-containing gases. Though ozone is a minor atmospheric constituent, with an average concentration of about 3 parts per million (ppmv), the radiation properties of this “greenhouse” gas make it a significant contributor to the radiative energy balance of the atmosphere, and an important regulator of the ultraviolet solar radiation received at the Earth’s surface. Most of the atmospheric ozone (90 per cent) is located in the stratosphere with a maximum concentration of between 17 and 25 km (see Figure 16.1), depending on latitude and season, where its presence causes stratospheric temperature inversion and results in maximum temperature at the stratopause. In addition to its radiation properties, ozone reacts with many other trace species, some of which are anthropogenic in origin. The geographical and vertical distributions of ozone in the atmosphere are determined by a complex interaction of atmospheric dynamics and photochemistry.

Ozone near the ground is monitored because it is a product of industrial and urban pollution. Measurements of tropospheric and stratospheric ozone are used for the verification of models that simulate the photochemistry or general circulation of the real atmosphere. Ozone is also measured to determine attenuation of the ozone layer by man-made gases, to validate model estimations of changes in ozone and to confirm the efficiency of the Montreal Protocol on Substances that deplete the Ozone Layer and its Amendments.¹ This monitoring of the ozone layer requires high-quality, long-term records of ozone at stations with well-maintained instruments, which are crucial for reliable trend analyses.

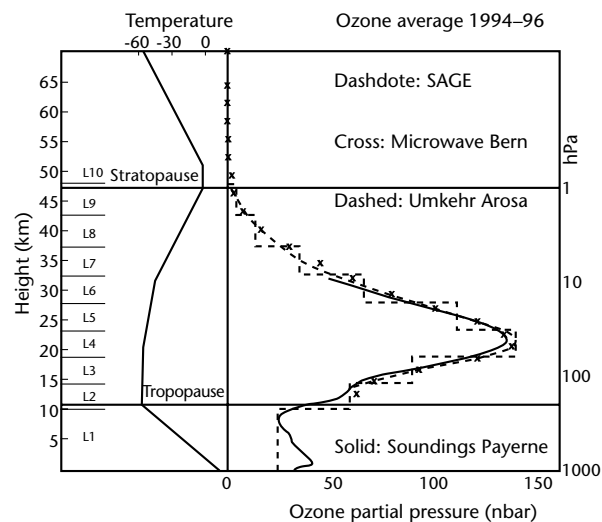

Figure 16.1 Example of the vertical average distribution of ozone in the atmosphere over Switzerland and different techniques of measurement applied (J. Staehelin, ETH, Zurich)

16.1.1 Definitions

There are basically three characteristics of atmospheric ozone that are routinely measured and reported by ground and satellite monitoring systems, namely:

- Surface ozone;
- Total ozone;
- The vertical profile of ozone.

Surface ozone expresses the concentration of local ozone in the layer a few metres above the ground at a particular site on the Earth’s surface. Surface ozone measurements are commonly given in units of partial pressure or mixing ratio (by either mass or volume).

Total ozone refers to the total amount of ozone contained in a vertical column in the atmosphere above the ground extending from the earth’s surface to the upper edge of the atmosphere. Commonly used units of total ozone are (a) column thickness of a layer of pure ozone at standard temperature and pressure (STP) and (b) vertical column density (number of molecules per area).

The vertical profile of ozone expresses ozone concentration as a function of height or ambient pressure. The amount of ozone at each height or pressure

1 See <http://ozone.unep.org/pdfs/Montreal-Protocol2000.pdf>.

level in the atmosphere is commonly expressed as partial pressure, mixing ratio or local concentration (number density). The integral of the ozone profile from the ground to the top of the atmosphere is the total column amount of ozone.

The following are definitions of other terms used frequently in this context:

Aerosols: A suspension, in a gaseous medium, of solid particles, liquid particles, or solid and liquid particles

Relative optical air mass: The ratio of the slant path of solar radiation through the atmosphere (or through a layer) to the vertical path.

Dobson unit (DU): A measure of total ozone equaling a thickness of 10^{-5} m of pure ozone at STP (commonly used but not a unit in the International System of Units).

Milliatmosphere centimetre (m-atm-cm): A measure of total ozone equal to 10^{-3} cm of pure ozone at STP (1 m-atm-cm is equivalent to 1 DU).

Ozone: An unstable blue gaseous allotrope of oxygen and a strong oxidant. It absorbs selectively radiative energy in the 100–340- and 550–650-nm bands of the solar spectrum and at 4 700, 9 600, and 14 100 nm in the infrared.

Spectrophotometer: An instrument for creating a spectrum and measuring the spectral radiance at selected wavelengths.

Ultraviolet (UV): Electromagnetic radiation in the 100–400-nm range which is often divided into UV-A (315–400 nm), UV-B (280–315 nm) and UV-C (100–280 nm).

Umkehr: An optical effect appearing close to sunrise or sunset when relative zenith sky radiances increase with increasing solar zenith angle. By taking a series of zenith measurements with spectrophotometers at selected UV wavelengths, it is possible to infer the vertical distribution of ozone. These ground-based measurements are performed only for clear skies.

16.1.2 Units and scales

A complete description of the units is given in Annex 16.A, and a brief summary is given in Table 16.1 below:

Table 16.1. Summary of units and scales used

<i>Local ozone</i>	<i>Units</i>	<i>Column ozone</i>	<i>Units</i>
Partial pressure	Millipascal	Total ozone	m-atm-cm 10^{-3} cm ozone at STP DU
Mass mixing ratio	$\mu\text{g g}^{-1}$		
Volume mixing ratio	ppmv		
Local concentration	Molecules cm^{-3} Molecules m^{-3}	Column density	m-atm-cm km^{-1}
Local density	g m^{-3} $\mu\text{g cm}^{-3}$		

Note: In honour of the pioneering work of G.M.B. Dobson, the unit of the vertical column of ozone (total ozone), the milliatmosphere centimetre (m-atm-cm), may also be called the Dobson unit (DU). One Dobson unit defines the amount of ozone in the vertical column which, when reduced to a temperature of 0°C and a pressure of 10 1325 Pa, will occupy a depth of 10^{-5} m.

16.1.3 Measurement methods

Atmospheric ozone is measured both by remote sensing and by in situ techniques. In situ measurements of ozone are taken by analysing a sample of the air to determine its ozone content by optical, chemical or electrochemical techniques. Remote-sensing measurements are taken by using differential absorption techniques. Ozone has a strong and variable absorption spectrum for UV wavelengths shorter than 340 nm, a weaker broad absorption peak centred around 600 nm in the visible light, and many absorption and thermal emission lines at infrared and microwave wavelengths. By measuring spectral irradiance from a natural (sun) or man-made source after it has passed through atmospheric ozone, it is possible to determine the amount of ozone in the optical path. The amount of thermal radiation emitted by atmospheric ozone is also measured and used to determine ozone amounts.

The accuracy of virtually all types of routine ozone measurements could be affected by errors in the knowledge of the ozone absorption spectrum. All surface and ground-based total ozone measurements depend on the ozone absorption coefficient (α) of the wavelength used (see equations 16.1 and 16.2). Umkehr and ozonesonde measurements of the ozone profile are normalized to a nearly coincident ground-based total ozone measurement. Absorption coefficients

are used in the inversion algorithms for light detection and ranging (LIDAR) and for satellite measurements of total ozone and the ozone profile.

Several groups have made a significant effort to measure the ozone-absorption spectrum in the laboratory. Measurements have been taken over a wide range of temperatures because there is a strong temperature dependence of the absorption. The International Ozone Commission of the International Association of Meteorology and Atmospheric Physics (IAMAP) (<http://www.esrl.noaa.gov/gmd>) recommended (Megie, Miller and Bojkov, 1991), and WMO adopted, a standard ozone spectrum effective as of 1 January 1992 based on measurements provided by Bass and Paur (1985). This absorption spectrum has replaced the Vigroux ozone absorption coefficients previously used for ozone measurements (IAMAP, 1967). As the absorption spectra are temperature dependent, further investigations were carried out, e.g. by Molina and Molina (1986), Brion and others (1993) and Burrows and others (1999), to determine how the absorption depends on temperature. The same absorption spectrum has to be used if ozone observations from different instruments are compared. There are a number of other sources of errors in the measurement of ozone which depend on what is being measured and the method used to take the measurements. These are discussed below.

16.2 SURFACE OZONE MEASUREMENTS

16.2.1 Instruments for measuring surface ozone

Surface ozone is routinely measured by ozone analysers, which measure the concentration of ozone in ambient air in situ. The most commonly used instruments for measuring surface ozone are UV photometric ozone analysers. These instruments measure ozone by UV absorption photometry in a narrow wavelength interval (≈ 0.5 to 1 nm) at 254 nm. The dry chemical analyser – which applies the chemiluminescence method – and the wet chemical analysers used to be in routine operation, but their use is becoming less common because these methods are not as reliable as the UV absorption method. UV absorption photometry is the method recommended by the WMO/Global Atmosphere Watch (GAW) Scientific

Advisory Group on Reactive Gases. Technical information regarding ambient ozone-monitoring instruments is given by Paur and McElroy (1979). Intercomparisons of surface ozone instruments have been made (Attmannspacher and Hartmannsgruber, 1982; Klausen and others, 2003).

16.2.2 UV photometric measurement of surface ozone

Surface ozone is routinely measured by in situ techniques. The most commonly used method is that of UV photometry, where ambient air is drawn through a cell in which the absorption of UV radiation is measured at the 254-nm emission line of a mercury lamp. The strong absorption by ozone at this wavelength produces a detectable absorption measurement when ozone is present in the cell. The absorption cell alternately samples ambient air coming directly from the atmosphere and ambient air diverted through a manganese dioxide “scrubber” that converts ozone catalytically to oxygen but leaves all other trace gases intact and the relative humidity almost constant. The UV irradiance is therefore measured in the presence and absence of ozone in the ambient air. The measured irradiance in the presence of ozone, I , is related to the measured irradiance in the absence of ozone, I_0 , by the following expression:

$$I = I_0 \exp(-\alpha CL) \quad (16.1)$$

where α is the absorption cross-section of ozone at 254 nm (cm^2), C is the concentration of ozone in the cell (molecules cm^{-3}), and L is the length of the cell (cm). By comparing the two irradiance signals it is possible to determine the concentration of ozone in the cell, provided that the length of the cell and the absorption cross-section for ozone are known. Ozone measurements are reported as parts per billion volume or partial pressure. The range of detectability is from 1 to 1 000 ppbv.

16.2.3 Exposure of instruments for surface ozone

The in situ instruments for measuring surface ozone usually operate in an indoor laboratory, with the ambient air being pumped to the analyser through a clean Teflon tube. The intake of the tube is mounted so that the air being sampled is representative of the local atmosphere. The intake should be at a height of at least 3 m above the

ground (usually on a rooftop). The inlet should be inverted and protected by a funnel to avoid the intake of rainwater and to minimize the intake of particles and dirt. All potential causes of a disturbance in the composition of the local atmosphere (for example, a roadway, chimney, ventilation fan, and the like) should be avoided. There should be a Teflon particle filter at the intake in order to prevent particles and dirt from contaminating the transfer tube and the filter should be changed when required (about once a week depending on the atmospheric conditions). The inlet tube must be kept clean and as short as possible to ensure that ozone is not destroyed before it is measured. A compromise between a high intake height and a short tube usually results in the length of the tube being between 3 and 5 m.

If background (non-polluted) surface ozone values are being measured, the site should be located away from major pollution sources (cities). The stations should satisfy the regional and/or global station criteria of the GAW, as specified in WMO (1988) and approved by the forty-fourth session of the Executive Council, held in June/July 1992 (WMO, 1993).

16.2.4 **Errors in measuring surface ozone**

The main source of error for all in situ ozone analysers measuring surface ozone is the loss of ozone along the inlet tube and at the particle filter. This error can be minimized by ensuring that the tube and the particle filter are kept clean and dry.

Some other trace gases absorb radiation at the the 254-nm wavelength, which is used to measure ozone absorption. The differential methods of comparing between ambient air with ozone and with ozone removed avoid the problem of other absorbing gases because they are present during both measurements. However, should the concentration of another gas change between the ozone and non-ozone sampling periods, an erroneous ozone measurement will result. Also, incomplete removal of ozone due to a defective scrubber will compromise the measured ozone values.

In general, ozone measurements taken using the UV photometer method are very stable because they are relative measurements (comparing absorption in a cell containing ozone with that in a cell without ozone present). The output of the lamp and the sensitivity of the detector may drift

without affecting the ozone-absorption measurement. The uncertainty and bias of surface ozone measurements using the UV absorption method has been assessed by Klausen and others (2003).

16.2.5 **Comparison, calibration and maintenance of instruments for surface ozone**

UV photometric instruments are recognized as being absolute instruments. The absolute calibration of a UV photometric analyser depends on the accuracy of the value of the absorption cross-section of ozone at 254 nm. This measurement is taken by measuring the absorption in a cell containing a known amount of ozone. The amount of ozone in the cell must be determined by a chemical or physical process which yields the number of ozone molecules in the cell. These absolute concentration measurement methods include passing ozone through a potassium iodide solution, titrating ozone with nitric oxide, and measuring pressure change as oxygen is converted to ozone. The ozone cross-section is estimated to have an uncertainty to within ± 5 per cent.

The UV photometric measurement is also recognized as a reliable method to transfer the primary calibration to the field. The world reference for in situ ozone measurements is the Standard Reference Photometer (SRP) maintained by the National Institute of Standards and Technology and the International Bureau of Weights and Measures. Transfer standards are calibrated against an SRP. A field instrument is then inter-compared by measuring a sample of ozone (generated either in the laboratory or in ambient air) by both the field instrument and the transfer standard (Klausen and others, 2003).

16.3 **TOTAL OZONE MEASUREMENTS**

16.3.1 **Methods for measuring total ozone**

Total ozone is measured by remote-sensing techniques using ground-based and satellite instruments that measure irradiances in the UV absorption spectrum of ozone between 300 and 340 nm. Total ozone is measured from the ground using the direct sun, direct moon and zenith sky irradiances and from space by measuring the solar UV radiation scattered back to space by the Earth's atmosphere.

In this section, the basic ground-based techniques are described. Space observations are characterized only generally in section 16.6 as their technologies are very complex and tied to individual satellite missions.

16.3.2 Ground-based instruments for measuring total ozone

Ground-based remote-sensing instruments which measure the intensity of UV light at wavelengths in the absorption spectrum of ozone can be used to determine total ozone by differential optical absorption spectroscopy (DOAS) techniques. The most commonly used ground-based instruments in the ozone network of the WMO GAW Programme are the Dobson (Dobson, 1957; WMO, 1980) and Brewer (Kerr, McElroy and Olafson, 1980; Wardle and others, 1987) ozone spectrophotometers, and the M-124 filter ozonometer (Gushchin, Sokolenko and Kovalyev, 1985). Other measuring instruments have been developed but their use has been limited to special experimental applications rather than to routine monitoring and data reporting.

16.3.2.1 Direct sun measurements

The most accurate and the best-defined method for determining total ozone is to measure direct solar radiation from the ground at UV wavebands between 305 and 340 nm. The method comes from the Lambert-Beer law that defines the direct spectral irradiance $I_{0\lambda}$ reaching the Earth's surface at wavelength λ after attenuation by column amounts by particular atmospheric constituents X_i :

$$I_{\lambda} = I_{0\lambda} e^{-\sum \alpha_{\lambda i} X_i \mu_i} \quad (16.2)$$

where $I_{0\lambda}$ is a constant identified as the reading of I_{λ} by the instrument if it is located above the atmosphere (the extraterrestrial constant), $\alpha_{\lambda i}$ are the laboratory-measured extinction coefficients of the attenuating species, and μ_i are the ratios of the slant paths of the beam through the layers of the absorbing/scattering species to the vertical paths (relative optical air masses). If a spectrophotometer measures spectral irradiances I_{λ} at several wavelengths λ_i with different ozone absorptions, the influences of other atmospheric attenuators (mainly aerosols) can be eliminated by linear combinations of equation 16.2. A general relation for the calculation of total ozone

from direct sun observations X_{DS} can be determined (see Annex 16.B) by:

$$X_{DS} = \frac{F_0 - F - \beta m}{\alpha \mu} \quad (16.3)$$

where F is the combination of $\log(I_{\lambda i})$, F_0 is the combination of $\log(I_{0\lambda i})$, the constants for the instrument, α and β , are the differential absorption and scattering coefficients of ozone in pure air, μm are the relative optical air masses of the ozone layer and the whole atmosphere, respectively. In equation 16.3, the value F comes from measurements taken by the instrument, F_0 is the calibration constant of the spectrophotometer, α and β are laboratory-determined values, and μm are calculated for the time and the geographical location of the measurement from astronomical relationships. Direct sun measurements are limited to daylight hours at times when the direct solar beam is not obscured by clouds or other obstacles for a period of at least 2 min (Dobson) or 5 min (Brewer). The solar zenith angles suitable for observations differ for particular types of spectrophotometers and wavelengths used for the measurements but usually do not exceed 72° for the Dobson and M-124 filter instruments and 75° for the Brewer spectrophotometer. While the Dobson spectrophotometer measures relative ratios of spectral irradiances at three wavelength pairs (A: 305.5/325.4; C: 311.5/332.4; D: 317.6/339.8 nm), the Brewer spectrophotometer registers spectral irradiances (photo counts) at five operational wavelengths (306.3, 310.1, 313.5, 316.8 and 320.1 nm). The M-124 filter instrument measures at 302 and 326 nm with the spectral band pass of 20 nm. Details on modification of the relation (equation 16.3) for particular types of instruments and their application for the processing of total ozone observations can be found in the references in section 16.3.2 or in the relevant GAW publication (WMO, 2003).

The Brewer spectrophotometer measures UV irradiances at several wavelengths that make it possible to calculate the total column amount of sulphur dioxide in the atmosphere using an equation similar to 16.3. The relevant equation is developed by other linear combinations of differential absorption and scattering coefficients and spectral irradiances I_i . For processing total sulphur dioxide measurements, an extra-terrestrial constant for sulphur dioxide has to be defined in the calibration of the instrument.

16.3.2.2 Direct moon measurements

Total ozone can also be measured by the direct moon method where the solar radiation reflected by the moon is used as the source of the UV radiation. This method is similar in principle to the direct sun measurement method but is less precise because of the reduced amount of available UV and the difficulty in taking measurements. The measurement period is limited to within five days of the full moon, so complete coverage on a daily basis is not possible. Also, the direct beam from the moon must be clear of clouds, and the apparent zenith distance of the moon must be less than 75°. The direct moon measurements may be useful during polar nights. Nevertheless, this method is not widely used at GAW stations.

16.3.2.3 Zenith sky measurements

The zenith sky measurement method has been developed for use on days when the sun is obscured by clouds, in order to satisfy the desire to measure total ozone on a daily basis. Empirically, evidence shows that the information content of UV scattered from the zenith sky to the Earth's surface is sufficient to provide a reasonable measurement of total ozone. The measurement of the relative magnitude of UV at a set of wavelengths is dependent both on total ozone and on the μ value. If a large set of near-simultaneous zenith sky and direct sun observations (hundreds) are available, the direct sun total ozone values can be used to develop empirical regression functions $f(F, \mu)$ that make the calculation of zenith sky total ozone values X_{ZS} possible as follows:

$$X_{ZS} = f(F, \mu) \quad (16.4)$$

The statistical functions $f(F, \mu)$ are defined as multi-regression polynomials (zenith polynomials) to replace the previously used manual charts. The zenith sky measurements are limited to daylight hours when the solar zenith angle does not exceed 80°. They are less accurate than the direct sun measurements because the path of the scattered light through the atmosphere and the ozone layer is longer and its attenuation depends on other variables, such as the vertical distribution of ozone and the presence of clouds. The results of the zenith sky observations are forced to the level of the direct sun observations in the long term by this method. Given that the conditions allowing the near-simultaneous zenith sky and direct sun observations may have a different total ozone amount than that under the conditions allowing only zenith sky observations (especially cloudy zenith), the

precision of the results of zenith sky observations is further reduced.

16.3.3 Exposure of instruments used for the measurement of total ozone

The ground-based remote-sensing instruments for measuring ozone in the stratosphere are installed according to their viewing requirements. In general, an observatory with a clear view of the sun and zenith sky is required. The measurement site should avoid sources of local pollution or other contaminants which may affect the optical properties of the local atmosphere in the UV region, mainly aerosols and sulphur dioxide. All types of spectrophotometers must be equipped with external drying systems or internal desiccants to keep the components of the optical system and electronics of the instruments permanently dry. The spectrophotometers should be operated under stable temperature conditions so that their sensitivity and adjustments do not change rapidly during measurements. For this reason, the Dobson instruments should be equipped with insulating covers.

The Dobson and M-124 instruments are stored indoors and must be transported outside to take a measurement using sunlight or zenith skylight. The requirement to move the instrument outdoors is avoided at some observatories by the use of a roof hatch or observation dome which is opened to take a measurement. The fully automated Brewer instrument is permanently mounted outdoors at a location allowing a good view of the sun above an elevation of 15° on all days of the year. The instrument is levelled and its alignment is fixed to the sun in order to allow automatic pointing at the sun. Each spectrophotometer is also equipped with an internal heating system.

16.3.4 Errors in measuring total ozone

Equation 16.3 is the fundamental physical basis for the measurement of total ozone by the direct sun method. Some of the errors in the measurement are demonstrated by considering the uncertainties in the individual terms in this equation. A detailed description and explanation for the Dobson spectrophotometer can be found in WMO (1982a).

The extra-terrestrial constant F_0

F_0 is the reading that an instrument would obtain on solar radiation outside the Earth's atmosphere with no ozone in the light path. This value is not measured directly; it is determined either from a

number of air-mass extrapolation measurements (the absolute calibration or Langley-Plot method) or by calibrating an instrument against a standard with a known F_0 (see sections 16.3.5.1 and 16.3.5.2). Errors in F_0 of a particular spectrophotometer may arise from uncertainty of the initial calibration towards the standard, or from a change (either a gradual drift or an abrupt shift) in the optical properties of the instrument. Long-term results of calibration campaigns show that uncertainties in the initial calibrations (definition of F_0 from comparison toward a standard at the beginning of a campaign before any work is done) generally result in measurement errors of less than 1.0 per cent. If Dobson and Brewer spectrophotometers are maintained and operated according to their standard operation procedures (see section 16.3.5.2), the shift of their precision by natural ageing is usually less than 2.0 per cent in a four-year period (Vanicek, 2003; Evans and others, 2004a; Lamb, 2004; Köhler, 2004). However, errors in F_0 due to sudden changes in the technical condition of the instrument (e.g. damage, shift of the optical alignment, a fast deterioration of the phototube or filters) can result in measurement errors of up to 10 per cent and greater. Variability in the radiation spectrum emitted from the sun would also cause an error in F_0 . It is believed that errors from solar variability are less than 0.3 per cent (WMO, 1982b; 1990). These errors affect the accuracy of the resultant ozone value. The detection of such changes is often possible by using monthly lamp tests (see section 16.3.5.2).

The differential spectral reading F

There are instrumental errors in the reading of F . One potential source of error is a non-linear response from the instrument. In the case of the Dobson instrument, an unavoidable non-linearity arises mostly because of irregularities in the optical wedges of the instrument. Non-linearity of a Brewer instrument could appear due to an incorrect definition of the photomultiplier dead time of the photon counting system. Both of these effects are corrected by calibration measurements. Generally, this uncertainty is less than 0.3 per cent for the Brewer instrument and less than 0.5 per cent (WMO, 1982a) for the Dobson instrument. These errors affect the accuracy and precision of the resultant ozone value. Errors in the measured value F also arise from the random uncertainty (noise) in the measured signal. For both the Brewer and Dobson instruments, this error is estimated to be less than 0.3 per cent for a typical direct sun measurement.

The relative optical air mass of the ozone layer μ

Another source of error in the determination of total ozone is the optical air mass of the ozone layer (μ). This value is calculated from the date and time of the measurement and from the geographical coordinates of the location of the instrument (latitude, longitude, altitude). Errors of 1 latitude or longitude or 10 s in time can, in certain parts of the year, result in an error of 0.1 per cent in the μ value. Calculations of μ assume that the ozone layer is optically centred at 22 km above the station. A deviation of a 2 km height from this assumption could result in a 0.25 per cent error in the μ value and consequently up to 2 per cent in total ozone for $\mu > 3.2$. Therefore, for the best measurements, the 10 s time resolution of F readings is recommended and the calculation of μ should include geographical approximation of the altitude of the ozone layer. This is important especially for measurements of total ozone in high latitudes where observations are taken at low solar zenith angles.

Ozone absorption coefficient α

The uncertainty of the differential absorption coefficient α in equation 16.3 for a specific instrument arises from the uncertainty of the slit transmission functions. The spectrophotometers operated in the GAW global network are assumed to have the same slit functions as the world reference instruments if their slit tests agree with desired limits defined by the instrument designers (Dobson 1957; SCI-TEC, 1993). In reality, this assumption is not fully satisfied and the effective wavelengths selected by slits can differ from the assumed wavelengths. For Dobson spectrophotometers it is very difficult to determine correct absorption coefficients because very sophisticated laboratory investigations and adjustments are needed to do this. For a Brewer spectrophotometer, the effective wavelengths can be determined and ozone absorption coefficients are defined by the "dispersion test", which can be performed under routine calibration at the station. As mentioned in section 16.1.3, on 1 January 1992 the new Bass-Paur set of ozone absorption coefficients was adopted as a new international standard scale. An additional error in the ozone absorption coefficients arises from their temperature dependence. This is especially important for the absorption coefficients of the Dobson spectrophotometer which were defined for the representative stratospheric temperature -46.3°C (Komhyr, Mateer and Hudson, 1993). Because the effective temperature of the ozone layer (determined from the vertical profile of ozone weighted by the vertical profile of

temperature) is not stable by latitude and season, the values of the differential absorption coefficients can differ by about 1.2 per cent per 10 K for the reference AD² wavelength combination (Kerr, Asbridge and Evans, 1988). Such a temperature effect can produce additional error in total ozone which is estimated to be 1–1.5 per cent (Köhler, 1999; Vanicek, Stanek and Dubrovsky, 2003; WMO, 2003). As the Brewer instrument uses combinations of wavelengths such that the atmospheric ozone absorption coefficients are independent of the stratospheric temperature (Kerr, 2002), the accuracy of the Brewer should be considered better than that of the Dobson instrument.

Other absorbing gases and aerosols

The absorption of UV by other atmospheric gases can also influence the accuracy of total ozone measurement. Sulphur dioxide in particular has been found to be a significant contributor to errors. These are generally about 1 per cent for a Dobson instrument operated in unpolluted locations (Kerr, Asbridge and Evans, 1988). However, in areas with high local sulphur dioxide emissions or during inversion situations, the effect can reach up to about 10 per cent of the column ozone (DeMuer and DeBacker, 1992; Vanicek, Stanek and Dubrovsky, 2003). As mentioned in section 16.3.2.1, the Brewer instrument can measure the total column of sulphur dioxide if its extra-terrestrial constant has been defined. This makes it possible to eliminate the influence of sulphur dioxide on the accuracy of total ozone measurement. The effect of aerosols is mostly eliminated by the technology of direct sun observations (see Annex 16.B) and its contribution to errors of total ozone measurements is estimated to be less than 1 per cent. This is also the magnitude of errors caused by thin cirrus clouds.

Zenith observations

The three basic instruments used in the GAW ozone network (Dobson, Brewer and M-124 filter) can also measure total ozone by observing the scattered solar radiation from the sky. The accuracy and precision of these measurements depend on the calibration of an instrument, on the quality of zenith polynomials $f(F, \mu)$ in equation 16.4 and on the real sky conditions during the observation. While the manual operation of Dobson and filter instruments allows operators to specify

the sky condition and then use the “zenith blue” or “zenith cloudy” polynomials, the Brewer zenith measurements can be processed only by means of a general “zenith sky” polynomial. Given that the results of the zenith measurements are forced to be the same as the direct sun results in the long term, the zenith measurement accuracy can be, at best, the same as that of the direct sun.

The precision of zenith observations is usually estimated by a comparison of quasi-simultaneous direct sun and zenith sky total ozone measurements taken within 10 min or more. Several studies (DeBacker, 1998; Vanicek, Stanek and Dubrovsky, 2003) found a 1.5 per cent precision for Dobson instrument measurements made on the clear zenith and of about 3 per cent for those taken on the cloudy zenith according to the opacity of the cloudiness. For the Brewer spectrophotometer differences against direct sun, values are more variable and generally a precision of up to 3 per cent can be reached for all skies, except those with heavy clouds. The accuracy of the M-124 filter instrument is about 4 per cent for blue and up to 6 per cent for cloudy observations with a significantly higher variation of biases of individual measurements (Gushchin, Sokolenko and Kovalyev, 1985; Feister, 1991). Nevertheless, the above limits of the accuracy require the application of zenith polynomials that have been developed for a particular instrument and station given that $f(F, \mu)$ are dependent mainly on the external and internal scattered UV radiation reaching the light detector of the instrument. In mid- and high latitudes, the zenith polynomials derived and used for summer and winter seasons separately give a better and more stable accuracy of zenith measurements (Asbridge, Vanicek and Stanek, 1998).

16.3.5 **Comparison, calibration and maintenance of instruments for measuring total ozone**

16.3.5.1 **Calibration of primary standard instruments and calibration scales**

The calibration of a field instrument is ultimately traced to a reference standard. The Dobson reference is the WMO-recognized World Primary Dobson Spectrophotometer (WPDS) No. 83, which is maintained at the National Oceanic and Atmospheric Administration (NOAA) Earth System Research Laboratory (ESRL)/Global Monitoring Division (GMD) in Boulder, Colorado (Komhyr, Grass and Leonard, 1989). The Brewer

² AD is the difference between the absorption of pairs of wavelengths which are most commonly used for the total ozone calculations, where the wavelengths (in nm) are A: 305.5/325.4; D: 317.6/339.8.

reference consists of three primary instruments (B008, B014 and B015). This Brewer reference triad is maintained as the WMO world standard group by the Meteorological Service of Canada (MSC), formerly the Atmospheric Environment Service, in Toronto, Canada (Kerr, McElroy and Wardle, 1998). All M-124 field ozonemeters are referenced to the Dobson spectrophotometer D108, maintained at the Voeikov Main Geophysical Observatory (MGO) in St Petersburg, the Russian Federation (Bojkov, Fioletov and Shalamjansky, 1994). It is important to note that the Dobson and Brewer world standards are used for calibration of the same types of spectrophotometers in the global network. Thus, both the WPDS and the Brewer reference triad define their own separate calibration scales that are transferred to station instruments (see section 16.3.5.2).

The world reference spectrophotometers are calibrated by a sophisticated Langley-plot method, sometimes called “absolute calibration”. The method is based on the determination of the extra-terrestrial constant F_0 from equation 16.3, which can be restated as follows:

$$F + \beta m = F_0 - \alpha X_{DS} \mu \quad (16.5)$$

Where α and β are constants. If certain atmospheric conditions are met (near constant total ozone, negligible influence of the atmospheric aerosol, stable Rayleigh air scattering of solar radiation and fully clear skies on days with observations), a series of direct sun observations of $F + \beta m$ are made by the standard instrument during the day at different values of μ . These observations are subsequently plotted against μ and the linear fit to the data points extrapolated to $\mu = 0$ in order to determine F_0 . Normally, the calibration is an average based on many days of observations, and the equations are transformed to produce a correction to the existing calibration. The specific atmospheric conditions required can be found only at a few observatories around the world. For this reason, the absolute calibrations of both Dobson and Brewer world standards are performed regularly at NOAA’s subtropical, high-altitude at Mauna Loa Observatory in Hawaii (19.5°N 155.6°W, at 3 397 m). Analyses of absolute calibrations show that the calibration stability of the references has been maintained with a precision of about 0.5 per cent during the last 20 to 25 years (Evans and others, 2004b; Fioletov and others, 2004). This long-term behaviour reflects all technical aspects that can influence the calibration state of the standards, i.e. selection of effective

wavelengths, sensitivity of photo-detection of irradiances, non-linear responses of the electronics, ageing of optical elements, internal scattering.

16.3.5.2 Calibration transfer and maintenance

The absolute calibration determined for the primary references must be transferred to all field instruments and the individual instrument’s calibration must be carefully maintained.

The basic method to transfer the calibration scale of the primary Dobson standard to a field instrument is through the simultaneous direct sun intercomparative side-by-side observations of total ozone. The measurements should be taken on at least one half-day with the adequate range of $\mu = 1.15-3.2$ and good observing conditions. The extra-terrestrial constant of the field instrument is adjusted to provide the best fit for total ozone values with the reference instrument for the direct sun AD values. It is not practical to bring all field instruments to the same site where the primary standard instrument is located. Therefore, the field instruments are usually calibrated at regional intercomparisons where spectrophotometers from a geographical region are collected and calibrated either against the travelling reference or against a regional standard directly tied with WPDS D083. For almost three decades the majority of the Dobson spectrophotometers from the GAW stations have been calibrated every four years at intercomparisons organized by WMO. Either the D065 spectrophotometer from the NOAA ESRL/GMD (as the travelling reference) or regional standards from WMO Regional Dobson Calibration Centres (D064, Hohenpeissenberg, Germany; D074, Hradec Kralove, Czech Republic; D089, Irene, South Africa; D097, Buenos Aires, Argentina; D105, Perth, Australia; and D116 Tsukuba, Japan) are used for calibration campaigns. The results of intercomparisons show that the Dobson calibration scale of WPDS is transferred to station instruments with an accuracy of 1 per cent, as documented in WMO/GAW reports (WMO, 1994; 2001a; 2002).

Calibration constants are transferred to a field Brewer instrument by intercomparison with a secondary travelling reference instrument every two years (recommended). Both the reference and the field instruments take simultaneous direct sun ozone measurements throughout a day which has good observing conditions over a sufficient range of $\mu = 1.15-3.2$. Values of absorption coefficients and extra-terrestrial constants for the field instrument are determined by fitting the data to total

ozone measured by the standard and by lamp tests. Calibration of the secondary travelling reference is checked at Toronto prior to departure to the field and on its return to ensure that the calibration has not altered in transit. Except for the Canadian (MSC) Brewer instruments, the majority of Brewer spectrophotometers in the global network are calibrated commercially by the secondary travelling reference B017 owned by the private company, International Ozone Service, Toronto. The B017 instrument is directly tied to the Brewer reference triad with the precision of 0.8 per cent and every one to two years is also absolutely calibrated at the Mauna Loa observatory similarly to the Brewer triad. Results of Brewer intercomparisons show that the B017 transfers the Brewer calibration scale to stations with the accuracy of 1 per cent (McElroy, Sevastouk and Lamb, 2004). To build up a GAW regional Brewer calibration system, the first Regional Brewer Calibration Centre for the Regional Association VI (Europe) region was established at the Izaña Observatory of the National Meteorological Institute of Spain in the Canary Islands in 2003.

The M-124 field ozonometers are recalibrated, on average, every two years by direct intercomparison with a D108 Dobson instrument at the MGO in St Petersburg. The instruments at stations are replaced every two years by recently calibrated ozonometers and brought to the calibration site at the MGO where they take simultaneous direct sun readings with the Dobson D108 spectrophotometer. Instrument readings as a function of solar zenith angle and total ozone, as measured by the Dobson instrument, are determined. The calibrated instruments are then returned to the field at different sites. In this way, the network of M-124 ozonometers is maintained in the calibration scale of WPDS D083. Although the D108 is calibrated with about 1 per cent precision every four years, the accuracy of the transfer of the calibration scale into the M-124 network is estimated to be about 3 per cent (Shalamyansky, 2003).

Routine checks by natural solar radiation and lamp tests are required to maintain the calibration constants of all reference and field instruments. These checks verify that an instrument is operating properly and, if this is not the case, alert the operator to a potential problem. Results of the tests are used to correct an instrument calibration, if necessary, and to help determine whether an instrument requires recalibration.

Calibration verifications for the wavelength settings and response to the standard relative irradiance are carried out once a month on the Dobson instrument. The wavelength setting is measured and adjusted by measuring the emission lines from a mercury vapour lamp. The instrument's response to relative irradiance is checked at all three wavelength pairs by measuring the output of a quartz halogen lamp defined as a "standard" lamp for that specific instrument. This measurement is used to adjust the instrument's extra-terrestrial constant, if necessary.

Verifications of the wavelength setting, response to irradiance levels, and photomultiplier dead time are carried out daily for the Brewer instrument. Emission lines from a mercury vapour lamp are used for wavelength calibration and setting. The emission from the instrument's internal quartz halogen lamp is measured to monitor the instrument's response to irradiance and to adjust the extra-terrestrial constants, if necessary. Linearity is checked by measuring the photomultiplier dead time. Outputs from the above tests are recorded and used for the operational adjustments of calibration constants or for a backward reprocessing of observations.

16.3.5.3 Differences between Dobson and Brewer total ozone observations

Although Dobson and Brewer measurements of total ozone are based on very similar DOAS techniques, they differ from each other in other aspects (influence of sulphur dioxide, different wavelengths and thus different ozone absorption coefficients, and number of measurements per a day). The calibration scales for these instruments defined by the respective world standards are also determined independently and are transferred to field spectrophotometers through differing techniques. Thus, there may be certain differences in real total ozone data produced by these instruments. Around 75 Dobson and 65 Brewer instruments were regularly operated for total ozone measurements in the GAW global network in the period 1995–2004 (<http://www.woudc.org/>). However, only a small number of stations have performed the simultaneous observations with collocated spectrophotometers to allow investigation of the relation between Dobson and Brewer data series. While some studies (Kerr, Asbridge and Evans, 1988; DeMuer and DeBacker, 1992) did not find significant differences, recent analyses of long-term records (Staehelin and others, 1998; Köhler, 1999; Vanicek, Stanek and

Dubrovsky, 2003) have shown a systematic seasonal dependency of differences between collocated well-calibrated spectrophotometers (Dobsons are lower than Brewers) of up to 3–5 per cent in winter months, while in summer the observations usually fit well. The reasons for such differences can be summarized as follows (Kerr, 2002; WMO, 2003):

- (a) Higher temperature dependency of the Dobson differential ozone absorption coefficients;
- (b) Stray light from UV radiation inside the instruments;
- (c) Different field-of-view angles of the spectrophotometers resulting in different influences of the atmospherically scattered UV solar radiation;
- (d) Contribution of sulphur dioxide to Dobson total ozone in polluted area;
- (e) Difference in μ values calculated for high solar zenith angles.

All the above factors are still being investigated by simultaneous observations taken at these stations.

16.4 MEASUREMENTS OF THE VERTICAL PROFILE OF OZONE

16.4.1 Instruments for measuring the vertical profile of ozone

The vertical profile of ozone is measured with ozonesondes, laser-radars (LIDARs), ground-based spectrometers and various satellite-borne instruments. The longest records exist for ozonesondes, which are ozone analysers coupled to radiosondes. The ozonesonde measures the concentration of ozone as a function of height by sampling ambient air during its balloon-borne ascent to an altitude typically between 30 and 35 km. Ozonesondes in routine use are the Brewer-Mast and electrochemical concentration cell (ECC) sondes (Komhyr, 1986), or modified variations of these instruments (Komhyr, 1997). The Japanese stations use their own carbon iodine sonde (KC 96).

Ground-based instruments measure the ozone profile on a routine basis by using remote-sensing techniques. Measurements of solar UV light from the zenith sky during twilight taken by a Dobson or Brewer ozone spectrophotometer are used to determine ozone profiles using the Umkehr inversion method. UV LIDAR systems were developed

in the 1980s and have been in operation at several sites since. Ground-based LIDAR instruments, as well as the microwave instruments, operate from inside a laboratory. Measurements are usually made on the zenith sky through a roof hatch or dome. In some instances, LIDAR takes measurements in other directions by pointing the laser beam and detector. LIDAR instruments must be located in such a way as to avoid interference from other UV sources, and microwave instruments must avoid interference which may come from microwave radio transmitters. The LIDAR technique is usually limited to operating at night when there is not an appreciable amount of cloud cover. A profile measurement is derived from the integration of many laser shots taken over a period of several hours.

16.4.2 Measurement of the vertical profile of ozone

16.4.2.1 Ozonesonde measurements

Ozonesondes, flown with large weather balloons, measure height-resolved profiles of atmospheric ozone from the surface up to the 30–35 km range in the middle stratosphere. They operate regularly in all climatic regions and under severe weather conditions. They have been the backbone of ozone profiling since the 1960s.

All types of wet-chemical in situ sondes are based on the electrochemical oxidation of potassium iodide by ozone in an aqueous solution. The chemical reaction forms two electrons per ozone molecule captured in the solution. The resulting current is a quantitative measure for the number of ozone molecules pumped through the reaction chamber(s). The main components of the sonde are a reaction chamber, where ozone molecules react with the chemical solution (bubbler), an air pump, a power supply, and an electronic interface that converts the raw current signal and transfers it to the radiosonde. To protect the sensitive parts of the instrument from mechanical impact and low temperature, all components are mounted in a styrofoam box. To transfer the ozone signal to the ground receiver, the ozonesonde has to be connected to a suitable meteorological radiosonde.

Principle of operation

The following provides a description of the measurement principle of the Brewer-Mast sonde. It is simpler than the related principle used by the more

recent ENSCI or science pump electrochemical cell (ECC) sensors, which consist of two chambers being separated by a diaphragm (Komhyr, 1986). The ECC sensors have a platinum electrode in each chamber, whereas Brewer-Mast sensors have a platinum cathode and a silver anode, both inside the single reaction chamber.

At the platinum cathode, iodine is oxidized according to:



At the silver wire anode, the silver is oxidized by the iodide:

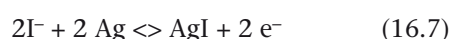

Since AgI is stable, it is bound to the anode and is not available for further reactions.

If a voltage of 410 mV is applied between the platinum mesh and the silver wire, the polarization voltage between the two is compensated. No electrons flow between anode and cathode and iodine and iodide concentration in the cell reach an electrochemical equilibrium. If an ozone molecule enters the solution, it can react with the iodide according to:

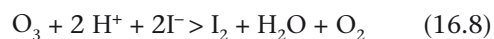

This upsets the equilibrium and two electrons flow until equilibrium is restored. In a complete reaction cycle, two electrons are released per ozone molecule. The resulting current provides an absolute measure of the amount of ozone reacting in the bubbler per unit time.

N ozone molecules give a charge $Q = N \cdot 2 \cdot e$. Using the ideal gas law ($p \cdot V = N \cdot k \cdot T$, where p is the ozone partial pressure, V the volume, N the number of ozone molecules, k the Boltzmann constant and T the absolute temperature, all of a given air-volume), it follows that:

$$p \cdot V = Q \cdot k \cdot T / (2 \cdot e) \quad (16.9)$$

or, as $Q = i \cdot t$, where i is the measured current and t the time:

$$p = i \cdot k \cdot T / (2 \cdot e) \cdot t / V \quad (16.10)$$

or:

$$p = 4.31 \cdot 10^{-3} i \cdot T \cdot t / V \quad (16.11)$$

where p is the ozone partial pressure (in millipascal), i is the measured current (in μA), T is the pump temperature (in K), and V/t is the air volume V pumped through the cell in time t (in 100 ml s^{-1}).

Atmospheric ozone concentrations lead to a current typically of the order of a few microamps. The ozonesonde interface converts the current to a signal that is passed to the radiosonde. The radiosonde transfers the ozone signal, along with meteorological parameters, to the ground station, where all signals are decoded and recorded.

Compared with a Dobson or a LIDAR, the ozonesondes have individual characteristics. Despite a thorough pre-launch laboratory check, they may deteriorate during flight and give poor readings. Also, long-term stability over many individual sondes is nearly impossible to maintain. Therefore it is strongly recommended that each sounding should be normalized. This is accomplished by calibrating the vertically integrated sounding profile with a closely coincident total ozone measurement. The ratio between measured total ozone and vertically integrated ozone from the sonde gives the correction factor. This factor must be applied to each value of the ozone profile. However, the primary sounding profile should exceed the 17 hPa pressure height without large gaps. For a good approximation, additional assumptions are necessary, e.g. a constant mixing ratio above the top of the measured profile.

16.4.2.2 Umkehr measurements

The vertical profile of ozone is measured remotely from the ground by using the Umkehr technique. The basis for this method is the dependence on the vertical distribution of the ozone of the differential absorption of solar UV light at two wavelengths passing through atmospheric ozone and scattered to the Earth's surface from the zenith sky. This dependence is enhanced as the sun nears the horizon. The ratio of zenith clear-sky radiation at two UV wavelengths is measured for solar zenith angles between 60° and 90° . The log of the ratio is plotted as a function of zenith angle; the slope of this curve changes sign at a particular zenith angle. This curve is called an Umkehr curve (from the German word meaning "turn around").

The standard Umkehr technique was developed (Götz, Meetham and Dobson, 1934; Dütch, 1957; Dobson, 1957; Mateer, 1964; Mateer and DeLuisi,

1992) and put in operation to analyse measurements taken by the Dobson spectrophotometer. Since the 1992 update, the UMK92 version has been used in operational processing of Umkehr data at the World Ozone and Ultraviolet Data Centre (WOUDC), in Toronto, Canada. In Umkehr retrieval, zenith blue-sky measurements at several solar zenith angles between 60° and 90° are compared with results from a multiple-scattering radiation model (“forward model”). It is assumed that the vertical ozone profile is uniform in the horizontal and remains constant for the duration of the measurement period. A representative total ozone measurement is required as part of the data input. The analysis is based on a climatological first guess, and an iterative solution is reached. The resulting profile is reported as mean partial pressure values for the following nine pressure layers:

<i>Layer number</i>	<i>Pressure range (hPa)</i>
1	500–250
2	250–125
3	125–62.5
4	62.5–31.2
5	31.2–15.6
6	15.6–7.8
7	7.8–3.9
8	3.9–1.96
9	1.96–0.98

The update to the UMK92 algorithm made by the REVUE group (Bojkov and others, 2002) included revised a priori profiles based on the new ozone climatology (McPeters, Logan and Labow, 2003) and updates to the forward model. The consequent work by Petropavlovskikh, Bhartia and McElroy (2004) allowed for further optimization of the Umkehr retrieval for trend analysis (UMK04). A key change is in the construction of the a priori profile. In the UMK92 algorithm, the a priori profiles are constructed using total ozone column measured by the same instrument. Therefore, UMK92 has the undesirable property that the a priori profiles vary with day and year. These variations make it difficult to ascertain whether the retrieved long-term changes are forced by a priori profiles or whether they reflect information contained in the measurements. Both the REVUE and the UMK04 algorithms use fixed a priori profiles, which vary with season and latitude but have no day-to-day or long-term variability. The new updated algorithm (UMK04) has an improved forward model. The inverse model is optimized to minimize a priori dependence in the retrieval. The

informational content of Umkehr measurements is analysed using the “averaging kernel (AK)” method developed by C.D. Rodgers. Based on AK analysis of the informational content available from the UMK04 algorithm, an eight-layer scheme is recommended, where ozone is combined in layers zero and one, and layers two and three to represent tropospheric and lower stratospheric changes, respectively. It was found that ozone information in layer four has similar informational content to ozone in layers five through to eight. Thus, layers four through to eight should be treated as individual layers containing prevalently independent stratospheric ozone information. Layer nine and above have no independent information but could be combined with layer eight to obtain an accurate ozone column above 4 hPa; this estimate is important for comparing satellite and ground-based ozone retrievals. Although this technique is too noisy to monitor short-term variability in atmospheric ozone, it is most capable of monitoring long-term changes in monthly mean ozone in seven or eight layers with reasonably uncorrelated errors and with minimal influence from a priori information.

The short Umkehr technique was developed by DeLuisi, Mateer and Bhartia (1985) for the Dobson and applied to Brewer instruments (McElroy, Hahn and Hare, 1998), and is in operation at some sites. The short Umkehr is of similar accuracy to the standard Umkehr and has several operational advantages because the required range of solar zenith angles is reduced to between 80° and 90°. Since the measurement period is significantly shorter, the probability of obtaining a cloud-free observation period is increased. The observing season is also extended for high latitudes because there are more days in the year when the sun rises to a 10° elevation. Also, the effects of ozone changes are not as likely for the shorter observation period. A measurement of total ozone is still required as data input.

16.4.2.3 LIDAR measurements

Ground-based measurements of the ozone profile are made with a LIDAR (optical radar) system. A short laser pulse at a wavelength in the UV ozone absorption spectrum is emitted toward the zenith. Backscattered radiance is measured as a function of time after the pulse emission. The time of arrival gives the scattering height, and the variation of the radiance as a function of time gives a measurement of the amount of ozone absorption. At least two wavelengths are used: one is absorbed by ozone, the

other is not and serves as a reference. Comparison of the return signals from the top and bottom of an atmospheric layer, and between the two wavelengths, allows the determination of the ozone absorption within the layer, and thus the amount of ozone in the layer. A big advantage of this double-differential measurement technique (differential in altitude and wavelength) is that it is self-calibrating. Instrumental parameters cancel out in the equations. The only external information needed is the ozone absorption cross-section at the two wavelengths.

The ozone measurement is contaminated at certain times and altitudes with substantially enhanced aerosol, e.g. after major volcanic eruptions. However, this can largely be circumvented by using return signals that are shifted in wavelength by vibrational Raman scattering from nitrogen, instead of the usual elastic Rayleigh scattered returns. The LIDAR technique is limited to operating at night when there is not an appreciable amount of cloud cover. A profile measurement is derived from the integration of many laser shots taken over a period of about 4 h.

16.4.2.4 Microwave measurements

The altitude distribution of ozone can be determined by ground-based microwave radiometry. This passive technique observes pressure-broadened rotational transition lines from atmospheric molecules with a permanent dipole moment. The emitted signal lies in the microwave region and is not affected by clouds; this allows observations during almost all weather conditions. Typical transition lines used to monitor ozone are located at 110.836 GHz and 142.175 GHz, although there are many more transitions available (Parrish and others, 1992). In order to retrieve an altitude profile, a spectral analysis of the detected signal is necessary. This is achieved by using a variety of spectrometers such as acousto-optical or chirp transform spectrometers, autocorrelators or filter banks and, most recently, with digital Fourier transform spectrometers. By combining information from the measured spectra and some a priori information on the atmospheric state in an optimal way (Rodgers, 1976; 1990), it is possible to retrieve an altitude profile of ozone in the range of approximately between 20 and 80 km in altitude. Depending on instrument sensitivity, profiles can be retrieved with a time resolution of the order of minutes. This time resolution allows investigation of diurnal variations of ozone e.g. in the mesosphere (Zommerfelds and others, 1989; Connor and others, 1994).

Microwave instruments are operated worldwide by a number of groups, and several of them contribute data to the Network for the Detection of Atmospheric Composition Change (NDACC) (see <http://www.ndacc.org>). Observations on a regular basis within the NDACC are performed at Bern and Payerne (Switzerland), Spitsbergen (Norway), Mauna Loa (Hawaii) and at Lauder (New Zealand).

16.4.2.5 Other measurement techniques

A number of other techniques have been used to measure the vertical ozone profile. Some of these new methods are starting to provide data on a routine basis. Instruments are located on the ground, balloons, rockets or satellites. These methods include the following:

- (a) In situ UV absorption photometry;
- (b) Differential UV solar absorption;
- (c) Infrared thermal emission;
- (d) Microwave thermal emission;
- (e) Infrared absorption.

The in situ UV absorption photometer normally used to measure surface ozone has been modified to measure ozone from a balloon platform. Ozone concentration is measured as a function of altitude as the instrument ascends (or descends) through the atmosphere.

The differential UV solar absorption technique measures total ozone from an ascending platform (balloon or rocket) as a function of altitude. The ozone profile is determined from the differential of the total ozone versus altitude curve.

Infrared and microwave radiation, which are thermally emitted by ozone, are measured from a balloon or satellite instrument scanning the Earth's limb. The radiance signal as a function of viewing angle can be inverted to give the vertical distribution of ozone.

Infrared absorption measurements are taken of solar radiation during sunrise or sunset from a balloon platform. The vertical profile of ozone is determined by inverting the signal as a function of tangential path through the atmospheric layers below the balloon.

16.4.3 Errors in measuring the vertical profile of ozone

There are a number of error sources for the ozonesonde measurement of ozone profile. The potassium iodide solution could contain

Table 16.2. Errors in the values for ozone retrieved in eight independent layers using a Dobson instrument and the Umkehr technique

<i>Layer number</i>	8+	8	7	6	5	4	2+3	1+0
Smoothing error %	10.3	5.7	6.2	6.5	6.5	10.5	15.6	22.6
Measurement error %	6.0	4.1	3.2	4.3	2.9	2.9	1.8	6.8
Total error %	11.9	7.0	6.9	7.8	7.1	10.9	15.7	23.6

contaminants which would affect the sensitivity of the sonde to ozone. An error in the measurement of the flow rate of air generated by the pump would result in a systematic error in the measurement of ozone at all levels. It is also possible that pumping efficiency may change during flight.

The absolute accuracy of the integrated profile (total ozone) for an ozonesonde profile is given by the absolute accuracy of the ground-based total ozone measurement because the integrated profile is normalized to a total ozone measurement. The uncertainty is estimated to be between 3 and 5 per cent. The uncertainty of a measurement at a particular height in the atmosphere varies as a function of altitude. In general, the uncertainty for the measurement is estimated to be 10 per cent in the troposphere and 5 per cent in the stratosphere below 10 hPa. Above 10 hPa, increasing uncertainties in pump efficiency and flow rate cause the estimated error to increase to 15 per cent at 5 hPa.

There are several error sources for the Umkehr inversion technique. Errors result when the horizontal distribution of ozone is not uniform, or when changes occur either in total ozone or in the vertical distribution of ozone during the measurement period. The Umkehr measurement is affected by stratospheric aerosols which are present following volcanic activity. The errors in ozone profile depend on optical depth and elevation of aerosol load. An error in the a priori first-guess profile causes a bias in the final inversion. The retrieval errors (see Table 16.2 below) are caused by smoothing of small-scale variability in the profile (the first row in the table) and by interference from the measurement noise (the second row in the table). The variance in the measurement noise is assumed to increase with the solar zenith angle between 0.3 and 1.6 N-values (based on analysis of coincidental data taken by two Dobson instruments at the Arosa station over several years). The overall uncertainty of the Umkehr method (the bottom row in the table) is estimated to be 25 per cent for the troposphere (layers zero and one), 15 per cent for

the low stratosphere (layers three and two), less than ± 10 per cent for the middle stratosphere (layers four to six), less than 10 per cent for the upper stratosphere (layers seven to eight), and errors increase in ozone integrated in layer eight and above.

For LIDAR measurements under background aerosol conditions, the uncertainty of the ozone profile measurement is estimated to be 3 per cent, which is largely determined by the uncertainty in the absolute values of the ozone absorption coefficient. For enhanced stratospheric aerosol, and without the use of Raman channels, ozone values may be wrong by more than 100 per cent at the altitudes of enhanced aerosol. However, for normal conditions, the statistical random error is the largest source of uncertainty. It is typically 2 per cent for heights of up to 30 km and increases to 18 per cent at 45 km.

In contrast to other techniques, microwave radiometry has a relatively poor altitude resolution of the order of 8 to 15 km (half-width of averaging kernels), depending on altitude (Connor and others, 1995). The random error is of the order of 3 to 10 per cent of the retrieved ozone values, depending on altitude. The contribution of the a priori information is less than 20 per cent in the range from approximately 20 to 55 km, but increases outside these limits.

16.4.4 **Comparison, calibration and maintenance of instruments for measuring the vertical profile of ozone**

The procedures for spectrophotometers and ozonemeters are covered in section 16.3.5. Ozonesondes are disposable instruments which are usually flown only once unless they are recovered and refurbished. There is no requirement to maintain calibration standards for an individual sonde over a long period of time; neither is there a standard ozonesonde to calibrate others. There are standard procedures to be followed to prepare individual ozonesondes for launch. Detailed

preparation procedures are given in Komhyr (1986) for the ECC sonde and in WMO (1992) for the Brewer-Mast sonde. Some investigations were carried out on the differences between ENSCI and Science Pump-ozonesondes, also taking into account air pump performance and different concentrations of the reaction solution. Details can be found in WMO (2004*a*) and Johnson and others (2002). Standard operating procedures for both types of ECC sondes are still in preparation.

Ground-based microwave observations of ozone have been thoroughly validated against other microwave instruments and other techniques such as LIDAR or satellite data (Tsou and others, 1995; Schneider and others, 2003). Investigations into the possibility of complementing ozone profiles from balloon soundings with microwave data have also been performed (Calisesi and others, 2003).

16.5 CORRECTIONS TO OZONE MEASUREMENTS

Total ozone data (direct sun, direct moon and zenith sky) and vertical distribution of ozone (Umkehr, ozonesonde and LIDAR) measured at stations in the GAW network are submitted to the WOUDC in Toronto (Canada), where the data are archived and made accessible to users on the WOUDC website at <http://www.woudc.org>. Yearly summaries of data are also available in the publication *Ozone Data for the World* (CD-ROM only). The WOUDC is operated by Environment Canada in cooperation with WMO. Other important sources of ozone data are the Norwegian Institute for Air research database (<http://www.nilu.no/nadir>), which has a focus on rapid data acquisition and dissemination for campaigns, and the NDACC website (<http://www.ndacc.org>). Measurements of surface ozone are submitted to the WMO World Data Centre for Greenhouse Gases (WDCGG), hosted by the Japan Meteorological Agency, where the data are available either through the website (<http://gaw.kishou.go.jp/wdcgg.html>) or on CD-ROM. Both WOUDC and WDCGG also collect metadata on the observations and ozone data saved in the data centres.

The instrumental characteristics which affect an ozone measurement (such as calibration constants, temperature response and settings of

instruments for local geographical and climate conditions) are generally corrected either during the observation procedure or when determining ozone values from the instrument readings. In some situations, the direct sun measurement of total ozone is corrected for spectral characteristics of an instrument in order to extend the range of measurements to air mass values greater than 3.2 (effects of spectral features of the spectrophotometer are usually negligible for an air mass of less than 3.2). This would occur mainly at high latitudes during winter. The corrections are empirical and based on data from days when the measurement from large air mass values (up to 5–6) may be compared with those measurements made at smaller values. It should be mentioned that the Dobson “focused sun” observations or measurements of total ozone with the new Brewer MK-III (double monochromator instrument) can be taken even up to $\mu = 6$.

Umkehr measurements are submitted to the WOUDC, where they are processed to yield vertical distributions of ozone, which are then published together with the raw data. All other types of data are processed at the station and the resulting total ozone or ozone concentration values are submitted.

Ozonesonde measurements of the vertical profile of ozone are corrected by normalizing the integrated profile to a ground-based measurement of total ozone. Assumptions must be made regarding the amount of ozone in the atmosphere above the measured profile. If a total ozone measurement is not available, the correction factor is assumed to be 1.0.

Individual stations are responsible for ensuring that their data are correct. Questionable data are flagged by the WOUDC so that a station can check and correct the data, if necessary. The Umkehr data processed at the WOUDC must pass a quality-control process to be published. A station may correct previous data by resubmitting the data for publication at a later date. The requirement to correct earlier reported data is usually based on new information regarding an instrumental constant, or the discovery of an error, or an improvement in the data-reduction process. Corrected data are published in the same format but are usually identified with a “corrected” comment. Corrected data are also identified in the annual catalogue which summarizes all submitted data.

16.6 AIRCRAFT AND SATELLITE OBSERVATIONS

Ozone in the atmosphere is also measured by instruments located on board aircraft and space satellites. The airborne observations are usually made by in situ photometers sampling the air in the troposphere and lower stratosphere during a flight. The measurements are mostly used in research campaigns on atmospheric chemistry, e.g. the MOZAIC, CARIBIC or SCOUT projects.

Large-scale monitoring of atmospheric ozone is performed by remote-sensing instruments from satellites. These programmes can be divided according to lifetime into the long-term operational monitoring systems that generate large (global) data sets used both for trend analyses and for operational mapping of ozone, and into temporary experimental missions.

Satellite instruments can be grouped according to the radiation-detection technology to be used for the determination of ozone by DOAS techniques. One group contains nadir-viewing instruments that scan scattered UV radiation to specifically derive total ozone. Instruments of another group measure vertical profiles of ozone by solar, lunar or stellar occultation in different parts of the spectrum, or by scanning microwave thermal emissions through the atmospheric limb (WMO, 1998).

Since 1978, when the first ozone space observations started with the Total Ozone Mapping Spectrometer instrument (Heath, Krueger and Park, 1978), much progress has been achieved in monitoring ozone from space. About a dozen long-life and experimental satellite instruments have been launched since that time and several others are scheduled for the coming decade. Also, the technologies and parameters of these space-borne systems have been improved with respect to vertical and horizontal resolution, spectral resolution, algorithms for processing the observations and the number of atmospheric species monitored.

Satellite monitoring of ozone is closely related to ground-based observations, mainly for the validation of space-borne observations and for the large-scale assimilation of operational ozone measurements into numerical ozone mapping and prediction models. Building up and integrating ground and satellite ozone monitoring systems is a strategic task of WMO, space agencies and other related scientific groups represented by the Committee on Earth Observation Satellites. The design of the system and a summary of recent, current and forthcoming satellite ozone monitoring missions can be found in WMO (2001*b*) and are updated in WMO (2004*b*). The best descriptions of the ongoing and planned satellite ozone monitoring projects are available at their temporary websites.

ANNEX 16.A

UNITS FOR TOTAL AND LOCAL OZONE

Dobson unit	1 DU	= 1 milliatmosphere centimetre (1 m-atm-cm) = 10^{-5} m of ozone at standard temperature and pressure (STP) = $2.141\ 4\ \text{mg cm}^{-1}$ = $2.687 \cdot 10^{16}$ molecules cm^{-2}
-------------	------	---

TABLE 16.A.1. Quantities specifying local ozone, units of the International System of Units and vertical integration

Quantity by	Density		Concentration relative to local air (mixing ratio)		Partial pressure	
	Number density	Density	Relative to STP (differentiated total)	By mass		By volume
	m^{-3}	kg m^{-3}	/[STP]	/		/
	n	ρ	s	m	v	P
Number density	////	$n \cdot \frac{\rho^0 M}{L}$	$n \cdot \frac{1}{L}$	$n \cdot \frac{M}{L} \cdot \frac{T^*}{P^*}$	$n \cdot \frac{1}{L} \cdot \frac{T^*}{P^*}$	$n \cdot \frac{P^0}{L} \cdot T^*$
Density	$\rho \cdot \frac{L}{\rho^0 M}$	////	$\rho \cdot \frac{1}{\rho^0 M}$	$\rho \cdot \frac{1}{\rho^0} \cdot \frac{T^*}{P^*}$	$\rho \cdot \frac{1}{\rho^0 M} \cdot \frac{T^*}{P^*}$	$\rho \cdot \frac{P^0}{\rho^0 M} \cdot T^*$
Density relative to STP	$s \cdot L$	$s \cdot \rho^0 M$	////	$s \cdot M \cdot \frac{T^*}{P^*}$	$s \cdot \frac{T^*}{P^*}$	$s \cdot P^0 \cdot T^*$
Mixing ratio by mass	$m \cdot \frac{L}{M} \cdot \frac{P}{T^*}$	$m \cdot \rho^0 \cdot \frac{P^*}{T^*}$	$m \cdot \frac{1}{M} \cdot \frac{P^*}{T^*}$	////	$m \cdot \frac{1}{M}$	$m \cdot \frac{P^0}{M} \cdot P^*$
Mixing ratio by volume	$v \cdot L \cdot \frac{P^*}{T^*}$	$v \cdot \rho^0 M \cdot \frac{P^*}{T^*}$	$v \cdot \frac{P^*}{T^*}$	$v \cdot M$	////	$v \cdot P^0 \cdot P^*$
Partial pressure	$p \cdot \frac{L}{P^0} \cdot \frac{1}{T^*}$	$p \cdot \frac{\rho^0 M}{P^0} \cdot \frac{1}{T^*}$	$p \cdot \frac{1}{P^0} \cdot \frac{1}{T^*}$	$p \cdot \frac{M}{P^0} \cdot \frac{1}{P^*}$	$p \cdot \frac{1}{P^0} \cdot \frac{1}{P^*}$	////
Typical concentration at 25 km	$4.97 \cdot 10^{18}$	$3.96 \cdot 10^{-7}$	$1.85 \cdot 10^{-7}$	$10 \cdot 10^{-6}$	$6.03 \cdot 10^{-6}$	$1.51 \cdot 10^{-2}$
Vertical integration (z in metres)	$\int n \cdot dz = L \cdot x$	$\int \rho \cdot dz = \rho^0 M \cdot x$	$\int s \cdot dz = x$	$\int m \cdot dP = -Mg \cdot x$	$\int v \cdot dP = -g \cdot x$	$\int p \cdot d(\ln P) = -g \cdot x$

$P^* = P/P_0$, $T^* = T/T_0$	Normalized local temperature and pressure	
P_0 , T_0	STP	$1.013\,25 \cdot 10^5$ Pa, 273.15 K
ρ_0	Density of air at STP	1.293 kg m ⁻³
L	Loschmidt number	$2.687 \cdot 10^{25}$ m ⁻³
g	Gravity acceleration	9.807 m s ⁻²
M	Molecular ratio: ozone/air	1.657
x	Total ozone	unit m (at STP)
P , T	Local air pressure, temperature	units Pa, K

TABLE 16.A.2. Commonly used units for local ozone and their conversion

Unit	Density			Mixing ratios		Pressure
	(10^{11} mol cm ⁻³)	(μ g m ⁻³)	(DU km ⁻¹)	(μ g g ⁻¹) (ppmv)		(hPa)
10^{11} mol cm ⁻³ [10^{17} mol m ⁻³]	—	7.97	0.371	$0.022\,9 \frac{T}{P}$	$0.013\,8 \frac{T}{P}$	$0.013\,8 T$
1μ g m ⁻³ [10^{-9} kg m ⁻³]	0.125	—	0.046 7	$0.002\,87 \frac{T}{P}$	$0.001\,73 \frac{T}{P}$	$0.001\,73 T$
1 DU km ⁻¹	2.69	21.4	—	$0.061\,4 \frac{T}{P}$	$0.037\,0 \frac{T}{P}$	$0.037\,0 T$
1μ g g ⁻¹ [10^{-6} by mass]	$43.7 \frac{P}{T}$	$348 \frac{P}{T}$	$16.3 \frac{P}{T}$	—	0.603	$0.603 P$
1 ppmv [10^{-6} by volume]	$72.4 \frac{P}{T}$	$578 \frac{P}{T}$	$27.0 \frac{P}{T}$	1.657	—	P
1 hPa [10^{-4} Pa]	$72.4 \frac{1}{T}$	$578 \frac{1}{T}$	$27.0 \frac{1}{T}$	$1.657 \frac{1}{T}$	$\frac{1}{P}$	—

Note:

Pressure (P) in hectopascal.

Temperature (T) in kelvin.

Numbers in square brackets give the equivalent value according to the International System of Units.

ANNEX 16.B MEASUREMENT THEORY

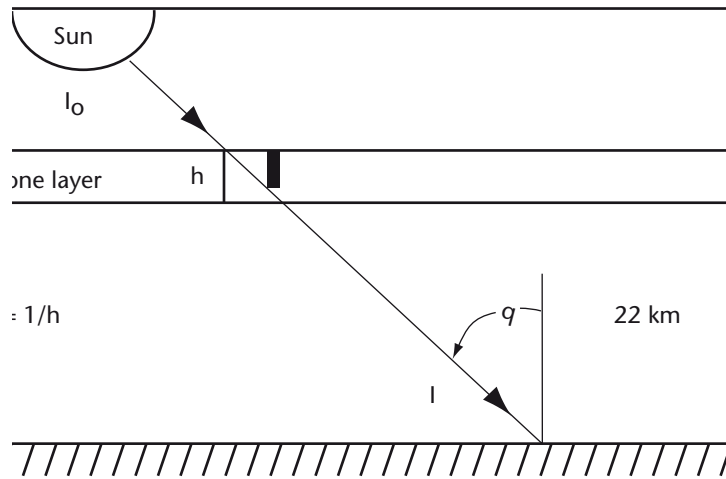

Total ozone by spectrophotometer

The geometry for the path of sunlight passing through the ozone layer in the Earth's atmosphere is illustrated in the figure above. The solar irradiance (I_λ) at wavelength λ measured at the Earth's surface is given by the following:

$$\log(I_\lambda) = \log(I_{0\lambda}) - \alpha_\lambda X \mu - \alpha'_\lambda X' \mu' - \beta_\lambda m - \delta_\lambda \sec(\theta) \quad (16.B.1)$$

where: I_0 is the irradiance outside the Earth's atmosphere (extra-terrestrial value) at wavelength λ ;

α_λ is the ozone absorption coefficient at wavelength λ (nm);

X is the total amount of column ozone in the atmosphere (m at STP);

μ is the ratio of the slant path of the beam through the ozone layer to the vertical path — the optical air mass of the ozone layer;

α'_λ is the sulphur dioxide absorption coefficient at wavelength λ (nm);

X' is the total column amount of sulphur dioxide in the atmosphere (m at STP);

μ' is the ratio of the slant path of the beam through the sulphur dioxide layer to the vertical path — the optical air mass of the sulphur dioxide layer;

β_λ is the Rayleigh molecular scattering coefficient of the air at wavelength λ ;

m is the ratio of the slant path of the beam through the whole atmosphere to the vertical path — the optical air mass of the whole atmosphere;

δ_λ is the particulate aerosol scattering coefficient at wavelength λ ;

θ is the apparent solar zenith angle.

In practice, an accurate measurement of ozone cannot be made by measuring the irradiance at one wavelength because it is difficult to maintain the absolute sensitivity of an instrument over a long period. Also, particulate scattering due to aerosols and thin clouds significantly affects the amount of transmitted irradiance.

It is therefore necessary to measure the irradiances at more than one wavelength and to determine total ozone by techniques of differential optical

absorption spectroscopy (DOAS). Measurements of irradiances made at N wavelengths are expressed by N equations of the form given in equation 16.B.1 with different values for $I_{0\lambda}$, α_λ , α'_λ , β_λ and δ_λ . These N equations may be linearly combined to give the following:

$$\sum w_\lambda \log(I_\lambda) = \sum w_\lambda \log(I_{0\lambda}) - (\sum w_\lambda \alpha_\lambda) X_\mu - (\sum w_\lambda \alpha'_\lambda) X'_\mu - (\sum w_\lambda \beta_\lambda) m - (\sum w_\lambda \delta_\lambda) \sec(\theta) \quad (16.B.2)$$

where Σ represents the summation from 1 to N and w_λ is a set of N weighting values, one for each wavelength.

The weighting values at each wavelength (w_λ) are selected to minimize the effects of other atmospheric constituents, mainly aerosols. Weighting values for the Dobson AD measurement reduce the effects of haze. The effect of sulphur dioxide on the Dobson ozone measurement is ignored, although the presence of sulphur dioxide adds about 1 per cent false ozone for some stations. The weighting values for the Brewer total ozone measurement minimize the effects caused by aerosols and sulphur dioxide. The wavelengths for the Dobson AD and Brewer standard measurements with the appropriate values of w_λ are given in the following table.

If the effects of sulphur dioxide and haze are neglected, equation 16.B.2 can be rewritten in the following form:

$$F + \beta m = F_0 - \alpha X \mu \quad (16.B.3)$$

where: $F = \sum w_\lambda \log(I_\lambda)$
 $F_0 = \sum w_\lambda \log(I_{0\lambda})$
 $\beta = \sum w_\lambda \beta_\lambda$
 $\alpha = \sum w_\lambda \alpha_\lambda$

It follows from equation 16.B.3 that the value for total ozone is given by the following:

$$X = \frac{(F_0 - F - \beta m)}{\alpha \mu} \quad (16.B.4)$$

Here, the term F is measured, F_0 is a calibration constant which is equal to the value of F outside the Earth's atmosphere (the extra-terrestrial constant for the instrument), and βm and $\alpha \mu$ are values which are calculated.

In order to determine the amount of total ozone, it is necessary to know F_0 , a value which is unique for each instrument. This constant is determined for most field instruments by direct intercomparison with the primary standard or secondary reference instruments (see section 16.3.5.1).

Wavelengths and the effective weighting values used for Dobson and Brewer standard ozone measurement

DOBSON AD MEASUREMENT		BREWER STANDARD MEASUREMENT	
Wavelength (λ) (nm)	Weighting value (w_λ)	Wavelength (λ) (nm)	Weighting value (w_λ)
305.5	1.0	310.1	1.0
	A pair		
325.4	-1.0	313.5	-0.5
317.6	-1.0	316.8	-2.2
	D pair		
339.8	1.0	320.0	1.7

REFERENCES AND FURTHER READING

- Asbridge A.I., K. Vanicek and M. Stanek, 1998: Application of Dobson zenith polynomials for different instruments, locations and seasons. *Proceedings of the Quadrennial Ozone Symposium* (R.D. Bojkov and G. Visconti, eds.) (L'Aquila, Italy, 12–21 September 1996), pp. 979–982.
- Attmannspacher, W. and R. Hartmannsgruber, 1982: Intercomparison of instruments measuring ozone near the ground at Hohenpeissenberg Observatory, 1 October 1978–30 April 1979. *Berichte des Deutschen Wetterdienstes*, No. 161, Offenbach am Main.
- Bass, A.M. and R.J. Paur, 1985: The ultraviolet cross-sections of ozone: I. The measurements, II: Results and temperature dependence. *Atmospheric Ozone* (C.S. Zerefos and A. Ghazi, eds), Reidel, Dordrecht, pp. 606–616.
- Bojkov, R.D., Fioletov, V.E. and A.M. Shalamjansky, 1994: Total ozone changes over Eurasia since 1973 based on reevaluated filter ozonometer data. *Journal of Geophysical Research*, 99, pp. 22985–22999.
- Bojkov, R.D., E. Kosmidis, J.J. Deluise, I. Petropavloskikh, V.E. Fioletov, S. Godin and C. Zerefos, 2002: Vertical ozone distribution characteristics deduced from 44 000 re-evaluated Umkehr profiles (1957–2000). *Meteorology and Atmospheric Physics*, 79, Issue 3–4, pp. 127–158.
- Brion, J.A., A. Chakir, D. Daumont, J. Malicet and C. Parisse, 1993: High-resolution laboratory absorption cross-section of O₃: Temperature effect. *Chemical Physics Letters*, 213, pp. 610–612.
- Burrows, J.P., A. Richter, A. Dehn, B. Deters, S. Himmelmann, S. Voigt and J. Orphal, 1999: Atmospheric remote-sensing reference data from GOME: 2. Temperature-dependent absorption cross sections of O₃ in the 231–794 nm range. *Journal of Quantitative Spectroscopy and Radiative Transfer*, 61, pp. 509–517.
- Calisesi, Y., R. Stübi, N. Kämpfer and P. Viatte, 2003: Investigation of systematic uncertainties in Brewer-Mast ozone soundings using observations from a ground based microwave radiometer. *Journal of Atmospheric and Oceanic Technology*, Vol. 20, No. 11, pp. 1543–1551.
- Connor, B.J., D.E. Siskind, J.J. Tsou, A. Parrish and E.E. Remsburg, 1994: Ground-based microwave observations of ozone in the upper stratosphere and mesosphere. *Journal of Geophysical Research*, 99, pp. 16757–16770.
- Connor, B.J., A. Parrish, J.J. Tsou and M.P. McCormick, 1995: Error analysis for the ground-based microwave ozone measurements during STOIC. *Journal of Geophysical Research*, 100, pp. 9283–9291.
- DeBacker, H., 1998: Zenith observations of total ozone in Uccle. *Scientific Publication No. 006*, Royal Meteorological Institute of Belgium, Brussels.
- DeLuisi, J.J., C.L. Mateer and P.K. Bhartia, 1985: On the correspondence between standard Umkehr, short Umkehr, and solar backscattered ultraviolet vertical ozone profiles. *Journal of Geophysical Research*, 90, pp. 3845–3849.
- DeMuer, D. and H. DeBacker, 1992: Revision of 20 years of Dobson total ozone data at Uccle (Belgium): Fictitious Dobson total ozone trends induced by sulfur dioxide trends. *Journal of Geophysical Research*, 97, pp. 5921–5937.
- Dobson, G.M.B., 1930: Observations of the amount of ozone in the Earth's atmosphere and its relation to other geophysical conditions. Part IV, *Proceedings of the Royal Society of London*, A129, pp. 411–433.
- Dobson, G.M.B., 1957: Observer's handbook for the ozone spectrophotometer. *Annals of the International Geophysical Year*, 5, pp. 46–89.
- Dütsch, H.U., 1957: Evaluation of the Umkehr effect by means of a digital electronic computer. *Ozone and General Circulation in the Stratosphere*, Scientific Report No. 1, Arosa, Lichtklimatisches Observatorium.
- Dütsch, H.U., 1959: Vertical ozone distribution from Umkehr observations. *Archives for Meteorology, Geophysics and Bioclimatology*, A11, pp. 240–251.
- Evans, R.D., G. Carbaugh, B. Walsh, S. Oltmans, D. Quincy, M. O'Neil, M. Clark and V. Köhler, 2004a: Results of international Dobson spectrophotometer intercalibrations held since 2000. In: *Proceedings of the Quadrennial Ozone Symposium* (C.S. Zerefos, ed.), University of Athens, pp. 532–533.
- Evans, R.D., G.L. Carbaugh, S.J. Oltmans, B. Walsh, D.M. Quincy, M. O'Neil and M. Clark, 2004b: Dobson calibration scales and application to network instruments. *Proceedings of the Quadrennial Ozone Symposium* (C.S. Zerefos, ed.), University of Athens, pp. 534–535.
- Feister, U., 1991: Field performance of a Brewer spectrometer and filter ozonometer M-124 as compared to a Dobson spectrophotometer. *Zeitschrift für Meteorologie*, 4, pp. 291–305.

- Fioletov, V.E., E.W. Hare and E.J. Carty, 2004: Recent advancements and developments at the WOUDC. *Proceedings of the Quadrennial Ozone Symposium* (C.S. Zerefos, ed), University of Athens, pp. 536–537.
- Götz, F.W.P., A.R. Meetham, and G.M.B. Dobson, 1934: The vertical distribution of ozone in the atmosphere. *Proceedings of the Royal Society of London*, A145, pp. 416–446.
- Gushchin, G.P., S.A. Sokolenko and V.A. Kovalyev, 1985: Total-ozone measuring instruments at the USSR station network. *Atmospheric Ozone* (C.S. Zerefos and A. Ghazi, eds), Reidel, Dordrecht, pp. 543–546.
- Heath, D.F., A.J. Krueger and H. Park, 1978: The solar backscatter ultraviolet (SBUV) and total ozone mapping spectrometer (TOMS) experiment. In: C.R. Madrid, *The NIMBUS-7 User's Guide*. NASA Goddard Space Flight Center, Greenbelt, Maryland, pp. 175–211.
- International Association of Meteorology and Atmospheric Physics (IAMAP), 1967: *Resolution of the International Ozone Commission of the International Association for Meteorology and Atmospheric Physics*. Fourteenth General Assembly of IAMAP, Lucerne, 4 October 1967.
- Johnson, B.J., S.J. Oltmans, H. Vömel, H.G.J. Smit, T. Deshler and C. Kröger, 2002: Electrochemical concentration cell (ECC) ozonesonde pump efficiency measurements and tests on the sensitivity to ozone of buffered and unbuffered ECC sensor cathode solutions. *Journal of Geophysical Research*, 107, D19 doi: 10.1029/2001JD000557.
- Kerr, J.B., C.T. McElroy and R.A. Olafson, 1981: Measurements of ozone with the Brewer ozone spectrophotometer. *Proceedings of the Quadrennial Ozone Symposium* (J. London, ed.) (Boulder, Colorado, August 1980), pp. 74–79.
- Kerr, J.B., I.A. Asbridge and W.F.J. Evans, 1988: Intercomparison of total ozone measured by the Brewer and Dobson spectrophotometers at Toronto. *Journal of Geophysical Research*, 93, pp. 11129–11140.
- Kerr, J.B., C.T. McElroy and D.I. Wardle, 1998: The Brewer instrument calibration center 1984–1996. *Proceedings of the XVIII Quadriennial Ozone Symposium* (R.D. Bojkov and G. Visconti, eds), pp. 915–918.
- Kerr, J.B., 2002: New methodology for deriving total ozone and other atmospheric variables from Brewer spectrophotometer direct sun spectra. *Journal of Geophysical Research*, 107(D23), 4731, doi: 10.1029/2001JD001227.
- Klausen, J.C. Zelleweger, B. Buchmann and P. Hofer, 2003: Uncertainty and bias of surface ozone measurements at selected Global Atmosphere Watch sites. *Journal of Geophysical Research*, 108 (D19), 4622, doi: 10.1029/2003JD003710.
- Köhler, U., 1999: A comparison of the new filter ozonometer MICROTOPS II with Dobson and Brewer spectrophotometers at Hohenpeissenberg. *Geophysical Research Letters*, 26, pp. 1385–1388.
- Köhler U., H. Claude, K. Vanicek, M. Stanek and R. Evans, 2004: The Dobson instrument – still a backbone of ozone monitoring? *Proceedings of the Quadrennial Ozone Symposium* (C.S. Zerefos, ed.), University of Athens, pp. 121–122.
- Komhyr, W.D., 1986: *Operations Handbook – Ozone Measurements to 40-km Altitude with Model 4A Electrochemical Concentration Cell (ECC) Ozonesondes*. NOAA Technical Memorandum ERL ARL-149.
- Komhyr, W.D., 1997: *Instruction Manual of Model KZ-ECC Atmospheric Ozone Sounding System*. ENSCI-Corporation, Boulder, CO, USA.
- Komhyr, W.D., R.D. Grass and R.K. Leonard, 1989: Dobson spectrophotometer 83: A standard for total ozone measurements, 1962–1987. *Journal of Geophysical Research*, D7, 94, pp. 9847–9861.
- Komhyr, W.D., C.L. Mateer, and R.D. Hudson, 1993: Effective Bass-Paur 1985 ozone absorption coefficients for use with Dobson ozone spectrophotometers. *Journal of Geophysical Research*, 98, pp. 451–465.
- Lamb, K., 2004: International Ozone Service, personal communication.
- Mateer, C.L., 1964: *A Study of the Information Content of Umkehr Observations*. Ph. D. thesis, University of Michigan.
- Mateer, C.L. and J.J. DeLuisi, 1992: A new Umkehr inversion algorithm. *Journal of Atmospheric and Terrestrial Physics*, 54, pp. 537–556.
- McElroy, C.T., J.F. Hahn and E. Hare, 1998: Determining high-altitude trends in ozone from Brewer Umkehr observations made at Canadian stations. *Proceedings of the Quadrennial Ozone Symposium* (R. D. Bojkov and G. Visconti, eds), pp 25–28.
- McElroy, C.T., V. Sevastiouk and K. Lamb, 2004: Calibrating the Brewer spectrophotometers with the travelling standard. *Proceedings of the Quadrennial Ozone Symposium* (C.S. Zerefos, ed.), University of Athens, pp. 577–578.
- McPeters, R.D., J.A. Logan and G.J. Labow, 2003: Ozone climatological profiles for Version 8 TOMS and SBUV retrievals, *EOS, Transactions, American Geophysical Union*, 84, Fall Meeting Supplement, Abstract A21D-0998.
- Megie G.J., A.J. Miller and R.D. Bojkov, 1991: *Recommendations for Implementation of the*

- Bass-Paur Ozone Absorption Coefficients*. Ozone Commission of the International Association of Meteorology and Atmospheric Physics (IAMAP), Geneva, 18 December 1991.
- Molina, L.T. and M.J. Molina, 1986: Absolute absorption cross-sections of ozone in the 185- to 350-nm wavelength range. *Journal of Geophysical Research*, 91, pp. 14501–14508.
- Parrish, A., B.J. Connor, W.P. Chu, J.J. Tsou and I.S. McDermid, 1992: Ground-based microwave monitoring of stratospheric ozone. *Journal of Geophysical Research*, 97, pp. 2541–2546.
- Paur, R.J. and F.F. McElroy, 1979: *Technical Assistance Document for the Calibration of Ambient Ozone Monitors*. EPA-600/4-79-57, United States Environmental Protection Agency.
- Petropavlovskikh, I., P.K. Bhartia and T. McElroy, 2004: Assessment of information content of automated Dobson and Brewer Umkehr measurements. *Proceedings of the Quadrennial Ozone Symposium* (C.S. Zerefos, ed.), University of Athens.
- Rodgers, C.D., 1976: Retrieval of atmospheric temperature and composition from remote measurements of thermal radiation. *Reviews of Geophysics and Space Physics*, 14, pp. 609–624.
- Rodgers, C.D., 1990: Characterization and error analysis of profiles retrieved from remote sounding measurements. *Journal of Geophysical Research*, 95, (D5) pp. 5587–5595.
- Schneider, N.O., O. Lezeaux, J. de la Noë, J. Urban and P. Ricaud, 2003: Validation of ground-based observations of stratomesospheric ozone. *Journal of Geophysical Research*, 108, (D17) 4540, doi: 10.1029/2002JD002925.
- SCI-TEC, 1993: *The Brewer Ozone Spectrophotometer – Maintenance Manual*. SCI-TEC Instruments Inc., publication MM-BA-C05 Rev. J.
- Shalamyansky, A.M., 2003: Personal communication with the WMO SAG-Ozone.
- Staehelin, J., A. Renaud, J. Bader, R. McPeters, P. Viatte, B. Hoegger, V. Bugnion, M. Giroud and H. Schill, 1998: Total ozone series at Arosa, Switzerland: Homogenization and data comparison. *Journal of Geophysical Research*, 103, D5, pp. 5827–5842.
- Tsou, J.J., B.J. Connor, A. Parrish, I.S. McDermid and W.P. Chu, 1995: Ground-based microwave monitoring of middle atmosphere ozone: Comparison to Lidar and stratospheric and gas experiment II satellite observations. *Journal of Geophysical Research*, 100, D2, pp. 3005–3016.
- Vanicek K., 2003: *Calibration History of the Dobson 074 and Brewer 098 Ozone Spectrophotometers*. Publication of the Czech Hydrometeorological Institute, Prague.
- Vanicek, K., M. Stanek and M. Dubrovsky, 2003: *Evaluation of Dobson and Brewer Total Ozone Observations from Hradec Kralove, Czech Republic, 1961–2002*. Publication of the Czech Hydrometeorological Institute, Prague.
- Wardle, D.I., W.F.J. Evans, H. Fast, A.J. Forester, G.S. Henderson, J.B. Kerr and R.K.R. Vupputuri, 1987: *Stratospheric Ozone Science in Canada. An Agenda for Research and Monitoring*. Internal Report of the Atmospheric Environment Service No. ARD-87-3, Toronto.
- World Meteorological Organization, 1980: *Operations Handbook – Ozone Observations with a Dobson Spectrophotometer* (W.D. Komhyr). WMO Global Ozone Research and Monitoring Project Report No. 6, Geneva.
- World Meteorological Organization, 1982a: *Review of the Dobson Spectrophotometer and its Accuracy* (R.E. Basher). WMO Global Ozone Research and Monitoring Project Report No. 13, Geneva.
- World Meteorological Organization, 1982b: *The Stratosphere 1981 Theory and Measurements*. WMO Global Ozone Research and Monitoring Project Report No. 11, Geneva.
- World Meteorological Organization, 1988: *Technical Regulations*, Volume I, WMO-No. 49, Geneva.
- World Meteorological Organization, 1990: *Report of the International Ozone Trends Panel: 1988*. WMO Global Ozone Research and Monitoring Project Report No. 18, Geneva.
- World Meteorological Organization, 1992: *Measurement of Atmospheric Ozone Profiles Using the Brewer/Mast Sonde: Preparation, Procedure, Evaluation* (H. Claude, R. Hartmannsgruber and U. Köhler). WMO Global Ozone Research and Monitoring Project Report No. 17, WMO/TD-No. 179, Geneva.
- World Meteorological Organization, 1993: *Abridged Final Report with Resolutions of the Forty-fourth Session of the Executive Council*. WMO-No. 780, Geneva.
- World Meteorological Organization, 1994: *Survey of WMO-sponsored Dobson Spectrophotometer Intercomparisons* (R.E. Basher). WMO Global Ozone Research and Monitoring Project Report No. 19, WMO/TD-No. 657, Geneva.
- World Meteorological Organization, 1998: *SPARC/IOC/GAW Assessment of Trends in the Vertical Distribution of Ozone* (N. Harris, R. Hudson and C. Phillips). WMO Global Ozone Research and Monitoring Project Report No. 43, WMO/TD-No. 935, Geneva.
- World Meteorological Organization, 2001a: *Reports on WMO International Comparisons of Dobson Spectrophotometers: Part I: Arosa, Switzerland, 19–31 July 1999; Part II: Buenos Aires, Argentina,*

- 19 November–12 December 1999; Part III: Pretoria, South Africa, 18 March–10 April 2000* (R. D. Evans). Global Atmosphere Watch Report No. 138, WMO/TD-No. 1016, Geneva.
- World Meteorological Organization, 2001*b*: *WMO/CEOS Report on a Strategy for Integrating Satellite and Ground-based Observations of Ozone*. Global Atmosphere Watch Report No. 140, WMO/TD-No. 1046, Geneva.
- World Meteorological Organization, 2002: *WMO GAW International Comparisons of Dobson Spectrophotometers at the Meteorological Observatory Hohenpeissenberg, Germany: 21 May–10 June 2000 and 23 July–5 August 2000; 10–23 June 2001 and 8–21 July 2001* (U. Köhler). Global Atmosphere Watch Report No. 145, WMO/TD-No. 1114, Geneva.
- World Meteorological Organization, 2003: *Comparison of Total Ozone Measurements of Dobson and Brewer Spectrophotometers and Recommended Transfer Functions* (J. Staehelin, J. Kerr, R. Evans and K. Vanicek). Global Atmosphere Watch Report No. 149, WMO/TD-No. 1147, Geneva.
- World Meteorological Organization, 2004*a*: *JOSIE-1998: Performance of ECC Ozone Sondes of SPC-6A and ENSCI-Z Type* (H.G.J. Smit and W. Straeter). Global Atmosphere Watch Report No. 157, WMO/TD-No. 1218, Geneva.
- World Meteorological Organization, 2004*b*: *The Changing Atmosphere: An Integrated Global Atmospheric Chemistry Observation Theme for the IGOS Partnership*. Global Atmosphere Watch Report No. 159, WMO/TD-No. 1235, Geneva.
- Zommerfelds, W.C. K.F. Kunzi, M.E. Summers, R.M. Bevilacqua and D.F. Strobel, 1989: Diurnal variations of mesospheric ozone obtained by ground-based microwave radiometry. *Journal of Geophysical Research*, 94, pp. 12819–12832.
-

CHAPTER 17

MEASUREMENT OF ATMOSPHERIC COMPOSITION

17.1 GENERAL

The main purpose of this chapter is to introduce instrument specialists to methods for the measurement of various components of atmospheric composition, with emphasis on the anthropogenic components which fall under the general heading of pollution. Such measurements are often accompanied by measurement of the basic meteorological variables, as introduced in the preceding chapters.

These measurements are taken with the main objectives of studying climate change, introducing measures for the reduction of negative impacts on the environment and for the direct protection of human health. Within WMO, the Global Atmosphere Watch (GAW) was established to coordinate atmospheric pollution measurements taken by WMO Member countries.

The GAW programme integrates many monitoring and research activities involving the measurement of the chemical and physical properties of the atmosphere. It serves as an early warning system to detect further changes in atmospheric greenhouse gases, the ozone layer, the long-range transport of air pollutants, the acidity and toxicity of rain, and the atmospheric burden of aerosols. The GAW was approved in June 1989 by the WMO Executive Council and is designed to strengthen and coordinate the WMO environmental data-gathering programme that began in the 1950s. The new GAW absorbed the Global Ozone Observing System (GO₃OS), the Background Air Pollution Monitoring Network (BAPMoN) and other smaller networks. The GAW provides framework design, standards, intercalibrations, and data collection systems for global monitoring and data evaluation.

The main variables to be determined are as follows:

- (a) Greenhouse gases: including carbon dioxide, chlorofluorocarbons, methane and nitrous oxide;
- (b) Ozone: including surface ozone, total column ozone, vertical profile and precursor gases;
- (c) Radiation and the optical depth or transparency of the atmosphere: including turbidity, solar radiation, ultraviolet B, visibility, total atmospheric aerosol particle load and water vapour;
- (d) Chemical composition of deposition: including dry and wet deposition of sulphur and nitrogen compounds and wet deposition of heavy metals (with precipitation);
- (e) Reactive gas species: including sulphur dioxide and reduced sulphur species, nitrogen oxides and reduced nitrogen species, carbon monoxide and volatile organic compounds;
- (f) Particle concentration and composition characteristics;
- (g) Radionuclides: including krypton-85, radon, tritium and the isotopic composition of selected substances.

The instruments and methods used for the quantitative and qualitative determination of atmospheric constituents are complex and sometimes difficult to deal with. Therefore, besides correct operation, regular calibration of the equipment is essential for accurate and reliable measurements, and quality assurance is very important. Obtaining good results for most of the measurements described here is not feasible without the close involvement of specialist staff at a professional level.

17.2 MEASUREMENT OF SPECIFIC VARIABLES

The accurate operational measurement of atmospheric composition is still a difficult undertaking, mainly due to the very low concentrations of the chemical species of main interest, a frequent need for complicated measurement and analysis protocols, as well as problems related to the calibration of the required equipment. Proper exposure and siting of the sensors/equipment according to defined measurement protocols is of great importance. The following sections will briefly introduce the measurement of some variables. More detailed information can be found in WMO (1993).

17.2.1 Greenhouse gases

Increasing levels of greenhouse gases, particularly carbon dioxide (CO₂), are threatening to change the Earth's climate and weather and may lead to a gradual global warming in the twenty-first century. The magnitude of this warming, and the seriousness of its effects, will depend on future concentrations of greenhouse gases in the atmosphere. Monitoring

greenhouse gas concentrations is therefore of critical importance to the future of the planet. Other greenhouse gases that are monitored from locations all over the globe include methane (CH_4), chlorofluorocarbons (CFCs) and nitrous oxide (N_2O). Tropospheric ozone is also considered to be a greenhouse gas.

WMO has been monitoring CO_2 levels since the 1960s when it established a worldwide network that has since become a part of GAW, the major WMO source of information on atmospheric chemistry. The WMO World Data Centre for Greenhouse Gases, located in Tokyo, Japan, was established in 1990 to archive data for the complete suite of greenhouse gases (WMO, 1995a).

Carbon dioxide

Carbon dioxide is one of the most common and important trace gases in the Earth-ocean-atmosphere system. It has both natural and industrial sources. Within the natural carbon cycle, CO_2 plays a key role in a number of biological processes. Because of the role that CO_2 plays as one of the more important greenhouse gases, scientists have attempted to understand its potential impact on climate and global change.

At present, background atmospheric CO_2 concentration measurements are mainly taken with non-dispersive infrared (NDIR) gas analysers. With special care, such as with the use of (carefully calibrated) reference gases, most types can achieve the required accuracy (± 0.1 parts per million (ppm) in ambient concentrations of 360-390 ppm). Basically, an infrared source provides a beam of radiation that passes through a reference- and sample-measuring cell. The relative difference in intensity of radiation transmitted through the two cells and through an optical filter that passes the CO_2 absorption band at $4.25 \mu\text{m}$ is a measure of the CO_2 concentration difference between the gases contained in the two cells. During normal operation, a comparison gas of constant, but not necessarily precisely known, concentration is flushed through the reference cell. At regular intervals a suite of reference gases covering the normally measured range is passed through the sample cell, which calibrates the response of the analyser. All gases passed through the reference and sample cells are thoroughly dried, and the measurements are expressed as the CO_2 mole fraction in dry air.

In order to obtain global intercomparability of background CO_2 measurements, a calibration system has been developed by the use of a

three-level reference gas system. The system consists of primary, secondary and working reference gases and requires the exchange of reference gases between the different national programmes and a central calibration laboratory. The calibration laboratory is located at the National Oceanic and Atmospheric Administration (NOAA) Global Monitoring Division (GMD) of the Earth System Research Laboratory (ESRL) in Boulder, Colorado, United States. The infrared analysis gives a constant trace of the ambient CO_2 concentration interspersed with calibration gas measurements at a set interval. At least once a week, a calibration test is made over a wider range of concentrations using the secondary standard.

An alternative method of CO_2 measurement which is generally applicable to many other trace gases requires the collection of air in specially designed glass or stainless steel flasks. These flasks are returned to a central laboratory where CO_2 is determined by NDIR analysers (Komhyr and others, 1989). This method has become a standard technique employed by a number of countries.

Chlorofluorocarbons

Chlorofluorocarbons (CFCs), which include CFC-11 (CCl_3F) and CFC-12 (CCl_2F_2), are a family of compounds which do not naturally exist in the environment. Since their manufacture began in the 1930s, CFCs have been used as refrigerant gases, as solvents in industrial applications and dry cleaning, and as a propellant in aerosol cans. Because they are resistant to destruction in the troposphere and because their production has accelerated over time, CFCs were increasing in the lower atmosphere at a rate of about 4 per cent per year. With some restrictions on the use of CFCs in place, CFC-11 has been decreasing at about 1 per cent per year; however, CFC-12 is still increasing at about 1 per cent per year.

CFCs contribute to the greenhouse effect. They are a source of chlorine in the atmosphere and lead to the destruction of ozone, as observed particularly over Antarctica. They have a long residence time in the atmosphere.

The standard technique for analysing CFCs is to pass a whole air sample through a dryer, after which it is injected into a gas chromatograph. Electron capture detectors are used to detect the different gases. Calibration gas measurements are interspersed with air sample measurements to obtain absolute concentration. An alternative to on-site determination is collecting samples in clean,

stainless steel flasks and returning them to a central laboratory for analysis (Prinn and others, 1983).

Nitrous oxide

Nitrous oxide (N_2O) is a gas that has both natural and anthropogenic sources and contributes to the enhanced greenhouse effect (about 6 per cent of the effect is attributable to N_2O). It has a very long atmospheric lifetime (125 years) and concentrations are increasing at the rate of 0.8 parts per billion (ppb) per year. Sources include the oceans, fossil fuel and biomass burning and agricultural soils. Nitrous oxide is inert in the troposphere and its major sink is its photochemical transformation in the stratosphere.

As with several trace gases, an electron capture gas chromatograph is used to measure N_2O . Concentrations are determined by interpreting the measurements with calibration gases of known N_2O concentration. Flask sampling of nitrous oxide is an alternative method of monitoring concentrations. Flasks would be returned to a central laboratory for analysis (Elkins and others, 1996).

Methane

Methane (CH_4) is the most abundant hydrocarbon in the atmosphere. Its tropospheric chemistry affects hydroxyl radical (OH) and carbon monoxide (CO) concentrations. In the stratosphere, the oxidation of CH_4 by OH is a major source of water vapour. Its reaction with chlorine atoms is a termination step in the chlorine-catalysed destruction of ozone. A strong infrared absorption band at $7.66 \mu\text{m}$, where CO_2 and water (H_2O) absorb weakly, makes CH_4 an effective greenhouse gas. The reasons behind the reduction in the CH_4 growth rate from approximately 1 per cent per year in the atmosphere to approximately level concentrations are still largely unknown.

Most measurements of atmospheric methane are made by gas chromatography with flame ionization detection. The gas chromatograph systems are very reliable and technically less difficult to operate and maintain than other methods. Typically, CH_4 is separated from other components of an air sample with a molecular sieve column at a constant temperature. Flame ionization detection has a detection limit for $\text{CH}_4 < 20$ parts per billion by volume (ppbv) (1 ppbv = 1 in 10^9 molecules). Measurements are taken relative to a standard.

Standards composed of air with stable, well characterized CH_4 mixing ratios are critical to a measurement programme. As standards are

depleted, it is necessary to propagate the measurement scale to new working standards.

Several sample introduction schemes are possible. A central processing facility for flask samples should have an automated manifold for alternate flask samples and standard introduction to the analytical system, but this can be done manually. For a field instrument, an automated stream selection valve is used to select between standards and samples.

An alternative measurement technique is to use a tunable diode laser to determine CH_4 mixing ratios by infrared absorption. This method is expensive to set up and maintain and requires a high degree of technical skill (Fried and others, 1993).

17.2.2 Ozone

Although ozone (O_3) comprises less than 0.5 ppm of the total atmosphere, its radiative and chemical properties make it a very significant constituent of the atmosphere. Methods for its measurement are described in Part 1, Chapter 16.

17.2.3 Radiation and the optical depth of the atmosphere

Measurements of the various solar radiation quantities and the optical depth of the atmosphere are required for many studies into the effects of atmospheric pollution. Measurement methods are described in Part 1, Chapter 7.

17.2.4 Atmospheric deposition

Several components of the atmosphere are deposited at the Earth's surface. The following sections will introduce principles for the measurement of wet and dry deposited components.

Wet deposition in rain and snow is a good integrator of the chemical and particulate content of the atmosphere; precipitation chemistry is the collection and analysis of precipitation. Dry deposition is the settling and impaction of aerosols and gases on a surface; this requires its own measuring systems. Measurements of wet and dry deposition have applications in studies of the effects of nutrients, acids and toxic materials, and their long-range transport.

17.2.4.1 Wet deposition

Precipitation chemistry measurements provide information on the exchange of trace materials between the atmosphere and the land/oceans, and

hence are an important link in understanding the chemical cycles of such substances as sulphur, nitrogen and other trace materials.

When planning precipitation chemistry measurements, particular care must be taken so that any form of local contamination, such as dust or traces of oil or perspiration from human contact, is excluded to prevent compromising the usefulness of the measurements. This requires strict adherence to local siting requirements and site operation protocols (Bigelow, 1987).

Precipitation chemistry monitoring can generally be divided into two phases: collection of the sample and laboratory analysis. When a rain or snow event takes place at a site, a special open-close collector is activated to capture the sample, or, alternatively, the lid is removed from the manual collector. The amount of rain from the national precipitation gauge is also recorded. Optimal sampling periods are either weekly or daily, depending on available funding and personnel, as well as on the intended use of the data. From past monitoring experience, daily sampling, where the collector is checked at a given time each day, has been found to be the most scientifically useful because samples can be preserved quickly, thus preventing significant biological degradation of labile species. Daily data also are simpler to manipulate in source-receptor modelling exercises. Under the weekly protocol, all events are composited over a seven-day period, a practice that may compromise the measurement of some ions, but will clearly reduce programme costs. In some networks, acidity (pH) and conductivity are determined on-site as part of the quality control programme, and biocides (for example, chloroform or thymol) are added to the sample before shipping to the laboratory (Keene and Galloway, 1984; Gillett and Ayers, 1991).

The analysis phase begins when the sample is received by the laboratory or analysing facility. To optimize analysis and ensure high quality, central and/or national laboratories are recommended, with performance tested routinely through the quality assurance programmes of GAW. At these laboratories, the major ions are determined (sulphate (SO_4^{-2}), chloride (Cl^-), nitrate (NO_3^-), hydrogen (H^+ (pH)), calcium (Ca^{+2}), magnesium (Mg^{+2}), sodium (Na^+), ammonia (NH_4^+) and potassium (K^+)). Biogenic acids such as formic and acetic acids are an important source of free acidity in pristine areas and should be measured at background stations (Keene, Galloway and Holden, 1983). Conductivity is also usually measured as part of a comprehensive quality assurance programme. A wide variety of analysis

techniques are used by the different laboratories, although ion chromatography and atomic absorption spectrophotometry tend to be the preferred automated analysis techniques (James, 1991).

17.2.4.2 Dry deposition

The term *dry deposition* commonly refers to any atmosphere-surface chemical exchange that occurs at times other than during precipitation events. However, this term can be misleading because some chemicals undergo a bidirectional exchange with the atmosphere. Air-surface exchange is a complex process whose rate is determined by a variety of factors, including atmospheric turbulence and stratification, the chemical and physical characteristics of the deposited compound, the presence and extent of a chemical gradient between the atmosphere and receptor surface, and the chemical, physical (height, surface area, etc.) and biological characteristics of the vegetation receptor surfaces.

Dry deposition is a slow but continuous flux of airborne contaminants to an underlying surface. It contrasts sharply with wet deposition, which is a rapid delivery of pollutants, highly concentrated in precipitation, during precipitation events. Moreover, dry deposition necessarily involves pollutants carried in the lowest layers of the atmosphere, in air that is in contact with the surface. The importance of dry deposition in most areas of the world has never been well documented. Dry deposition is generally far more a local problem than wet deposition. However, in highly industrialized areas, its regional importance is also thought to be great because of the large number of emission sources typically associated with power generation. In many areas, dry deposition is likely to be at least as important as wet deposition.

There are many methods available to estimate dry deposition at a point. Two common approaches are discussed below, namely eddy flux measurements and dry deposition inferential monitoring. Other methods, such as throughfall/stemflow techniques and snowpack accumulation, are not discussed.

Eddy correlation measurements are applicable for certain key pollutants (sulphur dioxide (SO_2), ozone (O_3), nitrogen oxides (NO_x), etc.). They provide direct measurement for comparison to inferential model-based estimates through the use of fast- and slow-response meteorological equipment and fast-response (> 1 Hz) chemical sensors. Reliable flux measurements can be taken using micrometeorological techniques, provided that the user works within a fairly narrowly defined theoretical framework that

is somewhat dependent on the trace gas or particle species being measured. A good overview of micrometeorological theory and a short summary of chemical sensors and micrometeorological techniques used to measure turbulent fluxes may be found in Baldocchi, Hicks and Meyers (1988).

Dry deposition inferential monitoring stations make use of current generation data loggers and mean measurements of meteorological variables, and rely on filterpacks for time-integrated concentration sampling. While meteorological data are typically averaged over periods of 30 min, filterpacks are replaced weekly. Filterpacks in several configurations are now in routine use. A typical configuration will have a teflon prefilter in front to remove particles from the air stream, followed by a nylon filter to remove nitric acid and a third filter of cellulose impregnated, for example, with potassium carbonate (K_2CO_3) to capture sulphur. Usually K_2CO_3 is used to clean the filters (before use) and a potassium hydroxide solution is subsequently used for the impregnation. Optional methods include bubblers, denuders and passive monitors, although these techniques, unlike filterpacks, have not seen routine use in network measurement programmes. Required meteorological data include wind speed, direction standard deviation, incoming shortwave solar radiation, air temperature and humidity, surface wetness and precipitation amount. A thorough discussion of dry deposition inferential measurement techniques may be found in Hicks and others (1991).

17.2.5 Reactive gases

Reactive gases monitored with GAW include CO, SO_2 and NO_x . Although these gases do not contribute directly to the greenhouse effect, they can influence the chemistry of the important greenhouse gases through their interaction with the OH in the atmosphere. Furthermore, as pollutant gases, they are important in influencing the environment at the Earth's surface. For example, both SO_2 and NO_x react photochemically and are the major precursors of acid rain. Nitrogen oxides also play critical roles in determining tropospheric O_3 concentrations of photochemical smog at ground level and in the eutrophication of coastal estuaries.

17.2.5.1 Carbon monoxide

In the non-urban troposphere, CO is often the primary sink for OH. It is therefore an intimate component of the series of photochemical reactions that ultimately oxidize reduced carbon, nitrogen and sulphur trace gases. Although CO itself does not contribute directly to the greenhouse

effect, because of its influence on OH, CO concentrations (with a lifetime of several months) have climatological importance as these indirectly affect the concentrations of many greenhouse gases.

Several analytical techniques are available with which to measure CO at atmospheric levels. Measurements can be taken by gas chromatography with either a flame ionization detector or a mercuric oxide reduction detector (Peterson and Rosson, 1993). Non-dispersive infrared radiation techniques also work, with modifications. The chromatography uses two columns in series, with silica gel first for the removal of impurities, followed by the separation of CO, hydrogen (H_2) and CH_4 on a molecular sieve. Using a flame ionization detector, CO is catalytically converted to CH_4 before entering the detector. In this case, the same gas chromatograph can be used to measure both CH_4 and CO (as well as other hydrocarbons). A measurement precision of 5–10 per cent is easily obtained. When using the mercury oxide (HgO) reduction detector, CO reacts with hot HgO releasing mercury (Hg) vapour, which is detected by ultraviolet absorption. Molecular hydrogen is also detected with this method. Precision is of the order of 1–2 per cent. HgO detectors often exhibit non-linear response over the range of atmospheric CO levels; however, this problem is minimized through the use of multiple calibration standards. The gas chromatograph methods require calibration of the samples to quantify their CO mixing ratios (Novelli and others, 1994).

Tunable diode laser spectroscopy also measures ambient levels of CO by infrared absorption. The drawbacks of this method are that the startup costs are much higher than for gas chromatography, a high degree of technical skill is required to maintain the instruments, and they are not well suited for remote operation (Sachse and others, 1987).

Reference standards consisting of dried air with carefully determined CO mixing ratios are essential to programmes which use gas chromatography, gas fluid chromatography, NDIR, or tunable diode laser spectroscopy to measure CO. In the past, it has been difficult to obtain CO standards representing atmospheric levels. WMO has designated ESRL in Boulder, Colorado, United States, as the central calibration facility for CO. The ESRL is working in coordination with the Fraunhofer Institute (Garmisch-Partenkirchen, Germany), the Swiss Federal Laboratories for Materials Testing and Research (EMPA) (Dübendorf, Switzerland), and the Nitrous Oxide and Halocompounds Group (NOAA/ESRL, United States) to provide the research community with high-quality CO standards. However,

caution must still be used when comparing previously obtained data sets from various laboratories to evaluate either geographical or temporal CO changes. This is primarily due to the use of different standard scales which may vary by as much as 30 per cent (Weeks and others, 1989). Also, low concentrations of CO in high pressure reference gas cylinders are likely to slowly change over time.

There is a very significant problem of contamination associated with the measurement of CO in flask samples. Flask samples of air are generally analysed by using one of the gas chromatography methods. Carbon monoxide may increase or decrease significantly in a few days to weeks in many types of containers. Methods and materials should be rigorously tested for contamination before beginning field measurements.

17.2.5.2 Sulphur dioxide

The sources of sulphur dioxide (SO₂) in the atmosphere include the sea, volcanic activity, anthropogenic emissions and biomass decay processes. Sulphur dioxide has a typical residence time of hours to days. The concentrations of SO₂ in remote areas can be lower than 0.05 ppbv, while in urban areas, concentrations may rise to greater than 10 ppbv. Power plant plumes and volcanic emissions may emit concentrations as high as 1000 ppbv. Sulphur dioxide is a greenhouse gas because it is an infrared absorber. However, because of its low concentration relative to other greenhouse gases, it is a less significant greenhouse gas.

Sulphur dioxide is a climatically active trace species. This is because in the atmosphere it reacts photochemically (homogeneous conversion) and on airborne particles (heterogeneous conversion) to produce sulphates. Atmospheric sulphate particles are active cloud condensation nuclei. An increase in the number of cloud condensation nuclei on a global scale may increase cloud albedo (Charlson and others, 1987). An enhancement in atmospheric sulphate particles in the stratosphere may increase short-wave reflection to space (Charlson and others, 1991). Sulphur dioxide also plays a significant role in producing acid deposition. It forms sulphate particles. These particles return to the Earth's surface via dry or wet deposition processes. Both processes transfer excess acidity to their deposition sites. This acidity may damage sensitive ecosystems.

Concentrations of SO₂ can be measured continuously by using either a pulsed-fluorescence analyser or a flame-photometric device. The response time

of the pulsed-fluorescence sensor is slower, but its ease of calibration, dependability, accuracy and SO₂ specificity make it preferable (Luke, 1997; Kok and others, 1990). More sensitive gas-chromatographic techniques are available. They require significant technical expertise and regular attention. Concentrations of SO₂ can also be measured by using filter media. This method yields a potentially more accurate result. It is an integrative technique and requires frequent attention, and filter analysis costs are high.

Since SO₂ has a short atmospheric lifetime, understanding the sulphur cycle requires knowledge of the source and sink terms. This is best accomplished with sampling frequencies of less than 1 h. Therefore, the best technique for the long-term monitoring of SO₂ may be a combination of the pulsed-fluorescence analyser and filter sampling. Filter samples would be exposed at intervals, but often enough to act as a quality control for the continuous analyser.

Sulphur dioxide should be considered a reactive gas. It may stick to intake lines or oxidize within water drops condensed in the lines. Thus, intake lines should be made of inert material, for example, stainless steel, as short as possible, and thermostatically heated when condensation is likely to occur. Measurement on PFA Teflon is acceptable after appropriate tests have been conducted to ensure no loss from inappropriate filter additives.

A summary of techniques is presented in the special issue of the *Journal of Geophysical Research* discussing the Gas-Phase Sulfur Intercomparison Experiment (GASIE), beginning with an overview of the experiment by Stecher and others (1997).

17.2.5.3 Nitrogen oxides

Nitrogen oxides (NO_x) comprise a large family of trace gases that are ubiquitous in the Earth's troposphere. Their origin is from both anthropogenic (combustion) and natural (biomass burning, lightning, soil microbial activity) processes; transport from the stratosphere is also thought to be a source. NO_x play a crucial role in determining the ozone concentration in the air and are an important contributor to the acid precipitation problem, especially in North America. Although the need for knowledge of the abundance of these compounds is unquestioned even at the parts per trillion by volume (pptv) level (1 pptv = 1 in 10¹² molecules), very little observational data outside urbanized areas are presently available

owing to the scarcity of sensitive equipment, difficulty in accurately measuring NO_x and a high degree of skill or training needed to measure NO_x reliably at such low concentrations. The more important nitrogen oxide compounds are nitric oxide (NO), nitrogen dioxide (NO_2) (the sum of these two compounds is often indicated as NO_x), nitric acid (HNO_3), aerosol nitrate and peroxy-acetyl-nitrate (PAN). Nitric oxide and NO_2 are the initial compounds produced, while the others are the product of chemical conversions in the atmosphere from the former. Nitrous oxide (N_2O) is a special case; its chemistry is very different from all other nitrogen oxides in that it is essentially inert in the troposphere. It is discussed in section 17.2.1 as one of the greenhouse gases.

When measuring these gases, it should be noted that conversions between the different compounds are generally rapid, and the most unambiguous data for NO_x are often expressed as the sum of all compounds (excluding N_2O), often denoted as total reactive nitrogen (NO_y). Obvious precautions related to human interference with the measurements have to be taken into account. Since the levels are so low, even at less remote locations, great care has to be taken to minimize potential contamination from any form of motorized transport, which is a principal source of NO_x (and also CO and SO_2) (United States Environmental Protection Agency, 1996).

Nitric oxide and nitrogen dioxide

Reliable measurements of nitric oxide (NO) and nitrogen dioxide (NO_2) at background levels are possible by using instruments based on chemiluminescence of NO (with O_3) or NO_2 (indirectly using chemiluminescence following conversion to NO). NO_2 may also be measured directly with a luminol solution. However, commercial instruments are not sensitive enough. Low-level measurements require research-grade or modified detectors.

The O_3 chemiluminescence technique is a continuous measurement method based upon the detection of photons released through the reaction of O_3 with NO. Ambient air is drawn into a reaction vessel at a controlled flow rate using a mechanical vacuum pump and mass flow controller. Ozone is generated within the instrument as a reagent by passing a flow of pure, dry oxygen through a high-voltage electrode and is directed into the reaction vessel where it reacts with NO in the ambient air flow to form NO_2 . A fraction of the

NO_2 is formed in an electronically excited state, a portion of which emits a photon as it relaxes back to the ground state. A red-sensitive photomultiplier tube is used to detect the emission spectrum. As mentioned above, NO_2 must first be converted to NO prior to detection. Typically, heated molybdenum or gold surfaces are used to convert the total reactive nitrogen species NO_y to NO. Photolytic conversion is a more selective method to measure NO_2 , but may suffer from small interferences from nitrous acid (HONO), nitrate (NO_3) and PAN.

Instruments suitable for gradient measurements (a dry deposition measurement technique) are available commercially. Custom-built instruments have been deployed in a variety of eddy correlation studies of NO emissions from soils (Luke and Valigura, 1997).

Nitrogen dioxide may be measured directly through its chemiluminescent reaction with luminol. The solution flows at a controlled rate down a fabric wick in front of a photomultiplier tube and blue photons are emitted by the chemiluminescence. Commercial versions of this instrument are available, and the technique does give rapid and sensitive measurements. However, the method suffers from non-linearity at NO_2 concentrations below 2 to 3 ppbv and exhibits a slight O_3 and a significant PAN interference (Luke and Valigura, 1997). Instruments must be adjusted frequently to account for calibration drift and shift in zero point with temperature.

Peroxy-acetyl-nitrate

Peroxy-acetyl-nitrate (PAN) is ubiquitous in the troposphere and is typically abundant in polluted urban air due to the reactivity of many anthropogenic hydrocarbons. PAN may undergo long-range transport at low temperatures and may be present at high latitudes. Studies of PAN are relatively few; however, PAN may be important because of phytotoxicity and abundance in urban areas. A thorough review of the sources, sinks and atmospheric chemistry of PAN may be found in Roberts (1990).

PAN is typically measured by using automated gas chromatographs, equipped with either electron capture detection or by thermal decomposition followed by detection of NO_2 via luminol chemiluminescence. The use of a luminol detector has a disadvantage due to its sensitivity to NO_2 . The major problem with PAN measurements is the unreliability of calibration.

Nitric acid and aerosol nitrate

The primary anthropogenic nitrogen species emitted to the atmosphere is NO which is quickly transformed to NO₂ and then by several steps to mainly nitric acid (HNO₃), which is efficiently deposited to the surface of the Earth via both wet and dry deposition mechanisms. See section 17.2.4.1 for more information regarding the wet deposition pathway.

Nitric acid and aerosol nitrates are amenable to monitoring with filters. A standard procedure would require a train of filters in series, with the first filter, a Teflon filter to capture aerosol particles, including aerosol nitrate, followed by a nylon, or base-impregnated filter to capture acid gases including HNO₃. These filters are routinely exposed for periods of many hours, by sampling air at a flow rate of several litres per minute. The filters are then transported to a laboratory, extracted, and analysed for nitrate ions by ion chromatography. In order to derive the amount of air sampled, the pumping flow rate must be continually monitored. The most severe problem associated with the use of the filter-pack method is the potential for artefact formation from the collection and volatilization of ammonium nitrate aerosols. These problems can be largely avoided by keeping sampling time short (Anlauf and others, 1985; Luke and Valigura, 1997).

Good alternative methods exist for measuring HNO₃. Denuders have been employed, but their use is not as widespread as that of the filterpack method because of the labour intensiveness of the procedure (Luke and Valigura, 1997). Mist chamber methods are also available and were developed as an alternative to the filterpack method. Klemm and others (1994) tested this methodology in the Canadian Taiga during a recent field programme.

Total reactive nitrogen

Collectively, the suite of nitrogen oxides is known as total reactive nitrogen (NO_y) as follows:

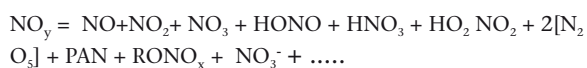

where NO_x represents the sum of NO and NO₂. Each of these compounds behaves differently in the atmosphere and deposits at a different rate. Many of these compounds are present in minute quantity and are difficult to convert quantitatively for measurement as NO. NO_y is measured by converting each of these compounds to NO and measuring them as compounds, as described earlier. This

conversion is obtained by passing the air through a gold converter tube kept at approximately 300°C, together with a small amount of either pure CO or hydrogen gas (Luke and Valigura, 1997). Heated molybdenum screens, wire or tubing (temperature ~ 300–350°C) may also be used, without the necessity of adding CO or hydrogen.

17.2.6 **Chemical properties of particulate matter**

The chemical properties of atmospheric particles can affect the environment in many ways. Toxic aerosols such as heavy metals (for example, lead (Pb), cadmium (Cd) or arsenic (As)) or particles from semi-volatile organic contaminants (for example, from polychlorinated biphenyl compounds) have been linked to a broad range of adverse effects on humans and animals, including effects to the reproductive, nervous, immune and endocrine systems, and changes in enzyme functioning (United States Environmental Protection Agency, 1997). Hygroscopic aerosols, for example, sea salt, sulphate and nitrate particles are active cloud condensation nuclei which govern the concentration and size distribution of cloud droplets, and thus affect cloud lifetime, amount and albedo and overall climate (Parungo and others, 1992). Hydrophobic aerosols, for example, soil dust and decayed bio-debris, can serve as ice nuclei and thus control precipitation amount. In order to improve our understanding of the trends and extent of aerosol effects on global change, it is important to measure the spatial and temporal variabilities of aerosol chemical properties.

The most simple and direct sampling technique is to collect particles on filters. Samples can be collected on one stage for bulk analysis or on several cascade stages for size discrimination. The samples are sent to a centralized laboratory for chemical analyses. Soluble portions of aerosol particles can be extracted with water and determined with an ion chromatograph for cation and anion concentrations. The insoluble particles are typically analysed with instrumental neutron activation analysis, proton induced X-ray emission, or inductivity coupled plasma mass spectrogrametry for elemental composition. Semi-volatile components are typically analysed by gas chromatography by using either an electron capture detector or coupled with a mass spectrometer (Parungo and others, 1992; Baker, 1997).

For all samples collected, the sampling and analytical procedures should be standardized to the degree possible at all sites. However, it is difficult to specify

sampling regimes for such a broad array of materials which have tremendous spatial and temporal variation, particularly between urban and background regions. For many urban and rural regions, 12 h samples taken several times per week provide an adequate understanding of the concentration regime, while background areas may require longer exposures. If filter concentrations are to be coupled with source-receptor models, sampling frequencies may need to be tuned to the requirements imposed by meteorological conditions (Harris and Kahl, 1990).

17.2.7 Radioactive gases

Radioactive gases are trace gases in the atmosphere system which are both natural and from industrial sources. Regarding the latter, radioactive gases are especially produced by nuclear electric power generation, by other industrial processes and by former nuclear weapons tests. The concentration of the different components varies and in high enough concentrations can have negative impacts on humans.

The behaviour of radioactive contaminants in the atmosphere is governed by their chemical and physical nature. The dynamics of transport, diffusion, deposition and condensation for these materials will be nearly the same as for their non-radioactive counterparts. One possible exception to this generality is the fact that radioactive particles produce ionization in the surrounding air and leave charges on particles; this factor could change processes that are dependent upon charge effects. The radioactive properties of individual radioisotopes or particular mixture of radioisotopes are of importance in determining the quantity and nature of the radioactive materials reaching the receptor, as well as the resulting radiation dose (Slade, 1968).

17.2.7.1 Radon

Radon is an inert gas resulting from the alpha decay of radium, with a half-life of 3.82 days. Because radon fluxes from soils are typically 100 times those from the ocean, radon is useful as a tracer for air masses that have recently passed over land. Studies at the Mauna Loa observatory in Hawaii have identified diurnal episodes of radon transported from local sources, and long-term transport of air from distant continents. In conjunction with other measurements, radon data provide a useful constraint in evaluating air transport models and in identifying baseline atmospheric conditions. Because of its short residence time in the atmosphere and wide range of surface emanation rates, the interpretation

of radon measurements is highly site-specific (Liu, McAfee and Cicerone, 1984; Hansen and others, 1990).

Radon-222 decays through a series of five progeny into lead 210, which is relatively stable at a half-life of 22 years. Two of these progeny undergo alpha decay. The daughter products are chemically reactive and quickly form complex hydrated ions that readily attach to particles and surfaces.

In a typical radon-monitoring instrument, air is drawn through a filter which removes all the ambient daughters but allows the inert radon gas to pass. Radon then enters a large chamber that allows a delay during which its progeny are produced. These are collected on a second filter, and their alpha activity is measured by a scintillation detector. The response of an instrument is dependent on a number of factors, such as the flow rate, chamber geometry, progeny capture efficiency, sampling interval, and counter efficiency. The usual sampling frequency is one to two samples per hour (Thomas and LeClare, 1970).

17.2.7.2 Krypton-85

Krypton-85 (^{85}Kr) is a radioactive noble gas that decays with a half-life of 10.76 years, emitting mainly β particles with a mean energy of 251 KeV. The main sources of ^{85}Kr are nuclear-fuel reprocessing plants and various nuclear reactors. The nuclear weapons tests carried out between 1945 and 1963 contributed about 5 per cent of the total ^{85}Kr in the atmosphere, whereas its natural sources can be neglected. Radioactive decay is practically the only mechanism of ^{85}Kr removal from the atmosphere. The present background concentrations of ^{85}Kr in the atmosphere are about 1 Bq/m³ and are doubled every 20 years. At this level, ^{85}Kr is not dangerous for human beings, but the air ionization caused by ^{85}Kr decay will affect atmospheric electric properties. If ^{85}Kr levels continue to increase, changes in such atmospheric processes and properties as atmospheric electric conductivity, ion current, the Earth's magnetic field, formation of cloud condensation nuclei and aerosols, and the frequency of lightning may result and, thus, disturb the Earth's heat balance and precipitation patterns. These ^{85}Kr -induced consequences call for ^{85}Kr monitoring (WMO, 1995b).

To measure ^{85}Kr , air samples are collected using a charcoal trap that has been immersed in a container of liquid nitrogen. Samples are prepared chromatographically and reduced to cryogenic temperatures, forced through a concentrator and then desorbed by the flux of a helium gas carrier.

After leaving the chromatograph, the mixture is fed into the liquid air-cooled trap. Radiometric analysis is then performed using a scintillation detector (Novichkov, 1997).

The required precision for ^{85}Kr depends on the application of the information. For the purpose of climate change research, only the order of magnitude of the atmospheric concentration would be of interest. In this case, a precision as low as about 10 per cent would be acceptable. If however, ^{85}Kr is to be used as a tracer for the purpose of understanding transport and mixing processes, a precision of the order of 1 per cent would be required. The measurement of ^{85}Kr provides a good tool to validate or perhaps even calibrate global-scale transport and mixing characteristics of models (Novichkov, 1997).

17.3 QUALITY ASSURANCE

The primary objective of the GAW quality assurance system is to ensure that the data deposited in the World Data Centres are consistent, meet the GAW data quality objectives and are supported by comprehensive metadata. The quality assurance system is designed around Quality Assurance/Science Activity Centres (QA/SACs), which are, among other things, expected to critically review data submitted by individual stations. This will be achieved through adherence to GAW standard operating procedures. According to a decision of the Executive Council Panel of Experts/CAS Working Group on Environmental Pollution and Atmospheric Chemistry in 1999 (WMO, 1999), QA/SACs should have global responsibility for specific atmospheric parameters. The GAW quality assurance procedures should not only address the quality of the measurement, but also the entire quality assurance process, beginning at the station with the training of station personnel and ending with the World Data Centres containing data of the required quality.

The recommended GAW quality assurance principles to ensure comparability and consistency of measurements involve the following (WMO, 2001):

- (a) Adoption and use of internationally accepted methods and vocabulary to deal with uncertainty in measurements as outlined by the International Organization for Standardization (ISO, 1993; 1995);
- (b) Use of harmonized measurement techniques based on standard operating procedures at all stations. A standard operating procedure is a written document that has been officially approved by the relevant Scientific Advisory

Group and details the method for performing a certain operation, analysis or action by thoroughly prescribing the techniques and steps involved;

- (c) Regular performance and system audits. In the context of GAW, a performance audit is understood as being a voluntary check for the conformity of a measurement where the audit criteria are the data quality objectives for that parameter. In the absence of formal data quality objectives, an audit will at least involve ensuring the traceability of measurements to the reference standard. A system audit is more generally defined as a check of the overall conformity of a station with the principles of the GAW quality assurance system. The reference for station conformity will evolve as the GAW quality assurance system evolves.

According to WMO (2001), the overall goals of the quality assurance system are the following:

- (a) To establish data quality objectives and standard operating procedures for all parameters as recommended by the Scientific Advisory Groups;
- (b) To identify and establish QA/SACs, World Calibration Centres and reference standards where needed;
- (c) To harmonize the GAW quality assurance procedures;
- (d) To increase the frequency of instrument calibrations and intercomparisons;
- (e) To build alliances between and among global and regional stations (scientific and technical cooperation, twinning), as well as twinning between individuals (scientists and station personnel).

According to (WMO (2001), the current implementation includes the following:

- Task 1: To establish a prioritized list of parameters urgently needing data quality objectives;
- Task 2: To identify and establish QA/SACs for N_2O and CFCs;
- Task 3: To identify and, where feasible, establish World Calibration Centres and reference standards for the remaining parameters;
- Task 4: To develop standard operating procedures for the remaining parameters;
- Task 5: To develop guidelines for GAW station system audits;
- Task 6: To identify and establish Regional Calibration Centres, where necessary, which provide calibration and instrument intercomparison for GAW stations in the region.

The quality assurance-related tasks for the various GAW components are also covered by Global and Regional Calibration Centres. These centres perform the vital function of helping to ensure that the data submitted to the GAW World Data Centres are of sufficient quality. Their activities include the following:

- (a) The careful calibration of instruments through station visits;
- (b) Instrument intercomparisons and calibration campaigns;
- (c) Laboratory measurement intercomparisons of circulated standard gases or reference samples;
- (d) Systematic and frequent calibration checks of the world standards.

Although these direct calibration activities are required to maintain the required comparability of measurements during station visits, GAW Calibration Centres also provide on-site training and expert advice to help station personnel

maintain the required data quality. Workshops are also held during intercomparisons and calibration campaigns. Further help is provided to less experienced personnel at new stations by personnel from well-established and technically advanced stations. In addition, GAW Training Centres sponsor frequent training sessions for station personnel, particularly those located in developing countries. These capacity-building activities are increasingly important as many GAW stations in developing countries have become operational. As reported in WMO (2001), the GAW quality assurance system is still incomplete. Currently, very few guidelines have been produced for quality assurance and standard operating procedures for the GAW programme, and no GAW reports are available concerning system audits. Further details on the current GAW implementation strategy are provided on the WMO website (<http://www.wmo.int>, "Global Atmosphere Watch" under "Topics").

REFERENCES AND FURTHER READING

- Anlauf, K.G., P. Fellin, H. Wiebe, H. Schiff and G. Mackay, R. Braman and R. Gilbert, 1985: A Comparison of three methods for measurement of atmospheric nitric acid and aerosol nitrate and ammonium. *Atmospheric Environment*, 19, pp. 325–333.
- Baker, J.E. (ed.), 1997: *Proceedings from a Session at the SETAC Fifteenth Annual Meeting* (30 October–3 November 1994, Denver, Colorado), SETAC Press, Pensacola, Florida, pp. 347–377.
- Baldocchi, D.D., B.B. Hicks and T. P. Meyers, 1988: Measuring biosphere-atmosphere exchanges of biologically related Gases with micrometeorological methods. *Ecology*, Volume 69, Number 5, pp. 1331–1340.
- Bigelow, D.S., 1987: *Siting and Sampling Characteristics of the National Atmospheric Deposition Program and the National Trends Network: Regional Influences*. EMEP Workshop on Data Analysis and Presentation (Cologne, Federal Republic of Germany, 15–17 June 1987), EMEP/CCC-Report 7/87, Norwegian Institute for Air Research, Lillestrom, Norway, December 1987, pp. 149–160.
- Charlson, R.J., J.E. Lovelock, M.O. Andreae and S.G. Warren, 1987: Oceanic phytoplankton, atmospheric sulphur, cloud albedo and climate. *Nature*, 326, pp. 655–661.
- Charlson, R. J., C.B. Leovy, S.G. Warrend, J. Langner and H. Rodhe, 1991: Perturbation of the northern hemisphere radiative balance by backscattering from anthropogenic sulfate aerosols. *Tellus*, 43AB, pp. 152–163.
- Dlugokencky, E.J., L.P. Steale, P.M. Lang and K.A. Masarie, 1995: Atmospheric methane at the Mauna Loa and Barrow observatories: Presentation and analysis of in situ measurements. *Journal of Geophysical Research*, Volume 100, (D11), pp. 23103–23113.
- Elkins, J.W., and others, 1996: Airborne gas chromatograph for in situ measurements of long-lived species in the upper troposphere and lower stratosphere. *Geophysical Research Letters*, Volume 23, Issue 4, pp. 347–350.
- Fried, A., H. Bruce and J.R. Drummond, 1993, Tunable diode laser ratio measurements of atmospheric constituents by employing dual fitting analysis and jump scanning. *Applied Optics*, 32 (6), pp. 821–827.
- Gillett, R.W. and G.P. Ayers, 1991: The use of thymol as a biocide in rainwater samples. *Atmospheric Environment*, Volume 25, Number 12, pp. 2677–2681.
- Hansen, A.D.A., R.S. Artz, A.A.P. Pszenny and R.E. Larson, 1990: Aerosol black carbon and radon as tracers for air mass origin over the North Atlantic Ocean. *Global Biogeochemical Cycles*, 4(2), pp. 189–199.
- Harris, J.M. and J.D. Kahl, 1990: A descriptive atmospheric transport climatology for the Mauna Loa observatory, using clustered trajectories. *Journal of Geophysical Research*, Volume 95, Issue D9, pp. 13651–13667.
- Hicks, B.B., R.P. Hosker, T.P. Meyers and J.D. Womack, 1991: Dry deposition inferential measurement techniques – I: Design and tests of a prototype meteorological and chemical system for determining dry deposition. *Atmospheric Environment*, Volume 25A, Number 10, pp. 2345–2359.
- International Organization for Standardization, 1993: *International Vocabulary of Basic and General Terms in Metrology*. Second edition, Geneva.
- International Organization for Standardization, 1995: *Guide to the Expression of Uncertainty in Measurement*. First edition, Geneva.
- James, K.O.W., 1991: *Quality Assurance Report*. NADP/NTN Deposition Monitoring, Laboratory Operations, Illinois State Water Survey, Champaign, Illinois.
- Keene, W.C. and J.N. Galloway, 1984: Organic acidity in precipitation of North America. *Atmospheric Environment*, Volume 18, Number 11, pp. 2491–2497.
- Keene, W.C., J.N. Galloway and J.D. Holden, 1983: Measurement of weak organic acidity in precipitation from remote areas of the world. *Journal of Geophysical Research*, 88C(9), pp. 5122–5130.
- Klemm, O., R.W. Talbot, D.R. Fitzgerald, K.I. Klemm and B.L. Lefer, 1994: Low to middle tropospheric profiles and biosphere/troposphere fluxes of acidic gases in the summertime Canadian Taiga. *Journal of Geophysical Research*, 99, pp. 1687–1698.
- Kok, G.L., A.J. Schanot, P.F. Lindgren, P.K. Dasgupta, D.A. Hegg, P.V. Hobbs and J.F. Boatman, 1990: An airborne test of three sulfur dioxide measurement techniques. *Atmospheric Environment*, 24A, pp. 1903–1908.
- Komhyr, W.D., T.B. Harris, L.S. Waterman, J.F.S. Chin and K.W. Thoning, 1989: Atmospheric carbon dioxide at the Mauna Loa Observatory. 1: NOAA global monitoring for climatic change measurements with a nondispersive infrared analyzer, 1974–1985. *Journal of Geophysical Research*, 94 (D6), pp. 8533–8547.

- Liu, S.C., J.R. McAfee and R.J. Cicerone, 1984: Radon 222 and tropospheric vertical transport. *Journal of Geophysical Research*, Volume 89 (D5), pp. 7291-7297.
- Luke, W.T., 1997: Evaluation of a commercial pulsed fluorescence detector for the measurement of low-level SO₂ concentrations during the Gas-Phase Sulfur Intercomparison Experiment. *Journal of Geophysical Research*, Volume 12, (D13), pp. 16255-16265.
- Luke, W.T. and R.A. Valigura, 1997: Methodologies to estimate the air-surface exchange of atmospheric nitrogen compounds. In: Atmospheric deposition of contaminants to the Great Lakes and coastal waters (J.E. Baker, ed.). *Proceedings from a Session at the SETAC Fifteenth Annual Meeting* (30 October-3 November 1994, Denver Colorado), SETAC Press, Pensacola, Florida, pp. 347-377.
- Novelli, P.C., J.E. Collins, R.C. Myers, G.W. Sachse and H.E. Scheel, 1994: Reevaluation of the NOAA/CMDL carbon monoxide reference scale and comparisons with CO reference gases at NASA-Langley and the Fraunhofer Institut. *Journal of Geophysical Research*, Volume 99 (D6), pp. 12833-12839.
- Novichkov, V., 1997: *Measurement Content of Krypton-85 in Earth Atmosphere and Validation of Global Model of Atmospheric Transport*. IGAC-SPARC-GAW Conference on Global Measurement Systems for Atmospheric Composition (Toronto, Canada, 20-22 May 1997).
- Parungo, F.B. Kopcewicz, C. Natgamoto, R. Schnell, P. Sheridan, C. Zhu and J. Harris, 1992: Aerosol particles in the Kuwait oil fire plumes: Their morphology, size distribution, chemical composition, transport, and potential effect on climate. *Journal of Geophysical Research*, Volume 97, (D14), pp. 15867-15882.
- Peterson, J.T. and R.M. Rosson, 1993: *Climate Monitoring and Diagnostics Laboratory*. Summary Report 1992, No. 21, Environmental Research Laboratories, Boulder, Colorado.
- Prinn, R.G., P.G. Simmonds, R.A. Rasmussen, A.J. Crawford, R.D. Rosen, F.N. Alyea, C.A. Cardelino, D.M. Cunnold, P.J. Fraser and J.E. Lovelock, 1983: The atmospheric lifetime experiment. 1: Introduction, instrumentation, and overview. *Journal of Geophysical Research*, Volume 88, (C13), pp. 8353-8367.
- Roberts, J.M., 1990: The atmospheric chemistry of organic nitrates. *Atmospheric Environment*, 24A, pp. 243-287.
- Sachse, G.W. G.F. Hill, L.O. Wade and M.G. Perry, 1987: Fast-response, high-precision carbon monoxide sensor using a tunable diode laser absorption technique. *Journal of Geophysical Research*, Volume 92 (D2), pp. 2071-2081.
- Slade, D.H. (ed.), 1968: *Meteorology and Atomic Energy*. United States Atomic Energy Commission, Office of Information Services.
- Smith, R.A., 1872: *Air and Rain: The Beginnings of a Chemical Climatology*. Longmans, Green and Co., London.
- Stecher, H.A. and others, 1997: Results of the Gas-phase Sulfur Intercomparison Experiment (GASIE): Overview of experimental setup, results and general conclusions. *Journal of Geophysical Research*, 102, D13, pp. 16219-16236.
- Thomas, J.W. and P.C. LeClare, 1970: A study of the two-filter method for radon-222. *Health Physics*, 18(2), pp. 113-122.
- United States Environmental Protection Agency, 1996: *National Air Quality and Emissions Trends Report, 1995*. EPA-454/R-96-005, Office of Air Quality Planning and Standards, Research Triangle Park, North Carolina.
- United States Environmental Protection Agency, 1997: *Deposition of Air Pollutants to the Great Waters: Second Report to Congress*. EPA-453/R-97-011, Office of Air Quality Planning and Standards, Research Triangle Park, North Carolina.
- Weeks, I.A., I.E. Galbally, P.J. Fraser and G. Mathews, 1989: Comparison of the carbon monoxide standards used at Cape Grim and Aspendale. *Baseline Atmospheric Program 1987* (B.W. Forgan and G.P. Ayers, eds). Australian Government Department of Science and Technology, Canberra, Australia, pp. 21-25.
- World Meteorological Organization, 1993: *Global Atmosphere Watch Guide*. Global Atmosphere Watch Report No. 86, WMO/TD-No. 553, Geneva.
- World Meteorological Organization, 1995a: *Report of the Meeting of Experts on the WMO World Data Centres* (E.W. Hare). Global Atmosphere Watch Report No. 103, WMO/TD-No. 679, Geneva.
- World Meteorological Organization, 1995b: *Report of an Expert Consultation on 85Kr and 222Rn: Measurements, Effects and Applications*. Global Atmosphere Watch Report No. 109, WMO/TD-No. 733, Geneva.
- World Meteorological Organization, 1999: *Report of the Sixth Session of the EC Panel of Experts/CAS Working Group on Environmental Pollution and Atmospheric Chemistry*. Global Atmosphere Watch Report No. 135, WMO/TD-No. 1002, Geneva.
- World Meteorological Organization, 2001: *Strategy for the Implementation of the Global Atmosphere Watch Programme (2001-2007): A Contribution to the Implementation of the WMO Long-term Plan*. Global Atmosphere Watch Report No. 142, WMO/TD-No. 1077, Geneva.

PART II

OBSERVING SYSTEMS

PART II. OBSERVING SYSTEMS

CONTENTS

	<i>Page</i>
CHAPTER 1. MEASUREMENTS AT AUTOMATIC WEATHER STATIONS	II.1-1
1.1 General.....	II.1-1
1.2 Automatic weather station hardware	II.1-3
1.3 Automatic weather station software.....	II.1-10
1.4 Automatic weather station siting considerations.....	II.1-17
1.5 Central network data processing	II.1-17
1.6 Maintenance	II.1-18
1.7 Calibration	II.1-19
1.8 Training.....	II.1-20
References and further reading	II.1-22
CHAPTER 2. MEASUREMENTS AND OBSERVATIONS AT AERONAUTICAL METEOROLOGICAL STATIONS.....	II.2-1
2.1 General.....	II.2-1
2.2 Surface wind.....	II.2-3
2.3 Visibility.....	II.2-4
2.4 Runway visual range	II.2-5
2.5 Present weather.....	II.2-9
2.6 Cloud	II.2-10
2.7 Air temperature.....	II.2-11
2.8 Dewpoint	II.2-11
2.9 Atmospheric pressure.....	II.2-12
2.10 Other significant information at aerodromes.....	II.2-14
2.11 Automated meteorological observing systems	II.2-14
2.12 Radar	II.2-15
2.13 Ice sensor.....	II.2-15
2.14 Lightning detection	II.2-16
2.15 Other relevant observations	II.2-16
References and further reading	II.2-17
CHAPTER 3. AIRCRAFT OBSERVATIONS.....	II.3-1
3.1 General.....	II.3-1
3.2 Pressure and Mach number	II.3-1
3.3 Air temperature.....	II.3-4
3.4 Wind speed and direction.....	II.3-5
3.5 Turbulence	II.3-6
3.6 Relative humidity	II.3-8
3.7 Icing	II.3-9
3.8 Practical operational systems.....	II.3-9
3.9 Future AMDAR systems.....	II.3-9
References and further reading	II.3-11
CHAPTER 4. MARINE OBSERVATIONS.....	II.4-1
4.1 General.....	II.4-1
4.2 Observations from ships.....	II.4-1
4.3 Moored buoys	II.4-17

4.4	Unstaffed light vessels	II.4-18
4.5	Towers and platforms.....	II.4-18
4.6	Drifting buoys.....	II.4-19
	Annex. Descriptions of precipitation for use by ship-borne observers	II.4-20
	References and further reading.....	II.4-22
CHAPTER 5. SPECIAL PROFILING TECHNIQUES FOR THE BOUNDARY LAYER AND THE TROPOSPHERE.....		II.5-1
5.1	General.....	II.5-1
5.2	Ground-based remote-sensing techniques	II.5-1
5.3	In situ measurements.....	II.5-6
	References and further reading.....	II.5-10
CHAPTER 6. ROCKET MEASUREMENTS IN THE STRATOSPHERE AND MESOSPHERE		II.6-1
6.1	General.....	II.6-1
6.2	Wind measurement	II.6-1
6.3	Temperature measurement by immersion thermometry	II.6-3
6.4	Temperature measurement by inflatable falling sphere	II.6-5
6.5	Calculation of other aerological variables	II.6-6
6.6	Networks and comparisons.....	II.6-6
	References and further reading.....	II.6-8
CHAPTER 7. LOCATING THE SOURCES OF ATMOSPHERICS		II.7-1
7.1	General.....	II.7-1
7.2	The direction finding lightning location system.....	II.7-3
7.3	Examples of time-of-arrival location systems.....	II.7-5
7.4	Comparisons of direction-finder and time-of-arrival networks	II.7-7
7.5	A combination of the direction-finder and time-of-arrival techniques	II.7-8
7.6	Presentation and distribution of lightning data.....	II.7-8
	References and further reading.....	II.7-9
CHAPTER 8. SATELLITE OBSERVATIONS		II.8-1
8.1	General.....	II.8-1
8.2	Operational satellite systems	II.8-3
8.3	Meteorological observations.....	II.8-8
8.4	Related facilities	II.8-30
	Annex 8.A. Advanced very high resolution radiometer channels.....	II.8-34
	Annex 8.B. HIRS channels and their applications.....	II.8-35
	References and further reading.....	II.8-36
CHAPTER 9. RADAR MEASUREMENTS		II.9-1
9.1	General.....	II.9-1
9.2	Radar technology	II.9-4
9.3	Propagation and scattering of radar signals.....	II.9-11
9.4	Velocity measurements	II.9-13
9.5	Sources of error	II.9-15
9.6	Optimizing radar characteristics.....	II.9-16
9.7	Radar installation.....	II.9-18
9.8	Calibration and maintenance.....	II.9-19
9.9	Precipitation measurements	II.9-20

	<i>Page</i>
9.10 Severe weather detection and nowcasting applications	II.9-24
9.11 High frequency radars for ocean surface measurements	II.9-26
References and further reading	II.9-27
 CHAPTER 10. BALLOON TECHNIQUES	 II.10-1
10.1 Balloons.....	II.10-1
10.2 Balloon behaviour	II.10-2
10.3 Handling balloons	II.10-3
10.4 Accessories for balloon ascents	II.10-5
10.5 Gases for inflation.....	II.10-5
10.6 Use of hydrogen and safety precautions	II.10-7
References and further reading	II.10-10
 CHAPTER 11. URBAN OBSERVATIONS.....	 II.11-1
11.1 General.....	II.11-1
11.2 Choosing a location and site for an urban station.....	II.11-7
11.3 Instrument exposure	II.11-8
11.4 Metadata	II.11-20
11.5 Assessment of urban effects	II.11-22
11.6 Summary of key points for urban stations	II.11-22
References and further reading	II.11-24
 CHAPTER 12. ROAD METEOROLOGICAL MEASUREMENTS	 II.12-1
12.1 General.....	II.12-1
12.2 Establishment of a road meteorological station	II.12-2
12.3 Observed variables	II.12-8
12.4 Choosing the road weather station equipment.....	II.12-5
12.5 Message coding	II.12-6
12.6 Central control and data-acquisition computer	II.12-6
12.7 Communications considerations.....	II.12-7
12.8 Sensor signal processing and alarm generation.....	II.12-7
12.9 Measurement quality control	II.12-7
12.10 Road weather station maintenance	II.12-8
12.11 Training	II.12-9
References and further reading	II.12-10

CHAPTER 1

MEASUREMENTS AT AUTOMATIC WEATHER STATIONS

1.1 GENERAL

1.1.1 Definition

An automatic weather station (AWS) is defined as a “meteorological station at which observations are made and transmitted automatically” (WMO, 1992*a*).

At an AWS, the instrument measurements are read out or received by a central data-acquisition unit. The collected data from the autonomous measuring devices can be processed locally at the AWS or elsewhere, for example, at the central processor of the network (WMO, 1989*a*). Automatic weather stations may be designed as an integrated concept of various measuring devices in combination with the data-acquisition and processing units. Such a combined system of instruments, interfaces and processing and transmission units is usually called an automated weather observing system (AWOS) or automated surface observing system (ASOS). It has become common practice to refer to such a system as an AWS, although it is not a “station” fully in line with the stated definition. Nevertheless, throughout this chapter, an AWS may refer to just such a system.

1.1.2 Purpose

Automatic weather stations are used for increasing the number and reliability of surface observations. They achieve this by:

- (a) Increasing the density of an existing network by providing data from new sites and from sites that are difficult to access and inhospitable;
- (b) Supplying, for manned stations, data outside the normal working hours;
- (c) Increasing the reliability of measurements by using sophisticated technology and modern, digital measurement techniques;
- (d) Ensuring the homogeneity of networks by standardizing the measuring techniques;
- (e) Satisfying new observational needs and requirements;
- (f) Reducing human errors;
- (g) Lowering operational costs by reducing the number of observers;
- (h) Measuring and reporting with high frequency or continuously.

1.1.3 Meteorological requirements

The general requirements, types, location and composition, frequency and timing of observations are described in WMO (1988*a*; 2003*a*).

Considering that AWSs are fully accepted as meteorological stations when providing data with accuracy comparable to that of conventional stations, the accuracy requirements given in Part I, Chapter 1 of the Guide may also be applied, as appropriate, to AWSs.

The guidance provided in this chapter must be used in conjunction with the chapters on measurements of the various meteorological variables in Part I and, in particular, with the chapters on quality management (Chapter 1), sampling (Chapter 2) and data reduction (Chapter 3) in Part III.

The development and installation of AWSs should be the result of a definite, coordinated plan for getting data to users in the format required. To achieve this, negotiations should first be undertaken with the users to draw up a list of all functional requirements and to develop practical means of fulfilling them.

Furthermore, it is not always satisfactory to rely on equipment suppliers to determine operational requirements. The Commission for Instruments and Methods of Observation (CIMO) gives the following advice to Members of WMO and, by inference, to any Service taking meteorological measurements.

When considering the introduction of new AWS instrument systems, Meteorological Services should:¹

- (a) Introduce into service only those systems that are sufficiently well documented so as to provide adequate knowledge and understanding of their capabilities, characteristics and any algorithms used;
- (b) Retain or develop sufficient technical expertise to enable them to specify system requirements and to assess the appropriateness of the

¹ Recommended by the Commission for Instruments and Methods of Observation at its twelfth session (1998) through Recommendation 2 (CIMO-XII).

capabilities and characteristics of such systems and algorithms used therein;²

- (c) Explore fully user requirements and engage users in system design of AWSs;
- (d) Engage users in validation and evaluation of the new automated systems;
- (e) Engage manufacturers in the system assessment and need for improvements in performance;
- (f) Develop detailed guides and documentation on the systems to support all users;
- (g) Develop adequate programmes for maintenance and calibration support of the AWSs;
- (h) Consult and cooperate with users, such as aeronautical authorities, throughout the process from AWS design, to implementation, to operational use;
- (i) Develop and apply reporting methods for national use to accommodate both observations generated by traditional and automated systems.

With respect to the automation of traditional visual and subjective observations, and future changes in reporting code, Meteorological Services should improve their definition of requirements with respect to:³

- (a) Areas of application for which data are no longer required;
- (b) Areas of application for which different or new data are needed;
- (c) Prioritizing the requirements for data to be provided by AWSs.

When considering the development and application of algorithms for AWSs, Meteorological Services should:⁴

- (a) Encourage instrument and system designers to work closely with relevant users to understand fully user requirements and concerns;
- (b) Work together with system designers to publish and disseminate, for widespread use and possible standardization, descriptions of the data-processing algorithms used in their systems to derive meteorological variables;
- (c) Test and evaluate thoroughly new algorithms and systems being introduced and disseminate the test results in the form of performance

characteristics to users of the observations;

- (d) Evaluate thoroughly, through field testing and intercomparison, the relationship of new algorithms and systems to previous methods, and establish transfer functions for use in providing data continuity and homogeneity, and disseminate these data to users.

1.1.4 **Climatological requirements⁵**

Where a proposed automatic station has a role in providing data for climatological records, it is important for the integrity, homogeneity and utility of the climate data sets that the following areas be considered for action (see WMO, 1993):

- (a) In cases where an AWS replaces a manual observing system that has been in operation for a long time, a sufficient overlap in observation systems to facilitate maintaining the homogeneity of the historical record must be assured.⁶ The overlap time is dependent on the different measured variables and on the climate region. In tropical regions and islands, the overlap time could be shorter than in extratropical and mountainous regions. The following general guidelines are suggested for a sufficient operational overlap between existing and new automated systems:
 - (i) Wind speed and direction: 12 months
 - (ii) Temperature, humidity, sunshine, evaporation: 24 months
 - (iii) Precipitation: 60 months
 (It will often be advantageous to have an ombrometer operated in parallel with the automatic raingauge.)
 A useful compromise would be an overlap period of 24 months (i.e. two seasonal cycles);
- (b) Accurate metadata should be maintained for each AWS installation;⁷
- (c) Procedures should be standardized for quality assurance and processing of data from AWSs (see section 1.3.2.8);
- (d) The existing and future requirements of climate data users should be defined precisely and considered in developing statements of requirement for automated observations by AWSs;⁸

2 Recommended by the Commission for Instruments and Methods of Observation at its twelfth session (1998) through Recommendation 2 (CIMO-XII).

3 Recommended by the Commission for Instruments and Methods of Observation at its twelfth session (1998) through Recommendation 5 (CIMO-XII).

4 Recommended by the Commission for Instruments and Methods of Observation at its twelfth session (1998) through Recommendation 2 (CIMO-XII)

5 Recommended by the Commission for Instruments and Methods of Observation at the twelfth session, 1998, through Recommendation 3 (CIMO-XII).

6 Note also WMO (1989a), section 3.2.1.4.4.4(c) "one year of parallel measurements is not enough; three years are a minimum, and five are preferable".

7 See Part I, Chapter 1, section 1.1.3.

8 See Part I, Chapter 1, Annex 1.B.

- (e) Climate users should be trained in the most effective use of AWS data;⁹
- (f) Specifications for a standardized climatological AWS should be developed which would record a basic set of climate variables such as temperature, precipitation, pressure and wind. Standardized water vapour measurements should be included due to the significance of this parameter in climate-change studies. Extreme values of all variables should be accurately and consistently recorded in a way that can be precisely related to older, manually-observed, data.¹⁰

1.1.5 **Types of automatic weather stations**

Automatic weather stations are used to satisfy several needs, ranging from a simple aid-to-the-observer at manned stations to complete replacement of observers at fully automatic stations. It is possible to classify AWSs into a number of functional groups; these frequently overlap each other, however, and the classification then begins to break down. A general classification could include stations that provide data in real time and those that record data for non-real-time or off-line analysis. It is not unusual, however, for both of these functions to be discharged by the same AWS.

Real-time AWS: A station providing data to users of meteorological observations in real time, typically at programmed times, but also in emergency conditions or upon external request. Typical real-time use of an AWS is the provision of synoptic data and the monitoring of critical warning states such as storms and river or tide levels.

Off-line AWS: A station recording data on site on internal or external data storage devices possibly combined with a display of actual data. The intervention of an observer is required to send stored data to the remote data user. Typical stations are climatological and simple aid-to-the-observer stations.

Both types of stations can optionally be set up with means both for manual entry and for the editing of visual or subjective observations that cannot yet be made fully automatically. This includes present and past weather or observations that involve high costs, such as cloud height and visibility. Such a

station could be described as partially or semi-automated.

Since AWSs can be very expensive, the stations' facilities can also be used to satisfy the common and specific needs and requirements of several applications, such as synoptic, aeronautical and agricultural meteorology, hydrology and climatology. They may also be used for special purposes, such as nuclear power safety, air and water quality, and road meteorology. Some AWSs are, therefore, multipurpose AWSs.

1.1.6 **Networking**

An AWS usually forms part of a network of meteorological stations, each transmitting its processed data to a central network processing system by various data transmission means. As the tasks to be executed by this central system are strongly related, and often complementary, to the tasks of the AWSs, the functional and technical requirements of both the central system and the AWSs should be very well coordinated.

When planning the installation and operation of a network of AWSs, it is of the utmost importance to consider the various problems associated with maintenance and calibration facilities, their organization and the training and education of technical staff. Network density considerations are beyond the scope of this Guide as they depend on the specific applications. However, the optimum siting and exposure of stations have an important influence on the performance of the stations and must be studied before they are installed.

1.2 **AUTOMATIC WEATHER STATION HARDWARE**

An AWS may consist of an integrated AWOS (and data-acquisition system) or a set of autonomous measuring devices connected to a data-collection and transmission unit. The layout of an AWS typically consists of the following:

- (a) On a standard observing area, preferably no smaller than 25 m x 25 m (Part I, Chapter 1, and WMO, 1989a), a series of automated sensors sited at the recommended positions and interconnected to one or more data collection units using interfaces, or for an AWOS, a set of sensors installed in close combination, but not affecting each other, directly connected to a central processing unit (CPU)

⁹ For example, see WMO (1997), especially Part II – "Implementation and user training considerations".

¹⁰ Ibid.

- by means of shielded cables, fibre optics, or radio links;
- (b) A CPU for sensor data-acquisition and conversion into a computer-readable format, proper processing of data by means of a microprocessor-based system in accordance with specified algorithms, the temporary storage of processed data, and their transmission to remote users of meteorological information;
 - (c) Peripheral equipment such as a stabilized power supply providing power to the various parts of the station, a real-time clock, and built-in test equipment for automatic monitoring of the status of vital parts of the station. For specific applications, local terminals for the manual entry and editing of data, display devices and printers, or recorders are added to the station.

The growing interaction between society and the atmosphere results in changing and growing requirements, such as demands for more stations and more variables to be measured, transmission at more frequent intervals, new formats and better performance. As a consequence, existing AWS hardware and software have to be adapted to new requirements. This can be carried out only if the AWS is well planned on a modular basis. Adaptation processes and tests are often more complicated than expected. A well-planned AWS includes pre-tested options that allow changes in the configuration and the system parameters. Other desirable features include spare power capacity, space in installation frames, spare communication interfaces, spare processing capacity and a flexible software environment. Guidance on preparing a functional specification for the AWS system is available in Part I of WMO (1997).

1.2.1 **Sensors**

The meteorological requirements for sensors used at AWSs are not very different from those of sensors at manual observation stations. See also the recommendations in the relevant chapters in Part I of this Guide. Because measurements at most AWSs are controlled from long distances, these sensors must be robust, fairly maintenance-free and should have no intrinsic bias or uncertainty in the way in which they sample the variables to be measured. In general, all sensors with an electrical output are suitable. A large number of sensors of varying performance and quality (and price) are suitable for use with automatic data-acquisition systems. There are frequent new developments, some enhancing the performance of existing sensors, while others are often based on new physical principles. Depending

on their output characteristics, sensors can be classified as analogue, digital and “intelligent” sensors.

Analogue sensors: Sensor output is commonly in the form of voltage, current, charge, resistance or capacitance. Signal conditioning converts these basic signals into voltage signals.

Digital sensors: Sensors with digital signal outputs with information contained in a bit or group of bits, and sensors with pulse or frequency output.

“Intelligent” sensors/transducers: Sensors including a microprocessor performing basic data-acquisition and processing functions and providing an output in serial digital or parallel form.

With regard to meteorological sensors, Part I of this Guide gives a full description of general aspects, types of sensors, methods of measurement, units, scales, exposure, sources of error, calibration and maintenance. CIMO assists Members through the regular organization of international instrument intercomparisons. The results can be very valuable for evaluating different measuring approaches. Since 1968, CIMO has been using questionnaires to obtain information on instrument development, and a report, entitled the *Instrument Development Inquiry*, is published every four years. The reports contain information on both instruments under development and instruments put into operational use. Information on new developments and operational experience can be found in the proceedings of national symposiums, magazines and journals, and also in the proceedings of the technical conferences organized regularly by CIMO. These technical conferences are accompanied by an exhibition of meteorological instrumentation where manufacturers present their latest developments. The results of CIMO intercomparisons, the *Instrument Development Inquiry* reports and the proceedings of CIMO technical conferences are published by WMO in the Instruments and Observing Methods reports series. The direct exchange of experience between operators of AWS networks, in particular those operating stations in similar environmental conditions, is recommended as another way of obtaining information.

Some specific considerations concerning AWS sensors are given in the following paragraphs. Achievable operational accuracies are given in Annex 1.B¹¹ of Chapter 1, Part I, of the Guide. As

11 As specified by the Meeting of Experts on Operational Accuracy Requirements (1991) and approved by the forty-fourth session of the Executive Council (1992) for inclusion in this Guide.

experimental results become available, these estimates will be updated by CIMO, as appropriate. Sensor (laboratory) calibration accuracy should be better by a factor of at least two, allowing for transformation to linear response functions. Sensor resolution should be better by a factor of about three than the stated requirement (which includes the performance of the interface).

Atmospheric pressure: A wide variety of devices exists, mostly based upon the use of an aneroid capsule, vibrating wire, or quartz crystal which provide an output in electrical analogue or digital form. For digital sensors, reference is made to WMO (1992b). The main problems to be carefully considered by the designer or specifier of an AWS are the adverse effects of temperature, long-term drift, vibration and exposure. Temperature effects are severe and are not always fully compensated by built-in temperature compensation circuits. AWS pressure sensors have an intrinsic long-term drift in accuracy, typically less than 0.2 to 0.3 hPa every six months and therefore require, regular calibration. The effects of vibration and mechanical shocks on the output of pressure sensors are important, especially where marine AWS applications are concerned. Because of the vulnerability of most readily available pressure sensors to the effects of external exposure, it is common practice to house the pressure instrument within a sealed and thermo-stabilized small box inside the CPU enclosure. In some countries, the sensor is connected to the outside of the box via a tube equipped with a static pressure head. For aeronautical applications or at remote stations, where a high degree of accuracy and reliability are required, two or more pressure sensors are incorporated in the station.

Part I, Chapter 3 gives guidelines on the use of digital barometers with AWSs.

Temperature: The most common types of thermometers used in an AWS are pure metal resistance thermometers or thermistors. The platinum resistance thermometer (100 Ω at 0°C) shows very good long-term stability and can be considered as the preferred type of sensor.

Electrical thermometers usually have a short time-constant and, when sampled by fast electronic circuits, their output reflects high-frequency low amplitude fluctuations of the local temperature. This problem can be avoided by using sensors with a long time-constant, by artificially damping the response with a suitable circuit to increase the time-constant of the output signal, or by averaging

digitally the sampled outputs in the CPU. Resistance thermometers require linearization. This can be obtained by appropriate circuits in signal conditioning modules, or by software algorithms. It is highly recommended that the thermistor characteristics should be linearized. Of great concern is the proper protection of the sensor against the effects of radiation. Radiation shields adjusted to the size of the sensor are widely used and replace the common naturally ventilated Stevenson screen in an AWS. For accurate measurements, the radiation shields should be artificially ventilated with an air speed of about 3 m s⁻¹, but precautions should be taken to prevent the entry of aerosols and drizzle in order to avoid wet-bulb effects.

Humidity: A very comprehensive overview of humidity sensors for use in an AWS can be found in WMO (1989b).

Although relatively low-cost resistance and capacitive sensors for direct relative humidity measurements are widely employed in AWSs, they are still susceptible to poor performance in the presence of pollutants and require special protection filters. Intercomparisons reveal that additional corrections have to be applied for measurements below 0°C, even if the sensors incorporate temperature compensation circuits and if hysteresis problems occur when exposed to saturated conditions.

Dew-point meters, such as the saturated lithium chloride sensor and the chilled mirror sensor, are also used in an AWS. The major drawback of lithium chloride sensors is their sensitivity to power failures; they require field interventions after a power interruption. The optical dewpoint meter is considered as the most promising technique, but further investigations are required in order to develop a good automatic mirror-cleaning device.

The problems associated with the short time-constant of many humidity sensors are more critical than for temperature sensors. As for temperature measurements, all types of sensors have to be installed in proper radiation shields. Preference should be given to aspirated or well-ventilated radiation shields. Shields may be similar in construction to those used for temperature measurements. Large errors can occur due to aspiration and cleaning problems.

Wind: The use of conventional cup or propeller anemometers with pulse or frequency output is widespread and presents no particular technical

problem other than that associated with icing in severe conditions. This complication can be overcome by heating the sensor in moderate icing conditions, but this results in a significant increase in electrical power consumption. It is recommended that, for new cup and propeller anemometers, the response length should be smaller than 5 m and that, in new digital systems, the sampling frequency must be compatible with the filtering applied. In counting devices, this implies that the number of pulses over one counting interval is considered as one sample.

The use of conventional analogue instruments equipped with a potentiometer for wind direction measurements is also widespread in AWSs. Wind-vane devices with digital angle encoders, usually in one or other form of Gray code, are increasingly used. Wind vanes with an undamped natural response length smaller than 10 m and a damping ratio between 0.3 and 0.7 are recommended. For vanes with digital encoders, a minimum resolution of 7 bits is required.

CIMO also recommends that, for new systems, it should be possible to report standard deviations of wind speed and direction with a resolution of 0.1 m s^{-1} and 10° , respectively.

A wind system with a serial digital output and one or more digital displays providing a direct visualization of the operational variables (wind peak, wind averages over two and 10 min, wind direction and extremes) is a typical example of an intelligent sensor.

Precipitation: The most common rainfall-measuring equipment in an AWS is the tipping-bucket raingauge. Gauges are rapidly clogged by debris such as leaves, sand or bird droppings; therefore, care must be taken with AWSs used for long unattended operations. For measurements of rain and snowfall below 0°C , different parts of the gauge must be heated properly. This can give rise to serious electrical power problems, in particular for battery-operated AWSs. Care should be taken since heated gauges introduce errors due to evaporation losses. An achievable observing accuracy of 5 to 10 per cent is considered to be excellent. Accuracy can be improved by surrounding the raingauge with a proper windshield (for example, a Nipher shield) (see WMO, 1994, for a comparison of precipitation sensors).

Sunshine: A number of sunshine duration recorders with electrical output are available. Reference is made to WMO (1989c). WMO has adopted a thresh-

old value of 120 W m^{-2} for bright sunshine of direct solar irradiance, thus solving a long-term problem. A drawback of a sunshine sensor for unattended use over long periods of time is that dirt accumulates on the front aperture which results in apparent changes in threshold.

Radiation: Most of the sensors used for these measurements at conventional stations can, in principle, be connected to an automatic system. The main technical problem is that these sensors are usually analogue devices that produce very small, continuously variable voltages as signal output. These voltages are very vulnerable to electromagnetic interference on the signal cables and adequate measurements have to be taken. The problem of contamination of the front aperture is even more severe for radiation measurements (which are absolute measurements) than for bright sunshine. Dust deposits on uncleaned pyranometer domes are considered to give a 2 per cent loss of accuracy (excluding days with frost and dew). As a result, the effective use of radiation instruments at sites that are unattended for several days is hard to envisage. An achievable observing accuracy (daily mean) is of the order of 5 per cent.

Cloud height: The measurement of cloud height at an AWS is now mostly accomplished with the aid of (laser) ceilometers. Reference is made to WMO (1988b) for an evaluation of current systems. Difficulties are still experienced in processing automatically the signals from the sensors in order to produce accurate measurements of cloud base height under the wide range of conditions encountered in nature, in particular rain and snow. Another difficulty is that the sensors sample the cloud height only over a very small area of sky directly above the detector. When provided to a remote user, such information can present a dangerously incorrect picture of the state or coverage of the sky, especially if the data are to be used for aviation purposes. This may be overcome by the use of algorithms to estimate cloud cover during a 30 min processing interval. In some countries, the role of the ceilometer is, however, that of an aid to the observer who is watching the sky. Ceilometers normally require a significant amount of electrical power and cannot generally be used unless a conventional supply is available. Furthermore, their performance may be reduced or distorted by the accumulation of snow, dust or other forms of contamination on the window of the exit and front apertures of the optical or infrared beam.

Visibility: A wide variety of instruments is readily available for making visibility measurements at AWSs. Refer to WMO (1990a).

A distinction can be made between transmissometers and visibility meters. High accuracy transmissometers are mostly used at airports, while lower accuracy (and less expensive) backward, forward or integrated visibility meters are more common for other AWSs. Both types are available in versions which can be battery-powered and which can, therefore, be used at remote sites where primary alternating current or "mains" power is not available. However, they consume a considerable amount of electrical power and, unless supported by an auxiliary power source, it is not normally feasible to operate them for more than a few weeks without battery changes.

1.2.2 Central processing unit

The core of an AWS is its CPU. Its hardware configuration depends on the complexity and magnitude of the functions it has to perform and on whether a unique hardware solution exists. In general, the main functions of the CPU are data acquisition, data processing, data storage and data transmission.

In the majority of existing AWSs, all of these functions are carried out by one microprocessor-based system installed in a weather-proof enclosure as close as possible to the sensors, or at some local indoor location. If the unit is located near the sensors, on-site processing reduces the amount of data which must be transmitted and enables those data to be presented in a form suitable for direct connection to communication channels. In such cases, however, the CPU is vulnerable to power-supply failure and must be protected against the outdoor environment in which it must operate. If the unit can be located indoors, it can usually be connected to a mains supply and operated as if it were located in a normal office environment. However, such a configuration results in an increased number of long signal cables and appropriate signal conditioners.

Depending on local circumstances and requirements, the different functions of the CPU may also be executed by different units. In such cases, each unit has its own microprocessor and relevant software, can be installed at different places in the station, and can communicate with each other through well-established inter-processor data transfer links and procedures. They operate in a dependency relation, the data-processing unit being the independent unit. An example is the installation of one or more data-acquisition units in the field close to the sensors that are connected to the

data processing or transmission unit of the CPU by means of one or more telephone lines using digital data transmission. These units can consist of one sensor (for example, an intelligent sensor such as a laser ceilometer), a number of similar sensors (for example, thermometers), or a number of different sensors.

The rapid technological evolution of modern industrial data-acquisition and process-control systems opens up new possibilities for meteorological applications. The high degree of input/output modulation and flexibility, the drastically increased operating speed of microprocessors and, in particular, the availability of dedicated data-acquisition, process-control and telecommunications software make it possible to develop AWSs which can meet the diverse observation needs and requirements of various users. As a consequence, any description of an AWS can be soon out of date and has to be considered with reservation. With this in mind, the following paragraphs give a general idea of the state of the art.

1.2.2.1 Data acquisition

In general, the data-acquisition hardware is composed of:

- (a) Signal-conditioning hardware for preventing unwanted external sources of interference from influencing the raw sensor signals, for protecting the CPU electronics, and for adapting signals to make them suitable for further data processing;
- (b) Data-acquisition electronics with analogue and digital input channels and ports, scanning equipment and data conversion equipment to enter the signals into the CPU memory.

Signal conditioning

Signal conditioning is a vital function in the data-acquisition process and starts with the proper selection of cables and connectors for connecting the sensor to the data-acquisition electronics. It is further accomplished by means of different hardware modules. Taken over from industrial process control, several conditioning functions are now integrated into one removable module. The most convenient and, hence, most common location for installing these modules is on the terminal panels of sensor cables in the same waterproof enclosure as the data-acquisition electronics. Depending on the sensor and local circumstances, various signal-conditioning techniques are available.

Sensor cables: Electrical signals from the sensors entering a data-acquisition system might include unwanted noise. Whether this noise is troublesome depends upon the signal-to-noise ratio and the specific application. Digital signals are relatively immune to noise because of their discrete (and high-level) nature. In contrast, analogue signals are directly influenced by relatively low-level disturbances. The major noise transfer mechanisms include capacitive and inductive coupling. A method of reducing errors due to capacitive coupling is to employ shielded cables for which a conductive material (at ground potential) is placed between the signal cables and the interference source. The additional use of a pair of wires that are entwined is effective in reducing electromagnetic coupling.

Surge protection: When an AWS could be subject to unintentional high-voltage inputs, the installation of a protection mechanism is indispensable to avoid possible destruction of the equipment. High-voltage input can be induced from magnetic fields, static electricity and, especially, from lightning.

Two-wire transmitters: It is sometimes desirable to pre-amplify low-level signals close to the sensor to maintain a maximum signal-to-noise ratio. One way of performing this kind of signal conditioning is to use a two-wire transmitter. These transmitters not only amplify the input signal, but also provide isolation and conversion to a high-current level (typically 4 to 20 mA). Current transmission allows signals to be sent to a distance of up to about 1 500 m.

Digital isolation: Electrical modules are used to acquire digital input signals while breaking the galvanic connection between the signal source and the measuring equipment. The modules not only isolate, but also convert the inputs into standard voltage levels that can be read by the data-acquisition equipment.

Analogue isolation: Analogue isolation modules are used to protect equipment from contact with high voltages, the breaking of ground loops and the removal of large common-mode signals. Three types of analogue isolation are in wide use today: the low-cost capacitive coupling or "flying capacitor", the good performance and moderate cost optical coupling, and the high-isolation and accurate, but higher-cost, transformer coupling.

Low-pass filtering: Filters are used to separate desired signals from undesirable signals. Undesirable signals are noise, alternating current line frequency pick-up,

radio or television station interference, and signal frequencies above half the sampling frequency. Generally, a low-pass filter is employed to control these unwanted sources of error, excluding that portion of the frequency spectrum where desired signals do not exist.

Amplifiers: Analogue sensor signals can vary in amplitude over a wide range. The analogue-to-digital (A/D) converter, however, requires a high-level signal in order to perform best. In many cases, an amplifier module is used to boost possible low-level signals to the desired amplitude. Amplifier modules are also employed to standardize the voltage output of all sensors to a common voltage, for example 0-5 voltage direct current.

Resistances: Special modules are used to convert resistances, such as platinum thermometers, into a linearized output voltage signal and to provide the necessary output current for this conversion. It should be noted that the conversion to a linear signal can introduce inaccuracies, which can be critical for some applications.

Data-acquisition function

The data-acquisition function consists of scanning the output of sensors or sensor-conditioning modules at a predetermined rate, and translating the signals into a computer-readable format.

To accommodate the different types of meteorological sensors, the hardware for this function is composed of different types of input/output channels, covering the possible electrical output characteristics of sensors or signal-conditioning modules. The total number of channels of each type depends on the output characteristics of the sensors and is determined by the type of application.

Analogue inputs: The number of analogue channels is usually between 4 and 32. In general, a basic configuration can be extended by additional modules that provide more input channels. Analogue input channels are of particular significance as most of the commonly used meteorological sensors, such as temperature, pressure and humidity sensors deliver a voltage signal either directly or indirectly through the sensor-conditioning modules.

The data-acquisition tasks are the scanning of the channels and their A/D conversion. A scanner is simply a switch arrangement that allows many analogue input channels to be served by one A/D

converter. Software can control these switches to select any one channel for processing at a given time. The A/D converter transforms the original analogue information into computer readable data (digital, binary code). The A/D resolution is specified in terms of bits. An A/D resolution of 12 bits corresponds to approximately 0.025 per cent, 14 bits to 0.006 per cent, and 16 bit to 0.0015 per cent of the A/D full range or scale.

Parallel digital input/output: The total number of individual channels is mostly grouped in blocks of 8 out of 16 bits with extension possibilities. They are used for individual bit or status sensing or for input of sensors with parallel digital output (for example, wind vanes with Gray code output).

Pulses and frequencies: The number of channels is generally limited to two or four. Typical sensors are wind speed sensors and (tipping-bucket) raingauges. Use is made of low- and high-speed counters accumulating the pulses in CPU memories. A system that registers pulses or the on-off status of a transducer is known as an event recorder.

Serial digital ports: These are individual asynchronous serial input/output channels for data communication with intelligent sensors. The ports provide conventional inter-device communications over short (RS232, several metres) to long (RS422/485, several kilometres) distances. Different sensors or measuring systems can be on the same line and input port, and each of the sensors is addressed sequentially by means of coded words.

1.2.2.2 Data processing

The data-processing hardware is the heart of the CPU and its main functions are to act as the master control of the input/output of data to, and from, the CPU and to carry out the proper processing of all incoming data by means of the relevant software.

The hardware is operated by a microprocessor. Microprocessors do not change the principles of meteorological measurements or observing practices but they do allow the instrument designer to perform technical functions in a new way to make measurements easier, faster and more reliable, and to provide the instrument with higher capabilities, especially in data handling. The adoption of microprocessors considerably reduces hardware costs for some applications. It must be noted, however, that the expanded expectations which may be met by this device will lead very often to a fast-growing

and considerably underestimated cost of the development of software.

Existing AWOSs are equipped with 8-bit microprocessors and limited memory (32 to 64 kbytes). New systems using 16- or 32-bit microprocessors surrounded by a considerable amount of solid-state memory (up to 1 Mbyte) are becoming standard. These AWOSs provide more input/output facilities which operate at much higher processing speeds and are capable of performing complex computations. Together with new hardware, sophisticated software is applied which was, some years ago, available only in minicomputer systems. The unit can be equipped with different types of memories such as random access memories (RAM) for data and program storage, non-volatile programmable read-only memories (PROMs) for program storage (programs are entered by means of a PROM programmer), and non-volatile electrically erasable PROMs (EEPROMs) mostly used for the storage of constants which can be modified directly by software. At most stations, the RAM memory is equipped with a battery backup to avoid loss of data during power failures. At non-real-time stations without data transmission facilities, data can be stored in external memories. Mechanical devices with tapes which were used for this purpose for many years are now replaced by memory cards (RAM with battery backup, EEPROMs, etc.), which have a much higher reliability.

1.2.2.3 Data transmission

The data transmission part of the CPU forms the link with the "outside world", which may be the local observer or the maintenance personnel, the central network processing system of the National Meteorological and Hydrological Service, or even directly the users of meteorological information. The equipment is interfaced to the CPU by using commonly available serial and parallel input/output ports. The most suitable means of data transmission depends mainly on the site in question and the readily available transmission equipment. No single solution can be regarded as universally superior, and sometimes the transmission chain requires the use of several means (see section 1.3.2.10).

1.2.3 Peripheral equipment

Power supply: The design and capability of an AWS depend critically upon the method used to power it. The most important characteristics of an AWS power supply are high stability and interference-free operation. For safety reasons, and because of the widespread use and common availability of 12 V batteries in motor vehicles, consideration should be

given to the use of 12 V direct current power. Where mains power is available, the 12 V batteries could be float-charged from the main supply. Such a system provides the advantage of automatic backup power in the event of a mains power failure. Automatic weather stations deployed at remote sites where no mains power is available must rely upon batteries that may, or may not, be charged by an auxiliary power source, such as a diesel generator, wind- or water-driven generator, or solar cells. However, such low-power systems cannot, in general, support the more complex sensors required for cloud height and visibility measurements, which require large amounts of power. Furthermore, AWSs with auxiliary equipment such as heaters (anemometers, raingauges) and aspirators can also consume considerable power, thus restricting the installation of an AWS to locations where mains power is available. If, because of the need for a versatile and comprehensive system, only the mains can supply sufficient power for full operation, provision should be made for support, from a backup supply, of at least the system clock, the processor and any volatile memory that may contain recent data needed to restart the station automatically.

Real-time clock: An essential part of data processing is a 24 h real-time clock powered by a battery, which ensures that the time is kept even during power outages. Ensuring the accuracy of actual AWS clocks requires special attention to guarantee correct read-outs, sample intervals and time stamps. At some AWSs, devices are used to synchronize the clock with broadcast radio time reference signals or the Global Positioning System.

Built-in test equipment: Vital parts of an AWS often include components whose faulty operation or failure would seriously degrade or render useless the principal output. The inclusion of circuits to monitor automatically these components' status is an effective means of continuously controlling their performance during operation. Examples are: a power-failure detector which restarts the processor and continues the AWS function after a power failure; a "watchdog" timer to monitor the proper operation of microprocessors; and test circuits for monitoring the operation of station subsystems such as battery voltage and charger operation, aspirators (temperature and humidity screens), A/D converters, heaters, etc. Status information can be automatically displayed on site or input into the CPU for quality-control and maintenance purposes.

Local display and terminals: Operational requirements often require observations to be entered or edited manually, for example at semi-automatic

weather stations. Depending on the requirements, and on the station designer, different types of local terminals are used for this purpose, including a simple numerical light-emitting diode (LED) display with keyboard forming an integral part of the CPU, a screen with keyboard, or even a small personal computer installed at some distant indoor location. For maintenance purposes, special hand-held terminals are sometimes used which can be plugged directly into the station. For particular applications, such as AWSs at airports or simple aid-to-the-observer stations, digital displays are connected for the visualization of data at one or more places at the site. On request, a printer or graphical recorders can be added to the station.

1.3 **AUTOMATIC WEATHER STATION SOFTWARE**

When designing or specifying an AWS it is a guiding principle that the cost of developing and testing the software will be one of the largest financial elements in the package. Unless great care is exercised in the preliminary design and strong discipline maintained while coding, complex software readily become inflexible and difficult to maintain. Minor changes to the requirements — such as those often induced by the need for a new sensor, code changes, or changes in quality-control criteria — may often result in major and very expensive software revisions.

In general, a distinction can be made between application software consisting of algorithms for the proper processing of data in accordance with user specifications, and system software inherently related to the microprocessor configuration and comprising all software to develop and run application programs.

Advice on the development of algorithms for AWSs is given in section 1.1.3 above. Discussion of the design of algorithms for synoptic AWSs is found in WMO (1987), and for the processing of surface wind data in WMO (1991). Information on the algorithms used by Members can be found in WMO (2003*b*). For detailed information on sampling, data reduction and quality management, the appropriate chapters in Part III should be consulted.

1.3.1 **System software**

The software for many existing AWSs is developed by the manufacturer in accordance with user requirements and is put into the CPU memory in a

non-readable format for the user (so-called firmware), thus turning the CPU into a sort of black box. The user can execute only predetermined commands and, as a consequence, depends entirely on the manufacturer in the event of malfunctions or modifications.

Fortunately, the increasing demand for data-acquisition systems for industrial process control has opened up new possibilities. Users can now develop their own application software (or leave it to a software company or even the manufacturer of the station) using programming languages like Basic, Pascal or, in particular, C, and using readily available utility packages for data acquisition, statistics, storage and transmission. The result is that the user acquires more insight into, and control over, the different processes and becomes consequently less dependent on the manufacturer of the station.

In recent systems, increasing use is made of well-proven real-time multitasking/multi-user operating systems, which were available only for minicomputers in the past. They are *real-time* because all operations are activated by hardware and software interrupts, *multitasking* because different tasks can be executed quasi-simultaneously following a predetermined priority, and *multi-user* because different users can have quasi-simultaneous access to the system. Software developers can give their full attention to the development of application programs in the language of their choice while leaving the very difficult and complex control and execution of tasks to the operating system.

1.3.2 Application software

The processing functions that must be carried out either by the CPU, the sensor interfaces, or a combination of both, depend to some extent on the type of AWS and on the purpose for which it is employed. Typically, however, some or all of the following operations are required: initialization, sampling of sensor output, conversion of sensor output to meteorological data, linearization, averaging, manual entry of observations, quality control, data reduction, message formatting and checking and data storage, transmission and display. The order in which these functions are arranged is only approximately sequential. Quality-control may be performed at different levels: immediately after sampling, after deriving meteorological variables, or after the manual entry of data and message formatting. If there are no checks on data quality-control and message content, the AWS data are likely to contain undetected errors. While linearization may be inherent in the sensor or

signal-conditioning module, it should always be carried out before the calculation of an average value.

The execution of the application software is governed by a schedule that controls when specific tasks must be executed. The overview of AWS application software in the following paragraphs is limited to some practical aspects related to AWSs.

1.3.2.1 Initialization

Initialization is the process that prepares all memories, sets all operational parameters and starts running the application software. In order to be able to start normal operations, the software first requires a number of specific parameters, such as, among others, those related to the station (station code number, altitude, latitude and longitude); date and time; physical location of the sensor in the data-acquisition section; type and characteristics of sensor-conditioning modules; conversion and linearization constants for sensor output conversion into meteorological values; absolute and rate of change limits for quality-control purposes; and data buffering file location. Depending on the station, all or part of these parameters may be locally input or modified by the user through interactive menus on a terminal. In the latest generation of AWSs, initialization may be executed remotely, for instance, by the central network processing system or by a remote personal computer. In addition to full initialization, a partial initialization should be programmed. This automatically restores normal operation, without any loss of stored data, after a temporary interruption caused by real-time clock setting, maintenance, calibration or power failure.

1.3.2.2 Sampling and filtering

Sampling can be defined as the process of obtaining a well-spaced sequence of measurements of a variable. To digitally process meteorological sensor signals, the question arises of how often the sensor outputs should be sampled. It is important to ensure that the sequence of samples adequately represents significant changes in the atmospheric variable being measured. A generally accepted rule of thumb is to sample at least once during the time-constant of the sensor. However, as some meteorological variables have high frequency components, proper filtering or smoothing should be accomplished first by selecting sensors with a suitable time-constant or by filtering and smoothing techniques in the signal-conditioning modules (see Part III, Chapter 2).

Considering the need for the interchangeability of sensors and homogeneity of observed data, it is recommended:¹²

- (a) That samples taken to compute averages should be obtained at equally spaced time intervals which:
 - (i) Do not exceed the time-constant of the sensor; or
 - (ii) Do not exceed the time-constant of an analogue low-pass filter following the linearized output of a fast response sensor; or
 - (iii) Are sufficient in number to ensure that the uncertainty of the average of the samples is reduced to an acceptable level, for example, smaller than the required accuracy of the average;
- (b) That samples to be used in estimating extremes of fluctuations should be taken at least four times as often as specified in (i) or (ii) above.

1.3.2.3 Raw-data conversion

The conversion of raw sensor data consists of the transformation of the electrical output values of sensors or signal-conditioning modules into meteorological units. The process involves the application of conversion algorithms making use of constants and relations obtained during calibration procedures.

An important consideration is that some sensors are inherently non-linear, namely their outputs are not directly proportional to the measured atmospheric variables (for example, a resistance thermometer), that some measurements are influenced by external variables in a non-linear relation (for example, some pressure and humidity sensors are influenced by the temperature) and that, although the sensor itself may be linear or incorporate linearization circuits, the variables measured are not linearly related to the atmospheric variable of interest (for example, the output of a rotating beam ceilometer with photo detector and shaft-angle encoder providing backscattered light intensity as a function of angle is nonlinear in cloud height). As a consequence, it is necessary to include corrections for non-linearity in the conversion algorithms as far as this is not already done by signal-conditioning modules. Linearization is of particular importance when mean values must be calculated over a certain time. Indeed, when the sensor signal is not constant throughout the averaging period, the “average then linearize”

sequence of operations can produce different results from the “linearize then average” sequence. The correct procedure is to only average linear variables.

1.3.2.4 Instantaneous meteorological values

The natural small-scale variability of the atmosphere, the introduction of noise into the measurement process by electronic devices and, in particular, the use of sensors with short time-constants make averaging a most desirable process for reducing the uncertainty of reported data.

In order to standardize averaging algorithms it is recommended:¹³

- (a) That atmospheric pressure, air temperature, air humidity, sea-surface temperature, visibility, among others, be reported as 1 to 10 min averages, which are obtained after linearization of the sensor output;
- (b) That wind, except wind gusts, be reported as 2 or 10 min averages, which are obtained after linearization of the sensor output.

These averaged values are to be considered as the “instantaneous” values of meteorological variables for use in most operational applications and should not be confused with the raw instantaneous sensor samples or the mean values over longer periods of time required from some applications. One-minute averages, as far as applicable, are suggested for most variables as suitable instantaneous values. Exceptions are wind (see (b) above) and wave measurements (10 or 20 min averages). Considering the discrepancy of observations between the peak gust data obtained from wind measuring systems with different time responses, it is recommended that the filtering characteristics of a wind measuring chain should be such that the reported peak gust should represent a 3 s average. The highest 3 s average should be reported. In practice, this entails sampling the sensor output and calculating the 3 s running mean at least one to four times a second.

Some specific quantities for which data conversion is necessary and averaging is required before conversion are given in Part III, Chapter 2.

1.3.2.5 Manual entry of observations

For some applications, interactive terminal routines have to be developed to allow an observer to enter and edit visual or subjective observations

¹² Recommended by the Commission for Instruments and Methods of Observation at its tenth session (1989) through Recommendation 3 (CIMO-X).

¹³ Recommended by the Commission for Instruments and Methods of Observation at its ninth session (1985) through Recommendation 6 (CIMO-IX).

for which no automatic sensors are provided at the station. These typically include present and past weather, state of the ground and other special phenomena.

1.3.2.6 Data reduction

Beside instantaneous meteorological data, directly obtained from the sampled data after appropriate conversion, other operational meteorological variables are to be derived and statistical quantities calculated. Most of them are based on stored instantaneous values, while, for others, data are obtained at a higher sampling rate, as for instance is the case for wind gust computations. Examples of data reduction are the calculation of dew-point temperature values from the original relative humidity and air temperature measurements and the reduction of pressure to mean sea level. Statistical data include data extremes over one or more time periods (for example, temperature), total amounts (for example, rain) over specific periods of time (from minutes to days), means over different time periods (climatological data), and integrated values (radiation). These variables or quantities can be computed at an AWS or at a central network processing system where more processing power is normally available.

CIMO is involved in an extensive programme to survey and standardize algorithms for all variables. The results are published in the WMO Instruments and Observing Methods Reports (WMO, 2003*b*).

Formal recommendations exist for the computation of pressure tendency¹⁴ and humidity quantities¹⁵ (Annex 4.B, Chapter 4, Part I).

WMO investigated the methods for pressure reduction used by Members in 1952 (WMO, 1954) and concluded that the “international formula” (using the formula of Laplace or Angot’s tables) or some “simplified” methods are in practice (for example, for “low-level” stations¹⁶, see, Part I, Chapter 3). As a result of this inquiry, a study of the standardization of methods of reduction was undertaken and one general equation of pressure

reduction was recommended as standard¹⁷ (WMO, 1964). Nevertheless, this recommended method, the “international formula” and methods using simplified formulae are still in common practice (WMO, 1968).

1.3.2.7 Message coding

Functional requirements often stipulate the coding of meteorological messages in accordance with WMO (1995). Depending on the type of message and the elements to be coded, the messages can be generated fully or semi-automatically. Generating fully automatic messages implies that all elements to be coded are measurable data, while generating semi-automatic messages involves the intervention of an observer for entering visual or objective observations, such as present and past weather, the state of the ground, and cloud type. Message coding algorithms should not be underestimated and require considerable efforts not only for their development but also for updating when formats are altered by international, regional and national regulations. They also occupy a considerable amount of memory that can be critical for small performance stations. It should be noted that observational data could be transmitted to the central network processing system, where more computer power is normally available for message coding.

1.3.2.8 Quality control

The purpose of quality-control at an AWS is to minimize automatically the number of inaccurate observations and the number of missing observations by using appropriate hardware and software routines. Both purposes are served by ensuring that each observation is computed from a reasonably large number of quality-controlled data samples. In this way, samples with large spurious errors can be isolated and excluded and the computation can still proceed, uncontaminated by that sample.

Quality-control achieves assured quality and consistency of data output. It is achieved through a carefully designed set of procedures focused on good maintenance practices, repair, calibration, and data quality checks. Currently, there is no agreed set of procedures or standards for the various AWS platforms. Such a set of procedures should be developed and documented.

14 Recommended by the Commission for Instruments and Methods of Observation at its ninth session (1985) through Recommendation 7 (CIMO-IX).

15 Recommended by the Commission for Instruments and Methods of Observation at its tenth session (1989) through Recommendation 7 (CIMO-X).

16 Recommended by the Commission for Instruments and Methods of Observation at its first session (1953) through Recommendation 13 (CIMO-I) and adopted by EC-IV.

17 Based on the recommendations by the CIMO-I Working Committee II on “Reduction of Pressure” (WMO, 1954, Part 2).

In modern AWSs, the results of data quality-control procedures for sensors which reveal the reasons why a measurement is suspect or erroneous, and the results of hardware self-checks by built-in test equipment, are stored in appropriate housekeeping buffers. The visual display of these status indicators forms a very handy tool during field maintenance. The transmission of housekeeping buffers – either as an appendix to the routine observational message, or as a clocked or on-request housekeeping message, from a network of AWSs to a central network processing system – is a valuable possible approach to the maintenance of meteorological equipment.

Real-time procedures for the quality-control of AWS data are highly advisable, and detailed recommendations exist in Part III, Chapter 1, and as basic quality-control procedures in WMO (1993). The following is a practical elaboration of the recommendations.

Intra-sensor checks

Intra-sensor checks: This is when each sensor sample is checked at the earliest practical point in the processing, taking into account sensor and signal-conditioning response functions, for a plausible value and a plausible rate of change.

Plausible value: This is a gross check that the measured value lies within the absolute limits of variability. These limits are related to the nature of the meteorological variable or phenomena but depend also on the measuring range of selected sensors and data-acquisition hardware. Additional checks against limits which are functions of geographical area, season and time of year could be applied. Suggested limits for these additional checks are presented in Tables 6.3–6.9 in Chapter 6 of WMO (1993). The checks provide information as to whether the values are erroneous or suspect.

Plausible rate of change: This checks for a plausible rate of change from a preceding acceptable level. The effectiveness of the check depends upon the temporal consistency or persistence of the data and is best applied to data of high temporal resolution (high sampling rate) as the correlation between adjacent samples increases with the sampling rate. One obvious difficulty is determining how quickly an atmospheric variable can change taking into account the response characteristics of the sensor in question. Additional time consistency checks using comparisons of data between two consecutive reports can be made. WMO (1993) provides checking tolerances for

different time periods on the synoptic scales (1, 2, 3, 6, 12 h) for air temperature, dewpoint, and pressure tendency.

Inter-sensor checks

It is possible to make internal consistency checks of a variable against other variables, based upon established physical and meteorological principles. Some examples are as follows: dewpoint cannot exceed ambient temperature; precipitation without clouds overhead or just after they have passed overhead is very unlikely; non-zero wind-speed and zero wind-direction variance strongly suggest a wind-direction sensor problem; and zero average wind speed and non-zero wind direction (variance) suggest a defective wind-speed sensor.

Observations entered manually

When a manually observed quantity is entered into the AWS, the inter- and intra-sensor checks mentioned above can be conducted. Some special consistency checks are suggested in WMO (1993) concerning present weather with visibility; present weather with cloud cover; cloud cover, weather and cloud information; present weather with air temperature; present weather with dew-point temperature; height of clouds with types of clouds; and state of the sea with wind speed.

Hardware checks

During operation, the performance of an AWS deteriorates with the ageing of hardware components, exposure to untested situations, improper maintenance, product failure, and so on. Therefore, it is important to implement and execute automatically and periodically internal self-check features using built-in test equipment for AWS hardware and to make the results of these tests available to appropriate personnel or to store the results in housekeeping buffers. These buffers can be examined, and the information contained in them should be used to classify the measurements as correct, erroneous or suspect.

Message checking

For AWSs equipped with software for coding messages and for transmitting the messages over the Global Telecommunication System, it is of vital importance that all the above checks are executed very carefully. In addition, compliance with regulations concerning character, number, format, and so forth, should be controlled. Proper actions are to be

considered in cases of values that are classified as suspect.

1.3.2.9 Data storage

Processed and manually observed data, including quality-control status information (housekeeping data) must be buffered or stored for some time in the AWS. This involves a relevant database that must be updated in real time. The number of database cells and memory required is determined as a function of the maximum possible number of sensors, intermediate data, derived quantities and the required autonomy of the station. In general, a circular memory structure is adopted allowing the old data to be overwritten by new incoming data after a predetermined time. The database structure should allow easy and selective access by means of data transfer and transmission algorithms.

Depending on observational requirements and the type of station, the data can be transferred at regular time intervals from the AWS main memory to other kinds of storage devices, such as a removable memory.

1.3.2.10 Data transmission

Dictated by operational requirements and data transmission facilities, data transmission between an AWS and either local users or the central network processing system can operate in different modes, as follows:

- (a) In response to external commands, as this is the most common basic mode given that it allows more control of the station, such as initialization, setting and resetting of the real-time clock, inhibiting faulty sensors, selective database transfer, and so on. Upon reception and after transmission control of an external command, a task schedule activates the appropriate task or subroutine as requested by the command;
- (b) At periodic time intervals controlled by the AWS time scheduler;
- (c) In AWS emergency conditions when certain meteorological thresholds are crossed.

In general, readily available data transmission software packages can be used for proper data transfer and control and for transmission protocols. As data transmission means are subject to several interference sources, careful attention must be paid to adequate error coding, such as parity bits and cyclical redundancy codes. A brief review of some telecommunications options for establishing an AWS network follows.

One-way communications

A simple AWS network could use one-way communications where the remote stations operate on a timed cycle to scan the sensor channels, or otherwise when alarm conditions are triggered, to dial up over telephone lines the central control and data-acquisition computer, and having established the link, deliver their data messages. Each AWS might have a serial interface to an analogue modem, and data transmission would be at a rate, of say, 9 600 bits per second (bps) using audio tones. The advantage of this point-to-point communications system is that it uses well-established, simple technology and ordinary voice-grade telephone lines. The cost, which should be modest, depends on a tariff formula including distance and connection time. The drawbacks are that data security is only moderate; data volumes must be relatively low; no powerful network architectures can be used; and telecommunications companies may restrict future access to analogue data circuits as the technology moves inexorably to broadband digital networks.

Two-way communications

A more powerful network has two-way communications so that the central computer may poll the network stations, not only at the synoptic times, or hourly, but on a random access basis when a forecaster or hydrologist wishes to obtain a current update on weather conditions at a particular site or sites. The remote stations would initiate the procedure for sending their own alarm messages in real time. Two-way communication also enables the remote station to send command messages to change its mode of operation, or to have new operating software downloaded onto its processor.

Establishing the AWS network

The network might use landline or radio communications (especially for very remote sites) or a combination of both. The advantage of using a telecommunications service provider is that all responsibility for maintenance of the network service and probably the communications interfaces lies with the provider, who should respond promptly to the AWS system manager's fault reports. Note the need to be able to determine on which side of the communications interface (AWS or telecommunications circuits) the fault lies, which may be problematical. AWS networks have often used dial-up circuits in the Public Switched Telephone Network (PSTN), with costs related to distance and connect time, depending on the tariffs of the local communications provider. The other option is to have a

“private network” network based on dedicated leased lines of defined quality. There is no switching delay in establishing the circuits, higher transmission speeds are available, and there is a high certainty that the circuit will be maintained. The leasing costs depend on the line distances, but not on the volume of data. Costs are higher than for dial-up connections when the volume of data is fairly low.

Integrated services digital network

Many telecommunications authorities offer an integrated services digital network that provides for voice, data and video transmission with pulse-code modulation over upgraded PSTN cables and switches. A basic channel provides for 64 kbps data, which may carry X.25 packet-switch or frame-relay protocols. The digital circuits provide very high data security.

Wide area network communications

With the worldwide increase in data traffic and the use of modern communications protocols, together with the increased computing and data-storage capability at remote terminals, it is now common to view the remote AWS and the central control and data-acquisition computer as nodes of a wide area network (WAN). The data or control message is divided into “packets” according to rules (protocols) such as X.25 or the faster frame relay. Each data packet is routed through the telecommunication provider’s switched data network and may arrive at the destination by different routes (making efficient use of the network with other unrelated packets). At the destination, the packets are reassembled under the protocol after variable delays to reform the message. Error detection with the automatic resending of corrupted or lost packets ensures reliable transmission. Note the contrast with ordinary PSTN based on circuit-switching technology, in which a dedicated line is allocated for transmission between two parties. Circuit-switching is ideal when real-time data (like live audio and video) must be transmitted quickly and arrive in the same order in which it was sent. Packet switching is more efficient and robust for data that can withstand some short delay in transmission. Message costs are related to connect time and data volume. There should be a means to terminate the connection reliably when data collection is finished, as a faulty AWS may keep the line open and incur unwanted costs.

Frame relay and asynchronous transfer mode

Frame relay is a packet-switching, networking protocol for connecting devices on a WAN, operating at data speeds from 64 kbps to 2 Mbps or

higher, depending on line quality. Unlike a point-to-point private line, network switching occurs between the AWS and the central station. In fact, there is a private line to a node on the frame relay network, and the remote location has a private line to a nearby frame relay node. The user gets a “virtual private network”. Costs are decreasing and are independent of the volume of data or the spent time connected. However, frame relay is being replaced in some areas by newer, faster technologies, such as asynchronous transfer mode (ATM). The ATM protocol attempts to combine the best of both worlds – the guaranteed delivery of circuit-switched networks and the robustness and efficiency of packet-switching networks.

Transmission protocol

A de facto standard for transmission between computers over networks is the Transmission Control Protocol/Internet Protocol (TCP/IP). The Internet Protocol (IP) specifies the format of packets, called “datagrams” and the addressing scheme. The higher-level protocol TCP establishes a virtual connection between source and destination so that two-way data streams may be passed for a time and so that datagrams are delivered in the correct sequence with error correction by retransmission. The TCP also handles the movement of data between software applications. The functioning of the Internet is based on TCP/IP protocols, and the IP is also used in WANs, where the nodes have processing capability and high volumes of data are exchanged over the network. The IP enables the AWS data and road condition analyses performed in the central station computer to be shared by national and regional road administrations over a private Intranet.

Switched or dedicated circuits

It is necessary to decide whether to use cheaper switched data circuits where telecommunications network access has to be shared with other users, or to lease much more expensive dedicated circuits that provide reliable, high-speed, real-time communications. The switched network will have some latency where there will be a delay of as much as a few seconds in establishing the circuit, but packet-switch protocols handle this without difficulty. The reliability consideration, the amount of data to be exchanged with each message or special “downloads” to the remote stations, as well as the operational need for actual real-time communications, will help determine the choice. The seasonal factor will also have a bearing on the

choice of communications. If the critical use of the road meteorological data is only for a few months of the year, maintaining a year-round dedicated communications network imposes a high overhead cost per message. Actual message costs will depend on the charging formulas of the telecommunications company, and will include factors like data rate, distance of link, connection time and whether the terminal modems are provided by the company. The local telecommunications companies will be ready to offer guidance on the choice of their services.

1.3.2.11 Maintenance and calibration

Specific software routines are incorporated in the application software allowing field maintenance and calibration. Such activities generally involve running interactive programs for testing a particular sensor, AWS reconfiguration after the replacement of sensors or models, resetting of system parameters, telecommunication tests, entering new calibration constants, and so on. In general, maintenance and calibration is conducted in an off-line mode of operation, temporarily interrupting the normal station operation.

1.3.2.12 Data display

In addition to data display routines for the different functions mentioned in the above paragraphs, operational requirements often specify that selected data should be displayed locally with periodic updating in real time or, on LED displays, existing terminals, or on special screens. Examples of this are AWSs at airports and at environmental control sites. In some countries, a printout of local data or a graphical display on pen recorders is required.

1.4 AUTOMATIC WEATHER STATION SITING CONSIDERATIONS

The siting of an AWS is a very difficult matter and much research remains to be done in this area. The general principle is that a station should provide measurements that are, and remain, representative of the surrounding area, the size of which depends on the meteorological application. Existing guidelines for conventional stations are also valid for AWSs and are given in Part I as well as in WMO (1989*a*; 1990*b*; 2003*a*).

Some AWSs have to operate unattended for long periods at sites with difficult access both on land and

at sea. Construction costs can be high and extra costs can be necessary for servicing. They may have to operate from highly unreliable power supplies or from sites at which no permanent power supply is available. The availability of telecommunication facilities should be considered. Security measures (against lightning, flooding, theft, vandalism, and so forth) are to be taken into account and the stations must, of course, be able to withstand severe meteorological conditions. The cost of providing systems capable of operating under all foreseen circumstances at an automatic station is prohibitive; it is essential that, before specifying or designing an AWS, a thorough understanding of the working environment anticipated for the AWS be obtained. At an early stage of planning, there should be a detailed analysis of the relative importance of the meteorological and technical requirements so that sites can be chosen and approved as suitable before significant installation investment is made.

1.5 CENTRAL NETWORK DATA PROCESSING

An AWS usually forms part of a network of meteorological stations and transmits its processed data or messages to a central network processing system by various data telecommunication means. The specification of the functional and, consequently, the technical requirements of a central system is a complex and often underestimated task. It requires good cooperation between AWS designers, specialists in telecommunication, software specialists, and data users. Decisions have to be taken concerning the tasks that must be executed in the central system and at the AWSs. In fact, depending on the application, certain functions at an AWS could be transferred to the central system where more computer power and memory are available. Examples are long mathematical calculations, such as the reduction of atmospheric pressure and coding of meteorological messages. The AWS data buffers can be reduced to an operational minimum when they are regularly transferred to the central system. It is good practice to first arrange for an agreement on the functional requirements of both the central system and the AWS before specifying their technical requirements.

1.5.1 Composition

The composition of a central network processing system depends considerably not only on the functions to be accomplished, but also on local facilities. Use can be made of powerful personal computers or workstations, operating in a real-time multitasking

and multi-user environment. However, existing telecommunication and processing systems are used. Central network processing systems are increasingly integrated into a local area network allowing distribution and execution of tasks at the most convenient place by the most appropriate people.

The main functions of a central network system are data acquisition, including decoding of messages from the AWS network, remote control and house-keeping of AWSs, network monitoring and data quality control, further processing of data to satisfy user requirements, access to the network database, data display, and data transfer to internal or external users. The latter may include the Global Telecommunication System if the data are exchanged internationally.

1.5.2 **Quality management of network data**

This topic is discussed further in Part III, Chapter 1. It is recommended that operators of networks:¹⁸

- (a) Establish and test near-real-time measurement monitoring systems in which reported values are regularly tested against analysed fields corresponding to the same measurement location;
- (b) Establish effective liaison procedures between the monitoring service and the appropriate maintenance and calibration services to facilitate rapid response to fault or failure reports from the monitoring system.

Automated quality-control procedures at an AWS have their limitations and some errors can go undetected even with the most sophisticated controls, such as long-term drifts in sensors and modules. Data transmission from an AWS adds another source of error. Therefore, it is recommended that additional quality-control procedures should be executed by a network monitoring system forming part of the central network system. Quality-control procedures of prime importance in such a monitoring system include:

- (a) Detecting data transmission errors; the required routines depend on the transmission protocol and cyclic redundancy codes used;
- (b) Checking the format and content of WMO coded messages (WMO, 1993);
- (c) Further processing of data to exclude or otherwise deal with data flagged as erroneous or suspect in the AWS housekeeping files.

Interactive display systems also allow complementary quality-control of incoming data. Time-series for one or more variables and for one or more stations can be displayed on colour screens; statistical analysis can be used by trained and experienced personnel to detect short- and long-term anomalies that are not always detected by fully automatic quality-control algorithms.

Monitoring algorithms, by which reported values are regularly tested in space and time against an analysed numerical field, are very powerful ways to identify errors and to establish the need for investigative or remedial action. The low level of turbulent fluctuations in atmospheric pressure and the confidence with which local geographic influences can be removed by normalizing all observations to a common reference level make atmospheric pressure a prime candidate for this type of quality control. By averaging over space or time, observations with other variables should be susceptible to this analysis as well. However, local orographic effects must be carefully considered and taken into account.

1.6 **MAINTENANCE**

The cost of servicing a network of automatic stations on land and, in particular, at sea can greatly exceed the cost of their purchase. It is, therefore, of central importance that AWSs are designed to have the greatest possible reliability and maintainability. Special protection against environmental factors is often justified, even when initial costs are high.

It is evident that any complex system requires maintenance support. Corrective maintenance is required for component failures. Hardware components may fail for many reasons; computer programs can also fail because of errors in design that can go undetected for a long time. To minimize corrective maintenance and to increase the performance of an AWS, well-organized preventive maintenance is recommended. Preventive maintenance is required for all system components, not only cleaning and lubricating the mechanical parts. In view of the increasing reliability of the electronic components of an AWS, preventive maintenance, including services and sensor calibration, will become the controlling factor in maintenance.

Adaptive maintenance is required to take into account the rapid changes in technology and the availability of spare parts after a few years. Indeed, costs for repair and components often increase quite rapidly after a system is no longer in active distribu-

¹⁸ Recommended by the Commission for Instruments and Methods of Observation at its ninth session (1985) through Recommendation 5 (CIMO-IX).

tion, making it necessary to replace modules by new ones with different technology, as exact replacements are seldom found. Examples include transferring data from one recording medium to another and programs and operating systems from one processor to another, introducing modular changes for system reliability, connecting with new telecommunication systems, and so on. In order to reduce the costs for this kind of maintenance, it is desirable that widely accepted standards on equipment and interfaces, as well as on software, be established and included in AWS technical specifications.

Since the maintenance of a network of automatic stations is often a grossly underestimated task, it is essential to organize maintenance according to a rational plan that details all the functions and arranges them so as to minimize costs without adversely affecting performance. The modular structure of many modern automatic stations allows maintenance to take place in the field, or at regional and national centres.

Field maintenance: In general, it is not advisable to repair AWS sensors or other modules in the field because conditions do not favour effective work. Also, because of high staff costs and relatively low equipment costs, it is more cost-effective to discard faulty modules rather than to repair them. It is recommended that corrective maintenance in the field be carried out by specialized technical personnel from a regional or national centre, depending on the size of the country, and to leave simple preventive maintenance to the local observer (when available). The periodic transmission of self-checking diagnostic information by the AWS is a very desirable practice to ensure rapid response to failures.

Regional centre: At a regional centre, technical personnel should be available to replace or repair modules and sensors which require the detection and elimination of simple defects. The personnel should have good knowledge of the station hardware operation and must be trained in the execution of software maintenance routines. Such regional centres should be equipped with appropriate test equipment and sufficient spare modules and sensors to support the maintenance of the stations in their area. These centres need adequate transportation facilities for conducting field work. Care should be taken to plan and visit periodically the remote sites to check for operational problems, vandalism, site conditions, changes, and so forth. Procedures for emergency visits to the different stations must be established, based on priorities defined at the station.

National centre: A national centre requires more skilled technical personnel, who should be capable of detecting and eliminating complex problems in sensors, modules and data transmission means. The equipment necessary for checking and correcting all parts of an AWS should be available and the work should be performed in the centre. Any recurring defects should be referred to designers or suppliers in charge of correcting the design fault.

As software plays a very important role in each AWS and in the central network processing system, personnel with a profound knowledge of the AWS and central network system software are required. The necessary software development and test facilities should be available. Moreover, the national centre should be able to execute all tasks associated with adaptive maintenance.

With reference to the quality-control of network data, it is desirable to establish effective liaison procedures between the monitoring service and the appropriate maintenance and calibration service in order to facilitate rapid response to fault or failure reports from the monitoring system.

The scheme outlined above is suitable for big countries. For small countries, the tasks of the regional centres could be taken over by the national centre. Developing countries could consider establishing joint maintenance arrangements with neighbouring countries. A common international maintenance centre could be envisaged in order to keep maintenance costs reasonably low. However, such international cooperation would probably require the use of similar equipment. If the Meteorological Service is unable to expand its staff or facilities, contractor services could be used to perform many of the support functions. Such support could, for example, be negotiated as part of the system procurement. However, a maintenance contract should be extremely well prepared and the execution of the contract should be very carefully verified by the appropriate staff.

Suggestions for quality-management techniques are given in Part III, Chapter 1.

1.7 CALIBRATION

Sensors, in particular AWS sensors with electrical outputs, show accuracy drifts in time and, consequently, need regular inspection and calibration.

In principle, the calibration interval is determined by the drift specifications given by the manufacturer and the required accuracy. WMO international instrument intercomparisons also provide some objective indications of sensor accuracy drifts and desirable calibration intervals. As signal conditioning modules and data-acquisition and transmission equipment also form a part of the measuring chain, their stability and correct operation also have to be controlled or calibrated periodically. The summary given below is limited to practical aspects related to AWSs. Refer to the different chapters of Part I and to Part III, Chapter 4, for more detailed information on calibration techniques and methods.

Initial calibration: It is easy to overlook the requirement that appropriate calibration facilities and instrumentation should be available prior to the procurement and installation of AWSs in order to be able to verify the specifications given by the manufacturer, to test the overall performance of the station and to verify that transportation did not affect the measuring characteristics of the equipment.

Field inspection: The periodic comparison of AWS sensors with travelling standards at the station is an absolute requirement to monitor the performance of the sensors. Travelling standards having similar filtering characteristics to the AWS measuring chain and with a digital read-out are to be preferred. In many countries, two travelling standards of the same type are used to prevent possible accuracy change problems due to transportation. In order to be able to detect small drifts, the travelling standards should have an accuracy that is much better than the relevant station sensor and should be installed during the comparison process in the same environmental conditions as the sensors for a sufficiently long time. As signal conditioning modules and data-acquisition equipment, such as the A/D converter, can also show performance drifts, appropriate electrical reference sources and multimeters should be used to locate anomalies.

Before and after field inspections, the travelling standards and reference sources must be compared with the working standards of the calibration laboratory. The maintenance service must be informed as soon as possible when accuracy deviations are detected.

Laboratory calibration: Instruments at the end of their calibration interval, instruments showing an accuracy deviation beyond allowed limits during a

field inspection and instruments repaired by the maintenance service should return to a calibration laboratory prior to their re-use. Sensors should be calibrated in a conditioned environment (environmental chambers) by means of appropriate working standards. These working standards should be compared and calibrated periodically with secondary standards and be traceable to international standards.

Attention should also be paid to the calibration of the different components forming the measuring and telemetry chain, in particular the signal-conditioning modules. This involves appropriate voltage, current, capacitance and resistance standards, transmission test equipment and high-accuracy digital multimeters. Highly accurate instruments or data-acquisition systems are required for calibration. A computer is desirable for calculation of calibration constants. These constants will accompany the sensor or module between calibrations and must be entered in the AWS whenever a sensor or module is replaced or installed in an AWS during field maintenance.

A schedule should be set up to compare periodically the secondary standards of the calibration laboratory with national, international or regional WMO primary standards.

1.8 TRAINING

As an AWS is based on the application of technology that differs considerably from the equipment at conventional stations and networks, a comprehensive review of existing training programmes and of the skills of the necessary technical staff is obviously required. Any new training programme should be organized according to a plan that is geared to meeting user needs. It should especially cover the maintenance and calibration outlined above and should be adapted to the system. Requesting existing personnel to take on new functions, even if they have many years of experience with conventional stations, is not always possible and may create serious problems if they have no basic knowledge of electrical sensors, digital and microprocessor techniques or computers. It could be necessary to recruit new personnel who have such knowledge. Personnel competent in the different areas covered by automatic stations should be present well before the installation of a network of AWSs (see WMO, 1997).

It is essential that AWS equipment manufacturers provide very comprehensive operational and technical documentation together with operational and technical training courses. Generally, two sets of documentation are required from the manufacturer: user manuals for operational training and use of the system, and technical manuals with more complex documentation describing in great technical detail the operating characteristics of the system, down to sub-unit and even electronic component level and including maintenance and repair instructions. These manuals can be considered as the basic

documentation for training programmes offered by the manufacturer and should be such that they can serve as references after the manufacturer's specialists are no longer available for assistance.

For some countries, it may be advisable to organize common training courses at a training centre that serves neighbouring countries. Such a training centre would work best if it is associated with a designated instrument centre and if the countries served have agreed on the use of similar standardized equipment.

REFERENCES AND FURTHER READING

- World Meteorological Organization, 1954: *Reduction of Atmospheric Pressure*. Technical Note No. 7, WMO-No. 36.TP. 12, Geneva.
- World Meteorological Organization, 1964: *Note on the Standardization of Pressure Reduction Methods in the International Network of Synoptic Stations*. Technical Note No. 61, WMO-No. 154.TP.74, Geneva.
- World Meteorological Organization, 1968: *Methods in Use for the Reduction of Atmospheric Pressure*. Technical Note No. 91, WMO-No. 226. TP.120, Geneva.
- World Meteorological Organization, 1983: *Guide to Climatological Practices*. Second edition, Part I, Chapter 2, WMO-No. 100, Geneva (updates available at: http://www.wmo.ch/pages/prog/wcp/ccl/guide/guide_climat_practices.html).
- World Meteorological Organization, 1987: *Some General Considerations and Specific Examples in the Design of Algorithms for Synoptic Automatic Weather Stations* (D.T. Acheson). Instruments and Observing Methods Report No. 19, WMO/TD-No. 230, Geneva.
- World Meteorological Organization, 1988a: *Technical Regulations*. WMO-No. 49, Geneva.
- World Meteorological Organization, 1988b: *WMO International Ceilometer Intercomparison (United Kingdom, 1986)* (D.W. Jones, M. Ouldrige and D.J. Painting). Instruments and Observing Methods Report No. 32, WMO/TD-No. 217, Geneva.
- World Meteorological Organization, 1989a: *Guide on the Global Observing System*. WMO-No. 488, Geneva.
- World Meteorological Organization, 1989b: *WMO International Hygrometer Intercomparison* (J. Skaar, K. Hegg, T. Moe and K. Smedstved). Instruments and Observing Methods Report No. 38, WMO/TD-No. 316, Geneva.
- World Meteorological Organization, 1989c: Preliminary results of the WMO automatic sunshine duration measurement comparison 1988/89 in Hamburg (K. Dehne). *Fourth WMO Technical Conference on Instruments and Methods of Observation (TECIMO-IV)*. Instruments and Observing Methods Report No. 35, WMO/TD-No. 303, Geneva.
- World Meteorological Organization, 1990a: *The First WMO Intercomparison of Visibility Measurements (United Kingdom 1988/1989)*(D.J. Griggs, D.W. Jones, M. Ouldrige and W.R. Sparks). Instruments and Observing Methods Report No. 41, WMO/TD-No. 401, Geneva.
- World Meteorological Organization, 1990b: *Guide on Meteorological Observation and Information Distribution Systems at Aerodromes*. WMO-No. 731, Geneva.
- World Meteorological Organization, 1991: *Guidance on the Establishment of Algorithms for Use in Synoptic Automatic Weather Stations: Processing of Surface Wind Data* (D.J. Painting). Instruments and Observing Methods Report No. 47, WMO/TD-No. 452, Geneva.
- World Meteorological Organization, 1992a: *International Meteorological Vocabulary*. Second edition, WMO-No. 182, Geneva.
- World Meteorological Organization, 1992b: *The WMO Automatic Digital Barometer Intercomparison: Final Report* (J.P. van der Meulen). Instruments and Observing Methods Report No. 46, WMO/TD-No. 474, Geneva.
- World Meteorological Organization, 1993: *Guide on the Global Data-processing System*. WMO-No. 305, Geneva.
- World Meteorological Organization, 1994: WMO solid precipitation measurement intercomparison: Preliminary results (B.E. Goodison, E. Elomaa, V. Golubev, T. Gunther and B. Sevruk). *Papers Presented at the WMO Technical Conference on Instruments and Methods of Observation (TECO-94)*, Instruments and Observing Methods Report, No. 57, WMO/TD-No. 588, Geneva.
- World Meteorological Organization, 1995: *Manual on Codes*. Volumes I.1 and I.2, WMO-No. 306, Geneva.
- World Meteorological Organization, 1997: *Guidance on Automatic Weather Systems and their Implementation*. Instruments and Observing Methods Report No. 65, WMO/TD-No. 862, Geneva.
- World Meteorological Organization, 2000: Operation of automated surface observing systems in harsh climatological environments (M.D. Gifford, G.M. Pearson and K. Hegg). *Papers Presented at the WMO Technical Conference on Meteorological and Environmental Instruments and Methods of Observation (TECO-2000)*. Instruments and Observing Methods Report No. 74, WMO/TD-No. 1028, Geneva.
- World Meteorological Organization, 2003a: *Manual on the Global Observing System*. WMO-No. 544, Geneva.
- World Meteorological Organization, 2003b: *Algorithms Used in Automatic Weather Stations: Evaluation of Questionnaire* (M.D. Gifford). Instruments and Observing Methods Report No. 78, WMO/TD-No. 1160, Geneva.

CHAPTER 2

MEASUREMENTS AND OBSERVATIONS AT AERONAUTICAL METEOROLOGICAL STATIONS

2.1 GENERAL

2.1.1 Definitions

This chapter deals with the requirements for observations at aeronautical meteorological stations and the instruments and methods that are used. Synoptic observations measure at one location a representative value for a rather large area, but meteorological observations for aeronautical purposes are often made at several locations at the aerodrome and in the surrounding area, at more frequent intervals, to be representative of rather limited areas, such as the approach, touchdown and take-off areas.

The meteorological measurements to be taken are for the most part essentially the same as those taken for other applications, and described in other chapters in this Guide. The exceptions are runway visual range (RVR), slant visual range and low level wind shear which are unique to this application.

2.1.2 Units

The units for measuring and reporting meteorological quantities for aeronautical purposes are the same as for other applications, except that:

- (a) Surface wind speed may be measured and reported in metres per second, kilometres per hour or knots;¹ and wind direction² reported in degrees measured clockwise from geographic north³ (see section 2.2.1);
- (b) Cloud base height may be measured in metres or feet.

The choice of units is a matter for national practice, depending on the requirements of the aviation regulatory bodies.

1 The unit of wind speed used is determined by national decision. However, the primary unit prescribed by the *Technical Regulations*, Volume II (WMO, 2004) for wind speed is the kilometre per hour, with the knot permitted for use as a non-SI alternative unit until a termination date is decided – subject to a decision which is currently under review by ICAO.

2 Direction from which surface wind is blowing.

3 Because wind direction reported to aircraft for landing or take-off purposes may be converted into degrees magnetic, the display at the air traffic service unit usually presents direction with respect to the magnetic north.

2.1.3 Requirements

The formal requirements for aeronautical observations are stated in the WMO Technical Regulations (WMO, 2004). Detailed guidance on procedures and practices is found in WMO (1990a). Useful guidance on observing and monitoring meteorological conditions is contained in WMO (2003). Special attention should be given to aeronautical meteorological stations established on offshore structures in support of helicopter operations (ICAO, 1996).

The requirements for uncertainty, resolution and range, and for currently achievable performance in meteorological measurements are given in Part I, Chapter 1 and, partly, in Technical Regulation [C.3.1.], Attachment A.

Despite the excellent performance of modern aircraft, weather factors still have a marked effect on their operation. The reliability and representativeness of aerodrome observations are very important in ensuring that landings and take-offs are made safely. The wind observation will determine the runway to be used, and the maximum take-off and landing weights. Temperature is also important and affects engine performance. Consequently, the load carried might have to be reduced, or the take-off would require a longer runway, particularly at airports in hot countries.

Routine observations are to be made at aeronautical meteorological stations, at times and frequencies determined by the Member country to meet the needs of national and international air navigation, giving due regard to regional air-navigation arrangements. Special and other non-routine observations are to be made on the same basis. Routine observations at aerodromes should be made at hourly or half-hourly intervals, during all or part of each day, or as necessitated by aircraft operations. Special observations should be made when specified changes occur between routine observations in respect of surface wind, visibility, RVR, present weather and/or cloud. These specified changes are set out in WMO Technical Regulation [C.3.1.], Appendix 3, 2.3.2. These observations, in the form of coded reports of the METAR or SPECI types, are exchanged internationally between aeronautical meteorological stations. Other types of reports are

intended only for aeronautical operations, and should be prepared in a form defined jointly by the meteorological and airport authorities.

In view of the importance of meteorological observations for aircraft safety, it is essential that observers be correctly trained and have good eyesight. Observer training should include basic courses and regular refresher courses. WMO (2002) gives guidance on the contents of courses.

Siting, installation and the nature of meteorological systems are specified in Technical Regulation [C.3.1.] 4, with technical specifications and detailed criteria in Technical Regulation [C.3.1.], Appendix 3. These specifications are summarized below.

Special care is necessary in selecting appropriate sites for making observations, or for the installation of instruments at aeronautical meteorological stations, to ensure that the values are representative of the conditions at or near the aerodrome. In some instances, where information over a large area is required, it may be necessary to provide multiple installations for some instruments to ensure that values reported are representative of the entire area. For example, for long runways or for large aerodromes with several runways, where approach, touchdown and take-off areas may be as much as 2 to 5 km apart, the values of various parameters such as wind, cloud height, RVR, and so forth, measured at one end of a runway may be quite different from the conditions prevailing elsewhere on that runway, or over other areas of the runway complex of interest to aircraft operations.

At all aerodromes, the sites should be such that the measured values of the various meteorological parameters are representative of the aerodrome itself and/or the appropriate area of a particular runway or runway complex. At aerodromes where precision approach and landing operations are not in practice (non-instrument or non-precision approach runways), this criterion on representativeness is less restrictive than with precision approach runways (i.e. with Category I, II or III runways (see WMO, 1990a, and ICAO, 2004a)).

In selecting locations for instruments at aerodromes, it is particularly important that, while the site and exposure of the instruments meet operational requirements, the instruments or their operation do not present hazards to air navigation; and that the presence or movement of aircraft at the aerodrome (taxiing, take-off runs, landing, parking,

etc.) and the various aerodrome installations do not unduly influence the measured values.

The types of instruments to be used, their characteristics and the methods employed for the presentation and reporting of the measured values of the parameters are equally important. Meteorological instruments should be exposed, operated and maintained in accordance with the practices, procedures and specifications promulgated in this Guide. Aeronautical meteorological stations should be inspected at sufficiently frequent intervals to ensure that a high standard of observations is maintained, that instruments and all their indicators are functioning correctly, and to check whether the exposure of the instruments has changed significantly (Technical Regulation [C.3.1.] 4.1.4).

Instrument design should permit remote indication, simultaneously at both the air traffic service (ATS) units and at the meteorological stations and offices, of the appropriate values of surface wind, temperature, dewpoint, atmospheric pressure, present weather, visibility, RVR (if the runways are equipped for take-offs and landings in fog) and cloud height, all of which should be representative of conditions in the touchdown and take-off areas concerned. Automatic instrumental systems for measuring the height of the cloud base and RVR are particularly useful at aeronautical stations.

At aerodromes where precision approaches and, in particular, where Category II, III A and III B operations are affected, and/or at aerodromes with high levels of traffic, it is preferable to use integrated automatic systems for acquisition, processing and dissemination/display in real time of the meteorological parameters affecting landing and take-off operations. These automatic systems should be capable of accepting the manual insertion of meteorological data that cannot be measured by automatic means (Technical Regulations [C.3.1.] 4.1.7 and 4.6.8.2). The requirements for automatic meteorological observing systems are specified in Technical Regulation [C.3.1.], Appendix 3.

2.1.4 **Methods**

The methods for taking meteorological measurements at aerodromes are essentially the same as those for other meteorological applications and described in other chapters of this Guide. This chapter describes some siting and sampling requirements, and some algorithms, which are particular to the aeronautical application.

2.2 SURFACE WIND

2.2.1 General

In aviation, measurements of airflow and low-level wind shear in the vicinity of the landing and take-off areas are of primary interest. The regulations are described in Technical Regulation [C.3.1.] 4.1, with details in Technical Regulation [C.3.1.], Appendix 3. At international aerodromes, ATS units, air traffic control towers, and approach control offices are normally equipped with wind-speed and wind-direction indicators, and air traffic controllers supply arriving and departing aircraft with readings from these indicators. To ensure compatibility, the indicators at the ATS units and the meteorological station should be connected to the same sensors.

The mean direction and speed of the wind are measured as well as gusts and specified significant variations of direction and speed. Wind reports disseminated beyond the aerodrome (Technical Regulation [C.3.1.], Appendix 3, 4.1.4) have the same content as those in synoptic observations (10 min means, and direction reported with respect to the geographic north),⁴ and the values transmitted should be representative of all runways. For local routine and special reports and for wind indicator displays in ATS units (Technical Regulation [C.3.1.], Appendix 3, 4.1.3.1), the averaging period is 2 min for both speed and direction, and the values should be representative of the runway in use. Although wind direction shall be reported with respect to the geographic north, expressed in “degrees true” (Technical Regulation [C.3.1.] 4.6.1 and Appendix 3, 4.1.4.1), it is still common practice that ATS personnel report the aircraft with respect to the magnetic north (“degree magnetic”). Gusts should be determined from 3 s running means. Part I, Chapter 5, and Part III, Chapter 2, of this Guide should be consulted on the precautions to be taken for sampling the anemometer output to measure the mean, gusts and variability of the wind speed and direction. Vector averaging is to be preferred to scalar averaging.

The wind measurements needed at aerodromes, such as mean value, extreme values, and so forth, should preferably be determined and displayed

automatically, particularly when several sensors are used on different runways. When several sensors are required, the indicators shall be clearly marked to identify the runway and the section of runway monitored by each sensor.

2.2.2 Instruments and exposure

Wind-measuring instruments used at aeronautical stations are generally of the same type as those described in Part I, Chapter 5. The lag coefficients of direction and speed sensors should comply with the requirements of that chapter.

Sensors for direction and speed should be exposed approximately 10 m above the runway and should provide measurements that are representative of the conditions at the average lift-off and touch-down areas of the runway. However, for compatibility with synoptic observations, a height of 10 m is to be preferred.

If wind sensors installed at aerodromes are to be representative of the conditions at take-off or landing areas, any disturbance or turbulence due to the proximity and passage of the aircraft themselves must be avoided (false gust indications due to landings and take-offs). For similar reasons, they must not be placed too close to buildings or hills or located in areas subject to microclimatic conditions (sea breeze, frequent storms, etc.). The preferred standard exposure of wind instruments is in open terrain, defined as an area where the distance between the anemometer and any obstruction is at least 10 times the height of the obstruction.

It is recommended that back-up or standby equipment should be provided in case of failure of the service instrument in order to avoid any interruption in the transmission of data to the ATS units. Where local conditions so warrant, one or more sets of sensors should be installed for each runway concerned. In such cases, the use of digital techniques is recommended since they enable data from a large number of sensors to be transmitted by one or two telephone cable pairs, and allow digital indicators to be used to display wind measurements using light-emitting diodes of different colours. The displays should show the “instantaneous” wind speed and direction (with a distance constant of 2 to 5 m), the average wind speed and direction over 2 or 10 min, and the minimum and maximum wind speeds. It is sometimes possible to select wind readings for different measurement points on the same indicator (thus reducing the number of indicators required).

4 Usually referred to as the “true” north, with the unit “degree true”. The word “true” in “true north” or “degree true” should not be confused with the “true wind” (defined by WMO, 1992a). “True wind” is represented by the wind vector in relation to the Earth’s surface. For a moving object like an aircraft, it is the vector sum of the apparent wind (i.e. the wind vector relative to the moving object) and the velocity of the object.

When installing wind sensors at the aerodrome, particular attention must be paid to protecting them against atmospheric storm discharge (by the use of lightning conductors, earthing of the mast, and shielded or fibre optic cables); electronic data-processing equipment should also be protected.

In order to maintain the required accuracy, wind-measuring instruments should be kept in good order and regularly checked and recalibrated. Sensor performance must sometimes be checked in the wind tunnel, particularly for analogue systems. The use of digital techniques with the built-in testing of certain functions calls for fewer checks, but does not eliminate errors due to friction. Regular checks are to be made to detect defective components and deterioration of certain parts of the sensors.

The sources of error include friction, poor siting and problems with transmission or display equipment. Errors may also be caused by the design of the sensors themselves and are noticed particularly in light winds (rotation threshold too high, excessive inertia) or variable winds (over- or underestimation of wind speed or incorrect direction due to excessive or inadequate damping).

2.3 VISIBILITY

The definition of the meteorological optical range (MOR) and its estimation or instrumental measurement are discussed in Part I, Chapter 9. The measurement of visibility in aviation is a specific application of MOR. However, the term MOR is not yet commonly used in aviation and the term visibility has been retained in this chapter to describe operational requirements. For aviation purposes, it is common practice to report visual ranges like the RVR and “visibility for aeronautical purposes” (VIS-AERO). Note that the latter is used in reports and indicated as “visibility” only, which differs from the common definition of visibility (see Part I Chapter 9). Instruments used to measure MOR may also be used to measure RVR (see section 2.4) and VIS-AERO (see section 2.3.1). Technical Regulation [C.3.1.], Appendix 3, 4.2 and 4.3 contains the formal descriptions for international aviation.

At international aerodromes, visibility observations made for reports disseminated beyond the aerodrome should be representative of conditions pertaining to the aerodrome and its immediate vicinity. Visibility observations made for reports for landing and take-off and disseminated only within the aerodrome should

be representative of the touchdown zone of the runway, remembering that this area may be several kilometres from the observing station.

For aeronautical purposes, the measurement range for visibility is from 25 m to 10 km. Values greater than or equal to 10 km are indicated as 10 km. A sensor must therefore be able to measure values above 10 km or indicate if the measurement is greater than or equal to 10 km. The operationally desirable measurement uncertainty is 50 m up to 600 m, 10 per cent between 600 m and 1 500 m and 20 per cent above 1 500 m (Attachment A to WMO (2004)). See Part I, Chapters 1 and 9, for advice on the accuracy of measurements.

In view of the meteorological minima governing the operational decisions on whether an aircraft can or cannot land or take-off, precise, reliable information must be given whenever visibility passes through certain limits, namely whenever visibility drops below or increases beyond the limit values of 800, 1 500 or 3 000 and 5 000 m, in the case, for example, of the beginning, cessation or change in fog or precipitation (Technical Regulation [C.3.1.], Appendix 3, 2.3.2 (e)).

When there are significant directional variations in visibility, particularly when they affect take-off and landing areas, this additional information should be given with indications of the direction of observation, for example, “VIS 2000 M TO S”.

When visibility is less than 800 m it should be expressed in steps of 50 m in the form VIS 350M; when it is 800 m or more but less than 5 km in steps of 100 m; when it is 5 km or more but less than 10 km, in kilometre steps in the form VIS 7KM; and when it is 10 km or more, it should be given as 10 km, except when the conditions for the use of CAVOK (Ceiling and Visibility OK) apply (Technical Regulation [C.3.1.], Appendix 3, 4.2.4.1).

The methods described in Part I, Chapter 9, apply. Meteorological visibility observations are to be made by an observer who has “normal” vision, viewing selected targets of specified characteristics at known distances from the meteorological station. These observations may also be made by using visibility-measuring instruments, such as transmissometers and scatter coefficient meters. The location of the observing sites should be such as to permit continuous viewing of the aerodrome, including all runways.

If a transmissometer is used for visibility measurements, a baseline length of 75 m is suitable for aeronautical operations. However, if the instrument is

also to be used for measuring RVR, the baseline length should be chosen after taking into account the operational categories in force at the aerodrome.

2.3.1 **Visibility for aeronautical purposes**

Technical Regulation [C.3.1.] 1.1 defines visibility. VIS-AERO is the greater of:

- (a) The greatest distance at which a black object of suitable dimensions, situated near the ground, can be seen and recognized when observed against a bright background;
- (b) The greatest distance at which lights in the vicinity of 1 000 cd can be seen and identified against an unlit background.

This VIS-AERO is in fact a “visual range” like RVR, involving subjective elements such as the virtual performance of a human eye and artificial lights. Nevertheless, the word “visibility” is commonly used without the addition “for aeronautical purposes” and confusion may arise with the official definition of “visibility” as defined by WMO (see Part I, Chapter 9) which is known as the MOR (meteorological optical range). An optical range is purely based on the physical state of the atmosphere and not on human or artificial elements, and is therefore an objective variable. This visibility (for aeronautical purposes) shall be reported, as in METAR. Because an aeronautical meteorological station may be combined with a synoptic station, visibility in SYNOP reports will differ from visibility in METAR, although it is measured by the same equipment.

Visibility for aeronautical purposes can be measured and calculated similarly to RVR (see section 2.4 for details), except that for the intensity of the light source, *I*, a constant value of 1 000 cd shall be used. Note that this value holds for lights usually used for the assessment of visibility, which are 10 times more intense than lights of moderate intensity (i.e. 100 cd, see Part I, Chapter 9).

2.3.2 **Prevailing visibility**

Prevailing visibility is defined as the visibility value, observed in accordance with the definition of “visibility (for aeronautical purposes)”, which is reached or exceeded within at least half of the horizon circle or within at least half of the surface of the aerodrome. These areas could comprise contiguous or non-contiguous sectors. This value may be assessed by human observation and/or instrumented systems, but when instruments are installed, they are used to obtain the best estimate of the prevailing visibility (Technical Regulation [C.3.1.] 1.1).

Prevailing visibility should be reported in METAR and SPECI code forms.

2.4 **RUNWAY VISUAL RANGE**

2.4.1 **General**

RVR is the range over which the pilot of an aircraft on the centre line of a runway can see the runway surface markings or the lights delineating the runway or identifying its centre line. It is discussed in Technical Regulation [C.3.1.] 4.6.3 and Appendix 3, 4.3. Details on observing and reporting RVR are given in ICAO (2000). It is recommended that this measurement be taken during periods when horizontal visibility is less than 1 500 m.

A height of approximately 5 m is regarded as corresponding to the average eye-level of a pilot in an aircraft on the centre line of a runway. Note that for wide-bodied aircraft, the pilot’s eye-level may be at least 10 m. In practice, RVR cannot be measured directly from the position of a pilot looking at the runway centre line, but must be an assessment of what he or she would see from this position. Nevertheless, RVR should be assessed at a height of approximately 2.5 m above the runway (Technical Regulation [C.3.1.], Appendix 3, 4.3.1.1).

The RVR should be reported to the ATS units whenever there is a change in RVR, according to the reporting scale. The transmission of such reports should normally be completed within 15 s of termination of the observation. These reports are to be given in plain language.

2.4.2 **Methods of observation**

The RVR may be measured indirectly, by observers with or without supplementary equipment, by instrumental equipment such as the transmissometer or sensors measuring scattered light, or by video systems. At aerodromes, where precision approaches and, in particular, where Category I, II, III A and III B operations are executed, RVR measurements should be made continuously by using appropriate instruments, namely transmissometers or forward-scatter meters (Technical Regulation [C.3.1.], Appendix 3, 4.3.2.1 for Category II and III, and recommended for Category I in [C.3.1.], Appendix 3, 4.3.2.2).

The RVR can then be assessed for operational purposes using tables or, preferably, by automatic equipment with digital read-out of RVR. It should be computed

separately for each runway in accordance with Technical Regulation [C.3.1.], Appendix 3, 4.3.5.

2.4.2.1 Measurement by observers

The counting of runway lights visible in fog (or lights specially installed parallel to the runway for that purpose) by observers can provide a simple and convenient method of determining RVR (but for precision instrument landing, only if the instrumented system fails). The difficulty arising with this method is related to the resolution capability of the human eye which, beyond a certain distance (dependent on the observer), does not permit the runway lights to be distinguished and counted.

Since the observer's position when observing runway lights is not identical to that of the pilot, the use of conversion curves to determine the true RVR is essential. Specially designed marker boards, spaced out along the side of the runway, may also be used for RVR assessment during the day.

2.4.2.2 Measurement by video

To assess RVR using a video system, use is made of a video camera and receiver to observe markers at known distances consisting of either runway lights, special lights, or markers positioned alongside the runway. Such a system is also beneficial for detecting patchy or shallow fog, which cannot be detected by the instruments.

2.4.2.3 Measurement by transmissometer

The instrument most commonly used at present for making an assessment of RVR is the transmissometer, which measures the transmission factor along a finite path through the atmosphere (see Part I, Chapter 9). RVR can be determined as follows:

- (a) RVR when runway lights are dominant (RVR based on illumination threshold): The RVR depends on the transmission factor of the air, on the intensity of the runway lights and on the observer's (and pilot's) threshold of illuminance, which itself depends on the background luminance. It can be computed from:

$$E_t = I R^{-2} T^{R/a} \tag{2.1}$$

where E_t is the visual threshold of illuminance of the observer (pilot), which depends on the background luminance L ; I is the effective intensity of centre-line or edge lights toward the observer (pilot); T is the transmission factor, measured by the transmissometer; R is the RVR; and a is the transmissometer

baseline or optical light path. Note that for the illuminance E of the observer (pilot), it holds that $E = I / R^2$. The requirements for the light intensity characteristics of runway lights are given in ICAO (2004b). In fact, it holds for both centre-line and edge light that the illumination of the observer (pilot) is angular dependent and as a consequence I depends on R . Therefore $I = I(R)$ and $E = E(I, R)$. The calculation of R from equation 2.1 can be done only iteratively, which is relatively easy with the help of a simple calculator suitable for numerical mathematics. The value of E_t is determined with the help of a background luminance sensor (see section 2.4.3.3);

- (b) Assessment of RVR by contrast (RVR based on contrast threshold): When markers other than lights are used to give guidance to pilots during landing and take-off, the RVR should be based upon the contrast of specific targets against the background. A contrast threshold of 0.05 should be used as a basis for computations. The formula is:

$$R = a \frac{\ln 0.05}{\ln T} \tag{2.2}$$

where R is RVR by contrast. Because the contrast threshold level is 0.05, RVR by contrast is identical to MOR, namely $R = \text{MOR}$. Note that RVR (based on illumination threshold) will always supersede RVR (based on contrast threshold), or $\text{RVR} \geq \text{MOR}$.

2.4.2.4 Measurement by forwardscatter or backscatter meters

Instruments for measuring the forwardscatter or backscatter coefficient (sometimes known as scatterometers) are discussed in Part I, Chapter 9. Because of the physical principles of light scattering by aerosols, the measurement uncertainty of a forwardscatter meter (scatter-angle about 31-32°) is smaller than with backscatter meters. Therefore, a forwardscatter meter is to be preferred. With these instruments the extinction coefficient σ can be determined, which is the principal variable to calculate RVR. Experience and studies with forwardscatter meters have demonstrated their capability to measure RVR for aeronautical applications (WMO, 1990b; 1992b).

Since accuracy can vary from one instrument design to another, performance characteristics should be checked before selecting an instrument for assessing RVR. Therefore, the calibration of a

forwardscatter meter has to be traceable and verifiable to a transmissometer standard, the accuracy of which has been verified over the intended operational range (Technical Regulation [C.3.1.], Appendix 3, 4.3.2).

A scatter meter determines, from the received scattered light, the extinction coefficient σ of the atmosphere at the position of the optical volume (see Part I, Chapter 9). Because σ is a direct measure for the visibility, R can be determined relatively easily (from σ or MOR, where $\text{MOR} = -\ln 0.05/\sigma \approx 3/\text{MOR}$). The RVR can be determined as follows:

- (a) RVR when runway lights are dominant (RVR based on illumination threshold): RVR will be calculated in a similar way as with a transmissometer except that σ is used and not T . It can be computed from:

$$R = \frac{1}{\sigma} \left(\frac{I(R)}{E_t \cdot R^2} \right) \quad (2.3)$$

where R is the runway visual range; σ is the extinction coefficient (or $3/\text{MOR}$); E_t is the visual threshold of illuminance of the observer (pilot), which depends on the background luminance; and I is the effective intensity of centre-line or edge lights toward the observer (pilot). As with a transmissometer, R should be calculated iteratively;

- (b) Assessment of RVR by contrast (RVR based on contrast threshold): When markers other than lights are used to give guidance to pilots during landing and take-off, the RVR should be based upon the contrast of specific targets against the background. A contrast threshold of 0.05 should be used as a basis for computations. The formula is:

$$R = -\ln 0.05/\sigma = \text{MOR} \quad (2.4)$$

where R is RVR by contrast. Note that RVR (based on illumination threshold) will always exceed RVR (based on contrast threshold), namely $\text{RVR} \geq \text{MOR}$.

2.4.3 Instruments and exposure

Instrumented systems may be based on transmissometers or forwardscatter meters to assess RVR. Runway visual range observations should be carried out at a lateral distance of not more than 120 m from the runway centre line. The site for

observations that are representative of the touchdown zone should be located about 300 m along the runway from the threshold. The sites for observations that are representative of the middle and far sections of the runway should be located at a distance of 1 000 to 1 500 m along the runway from the threshold and at a distance of about 300 m from the other end of the runway (Technical Regulation [C.3.1.], Appendix 3, 4.3.1.2). The exact position of these sites and, if necessary, additional sites (for long runways), should be determined after considering aeronautical meteorological and climatological factors, such as swamps and other fog-prone areas. Runway visual range should be observed at a height of approximately 2.5 m (Technical Regulation [C.3.1.], Appendix 3, 4.3.1.1).

The units providing air traffic and aeronautical information services for an aerodrome should be informed without delay of changes in the serviceability status of the RVR observing system.

A computer is usually used to compute the RVR at several measurement points and to display the measurements on screen with the time of observation, the transmission factors, the luminance measured at one or more points on the aerodrome and the runway light intensity. The data are sent to display panels at the ATS and meteorological and other units concerned, or to printers for recording.

The runway light intensity should be entered automatically in the computer in accordance with the procedure described in Technical Regulation [C.3.1.], Appendix 3, 4.3.5 or as formally agreed upon between the ATS units and the local meteorological unit.

Analogue or digital graphic recorders (with time base) for transmission factors T and background luminance I may also be used. A graphic display of the RVR should also properly show the record of E_t and I (see equation 2.1).

2.4.3.1 Transmissometers

A description of transmissometers, their installation on site and their maintenance and sources of error is given in Part I, Chapter 9, with references to other literature.

A transmissometer system consists of a projector that directs a light of known intensity onto a photoelectric receiving device placed at a known distance from the projector. The variations in atmospheric transmission, due to fog or haze, and so on, are continuously measured and recorded.

The instrument is calibrated to be direct-reading, giving the transmission factor in per cent.

The transmitter and receiver must be mounted at the same height on rigid, secure and durable stands, which, if possible, are not frangible and in such a way that shifting soil, frost, differential heating of towers, and so forth, do not adversely affect the alignment of the two units. The height of the optical path should not be less than 2.5 m above the level of the runway.

In one type of transmissometer, the transmitter and receiver are incorporated in the same unit (see Part I, Chapter 9). In this case, a reflector (for example, mirror) is installed at the normal receiver location. The light travels out and is reflected back, with the baseline length being twice the distance between the transmitter/receiver and the reflector. The transmissometer may have a single or double base, depending on whether one or two receivers or retro-reflectors, positioned at different distances, are used.

The transmissometer baseline length, namely, the length of the optical path covered by the light beam between transmitter and receiver, determines the RVR measurement range. For an RVR between 50 and 1 500 m, the most commonly used baseline lengths are between 15 and 75 m.

However, for shorter transmissometer baseline lengths, a higher transmission factor measurement accuracy and better system linearity are necessary. If low RVRs must be measured for Category II and III landing requirements, a short base transmissometer should be selected. However, the maximum RVR that can be measured is then relatively low. A compromise must be found. Double-base transmissometers exist, offering a wider measurement range by the selection of one base or the other, but care must be taken when switching baselines to ensure that the RVR measurements remain consistent with each other.

Higher RVR values can be measured by using longer transmissometer baseline lengths, but greater luminous power is needed for transmission to compensate for light attenuation between the transmitter and receiver in dense fog, and a narrower reception angle is required to avoid scatter disturbance phenomena. The measurement of the weakest signals is also dependent on background noise in the measuring equipment.

Transmissometers are generally aligned parallel to the runway. However, direct (or reflected) sunlight should be avoided as this may cause damage. The

optical axis should, therefore, be positioned in an approximate north-south direction horizontally (for latitudes below 50°). Otherwise, a system of baffles should be used.

2.4.3.2 Forwardscatter meters

Forwardscatter meters should be sited near the runway in a similar fashion to transmissometers. The positioning of forwardscatter meters requires fewer precautions than for transmissometers. Nevertheless, care should be taken to avoid direct or scattered sunlight which might influence (or damage) the receiver. In particular, sunlight may influence the receiver after scattering by snow cover, or lake or sea surface. Modern instruments compensate for contamination of the optical components.

2.4.3.3 Background luminance sensor

The threshold of illuminance E_t must be known when computing the RVR. A background luminance sensor should be placed at the end of the runway along which one or more transmissometers or scatter meters have been installed. One or more luminance sensors may be installed at the airport depending on the number of runways covered.

The background luminance sensor measures the luminance of the horizon or sky in the direction opposite the sun. The illuminance thresholds are introduced in the RVR computation either as a continuous or a step function (two to four steps). The curve for converting background luminance to illumination threshold is given in Technical Regulation [C.3.1.], Attachment E, and in ICAO (2000). The recommended relation used for this curve is:

$$\log_{10}E_t = 0.05 (\log_{10}L)^2 + 0.573 \log_{10}L - 6.667 \quad (2.5)$$

where L is the luminance of the horizon sky.

The background luminance sensor consists of a photodiode placed at the focal point of a lens with an angular aperture of about 10° to 20°, aligned in a north-south direction (to avoid direct sunlight) and at an angle of elevation of approximately 30° to 45° to the horizon.

2.4.4 Instrument checks

It is essential that regular periodic checks be made on all components of the transmissometer – or scatter meter – RVR system to ensure the proper

operation and calibration of the system. In general, the literature provided by the companies manufacturing and developing such equipment will give detailed instructions for making such checks and will indicate the corrective action to be taken when specified instrumental tolerances are not met. For a transmissometer, when the visibility exceeds 10 to 15 km, it is simple to check that the equipment indicates a transmissivity of approximately 100 per cent (see Part I, Chapter 9). For scatter meters, "scatter plates" may be used, which emulate certain extinction values. However, the calibration of a forwardscatter meter should be traceable and verifiable to a transmissometer standard (see section 2.4.2.4).

Correct maintenance and calibration are necessary in order to:

- (a) Prevent dirt from accumulating, on optical surfaces;
- (b) Check variations in the light intensity of the transmitter;
- (c) Avoid drift after calibration;
- (d) Check the alignment of transmitters and receivers.

Frequent maintenance is necessary at heavily polluted sites. Care is to be taken so that not all equipment is taken out of service at the same time during maintenance, and so that this interruption of service is not of long duration, particularly during periods when fog is forecast.

When fog persists for several consecutive days, the projector should be checked to ensure that its light intensity is steady and the equipment should be checked for drift. Checking optical settings is difficult, if not impossible, in very dense fog; it is therefore vital that instruments should be mechanically reliable and optically stable.

2.4.5 **Data display**

The RVR data display for the units concerned is updated according to the local agreements in force: every 15 to 60 s, and even every 2 min on some occasions. Changes in RVR should normally be transmitted within 15 s after termination of the observation.

2.4.6 **Accuracy and reliability of runway visual range measurements**

If scattered light sensors are used, as distinct from transmissometers, the equations for RVR are acceptable in the case of fine water droplets as fog, but not when visibility is reduced by other hydrometeors such as freezing fog, rain, snow or

lithometeors (sandstorms). In which case, MOR and RVR measurements must be used with much caution since satisfactory relations for such cases have not yet been accepted.

Divergence between the RVR for a pilot and the measured value may reach 15 to 20 per cent, with an assumed standard deviation of not more than 10 per cent. In the case of observers, there are divergences in visual threshold and in observing conditions that, together, can cause differences in reported visual range amounting to 15 or 20 per cent.

RVR measurements taken using transmissometers or scatter coefficient meters are representative of only a small volume of the atmosphere. In view of the considerable fluctuations of fog density in time, as well as in space, a mean value established over a large number of samples or measurements is essential. Rapid changes in RVR may give rise to difficulties for the ATS units when transmitting the information to aircraft. For these reasons, an averaging period of between 30 s and 1 min is recommended, computed as a mean or a sliding mean.

The difference between the RVR derived by an observer or by instrumental equipment and the true RVR should not normally exceed the limits specified in Technical Regulation [C.3.1.], Attachment A.

2.5 **PRESENT WEATHER**

The observation and reporting of present weather is discussed in Part I, Chapter 14, and the procedures are described in Technical Regulation [C.3.1.] 4.6.4 with details in Technical Regulation [C.3.1.], Appendix 3, 4.4. For aviation, emphasis is placed upon observing and reporting the onset, cessation, intensity and location of phenomena of significance to the safe operation of aircraft, for example, thunderstorms, freezing precipitation and elements that restrict flight visibility.

For take-off and landing, present weather information should be representative, as far as practicable, of the take-off and climb-out area, or the approach and landing area. For information disseminated beyond the aerodrome, the observations of present weather should be representative of the aerodrome and its immediate vicinity.

Most observations relating to present weather are made by visual means. Care should be taken to select observing sites that afford adequate views in

all directions from the station. Instruments may be used to support the human observations, especially for measuring the intensity of precipitation.

Detectors used to identify the type of precipitation (rain, snow, drizzle, etc.) or visibility-reducing phenomena other than precipitation (fog, mist, smoke, dust, etc.) can assist the human observer and this can help if done by automation. They are based essentially on the measurement of the extinction coefficient or scintillation, and may also make use of relations between weather phenomena and other quantities, such as humidity. At present, there is no international agreement on the algorithms used for processing data to identify these phenomena. There is no vital need for this equipment in aeronautical meteorology while human observers are required to be present.

Descriptions of phenomena reported in present weather appear in Part I, Chapter 14, as well as in WMO (1975; 1987; 1992a; 1995) and ICAO (2004a).

Specifications for special reports regarding present weather are contained in Technical Regulation [C.3.1.], Appendix 3, 4.4.2. The abbreviations and code figures used in METAR or SPECI plain language reports appear in Technical Regulation [C.3.1.], Appendix 3, 4.4.2.3.-4.4.2.5.

2.6 **CLOUD**

2.6.1 **General**

Observations and measurements of clouds are discussed in Part I, Chapter 15. For aviation applications (see Technical Regulation [C.3.1.] 4.6.5 and Appendix 3, 4.5), cloud information (amount, base height, type) is required to be representative of the aerodrome and its immediate vicinity and, in reports for landing, of the approach area. Where cloud information is supplied to aircraft landing on precision approach runways, it should be representative of conditions at the instrument landing system middle marker site, or, at aerodromes where a middle marker beacon is not used, at a distance of 900 to 1 200 m from the landing threshold at the approach end of the runway (Technical Regulation [C.3.1.], Appendix 3, 4.5.1).

If the sky is obscured or not visible, the cloud base height is replaced by a vertical visibility in the local routine (MET REPORT) and local special (SPECIAL) reports (Technical Regulation [C.3.1.] 4.5.1(i) and

in weather reports METAR and SPECI (WMO, 1995, FM 15/FM 16, paragraph 15.9). Vertical visibility is defined as the maximum distance at which an observer can see and identify an object on the same vertical as himself or herself, above or below. Vertical visibility can be derived from the optical extinction profile, determined by a LIDAR-based ceilometer. Assuming that the total extinction σ at altitude h can be derived from the backscatter extinction coefficient σ_B at that altitude after appropriate calibration for the whole altitude range, and assuming that a contrast threshold of 5 per cent is applicable similar to MOR, it should hold for the vertical visibility VV that:

$$\int_0^{VV} \sigma(h) \cdot dh = \ln \left(\frac{I(VV)}{I_0} \right) = \ln(0.05) = 3 \quad (2.6)$$

Because LIDAR-based ceilometers determine the local extinction coefficient for fixed intervals h , VV may be derived relatively easily from:

$$\sum_{i=1}^N \sigma_i \cdot \Delta h = 3, \text{ with } h_N = VV \quad (2.7)$$

Typical code words like CAVOK, SKC (sky clear), NCD (no clouds detected) and NSC (nil significant clouds) are used in reports when the state of the atmospheric or weather will not affect the operations of take-off and landing; replacing the quantitative information with simple acronyms is beneficial. Details on the use of these practices are given in Technical Regulation [C.3.1.], Appendix 3, 2.2 and 4.5.4.1. For instance, CAVOK shall be used when cloud and present weather is better than the prescribed values or conditions, but if the specified conditions are met. Great care should be taken when using these abbreviations with automated measuring systems, which are not capable of measuring clouds or vertical visibility within the stated requirements.

The height of clouds bases should normally be reported above aerodrome elevation. However, when a precision approach runway is in use which has a threshold elevation of 15 m or more below the aerodrome elevation, local arrangements should be made in order that the height of the clouds reported to arriving aircraft should refer to the threshold elevation.

2.6.2 **Observation methods**

The principal methods used for determining the height of the cloud base are:

- (a) Cloud-base searchlight;
- (b) Rotating-beam ceilometer;
- (c) Laser ceilometer;
- (d) Ceiling balloon;
- (e) Visual estimation;
- (f) Aircraft reports.

Cloud-base height should be obtained by measurement whenever possible. At busy or international aerodromes with precision approach systems, cloud-base measurements should be taken automatically so that this information and any changes can be available on a continuous basis.

The ceiling-balloon method is too slow and too prone to errors to be a routine method for measuring cloud-base height at aerodromes, and the visual method is also too prone to error, especially at night, to be used where the observations are critical. Aircraft reports of cloud-base height can provide the observer with useful supplementary information. Care should be taken when interpreting pilots' information due to the fact that the information may be several kilometres from the surface observation point.

2.6.3 Accuracy of cloud-base height measurements

The ragged, diffuse and fluctuating nature of many cloud bases limit the degree of accuracy with which cloud-base heights can be measured. Isolated or infrequent measurements, such as those obtainable by the use of cloud-base height balloons, may be unrepresentative of the cloud conditions as a whole. The best estimate requires the study of a quasi-continuous recording over a period of several minutes provided by one of the instruments mentioned above.

The accuracy of instrumental measurements indicated by manufacturers is usually obtained by using solid or artificial targets. Operational accuracy is, however, more difficult to achieve in view of the fuzzy nature of the cloud base.

2.7 AIR TEMPERATURE

A general discussion of instruments and methods of observation for air temperature may be found in Part I, Chapter 2. For air navigation purposes (see Technical Regulation [C.3.1.] 4.1 and 4.5.1(j)), it is necessary to know the air temperature over the runway. Normally, data from well-sited, properly

ventilated screens give sufficient approximations of the required values. Rapid fluctuations in air temperature (2 to 3°C per half-hour) should be notified immediately to ATS units, principally in tropical and subtropical areas.

Temperature sensors should be exposed in such a way that they are not affected by moving or parked aircraft, and should yield values that are representative of general conditions over the runways. Thermometers with a time-constant of 20 s should preferably be used to avoid excessively small fluctuations in temperature (average wind speed of 5 m s⁻¹), or, in cases of automatic measurements, an appropriate digital averaging or resistance/capacitance filtering should be applied. Remote indicating and recording systems are an advantage. Moreover, aerodromes with runways intended for Category II and III instrument approach and landing operations, require automated measuring equipment and displays at the automatic retrieval system site. Temperature measurements have become more integrated into automatic stations or data acquisition systems, and are displayed in digital form. The displayed temperature should represent an average value over 1 to 10 min, obtained after linearization of the sensor output signal. The value obtained should be rounded off to the nearest whole degree for aeronautical use.

2.8 DEWPOINT

Atmospheric moisture at aeronautical stations is usually expressed in terms of the dewpoint temperature. The reading is rounded off to the nearest whole degree as in the case of air temperature. The procedures are described in Technical Regulation [C.3.1.] 4.1 and 4.5.1(j). Observation methods are described in Part I, Chapter 4.

Modern humidity sensors allow the use of remote indicators and recorders. For manual observations the psychrometer is commonly used. A psychrometer of the ventilated type is to be preferred to meet the stated measurement uncertainty. The types of instruments commonly in use are as follows:

- (a) Capacitive sensors based on the measurement of a capacitor's capacitance, in which the value of the polymer dielectric varies as a function of the water vapour content of the ambient air. In practice, the measured capacitance is fairly linear with relative humidity. Dewpoint is calculated using the

ambient air temperature (measured separately and at a very short distance) ($t_d = t_d(t, U)$). The appropriate formulae are given in Part I, Chapter 4, Annex 4.B. To avoid condensation, which may last long after $U < 100\%$ and which might be trapped by the filter protecting the sensor, the sensor may be heated. For such a practice, the ambient air temperature should not be used, rather a temperature value should be used that represents the heated air around the sensor. In practice, the appropriate procedure can only be achieved after careful calibration in well-designed climate chambers;

- (b) Dewpoint hygrometers, measuring the temperature at which a very light deposit of dew occurs on a mirror. The mirror is heated or cooled, most frequently by the Peltier effect, to obtain the point of equilibrium at which dew is deposited. The mirror is used with an associated photo-electronic dew-detection system. Although such systems deliver dewpoint temperature directly, pollution and deterioration of the mirror may cause significant biases. In particular, frost may destroy the mirror. At least every six months the mirror should be inspected, but only by skilled personnel. Great care should be taken when cleaning the mirror and the manufacturer's instructions should be followed precisely.

2.9 ATMOSPHERIC PRESSURE

2.9.1 General

A general discussion on the observations of atmospheric pressure may be found in Part I, Chapter 3, and that for aviation purposes is found in Technical Regulation [C.3.1.] 4.6.7. Pressure measurements for setting aircraft altimeters are essential at an aeronautical station. They are computed in tenths of hectopascals (0.1 hPa). They are referred to in the Q code as QFE and QNH, where:

- (a) QFE (field elevation pressure) is defined as the pressure value at an elevation corresponding to the official elevation of the aerodrome (Technical Regulation [C.3.1.], Appendix 3, 4.7.2). Aerodrome reference point, elevation and runway elevation are described in ICAO (2004b);
- (b) QNH (atmospheric pressure at nautical height) is defined as the pressure value at which an aircraft altimeter is set so that it will indicate the official elevation of the aerodrome when

the aircraft is on the ground at that location. QNH is calculated using the value for QFE and the pressure altitude relationship of the ICAO standard atmosphere. In fact, the ICAO standard atmosphere is a sub-range of the International Standard Atmosphere, which is documented by the ISO the 2533:1975 standard and developed in liaison with the Committee on Space Research, ICAO and WMO. This standard atmosphere is a static atmosphere, with a fixed pressure and temperature at sea level and a fixed temperature gradient. Details of the standard atmosphere and its predefined constants are given in WMO (1966) and ICAO (1993). For the calculation of QNH from QFE, namely the reduction to mean sea level, this virtual atmosphere is used, and not the current true state of the atmosphere. As a consequence, QNH will differ from the reported atmospheric pressure reduced to sea level as described in Part I, Chapter 3, section 3.11 and for which the actual temperature is used. The calculation of QNH from QFE is based on a slide rule relationship (for stations below about 3 000 to 4 000 m):

$$QNH = A + B \times QFE \quad (2.8)$$

where A and B depend on the geopotential altitude of the station (for details, see WMO, 1966, Introduction to Table 3.10). To derive QNH, the following three-step procedure should be followed:

- (i) Determine the pressure altitude of the station from the QFE (the pressure altitude is calculated from QFE using the formulae of the standard atmosphere);
- (ii) Subtract (or add for stations below mean sea level) from this pressure altitude the elevation of the station with respect to mean sea level to give the pressure altitude at mean sea level (may be positive or negative);
- (iii) Derive from this pressure altitude the associated pressure value according to the standard atmosphere, which will be QNH.

An example of this procedure to derive QNH from QFE is shown in the figure below. The measured pressure and QNH and/or QFE values should be computed in tenths of a hectopascal. In local reports and reports disseminated beyond the aerodrome, QNH and QFE values should be included and the values should be rounded down to the nearest whole hectopascal. The ATS units,

should be notified of rapid major changes in pressure.

The curve represents the standard atmosphere (pressure altitude as a function of pressure).

2.9.2 Instruments and exposure

The instrumental equipment used at an aeronautical station for pressure measurement is identical to that at a synoptic station, except that greater use is often made of precision automatic digital barometers for convenience and speed of reading in routine observations. Aeronautical stations should be equipped with one or more well-calibrated barometers traceable to a standard reference. A regular schedule should be maintained for comparing the instruments against this standard instrument. Both manual and automated barometers are suitable, provided that temperature dependence, drift and hysteresis are sufficiently compensated. Details of suitable barometers are given in Part I, Chapter 3.

The exposure of barometers at an aeronautical station is the same as at a synoptic station. If barometers have to be exposed inside a building, sensors should be vented to the outside, using an appropriately located static-tube arrangement. Owing to wind impacts on a building, pressure differences inside and outside the building may be larger than 1 hPa. To prevent such bias, which may extend to about plus or minus 3 hPa with high wind speeds,

the static-tube should be placed sufficiently far away from this building. Also, air conditioning may have impacts on pressure measurements, which will be avoided by using such a static tube.

Direct-reading instruments for obtaining QNH values are available and may be used in place of the ordinary aneroid or mercury barometer, which require reference to tables in order to obtain the QNH values. For such devices, correct values of *A* and *B*, which are a function the station geopotential altitude (see equation 2.8), shall be entered. The readings given by these instruments must be compared periodically with QNH values calculated on the basis of measurements obtained using the mercury barometer.

2.9.3 Accuracy of and corrections to pressure measurements

Pressure values used for setting aircraft altimeters should have a measurement uncertainty to 0.5 hPa or better (Technical Regulation [C.3.1.], Attachment A). All applicable corrections should be applied to mercury barometer readings, and corrections established through regular comparisons between the mercury and aneroid instruments routinely used in observations must be applied to all values obtained from the latter instruments. Where aneroid altimeters are used in ATS tower positions, corrections different from those used in the observing station must be provided, for proper

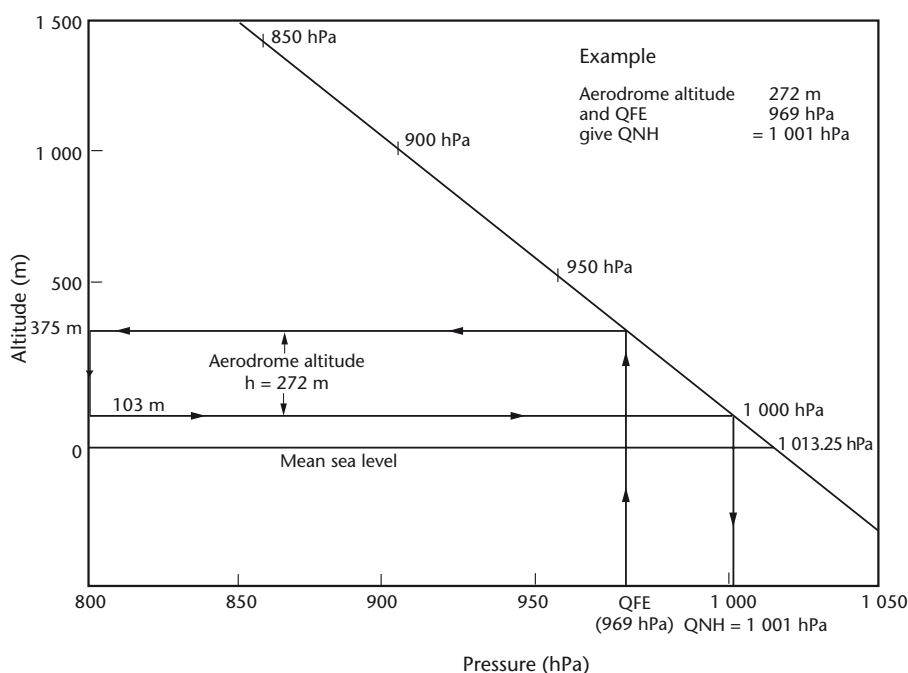

Figure 2.1. The relation between QFE and QNH

reduction to official aerodrome or runway level (Technical Regulation [C.3.1.], Appendix 3, 4.7).

The pressure values used for setting altimeters must refer to the official elevation for the aerodrome. For non-precision approach runways, the thresholds of which are 2 m or more below or above the aerodrome elevation, and for precision approach runways, the QFE, if required, should refer to the relevant threshold elevation.

2.10 OTHER SIGNIFICANT INFORMATION AT AERODROMES

2.10.1 General

Observations made at aeronautical stations should also include any available information on meteorological conditions in the approach and climb-out areas relating to the location of cumulonimbus or thunderstorms, moderate or severe turbulence, horizontal and/or vertical wind shear and significant variations in the wind along the flight path, hail, severe line squalls, moderate or severe icing, freezing precipitation, marked mountain waves, sandstorms, dust storms, blowing snow or funnel clouds (tornadoes or waterspouts), for example, SURFACE WIND 320/10 WIND AT 60M 360/25 IN APCH or MOD TURB AND ICE INC IN CLIMB OUT.

2.10.2 Slant visual range

Despite the development work carried out in various countries, no instrument for measuring the slant visual range has been made operational. The rapid technological development of all-weather landing systems has made it possible to reduce the set landing minima at aerodromes (Categories II, III A and III B) and has gradually resulted in this parameter being considered less important. No recommendation has been established for measuring this parameter.

2.10.3 Wind shear

Wind shear is a spatial change in wind speed and/or direction (including updraughts and down-draughts). Wind shear intensity may be classified into light, moderate, strong or violent according to its effect on aircraft. Low-level wind shear, that may affect landing and take-off operations, may exist as a vertical wind gradient in the lower layers of a thermally stable atmosphere, or it may be due to the effect of obstacles and frontal surfaces on

wind flow, the effect of land and sea breezes, and to wind conditions in and around convection clouds, particularly storm clouds. Violent storms are by far the major cause of low-level wind shear, and a cause of fatal accidents for aircraft both on approach and landing, and during take-off.

The preparation and issuing of wind-shear warnings for climb-out and approach paths are described in Technical Regulation [C.3.1.], Appendix 3, 4.8.1.3.

The measurement of vertical wind shear based on the information presented in Part I, Chapter 5, may be determined directly by anemometers on tall masts, which must be at a certain distance from the airport. Remote-sensing systems include Doppler Radar, Lidar, Sodar and the wind profiler. The Lidar uses laser light, the Sodar is based on acoustic radiation, and the wind profiler radar employs electromagnetic radiation at a frequency of around 50 MHz, 400 MHz or 1 000 MHz.

Horizontal wind shear is usually detected by a system of anemometers over the entire aerodrome. This system is designated as a low-level wind shear alert system. Computer-processed algorithms enable a wind-shear warning to be given. This system is used particularly in tropical and subtropical regions where frequent, intense storm build-up occurs.

Global coverage of this subject is given in the *ICAO Manual on Low-level Wind Shear and Turbulence* (Doc. 9817), first edition, 2005.

Although wind shear may have a significant impact on aircraft operations, no recommendation or criteria has yet been established. Nevertheless, details on wind-shear warnings are given in ICAO (2004a).

2.10.4 Marked temperature inversions

Information on marked temperature inversions exceeding 10°C between the surface and levels up to 300 m should be provided, if available. Data are usually obtained from balloon-borne radiosondes, remote sensing, aircraft observations (for example, AMDAR) or by meteorological inference.

2.11 AUTOMATED METEOROLOGICAL OBSERVING SYSTEMS

Specially-designed instrument systems have become common practice at aeronautical stations for measuring, processing, remotely indicating

and recording values of the various meteorological parameters representative of the approach, landing, take-off and general runway conditions at the airport (Technical Regulation [C.3.1.] 4.1).

These automated systems comprise the following:

- (a) An acquisition system for converting electrical analogue measurements (volts, milliamperes, resistance, capacitance) to digital values in the appropriate units, and for the direct introduction of digital data;
- (b) A data pre-processing unit (averaging of readings over a time period of 1 to 10 min depending on the parameter measured and minimum, maximum and average values for the various parameters);
- (c) A computer, used, for example, to prepare SYNOP, METAR and SPECI reports, and telecommunication software.

The observer should be able to include in these reports those parameters which are not measured by the automatic station; these may include present weather, past weather, cloud (type and amount) and, sometimes, visibility. For aviation purposes, these stations are, therefore, often only an aid for acquiring meteorological data and cannot operate without observers.

Instruments at the automatic station should be checked and inspected regularly. Quality checks are necessary and recommended in order to avoid major errors and equipment drift. Measurements taken by automatic weather stations are dealt with in detail in Part II, Chapter 1. Quality assurance and other management issues can be found in Part III, Chapter 1. To guarantee the stated performance of the automated instruments, a detailed evaluation plan should be established with details on maintenance and calibration intervals, and with feedback procedures to improve the observing system.

Recommendations on reporting meteorological information from automatic observing systems are given in Technical Regulation [C.3.1.], Appendix 3, 4.9.

2.12 RADAR

At aerodromes with heavy traffic, weather radars have become indispensable since they provide effective, permanent, real-time surveillance by producing additional observations to the usual meteorological observations for landings and

take-offs. A radar can provide information over a wider area of up to 150 to 200 km. It is also an aid to short-range forecasting – within the hour or a few hours following the observation (possible aid in preparing the TREND report).

The echoes received are interpreted to identify the type of precipitation around the station: precipitation from stratus or convective clouds; isolated or line precipitation; or precipitation due to storms and, under certain conditions, detection of precipitation in the form of snow or hail. The image received enables the paths of squall lines or fronts to be followed and their development (intensification or weakening) to be monitored. If the radar is equipped with a Doppler system, the speed and direction of movement of these echoes can be computed.

The most widely used radars operate on wavelengths of 3, 5 or 10 cm. The choice depends on the region of the globe and the intended purpose, but the present general trend is towards the use of a 5 cm wavelength.

In certain regions, centralizing centres collect radar images from a series of radar stations in the country or region and assemble a composite image. Images are also exchanged between the various centres so that radar protection is provided over the largest possible area.

A general discussion on radar observations may be found in Part II, Chapter 9.

2.13 ICE SENSOR

This type of instrument, described in Part I, Chapter 14, is installed at a number of aerodromes to provide information on runway conditions in winter. The temperature at the surface and a few centimetres below the runway, the presence of snow, water, clear ice or white ice and the presence of salts or de-icing products, if any, are measured or detected. These sensors, in the form of a compact unit, are placed at a certain number of points on the runways or taxiways with their number depending on the size of the aerodrome and the number of runways to be protected. Atmospheric sensors are also placed close to the runways for the measurement of air temperature and humidity, wind and precipitation.

A data-acquisition and data-processing system displays the parameters measured and their variations with time. Depending on the type of software

used, warning systems alert the airport authority responsible for aerodrome operations to the presence of clear ice or forecasts of dangerous conditions for aircraft.

2.14 **LIGHTNING DETECTION**

Systems for locating thunderstorms based on the detection of the low-frequency electromagnetic radiation from lightning have been developed in recent years (see Part II, Chapter 7). These systems measure the time taken for the signal to arrive and/or the direction from which it comes. Also, some systems analyse the characteristics of each radio impulse to identify cloud-to-ground lightning strokes. In certain regions, a number of these units are installed to measure and locate these phenomena in an area of 50 to 100 km around the aerodrome.

However, these systems are still not very widely used at aerodromes and no recommendation concerning their use has yet been formulated.

2.15 **OTHER RELEVANT OBSERVATIONS**

Additional information should be provided if the atmosphere is affected by dangerous pollution, for example, during volcanic eruptions. Information should also be provided to support rescue operations, especially at off-shore stations. If relevant for aircraft operations during take-off and landing, information on the state of the runway should be reported in METAR and SPECI, provided by the appropriate airport authority.

Volcanic ash should be reported (in SIGMET reports) as part of the supplementary information (Technical Regulation [C.3.1.], Appendix 3, 4.8). Details on observing volcanic ash, radioactive material and toxic chemical clouds are given in ICAO (2001, 2004c).

In METAR and SPECI, information on sea-surface temperature and the state of the sea should be included from aeronautical meteorological stations established on offshore structures in support of helicopter operations (Technical Regulation [C.3.1.], Appendix 3, 4.8.1.4).

REFERENCES AND FURTHER READING

- Committee on Low-Altitude Wind Shear and its Hazard to Aviation, 1983: *Low-Altitude Wind Shear and Hazard to Aviation*. National Academy Press, Washington DC (<http://www.nap.edu/books/0309034329/html/>).
- International Civil Aviation Organization, 1993: *Manual of the ICAO Standard Atmosphere (extended to 80 kilometres)*. Third edition, Doc. 7488, Montreal.
- International Civil Aviation Organization, 1996: *Manual on the Provision of Meteorological Service for International Helicopter Operations*. Doc. 9680, Montreal.
- International Civil Aviation Organization, 2000: *Manual of Runway Visual Range Observing and Reporting Practices*. Second edition, Doc. 9328, Montreal.
- International Civil Aviation Organization, 2001: *Manual on Volcanic Ash, Radioactive Material and Toxic Chemical Clouds*. Doc. 9691, Montreal.
- International Civil Aviation Organization, 2004a: *Manual of Aeronautical Meteorological Practice*. Chapter 2 and Appendix D. Sixth edition, Doc. 8896, Montreal.
- International Civil Aviation Organization, 2004b: *Aerodromes*. ICAO Annex 14, Volume I, Montreal.
- International Civil Aviation Organization, 2004c: *Handbook on the International Airways Volcano Watch (IAVW)*. Second edition, Doc. 9766, Montreal.
- World Meteorological Organization, 1966: *International Meteorological Tables* (S. Letestu). (with 1973 amendments), WMO-No. 188, Geneva.
- World Meteorological Organization, 1975: *International Cloud Atlas: Manual on the Observation of Clouds and Other Meteors*. Volume I, WMO-No. 407, Geneva.
- World Meteorological Organization, 1987: *International Cloud Atlas*. Volume II, WMO-No. 407, Geneva.
- World Meteorological Organization, 1990a: *Guide on Meteorological Observation and Information Distribution Systems at Aerodromes*. WMO-No. 731, Geneva.
- World Meteorological Organization, 1990b: *The First WMO Intercomparison of Visibility Measurements: Final Report* (D.J. Griggs, D.W. Jones, M. Ouldrige, W. R. Sparks). Instruments and Observing Methods Report No. 41, WMO/TD-No. 401, Geneva.
- World Meteorological Organization, 1992a: *International Meteorological Vocabulary*. Second edition, WMO-No. 182, Geneva.
- World Meteorological Organization, 1992b: *Visibility measuring instruments: Differences between scatterometers and transmissometers* (J.P. van der Meulen). *Papers Presented at the WMO Technical Conference on Instruments and Methods of Observation (TECO-92)*. Instruments and Observing Methods Report No. 49, WMO/TD-No. 462, Geneva.
- World Meteorological Organization, 1995: *Manual on Codes*. Volume I.1, WMO-No. 306, Geneva.
- World Meteorological Organization, 2002: *Guidelines for the Education and Training of Personnel in Meteorology and Operational Hydrology*. Volume I, Fourth edition, WMO-No. 258, Geneva.
- World Meteorological Organization, 2003: *Guide to Practices for Meteorological Offices Serving Aviation*. Second edition, WMO-No. 732, Geneva.
- World Meteorological Organization, 2004: *Technical Regulations*. Volume II, WMO-No. 49, Geneva.
-

CHAPTER 3

AIRCRAFT OBSERVATIONS

3.1 GENERAL

3.1.1 Definitions

This chapter describes the methods used for automatic meteorological measurements on modern commercial aircraft, known collectively as aircraft meteorological data relay (AMDAR) systems. The principles described here may be used for data processing on any instrumented aircraft. Additional information is available in WMO (2003).

Automatic long-range pilotless aircraft dedicated to meteorological operations, such as the aerosonde (Holland, McGeer and Youngren, 1992) have been developed. They are not likely to be deployed in large numbers and are not described here.

Aircraft meteorological data relay systems operate on aircraft that are equipped with sophisticated navigation and other sensing systems. There are sensors for measuring air speed, air temperature and air pressure. Other data relating to aircraft position, acceleration and orientation are available from the aircraft navigation system. The aircraft also carry airborne computers for the flight management and navigation systems, by which navigation and meteorological data are computed continuously and are made available to the aircrew at the flight deck. In AMDAR systems, they are further processed and fed automatically to the aircraft communication system for transmission to the ground, or, alternatively, a dedicated processing package can be used on the aircraft to access raw data from the aircraft systems and derive the meteorological variables independently.

In AMDAR systems, these facilities are used to compile and transmit meteorological reports in real time. Normally, the messages contain wind speed and direction (in the horizontal plane), air temperature, altitude (related to a reference pressure level), a measure of turbulence, time of observation, phase of flight and the aircraft position.

The source data for meteorological observations require significant correction and complex processing to yield meteorological measurements that are representative of the free air-stream in

the aircraft vicinity. A full description of all the processes involved is beyond the scope of this Guide, but an outline of the principles is given here, and there are references for further reading.

3.1.2 Aircraft meteorological sensors

The basic sensors carried on modern commercial aircraft comprise the pitot-static probe and the total air temperature (TAT) probe. Data from these sensors, together with information from the aircraft navigation system, usually provided by one or a combination of radio navaid systems (Global Positioning System, GPS), distance-measuring equipment, VHF omni-directional radio range, an instrument landing system and in some cases an inertial reference system, are processed to give the following meteorological elements:

- (a) Pressure altitude, position and time;
- (b) Static air temperature (SAT);
- (c) Wind speed;
- (d) Wind direction.

On some aircraft, additional processing for measuring turbulence is available or additional sensors are available for measuring ice build-up on the flying surfaces and/or for measuring relative humidity or water vapour mixing ratio (WVMR).

In order to appreciate the complexity of the processing system, the following description is structured according to the process flow in a typical operational system. It will be noted (Figure 3.1) that the computed variables are highly interdependent.

3.2 PRESSURE AND MACH NUMBER

3.2.1 Pitot-static probe

The pitot-static probe (Figure 3.2) is exposed in the free air-stream beyond the aircraft boundary layer and measures static pressure (i.e. free air-stream pressure) and total pressure (static pressure, and impact or dynamic) pressure. The sensor outputs are passed via an electronic barometer to the air data computer (ADC). The ADC computes pressure altitude and Mach number from these two measurements.

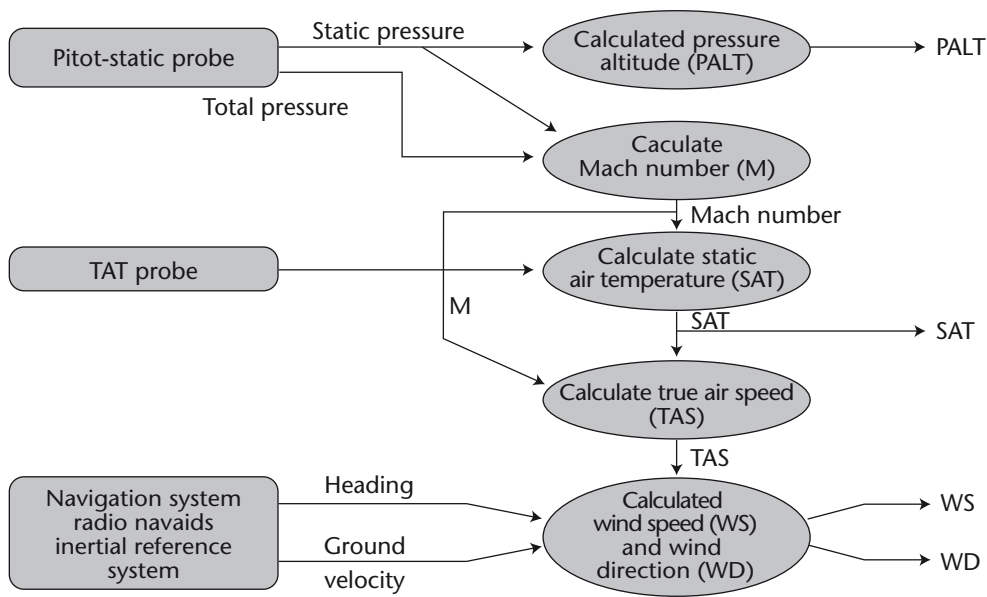

Figure 3.1. AMDAR sensor data processing

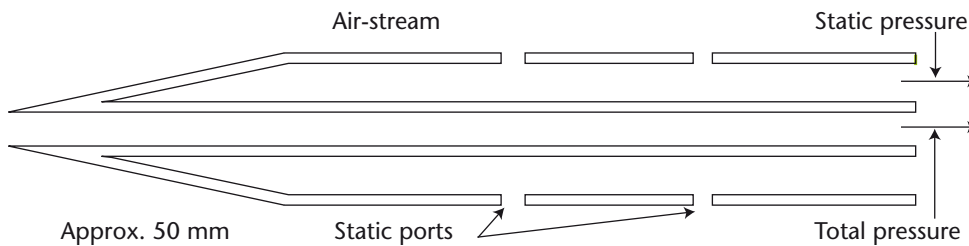

Figure 3.2. Pitot-static probe

3.2.2 Pressure altitude

The static pressure measurement is not normally reported in AMDAR but is converted in the ADC to the equivalent altitude based on the International Standard Atmosphere (ICAO, 1964). The standard atmosphere (see Figure 3.3) assumes a linear decrease in temperature with height of 6.5°C per km up to 11 m or 36 089 ft, and a mean sea-level temperature and pressure of 15°C and 1 013.25 hPa, respectively. From 11 km to 20 km the temperature is assumed constant at -56.5°C.

For pressure altitude (PALT) equal to or less than 36 089 ft, static pressure is related to PALT by the following expression:

$$P \text{ (hPa)} = 101.325 \cdot (1 - 10^{-6} \cdot 6.875 \cdot 6 \cdot (\text{PALT}))^{5.2559} \quad (3.1)$$

For example, if PALT is 30 000 ft, $P = 300.9$ hPa.

The above expression can be used directly if the aircraft altimeter sub-scale (zero-reference) is set to standard pressure (1 013.25 hPa). In this case, PALT is identical to the indicated altitude. Navigational procedures also provide for altimeter sub-scale settings at other reference levels. For example, the setting can be aerodrome pressure (field elevation pressure, QFE) or QNH (atmospheric pressure at nautical height), which is a pressure reference on the standard atmosphere scale such that aerodrome height is indicated at touchdown on a specific airfield. Thus, in general, PALT is given by the indicated altitude plus the altitude of the altimeter sub-scale reference on the standard atmosphere scale. The general expression is:

$$\text{PALT (ft)} = H_i + H_r \quad (3.2)$$

$$H_r = (1 - (P_r/101.325)^{0.1903}) \cdot 10^6 / 6.875 \cdot 6 \quad (3.3)$$

where H_i is the indicated altitude; H_r is the height of the reference pressure; and P_r (hPa) is the altimeter sub-scale setting. (Note that $H_r = 0$ if $P_r = 1\ 013.25$ hPa.)

For example:

- (a) If the sub-scale setting is a QNH value of 1 000.0 hPa and the indicated altitude is 9 335 ft, PALT = 9 335 + 364 = 9 699 ft and P = 705 hPa;
- (b) If the sub-scale setting is a QFE value 990 hPa, the aerodrome height is 276 ft and the indicated altitude is 9 058 ft, PALT = 9 058 + 641 = 9 699 ft and the QNH value would be 1 000 hPa.

If PALT is greater than 36 089 ft, static pressure is given by:

$$P \text{ (hPa)} = 226.32 - (PALT - 36\ 089) / 20\ 805 \quad (3.4)$$

For example, if PALT is 40 000 ft, P = 187.5 hPa.

3.2.2.1 Measurement uncertainty

Sources of error include:

- (a) Calibration error;
- (b) Short-term random instrument error;
- (c) Calibration drift;
- (d) Exposure error or static source error.

Because aircraft safety separations are critical, these errors are corrected as much as possible in the ADC. Static source error, which is a function of probe location, Mach number and angle of attack, is

determined empirically during flight-testing. Uncertainty of pressure is inferred from reported heights.

AMDAR heights, as coded in WMO, 1995, are reported in hundreds of feet, equivalent at cruise level to some 1.5 hPa. This represents roughly 0.1 per cent of the full scale pressure measurement; with instrumental accuracy at best of the order 0.05 per cent, the uncertainty in static pressure at cruise level derived from converting pressure altitude is about 2 hPa. At zero reference level, the resolution is equivalent to about 3.5 hPa, leading to an uncertainty of some 4.0 hPa.

3.2.3 Mach number

Mach number (M , the true air speed divided by the speed of sound in the free air) is an important element for aircraft operations. In AMDAR systems, it is used to correct air-temperature measurements and air speed measurements. In dry air, the speed of sound is proportional to the square root of absolute (static) temperature. However, because SAT is not measured directly by the aircraft sensors, an independent method of measuring the Mach number is employed. The equation for M is:

$$M^2 = \frac{2}{(\gamma - 1)} \left[\left(\frac{p_s}{p_0} \right)^{\frac{\gamma - 1}{\gamma}} - 1 \right] \quad (3.5)$$

where p_0 is static pressure (in the undisturbed air-stream); p_s is total pressure (both available from the pitot-static probe); and γ is the ratio of specific heats

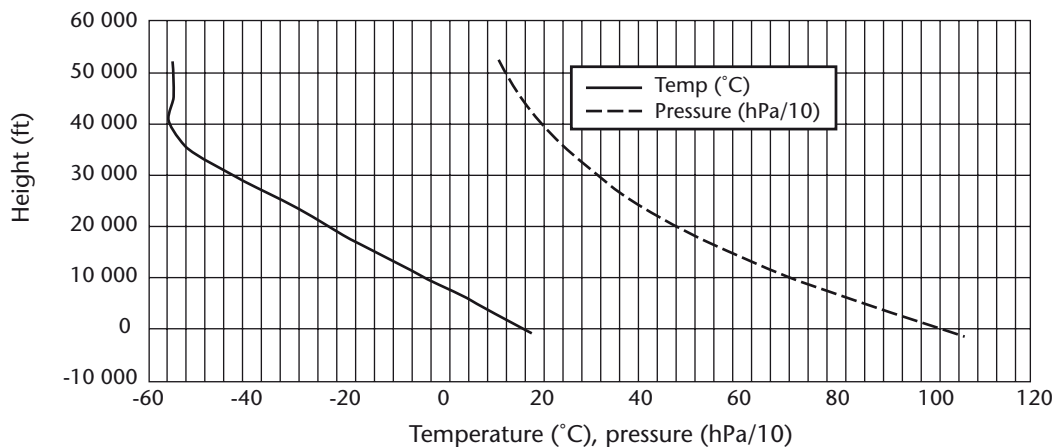

Figure 3.3. ICAO Standard Atmosphere

of dry air (C_p and C_v). For further details, see the standard texts on aircraft aerodynamics such as Abbott and von Doenhoff (1959) and Dommasch, Sherby and Connolly (1958).

3.2.3.1 Measurement uncertainty

The measurement accuracy is determined almost entirely by the accuracy of the fundamental measurements of pressure. In normal operation (with the pitot-static probe properly aligned and exposed to the free air-stream), the derived Mach number should be accurate to better than 0.2 per cent.

3.3 AIR TEMPERATURE

3.3.1 Total air temperature probe

The TAT probe is exposed in the free air-stream and used to derive static (free air-stream) temperature. The accurate measurement of air temperature is fundamental to the other derived meteorological elements. For example, it is used in the calculation of true air speed and thus has an impact on the

calculation of the wind velocity components. The ADC corrects the temperature actually measured by the probe using the computed Mach number.

Most commercial aircraft are equipped with TAT probes of the immersion thermometer type. Figure 3.4 shows a typical example. The sensing element is a platinum resistance thermometer. The housing is designed to divert cloud hydrometeors from the sensing element, although it has been reported (Lawson and Cooper, 1990) that the sensing element becomes wet in cumulus clouds.

The temperature (T_1) measured by the probe is close to the theoretical value of TAT that would occur with perfect adiabatic compression of the free air-stream at the sensor probe. The SAT (T_0 , in K), which is the temperature of the free air-stream, is related to the measured temperature by the expression:

$$T_0 = \frac{T_1}{\left(1 + \lambda \frac{(\gamma - 1)}{2} M^2\right)} \tag{3.6}$$

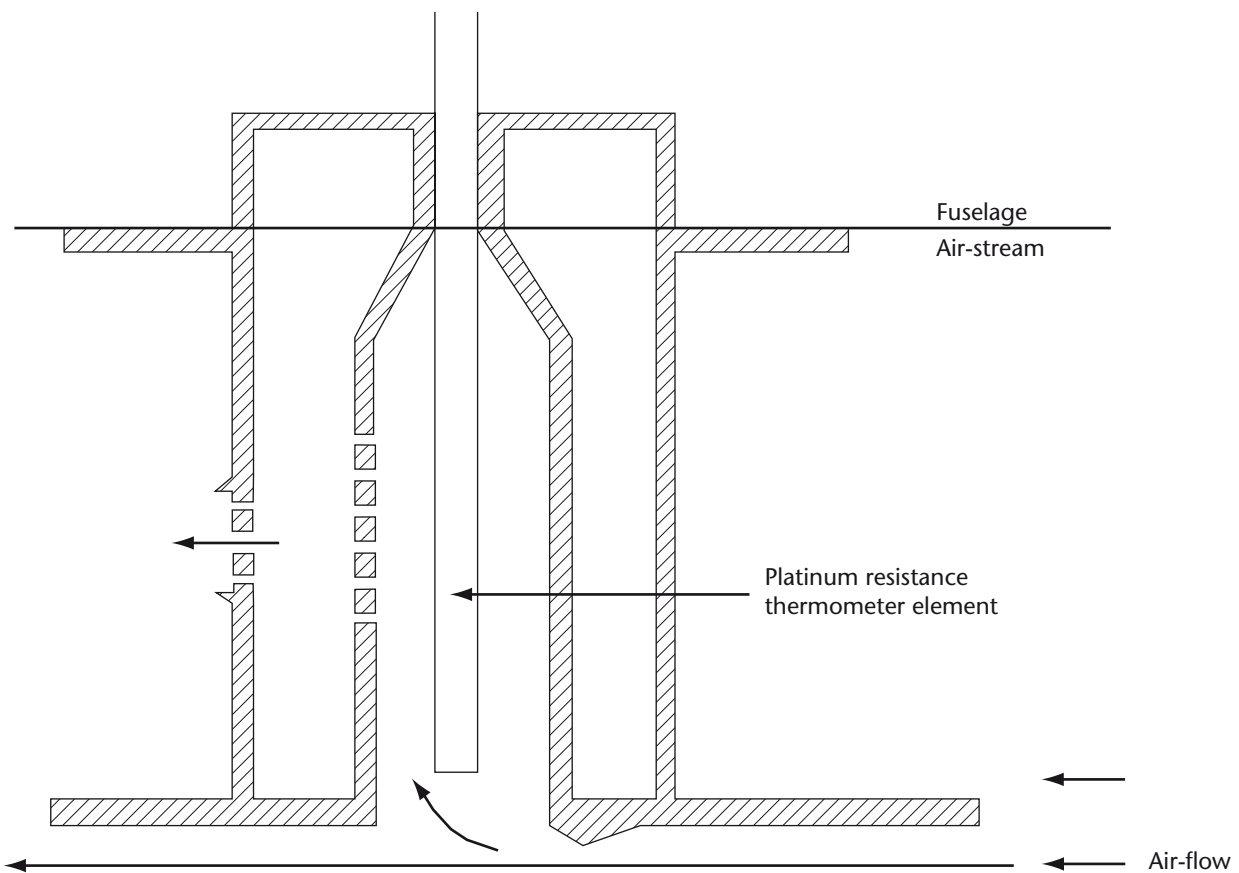

Figure 3.4. Aircraft thermometer probe

where λ is the probe recovery factor, which includes the effect of viscosity and the effect of incomplete stagnation of air at the sensor. T_1 includes compensation for heat applied for de-icing, if appropriate.

For the most common probe in service on commercial aircraft $\lambda = 0.97$, and thus given $\gamma = 1.4$, the SAT becomes:

$$T_0 = T_1 / (1 + 0.194M^2) \text{ K} \quad (3.7)$$

Typical commercial jet aircraft cruise at a Mach number near 0.8, thus giving:

$$T_0 \approx T_1 / 1.124 \quad (3.8)$$

namely, if $T_0 = 223 \text{ K}$ (-50°C), then:

$$T_1 = 251 \text{ K} \text{ } (-22^\circ\text{C}) \quad (3.9)$$

Thus, a typical temperature correction at cruise level is -28°C .

3.3.1.1 Measurement uncertainty

SAT is a function of probe temperature and Mach number. As shown above, the Mach number is derived from total pressure and static pressure, themselves independent measurements from the pitot-static head. The uncertainty of measurement is therefore a function of three error sources in addition to errors of calibration and correction for

exposure and other effects (for example, probe de-icing).

The temperature error (ΔT_0) is related to Mach number error (ΔM) by the following expression:

$$\Delta T_0 = 0.388MT_1(1 + 0.194M^2)^{-2} \Delta M \quad (3.10)$$

Taking these various factors into account, the uncertainty of calculated SAT is some 0.4°C at Mach 0.8, reducing to 0.3°C at low Mach numbers. Temperature data are typically stored as 11-bit binary words, thus the uncertainty of each stored value will increase by about 0.25°C . If the sensor is wetted in cloud, it will be cooled by evaporation leading to additional errors up to 3°C or so. At very low air speed (for example prior to take-off) there may be insufficient air-flow over the sensor to maintain the accuracy of measurement. Some aircraft employ aspirated sensors to overcome this problem. However, such measurements are usually outside the AMDAR observational range and may be neglected in AMDAR error considerations. Despite the complexity of the data processing involved, operational experience with aircraft to satellite data relay (ASDAR) (WMO, 1992) suggests that mean-temperature errors at cruise height are around 1°C .

3.4 WIND SPEED AND DIRECTION

The measurement of the three-dimensional wind vector from an aircraft is a complicated procedure. Using data from the aircraft navigation system (usually a radio navaid system) and the air speed system (usually a pitot-static tube), together with data from the temperature sensors, it is possible to estimate to a high degree of accuracy the velocity (V_g) of the aircraft with respect to the Earth and the velocity of the air (V_a) with respect to the aircraft. The wind vector (V), therefore, is given by:

$$V = V_g - V_a \quad (3.11)$$

The vectors V_g and V_a must be measured accurately since typical horizontal winds are small ($\leq 30 \text{ ms}^{-1}$) compared with aircraft ground speed and true air speed (200 to 300 ms^{-1}). Early AMDAR systems depended on data derived from inertial navigation systems for primary long-range navigation that required information on pitch, yaw, angle of attack and roll angles to resolve fully the wind vector. However, this is no longer necessary with modern multi-sensor navigation systems, in

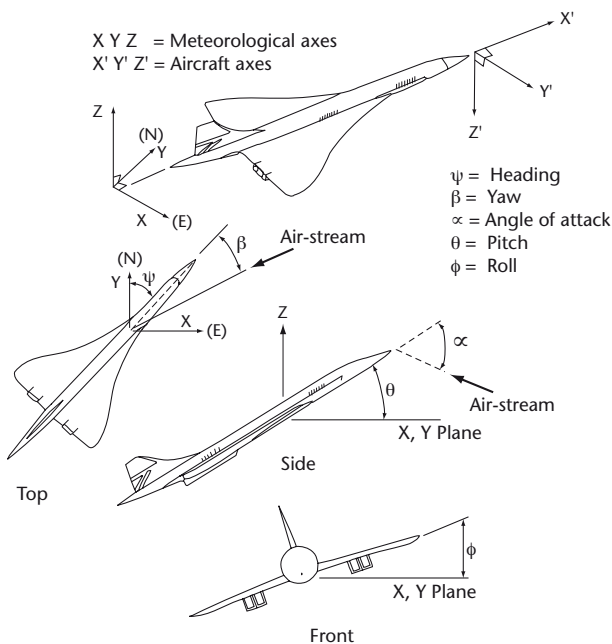

Figure 3.5. Aircraft reference axes and attitude angles

order to produce operational quality data (Meteorological Service of Canada, 2003). However, when an inertial navigation system is used, the full resolution of the vectors requires measurements of aircraft pitch, roll and yaw and vertical angle of attack with respect to the air-stream (Figure 3.5). In normal level flight, pitch, yaw and angle of attack are very small and can be neglected. However, errors during manoeuvres can be significant, but manoeuvres usually involve a substantial roll angle, so wind data are usually excluded when the roll angle is above a threshold (typically 3 to 5 degrees).

For most applications, only the horizontal component of the wind is measured. The input data requirement reduces to air speed, heading and ground velocity. Heading and ground velocity are taken from the navigation system. True air speed must be calculated from the Mach number and SAT. The components of the horizontal wind (u, v) are:

$$u = -V_a / \sin\phi + u_g \quad (3.12)$$

$$v = -V_a / \cos\phi + v_g \quad (3.13)$$

where V_a is the magnitude of the true air speed; ϕ is the heading relative to true north; and u_g and v_g are the components of ground velocity.

3.4.1 Measurement uncertainty

True air speed is a function of the Mach number and SAT:

$$V_a \text{ (kt)} = 38.867MT_0^{1/2} \quad (3.14)$$

$$V_a \text{ (kt)} = 38.867T_1^{1/2}M/(1 + 0.194M^2)^{1/2} \quad (3.15)$$

If errors exist in both Mach number and SAT, the total error is given by:

$$\Delta V_a = 38.867T_0^{1/2} \Delta M + 19.433MT_0^{-1/2} \Delta T_0 \quad (3.16)$$

where ΔV_a is wind error; ΔM is Mach error; and ΔT_0 is temperature error. Note from equation 3.10 that Mach error also contributes to temperature error.

Unless gross temperature errors exist, the Mach number uncertainty can be the most significant. For example, with a Mach number error of 0.2 per cent at cruise level, air speed error is some 1 kt (0.5 m s^{-1}). Thus, with zero error from the navigation system, wind vector errors up to 0.5 m s^{-1} are to be expected and are also depend-

ent on the angle between the wind at flight level and the aircraft heading. Note, however, that gross temperature errors will lead to gross wind errors.

Errors in true air speed combine with errors from the inertial reference unit. The basic calculations assume perfect alignment of the aircraft with the air-stream and zero roll, pitch and yaw and perfect inertial platform alignment. At high pitch/roll angles, wind vector errors, which are proportional to true air speed, can be significant. For example, at an air speed of 150 kt with 5° pitch and 10° roll, a wind vector error of some 2 kt (1 ms^{-1}) can be expected regardless of the true wind vector. At 300 kt air speed, the wind error doubles to 4 kt (2 ms^{-1}). At low wind speeds, vector errors can lead to large errors in wind direction. Thus, a more useful indication, considering all of the above error sources and combining wind speed and direction error as vector error, would suggest a typical uncertainty of 4-6 kt ($2-3 \text{ ms}^{-1}$). These estimates are in line with operational experience (see, e.g., Nash, 1994).

3.5 TURBULENCE

Turbulence, especially clear-air turbulence (turbulence in the absence of clouds), is an important and potentially dangerous phenomenon in aviation. Although for routine commercial operations flight paths are designed to avoid turbulence, inevitably aircraft will experience unexpected bumpiness and the departure from normal level flight can be measured by the aircraft instrumentation.

3.5.1 Turbulence from vertical acceleration

Vertical acceleration (normal to the aircraft horizontal reference plane) is measured in the inertial reference unit. The data output is referenced and scaled to the acceleration due to gravity and may be categorized as shown in the table below. However, the severity of turbulence affecting an aircraft depends principally on air speed, the mass of the aircraft, the altitude and the nature of the turbulence itself. Hence, reports of turbulence from an aircraft derived from peak acceleration according to the crude relationships given in the table are of limited application and are aircraft-specific because a given gust will have different effects on different aircraft.

Scale of turbulence, defined by peak acceleration

Turbulence category	Peak acceleration ^a
None	Less than 0.15 g
Light	0.15 g to, but not including, 0.5 g
Moderate	0.5 g to 1.0 g
Severe	Greater than 1.0 g

^a These accelerations, which may be positive or negative, are departures from the normal acceleration of gravity (1.0 g).

3.5.1.1 Measurement uncertainty

There are two main sources of error in the aircraft instrumentation, namely the “zero”, or reference, error and the output calibration (measurement) error. For most aircraft, the reference value is nominally +1.0 g, but this can vary typically by 3 per cent. This error can be virtually eliminated by correction when the aircraft is on the ground, leaving a residual (including measurement) error of about 3 per cent of measurement (Sherman, 1985).

3.5.2 Derived equivalent vertical gust velocity

An alternative indicator of turbulence is the derived equivalent vertical gust velocity (DEVG), defined as the instantaneous vertical gust velocity, which, superimposed on a steady horizontal wind, would produce the measured acceleration of the aircraft. The effect of a gust on an aircraft depends on the mass and other characteristics, but these can be taken into account so that a gust velocity can be calculated which is independent of the aircraft. The derived equivalent vertical gust is given (Sherman, 1985) by:

$$U_{de} = \frac{Am\Delta n}{V_c} \quad (3.17)$$

where U_{de} is the derived equivalent gust velocity; n is the modulus of the peak deviation of the aircraft vertical acceleration from 1 g in units of g ; m is the total mass; V_c is the calibrated air speed at the time of the occurrence of the acceleration peak; and A is a parameter that depends on the aircraft type, and weakly on the mass, the altitude and the Mach number.

3.5.2.1 Measurement uncertainty

Errors in each of the elements contributing to U_{de} have been estimated. These are typically less than 3 per cent maximum for each element in normal

level flight and in the extreme could lead to a total error of 10 to 12 per cent. Assuming a random distribution of errors, a typical uncertainty would be 3 or 4 per cent of the final value of U_{de} . Aircraft manoeuvres can also lead to large vertical accelerations of an aircraft, and, conversely, active control techniques can dampen the acceleration due to gusts, leading to serious underestimation of vertical gust velocities.

3.5.3 Eddy dissipation rate

This method (Cornman, Morse and Cuning, 1995) describes the vertical gust spectrum of the turbulent air around the aircraft by the single parameter $\varepsilon^{1/3}$, the eddy dissipation rate (EDR). The input gust energy spectrum, at the frequencies of interest, is approximated by:

$$\phi_i(\omega) = 0.7V^{2/3} \varepsilon^{2/3} \omega^{-5/3} \quad (3.18)$$

where V is the true air speed, and ω is the turbulent frequency relative to the aircraft. $\varepsilon^{1/3}$ is related to the total power in the gust spectrum (σ^2) divided by a length scale parameter ($L^{1/3}$) such that:

$$\varepsilon^{1/3} = [\sigma^2/L^{1/3}]^{1/2} (m^{2/3} s^{-1}) \quad (3.19)$$

Given the aircraft vertical acceleration response function to vertical gusts $H(\omega)$, the output vertical gust energy spectrum $\phi_0(\omega)$ is given by:

$$\phi_0(\omega) = |H(\omega)|^2 0.7V^{2/3} \varepsilon^{2/3} \omega^{-5/3} \quad (3.20)$$

and the output vertical acceleration power $\sigma_0^2(\omega)$ is given by:

$$\sigma_0^2(\omega) = \int_{\omega_1}^{\omega_2} \phi_0(\omega) d\omega \quad (3.21)$$

$$\sigma_0^2(\omega) = 0.7V^{2/3} \varepsilon^{2/3} \int |H(\omega)|^2 \omega^{5/3} d\omega \quad (3.22)$$

The limits of integration, ω_1 and ω_2 , are chosen to remove the low-frequency amplification of the gust spectral approximation, low frequencies due to aircraft manoeuvres, noise and high-frequency aircraft response not modelled by $H(\omega)$. Denoting the integral above $I(\omega_1, \omega_2, \omega)$ and rearranging, gives:

$$\varepsilon^{2/3}(\omega) = \sigma_0^2(\omega)/0.7V^{2/3} I(\omega_1, \omega_2, \omega) \quad (3.23)$$

The response integral can be determined for a particular aircraft and changes relatively slowly over time with changing aircraft weight and flight conditions. Since the EDR and output power will change with time as the aircraft encounters different

turbulent conditions, and noting that for a given time interval T , $\sigma_0^2(\omega) = \sigma_0^2(t)$, it is possible to write:

$$\varepsilon^{2/3}(T) = \sigma_0^2(T)/0.7V^{2/3}I(\omega_1, \omega_2, T) \quad (3.24)$$

where T is the measurement interval for each estimation of EDR.

In practical applications, the output vertical accelerations are band-pass filtered to match the response integral, and σ_0^2 is estimated from the standard deviation of running 10 s samples of the filtered values. The pass band is currently set at 0.1 to 0.8 Hz. The aircraft response integral is evaluated for a range of flight conditions and stored in look-up tables, thus simplifying and reducing the on-board computation requirement. For downlinking, the data can be reduced to a median and peak value over the reporting interval. The peak value usually chosen is the 90 percentile value in the reporting interval.

3.5.3.1 Measurement uncertainty

As for DEVG, in the EDR there are potentially a large number of error sources contributing to measurement uncertainty. Based on the error analysis for DEVG, an uncertainty of some 5 to 10 per cent in the calculation process can be expected. A further complication arises over the choices of sampling interval and averaging time. Examination of typical time series of vertical acceleration data often indicates high variability of statistical properties over short distances. Variation of air speed for a single aircraft and between different aircraft types alters the sampling distances and varies the wavelengths filtered.

3.5.3.2 Relationship between EDR and DEVG

Detailed field comparisons (Stickland, 1998) have been made between EDR and DEVG. These have shown a high correlation between peak EDR and DEVG for the same turbulence incidents. This result should be expected since EDR is directly proportional to the standard deviation of vertical acceleration over the measurement interval chosen. Hence, for a "normal" distribution, the extreme value will correlate closely with the peak vertical gust (proportional to the peak deviation of vertical acceleration). Clearly, this relationship will not apply to a singular event falling outside the assumed distribution and the EDR filter cut-off at 0.8 Hz might well unduly attenuate very sharp gust events.

3.6 RELATIVE HUMIDITY

Although various sensors have been used in research aircraft for the measurement of relative humidity (or a related variable) and several are currently being developed using a range of technologies (including capacitance-absorption, cooled-mirror and diode-laser technologies), no suitable sensor is widely available at this time. A diode-laser/solid-state detector instrument under development in the United States (May, 1998; Fleming, 2000; 2003), measuring WVNR directly, promises to measure to a few parts per million by volume. The method is based on the absorption of narrow-band electromagnetic radiation by water vapour. The intensity of radiation at the detector is related to the emitted radiation by Beer's law such that:

$$I = I_0^{-kxp/p_0} \quad (3.25)$$

where I is the received signal; I_0 is the transmitted signal; k is the absorption coefficient; x is the path length; p is the concentration of water in the sensing volume, and p_0 is the concentration of water vapour at standard temperature and pressure. Since I_0 , k , x and p_0 are known properties of the system, the concentration of water in the sampling volume is measured and readily converted to WVMR.

By folding the path length, it has been possible to fit the complete sensor in a standard aircraft temperature probe. As WVMR is conserved with adiabatic compression in the sensor probe, the measured value is suitable for reporting without knowledge of SAT. This is also convenient in numerical atmospheric models using specific humidity (numerically almost indistinguishable from WVMR) as the input variable. Numerical analysis fields often require relative humidity as the moisture field variable. This is readily computed from WVMR if SAT and ambient pressure are known.

3.6.1 Measurement uncertainty

The accuracy claimed for the system is some 2 to 4 ppm by volume. However, for many meteorological applications, other psychrometric variables such as dewpoint or relative humidity are required. The accuracy of these derived variables depends not only on the uncertainty of the basic measurement of WVMR, but also on uncertainty in SAT and, to a lesser extent, uncertainty in ambient pressure. For example, an uncertainty of relative humidity of around 4 and 6 per cent might be expected at a true 50 per cent and 90 per cent relative humidity, respectively, if temperature uncertainty is 1°C.

3.7 ICING

Several types of sensors may detect ice build-up on the flying surfaces. The following two types are in use:

- (a) A thin-film capacitive sensor attached to the airfoil;
- (b) A mechanical (vibrating-transducer) sensor exposed to the air-stream in a probe adjacent to the relevant flying surface.

3.7.1 Measurement uncertainty

The output of both sensors is essentially an “ice/no ice” signal, and error would be described by false-alarm rate. At present, no data are available on false-alarm rates for these sensors.

3.8 PRACTICAL OPERATIONAL SYSTEMS

There are a number of operational AMDAR systems in current use, including ASDAR, and an increasing number of very high frequency systems based on the aircraft communication addressing and reporting system (ACARS). They all report data in profile (ascent/descent) mode as well as cruise mode.

3.8.1 Aircraft to satellite data relay

The aircraft to satellite data relay was conceived as an observing system for the First Global Atmospheric Research Program Global Experiment and after successful prototype development has been deployed by a consortium of WMO Members in an operational system. ASDAR (WMO, 1992) employs a dedicated data processor which extracts raw data from the aircraft systems, calculates the required meteorological variables, and formats and transmits a meteorological coded message through the International Data Collection System of the meteorological geosynchronous satellites. Although this programme was formally terminated in December 2003, data are still being produced by a small number of aircraft.

3.8.2 Meteorological data collection and reporting system

This system is a typical ACARS-based AMDAR. The meteorological data collection and reporting system in use in North America (Taylor, Landot and Ligler, 1990) was developed by Aeronautical Radio Inc. under contract with the Federal Aviation Administration of the United States. The system accepts meteorological reports from commercial

aircraft down-linked through ACARS in a variety of company-specific formats and processes the reports into a common format for onward transmission to the National Centers for Environmental Prediction in Washington DC.

3.9 FUTURE AMDAR SYSTEMS

A number of AMDAR-like systems are being developed which will improve global coverage and increase the number of observations in the boundary layer and lower troposphere. Emphasis is being placed on recruiting smaller regional and general aviation aircraft to install either conventional AMDAR systems or dedicated sensor and communication systems. These aircraft operate from numerous smaller airports that are not normally covered by existing conventional AMDAR reporting aircraft.

3.9.1 ICAO automatic dependent surveillance

The development of global air navigation systems is closely linked to developments in communication systems. Thus, the Future Air Navigation System is coupled with the development of an automatic dependent surveillance system which itself is dependent on global satellite aircraft communication. The global aircraft communication system is migrating to an open network under the Aeronautical Telecommunication Network project (Wells and others, 1990). This will link the VHF and Satcom Systems into a common open network.

The successful weather routing of commercial aircraft, especially to provide flight safety, minimize fuel consumption and airframe fatigue, and to ensure passenger comfort, demands greater accuracy in aviation forecasts. Hence, automatic reports of aircraft position for automatic dependent surveillance allow for the inclusion of automated meteorological reports. The data to be included in these reports are essentially the same as those of current AMDAR systems including allowance for turbulence and humidity elements.

3.9.2 Other AMDAR systems

A new system being developed in the United States called tropospheric airborne meteorological data reporting (AirDat, 2003) is based on a dedicated sensor and communications system for installation

on regional and smaller general aviation aircraft that cruise between 10 000 and 25 000 ft. These aircraft operate on shorter routes with more ascents and descents than conventional larger jet transports.

Other systems are being developed in Canada to provide AMDAR coverage by a range of different and generally smaller aircraft that operate into Arctic regions.

REFERENCES AND FURTHER READING

- Abbott, I.H. and A.E. von Doenhoff, 1959: *Theory of Wing Sections*. Dover Publications, Inc., Mineola, New York, 693 pp.
- AirDat, 2003: *TAMDAR – Tropospheric Airborne Meteorological Data Reporting Sensor and System Overview; AirDat Infrastructure and Global Capabilities*. Information document, AirDat LLC, Evergreen, Colorado.
- Cornman, L.B., C.S. Morse and G. Cunning, 1995: Real-time estimation of atmospheric turbulence severity from in situ aircraft measurements. *Journal of Aircraft*, Volume 32, Number 1, pp. 171–177.
- Dommasch, D.O., S.S. Sherby and T.F. Connolly, 1958: *Airplane Aerodynamics*. New York, Pitman, 560 pp.
- Fleming, R.J., 2000: Water vapor measurements from commercial aircraft: Progress and plans. *Preprints*. Fourth Symposium on Integrated Observing Systems, Long Beach, CA, American Meteorological Society, pp. 30–33.
- Fleming, R.J., 2003: The WVSS-II and the UCAR air sampler: Purpose, design, status (personal communication). University Corporation for Atmospheric Research, Boulder, Colorado.
- Holland, G. J., T. McGeer, and H. Youngren, 1992: Autonomous aerosondes for economical atmospheric soundings anywhere on the globe. *Bulletin of the American Meteorological Society*, 73, pp. 1987–1998.
- International Civil Aviation Organization, 1964: *Manual of the ICAO Standard Atmosphere*. Second edition, Doc. 7488, Montreal.
- Lawson, R.P. and W.A. Cooper, 1990: Performance of some airborne thermometers in clouds. *Journal of Atmospheric and Oceanic Technology*, 7, pp. 480–494.
- May, R.D., 1998: Open-path, near-infrared tuneable diode laser spectrometer for atmospheric measurements of H₂O. *Journal of Geophysical Research*, 103, pp. 19161–19172.
- Meteorological Service of Canada, 2003: *The Effect of Pitch and Roll Attitude on the Calculation of Wind*. A report by G. Bruce, Aeromechanical Services Ltd., 1118-1c, Rev. 1.0.
- Nash, J., 1994: Upper wind observing systems used for meteorological operations. *Annales Geophysicae*, Volume 12, pp. 691–710.
- Rodi, A.R. and P.A. Spyers-Duran, 1972: Analysis of time response of airborne temperature sensors. *Journal of Applied Meteorology*, Volume 11, pp. 554–556.
- Sherman, D.J., 1985: *The Australian Implementation of AMDAR/ACARS and the Use of Derived Equivalent Gust Velocity as a Turbulence Indicator*. Structures Report No. 418, Department of Defence, Defence Science and Technology Organisation, Aeronautical Research Laboratories, Melbourne, Victoria.
- Stickland, J.J., 1998: *An Assessment of Two Algorithms for Automatic Measurement and Reporting of Turbulence from Commercial Public Transport Aircraft*. A report to the ICAO METLINK Study Group. Observations and Engineering Branch, Bureau of Meteorology, Melbourne.
- Taylor, D.L., D. Landot and G.T. Ligler, 1990: Automated meteorological reports. *Proceedings of the Aeronautical Telecommunications Symposium on Data Link Integration*, Annapolis, Maryland, May 1990, pp. 141–144.
- Wells, V. E. and others, 1990: Migration of ACARS to the Aeronautical Telecommunication Network. *Proceedings of the Aeronautical Telecommunications Symposium on Data Link Integration*, Annapolis, Maryland, May 1990, pp. 209–216.
- World Meteorological Organization, 1992: Development of the aircraft to satellite data relay (ASDAR) system (D.J. Painting). *Papers Presented at the WMO Technical Conference on Instruments and Methods of Observation (TECO-92)*, Instruments and Observing Methods Report No. 49, WMO/TD-No. 462, Geneva.
- World Meteorological Organization, 1995: *Manual on Codes*. Volume I.1, WMO-No. 306, Geneva.
- World Meteorological Organization, 2003: *Aircraft Meteorological Data Relay (AMDAR) Reference Manual*, WMO-No. 958, Geneva.

CHAPTER 4

MARINE OBSERVATIONS

4.1 GENERAL

Marine observations in the broadest definition cover any meteorological and related environmental observations at the air-sea interface, below the sea surface and in the atmosphere above the sea surface (upper-air measurements). Detailed formal requirements for observations from sea stations are given in WMO (2003). Advice on requirements and procedures is given in WMO (2001).

This chapter considers observations at the air-sea interface, which include the usual surface measurements made also over land and discussed in that context in other chapters. This chapter also considers some subsurface measurements of importance to marine physics and physical oceanography. Upper-air measurements are taken using techniques that are essentially the same over the sea and over land; these will not be considered in this chapter.

Measurements and observations of waves are not described elsewhere in this Guide. Visual methods are discussed in section 4.2.12. Automated methods are referred to in section 4.3, although the techniques are applied on other types of platforms.

Observations can be made using fixed or moving platforms, and be in situ or remote, using surface- or space-based techniques. In situ measurements are essentially single-point observations intended to be representative of the surrounding sea area, as for synoptic meteorology. Remote-sensing techniques lead to large area or volume representation, which is particularly appropriate for observations of sea ice.

In situ measurements

These measurements or observations are made from a variety of platforms. They include ships of the voluntary observing fleet (also referred to as the Voluntary Observing Ship (VOS) Programme), ocean weather stations, manned and unmanned light vessels, moored buoys, drifting buoys, towers, oil and gas platforms and island automatic weather stations. The type of platform generally determines the range of elements measured and reported. Thus, ships of the voluntary observing fleet, using mainly manual observation techniques, make the full range of observations required for synoptic meteorology

(and distributed in the FM 13 SHIP or BUFR code), whereas the simplest drifting buoy might report position and sea-surface temperature only.

Remotely sensed measurements

Marine measurements can be made remotely from surface- and space-based systems. At present, surface-based remote-sensing systems are available to measure or observe precipitation (weather radar), near surface winds (Doppler radar), surface ocean currents, surface wind, and sea state (microwave radar for short-range and high-frequency radar for long-range, for example, “over the horizon”, sensing). These techniques are described in Part II, Chapter 9. In addition, the techniques for remote detection and location of lightning, described in Part II, Chapter 7, are applicable to the marine environment.

Remote sensing from space is used for the measurement of many surface marine variables. It is probable that, as technology advances, remote sensing from space-borne platforms will provide the bulk of sea state, wind and sea-surface temperature data over the world’s oceans. It should be noted, however, that in situ measurements are essential to supplement and calibrate these data. Remote-sensing systems from space are described in Part II, Chapter 8.

4.2 OBSERVATIONS FROM SHIPS

This section contains detailed guidance and advice for taking measurements and making observations on ships. Reference WMO (1991a) is another source. Details on surface observations to be carried out within the framework of the WMO VOS scheme are provided in WMO (2001), Chapter 6. Studies of the quality of observations from ships are given in WMO (1991b; 1999), Taylor and others (1999) and Wilkerson and Earle (1990).

4.2.1 Elements observed

Ships which undertake meteorological observations should be equipped for observing or measuring the following elements:

- (a) Ship position;
- (b) Wind speed and direction;

- (c) Atmospheric pressure, and pressure tendency and its characteristics;
- (d) Present and past weather, and weather phenomena;
- (e) Clouds (amount, type and base height);
- (f) Visibility;
- (g) Air temperature;
- (h) Humidity (dewpoint);
- (i) Precipitation;
- (j) Sea-surface temperature;
- (k) Ocean sea waves and swell — height, period and direction;
- (l) Sea-ice and/or ice accretion on board ship, when appropriate;
- (m) Ship course and speed.

As regards the order of observing these elements, in general, instrumental observations requiring the use of a light should be made after non-instrumental ones, so that to the observer's eyes can adapt to the darkness without being impaired.

The observation of elements other than pressure should be made within 10 min preceding the standard time for the synoptic observation, whereas atmospheric pressure should be read at the exact time or as close as possible to the standard time.

4.2.2 **Equipment required**

The following instruments are suitable for use on ships:

- (a) A precision aneroid barometer or marine mercury barometer;
- (b) A hygrometer or psychrometer;
- (c) A barograph, preferably open scale (desirable but not mandated);
- (d) A sea-temperature thermometer and suitable receptacle for obtaining a sample of seawater, or a continuously immersed sensor (or a hull contact sensor) with remote indicator;
- (e) A raingauge adapted for use aboard a ship (optional: for reporting past and present weather and for climatological purposes).

The use of anemometers with representative exposure as an alternative to the visual estimation of wind force is encouraged. The instruments used on ships should conform to the requirements laid down or recommended in other chapters of this Guide, apart from the modifications described in the following sections of this chapter. Instruments supplied to ships should be tested or inspected by the Meteorological Services concerned.

4.2.3 **Times of observation**

Surface observations on board ships are made as follows:

- (a) Synoptic observations should be made at main standard times: 0000, 0600, 1200 and 1800 UTC. When additional observations are required, they should be made at one or more of the intermediate standard times: 0300, 0900, 1500, and 2100 UTC;
- (b) When operational difficulties on board ships make it impracticable to make the synoptic observation at a main standard time, the actual time of observation should be as near as possible to the main standard times. In special cases, the observations may even be taken one full hour earlier than the main standard time. In such cases, the actual time of observation should be indicated;
- (c) Observations should be made more frequently than at the main standard times whenever storm conditions threaten or prevail;
- (d) When sudden and dangerous weather developments are encountered, observations should be made for immediate transmission without regard to the standard times of observation (i.e. within 300 nautical miles of a named tropical system);
- (e) Marine observations are just as valuable in coastal zones as in the open ocean and observations should be continued during the whole journey.

4.2.4 **Automation of observations on ships and data transmission**

Automated or partially automated systems on board ships have been developed, both for observation and data transmission purposes. Three basic modes of operation are used, as follows:

- (a) The observation is made manually, entered into a processing device (typically a personal computer), coded, as necessary, and formatted for automatic or manually initiated transmission;
- (b) The observation is made automatically using standard automatic weather station techniques, as described in Part II, Chapter 1. The position, course and speed of a ship are taken from its navigation system or computed independently using a satellite navigator (for example, global positioning system). The transmission of such observations can be either purely automatic or initiated manually according to the communications facilities;
- (c) The observations are a combination of automated and manual observations, namely, automated observations augmented with

BEAUFORT NUMBER (FORCE)	DESCRIPTIVE TERM	WIND SPEED EQUIVALENTS		SPECIFICATIONS FOR OBSERVATIONS
		$m s^{-1}$	knots	On board ship (open sea)
0	Calm	0–0.2	<1	Sea like a mirror
1	Light air	0.3–1.5	1–3	Ripples with the appearance of scales are formed, but without foam crests
2	Light breeze	1.6–3.3	4–6	Small wavelets; still short but more pronounced; crests have a glassy appearance and do not break
3	Gentle breeze	3.4–5.4	7–10	Large wavelets; crests begin to break; foam of glassy appearance; perhaps scattered white horses
4	Moderate breeze	5.5–7.9	11–16	Small waves, becoming longer; fairly frequent white horses
5	Fresh breeze	8.0–10.7	17–21	Moderate waves, taking a more pronounced long form; many white horses are formed (chance of some spray)
6	Strong breeze	10.8–13.8	22–27	Large waves begin to form; the white foam crests are more extensive everywhere (probably some spray)
7	Near gale	13.9–17.1	28–33	Sea heaps up and white foam from breaking waves begins to be blown in streaks along the direction of the wind
8	Gale	17.2–20.7	34–40	Moderately high waves of greater length; edges of crests begin to break into the spindrift; the foam is blown in well-marked streaks along the direction of the wind
9	Strong gale	20.8–24.4	41–47	High waves; dense streaks of foam along the direction of the wind; crests of waves begin to topple, tumble and roll over; spray may affect visibility
10	Storm	24.5–28.4	48–55	Very high waves with long overhanging crests; the resulting foam, in great patches, is blown in dense white streaks along the direction of the wind; on the whole, the surface of the sea takes a white appearance; the “tumbling” of the sea becomes heavy and shock-like; visibility affected
11	Violent storm	28.5–32.6	56–63	Exceptionally high waves (small and medium-sized ships might be for a time lost to view behind the waves); the sea is completely covered with long white patches of foam lying along the direction of the wind; everywhere the edges of the wave crests are blown into froth; visibility affected
12	Hurricane	32.7 and over	64 and over	The air is filled with foam and spray; sea completely white with driving spray; visibility very seriously affected

visual observations entered by the observer before transmission (i.e. adding visibility, wave heights).

Satellite communication systems are now in widespread use for disseminating ship observations. Details are given in WMO (2001), section 6.6. The following three methods are available:

- (a) The International Data Collection System through the meteorological geosynchronous (GOES, METEOSAT, MTSAT) satellites. This system, funded mainly by meteorological agencies, allows for purely automatic data communication at predetermined time slots,

once an hour. Data transmission is one-way only and error rates can be significant;

- (b) Commercial satellite systems, for example, through INMARSAT to a coast earth station using Code 41. These systems are very reliable and offer two-way communication, but often require manual initiation;
- (c) Service Argos: This system is primarily designed for location as well as data transmission and is limited by the number and the orbital characteristics of the National Oceanic and Atmospheric Administration polar-orbiting satellites. Argos can be used for the communication and processing of ship observations (WMO, 1995a).

4.2.5 **Wind**

Observations of wind speed and direction may be made either by visual estimates or by means of anemometers or anemographs.

On ships fitted with instruments, the observations should consist of the mean reading over a 10 min period. When observations are taken from a moving ship, it is necessary to distinguish between the relative and the true wind; for all meteorological purposes the true wind must be reported. A simple vector diagram or a table may be used for computing the true wind from observations of the relative wind and ship speed and course (Bowditch, 2002). In practice, this vector conversion is a frequent source of error in reported winds. Special slide rules and hand computers are also available, and programs can be installed on small computers. Wind speed needs to be corrected for effective height or a standard reference level (10 m, see WMO, 2003). Details on the reduction calculus are given in WMO (1989).

4.2.5.1 **Visual observations**

Visual estimates are based on the appearance of the sea surface. The wind speed is obtained by reference to the Beaufort scale (see table). The wind direction is determined by observing the orientation of the crests of sea waves (that is, wind-driven waves, and not swell) or the direction of streaks of foam which are blown in the direction of the wind. The specifications of the Beaufort scale numbers refer to the conditions in the open sea. In practice, wind directions made by visual methods are of good quality.

The wave height in itself is not always a reliable criterion since it depends not only on wind speed, but also on the fetch and duration of the wind, the depth of shallow waters, and the presence of swell running through a sea. The Beaufort scale, therefore, makes use of the relation between the state of the sea and the wind speed. This relation is, however, affected by several other factors which should, in principle, be taken into account in estimating wind speeds. These factors are the lag between the wind increasing and the sea rising, the smoothing or damping down of wind effects on the sea surface by heavy rain, and the effects of strong surface currents (such as tidal currents) on the appearance of the sea. Sea criteria become less reliable in shallow water or when close inshore, owing to the effect of tidal currents and the shelter provided by the land. At these locations, or when

the surface of the sea cannot be clearly seen, the Beaufort force of the relative wind on the ship may be estimated by noting wind effects on sound, on ship-borne objects such as flags, and on funnel smoke. In the latter case, the direction of the relative wind may also be estimated, for example, by observation of the funnel smoke. From these estimates, the speed and direction of the true wind can be computed (United Kingdom Meteorological Office, 1995). If no other means are available to estimate the wind direction, low-level cloud movement can be a helpful tool.

4.2.5.2 **Measurements with instruments**

If instruments for measuring wind are installed on ships, the equipment should give both wind speed and direction and should be capable of minimizing roll effects (suitably designed cup anemometers and damped wind vanes are capable of rendering the effects of pitch and roll insignificant).

In most cases, it is difficult to obtain a good exposure for ship-borne wind instruments (Taylor and others, 1999; Yelland, Moat and Taylor, 2001). The local effects produced by the superstructure, mast and spars should be minimized as much as possible by siting the instrument as far forward and as high as practicable. If fitted on a yard, it may be preferable that the speed and direction heads should form separate units, as a more even distribution of the weight on the yard can be obtained, and it may then be possible to fit the instruments farther outboard. Whether fitted on a yard or on a bracket fixed to the foremast, each unit should be mounted in position at a distance of at least 10 mast diameters away from the mast. If this is impracticable, a good technique is to fit two instruments, one on each side of the foremast, and always to use the one which is more freely exposed. The top of the foremast, if available, is generally thought to be the best site for an anemometer.

Various types of portable anemometers are on occasion used at sea. Their main disadvantage is that they can hardly be given representative exposure, and, in practice, measurements taken with them show substantial scatter. Only an observer who understands the nature of the air-flow over the ship in different circumstances would be able to choose the best place for making such observations and thus arrive at satisfactory results. This method may be useful if visual estimates of wind force are difficult or impossible, for example, with light winds at night.

4.2.6 Atmospheric pressure, pressure tendency and characteristic of pressure tendency

4.2.6.1 Methods of observation

Pressure can be measured either by a precision aneroid or by a mercury barometer. In the case of the latter, the “pumping” effect, namely rapid and regular changes in the height of the mercury, should be allowed for when a reading is made. This is done by taking the mean of two or three sets of readings, each set consisting of the highest and lowest points reached during the oscillation of the mercury in the tube.

The characteristic and amount of the pressure tendency in the past 3 h are obtained from a marine barograph, preferably an open-scale instrument graduated in divisions of 1 hPa. Alternatively, the amounts of pressure tendency can be obtained from successive readings of the mercury barometer at the beginning and end of the 3 h interval.

4.2.6.2 Instruments

Mercury barometers

In practice, the proper installation and operation of mercury barometers at sea have proven very difficult, and mercury barometers are now rarely installed on board ships. The mercury barometers used on board ships are mostly of the fixed cistern pattern. In addition to possessing the requirements of a good station barometer, a marine barometer should be appropriately damped in order to reduce pumping of the mercury column. This can be arranged by constricting the bore of the tube for the lower and greater part of its length by means of capillary tubing.

The time-constant of a marine barometer can be conveniently estimated by tilting the instrument so that it is reading 50 hPa above the actual pressure, and then by returning the barometer to a vertical position and noting the time taken for this difference to fall to 18 hPa above the actual pressure; the time should be between 4 and 9 min.

Digital and aneroid barometers and barographs

All barometers should conform to the general requirements given in Part I, Chapter 3, and should be supplied with a certificate giving the corrections (if any) that must be applied to the readings of each individual instrument. Barometers should be capable of being read to 0.1 hPa. The operational

measurement uncertainty requirements and instrument performance are stated in Part I, Chapter 1, Annex 1.B. The required measurement uncertainty is less than 0.1 hPa (after reduction to sea level: < 0.2 hPa). The achievable measurement uncertainty should never be worse than 0.3 hPa. Marine barographs should have a built-in damping device, for example, an oil bath containing the aneroid box or a dash pot connected to the lever mechanism, to prevent the wide trace produced by rapid pressure variations caused by gusty winds and movement of the ship. Both the barometer and barograph should also be vented to the outside with a static pressure head so that readings can be taken more accurately and are not affected by sealed bridges or indoor wind impacts. This is especially important on newer vessels or hazardous load carriers whose pilothouses are hermetically sealed.

4.2.6.3 Exposure and management

Mercury barometers

It is usually very difficult to give a marine barometer an exposure which satisfies the requirements specified in Part I, Chapter 3. The barometer should be mounted on gimbals in a position as near as possible to the centre of flotation, where it can swing freely and is not liable to interference from passing crew or passengers, and where the temperature is as uniform as possible. If the barometer is put into a protective box between the hours of observation, care must be taken that the instrument is put into a free position at least half an hour before the observation is made.

Digital and aneroid barometers and barographs

Barometers and barographs should be mounted on shock-absorbing material in a position where they are least affected by concussion, vibration or movement of the ship. The best results are generally obtained from a position as close to the centre of flotation as possible. Barographs should be installed with the pen-arm oriented athwart ships (to minimize the risk of its swinging off the chart).

4.2.6.4 Corrections

Provision should be made for the application of the following corrections:

- (a) Mercury barometers:
 - (i) Index error;
 - (ii) Temperature of the instrument;
 - (iii) Latitude (gravity);
 - (iv) Reduction to sea level (not mean sea level).

These corrections may be combined in a single table with the temperature of the attached thermometer and the latitude as arguments, or a Gold correction slide may be used. This special slide ruler is attached to the barometer and incorporates the attached thermometer. It gives the total barometer correction and reduction to sea level in one operation;

- (b) Aneroid barometers:
 - (i) Scale error (bias);
 - (ii) Reduction to sea level (not mean sea level);
 - (iii) Temperature (if applicable and appropriate tables are provided).

Barometers should be adequately compensated for temperature, otherwise the instruments should be provided with a temperature correction table and means should be provided for measuring the temperature. A table for reducing to sea-level pressure should also be supplied (Bowditch, 2002, Tables 29-34).

4.2.6.5 Sources of error

Errors are discussed in Part I, Chapter 3, but on ships in particular appreciable errors may be caused by the effect of the wind on the pressure in the compartment in which the barometer is placed. These should be minimized by enclosing the instrument in a chamber connected to a static pressure head or by connecting the device directly to this static pressure head.

Pressure measured by mercury barometers on ships would be subject to large apparent oscillations, which should be suppressed in a marine barometer. In an undamped barometer, one source of these errors would be the regular oscillation of the barometer when hanging freely. The error amount would depend on the position of the point of suspension, the period of swing of the barometer and the amplitude of the oscillation from the true vertical (which may be much smaller than the oscillation about an axis fixed relative to the ship). A barometer mounted on gimbals and oscillating regularly for a considerable time (15 min or more) with a swing of about 10° could read as much as 4 hPa too high. If, however, the amplitude of the swing were 2°, the error would be only about 0.2 hPa.

On account of the time-constant of the barometer, the fluctuations due to the pressure variations caused by the lifting and sinking of a barometer (rolling or pitching) are of less importance. The pumping of the mercury meniscus in an undamped barometer would be largely due to the varying

acceleration to which the barometer is subjected by the movements of the ship. Thus, the error of a single corrected undamped barometer reading on board a ship could vary from ± 0.2 hPa to a few hectopascals, according to the circumstances.

4.2.6.6 Checking with standard instruments

The mercury barometer should be frequently checked against standard instruments on shore (at least once every three months), and a permanent record of all such checks should be kept on a suitable card or in a special log.

Aneroid barometers and barographs should be checked frequently against a (portable) standard reference barometer on shore preferable every three months. In common practice, however, an interval of six months is found to be appropriate as well. A permanent record of all such checks should be attached to the instrument, and should include such information as the date of the check and the temperature and pressure at which the check was made. It is particularly important that barometers and barographs be checked more frequently when the instruments are new.

4.2.7 Clouds and weather

Visual cloud and weather observations should follow the same rules as those applicable to a land station (see Part I, Chapters 14 and 15) (see also the annex for descriptions of forms of precipitation). Detailed instructions and tips on how to make these observations should be provided through the affiliated Port Meteorological Office or by any Port Meteorological (Liaison) Officer, bearing in mind that most observers at sea are voluntary observers.

In the absence of instrumental aids, the cloud-base height must be estimated. In order to improve their ability to do this, observers should be encouraged to take every opportunity to check their estimates against known heights, for example, when a cloud base is seen to intercept a mountainous coast, although in such circumstances the cloud base may be lower at the mountain than out at sea.

The cloud-base searchlight is of limited value on a ship because of the short baseline. An instrument which does not require a baseline is to be preferred, such as a laser ceilometer (see Part I, Chapter 15). It should be installed so that it can be operated and read by the officer on watch on the navigation bridge.

4.2.8 **Visibility**

At sea, the absence of suitable objects makes it impossible to estimate visibility as accurately as at land stations. In recognition of this, a coarse code scale is normally used in reports from sea stations.

On a large ship, it is possible to make use of objects aboard the ship for estimation when the visibility is very low, but it should be recognized that these estimates are likely to be in error since the air may be affected by the ship. For the higher ranges, the appearance of the land when coasting is a useful guide, and, if fixes can be obtained, the distance of landmarks, just as they are appearing or disappearing, may be measured from the chart. Similarly, in open sea, when other ships are sighted and their distances known, for example, by radar, the visibility may be estimated. In the absence of other objects, the appearance of the horizon, as observed from different levels, may be used as a basis for the estimation. Although abnormal refraction may introduce errors into such methods of estimation, these methods are the only ones available in some circumstances. At night, the appearance of navigation lights can give a useful indication of the visibility.

When the visibility is not uniform in all directions it should be estimated or measured in the direction of least visibility and a suitable entry should be made in the log (excluding reduction of visibility due to the ship's exhaust).

Information about visibility meters is given in Part I, Chapter 9. Only those types of visibility meters which can be used with a baseline or light-path short enough to be practicable on a ship are suitable. Unfortunately, the heating effect of the ship, and its exhaust, may lead to unrepresentative measurements.

4.2.9 **Air temperature and humidity**

Temperature and humidity observations should be made by means of a hygrometer or psychrometer which has good ventilation. The instruments must be well exposed in a stream of air, directly from the sea, which has not been in contact with, or passed over, the ship, and should be adequately shielded from radiation, precipitation and spray.

Sling or aspirated psychrometers exposed on the windward side of the bridge have been found to be satisfactory. If manually operated psychrometers are used, the thermometers must be read as soon as possible after ventilation has stopped. Hand-held

hygrometers require several minutes to be acclimated to the open environment if they have been stored indoors before use.

If a louvered screen is to be used, two should be provided, one secured on each side of the vessel, so that the observation can also be made from the windward side. In this way, thermometers in the hygrometer can be completely exposed to the air-stream and are uninfluenced by artificial sources of heat and water vapour. As an alternative, a portable louvered screen can be used, which is hung on whichever side is windward to gain the same exposure. The muslin wick fitted to a wet-bulb thermometer in a louvered screen should be changed at least once each week, and more often in stormy weather.

For the general management of psychrometers, the recommendations of Part I, Chapter 4 should be followed. Distilled water should be used for the wet-bulb thermometer. If this is not readily available, water from the condenser will generally be more suitable than ordinary freshwater. Water polluted by (traces of) seawater should never be used because any traces of salt will affect the wet-bulb temperature significantly.

Psychrometers give better results in practice than louvered screens, which evidently are more prone to poor exposure.

4.2.10 **Precipitation**

The measurement of precipitation at sea is discussed in WMO (1962; 1981). As an aid to observers on ships, descriptions of precipitation at sea, for use in reporting present weather, are given in the annex.

4.2.10.1 **Measurements and instruments**

The complete measurement comprises the determination of both the amount and the duration of precipitation. The amount of precipitation should be measured with a raingauge adapted for use aboard a ship. Readings should be made preferably every 6 h. Amounts of precipitation up to 10 mm should be read to 0.2 mm. Larger amounts should be read to 2 per cent of the total. The required accuracy of the measurement is the same as is given for the resolution of the reading. The duration of precipitation should be recorded in rounded units of 5 min.

It is difficult to obtain reliable measurements of precipitation on board a ship, owing to the aerodynamic effect of the superstructure of the ship, the

influence of roll and pitch, the capture of spray, and the changes in ship position. The equipment used on ships for the measurement of precipitation should be constructed and exposed in such a manner that the first three effects mentioned above are avoided or minimized as far as possible.

Precipitation measurements from fixed stations (lightships, ocean station vessels, large buoys, towers, etc.) are particularly valuable because the effect of ship movement is eliminated and the data can, thus, be included in climatological analyses without reduction. However, the problems of platform motion and salt contamination must still be considered.

Gimbal-mounted raingauge

The most common instrument used on board ships for the measurement of precipitation is the gimbal-mounted raingauge, an arrangement that is not very effective, especially during bad weather, as it is not able to keep the gauge horizontal at all times. An efficient gimbal arrangement is very complicated and expensive and is used only aboard special ships. Generally, when a raingauge is used, a fixed installation with a remote measurement arrangement seems to be a better option.

Conical marine raingauge

The conical marine raingauge is normally fixed high up on a mast. A plastic tube leads the water to a remotely placed collector on the deck, or in the wheelhouse. This can be a useful device for measuring precipitation, provided that the installation precautions are taken into account. The raingauge orifice should be fixed in a plane parallel to the ship's deck.

Recording raingauge

Two types of recording raingauges have been developed for use at sea. In one type, the collector is installed in the open while the recorder is mounted indoors. The rainwater is channelled along a pipe from the collector to a reservoir near the recorder. A pen linked to a float in the reservoir records the change of water level therein on a chart on a rotating drum. The reservoir is emptied automatically by a siphon when the total collected corresponds to 20 mm of rainfall.

In the electrical contact type of raingauge, the connection between the gauge and the recorder is made by electrical means. The rainwater caught by the collector is stored temporarily in a reservoir.

After an amount corresponding to 0.5 mm of rainfall has been received, the rising surface touches a needle to close an electric circuit. A motor then closes the inlet valve and simultaneously opens a drain valve. After the water has drained away, the valves revert to their original state and a single pulse is sent to the recorder. Errors occur when the motion of the ship or buoy causes the water level to fluctuate rather than to rise steadily. This limitation can be overcome by using a peristaltic pump. This device drains a fixed quantity of water (rather than all the water available) each time the contact is made and, therefore, is less sensitive to fluctuations in water level; there are also no valves to maintain.

The observation of precipitation by radar requires the use of narrow radar beams and calibrating raingauges together with the addition of specialized equipment to monitor the state of the radar and to apply corrections. Radars provided on board ships for other purposes do not have these features and their use for the quantitative observation of precipitation is not normal practice.

Exposure

The exposure of the raingauge should aim at minimizing the first three effects mentioned above. For a shipboard raingauge, placing the instrument as far forward and as high as practicable seems to be effective. However, other exposures may be found in particular cases to provide for easier management.

4.2.10.2 **Precipitation intensity at sea**

A recording raingauge can, of course, be used for measuring precipitation intensity. Attempts have been made to facilitate visual estimation of rainfall intensity by establishing a relationship with visibility. A relationship was found in slight to moderate rates of precipitation falling from more or less continuous cloud. In other conditions, such as showery weather, however, no reliable relationship has been found. Even for the former conditions, observers should be aware that estimates of visibility at sea are difficult to make with sufficient precision for the rate to be estimated satisfactorily.

4.2.11 **Sea-surface temperature**

The temperature to be observed is that of the sea surface representative of conditions in the near-surface mixing layer underlying the ocean skin.

The sea-surface temperature should be very carefully measured. This is because, among other things, it is used to obtain the difference with air temperature,

which provides a measure of the stratification of temperature and humidity and of other characteristics of the lower layers of maritime air masses. For these reasons, the temperature of the seawater thermometer should be read to 0.1°C.

It has not been possible to adopt a standard device for observing sea-surface temperatures on account of the great diversity in ship size and speed and because of cost, ease of operation and maintenance consideration.

Sea-surface temperature may be observed by:

- (a) Taking a sample of the sea-surface water with a specially designed sea bucket;
- (b) Reading the temperature of the condenser intake water;
- (c) Exposing an electrical thermometer to sea-water temperature either directly or through the hull;
- (d) Using an infrared radiometer mounted on the ship to look down on the sea surface.

The principal methods used for many years have been (a) and (b). Studies of the difference in temperature provided by the two methods have been made (WMO, 1972) in which it is reported that intake temperatures average 0.3°C greater than those measured by sea-bucket samples. In recent years, as the speed and height of ships have increased, method (c), which gives the most consistent results, has been more widely used. The use of radiometers is not routinely encountered. Of all these methods, the condenser intake technique is the least desirable because of the great care needed to obtain good results.

4.2.11.1 Sea buckets

A sea bucket is lowered over the side of the ship, a sample of seawater is hauled on board and a thermometer is then used to obtain its temperature. The sample should be taken from the leeward side of the ship, and well forward of all outlets. The thermometer should be read as soon as possible after it has attained the temperature of the water sample. When not in use, the bucket should be hung in the shade to drain.

A sea bucket should be designed to ensure that seawater can circulate through it during collection and that the heat exchange due to radiation and evaporation is minimum. The associated thermometer should have a quick response and be easy to read and should preferably be fixed permanently in the bucket. If the thermometer must be withdrawn for reading, it should have a small heat capacity and should be provided with a cistern around the

bulb such that the temperature of the water withdrawn with it does not vary appreciably during the reading. The design of the bucket should be deemed adequate for its purpose by the organization recruiting the ship for observations.

Measurements from sea buckets of good design (not simple buckets of canvas or other construction) can be expected to agree well over an extensive range of conditions. However, sea buckets are less convenient to use than instruments attached to the ship and their use is sometimes restricted by weather conditions.

4.2.11.2 Intake and tank thermometers

The thermometer provided within the intake pipe when the ship is built is normally not suitable for the measurement of sea-surface temperature. Thus, the organization recruiting the ship should, with the permission of the shipping company concerned, install an appropriate thermometer. This should preferably be mounted in a special tube providing adequate heat conductivity between the thermometer bulb and the water intake.

When a direct-reading thermometer is installed in cramped conditions, the observer should be warned of the possibility of readings errors due to parallax. A distant reading system with the display elsewhere (for example, in the engine room or on the bridge) overcomes this problem. The observer should also be aware that, for ships of deep draught, or when a marked temperature gradient exists within the sea-surface layer, intake temperature readings usually differ considerably from those close to the sea surface. Lastly, of course, the intake temperature should not be taken when the ship is stationary, otherwise the cooling water is not circulating.

The sea chest in the bottom of a ship is a cavity in which the intake pipes may terminate and which may be used to observe the intake temperature. It is a favoured position for the sensor of a distant-reading thermometer. Alternatively, a small tank within the hull connected to the seawater outside by several holes may be used. The limitations already mentioned apply to such installations.

4.2.11.3 Hull-attached thermometers

Hull-attached thermometers provide a very convenient and accurate means of measuring sea-surface temperature. They are necessarily distant-reading devices, the sensor being mounted either externally in direct contact with the sea using a "through-the-hull" connection, or internally (the

“limpet” type) attached to the inside of the hull. Both types show very good mutual agreement, with the “through-the-hull” type showing a slightly quicker response.

The sensors must be located forward of all discharges at a depth of 1 to 2 m below the water line. When large changes of draught can occur, more than one sensor may be needed. There can be considerable problems of fitting and wiring, which is best done when the ship is being built. For subsequent fitting, the limpet-type thermometer avoids the need for drydocking the ship.

4.2.11.4 Trailing thermometers

Several means have been devised for trailing the sensor of a distant-reading thermometer in the sea at a point from which a sea bucket would take its sample. The differences concern the way in which the connecting cable is brought on board and the arrangement for exposing the sensor to the sea.

The cable must be able to withstand the drag of the sensor, while providing a good electrical connection despite the stretch that can occur. An early design used a thickly braided nylon rope inside which was inserted a twin telephone cable of high tensile strength. A more recent design utilizes a PVC garden watering hose with a twin-wire conductor passing loosely within.

To expose the sensor, a small bucket has been used with loosely packed rubberized hog’s hair to prevent damage by shock or vibration. The bucket has two small holes to let the water escape slowly and does not need to be submerged all the time. It takes about 8 s to empty so that periodic wave motions of 2 or 3 s have no adverse effect on the temperatures obtained.

In an alternative design, the sea bucket is dispensed with by arranging for the hose to provide the exposure and protection required by the sensor. Along the last 2 to 3 m of the hose, which has an internal diameter of 12 mm, holes of 8 mm in diameter are punched. The end of the hose is closed, apart from a small drainage hole. A length of rope attached to the end of the hose stabilizes the instrument and allows it to slide smoothly along the sea surface with water entering to flow past the sensor.

These devices provide readings that are in good agreement with those of an accurate sea bucket and can be used readily. However, since experience is limited, no information is available on their possible

fouling by weeds, and so on. Thus, streaming and recovery may be necessary on each occasion as for a sea bucket.

4.2.11.5 Radiometers

Because of its temperature, any substance gives off heat energy as infrared radiation. The amount of energy and the wavelength of the radiation depend upon the temperature of the substance and its emissivity. Thus, radiometers which respond to infrared radiation can be used to measure the temperature of a substance. When directed at the sea surface, a radiometer measures the temperature of only the uppermost 1 mm or so, because the emissivity of water is near unity. This uppermost layer is often called the ocean skin. Large temperature gradients, with the coolest temperature at the top, may exist in the first few centimetres of the ocean, especially in relatively calm conditions.

Radiometers can be hand held (pointing forward and downward), mounted on the bow or on a boom extending over the water, or carried on an aircraft or satellite. Radiometer measurements do not usually represent sea-surface temperatures as defined above, but rather the evaporative surface skin temperature. They are used on only a few ships.

4.2.12 Ocean waves and swell

The main topics of this section are the definitions and behaviour of waves and the visual methods of observing them. Automated methods are briefly mentioned in section 4.3 on moored buoys, although they are applied on other types of platforms.

4.2.12.1 Definitions and descriptions of waves

Fetch: Distance along a large water surface trajectory over which a wind of almost uniform direction and speed blows.

Wind wave or wind sea: Waves raised by the wind blowing in the immediate neighbourhood of an observation site at the time of observation.

Swell: Any system of water waves which has left its generating area (or observed when the wind field that generated the waves no longer exists).

Wave length: Horizontal distance between successive crests or troughs. It is equal to the wave period multiplied by the wave speed.

Wave height: Vertical distance between the trough and crest of a wave.

Wave period: Time between the passage of two successive wave crests past a fixed point. It is equal to the wave length divided by the wave speed.

Wave speed: The distance travelled by a wave in a unit of time. It is equal to the wave length divided by the wave period.

The observation should include the measurement or estimation of the following characteristics of the wave motion of the sea surface in respect of each distinguishable system of waves, namely, sea and swell (principal and secondary):

- (a) Direction (from which the waves come) on the scale 01–36 as for wind direction;
- (b) Period in seconds;
- (c) Height.

The following methods of observing wave characteristics of separate wave systems should be used as a guide.

Wind-generated ocean waves occur in large systems which are defined in connection with the wind field that produced the waves and also with the relative position of the point of observation. Bearing in mind the distinction between sea and swell, the observer should differentiate between the recognizable wave systems on the basis of direction, appearance and period of the waves.

Figure 4.1 shows a typical record drawn by a wave-height recorder. It shows the height of the sea surface above a fixed point against time, namely, it represents the up-and-down movement of a floating

body on the sea surface as it is seen by the observer. It gives a representation of the sea surface in its normal appearance when it is stirred by the wind to form a wind wave.

Waves invariably travel in irregular groups with areas of slight wave development of two or more wave lengths between the groups. The irregularity is greater in the wind wave than in a swell. Furthermore, and this cannot be shown by a wave record, groups consisting of two or more well-formed waves in the sea can be seen to travel in directions which may differ as much as 20° or 30° from each other; as a result of interference of crossing waves, the crests of sea waves are rather short. Swell waves have a more regular appearance. These waves travel in a rather regular succession and well-defined direction with generally long and smooth crests. Undisturbed typical swell waves may be observed in areas where there has been little or no wind over a period of several hours to a day or more. In most areas, sea and swell are intermixed.

In trying to observe the wave characteristics of each of the recognizable wave systems (sea and swell) separately, the observer should be aware of the fact that the higher components of a wind wave resemble swell waves by their comparatively long crests and large periods. It may seem possible to split the assembly of waves of different heights, periods and directions (together forming the system of a wind wave) into two different waves systems and consider the smaller waves as wind waves and the larger waves as swell, but this may not be correct.

The distinction between wind waves and swell should be made on the basis of one of the following criteria:

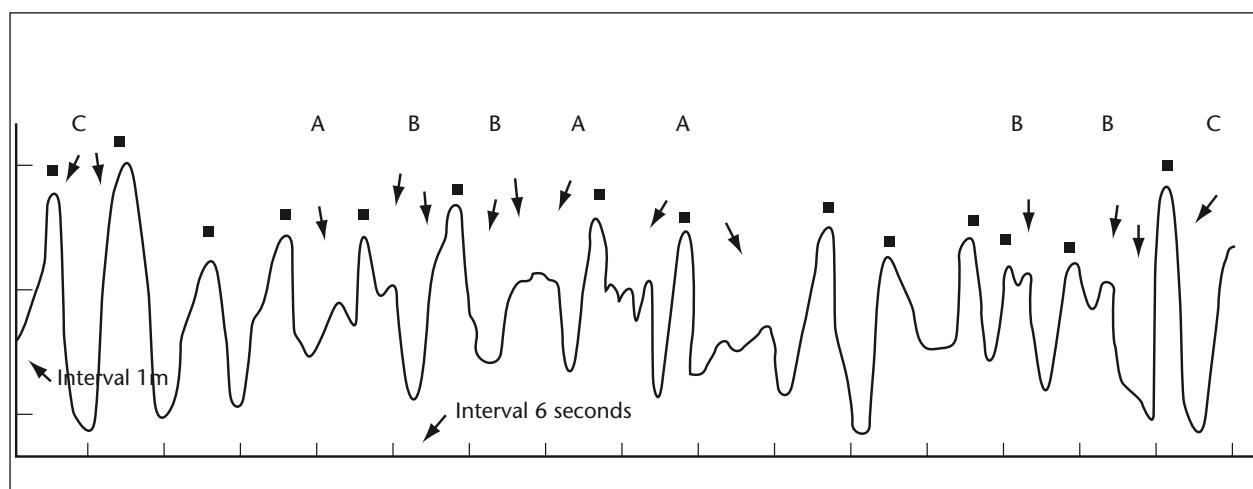

Figure 4.1. Typical sea and swell waves as shown by a wave-height recorder

Wave direction: If the mean direction of all waves of more or less similar characteristics (in particular, height and length) differs by 30° or more from the mean direction of waves of different appearance (in particular, height and/or length), the two sets of waves should be considered to belong to separate wave systems.

Appearance and period: When typical swell waves, characterized by their regular appearance and long crestedness, arrive approximately, namely, within 20°, from the direction of the wind, they should be considered as a separate wave system if their period is at least 4 s greater than the period of the larger waves of the existing wind wave.

For measuring the mean period and height of a wave system, significant waves should be considered only; these are the higher waves in the centre of each group of well-formed waves (Figure 4.1). The flat and badly formed waves (A) in the area between the groups must be omitted from the record.

The mean period and the mean height of about 15 to 20 well-formed waves; from the centres of the groups is actually required; of course, these waves cannot be consecutive. The smaller wave-like disturbances (B) which can be seen clearly to be forming under the action of the wind on top of the larger waves are also to be omitted from the record.

Occasionally, waves may be encountered which literally stand out above the environmental waves (C). Such waves may occur singly or in a group of two or three. The observer should not concentrate on these maximum waves only; in order to arrive at a measure for the mean period and mean height of about 15 to 20 waves, he or she should also consider groups of well-formed waves of medium height. Consequently, the reported wave height will be smaller than the maximum height obtained by the observed waves. On average, the actual height of 1 out of about 10 waves will exceed the height to be reported. It is common practice to define the significant wave height measured by wave height recorders as the average height of the highest one third of the waves; it should approximate the wave height, which would be estimated by a manual observer.

The observer must bear in mind that only measurements or quite good estimates are to be recorded. Rough guesses have little value. The quality of the observations must have priority over their quantity. If only two, or even only one, of the three elements (direction, period, height) could be measured, or

really well estimated, for example, at night, the report would still be of value.

The above considerations must be taken into account in all methods of observation described below. More details on waves are provided in WMO (1998) and WMO (2001), section 4.4.1.

4.2.12.2 Observations from ordinary merchant ships

Wave direction

The direction from which the waves are coming is most easily found by sighting along the wave crests and then turning 90° to face the advancing waves. The observer is then facing the direction in which the waves are coming.

Wave period

This is the only element that can actually be measured on board moving merchant ships. If a stop-watch is available, only one observer is necessary; otherwise, two observers and a watch with a second hand are required. The observer notes some small object floating on the water at some distance from the ship: if nothing is available, a distinctive patch of foam can usually be found which remains identifiable for the few minutes required for the observations. The watch is started when the object appears at the crest of the wave. As the crest passes, the object disappears into the trough, then reappears on the next crest, and so forth. The time at which the object appears to be at the top of each crest is noted. The observations are continued for as long as possible; they will usually terminate when the object becomes too distant to identify, on account of the ship's motion. Obviously, the longest period of observation will be obtained by choosing an object initially on the bow as far off as it can be clearly seen.

Another method is to observe two or more distinct consecutive periods from an individual group while the watch is running continuously; with the passage of the last distinct crest of a group or the anticipated disappearance of the object, the watch is stopped, then restarted with the passage of the first distinct crest of a new group. The observer keeps count of the total number of periods until it reaches at least 15 or 20.

Observations can also be made by watching the pitch and roll of the ship's bow. The observer picks the point which is at the highest or lowest in the cycle and starts the timer from there. When it returns to

the same point, the observer records the time. By repeating this process several times, a reliable observation can be determined. This also works during night-time observation for which the observer feels the rise and fall within his or her body.

With observations of a period less than 5 s and low wind velocity, the above observation may not be easily made, but such waves are less interesting than those with longer periods.

Wave height

With some experience, fairly reliable estimates can be made. For estimating the height of waves having wave lengths much shorter than the ship, the observer should take up a position as low down in the ship as possible, preferably amidships where the pitching is least, and on the side of the ship from which the waves are coming. Use should be made of the intervals which occur every now and then, when the rolling of the ship temporarily ceases.

In cases of waves longer than the ship, the preceding method fails because the ship as a whole rises over the wave. Under these circumstances, the best results are obtained when the observer moves up or down in the ship until, when the ship is in the wave trough and upright, the oncoming waves appear just level with the horizon (Figure 4.2). The wave height is then equal to the height of the observer above the level of the water beneath him or her (a). If the ship is rolling, care should be taken to ensure that the approaching wave is in line with the horizon at the instant when the ship is upright, otherwise the height estimate will be too large (b).

By far the most difficult case is that in which the wave length exceeds the length of the ship, but the wave height is small. The best estimate of height can be obtained by going as near to the water as

possible, but even then the observation can be only a rough estimate.

4.2.12.3 Observations from ocean station vessels and other special ships

Ocean station vessels are normally provided with suitable recording instruments. However, if visual observations are made, the above procedure should be followed; in addition, the ship should heave with the waves coming directly from ahead. For measuring wave period, an object can be thrown over the side of the vessel. For measuring wave height, marks should be painted amidships on the ship's side (half a metre apart).

Length can best be observed by streaming a buoy for such a distance astern that the crests of two successive waves simultaneously pass the buoy and the observer. The distance between the two is the wave length.

The velocity can be obtained by noting the time of the passage of a wave from the stern to the buoy, with allowance being made for the ship's speed.

4.2.12.4 Waves in coastal waters

The following are additional definitions applying to sea surface in coastal waters:

Breaker: The collapse of a whole wave resulting from its running into very shallow water, of a depth of the order of twice the wave height.

Surf: The broken water between the shoreline and the outermost line of the breakers.

Breaking sea: The partial collapse of the crest of a wave caused by the action of the wind; steepening of waves due to their encountering a contrary

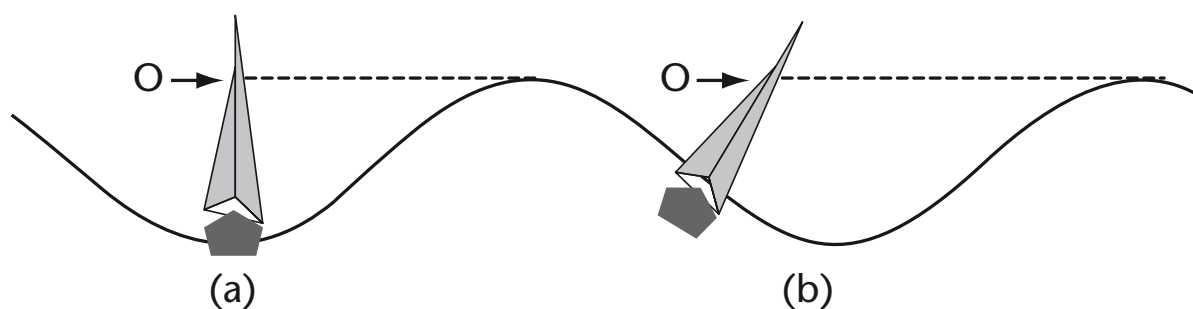

Figure 4.2. The effect of the ship's roll on the estimation of wave height

current or tidal stream; or steepening of waves due to their running into shoal water not shallow enough to cause a breaker.

Wave observations made from a coastal station cannot be expected to be representative of conditions in the open sea. This is because the waves are affected by the depth of the water, by tidal influence and by reflection from objects such as steep rocks and jetties. In addition, the location may be sheltered by headlands or, less obviously, by shoals, both of which may affect the height and direction of travel. An extensive account of these phenomena is given in WMO (1991*b*).

When observations are to be made despite these difficulties, the waves should be chosen in the same way as at sea. If they are required for wave research, the exact mean depth of water at the time of observation and the time itself should both be stated.

4.2.12.5 Terminology for sea and swell waves

The following terminology is recommended for uses other than the inclusion in coded messages, such as supplying weather information and forecasts for shipping, publications, pilots, and so on:

For the length of swell waves:

Short	0–100 m
Average	100–200 m
Long	over 200 m

For the height of swell waves:

Low	0–2 m
Moderate	2–4 m
Heavy	over 4 m

For the height of sea waves:

Calm (glassy)	0 m
Calm (rippled)	0–0.1 m
Smooth (wavelets)	0.1–0.5 m
Slight	0.5–1.25 m
Moderate	1.25–2.5 m
Rough	2.5–4 m
Very rough	4–6 m
High	6–9 m
Very high	9–14 m
Phenomenal	over 14 m

In all cases, the exact bounding length or height is included in the lower category, namely, a sea of 4 m is described as rough. When the state of the sea

surface is so confused that none of the above descriptive terms can be considered appropriate, the term “confused” should be used.

4.2.13 Ice

Several forms of floating ice may be encountered at sea. The most common is that which results from the freezing of the sea surface, namely sea ice. The other forms are river ice and ice of land origin. River ice is encountered in harbours and estuaries where it is kept in motion by tidal streams and normally presents only a temporary hindrance to shipping. Ice of land origin in the form of icebergs is discussed separately below.

Both icebergs and sea ice can be dangerous to shipping and always have an effect on navigation. Sea ice also affects the normal processes of energy exchange between the sea and the air above it. The extent of sea-ice cover can vary significantly from year to year and has a great effect both on adjacent ocean areas and on the weather over large areas of the world. Its distribution is therefore of considerable interest to meteorologists and oceanographers. Broad-scale observations of the extent of sea-ice cover have been revolutionized by satellite photography, but observations from shore stations, ships and aircraft are still of great importance for detailed observations and for establishing the ground truth of satellite observations.

At present, observations of floating ice depend almost entirely on visual estimation. The only instrumental observations of floating ice are carried out by conventional radar and new techniques, such as passive microwave sensors or sideways-looking airborne radar. However, icebergs are poor reflectors of radar energy and cannot always be detected by this means.

4.2.13.1 Observations of ice accretion

Ice accretion can be extremely hazardous because of its effects on small ships, particularly on vessels of less than about 1 000 gross tonnage. Even on ships of the order of 10 000 gross tonnage, it can cause radio and radar failures due to the icing of aerials. Visibility from the bridge may also be affected. Problems have occurred due to icing on the deck cargoes of large container ships. Apart from its possible effect on stability, it may cause difficulty in unloading cargo at the port of destination when containers and their lashings are frozen solidly to the deck. Fishing vessels are particularly vulnerable to ice accretion. Further information is given in WMO (1991*b*), while a

detailed consideration of the meteorological aspects appears in WMO (1974).

There are two main types of icing at sea: icing from seawater and icing from freshwater. Icing from seawater may be due either to spray and seawater thrown up by the interaction between the ship or installation and the waves, or to spray blown from the crests of the waves, or both. Icing from freshwater may be due to freezing rain and/or drizzle, or occasionally when the occurrence of wet snow is followed by a drop in temperature, or it may be due to freezing fog. Both types may occur simultaneously.

The most important meteorological elements governing ice accretion at sea are wind speed and air temperature. The higher the wind speed relative to the ship and the lower the air temperature, the greater the rate of ice accretion. There appears to be no limiting air temperature below which the icing risk decreases.

Provision is made in the WMO code form for ships (WMO, 1995*b*), used for radio weather reports from ships at sea, for the inclusion of reports of ice accretion. This may be done either in code or in plain language. The coded form, in a single five-figure group, provides for reports of the cause of icing, the ice thickness and the rate of accretion. Plain-language reports must be preceded by the word ICING and are particularly encouraged for indicating features of the icing which are dangerous to vessels.

4.2.13.2 Formation and development of sea ice

Ice less than 30 cm thick

The first indication of ice formation is the appearance of small ice spicules or plates in the top few centimetres of the water. These spicules, known as frazil ice, form in large quantities and give the sea an oily appearance. As cooling continues the frazil ice coalesces to form grease ice, which has a matt appearance. Under near-freezing, but as yet ice-free, conditions, snow falling on the surface may result in the sea surface becoming covered by a layer of slush. These forms may be regrouped by the action of wind and waves to form shuga and all are classified as new ice. With further cooling, sheets of ice rind or nilas are formed, depending on the rate of cooling and on the salinity of the water. Ice rind is formed when water of low salinity freezes into a thin layer of brittle ice which is almost free of salt, whereas when water of high salinity freezes,

especially if the process is rapid and the wind is very light, the ice has an elastic property which is characteristic of nilas. The latter form of ice is subdivided, according to its thickness, into dark and light nilas; the second, more advanced form reaches a maximum thickness of 10 cm.

The action of wind and waves may break up ice rind or nilas into pancake ice, which can later freeze and thicken into grey ice and grey-white ice, the latter attaining a thickness of up to 30 cm. These forms of ice are referred to collectively as young ice. In rough conditions this ice may be broken up into ice cakes or floes of various sizes.

Ice 30 cm to 2 m thick

The next stage of development is known as first-year ice and is subdivided into thin, medium and thick categories. Thin first-year ice has a thickness of 30 to 70 cm. Medium first-year ice has a range of thickness from 70 to 120 cm. In polar areas, thick first-year ice may attain a thickness of approximately 2 m at the end of the winter.

Old ice

Thick first-year ice may survive the summer melt season and is then classified as old ice. This category is subdivided into second-year ice or multi-year ice, depending on whether the floes have survived one or more summers. The thickness of old ice is normally in the range of 1.2 to 3 m or more before the onset of the melt season. Towards the end of the summer melt season, old ice may be considerably reduced in thickness. Old ice may often be recognized by a bluish surface, in contrast to the greenish tint of first-year ice.

Snow cover

During winter, ice is usually covered with snow which insulates it from the air above and tends to slow down its rate of growth. The thickness of the snow cover varies considerably from region to region as a result of differing climatic conditions. Its depth may also vary considerably within very short distances in response to variable winds and to ice topography.

Decay of sea ice

While the snow cover persists, almost 90 per cent of the incoming radiation is reflected back into space. Eventually, however, the snow begins to melt as air temperatures rise above 0°C in early summer, and

the resulting freshwater forms puddles on the surface. These puddles absorb about 90 per cent of the incoming radiation and rapidly enlarge as they melt the surrounding snow or ice. Eventually, the puddles penetrate to the bottom surface of the floes and are known as thaw holes. This slow decay process is characteristic of ice in the Arctic Ocean and seas where movement is restricted by the coastline or islands. Where ice is free to drift into warmer waters (for example, the Antarctic, East Greenland and the Labrador Sea), decay is accelerated in response to wave erosion as well as warmer air and sea temperatures.

Movement of sea ice

Sea ice is divided into two main types according to its mobility. One type is drift ice, which is continually in motion under the action of the wind and current; the other is fast ice, attached to the coast or islands, which does not move. When ice concentration is high, namely seven tenths or more, drift ice may be replaced by the term pack ice.

Wind stress in the drift ice causes the floes to move in an approximately downwind direction. The deflecting force due to the Earth's rotation (Coriolis force) causes the floes to deviate about 30° to the right of the surface wind direction in the northern hemisphere. Since the surface wind is itself deviated by a similar amount but in the opposite sense from the geostrophic wind (measured directly from isobars), the direction of movement of the ice floes, due to the wind drift alone, can be considered to be parallel to the isobars.

The rate of movement due to wind drift varies not only with the wind speed, but also with the concentration of the drift ice and the extent of deformation (see subsection below). In very open ice (1/10–3/10) there is much more freedom to respond to the wind than in close ice (7/10–8/10), where free space is limited. Two per cent of the wind speed is a reasonable average for the rate of ice drift caused by the wind in close ice, but much higher rates of ice drift may be encountered in open ice. Since it is afloat, a force is exerted on drift ice by currents that are present in the upper layers of the water, whether these are tidal in nature or have a more consistent direction due to other forces. It is usually very difficult to differentiate between wind- and current-induced ice drift, but in any case, where both are present, the resultant motion is always the vector sum of the two. Wind stress normally predominates, particularly in offshore areas.

Deformation of sea ice

Where the ice is subject to pressure, its surface becomes deformed. On new and young ice, this may result in rafting as one ice floe overrides its neighbour; in thicker ice, it leads to the formation of ridges and hummocks according to the pattern of the convergent forces causing the pressure. During the process of ridging and hummocking, when pieces of ice are piled up above the general ice level, large quantities of ice are also forced downward to support the weight of the ice in the ridge or hummock. The draught of a ridge can be three to five times as great as its height, and these deformations are major impediments to navigation. Freshly formed ridges are normally less difficult to navigate than older weathered and consolidated ridges.

4.2.13.3 Icebergs

Icebergs are large masses of floating ice derived from glaciers, including ice shelves. The depth of a berg under water, compared with its height above, varies widely with different shapes of bergs. The underwater mass of an Antarctic iceberg derived from a floating ice shelf is usually less than the underwater mass of icebergs derived from Greenland glaciers. A typical Antarctic tabular berg, of which the uppermost 10 to 20 m is composed of old snow, will show one part of its mass above the water to five parts below. However, the ratio for an Arctic berg, composed almost wholly of ice with much less snow, is typically 1:8.

Icebergs diminish in size in three different ways: by calving, melting and wave erosion. A berg is said to calve when a piece breaks off; this disturbs its equilibrium and as a result it may drift at a different angle or capsize. Large underwater projections, which may be difficult to observe, are a usual feature of icebergs. In cold water, melting takes place mainly on the water-line, while, in warm water, a berg melts mainly from below and calves frequently. It is particularly dangerous to approach a berg melting in warm water for it is unstable and may fragment or overturn at any time. There are likely to be many growlers and bergy bits around rapidly disintegrating icebergs, thus forming a particular hazard to navigation.

Bergs are poor reflectors of radar energy and cannot always be detected by this means. Their breakdown fragments (bergy bits and growlers) are even more difficult to detect with a ship's radar since they are often obscured by the background clutter from waves and swell. These smaller fragments are especially dangerous to shipping. Despite their low

profile, they contain sufficient mass to damage a vessel which comes into contact with them at normal cruising speed. Some growlers consisting of pure ice hardly break the sea surface and are extremely difficult to detect.

4.2.13.4 Observations of sea ice and icebergs

The key to good ice observing lies in familiarity with the nomenclature and experience. WMO (1970), with its illustrations, is the best guide to the mariner for ice identification.

The four important features of sea ice which affect navigation are as follows:

- (a) Thickness: the stage of development (i.e. new ice, young ice, first-year ice or old ice and their subdivisions);
- (b) Amount: concentration (estimated according to the tenths of the sea surface covered by ice);
- (c) The form of the ice, whether it is fast or drift ice and the size of the constituent floes;
- (d) Movement: particularly with regard to its effect on deformation.

Since icebergs represent such a hazard to navigation, particularly at night or in poor visibility, it is also important to report the number in sight at the time of the observation, especially in waters where they are less frequently observed.

Sea ice can be reported in plain language or by the use of codes. WMO has adopted two sea-ice codes for international use. The simplest is the ICE group appended to the SHIP code format. The ICEAN code has been developed for specialist use for the transmission of sea-ice analysis and prognoses.

There are two basic rules for observation from ships and shore stations:

- (a) Obtain a large field of view by making the observation from the highest convenient point above the sea surface (for example, the top of a lighthouse, the bridge or crow's nest of a ship);
- (b) Do not attempt to report sea-ice conditions beyond a radius of more than half the distance between the point of observation and the horizon.

WMO has developed a set of symbols for use on maps depicting actual or forecast sea-ice conditions. These symbols are intended for the international exchange of sea-ice information and for radiofacsimile transmission of ice data.

4.2.14 Observations of special phenomena

When describing waterspouts, the direction of rotation should always be given as if seen from above.

4.2.15 Operations of the voluntary observing fleet

An essential initial step in recruiting voluntary observers is to obtain the permission of the owners and master of the vessel. When permission has been granted and the observer has been identified, Port Meteorological Officers should provide input into the following aspects:

- (a) Care of the instruments in general;
- (b) Exposure and reading of the hygrometer or psychrometer;
- (c) Obtaining seawater samples and reading the temperature thereof;
- (d) Cloud observations with particular reference to cloud height;
- (e) Use of the present weather code;
- (f) Coding and transmission of observations by radio;
- (g) The ways in which mariners may use the weather information they receive by radio from various countries during their voyage.

Once a ship has been recruited, the Port Meteorological Officer should endeavour to visit it at least every three months to check the accuracy of the instruments and to renew the supply of forms, documents, and so on. The Port Meteorological Officer should take the opportunity to foster interest in meteorology, to explain the mutual value to seafarers and meteorologists of accurate weather information and to offer access to meteorological data under way from the different National Meteorological Service facsimile broadcasts, e-mail receipt, and so forth.

Full information on the WMO VOS scheme is given in WMO (2001).

4.3 MOORED BUOYS

A typical moored buoy designed for deep ocean operation is equipped with sensors to measure the following variables:

- (a) Wind speed;
- (b) Wind direction;
- (c) Atmospheric pressure;
- (d) Sea-surface temperature;
- (e) Wave height and period;

- (f) Air temperature;
- (g) Dewpoint temperature or relative humidity (to be converted to dewpoint temperature).

Additional elements measured by some data buoys are as follows:

- (a) Wave spectra (directional or non-directional);
- (b) Solar radiation;
- (c) Surface current or current profilers;
- (d) Salinity;
- (e) Subsurface temperature down to 500 m;
- (f) Atmospheric visibility;
- (g) Precipitation.

In addition to the meteorological and oceanographic measurements, it is usual to monitor buoy location and various housekeeping parameters to aid data quality control and maintenance. Moored-buoy technology has matured to the extent that it is usual to obtain six months to one year of unattended operation even in the most severe conditions. Operational life is largely determined by the life of the sensors, with sensor exchanges expected at 12- to 18-month intervals.

The observations from moored buoys are now considered to be better than ship observations with regard to the accuracy and reliability of measurements (Wilkerson and Earle, 1990).

Typical measurement uncertainties obtained from operational buoys are as follows:

Wind speed	1 m s ⁻¹ or 10%
Wind direction	10°
Air temperature	1°C
Air pressure	0.5 hPa
Sea-surface temperature	1°C
Relative humidity	6%
Significant wave height	0.2 m or 5%
Wave period	1 s

Wind sensors on moored buoys are mounted typically at a height of 3 to 5 m. Most designs follow the surface waves (indeed this is essential for accurate wave-height reporting), and it is feasible to adjust wind speeds to the standard reference height of 10 m. Various profile formulations have been proposed for wind variation with height above the sea surface, but, as the anemometer exposure height is sometimes below the significant wave height (i.e. within the disturbed boundary layer) it is not clear that the theory applies. An introduction to the measurement of waves and to the literature may be found in WMO/IOC (1996). One measure of significant wave height is four times the root-mean-square of

the height of the sea around the zero level over a 10 min period. Wave period in the same system is the average zero up-crossing period in the 10 min record.

Moored buoys are complex and expensive equipment to operate. The harsh environment in which they are deployed places severe demands on the engineering design and quality of construction. Further information on the design, operation and performance of moored buoys can be found in WMO/IOC (1996).

4.4 UNSTAFFED LIGHT VESSELS

In most respects, these platforms are similar to moored buoys. However, because of their larger dimensions and the feasibility of carrying a large instrument payload, it is more straightforward to deploy additional sensors, such as visibility sensors. In severe weather, such sensors can be affected by sea spray generated by the vessel itself. However, in most conditions, performance is equal to that of instruments deployed on land-based automatic weather stations.

4.5 TOWERS AND PLATFORMS

On towers (usually in relatively shallow waters close to shore) it is possible to operate standard automatic weather stations, similar in design to land automatic weather stations (see Part II, Chapter 1). Additional sensors are often deployed, for example, wave sensors and sensors for measuring mean water level above a reference point, ceilometers and visimeters. On staffed platforms, measured data can be supplemented by visual observations of cloud, visibility and weather, thus allowing full synoptic reporting.

Platforms and towers are rarely ideal structures for mounting meteorological sensors. Wind measurements might be taken at heights in excess of 100 m above mean sea level and correction to the equivalent 10 m surface wind is complicated by the effects of sea-surface roughness, itself related to wind speed. In the case of towers close inshore, tide height can significantly alter the effective height of the wind sensor. Temperature and humidity sensors need very careful positioning as often there are heat and exhaust sources that will modify the local environment. It follows, therefore, that towers and platforms are unlikely to provide data to the

accuracy and representativeness expected from a modern moored buoy.

4.6 DRIFTING BUOYS

Drifting buoys have been used for many years in oceanography, principally for the measurement of sea-surface currents. However, the development of reliable satellite tracking and data relay systems (WMO/IOC, 1995a) has led to a dramatic increase in the numbers of ocean drifting buoys deployed, and significant development has taken place in the sensor capabilities of drifters for meteorological and oceanographic purposes.

A description of drifting buoy systems and operations is given in UNESCO (1988). More recently, the WMO/IOC Data Buoy Cooperation Panel (DBCP) published the *Surface Velocity Programme Barometer Drifter Design Reference* (WMO/IOC, 2005). See also the annual reports and workshop proceedings of the DBCP, such as WMO/IOC (2004a and 2004b).

The evolution of drifting buoy technology has been driven mainly by the needs of oceanographic research, on the one hand, and operational meteorology, on the other. Thus, three main distinct types of buoys can be characterized as follows:

- (a) For oceanographic research, and especially for the World Ocean Circulation Experiment (Surface Velocity Programme, SVP, 1988–1993), a surface-current-following drifter equipped also to measure sea-surface temperature has been developed and deployed in large numbers over the world's oceans;
- (b) For operational meteorology, a drifting buoy design has evolved based on those developed for the First Global Atmospheric Research Programme Global Experiment. These buoys primarily measure air pressure, sea-surface temperature and air temperature;
- (c) For polar applications, different ice floats have been designed to measure traditional atmospheric variables as well as ice and snow conditions (ice/snow temperature and temperature profiles in the ice, ice thickness, ice stress, water conditions below ice). By tracking the

buoy position on the ice it is possible to estimate ice motion. In the last 15 years, efforts have been made to develop buoys that meet the combined requirements of oceanographic research and operational meteorology. This has resulted in the development of:

- (i) The SVP-B drifter, which is essentially a surface-current-following drifter with an air pressure sensor added;
- (ii) The SVP-BW drifter (or Minimet), which is essentially an SVP-B drifter with wind-measuring capability using so-called Wind Observation Through Ambient Noise (WOTAN) technology;
- (iii) The wind and temperature profile buoy, which is basically a meteorological drifter with added wind speed sensor and subsurface thermistor chain for the measurement of temperature profile to depths of 100 m or so. Wind direction is measured on these buoys by orienting the whole buoy into the wind using a profiled mast or fixed wind vane;
- (iv) The addition of salinity sensors to SVP drifters.

Drifting buoys are expendable devices, thus performance is a compromise between the requirements and the cost of ownership. As well as hardware costs, it should be noted that the cost of data processing and dissemination throughout the satellite (Argos) system is significant and can be a limiting factor. Despite these constraints, the performance of drifting buoy sensors is adequate for the purposes of synoptic meteorology and oceanography, as appropriate.

The typical measurement uncertainties of operational systems are as follows:

Sea-surface temperature	0.5°C
Air pressure	1 hPa
Air temperature	1°C
Wind speed	1 m s ⁻¹ or 10% ^a
Wind direction	15°
Subsurface temperature	0.5°C
Current speed	2 cm s ⁻¹

^a Because of the low sensor height (approximately 1 m above sea level) these uncertainties apply to low wind speed and low sea states only.

ANNEX

DESCRIPTIONS OF PRECIPITATION FOR USE BY SHIP-BORNE OBSERVERS

Precipitation occurs either in a more or less uniform manner (intermittent or continuous) or in showers.

All precipitation other than showers must be reported as intermittent or continuous.

Non-showery precipitation usually falls from stratiform clouds (mainly altostratus and nimbostratus). Showers fall from large convective clouds (mainly cumulonimbus or cumulus of moderate or strong vertical development) and are usually characterized by their abrupt beginning and ending and by variations in the intensity of the precipitation. Drops and solid particles in a shower are generally larger than those occurring in non-showery precipitation.

The drops of precipitation can be supercooled (i.e. the temperature of the drops is below 0°C). On impact with a surface, drops of supercooled rain form a mixture of water and ice having a temperature near 0°C.

Forms of precipitation

The descriptions given below are compatible with the definitions given in Part III.2, Volume I, of the *International Cloud Atlas* (WMO, 1975):

Drizzle: Fairly uniform precipitation in the form of very small drops of water. The diameter of the drops is normally less than 0.5 mm. The drops appear almost to float, thus making visible even slight movements of the air. Drizzle falls from a continuous and fairly dense layer of stratiform cloud, which is usually low, sometimes touching the surface (fog). For coding purposes, drizzle must be classified as slight, moderate or heavy, which are defined as follows:

- (a) *Slight drizzle* can be readily detected on the face of wheel-house windows, but produces very little runoff from deck, roofs, and so on;
- (b) *Moderate drizzle* causes windows, decks and superstructures to stream with moisture;
- (c) *Heavy drizzle:* same as for moderate drizzle. It also reduces visibility to below 1 000 m.

Rain: Precipitation of drops of water, which falls from a cloud. The diameter and concentration of raindrops vary considerably according to the intensity, and

especially the nature, of the precipitation (continuous rain, rain shower, downpour, etc.). Continuous rain usually falls from a more or less uniform layer or layers of thick stratiform cloud. For coding purposes, rain must be classified as slight, moderate or heavy. These terms are defined as follows:

- (a) *Slight rain* may consist of scattered large drops or numerous smaller drops. The rate of accumulation on a deck is low and puddles form very slowly;
- (b) *Moderate rain:* Individual drops are not clearly identifiable. Rain spray is observable. Puddles form rapidly. Sounds from roofs range from swishing to a gentle roar;
- (c) *Heavy rain:* A downpour which makes a roaring noise on awnings and deckheads and forms a misty spray of fine droplets by splashing on deck surfaces.

Snow: Precipitation of ice crystals, separately or agglomerated, which falls from a cloud. The form, size and concentration of snow crystals vary considerably according to the conditions prevailing at the time of the snowfall. The intensity is coded as slight, moderate or heavy.

Showers: These are characterized by their abrupt beginning and end, and by the generally rapid and sometimes violent variations in the intensity of the precipitation. Drops and solid particles falling in a shower are generally larger than those falling in non-showery precipitation. Whether the precipitation (rain or snow) occurs as showers or not depends on the clouds in which it originates. Showers fall from large convection clouds and are defined as follows:

- (a) *Rain and snow showers* must be classified for coding purposes with regard to intensity as either slight, moderate or heavy. The description is the same as for slight, moderate or heavy rain or snow. It must be remembered, however, that the visibility in showery weather shows a much greater variability than for the same category of continuous rain;
- (b) *Violent showers* are exceptionally heavy or torrential rain showers. Such showers occur mostly in tropical regions.

Snow pellets: Precipitation of white and opaque ice particles which falls from a cloud. These particles are generally conical or rounded. Their diameter

may attain 5 mm. These grains, having a snow-like structure, are brittle and easily crushed; when they fall on a hard surface they bounce and often break up. In most cases, snow pellets fall as showers, often together with snowflakes, normally when temperatures near the surface are close to 0°C. For recording purposes, the intensity of snow pellets, when they occur alone, is determined according to the visibility in the same manner as for snow.

Hail: Precipitation of transparent, or partly or completely opaque, particles of ice (hailstones), which are usually spherical, conical or irregular in form and have a diameter generally between 5 and 50 mm (smaller particles of similar origin may be classified either as small hail or ice pellets), and fall either separately or agglomerated into irregular lumps. Hail always occurs in the forms of showers and is generally observed during heavy thunderstorms. For coding purposes, hail must be classified as either slight, moderate or heavy. The intensity is determined by the rate of accumulation of stones as follows:

- (a) *Slight hail:* Few stones falling, no appreciable accumulation on flat surfaces;
- (b) *Moderate hail:* Slow accumulation of stones. Fall sufficient to whiten the decks;
- (c) *Heavy hail:* Rapid accumulation of stones. Rarely experienced in temperate latitudes at sea.

Small hail: Precipitation of translucent ice particles which falls from a cloud. These particles are almost

spherical and sometimes have conical tips. Their diameter may attain and even exceed 5 mm. Usually, small hail is not easily crushable and when it falls on a hard surface it bounces with an audible sound on impact. Small hail always occurs in showers. For coding purposes, small hail must be classified as either slight, moderate or heavy. The intensity is determined by using the accumulation rate given for hail.

Ice pellets: Precipitation of transparent ice particles which falls from a cloud. These particles are usually spherical or irregular, rarely conical. Their diameter is less than 5 mm. Usually, ice pellets are not easily crushable, and when they fall on hard surfaces they generally bounce with an audible sound on impact. Precipitation in the form of ice pellets generally falls from altostratus or nimbostratus. The intensity of ice pellets is determined in the same manner as for hail.

Snow grains: Precipitation of very small opaque white particles of ice which falls from a cloud. These particles are fairly flat or elongated; their diameter is generally less than 1 mm. When the grains hit a hard surface they do not bounce. They usually fall in small quantities, mostly from stratus or from fog and never in the form of a shower. This precipitation corresponds to drizzle and occurs when the temperature is approximately between 0°C and –10°C. As there is only one code specification which refers to snow grains (ww – 77), it is not necessary to classify intensity.

REFERENCES AND FURTHER READING

- Bowditch, N. and the National Imagery and Mapping Agency, 2002: *The American Practical Navigator: An Epitome Of Navigation*. 2002 Bicentennial edition, NIMA Pub. No. 9, Bethesda (available from <http://pollux.nss.nima.mil/pubs/>).
- Taylor, P.K., E.C. Kent, M.J. Yelland and B.I. Moat, 1999: *The Accuracy of Marine Surface Winds from Ships and Buoys*. CLIMAR 99, WMO Workshop on Advances in Marine Climatology, Vancouver, 8–15 September 1999 (available from <http://www.noc.soton.ac.uk/JRD/MET/PDF/climar.html>).
- United Kingdom Meteorological Office, 1995: *Marine Observers Handbook*. Eleventh edition, UK Met Office No. 1016, London.
- United Nations Educational, Scientific and Cultural Organization, 1988: *Guide to Drifting Data Buoys*. WMO/IOC Manuals and Guides 20.
- Wilkerson, J.C. and M.D. Earle, 1990: A study of differences between environmental reports by ships in the voluntary observing program and measurements from NOAA buoys. *Journal of Geophysical Research*, Volume 95, Number C3, pp. 3373–3385.
- World Meteorological Organization, 1962: *Precipitation Measurements at Sea*. Technical Note No. 47, WMO-No. 124.TP.55, Geneva.
- World Meteorological Organization, 1970: *WMO Sea-ice Nomenclature*. Volumes I and III, WMO-No. 259.TP. 145, Geneva.
- World Meteorological Organization, 1972: *Comparative Sea-surface Temperature Measurements* (R.W. James and P.T. Fox). Report on Marine Science Affairs No. 5, WMO-No. 336, Geneva.
- World Meteorological Organization, 1974: *The Meteorological Aspects of Ice Accretion on Ships* (H.C. Shellard). Report on Marine Science Affairs No. 10, WMO-No. 397, Geneva.
- World Meteorological Organization, 1975: *International Cloud Atlas*. Volume I, WMO-No. 407, Geneva.
- World Meteorological Organization, 1981: *Precipitation Measurement at Sea* (G. Olbrück). Marine Meteorology and Related Oceanographic Activities Report No. 1, Geneva.
- World Meteorological Organization, 1989: *Wind Measurements Reduction to a Standard Level* (R.J. Shearman and A.A. Zelenko). Marine Meteorology and Related Oceanographic Activities Report No. 22, WMO/TD-No. 311, Geneva.
- World Meteorological Organization, 1991a: *Compendium of Lecture Notes in Marine Meteorology for Class III and Class IV Personnel* (J.M. Walker). Second edition, WMO-No. 434, Geneva.
- World Meteorological Organization, 1991b: *The Accuracy of Ship's Meteorological Observations: Results of the VSOP-NA* (E.C. Kent, B.S. Truscott, P.K. Taylor and J.S. Hopkins). Marine Meteorology and Related Oceanographic Activities Report No. 26, WMO/TD-No. 455, Geneva.
- World Meteorological Organization/Intergovernmental Oceanographic Commission, 1995a: *Guide to Data Collection and Location Services using Service Argos*. Data Buoy Cooperation Panel Technical Document No. 3, Geneva and Paris.
- World Meteorological Organization, 1995b: *Manual on Codes*, Volumes I.1 and I.2, WMO-No. 306, Geneva.
- World Meteorological Organization/Intergovernmental Oceanographic Commission, 1996: *Guide to Moored Buoys and Other Ocean Data Acquisition Systems* (E.A. Meindl). Data Buoy Cooperation Panel Technical Document No. 8, Geneva and Paris.
- World Meteorological Organization, 1998: *Guide to Wave Analysis and Forecasting*. Second edition, WMO-No. 702, Geneva.
- World Meteorological Organization, 1999: The accuracy of meteorological observations from Voluntary Observing ships: Present status and future requirements (P.K. Taylor and E.C. Kent). *Final Report of the First Session of the Commission for Marine Meteorology Working Group on Marine Observing Systems Subgroup on Voluntary Observing Ships* (Athens 1999), WMO TC CMM 1999, Geneva.
- World Meteorological Organization, 2001: *Guide to Marine Meteorological Services*. Third edition, WMO-No. 471, Geneva.
- World Meteorological Organization, 2003: *Manual on the Global Observing System*. Volumes I and II, WMO-No. 544, Geneva.
- World Meteorological Organization/Intergovernmental Oceanographic Commission, 2004a: *Data Buoy Cooperation Panel: Annual Report for 2003*. Data Buoy Cooperation Panel Technical Document No. 25, Geneva and Paris. (available through <http://www.jcommops.org/dbcp>).
- World Meteorological Organization/Intergovernmental Oceanographic Commission, 2004b: *Research, Applications and Developments involving Data Buoys*. Presentations at the Data Buoy Cooperation Panel Technical Workshop, (Angra

- Dos Reis, Brazil, October 2003). Data Buoy Cooperation Panel Technical Document No. 24, Geneva and Paris.
- World Meteorological Organization/Intergovernmental Oceanographic Commission, 2005: *Surface Velocity Programme Barometer Drifter Design Reference*. Data Buoy Cooperation Panel Technical Document No. 4, revision 2, Geneva and Paris.
- Yelland, M.J., B. I. Moat and P. K. Taylor, 2001: *Air flow distortion over merchant ships*. Progress Report to the Atmospheric Environment Service, Canada, 32 pp. (available from http://www.soc.soton.ac.uk/JRD/MET/PDF/airflow_report.pdf).
-

CHAPTER 5

SPECIAL PROFILING TECHNIQUES FOR THE BOUNDARY LAYER AND THE TROPOSPHERE

5.1 GENERAL

Special profiling techniques have been developed to obtain data at high temporal and spatial resolution which is needed for analysis, forecasting and research on the smaller meteorological scales and for various special applications. This chapter gives a general overview of current ground-based systems that can be used for these purposes. It is divided into two main parts: remote-sensing and in situ direct measuring techniques. Some of these techniques can be used for measurements over the whole troposphere, and others are used in the lower troposphere, in particular in the planetary boundary layer.

Remote-sensing techniques are based on the interaction of electromagnetic or acoustic energy with the atmosphere. The measuring instrument and the variable to be measured are spatially separated, as opposed to on-site (in situ) sensing. For atmospheric applications, the technique can be divided into passive and active techniques. Passive techniques make use of naturally occurring radiation in the atmosphere (microwave radiometers). Active systems (sodars, windprofilers, RASSs – radio acoustic sounding systems – and lidars) are characterized by the injection of specific artificial radiation into the atmosphere. These ground-based profiling techniques are described in section 5.2. Other remote-sensing techniques relevant to this chapter are discussed in Chapters 8 and 9, Part I.

Section 5.3 describes in situ techniques with instruments located on various platforms to obtain measurements directly in the boundary layer (balloons, boundary layer radiosondes, instrumented towers and masts, instrumented tethered balloons). Chapters 12 and 13 in Part I describe the more widely used techniques using balloons to obtain profile measurements.

The literature on profiling techniques is substantial. For general discussions and comparisons see Derr (1972), WMO (1980), Martner and others (1993) and the special issue of the *Journal of Atmospheric and Oceanic Technology* (Volume II, No. 1, 1994).

5.2 GROUND-BASED REMOTE-SENSING TECHNIQUES

5.2.1 Acoustic sounders (sodars)

Sodars (sound detection and ranging) operate on the principle of the scattering of acoustic waves by the atmosphere. According to the theory of the scattering of sound, a sound pulse emitted into the atmosphere is scattered by refractive index variations caused by small-scale turbulent temperature and velocity fluctuations, which occur naturally in the air and are particularly associated with strong temperature and humidity gradients present in inversions. In the case of backscattering (180°), only temperature fluctuations with a scale of one half of the transmitting acoustic wavelength determine the returned echo, while, in other directions, the returned echo is caused by both temperature and velocity fluctuations, except at an angle of 90° , where there is no scattering.

Useful references to acoustic sounding include Brown and Hall (1978), Neff and Coulter (1986), Gaynor, Baker and Kaimal (1990) and Singal (1990).

A number of different types of acoustic sounders have been developed, but the two most common types considered for operational use are the monostatic sodar and the monostatic Doppler sodar.

A monostatic sodar consists of a vertically pointed pulsed sound source and a collocated receiver. A small portion of each sound pulse is scattered back to the receiver by the thermal fluctuations which occur naturally in the air. The receiver measures the intensity of the returned sound. As in a conventional radar, the time delay between transmitting and receiving an echo is indicative of the target's range. In a bistatic sodar, the receiver is located some distance away from the sound source to receive signals caused by velocity fluctuations.

As well as measuring the intensity of the return signal, a monostatic Doppler sodar also analyses the frequency spectrum of the transmitted and received signals to determine the Doppler frequency shift between transmitted and backscattered sound. This difference arises because of the motion of the temperature fluctuations

with the air, and provides a measure of the radial wind speed of the air. A Doppler sodar typically uses three beams, one directed vertically and two tilted from the vertical to determine wind components in three directions. The vertical and horizontal winds are calculated from these components. The vector wind may be displayed on a time-height plot at height intervals of about 30 to 50 m.

The maximum height that can be reached by acoustic sounders is dependent on system parameters, but also varies with the atmospheric conditions. Economical systems can routinely reach heights of 600 m or more with height resolutions of a few tens of metres.

A sodar might have the following characteristics:

Parameter	Typical value
Pulse frequency	1 500 Hz
Pulse duration	0.05 to 0.2 s
Pulse repetition period	2 to 5 s
Beam width	15°
Acoustic power	100 W

Monostatic sodars normally produce a time-height plot of the strength of the backscattered echo signal. Such plots contain a wealth of detail on the internal structure of the boundary layer and can, in principle, be used to monitor inversion heights, the depth of the mixing layer – changes in boundary stability – and the depth of fog. The correct interpretation of the plots, however, requires considerable skill and background knowledge, and preferably additional information from in situ measurements and for the general weather situation.

Monostatic Doppler sodar systems provide measurements of wind profiles as well as intensity information. Such systems are a cost-effective method of obtaining boundary layer winds and are particularly suited to the continuous monitoring of inversions and winds near industrial plants where pollution is a potential problem.

The main limitation of sodar systems, other than the restricted height coverage, is their sensitivity to interfering noise. This can arise from traffic or as a result of precipitation or strong winds. This limitation precludes their use as an all weather system. Sodars produce sound, the nature and level of which is likely to cause annoyance in the near vicinity, and this may preclude their use in otherwise suitable environments.

Some systems rely upon absorbent foam to reduce the effect of external noise sources and to reduce any annoyance caused to humans. The physical

condition of such foam deteriorates with time and must be periodically replaced in order to prevent deterioration in instrument performance.

5.2.2 Wind profiler radars

Wind profilers are very-high and ultra-high-frequency Doppler radars designed for measuring wind profiles in all weather conditions. These radars detect signals backscattered from radio refractive index irregularities associated with turbulent eddies with scales of one half of the radar wavelength (the Bragg condition). As the turbulent eddies drift with the mean wind, their translational velocity provides a direct measure of the mean wind vector. Unlike conventional weather radars, they are able to operate in the absence of precipitation and clouds. Profilers typically measure the radial velocity of the air in three or more directions — vertically and 15° off-vertical in the north and east direction — and from these components they determine the horizontal and vertical wind components. Simpler systems may only measure the radial velocity in two off-vertical directions and, by assuming that the vertical air velocity is negligible, determine the horizontal wind velocity. The four-beam profiler wind measurement technique is more practical than the three-beam profiler technique in that its measurement is not affected significantly by vertical wind (Adachi and others, 2005).

For further discussion see Gossard and Strauch (1983), Hogg and others (1983), Strauch and others, (1990) Weber and Wuertz (1990) and WMO (1994).

The nature of the scattering mechanism requires wind profiler radars to function between 40 and 1 300 MHz. Performance deteriorates significantly at frequencies over 1 300 MHz. The choice of operating frequency is influenced by the required altitude coverage and resolution. In practice, systems are built for three frequency bands (around 50 MHz, 400 MHz and 1 000 MHz) and these systems operate in low mode (shorter pulse: lower altitude) and high mode (longer pulse: higher altitude) which trade vertical range for resolution. Typical characteristics are summarized in the table below.

Profilers are able to operate unattended and to make continuous measurements of the wind almost directly above the site. These features are the principal advantages that profilers have over wind-measuring systems which rely on tracking balloons.

<i>Profiler parameter</i>	<i>Stratosphere</i>	<i>Troposphere</i>	<i>Lower troposphere</i>	<i>Boundary layer</i>
Frequency (MHz)	50	400	400	1 000
Peak power (kW)	500	40	2	1
Operating height range (km)	3–30	1–16	0.6–5	0.3–2
Vertical resolution (m)	150	150	150	50–100
Antenna type	Yagi-array	Yagi-array or Coco	Yagi-array or Coco	Dish or phased array
Typical antenna size (m)	100×100	10×10	6×6	3×3
Effect of rain or snow	Small	Small in light rain	Small in light rain	Great

Any given profiler has both minimum and maximum ranges below and above which it cannot take measurements. The minimum range depends on the length of the transmitted pulse, the recovery time of the radar receiver and the strength of ground returns received from nearby objects. Thus, care must be taken in siting profilers so as to minimize ground returns. Sites in valleys or pits may be chosen so that only the ground at very short range is visible. These considerations are most important for stratospheric profilers. The extent of the ground clutter effects on higher frequency radars can be reduced by suitable shielding.

The signal received by profilers generally decreases with increasing height. This ultimately limits the height to which a given profiler can take measurements. This maximum range is dependent on the characteristics of the radar and increases with the product of the mean transmitter power and the antenna aperture, but is subject to an absolute limit determined by the radar frequency used. These factors mean that the large high-powered stratospheric profilers are able to take measurements at the greatest heights. For a given profiler, however, the maximum height varies considerably with the meteorological conditions; on occasions there may be gaps in the coverage at lower heights.

Because it is important to take measurements at the maximum height possible, profilers gather data for several minutes in order to integrate the weak signals obtained. Typically, a profiler may take 6 or 12 min to make the three sets of observations required to measure the wind velocity. In many systems, a set of such observations is combined to give an hourly measurement.

Because profilers are made to be sensitive to the very weak returns from atmospheric inhomogeneities, they can also detect signals from aircraft, birds and

insects. In general, such signals confuse the profilers and may lead to erroneous winds being output. In these circumstances, a number of independent measurements will be compared or combined to give either an indication of the consistency of the measurements or reject spurious measurements.

In the 1 000 and 400 MHz bands, precipitation is likely to present a larger target than the refractive index inhomogeneities. Consequently, the measured vertical velocity is reflectivity-weighted and is not operationally useful.

Large stratospheric profilers are expensive and require large antenna arrays, typically 100 m × 100 m, and relatively high power transmitters. Because they are large, it can be difficult to find suitable sites for them, and their height resolution and minimum heights are not good enough for certain applications. They have the advantage of being able to take routinely wind measurements to above 20 km in height, and the measurements are unaffected by all but the heaviest of rainfall rates.

Tropospheric profilers operating in the 400–500 MHz frequency band are likely to be the most appropriate for synoptic and mesoscale measurements. They are of modest size and are relatively unaffected by rain.

Boundary layer profilers are less expensive and use small antennas. Vertical velocity cannot be measured in rain, but raindrops increase the radar cross-section and actually increase the useful vertical range for the measurement of horizontal wind.

Profilers are active devices and obtaining the necessary frequency clearances is a serious problem in many countries. However, national and international allocation of profiler frequencies is actively being pursued.

5.2.3 **Radio acoustic sounding systems**

A radio acoustic sounding system is used to measure the virtual temperature profile in the lower troposphere. The technique consists in tracking a short high-intensity acoustic pulse that is transmitted vertically into the atmosphere by means of a collocated microwave Doppler radar. The measuring technique is based on the fact that acoustic waves are longitudinal waves that create density variations of the ambient air. These variations cause corresponding variations in the local index of refraction of the atmosphere which, in turn, causes a backscattering of the electromagnetic energy emitted by the microwave Doppler radar as it propagates through the acoustic pulse. The microwave radar measures the propagation speed of these refractive index perturbations as they ascend at the local speed of sound. The acoustic wavelength is matched to one half of the microwave wavelength (the Bragg condition), so that the energy backscattered from several acoustic waves adds coherently at the receiver, thus greatly increasing the return signal strength. By measuring the acoustic pulse propagation speed, the virtual temperature can be calculated as this is proportional to the square of the pulse propagation speed minus the vertical air speed.

The extensive literature on this technique includes May and others (1990), Lataitis (1992*a*; 1992*b*) and Angevine and others (1994).

A variety of experimental techniques have been developed to sweep the acoustic frequency and then to obtain a virtual temperature profile. A number of RASSs have been developed by adding an acoustic source and suitable processing to existing profiler radars of the type mentioned above. For radar frequencies of 50, 400 and 1 000 MHz, acoustic frequencies of about 110, 900 and 2 000 Hz are required. At 2 000 Hz, acoustic attenuation generally limits the height coverage to 1 to 2 km. At 900 Hz, practical systems can reach 2 to 4 km. At 110 Hz, by using large 50 MHz profilers, maximum heights in the range of 4 to 8 km can be achieved under favourable conditions.

Comparisons with radiosondes show that, under good conditions, virtual temperatures can be measured to an accuracy of about 0.3°C with height resolutions of 100 to 300 m. However, the measurements are likely to be compromised in strong winds and precipitation.

The RASS technique is a promising method of obtaining virtual temperature profiles, but further investigation is required before it can be used

operationally with confidence over a height range, resolution and accuracy that respond to user requirements.

5.2.4 **Microwave radiometers**

Thermal radiation from the atmosphere at microwave frequencies originates primarily from oxygen, water vapour and liquid water and is dependent on their temperature and spatial distribution. For a gas such as oxygen, whose density as a function of height is well known, given the surface pressure, the radiation contains information primarily on the atmospheric temperature. Vertical temperature profiles of the lower atmosphere can be obtained by ground-based passive microwave radiometers measuring the microwave thermal emission by oxygen in a spectral band near 60 GHz. Spectral measurements in the 22–30 GHz upper wing of the pressure broadened water vapour absorption band provide information on the integrated amount of water vapour and liquid water, and the vertical distribution of water vapour. In addition, spectral measurements in both bands, combined with infrared cloud-base temperature measurements, provide information on the integrated amount and the vertical distribution of liquid water. For further information, see Hogg and others (1983) and Westwater, Snider and Falls (1990), Solheim and others (1998), Ware and others (2003) and Westwater and others (2005).

Individual downward-looking radiometers operating at different frequencies are maximally sensitive to temperature at particular ranges of atmospheric pressure. The sensitivity as a function of pressure follows a bell-shaped curve (the weighting function). The frequencies of the radiometers are chosen so that the peaks in the weighting functions are optimally spread over the heights of interest. Temperature profiles above the boundary layer are calculated by means of numerical inversion techniques using measured radiations and weighting functions. The relatively broad width of the weighting function curves, and radiation from the terrestrial surface, precludes accurate temperature profiles from being obtained near the surface and in the boundary layer when using space-based radiometer soundings.

The principles of upward-looking radiometric temperature and humidity sounding from the terrestrial surface are well established. The temperature weighting functions of upward-looking profiling radiometers have narrow peaks near the surface that

decrease with height. In addition, sensitivity to oxygen and water vapour emissions is not degraded by radiation from the terrestrial surface. This allows accurate temperature and humidity profile retrievals with relatively high resolution in the boundary layer and lower troposphere. Inversion techniques for upward-looking radiometers are based on temperature and humidity climatology for the site that is typically derived from radiosonde soundings.

Ground-based and satellite-based radiometers are highly complementary. Satellite measurements provide coarse temporal and spatial resolution in the upper troposphere, and ground-based measurements provide high temporal and spatial resolution in the boundary layer and lower troposphere. Retrieved profiles from ground-based radiometers can be assimilated into numerical weather models to improve short term (1–12 h) forecasting by providing upper-air data in the interval between radiosonde soundings. Alternatively, raw brightness temperature from terrestrial radiometers can be assimilated directly into numerical weather models. This approach improves results by avoiding errors inherent in the profile retrieval process. A similar method, which assimilates raw satellite radiometer radiances directly into weather models, demonstrated improved results years ago and is now widely used.

The main advantages of ground-based radiometers are their ability to produce continuous measurements in time, and their ability to measure cloud liquid. Continuous upper-air temperature, humidity and cloud liquid measurements can be used to improve nowcasting and short-term precipitation forecasting. These continuous measurements can be also used to detect the development or time of arrival of well-defined temperature changes (for studies of gas emissions, air pollution, urban heat islands, severe weather forecasting and warnings) (Kadyrov, Shur and Viazankin 2003).

Profiling radiometer reliability and accuracy have been widely demonstrated during long-term arctic, mid-latitude and tropical operations (Güldner and Spänkuch, 2001; Liljegren and others 2005). The result of the 13-month operation of the Radiometrics MP3000 (Gaffard and Hewison, 2003) shows that the root mean square value of the difference between the temperature observed by the radiosonde and that retrieved by the microwave radiometer ranges from 0.5 K (near the surface) to 1.8 K (at a height of 5 km). Güldner and Spänkuch (2001), who operated the Radiometrics TP/WVP-3000 for 18 months and compared retrievals with four radiosonde soundings daily, also shows a similar root mean square value from 0.6 K (near the surface)

to 1.6 K (at a height of 7 km in summer and 4 km in winter). The root mean square value of water vapour profile is not more than 1 gm^{-3} in all altitudes (Gaffard and Hewison, 2003; Güldner and Spänkuch, 2001).

Terrestrial profiling radiometers demonstrate significant economic and practical advantage whenever lower tropospheric temperature, humidity and cloud liquid measurements with high temporal resolution are required, and where moderate vertical resolution is acceptable. Commercial profiling radiometer prices have dropped significantly over the past several years, and are now less than the typical annual cost of labour and materials for twice daily radiosonde soundings.

5.2.5 Laser radars (lidars)

Electromagnetic energy at optical and near-optical wavelengths (from ultraviolet through visible to infrared) generated by lasers is scattered by atmospheric gas molecules and suspended particles. Such scattering is sufficient to permit the application of the radar principle to make observations of the atmosphere by means of lidar (light detection and ranging). Optical scattering can generally be divided into inelastic and elastic. When the wavelength of the laser energy, scattered by atmospheric constituents, differs in wavelength from the incident laser wavelength, the process is called inelastic scattering. The most widely used inelastic scattering process used in experimental atmospheric lidar systems is Raman scattering, which results from an exchange of energy between incident photons and the molecular rotational and vibrational states of the scattering molecules. In elastic scattering processes, the incident and the scattered wavelengths are the same. This scattering may be Rayleigh or Mie scattering and depends on the species and size of particles with respect to the incident laser wavelength (see Part II, Chapter 9). Both of these major scattering processes can occur simultaneously in the atmosphere.

For further reference see Hinkley (1976), WMO (1982), Thomas (1991) and Syed Ismael and Browell (1994).

The majority of lidars are operated in a monostatic mode, whereby the receiver is collocated with the laser transmitter. A typical lidar system uses a pulsed laser to transmit pulses of coherent light into the atmosphere. The average power of the laser used varies from a few milliwatts to tens of watts. An optical telescope mounted adjacent to the laser is used to capture the

backscattered energy. The light collected by the telescope is focused onto a photomultiplier or photoconductive diode. The received information is normally made available on a cathode ray display for real-time monitoring and is transferred to a computer for more detailed analysis.

The strength of the return signal is dependent both on the amount of scattering from the target and on the two-way attenuation between the lidar and the target — this attenuation depends on the proportion of the beam's energy scattered from its path and on the absorption by atmospheric gases. The scattering and absorption processes are exploited in different lidars to provide a variety of measurements.

Lidars based on elastic scattering (called Rayleigh or Mie lidars, or simply lidars), are mostly used for studies on clouds and particulate matter. The measurement of cloud-base height by a lidar is very straightforward; the rapid increase in the signal that marks the backscattered return from the cloud base can be readily distinguished; the height of the cloud base is determined by measuring the time taken for a laser pulse to travel from the transmitter to the cloud base and back to the receiver (see Part I, Chapter 15).

Lidars are also used to detect the suspended particles present in relatively clear air and to map certain structural features such as thermal stability and the height of inversions. Natural atmospheric particulate levels are sufficiently high in the lower atmosphere to allow lidars to measure air velocities continuously in the absence of precipitation, like weather radars. They can also be used to map and measure the concentration of man-made particulates, such as those originating from industrial stacks.

Lidar observations have made very extensive and the best-documented contributions to the study of stratospheric aerosol particulate concentration, which is strongly influenced by major volcanic eruptions and is an important factor in the global radiation balance.

It is much more difficult to obtain quantitative data on clouds, because of the variations in shape and distribution of droplets, water content, discrimination between water, ice and mixed phases, and the properties of suspended particles and aerosols. Indeed, such measurements require complex multiparameter research systems making several measurements simultaneously, using hypotheses concerning the optical properties of

the medium, and complex mathematical data-reduction methods.

Differential absorption lidar (DIALs) work on the principle that the absorption coefficient of atmospheric gases varies greatly with wavelength. A DIAL system normally uses a laser that can be tuned between two closely-spaced frequencies, one which is strongly absorbed by a particular gas, and one which is not. The differences in the measurements as a function of range can be used to estimate the concentration of the gas under study. This is a most promising remote-sensing technique for the measurement of atmospheric composition and has been successfully used to measure concentrations of water, sulphur dioxide, nitrogen dioxide and, in particular, ozone.

The application of Raman scattering is of particular interest because the scattered radiation is frequency shifted by an amount which depends on the molecular species (Stokes lines). The strength of the backscattered signal is related to the species concentration. Raman lidars do not require a particular wavelength or tuned laser; laser wavelengths can be selected in a spectral region free from atmospheric absorption. By measuring the Raman spectrum, spatially resolved measurements can be taken of preselected atmospheric constituents, which have been used to obtain tropospheric profiles of water vapour, molecular nitrogen and oxygen, and minor atmospheric constituents. The main disadvantages are the lack of sensitivity over long ranges owing to the small scattering cross-sections and the requirement for high power lasers, which can lead to eye-safety problems in practical applications.

Lidar systems have provided a great deal of useful information for research studies but have had limited impact as operational tools. This is because they are relatively expensive and require very skilled staff in order to be developed, set up and operated. In addition, certain lidars are able to operate only under restricted conditions, such as in darkness or in the absence of precipitation.

5.3 IN SITU MEASUREMENTS

5.3.1 Balloon tracking

Balloon tracking is frequently used to obtain boundary layer winds and is usually performed by optical theodolites or a tracking radar. Part I, Chapter 13, gives a more general account of windfinding.

When making lower tropospheric soundings, it is desirable to use a slow rate of balloon ascent in order to give high vertical resolution. The reduced rate of ascent may be achieved either by means of a brake parachute or by a reduced free lift.

For radar tracking, a small radar reflector is suspended below the balloon. For lower tropospheric soundings, the radar should be able to provide data at ranges as short as 100 m, and ideally the launch point must be farther away in a down-wind direction than this minimum range.

A basic wind measurement can be taken using a single optical theodolite, but, in order to obtain reasonably accurate winds, a two-theodolite system is required. The baseline between the theodolites should exceed 1 km. In order to facilitate the sounding procedure and to ensure height accuracy, the theodolites should be equipped with computer interfaces so that the data can be logged and the necessary calculations performed in a timely manner. Under good conditions, wind profiles can be obtained up to an altitude of 3 000 m. However, the technique fails in adverse conditions such as precipitation, low cloud or fog.

It is, of course, possible to obtain additional wind data in the lower atmosphere using conventional radiosondes by taking more frequent tracking measurements in the first few minutes of a normal full sounding, for example, between 2 and 10 per minute.

5.3.2 Boundary layer radiosondes

Conventional radiosonde systems are described in detail in Part I, Chapter 12. Special radiosondes have been designed specifically to make detailed observations of the boundary layer and lower troposphere. They differ from conventional radiosondes in that the sensors have greater sensitivity and faster response rates. Such radiosondes are used to measure temperature, humidity and wind profiles in the layer from the surface to elevations of typically 3 to 5 km.

The vertical ascent rate of these radiosondes is usually arranged to be between 150 and 200 m min⁻¹, which is rather slower than conventional radiosondes. The slower rate of ascent allows more detailed vertical profiles to be produced. The rate of ascent is normally determined by selecting an appropriately sized balloon, but may be modified by the use of a trailing brake parachute.

Because these instruments are required only to reach a limited height, they can normally be carried by a pilot balloon. In other respects, the sounding procedures and data processing are similar to those employed by standard radiosondes.

For soundings to an altitude of no more than 2 000 m, the pressure sensor is sometimes dispensed with, which results in a simpler and less expensive radiosonde. Even simpler systems are available which measure temperature only.

The basic requirements for boundary layer radiosondes are as follows:

<i>Variable</i>	<i>Operating range</i>	<i>Resolution</i>
Pressure	1 050 to 500 hPa	±0.5 hPa
Temperature	+40° to -40°C	±0.1 K
Humidity	100 to 20 (or 10)%	±2%
Wind speed	0.5 to 60 m s ⁻¹	±0.5 m s ⁻¹
Wind direction	0° to 360°	±5°

Measurements are typically taken at least every 30 s to give a vertical resolution of 50 to 100 m.

5.3.3 Instrumented towers and masts

Special instrumented towers and masts are used for many purposes, especially for the estimation of the diffusion of atmospheric pollution. A discussion is provided by Panofsky (1973).

For some purposes, the height of the tower must be up to 100 m, and for air-pollution monitoring and control projects it should exceed the height of the important sources of pollution by at least 50 m.

Measurements of temperature, humidity and wind should be made at several (at least two or three) levels, the lowest of which should be at the level of standard meteorological screen, close to the tower or mast. The number of measuring levels depends upon both the task and the height of the tower or mast. The use of just two levels provides no information on the shape of the vertical profile of meteorological variables and is, thus, very limiting. The number of measuring levels is usually greater for research projects than for routine use.

Usually, the data are processed and presented automatically together with differences between the levels that are provided to characterize the meteorological conditions. If the data are to be used

directly by non-meteorological staff – such as those concerned with keeping concentrations of air pollutants within safe limits – they are often processed further by computer to provide derived data which are easily applied to the task in hand.

The sensors most commonly used for measurements on towers or masts are as follows:

- (a) Temperature: electrical resistance or thermocouple thermometers in screens, with or without aspiration;
- (b) Humidity: psychrometers, electrochemical or electromechanical sensors in screens;
- (c) Wind: cup and vane, propeller, sonic or hot-wire devices.

All sensors should have linear or linearized characteristics and their time-constants should be small enough to ensure that the data gathered will adequately reflect local changes in the meteorological variables.

It is important that the structure of the tower or mast should not affect the sensors and their measurements appreciably. For open structures, booms – whether stationary or retractable – should be at least 2 m long, and preferably long enough to keep the sensors at least 10 tower diameters removed from the tower or mast. For solid structures, or where the required booms would not be practicable, a double system is required at each level, with booms on opposite sides of the tower or mast extending for at least three times the structure diameter. Measurements at a given time are then taken from the sensors exposed to the undisturbed wind.

Sometimes, in special situations, towers can be used to gather meteorological profile data without the direct mounting of fixed sensors; rather, a simplified method of sounding is used. A pulley is fastened at the highest possible point and a closed loop of rope extending to ground level is used to carry a radiosonde up and down the levels required by means of a hand- or motor-operated winch. The radiosonde, which is modified to include wind sensors, transmits its data to an appropriate receiving system at ground level. Much more vertical detail is possible than that provided by a boom installation, and the altitudes of significant features can be determined. However, sustained observation is possible at only a single level.

For an accurate definition of the extent of pollution dispersion in certain weather conditions, the tower height may be too limited. In such circumstances, unless a radiosonde station is within about 50 km, a special radiosonde is provided at the site of the

tower or mast for making local soundings up to an altitude of about 3 000 m. In addition to their main purpose, the data obtained can be treated as complementary to those of the basic aerological network, and can also be used in more detailed investigations of local weather phenomena.

Tower measuring equipment requires periodical checking by highly qualified instrument maintenance staff who should pay special attention to the state and performance of sensors and recorders and the connecting cables, sockets and plugs exposed to outdoor weather conditions.

5.3.4 Instrumented tethered balloons

Typical applications of instrumented tethered balloons include the measurement of temperature, humidity and wind profiles (and their short-period changes) from the surface to an altitude of about 1 500 m, and longer-period investigation of the meteorological conditions at one or more selected levels. The sensors are suspended in one or more packages beneath the balloon, or clamped to the tethering cable. The sensor's response is normally telemetered to the ground either by radio, or by conductors incorporated into the tethering cable. The techniques are discussed by Thompson (1980).

Tethered-balloon systems tend to use either large (~600 m³) or small (~10 to 100 m³) balloons. The small balloons are normally used to obtain profiles, and the larger ones to obtain measurements at multiple levels. Tethered balloons should be designed for low drag and to ride steadily. They are usually inflated with helium. Larger balloons should be able to carry a load of up to 50 kg (in addition to the tethering cable) to an altitude of 1 500 m. The balloon should be capable of operation at wind speeds of up to 5 m s⁻¹ at the surface and 15 m s⁻¹ at altitudes within the operational range. The tethering cable of a large balloon should be able to withstand a force of 2 000 to 3 000 kg to avoid a breakaway (200 to 300 kg for smaller balloons).

Tethered-balloon flying is subject to national rules concerning aviation safety. For this reason and for the convenience of the operating staff, the use of balloons which have distinct colours and night-warning lights is highly recommended. An automatic device for the rapid deflation of the balloon is mandatory, while a metallized radar target suspended below the balloon is optional.

The main factors limiting tethered-balloon operation are strong wind speed aloft, turbulence near the surface and lightning risk.

The winch used to control the balloon may be operated electrically or by hand. At least two speeds (e.g. 1 and 2 m s⁻¹) should be provided for the cable run. In addition, the winch should be equipped with a hand-brake, a cable-length counter and a tension gauge. The winch should be electrically earthed, whether electrically operated or not, as protection against atmospheric discharges.

The use of conductors to convey the sensor signals back to the ground is undesirable for a number of reasons. In general, it is preferable to use special radiosondes. Such radiosondes will have better resolution than those normally employed for free flights. The temperature and humidity sensors must have a horizontal shield to provide protection against solar radiation and rainfall, while allowing for adequate ventilation. Extra sensors are needed for wind speed and direction.

The basic requirements are the following:

<i>Variable</i>	<i>Operating range</i>	<i>Resolution</i>
Pressure	1 050 to 850 hPa	±0.5 hPa
Temperature	+40° to -20°C	±0.1 K
Humidity	100 to 20 (or 10)%	±2%
Wind speed	0.5 to 15 m s ⁻¹	±0.5 m s ⁻¹
Wind direction	0° to 360°	±1°

For telemetry, one of the standard radiosonde frequencies may be used; the 400 MHz allocation is a frequent choice. The maximum weight, including the battery, should be within the load capability of the balloon; a limit of 5 kg is reasonable. The radiosonde should be suspended at least three balloon diameters below the balloon in a stable condition so that adequate shielding and ventilation are maintained.

A major problem encountered in the measurement of turbulent, rather than mean, quantities is the effect of cable vibration and balloon motion on the measurements. Special techniques have to be used for such measurements.

The ground-based equipment must include a receiver and recorder. The data are usually processed with the aid of a small computer.

Soundings can be performed during the ascent and descent of the balloon, either continuously or with pauses at selected levels. For the lower levels, height can be estimated from the length of the cable paid out, but at higher levels this method is no more than an approximation and an alternative is necessary. This takes the form of a calculation by means of the hydrostatic equation, using the observed distribution of pressure, temperature and humidity. Thus, the increment in geopotential metres from level *n* to level *n*+1 is given by:

$$29.27 T_v \ln (p_n / p_{n+1})$$

where *T_v* is the mean of the virtual temperatures at levels *n* and *n* + 1; and *p_n* and *p_n* + 1 are the two associated pressures. If conversion from geopotential to geometric height is required, this is readily done by using the Smithsonian meteorological tables; however, this is unlikely to be necessary. The height of the station barometer is taken as the datum for these calculations.

If the meteorological variables are observed using the level-by-level method, a few measuring cycles should be taken at each level, with the time required for stabilization being 2 to 3 min. In this way, the whole sounding sequence could take from a half to one whole hour. As for all radiosondes, a baseline check in a control screen should be made just before use, to establish the differences with a barometer and an aspirated psychrometer. A similar check should also be made just after the sounding is completed. Again, as for regular radiosonde ascents, the station-level data should be obtained not from the radiosonde data, but from conventional instruments in a standard station screen.

For the sounding data, pressure, temperature and humidity should be averaged at each level. For wind speed, the average should be calculated for a period of 100 or 120 s. If wind direction is not measured directly, it can be roughly estimated from the orientation of the balloon's longitudinal axis with respect to the north. The uncertainty of this method is ±30°.

It should be stressed that operators must advise air traffic authorities of their plans and obtain permission for each sounding or series of soundings using tethered balloons.

REFERENCES AND FURTHER READING

- Adachi, A., T. Kobayashi, K.S. Gage, D.A. Carter, L.M. Hartten, W.L. Clark and M. Fukuda, 2005: Evaluation of three-beam and four-beam profiler wind measurement techniques using a five-beam wind profiler and collocated meteorological tower. *Journal of Atmospheric and Oceanic Technology*, 22, pp. 1167–1180.
- Angevine, W.M., W.L. Ecklund, D.A. Carter, K.S. Gage and K.P. Moran, 1994: Improved radio acoustic sounding techniques. *Journal of Atmospheric and Oceanic Technology*, Volume 11, Issue 1, pp. 42–49.
- Brown, E.H. and F.F. Hall, 1978: Advances in atmospheric acoustics. *Reviews of Geophysics and Space Physics*, Volume 16, pp. 47–109.
- Derr, V.E., 1972: *Remote Sensing of the Troposphere*. United Nations National Oceanic and Atmospheric Administration, WPL, Boulder, Colorado.
- Gaffard, C. and T. Hewison, 2003: Radiometrics MP3000 microwave radiometer trial report. *Technical Report–TR26*, Met Office, Workingham, Berkshire, UK, 27 pp.
- Gaynor, J.E., C.B. Baker and J.C. Kaimal, 1990: *The international sodar intercomparison experiment. Proceedings of the Fifth International Symposium on Acoustic Remote Sensing*. McGraw-Hill, New York, pp. 67–74.
- Gossard, E.E. and R.G. Strauch, 1983: *Radar Observations of Clear Air and Clouds*. Elsevier, Scientific Publishing Co., Amsterdam.
- Güldner, J. and D. Spänkuch, 2001: Remote sensing of the thermodynamic state of the atmospheric boundary layer by ground-based microwave radiometry, *Journal of Atmospheric and Oceanic Technology*, 18, 925–933.
- Hinkley, E.D., 1976: *Laser Monitoring of the Atmosphere: Topics in Applied Physics*. Volume 14, Springer Verlag, New York.
- Hogg, D.C., M.T. Decker, F.O. Guiraud, K.B. Earnshaw, D.A. Merritt, K.P. Moran, W.B. Sweezy, R.G. Strauch, E.R. Westwater and C.G. Little, 1983: An automatic profiler of the temperature, wind and humidity in the troposphere. *Journal of Climate and Applied Meteorology*, Volume 22, pp. 807–831.
- Kadygrov, E.N. and D.R. Pick, 1998: The potential for temperature retrieval from an angular-scanning single-channel microwave radiometer and some comparisons with in situ observations. *Meteorological Applications*, Volume 5, pp. 393–404.
- Kadygrov, E.N., G.N. Shur and A.S. Viazankin, 2003: Investigation of atmospheric boundary layer temperature, turbulence, and wind parameters on the basis of passive microwave remote sensing, *Radio Science*, Volume 38, No. 3, pp. 13.1–13.12.
- Lataitis, R.J., 1992a: Signal power for radio acoustic sounding of temperature: The effects of horizontal winds, turbulence and vertical temperature gradients. *Radio Science*, Volume 27, pp. 369–385.
- Lataitis, R.J., 1992b: *Theory and Application of a Radio-acoustic Sounding System*. NOAA Technical Memorandum ERL WPL-230.
- Liljegren, J.C., S.A. Boukabara, K. Cady-Pereira and S.A. Clough, 2005: The Effect of the half-width of the 22-GHz water vapor line on retrievals of temperature and water vapor profiles with a 12-channel radiometer, *IEEE Transactions on Geoscience Remote Sensing*, Volume 43, Issue 5, pp. 1102–1108.
- Martner, B.E., D.B. Wuertz, B.B. Stankov, R.G. Strauch, E.R. Westwater, K.S. Gage, W.L. Ecklund, C.L. Martin and W.F. Dabberdt, 1993: An evaluation of wind profiler, RASS, and microwave radiometer performance. *Bulletin of the American Meteorological Society*, Volume 74, Issue 4, pp. 599–613.
- May, P.T., R.G. Strauch, K.P. Moran and W.L. Ecklund, 1990: Temperature sounding by RASS, with wind profiler radars: A preliminary study. *IEEE Transactions on Geoscience and Remote Sensing*, Volume 28, Issue 1, pp. 19–28.
- Neff, W.D. and R.L. Coulter, 1986: Acoustic remote sounding. In Lenschow, D.H. (ed.): *Probing the Atmospheric Boundary Layer*, American Meteorological Society, pp. 201–236.
- Panofsky, H.A., 1973: Tower micrometeorology. In Haugen, D.A. (ed.): *Workshop on Micrometeorology*, Chapter 4, American Meteorological Society.
- Singal, S.P., 1990: Current status of air quality related boundary layer meteorological studies using sodar. *Proceedings of the Fifth International Symposium on Acoustic Remote Sensing*, McGraw-Hill, New York, pp. 453–476.
- Solheim, F., J.R. Godwin, E.R. Westwater, Y. Han, S.J. Keihm, K. Marsh, R. Ware, 1998: Radiometric profiling of temperature, water vapor, and cloud

- liquid water using various inversion methods, *Radio Science*, Volume 33, pp. 393–404.
- Strauch, R.G., and others, 1990: Preliminary evaluation of the first NOAA demonstration network wind profiler. *Journal of Atmospheric and Oceanic Technology*, Volume 7, Issue 6, pp. 909–918.
- Syed Ismael and E.V. Browell, 1994: Recent Lidar technology developments and their influence on measurements of tropospheric water vapor. *Journal of Atmospheric and Oceanic Technology*, Volume 11, Issue 1, pp. 76–84.
- Thomas, L., 1991: Lidar probing of the atmosphere. *Indian Journal of Radio and Space Physics*, Volume 20, pp. 368–380.
- Thompson, N., 1980: Tethered balloons. In: *Air-sea Interaction: Instruments and Methods* (F. Dobson, L. Hasse and R. Davis, eds) Chapter 31, Plenum Press, New York.
- Ware, R., R. Carpenter, J. Güldner, J. Liljegren, T. Nehrkorn, F. Solheim and F. Vandenberghe, 2003: A multi-channel radiometric profiler of temperature, humidity and cloud liquid, *Radio Science*, Volume 38, pp. 8079–8032.
- Weber, B.L. and D.B. Wuertz, 1990: Comparison of rawinsonde and wind profiler radar measurements. *Journal of Atmospheric and Oceanic Technology*, Volume 7, Issue 1, pp. 157–174.
- Westwater, E.R., J. B. Snider and M.J. Falls, 1990: Ground-based radiometric observations of atmospheric emission and attenuation at 20.6, 31.65, and 90.0 GHz: A comparison of measurements and theory. *IEEE Transactions on Antennas and Propagation*, Volume 38, Issue 10, pp. 1569–1580.
- Westwater, E., S. Crewell, C. Mätzler and D. Cimini, 2005: Principles of Surface-based Microwave and Millimeter Wave Radiometric Remote Sensing of the Troposphere. *Quaderni Della Società Italiana di Elettromagnetismo*, Volume. 1, No. 3.
- World Meteorological Organization, 1980: *Lower Tropospheric Data Compatibility: Low-level Intercomparison Experiment (Boulder, United States, 1979)*. Instruments and Observing Methods Report No. 3, Geneva.
- World Meteorological Organization, 1982: *Indirect Sensing: Meteorological Observations by Laser Indirect Sensing Techniques* (A.O. Van Gysegem). Instruments and Observing Methods Report No. 12, Geneva.
- World Meteorological Organization, 1994: Comparison of windprofiler and rawinsonde measurements (J. Neisser, V. Görsdorf and H. Steinhagen). *Papers Presented at the WMO Technical Conference on Instruments and Methods of Observation (TECO-94)*, Instruments and Observing Methods Report No. 57, WMO/TD-No. 588, Geneva.
- World Meteorological Organization, 2006: Operational Aspects of Different Ground-Based Remote Sensing Observing Techniques for Vertical Profiling of Temperature, Wind, Humidity and Cloud Structure (E.N. Kadygrov). Instruments and Observing Methods Report No. 89, WMO/TD No. 1309.
-

ROCKET MEASUREMENTS IN THE STRATOSPHERE AND MESOSPHERE¹

6.1 GENERAL

This chapter is concerned mainly with wind and temperature measurements taken with small meteorological rockets. The wind data are obtained from the radar tracking of the drift of a falling sensor package which, either alone or with temperature sensors, makes in situ observations. The temperature observations are transmitted to a ground station. The techniques described here are applicable to the stratosphere and mesosphere, generally, between 20 km and 90 km.

Typically, meteorological rocketsonde measurement systems consist of the following:

- (a) An instrument ejected from a rocket near its maximum height (apogee) which then descends on a decelerator device, similar to a parachute, and transmits measurements of temperature to the ground, while high-precision radar tracking of the decelerator provides wind information;
- (b) A free-falling inflatable balloon, called a "falling sphere" tracked by a high-precision radar to provide atmospheric density and wind data; or
- (c) A high-precision radar track of clouds of foil dipoles, called chaff, which are ejected near the rocket's apogee enabling only winds to be determined.

The elements to be measured are very diverse. The most important elements are wind and temperature, but others include solar radiation, electrical variables, turbulence and chemical constituents. Among the latter are ozone, water vapour, oxides of nitrogen, atomic oxygen and hydrogen, chlorine and the hydroxyl radical.

A central body, the World Data Center-A (WDC-A), undertakes collection and the various exchanges of the data. By means of these data, systematic studies are undertaken, for example, studies of the general circulation, solar/high-atmosphere relationships, correlation between geomagnetism and meteorological parameters, composition of standard atmospheres, checking of satellite data, and stratospheric warmings. For each launching,

a report, known as a ROCOB, is compiled and disseminated by means of the Global Telecommunication System.

The measurement techniques are in a state of constant evolution as regards both the methods used and the constituents measured. The measurements are mostly carried out non-routinely at a single location. Only the thermodynamic and ozone measurements have been widespread and frequent, with use being made of semi-operational methods. Several other meteorological measurement methods, not to be discussed further since these go beyond the realm of small meteorological rocketsonde techniques, are:

- (a) Chemical tracers, for example, sodium or potassium, that provide information on wind, turbulence and temperature: special tracking cameras are required with which to triangulate the chemical trail;
- (b) Pitot probes;
- (c) Active accelerometers;
- (d) Acoustic grenades that, upon exploding, emit sound waves to a system of highly sensitive microphones on the ground and provide wind and temperature data.

A comprehensive survey of earlier contributions to meteorological rocket soundings is given in Bollermann (1970).

6.2 WIND MEASUREMENT

6.2.1 Method

After the rocket reaches its apogee, an expulsion device (which is usually pyrotechnical) separates the payload from the propulsion system, or rocket motor. Wind and temperature sensors are deployed along with a telemetry unit used to transmit the temperature information to the ground. During the ensuing descent, the motion of the sensing system is tracked with a radar. Thus, the trajectory of the falling target is determined, whether it is a parachute, a temperature sensor/parachute system, or an inflatable sphere. Corrections to the trajectory are usually made to insure correct wind data. Chaff is another wind-sensing system that falls very slowly and follows the wind quite well; thus, corrections

¹ The technical content of this chapter has not been revised since the previous edition of the Guide.

to its motion are not usually required. Chaff, however, is no longer used routinely.

6.2.2 **Wind sensors**

The quality of the wind measurements depends on how well the wind-sensing system responds to atmospheric movements. The following factors influence this response:

- (a) Inertia, accelerations, and fall velocity of the wind-sensing system;
- (b) Dynamic stability and oscillation of the decelerator system;
- (c) The sensor shape as it affects the drag coefficient along the three axes.

6.2.3 **Tracking method**

After the payload has been ejected, its trajectory is usually tracked by a radar using the echo from the metal-coated sensor. This enables wind variations with height to be determined and the components of the wind velocity to be obtained. The required accuracy of azimuth and elevation tracking angles is of the order of 2×10^{-4} rad (approximately 0.011°), and of the order of 10 m for slant range; this is achieved by the use of high-performance radars or transponder transmitters. The raw data are sampled at a rate of 10 or more points per second and are then smoothed by the method of least squares in a manner that varies with target height and the fall speed.

6.2.4 **Corrections and computations of wind**

The horizontal velocity vector V_p of the sensor, relative to the observer, is often mistaken as the horizontal velocity V of the true wind. However, high ejection speeds, fluctuations in the drag coefficient and the force of inertia of the sensor lead to differences between these two vectors at heights above 50 km and make it necessary to apply corrections, the magnitude of which increase rapidly with increasing fall speed or height.

A technique for correction, developed by Eddy and others (1965) and Ballard (1966), enables the horizontal wind components to be obtained at all levels from the tracking data, if the following assumptions are made:

- (a) The sensor is subjected solely to the forces of gravity and of air resistance;
- (b) The force of gravity remains constant;
- (c) The magnitude (D) of the resistance to motion is proportional to the square of the speed of the sensor relative to the air.

From Newton's second law, we may write the following as a first approximation:

$$m \frac{dV_s}{dt} = mg + D \tag{6.1}$$

$$|D| = \rho \cdot s \cdot \frac{C_d}{2} \cdot (V - V_s)^2 \tag{6.2}$$

where C_d is the drag coefficient; g is the gravity constant; m is the mass of the descending payload (i.e. wind sensor and/or transmitter); S is the cross-sectional area of the sensor; t is time; V is the wind velocity; V_s is the velocity of the wind sensor; and ρ is the air density.

An expression is obtained for the corrections to be applied to the horizontal components of the velocity of the wind sensor, Δu and Δv , to obtain the components of the vector wind. This expression is valid if the wind component is much less than the speed of the sensor, and, if it is assumed that $S \cdot C_d$ is isotropic, namely independent of the direction of movement, the following is obtained:

$$\Delta u = -w_s \frac{\dot{u}_s}{|\dot{w}_s - g|}; \Delta v = -w_s \frac{\dot{v}_s}{|\dot{w}_s - g|} \tag{6.3}$$

where \dot{u}_s is the west-east acceleration of the wind sensor; \dot{v}_s is the south-north acceleration of the wind sensor; w_s is the vertical speed of the wind sensor; and \dot{w}_s is the vertical acceleration of the wind sensor.

The corrections are considered to be significant at altitudes above the level at which the sensor becomes sensitive to the wind, namely when the resistance to motion becomes sufficiently large. This altitude is usually defined as the level at which the vertical acceleration of the sensor becomes less than 5 m s^{-2} (on average 5 km below the apogee).

The value of the terms Δu and Δv may reach 100 m s^{-1} at the highest levels and then decrease very rapidly to become less than 1 m s^{-1} below 50 km. The performance of the best radars used makes it possible to achieve an accuracy of 3 to 5 per cent for winds at levels above 70 km and of the order of 2 per cent at lower levels. This method of correction cannot take into account abnormalities in the behaviour of the wind sensor. In such cases, the data must be considered as doubtful.

6.3 TEMPERATURE MEASUREMENT BY IMMERSION THERMOMETRY

6.3.1 General

In order to measure high-altitude temperatures by means of small rocketsondes, two methods are employed. The first uses immersion thermometry, namely, a sensor/telemetering unit that is ejected from the rocket at the apogee and then descends by parachute, which measures wind and temperature data during the payload's descent through the atmosphere. The second uses a passive inflatable falling sphere measuring primarily the density and wind profiles. Temperatures are derived from the density profile (see section 6.4). Both types of payloads must be radar tracked to obtain position information. This section discusses the first technique.

6.3.2 Immersion thermometry

The extreme difficulty of in situ measurements at high altitudes makes it a vital requirement that an instrument design be selected that minimizes the need for corrections. In this way, corrections may be either neglected completely or computed by using standard parameters up to the highest levels. Corrections are important at the highest levels and were developed for use by Henry (1967) and quantified by Krumins and Lyons (1972). Corrections are discussed further in section 6.3.3.

In these measurements, exchanges of energy between the sensing element and the surroundings rapidly become very small at great heights due to the very low air density, while the high speeds of descent result in rapid variation of the temperature measured. At a height of 70 km, these speeds vary from 250 to 500 m s⁻¹, depending on the system used. Unfortunately, the effect of the high fall speed and the thermistor thermal inertia expressed by its time-constant of response, taken together, acts to dampen the amplitude of the temperature variation.

It is therefore necessary to select sensors with a very low thermal capacity on mountings reducing the effects of heat conduction to a minimum. The sensors should be located as far away as possible from those regions aerodynamically disturbed by the body of the payload package and, in addition, must also be insensitive to oscillations of the sensor/parachute package which will cause variations in the effects of the incident air flux and direct solar radiation.

Three different types of sensors, based on a change in electrical resistance with temperature, are used:

- (a) *Thermistor*: A bead thermistor, approximately 0.25 mm in diameter, is supported by two fine wires soldered to supports formed of metal-coated mylar film which are very thin compared to their area, in order to facilitate dissipation of the heat due to conduction from the main body of the payload. The thermistor's electrical resistance increases exponentially with decreasing temperature. At a height of 70 km, for a speed of descent of 250 m s⁻¹, the time-constant of response is of the order of 15 to 20 s and the magnitude of the corrections may be approximately 40 to 50 K for some types of instruments (Krumins and Lyons, 1972), and more for other types (Kokin and Rusina, 1976; Schmidlin and others, 1980);
- (b) *Fine wire*: The sensor comprises a fine wire, 5 to 20 μ in diameter, made of tungsten, tungsten-rhenium alloy, or nickel-iron alloy. The sensor is sometimes covered with a gold skin a few hundredths of a micron thin, to protect it from oxidization (a gold-palladium alloy makes it possible to decrease the influence of solar radiation). In order to reduce the effect of heat from conduction, two techniques are used: either the fine wire is short (a few centimetres), has a small diameter, and is soldered to two constantan (copper-nickel alloy) wires a few tenths of a micron in diameter; or the fine wire is very much longer, has a larger diameter and is soldered to terminals which have an appreciable thermal capacity, the wire being held in place at several points by very small supports. The variation of resistance with temperature is practically linear, and is of the order of 1 ohm per 5 K in the first case, or 1 ohm per 10 K in the second. At a height of 70 km, for a speed of descent of 250 m s⁻¹, the time-constant of a short fine wire 5 μ in diameter is of the order of 0.5 s and the magnitude of the correction is approximately 35 K, while these values reach 2 to 3 s and approximately 40 K in the case of sensors with a long fine wire of 20 μ in diameter;
- (c) *Layered sensors*: This type of sensor, which is less fragile than the preceding ones, has a larger thermal inertia, which limits its use to heights below 60 km. On a thin nylon substrate, an electrical circuit, consisting predominantly of nickel, is vacuum deposited by evaporation, the two faces of the sensor then being covered with a film of anodized aluminum with a thickness of 5 μ to minimize the effects of solar radiation.

The variation of resistance of the circuit with temperature is practically linear and is of the order of 1 ohm per 5 K and the time-constant is of the order of a few seconds at 60 km.

6.3.3 General equation for temperature sensor corrections

Knowing the temperature of the sensor T_p , the temperature of the ambient air T_∞ can be calculated. In a general way and for each type of sensor, the first law of thermodynamics, namely the law of conservation of energy, requires that the variations in the internal energy of the system be balanced by the sum of the amounts of energy absorbed from the environment, as well as the amount dissipated away.

In a general way, the following may be written:

$$mC \frac{dT_t}{dt} = A \cdot h \left[T_\infty + \frac{rV^2}{2C_p} - T_t \right] + \alpha_s \cdot J \cdot A_s + \alpha_s \cdot J \cdot Alb \cdot A_a + \sigma \alpha_1 \sum_1^i A_i \cdot T_i^4 - A \cdot \varepsilon \cdot T_t^4 + W_t + K_c \quad (6.4)$$

where A is the area of the sensor; A_a is the effective area of the sensor with respect to radiation reflected by the Earth's surface; A_s is the effective area of the sensor with respect to direct solar radiation; A_i is the effective area of the sensor exposed to long-wave radiation from the Earth, the atmosphere and the main body of the sonde; Alb is the albedo of the Earth and atmosphere; C is the specific heat of the sensor; C_p is the specific heat of air at constant pressure; h is the convective heat transfer coefficient (function of density and speed of air relative to the sensor, and of air temperature); J is the solar constant; K_c is the heat from conduction; m is the mass of the sensor; r is the recovery factor; T_i is the equivalent black-body temperature of sources emitting long-wave radiation towards the sensor; T_t is the temperature of the sensor; T_∞ is the temperature of undisturbed air; V is the speed of air relative to the sensor; W_t is the Joule-effect heating due to the measuring current and absorption of electromagnetic radiation by the transmitting antenna; α_s is the absorption coefficient of the sensor for solar radiation; α_1 is the absorption coefficient for long-wave radiation; ε is the emissivity of the sensor; and σ is the Stefan-Boltzmann constant.

The first term on the right hand side of equation 6.4 represents the quantity of energy exchanged by convection, including kinetic heating, which is severe above 50 km because of the very fast fall

speed encountered. The second and third terms represent solar radiation and radiation reflected from the Earth and/or cloud surfaces, respectively. The fourth term represents long-wave radiation reaching the sensor from the environment and from the sonde. The fifth term represents the energy emitted by the sensor due to its emissivity. The sixth term, W_t , is that part of the energy absorbed by Joule-effect heating, and the seventh term characterizes the conduction between the sensor and its mounting. The last two terms are specific for each system and must be applied to supports or leads of the sensor in order to calculate the correction for conduction. For details, see Krumins and Lyons (1972), Bulanova and others (1967) and Yata (1970).

The necessary coefficients for calculating the other terms are determined experimentally and by mathematic formulation, depending on the parameters available during the launch. In particular, the coefficient h , which is a function of density and temperature, is calculated from standard values and then more accurately by successive iterative processes by applying the general equations for calculating temperature and density (equations 6.4, 6.8, 6.9, 6.10).

6.3.4 Telemetry

Meteorological telemetry units enable the variations in the temperature of the sensor to be transmitted. The resistance of the sensor is usually converted to a frequency which directly modulates the transmitter in the case of multiple channel measuring systems, or uses a commutator to switch up sequentially to three or four channels, or subcarriers in the case of a two- or three-channel measuring system.

Rocket-borne telemetry systems operate under very severe conditions. During the powered phase of the rocket flight, these systems are subjected to a very wide spectrum of large vibrations and to accelerations (g -forces) which may reach some tens of g for a period of several seconds. Low-air density at the beginning of the descent restricts heat dissipation. Later in the descent, the measuring package encounters denser air at temperatures which can be as low as 190 K, and which may cool the electronics.

In most cases, reference resistances or voltages are selected by means of a sequential switch in order that errors introduced by the measuring system as a whole and, in particular, those due to possible changes in performance of the telemetry devices as a result of environmental stress during flight, can be detected and corrected. Particular care is taken in designing and positioning the antenna relative to

the sensors in order to avoid heating of the sensors due to the Joule effect caused by the electromagnetic energy radiated from the transmitter; the power of the latter should, in any case, be limited to the minimum necessary (from 200 to 500 mw). With the use of such low transmission power, together with a distance between the transmitter and the receiving station which may be as much as 150 km, it is usually necessary to use high gain directional receiving antennas.

On reception, and in order to be able to assign the data to appropriate heights, the signals obtained after demodulation or decoding are recorded on multichannel magnetic tape together with the time-based signals from the tracking radar. Time correlation between the telemetry signals and radar position data is very important.

6.4 TEMPERATURE MEASUREMENT BY INFLATABLE FALLING SPHERE

The inflatable falling sphere is a simple 1 m diameter mylar balloon containing an inflation mechanism and nominally weighs about 155 g. The sphere is deployed at an altitude of approximately 115 km where it begins its free fall under gravitational and wind forces. After being deployed the sphere is inflated to a super pressure of approximately 10 to 12 hPa by the vaporization of a liquid, such as isopentane. The surface of the sphere is metallized to enable radar tracking for position information as a function of time. To achieve the accuracy and precision required, the radar must be a high-precision tracking system, such as an FPS-16 C-band radar or better. The radar-measured position information and the coefficient of drag are then used in the equations of motion to calculate atmospheric density and winds. The calculation of density requires knowledge of the sphere's coefficient of drag over a wide range of flow conditions (Luers, 1970; Engler and Luers, 1978). Pressure and temperature are also calculated for the same altitude increments as density. Sphere measurements are affected only by the external physical forces of gravity, drag acceleration and winds, which makes the sphere a potentially more accurate measurement than other in situ measurements (Schmidlin, Lee and Michel, 1991).

The motion of the falling sphere is described by a simple equation of motion in a frame of reference having its origin at the centre of the Earth, as follows:

$$m \frac{dV}{dt} = mg - \frac{\rho C_d A_s |V_r| \cdot V_r}{2} - \rho V_b g - 2m\omega \times V \quad (6.5)$$

where A_s is the cross-sectional area of the sphere; C_d is the coefficient of drag; g is the acceleration due to gravity; m is the sphere mass; V is the sphere velocity; V_r is the motion of the sphere relative to the air; V_b is the volume of the sphere; ρ is the atmospheric density; and ω is the Earth's angular velocity.

The relative velocity of the sphere with respect to air mass is defined as $V_r = V - V_a$, where V_a is the total wind velocity. C_d is calculated on the basis of the relative velocity of the sphere. The terms on the right hand side of equation 6.5 represent the gravity, friction, buoyancy, and Coriolis forces, respectively.

After simple mathematical manipulation, equation 6.5 is decomposed into three orthogonal components, including the vertical component of the equation of motion from which the density is calculated, thus obtaining:

$$\rho = \frac{2m (g_z - \ddot{z} - C_z)}{C_d A_s |V_r| (\dot{z} - w_z) + 2V_b g_z} \quad (6.6)$$

where g_z is the acceleration of gravity at level z ; w_z is the vertical wind component, usually assumed to be zero; \dot{z} is the vertical component of the sphere's velocity; and \ddot{z} is the vertical component of the sphere's acceleration.

The magnitudes of the buoyancy force ($V_b g_z$) and the Coriolis force (C_z) terms compared to the other terms of equation 6.7 are small and are either neglected or treated as perturbations.

The temperature profile is extracted from the retrieved atmospheric density using the hydrostatic equation and the equation of state, as follows:

$$T_z = T_a \frac{\rho_a}{\rho_z} + \frac{M_0}{R\rho_z} \int_h^a \rho_h g dh \quad (6.7)$$

where h is the height, the variable of integration; M_0 is the molecular weight of dry air; R is the universal gas constant; T_a is temperature in K at reference

altitude a ; T_z is temperature in K at level z ; ρ_a is the density at reference altitude a ; ρ_h is the density to be integrated over the height interval h to a ; and ρ_z is the density at altitude z .

Note that the source of temperature error is the uncertainty associated with the retrieved density value. The error in the calculated density is comprised of high and low spatial frequency components. The high frequency component may arise from many sources, such as measurement error, computational error and/or atmospheric variability, and is somewhat random. Nonetheless, the error amplitude may be suppressed by statistical averaging. The low frequency component, however, including bias and linear variation, may be related to actual atmospheric features and is difficult to separate from the measurement error.

6.5 **CALCULATION OF OTHER AEROLOGICAL VARIABLES**

6.5.1 **Pressure and density**

Knowledge of the air temperature, given by the sensor as a function of height, enables atmospheric pressure and density at various levels to be determined. In a dry atmosphere with constant molecular weight, and making use of the hydrostatic equation:

$$dp = -g\rho dz \tag{6.8}$$

and the perfect gas law:

$$\rho = \frac{M}{R} \cdot \frac{p}{T} \tag{6.9}$$

the relationship between pressures p_i and p_{i-1} at the two levels z_i and z_{i-1} between which the temperature gradient is approximately constant may be expressed as:

$$p_i = a_i \cdot p_{i-1} \tag{6.10}$$

where:

$$a_i = \exp \left[\frac{-M}{RT_{i-1}} \cdot g_0 \left\{ \frac{r_T}{r_T + z_{i-1}} \right\}^2 \cdot \left\{ 1 - \frac{T_i - T_{i-1}}{2T_{i-1}} \right\} \{ z_i - z_{i-1} \} \right] \tag{6.11}$$

and g_0 is the acceleration due to gravity at sea level; M is the molecular weight of the air; p_i is the pressure at the upper level z_i ; p_{i-1} is the pressure at the lower level z_{i-1} ; r_T is the radius of the Earth; R is the gas constant (for a perfect gas); T_i is the temperature at the upper level z_i ; T_{i-1} is the temperature at the lower level z_{i-1} ; z_i is the upper level; and z_{i-1} is the lower level.

By comparison with a balloon-borne radiosonde from which a pressure value p is obtained, an initial pressure p_i may be determined for the rocket sounding at the common level z_i , which usually lies near 20 km, or approximately 50 hPa. Similarly, by using the perfect gas law (equation 6.9), the density profile ρ can be determined.

This method is based on step-by-step integration from the lower to the upper levels. It is, therefore, necessary to have very accurate height and temperature data for the various levels.

6.5.2 **Speed of sound, thermal conductivity and viscosity**

Using the basic data for pressure and temperature, other parameters, which are essential for elaborating simulation models, are often computed, such as the following:

(a) The speed of sound V_s :

$$V_s = \left(\gamma R \frac{T}{M} \right)^{\frac{1}{2}} \tag{6.12}$$

where $\gamma = C_p/C_v$;

(b) The coefficient of thermal conductivity, κ , of the air, expressed in $W m^{-1} K^{-1}$:

$$\kappa = \frac{2.6502 \cdot 10^{-3} \cdot T^{\frac{3}{2}}}{T + 2454 \cdot 10^{\frac{12}{T}}} \tag{6.13}$$

(c) The coefficient of viscosity of the air μ , expressed in $N s m^{-2}$:

$$\mu = \frac{1.458 \cdot 10^{-6} \cdot T^{\frac{3}{2}}}{T + 110.4} \tag{6.14}$$

6.6 **NETWORKS AND COMPARISONS**

At present, only one or two countries carry out regular soundings of the upper atmosphere. Reduction in operational requirements and the high costs associated with the launch operation tend to limit the number of stations and launching frequency.

In order that the results obtained by the various existing systems may be uniform, international comparisons were conducted from Wallops Island, Virginia, United States in 1968, 1972, and 1977; and from Kourou, French Guiana, in 1973 and 1977 (Finger and others, 1975; Schmidlin and others, 1980).

Below 50 km, the data appear reasonably homogeneous. Above that height and up to 65 km, certain differences appear in the in situ thermistor measurements, but, by using compatibility tables prepared during the comparisons, it is possible to apply the results for synoptic studies simply by adjusting for systematic differences.

REFERENCES AND FURTHER READING

- Ballard, H.N., 1966: The measurement of temperature in the stratosphere and mesosphere. *Journal of Applied Meteorology*, Volume 6, Issue 1, pp. 150-163.
- Bollermann, B., 1970: *A Study of 30 km to 200 km meteorological rocket sounding systems*. NASA Contractor Report CR-1529.
- Bulanova, L.K., and others, 1967: *Some Results on the Methodical Treatment of the Temperature Measurement at High Layers of the Atmosphere Using Small Thermistors*. Trudy, Central Aerological Observatory, Volume 77, pp. 3-16.
- Eddy, A., C.E. Duchon, F.M. Haase and D.R. Haragan, 1965: *Determination of Winds from Meteorological Rocketsondes*. Report No. 2, Atmospheric Science Group, University of Texas, Austin, Texas.
- Engler, N.A. and J.K. Luers, 1978: *Modifications to the 1972 ROBIN Program*. Final report to the Atmospheric Sciences Laboratory, White Sands Missile Range. Report ASL-CR-0008-1.
- Finger, F.G., M.E. Gelman, F.J. Schmidlin, R. Leviton and B.W. Kennedy, 1975: Compatibility of meteorological rocketsonde data as indicated by international comparison tests. *Journal of the Atmospheric Sciences*, Volume 32, Issue 9, pp. 1705-1714.
- Henry, R.M., 1967: Corrections for meteorological rocket temperature soundings on an individual basis. In: *Proceedings of the Conference on High-altitude Meteorology and Space Weather*. American Meteorological Society, Houston, Texas.
- Kokin, G.A. and V.Y. Rusina, 1976: *Some Results of the Flight Testing of the Onboard Equipment of the MMR-06 Meteorological Rocket*. Trudy, Central Aerological Observatory, Volume 99, pp. 130-146.
- Krumins, M.V. and W.C. Lyons, 1972: *Corrections for the Upper Atmosphere Temperatures Using a Thin-film Loop Mount*. Technical Report TR 72-152, Naval Ordnance Laboratory, White Oak, Maryland.
- Luers, J.K., 1970: *A Method of Computing Winds, Density, Temperature, Pressure, and their Associated Errors from the High Altitude ROBIN Sphere using an Optimum Filter*. AFGL Contract F19628-C-0102, University of Dayton Research Institute, Air Force Report AFCRL-70-0366.
- Schmidlin, F.J., J.R. Duke, A.I. Ivanovsky and Y.M. Chernyshenko, 1980: *Results of the August 1977 Soviet and American Meteorological Rocketsonde Intercomparison Held at Wallops Island, Virginia*. NASA Reference Publication RP 1053.
- Schmidlin, F.J., H.S. Lee and W. Michel, 1991: The inflatable sphere: A technique for the accurate measurement of middle atmosphere temperatures. *Journal of Geophysical Research*, Volume 96, Number D12, pp. 22673-22682.
- Yata, A., 1970: Correction for the temperature data obtained by MT-135 system. *Geophysical Magazine* (Tokyo), Volume 35, pp. 99-121.
-

CHAPTER 7

LOCATING THE SOURCES OF ATMOSPHERICS¹

7.1 GENERAL

7.1.1 Definitions

Atmospherics, or sferics, may be defined as electromagnetic waves resulting from lightning discharges in the atmosphere. From a practical point of view, interest usually lies in the source of the atmospheric, the lightning flash. Then, the atmospheric is considered only as a phenomenon which offers a means of detecting and/or locating flashes. The mere detection of flashes is usually limited to local warning purposes, while flash location data can be used for various meteorological and other tasks. Terms such as sferic observations are convenient expressions to cover both kinds of methods. The following definitions also relate to sferics:

Cloud flash: A lightning discharge occurring within a cloud or between different clouds. It is usually outside the practical interest where thunderstorms are concerned, but may be useful in local thunderstorm warning systems.

Cloud-to-ground flash: The type of lightning flash of common practical interest. Referred to simply as a flash.

Direction finder: An instrument that determines the direction of arrival of an atmospheric.

Fix: The estimated location of a lightning flash as deduced from atmospheric.

Flash: The total lightning event consisting of one or more return strokes (and of leaders preceding each stroke).

Flash counter: An instrument for counting the number of lightning flashes in the vicinity of a station.

Multiplicity: The number of strokes in a lightning flash. Most positive flashes are one-stroke flashes.

Polarity: Cloud-to-ground lightning flashes are either negative or positive, according to the sign of the electric charge lowered from the cloud to the ground. Negative flashes are more common, positive flashes are typical of winter conditions.

Range: The radius of observation of a (sferic) detection device. Local means a range of a few tens of kilometres, regional means a few hundred kilometres, and a long-range instrument has a range of up to one or a few thousand kilometres.

Sferic: The accepted contraction of the word "atmospheric" for meteorological purposes.

Source: The place of origin of an atmospheric, normally a lightning flash.

Static: A small-scale electrical discharge in the atmosphere. The use of this word for atmospheric is not recommended.

Stroke or return stroke: The main pulse of strong electric current in the lightning channel. A flash contains one or more strokes.

Time-of-arrival receiver: An instrument which determines the time of arrival of an atmospheric to a high degree of accuracy (of the order of a microsecond, μs).

7.1.2 Units

Lightning flashes are characterized by, in addition to polarity and multiplicity, their strength. The most frequently used definition of the strength is the peak value of the electric current of a return stroke (usually the first stroke of a flash), measured in units of amperes (A). Typical magnitudes of flash strengths are tens of kiloamperes (kA). The intensity of a thunderstorm may be described in terms of the flash rate in a given area, the average multiplicity, the average strength and the ratio of the number of negative to positive flashes. Current techniques for determining the various characteristics of thunderstorms would make it possible to define a useful descriptive and concise measure ("index") of thunderstorm activity, but no such general index exists yet.

Defining the performance of a lightning detection/location system requires certain parameters. A local warning device, such as a flash counter, involves parameters like the detection radius or range

1 The technical content of this chapter has not been revised since the previous edition of the Guide.

(usually a few tens of kilometres), the fraction of flashes observed within the radius, and the fraction of false alarms. A location system is mainly subject to location errors (normally of the order of kilometres) and the less-than-perfect detection efficiency (the fraction of the number of observed to true flashes in a given region, usually expressed in per cent). Errors in the estimation of flash strength and multiplicity are usually of lesser concern.

7.1.3 Meteorological requirements

Locating regions of thundery activity by means of sferics data, especially real-time data, provides the meteorologist with valuable supplementary information. This information is of particular value when it is available for large ocean areas or other regions in which observational stations are sparsely distributed. It can also provide clues as to the instability of air masses and the location and movement of fronts, squall lines, tropical storms and tornadoes, and can aid investigation of past events. Examples of the uses of lightning location data are given in Orville and others (1987) and Holle, Lopez and Watson (1990).

Meteorological services to aviation can also benefit from sferics data, since thunderstorms are a major hazard to flying, both because of the vigorous air motions and because the lightning may strike and damage the aircraft. The weather forecasts provided for aircrews and for traffic control purposes can be improved by the inclusion of information on the latest sferics, and the choice of a storm-free track is greatly assisted by locating the areas in which thundery activity is taking place. Similar considerations apply to the launching of spacecraft.

Other sectors are concerned with the effect of lightning strikes, which, among other things, can damage vulnerable installations, such as electric power cables above ground, be a hazard when mining with explosives and cause forest fires. Sferics observations can be used to provide warnings of such risks, both in regional terms through their interpretation by a forecaster and in local terms through the direct use of an automatic warning system. In addition, sferics observations for scientific purposes are made by meteorological and atmospheric research institutes in several countries.

7.1.4 Observation methods

7.1.4.1 Direction finders

The most widely used sferics observation systems today are based on automatic direction finders. A direction finder uses two orthogonal loop aerials

aligned north-south and east-west to resolve the direction of arrival of the sferic in terms of its horizontal magnetic components. A remaining 180° directional ambiguity is resolved by the vertical electric component which is sensed by a horizontal plate antenna.

A wide-band direction finder, detecting sferics at frequencies up to 1 MHz, may be used as a local stand-alone lightning warning system. Its most efficient use is, however, as a basic element in a regional network of three or more direction finders to locate lightning flashes by finding the intersection points of the directions. An operational location system is described in section 7.2.

Long-range direction finders (700–4 500 km) tuned to very low frequencies (5–10 kHz) have been used experimentally with the goal of mapping thunderstorms on continental or even global scales (Heydt and Takeuti, 1977; Grandt and Volland, 1988). The long path of propagation, whose influence on the pulse depends on the frequency, offers a possibility of estimating the distance from a single-station measurement by comparing the sferics components at several frequencies. So far, the questions of accuracy, detection efficiency and operational feasibility are unclear; hence, these systems will not be discussed here.

7.1.4.2 Time-of-arrival receivers

The distance of the source of a sferic to an observing station can be determined if the arrival time of a pulse can be measured with an accuracy of the order of 1 μ s. This accuracy requirement is associated with the speed of propagation of the sferic which is 300 m per microsecond. Because the time of occurrence of the lightning is not known, the time measurement is only relative, and locating the source requires the determination of the arrival-time difference from several stations. A general requirement for synchronizing the stations is the use of an accurate timing item, such as is provided by navigation satellites or broadcasting networks. The sferics-signal propagation time is less sensitive to variations in the properties of the terrain than is its direction. Hence, in principle, an arrival-time network could determine lightning locations more accurately than a comparable direction-finder network. Comparisons are discussed in section 7.4.

Two types of arrival-time receivers are currently in operational use. One of these is designed for use as a regional system (Bent and Lyons, 1984) and is described in section 7.3. The other type has been

developed by Lee (1986a, 1986b, 1989) to exploit the long-range performance of this technique and has been in operational use in the United Kingdom for more than three years; a description is given in section 7.3.6.

7.1.4.3 Local lightning detectors

Because local lightning detectors are not used widely by Meteorological Services or other users for scientific purposes, little information is available about their current markets and possible investigations of performance. Presumably, progress in this field has been slower than for location systems, and it is assumed that the results of a five-instrument comparison made by Johnson, Janota and Hay (1982) still has some validity. The discussion of local detectors is restricted to the short descriptions in this section.

Stand-alone direction finders can be used as lightning warning devices. The direction information is clearly the greatest advantage over other local detectors. Also, the average signal strength of a group of flashes may be used to estimate the distance. In the comparison of Johnson, Janota and Hay (1982), high sensitivity together with insufficient rejection of unwanted signals caused a lot of false alarms in the instrument tested. After the comparison, a new instrument, called a thunderstorm sensor, appeared in the market. It is basically the direction finder used in current direction finder networks (see section 7.2.1) and has the same capability to reject signals other than those originating from cloud-to-ground flashes. A computer display unit shows the situation in a sector format supplemented by some statistical data. The range has been set to 160 km. The thunderstorm sensor has been applied rather widely by institutes and companies for which the more accurate regional flash location data exceed their needs and/or financial resources for this purpose.

Lightning-flash counters are designed to count the discharges occurring within a radius of 20 to 50 km, depending on the instrument's sensitivity adjustment. The principle of the counter is based on the detection of a simple rapid electric field change (a static), which increases the sensitivity to false alarms. The false alarm rate can, however, be reduced by carefully selecting the location to avoid nearby sources of disturbance. Local flash counters can be used in synoptic meteorology for issuing storm warnings, especially in connection with weather radars. Their simple construction and operation, as well as

their low price, also make them feasible for use as warning devices in any activities which may benefit from short-term knowledge of approaching thunderstorms.

A third type of instrument for issuing warnings is based on the detection of the high static electric field associated with thunderclouds. The rapid decrease of the field strength with distance limits the useful range to 10 to 20 km. In this case, the advance warning is not based on the distance of an approaching thunderstorm cell, but on the build-up time of the electric field of an overhead or nearby thundercloud from the warning threshold value to the lightning breakdown value.

The static vertical electric field at the ground level can be measured by a field mill (a periodically changing capacitor), a radioactive probe (a short vertical antenna with a radioactive preparation to make the surrounding air electrically conducting by ionization), or a corona point (a high sharp point which exhibits a corona discharge when the electric field exceeds a threshold value). According to Johnson, Janota and Hay (1982), the corona-point instrument is susceptible to ambient noise, which causes false alarms, while the two former instruments are subject to leak currents caused mainly by spiders and insects, and require a lot of maintenance.

7.2 THE DIRECTION FINDING LIGHTNING LOCATION SYSTEM

7.2.1 The direction finder

A commercially available system of this type is described by Krider, Noggle and Uman (1976), and Maier and others (1984). It can be built with an integral structure with both the antennas and the associated electronics within the same unit, making installation relatively easy.

From the present point of view, the most important features are its capability of detecting very weak spheric signals while rejecting effectively signals other than those originating from cloud-to-ground lightning flashes. The test is based on an analysis of the pulse form of the signal and only a form resembling the return stroke is accepted. Some local non-lightning disturbances may pass the test, but such false signals are usually so weak that only one direction finder may be close enough to detect them; false located lightning, which requires coincident signals from at least two direction finders, is virtually always avoided.

The pulse-form criteria imply that the spheric from a genuine but distant cloud-to-ground flash may be too distorted to be accepted. The surface-wave pulse itself is modified during the propagation over the terrain, and a slightly delayed component reflected from the ionosphere is superposed on it. Owing to these factors, the nominal range of a direction finder is normally 400 km; attenuation of the signal strength over a distance of this magnitude has a minor effect. Yet, many flashes much farther away are accepted, which means that more distant thunderstorms are detected, although the information of their locations and flash frequencies is less accurate.

The system provides the following digital information of an accepted flash: the direction of arrival (the bearing angle), signal strength, polarity and multiplicity. These data are sent immediately to the modem, which is normally connected to the central unit of the network.

7.2.2 **Direction finder network configuration**

If there are coincident observations of two direction finders, the lightning location can be calculated as the intersection point of the two bearings. The determination of the location is generally most accurate when the bearings intersect close to perpendicular, while near the baseline joining the two stations, the location errors may increase considerably. As a result, a network should include at least three direction finders.

In order to cover as large an area as possible with a minimum number of direction finders, the direction-finder configuration must fulfil certain conditions. First, in order to minimize the occurrence of near-parallel (baseline) bearings, a small network should form a regular figure (an equilateral triangle for a three direction finder system, a square for a four direction finder system); for larger networks, stations lying on the same straight line should be avoided. Second, the spacing of the stations should be fairly even. In order to achieve a good performance within the distance dictated by the 400-km range, the spacing between neighbouring stations should be between about 150 and 250 km.

The actual network configuration that can be realized also depends on the availability of sites free from screening structures or terrain features, nearby sources of disturbances, and vandalism. The availability of communication lines may also limit the choice, and the presence of trained personnel may be useful, although a direction finder needs very little maintenance.

An important point to be considered is the redundancy of a network, that is, the number of stations compared with the minimum number needed to maintain it operational. Failures in the communication lines between the direction finders and the central unit are not uncommon, and it may be recommended to cover any region of interest by at least four direction finders. Redundancy also improves the location accuracy and detection efficiency of the network (see section 7.2.3).

The system employs a central unit position analyser which receives the direction-finder data and computes the locations. If the communication lines are fixed, the position analyser determines the coincidences from the arrival times of the direction-finder data; if the communications are packet-switched, which is cheaper, the position analyser keeps track of the clocks of each direction finder using the coincidence information provided by the observed flashes themselves. When coincident data from more than two direction finders are received by the position analyser, an optimized location is computed. Optimization can be simply the choice of the most perpendicular pair of bearings, or some statistical procedure like a least-squares-fit method (see section 7.2.3).

The definition of coincidence between direction finders depends on the noise conditions in the network areas. A safe value is 20 ms, but, if a direction finder fails to detect the first stroke of a flash and reports the second flash instead, the coincidence is lost. A coincidence window of 50 ms increases somewhat the number of located flashes, but the window must remain below 100 ms to avoid false coincidences.

A network could also use the direction finder information from another network. For instance, the performance of a national network can be improved by using some direction finders in a neighbouring country, and vice versa. The realization of such a connection is a technical question that cannot be addressed here.

7.2.3 **Location accuracy and detection efficiency of direction finder networks**

The bearings measured by direction finders are subject to so-called site errors, which are angular errors caused by nearby natural and man-made irregularities in the terrain surrounding the direction-finder site. The errors vary with direction, mostly in a systematic way, and once found, they can be loaded into the position analyser as systematic corrections.

One possibility of finding systematic errors has been described by Mach and others (1986). For a three direction finder observation, for instance, it is possible to compute the intersection point of one pair of bearings and correct the third bearing toward this point. This is carried out in the three different ways (for each direction finder) for this observation, and a great number of observations is collected to cover all directions and distances. After one complete run, the resulting corrections are applied partially to the original data, and new runs are iterated until the corrections converge. Systematic errors may be as large as 10° in some directions before correction.

A more sophisticated method has been developed by Orville (1987). It is a kind of least-squares-fit method which is easy to adapt to a large number of direction finders. It can be used either iteratively to obtain the systematic corrections, or as a single-run optimization method.

A problem with both of the above methods is that, while the systematic bearing errors in each direction (actually, in sectors of a few degrees) are the average values over a large data set, there remains a scatter of a more random nature which may be several degrees in some sectors. Orville's method is best suited to adjust, or optimize, after the systematic corrections, the final locations by minimizing such random variations, independently of what method has been used in determining the systematic errors. Note that the systematic errors, once found, are treated as instrumental constants, while the final optimization is an operation computed separately for each flash (in real time or later). In the determination of systematic errors, the random errors are present and cause bias in the results. In fact, the application of Mach's and Orville's methods to the same data may lead to different systematic-error estimates.

A solution to the problem of the coupling of the two different types of errors has been described by Passi and Lopez (1989). The idea, which can be justified theoretically, is to represent the systematic-error curves as double-period sinusoidals with unknown coefficients, and, in the equations for determining these coefficients, the systematic and random errors are decoupled. Once the systematic correction curves from a representative historical data set have been found, Orville's method is perhaps the easiest to use for optimizing the final locations.

The errors discussed above are caused by external factors. The fact that the direction finder accepts only relatively well-shaped pulses means that the

direction can be computed accurately. According to the manufacturer, the bearing errors due to pulse distortion and non-vertical components of the electric field remain below 1° .

Another factor affecting the performance of a lightning-location system is its detection efficiency. Mach and others, (1986) found that a four direction system, a typical network for regional use, had a detection efficiency of about 70 per cent. The method was a comparison with ground-truth data. For another four direction finder system, Tuomi (1990) determined how the number of located flashes depended on the number of direction finders present. If it is assumed that all cloud-to-ground flashes in the nominal area of coverage have a chance of being accepted by a direction finder, a fraction of 50 to 80 per cent of these are actually detected by it. As a result, a two direction finder system detects only about half of these flashes, and a three direction finder system 70 to 80 per cent, as has also been suggested by Mach's result. This would imply that a significant fraction, of the order of 10 per cent, of the cloud-to-ground flashes is not detected.

7.2.4 **Maintenance of a direction-finder network**

A direction-finding network is relatively easy to set up once proper sites have been found and communication lines established. If properly shielded from overvoltages, it is also technically rather reliable, requiring very little technical maintenance.

The main maintenance tasks involve the operation of the position analyser and data quality control. The operation, that is, the arrangement of the data display and the data flow to users and archives, can and should be automatic, after which the routine operational side reduces to a minimum. A more enduring, and more interesting, task is on the scientific side, which includes not only the physical or meteorological research of the final results, but also the determination of the site errors, the establishment of location optimization and of the resulting accuracy, and the definition of the true area of coverage in terms of detection efficiency.

7.3 **EXAMPLES OF TIME-OF-ARRIVAL LOCATION SYSTEMS**

As explained in section 7.1.4.2, two types of time-of-arrival systems are in current operational use, an example of each type is described below.

7.3.1 **A regional time of arrival**

Reports of experiences with time-of-arrival networks are significantly rarer than those of direction-finder networks, and, for this reason, the present section is relatively brief compared with the preceding section. Much of the description is given by pointing out the similarities and differences between the two systems.

7.3.2 **The time-of-arrival receivers**

The receiver antenna is a simple whip antenna which is easy to install because there are no special requirements to avoid nearby structures, cables, and so on. A receiver which records the time of arrival rather than the direction is immune to site errors. The receiver digitizes the pulse for a period of up to 100 μs with a resolution of 0.2 μs , determines the polarity and the time of occurrence of the peak, and sends all this information to the central unit. The receiver clock is continually adjusted by using an external timing signal (typically LORAN-C or GPS). The receiver analyses each stroke of a flash separately.

7.3.3 **Network configuration**

For a regional lightning-location system, the receivers are installed into a long-baseline system where they are separated by distances of 150 to 250 km. However, recent information suggests that a much larger separation between stations is possible while still maintaining detection efficiency and locational accuracy adequate for some applications. The recommended number of stations is four to six. Requirements for the choice of network geometry are similar to those of a direction-finder network. Also, the requirements for communications between the receiver stations and the central unit are similar.

7.3.4 **Location accuracy and detection efficiency of time-of-arrival networks**

The time-of-arrival technique of locating lightning is in principle very accurate. The determination of the peak of the pulse can generally be made with an error of one or a few microseconds, which corresponds to a spatial error of the order of 1 km or less. Errors in travel times caused by differences in propagation paths also cause errors of the order of 1 μs . However, larger errors may be caused by the effect of the propagation conditions on the rise in time of the main stroke pulse. The strike location corresponds to the initial rise of the pulse, while the pulse peak occurs slightly later (MacGorman and

Rust, 1988). The different strokes of a flash, located by the pulse peaks, may show little scatter, but the location of the whole group may be in some error because of pulse rise times.

Still larger errors can be caused by a misinterpretation of the pulse peak, which may be blurred or displaced by the presence of ionospheric reflections or by the distortion of the waveform due to distance. According to one manufacturer, such spurious locations are usually separate and randomly distributed, and their number can be reduced by filtering (by dropping out those cases where there is, for a properly chosen time period, only one location within a map element of given size).

According to a report distributed by the manufacturer, the detection efficiency of a four-to-six station time-of-arrival network is about 80 to 85 per cent in terms of the detected strokes. Because a flash may still be detected even if a stroke is lost (this is also true for direction finders), the detection efficiency with respect to flashes may be higher, but no estimate is given. Neither is it known how efficient is the rejection of pulses is from sources other than cloud-to-ground lightning.

7.3.5 **Time-of-arrival system maintenance**

From the point of view of operation and maintenance, a time-of-arrival network is quite similar to a direction-finder network, namely, technical maintenance is probably not a problem while the tasks of data distribution and scientific quality control are long-lasting and interesting.

7.3.6 **The arrival time difference system**

The arrival time difference network was developed by the UK Met Office to provide wide-area lightning location over Europe and the eastern Atlantic. The time-of-arrival technique was chosen for superior location accuracy at long ranges. Because of the change in shape of spheric waveforms that takes place over long ranges due to propagation effects, differences in waveform arrival times between pairs of detectors are computed using a time lag correlation technique involving the entire waveform envelope.

7.3.7 **The arrival time difference network**

This network consists of five detectors in the United Kingdom at distances varying from 300 to 900 km. In addition, two further detectors in Gibraltar and Cyprus operate at distances from the United Kingdom

of 1 700 and 3 300 km, respectively, and are particularly vital to the long-range performance of this system. One detector (the selector) is set to be less sensitive than the others, which are then invited to submit data on sferics that they receive within a given time tolerance of the selector. Locations are then computed for events which pass given quality control criteria, for example, at least four detectors contributing sufficiently well defined correlations and well behaved variation of sferic amplitude with range.

7.3.8 **Arrival time difference location accuracy and detection efficiency**

Current location accuracy is typically 1 to 2 km in the United Kingdom, 2 to 5 km in Europe and 5 to 10 km over the eastern Atlantic. Beyond that, the accuracy lies between 1 and 2 per cent of the range out to 12 000 km. With the loss of the non-United Kingdom detectors, the accuracy degrades by about a factor of 10 outside the United Kingdom.

The present system is limited both by communication speed and processor power to a throughput of 450 flashes per hour. As a result, flash-detection efficiency is rather low and varies with the overall level of activity in the service area. Variations in Europe are between 25 and 70 per cent.

7.3.9 **Arrival time difference maintenance**

The precision oscillators used for keeping time at the detector stations require regular calibration against LORAN-C or GPS. A requirement for a long-range system is an adequate propagation model to correct for diurnal effects and also for land/sea path changes. In the absence of such a model, timing consistency checks are made at intervals using data from all detectors in the network.

7.4 **COMPARISONS OF DIRECTION-FINDER AND TIME-OF-ARRIVAL NETWORKS**

The fact that direction-finder systems have been on the market since the end of the 1970s and that time-of-arrival systems appeared at least five years later has resulted in a significant difference in the reported experiences with the systems. While results obtained by various lightning location position installations are rather abundant, corresponding time-of-arrival reports are few, and the number of comparisons between the two systems is smaller still. Hence, the results presented here should not be generalized directly to the conditions met in different countries.

Another, and perhaps more important, point is that both systems are developing all the time. Any institute planning to set up a new lightning location system should look at the situation as it stands at that time and consult as many new reports as possible.

A problem with the comparisons is that they have not been published in generally available journals, but rather in institute reports which are difficult to obtain. The comparison made by MacGorman and Rust (1988) was presented orally at a conference, but the actual results were not given in the proceedings; however, the same results are quoted by Murphy (1988) in an informal report. Another comparison is a study made by Oskarsson (1989) and published as an institute report in Swedish.

According to Murphy (1988), the major direction-finder networks in the United States have a mean location error of about 3 km. In areas with short direction-finder baselines, the error may be below 1 km, and in long-baseline regions, about 5 km. A typical value of the detection efficiency is 70 per cent. The false detection rate is very low. It was not reported whether the system uses an optimization procedure in computing the locations. The time-of-arrival location errors are of the order of 10 km, and the detection efficiency is 35 to 45 per cent. It is probable, however, that these figures have now been improved by technical developments.

Oskarsson (1989) made a comparison of time-of-arrival and direction-finder systems in Sweden, for a few thunderstorm events. The users of the time-of-arrival system estimated an average accuracy of 5 km, a somewhat better performance than the direction-finder system, but the latter was evidently not using an optimization procedure; a striking example of the effect is given by Passi and Lopez (1989). Relating the flash and stroke numbers, it appeared that the time-of-arrival flash-detection efficiency was lower than that of the direction-finder system by a factor of between 1 and 1.5. In Finland, it was estimated that a four-station direction-finder network had an average accuracy of 5 km after systematic corrections and optimization (Tuomi, 1990); the real-time accuracy, without optimization, was somewhat worse.

As a conclusion, it could be said that the two competing systems offer broadly comparable performance. When planning to purchase either system from competing suppliers, it would be useful to try to obtain answers to various questions using the latest information available, such as the following:

- (a) Is the central unit of the direction finder capable of using an optimization procedure?

- (b) Is a qualified person available to control the quality of the data of either system?
- (c) What systems, if any, are used in neighbouring countries? Could a network connection be useful?
- (d) Are good timing signals available for time-of-arrival?
- (e) How good is the rejection of false alarms in the time-of-arrival system? What is the resulting detection efficiency?
- (f) For a particular application, is it important to identify flashes rather than strokes?
- (g) What communication links will be needed (for both systems, the communication between the central unit and the direction-finder/time-of-arrival stations is likely to be costly, unless it can be integrated with existing facilities)?
- (h) How many direction-finder or time-of-arrival stations would be required to provide useful location accuracy and detection efficiency over the desired coverage area?
- (i) Are there direction-finder/time-of-arrival station siting considerations which would minimize the number of required stations?

7.5 **A COMBINATION OF THE DIRECTION-FINDER AND TIME-OF-ARRIVAL TECHNIQUES**

The SAFIR lightning location system developed in France represents a very sophisticated, but rather expensive, means of providing very high detection efficiency with good accuracy over a range of about 150 km using very high frequency detectors.

A typical network consists of three detectors located on 120° sectors between 20 and 70 km from a central station. Each detector uses three antennas positioned between 1 and 2 m from a central point on the assembly also on 120° sectors. This assembly acts as an interferometer to compute both the azimuth and the elevation angles of observed lightning events. The data-acquisition rate is high enough to identify sections of the lightning trajectory which provides good distinction between cloud-to-cloud and cloud-to-ground discharges. This is a good system for warning of lightning risks at launch sites, airports, and so on, where cloud-to-cloud lightning information is important. In view of the relatively short range, it is less suitable for use in a national location network.

7.6 **PRESENTATION AND DISTRIBUTION OF LIGHTNING DATA**

With today's versatile computer facilities, numerous possibilities of data presentation are at hand. One of the most useful methods for weather forecasters is to superimpose the lightning locations on a weather-radar or satellite-picture screen display to identify active clouds.

Computer networks offer almost unlimited possibilities to distribute real-time or historical flash location data to those interested. The problems encountered are common to the distribution of any information and are not specific to lightning location data.

REFERENCES AND FURTHER READING

- Bent, R.B. and W.A Lyons, 1984: Theoretical evaluations and initial operational experiences of LPATS (lightning position and tracking system) to monitor lightning ground strikes using a time-of-arrival (TOA) technique. *Preprints of the Seventh International Conference on Atmospheric Electricity*, Albany, New York, American Meteorological Society, pp. 317-324.
- Grandt, C. and H.Volland, 1988: Locating thunderstorms in South Africa with VLF sferics: Comparison with METEOSAT infrared data. *Proceedings of the Eighth International Conference on Atmospheric Electricity*, Uppsala, Sweden, Institute of High Voltage Research, pp. 660-666.
- Heydt, G. and T. Takeuti, 1977: Results of the global VLF-atmospherics analyser network. In H. Dolezalek and R. Reiter: *Electrical Processes in Atmospheres*, Steinkopf, Darmstadt, pp. 687-693.
- Holle, R.L., R.E. Lopez and A.I. Watson, 1990: Cloud-to-ground lightning detection using direction-finder networks: *WMO Bulletin*, Volume 39, Number 3, pp. 177-180.
- Johnson, R.L., D.E. Janota and J.E. Hay, 1982: An operational comparison of lightning warning systems. *Journal of Applied Meteorology*, Volume 21, Issue 5, pp. 703-707.
- Krider, E.P., R.C. Noggle and M.A. Uman, 1976: A gated, wideband magnetic direction finder for lightning return strokes. *Journal of Applied Meteorology*, Volume 15, pp. 301-306.
- Lee, A.C.L., 1986a: An experimental study of the remote location of lightning flashes using a VLF arrival time difference technique. *Quarterly Journal of the Royal Meteorological Society*, Volume 112, Issue 471, pp. 203-229.
- Lee, A.C.L., 1986b: An operational system for the remote location of lightning flashes using a VLF arrival time difference technique. *Journal of Atmospheric Oceanic Technology*, Volume 3, Issue 4, pp. 630-642.
- Lee, A.C.L., 1989: Ground truth confirmation and theoretical limits of an experimental VLF arrival time difference lightning flash locating system. *Quarterly Journal of the Royal Meteorological Society*, Volume 115, Issue 489, pp. 1147-1166.
- MacGorman, D.R. and W.D. Rust, 1988: An evaluation of the LLP and LPATS lightning ground strike mapping systems. *Proceedings of the Eighth International Conference on Atmospheric Electricity*, Uppsala, Sweden, Institute of High Voltage Research, pp. 668-673.
- Mach, D.M., D.R. MacGorman, W.D. Rust and R.T. Arnold, 1986: Site errors and detection efficiency in a magnetic direction-finder network for locating lightning strikes to ground. *Journal of Atmospheric and Oceanic Technology*, Volume 3, Issue 1, pp. 67-74.
- Maier, M.W., L.G. Byerly, R.C. Binford, W.L. Hiscox, E.P. Krider, A.E. Piper and M.A. Uman, 1984: Gated, wideband magnetic direction finders for locating cloud-to-ground lightning. *Preprints of the Seventh International Conference on Atmospheric Electricity*, Albany, New York, American Meteorological Society, pp. 305-310.
- Murphy, J.D., 1988: *Lightning Detection System Acquisition and Application*. Fifth Weather Wing Forecaster Memorandum.
- Orville, R.E., Jr., 1987: An analytical solution to obtain the optimum source location using multiple direction finders on a spherical surface. *Journal of Geophysical Research*, Volume 92, (D9), pp. 10877-10886.
- Orville, R.E., R.A. Weisman, R.B. Pyle, R.W. Henderson and R.E. Orville, Jr., 1987: Cloud-to-ground lightning flash characteristics from June 1984 through May 1985. *Journal of Geophysical Research*, 92 (D5), pp. 5640-5644.
- Oskarsson, K., 1989: *En jämförande studie mellan blixtpeljssystemen LLP och LPATS*. Meteorological Institute, Uppsala University, Sweden.
- Passi, R. M. and E.L. Lopez, 1989: A parametric estimation of systematic errors in networks of magnetic direction finders. *Journal of Geophysical Research*, Volume 94 (D11), pp. 13319-13328.
- Tuomi, T.J., 1990: On the accuracy and detection efficiency of a lightning location system of four direction finders. *Geophysica*, Volume 26, pp. 1-16.

CHAPTER 8

SATELLITE OBSERVATIONS¹

8.1 GENERAL

This chapter describes the application of remote-sensing techniques by satellite to the measurement and observation of meteorological and related quantities at the Earth's surface and in the troposphere and stratosphere. Its purpose is to describe space-based data in the context of the surface-based data systems which are the main subjects of this Guide, outlining the engineering and data-reduction techniques of satellite systems, and drawing attention to the differences and relative advantages of the two approaches. An outline of satellite technology is provided in sections 8.2 and 8.4. Section 8.3 describes the ways in which meteorological quantities are derived from the radiances which are directly measured by the satellite instruments, with comments on their accuracy, representativeness and relation to surface-based data.

Satellite systems have been continually evolving, and new systems under development are expected to be operational within a few years. The basic techniques continue to be generally relevant, and the discussion here will remain valid for the present purposes, for comparison with surface-based methods. Although the European meteorological satellites and data-processing systems are described here as examples of satellite technology applied to the acquisition of meteorological data, the other satellite systems make use of essentially similar processing and technology.

The references at the end of the chapter may be consulted for greater details on satellite technology and measurements. Very useful general descriptions may be found in Rao and others (1990), WMO (1994*a*) and Smith (1985). WMO (1994*b*) contains detailed descriptions of satellites and instruments and an authoritative statement of requirements. General information regarding WMO requirements is contained in WMO (1989; 2003).

Typical meteorological satellites orbit the Earth at elevations of about 36 000 km or about 850 km, and they are used to obtain both images and quantitative information about surface features and the lowest 20 km of the atmosphere. This, of course,

requires very sensitive instrumentation and data processing and very expensive systems, but the cost is justified by the quantity and quality of the data. The following is a brief discussion of the cost-effectiveness of satellite systems.

The use of sensors on satellite platforms to provide measurements of geophysical quantities has certain advantages and disadvantages compared with the use of ground-based observational systems. These are summarized in Table 8.1.

The imaging capability of meteorological satellites is part of the justification for using satellites. Cloud images provide invaluable diagnostic information which assists in the analysis of meteorological features. This benefit can be extended by the use of time lapse image sequences which transform our understanding of atmospheric processes. This cloud-pattern information is not quantitative.

Quantitative meteorological measurements are a very strong argument for the use of satellites. Numerical forecast models need precise measurements of atmospheric parameters at frequent time intervals, for many levels, and at close intervals over the surface of the Earth. The required spacing of the observations depends upon the nature of the model. The observational requirements for operational meteorology are summarized in Table 8.2.

The global requirements stated in Table 8.2 could be met by an adequate network of about 5 000 conventional stations, preferably regularly distributed all over the globe, each measuring the pressure at the surface as well as the wind, temperature and humidity at many levels, from the surface to 50 hPa, two to four times each day. However, ocean areas cannot sustain such a network, and the cost of such a network would be of the order of US\$ 10 billion.

By contrast, the entire globe can be observed by a system of seven meteorological satellites. A global programme to launch an appropriate number of new satellites each year is required in order to replace those satellites which have come to the end of their life, and to ensure operational backup; the total system could cost less than US\$ 500 million per year to operate, excluding development costs.

1 The Technical content of this chapter has not been revised since the previous edition of the Guide.

Table 8.1. Satellite systems compared with ground-based observing systems

<i>Advantages</i>	<i>Disadvantages</i>
Global coverage, including remote land areas and the oceans	Atmospheric, oceanographic and hydrological parameters not measured directly
High space and time resolution over large areas	Point accuracy low: instrument calibration and data-reduction procedures require continual attention
Wide range of parameters may be measured	Long lead time for new instruments
Favourable cost/benefit ratio for a high volume of data	Large capital outlay for satellite launch and for central ground equipment
Simultaneous measurement of many parameters	Sensor failure may result in total loss of data
Measurements continue through severe weather	Surface and lower atmosphere parameters may be only partially measured in thick cloud (severe weather)
Measurements throughout the depth of the atmosphere in some conditions	A very large amount of data needs to be processed and archived, and users cannot modify data needs collection easily

Table 8.2. Model requirements for different scales of forecasting

<i>GLOBAL</i>	<i>Medium range</i>	<i>REGIONAL</i> <i>Short range</i>	<i>LOCAL: NOWCASTING</i> <i>Very short range</i>
Timescale of forecasting	2–14 days	12–48 h	0–12 h
Area of interest (km radius around point for which forecast is required)	Global	3 000	1 000
Horizontal resolution of model (km)	150	75	15 (5 for nowcasting)
Frequency of coverage	12 h	6 h	1 h (15 min for nowcasting)
Speed of product delivery	3 h	2 h	30 min (5 min for nowcasting)

Similar arguments can be advanced concerning the denser observational networks required for regional- and local- scale forecasting. Data used for nowcasting (0–2 h) in advanced operational centres have even more stringent conditions than those shown in the third column of Table 8.2. They have to be able to show rapid changes within small features; therefore, the following are important requirements:

- (a) Availability to forecast with fast response time;
- (b) High time resolution (5 min for convection; 15 min for fronts);
- (c) High space resolution (ability to resolve 1 km convective features and 3 km frontal features).

Very dense additional conventional networks would be needed to satisfy these observational requirements, whereas the same global system of satellites could, if appropriately specified, also provide the increased density of observations at relatively small additional cost.

Therefore, although individually expensive, satellites provide more observations per dollar; hence, the main motivation for the interest expressed here in quantitative uses of meteorological satellites is financial. They appear to offer cost-effective solutions to the problem of the acquisition of observational data with useful resolution and accuracy.

Meteorological quantities which are measured operationally at present, with varying resolution and accuracy, include the following:

- (a) The temperature profile, and the temperature at the cloud top and at the surface of the sea and land;
- (b) The humidity profile;
- (c) The wind at cloud level and at the ocean surface;
- (d) Liquid and total water and precipitation rate;
- (e) Net radiation and albedo;
- (f) Cloud type and height of cloud top;
- (g) Total ozone;
- (h) The coverage and the edge of ice and snow.

Many of these measurements are described in this chapter. The techniques for measuring the non-meteorological quantities of vegetation and volcanic ash, which are operationally significant, are also described here.

Satellite measurements have by nature both horizontal and vertical spatial resolutions, and are much less precise than surface-based measurements. They do not meet the resolution and, in most cases, the accuracy requirements for all applications, including modelling, and are best used in combination with surface-based observational networks. Space-based and surface observations must be regarded as complementary, instead of competing, data sources.

8.2 OPERATIONAL SATELLITE SYSTEMS

8.2.1 Space vehicles

The design of a space vehicle must take into account the lack of gravity in a free orbit, the high-vacuum conditions in which materials have very different properties from those on the Earth's surface, and the presence of energetic particle radiation and micro-meteoritic dust.

Although the satellite vehicle (bus) acts as a frame on which to mount the instruments monitoring the Earth and its atmosphere, it must also provide the necessary power for the instruments, thermal control, aspect control, a data-handling system and communications. Power is normally supplied by solar cells, backed up by batteries to store energy when the satellite is on the night-time side of the Earth.

Sensors and other electrical equipment will only operate under particular temperature ranges. Hence, heat generated by electronic equipment, or

absorbed from incident radiation, must be balanced by long-wave radiation emission into space. Active control of the temperature can be achieved by varying the net long-wave radiation via attitude control, or by the operation of shutters to increase or decrease the area of radiating surfaces pointing towards cold space. Aspect control of a space vehicle is achieved by several different means, depending upon the overall vehicle design. Precise spin rates can be maintained by alteration of the mass distribution of the satellite and hence its moment of inertia. Alternatively, inertial systems are used which torque with respect to the Earth's magnetic field, and reaction jets may be activated. It is worth noting that the more stable the vehicle is, the longer its useful life. Atmospheric drag prevents orbits much below 300 km altitude from being used, as the vehicle lifetime is considerably reduced. However, at higher orbits, this drag is very small and lifetimes of several years are achieved.

8.2.2 Satellite orbital dynamics

A satellite moving without friction in the gravitational field of a spherical planet (Figure 8.1) has a trajectory that is either elliptical, parabolic or hyperbolic, depending upon its starting velocity (Massey, 1964). For an Earth-orbiting satellite, an elliptical orbit, or the special case of a circular orbit, is required. For the elliptical orbit shown in Figure 8.1a, the distance r of the satellite from the centre of the Earth is given by:

$$r = \frac{a(1 - e^2)}{1 + e \cos \theta} \quad (8.1)$$

where θ is the angle between the satellite's present radius vector and that at perigee (the orbit's closest point to the Earth); and a is the semi-major axis of the ellipse; ae is the displacement of the ellipse centre from the centre of the Earth where e is the eccentricity of the ellipse.

The period T for the satellite to travel around the orbit is:

$$T = 2\pi \left(\frac{a^3}{GM} \right)^{\frac{1}{2}} \quad (8.2)$$

where G is the gravitational constant; M is the mass of the Earth; and $GM = 3.986\ 03 \times 10^{14} \text{ m}^3 \text{ s}^{-2}$. For a circular orbit centred on the Earth, $e = 0$, $a = r$ and the horizontal speed of the satellite is:

$$v_0 = \left(\frac{GM}{a} \right)^{\frac{1}{2}} \quad (8.3)$$

In terms of the height h above the Earth (Figure 8.1(b)), and the acceleration due to gravity at the Earth's surface, $g = GM/R^2$, where $R = 6\,378$ km is the Earth's mean equatorial radius, then:

$$v_0 = R \left(\frac{g}{R+h} \right)^{\frac{1}{2}} \quad (8.4)$$

The rocket on which a satellite space vehicle sits must be launched to obtain a trajectory such that the desired height h and its speed V result. If, when the satellite reaches h its speed is $V < V_0$ then the vehicle will fall into an elliptical orbit for which $a < (h+R)$. However, if $V > V_0$ the satellite will move out into a higher ellipse and $a > (h+R)$. If $V > 2V_0$ then the orbit becomes parabolic, the satellite has reached escape velocity, and it will not remain in orbit around the Earth.

A geostationary orbit is achieved if the satellite orbits in the same direction as the Earth's rotation, with a period of one day. If the orbit is circular above the Equator it becomes stationary relative to the Earth and, therefore, always views the same area

of the Earth's surface. Taking $T = 1$ day = 86 400 s, from equation 8.2, $a = 42\,290$ km, and therefore for a geostationary orbit $h = a - R = 35\,910$ km.

Lower orbits have much shorter periods. Satellites at altitudes of between 500 and 2 000 km are normally placed in nearly circular polar orbits so that they move over the poles during a period of around 1 or 2 h. The usual altitude for meteorological satellites is 880 km. As the Earth rotates under this orbit, the satellite effectively scans from north to south over one side and from south to north across the other side of the Earth, several times each day, achieving much greater surface coverage than if it were in a non-polar orbit.

The discussion so far has assumed spherical symmetry and zero drag. In practice, this is not so. The main deviation from a pure elliptical orbit is due to non-symmetrical gravity forces caused by the irregular figure and mass distribution of the Earth. Solar and lunar gravitation are not important, but the equatorial bulge of the Earth is of major importance, thus causing a slight change to the satellite

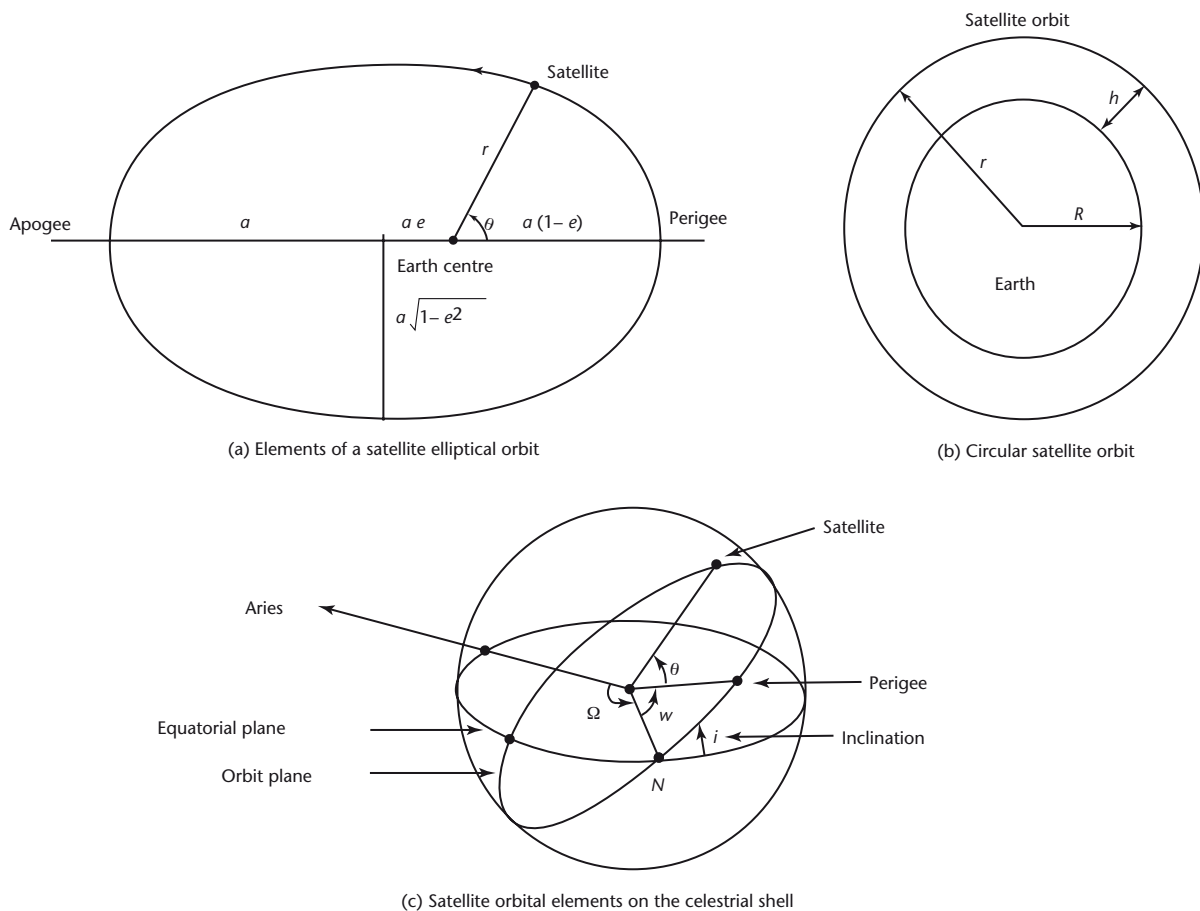

Figure 8.1. Geometry of satellite orbits

the sensors in order to avoid heating of the sensors due to the Joule effect caused by the electromagnetic energy radiated from the transmitter; the power of the latter should, in any case, be limited to the minimum necessary (from 200 to 500 mw). With the use of such low transmission power, together with a distance between the transmitter and the receiving station which may be as much as 150 km, it is usually necessary to use high gain directional receiving antennas.

On reception, and in order to be able to assign the data to appropriate heights, the signals obtained after demodulation or decoding are recorded on multichannel magnetic tape together with the time-based signals from the tracking radar. Time correlation between the telemetry signals and radar position data is very important.

6.4 TEMPERATURE MEASUREMENT BY INFLATABLE FALLING SPHERE

The inflatable falling sphere is a simple 1 m diameter mylar balloon containing an inflation mechanism and nominally weighs about 155 g. The sphere is deployed at an altitude of approximately 115 km where it begins its free fall under gravitational and wind forces. After being deployed the sphere is inflated to a super pressure of approximately 10 to 12 hPa by the vaporization of a liquid, such as isopentane. The surface of the sphere is metallized to enable radar tracking for position information as a function of time. To achieve the accuracy and precision required, the radar must be a high-precision tracking system, such as an FPS-16 C-band radar or better. The radar-measured position information and the coefficient of drag are then used in the equations of motion to calculate atmospheric density and winds. The calculation of density requires knowledge of the sphere's coefficient of drag over a wide range of flow conditions (Luers, 1970; Engler and Luers, 1978). Pressure and temperature are also calculated for the same altitude increments as density. Sphere measurements are affected only by the external physical forces of gravity, drag acceleration and winds, which makes the sphere a potentially more accurate measurement than other in situ measurements (Schmidlin, Lee and Michel, 1991).

The motion of the falling sphere is described by a simple equation of motion in a frame of reference having its origin at the centre of the Earth, as follows:

$$m \frac{dV}{dt} = mg - \frac{\rho C_d A_s |V_r| \cdot V_r}{2} \quad (6.5)$$

$$- \rho V_b g - 2m\omega \times V$$

where A_s is the cross-sectional area of the sphere; C_d is the coefficient of drag; g is the acceleration due to gravity; m is the sphere mass; V is the sphere velocity; V_r is the motion of the sphere relative to the air; V_b is the volume of the sphere; ρ is the atmospheric density; and ω is the Earth's angular velocity.

The relative velocity of the sphere with respect to air mass is defined as $V_r = V - V_a$, where V_a is the total wind velocity. C_d is calculated on the basis of the relative velocity of the sphere. The terms on the right hand side of equation 6.5 represent the gravity, friction, buoyancy, and Coriolis forces, respectively.

After simple mathematical manipulation, equation 6.5 is decomposed into three orthogonal components, including the vertical component of the equation of motion from which the density is calculated, thus obtaining:

$$\rho = \frac{2m (g_z - \ddot{z} - C_z)}{C_d A_s |V_r| (\dot{z} - w_z) + 2V_b g_z} \quad (6.6)$$

where g_z is the acceleration of gravity at level z ; w_z is the vertical wind component, usually assumed to be zero; \dot{z} is the vertical component of the sphere's velocity; and \ddot{z} is the vertical component of the sphere's acceleration.

The magnitudes of the buoyancy force ($V_b g_z$) and the Coriolis force (C_z) terms compared to the other terms of equation 6.7 are small and are either neglected or treated as perturbations.

The temperature profile is extracted from the retrieved atmospheric density using the hydrostatic equation and the equation of state, as follows:

$$T_z = T_a \frac{\rho_a}{\rho_z} + \frac{M_0}{R\rho_z} \int_h^a \rho_h g dh \quad (6.7)$$

where h is the height, the variable of integration; M_0 is the molecular weight of dry air; R is the universal gas constant; T_a is temperature in K at reference

altitude a ; T_z is temperature in K at level z ; ρ_a is the density at reference altitude a ; ρ_h is the density to be integrated over the height interval h to a ; and ρ_z is the density at altitude z .

Note that the source of temperature error is the uncertainty associated with the retrieved density value. The error in the calculated density is comprised of high and low spatial frequency components. The high frequency component may arise from many sources, such as measurement error, computational error and/or atmospheric variability, and is somewhat random. Nonetheless, the error amplitude may be suppressed by statistical averaging. The low frequency component, however, including bias and linear variation, may be related to actual atmospheric features and is difficult to separate from the measurement error.

6.5 CALCULATION OF OTHER AEROLOGICAL VARIABLES

6.5.1 Pressure and density

Knowledge of the air temperature, given by the sensor as a function of height, enables atmospheric pressure and density at various levels to be determined. In a dry atmosphere with constant molecular weight, and making use of the hydrostatic equation:

$$dp = -g\rho dz \tag{6.8}$$

and the perfect gas law:

$$\rho = \frac{M}{R} \cdot \frac{p}{T} \tag{6.9}$$

the relationship between pressures p_i and p_{i-1} at the two levels z_i and z_{i-1} between which the temperature gradient is approximately constant may be expressed as:

$$p_i = a_i \cdot p_{i-1} \tag{6.10}$$

where:

$$a_i = \exp \left[\frac{-M}{RT_{i-1}} \cdot g_0 \left\{ \frac{r_T}{r_T + z_{i-1}} \right\}^2 \cdot \left\{ 1 - \frac{T_i - T_{i-1}}{2T_{i-1}} \right\} \{ z_i - z_{i-1} \} \right] \tag{6.11}$$

and g_0 is the acceleration due to gravity at sea level; M is the molecular weight of the air; p_i is the pressure at the upper level z_i ; p_{i-1} is the pressure at the lower level z_{i-1} ; r_T is the radius of the Earth; R is the gas constant (for a perfect gas); T_i is the temperature at the upper level z_i ; T_{i-1} is the temperature at the lower level z_{i-1} ; z_i is the upper level; and z_{i-1} is the lower level.

By comparison with a balloon-borne radiosonde from which a pressure value p is obtained, an initial pressure p_i may be determined for the rocket sounding at the common level z_i , which usually lies near 20 km, or approximately 50 hPa. Similarly, by using the perfect gas law (equation 6.9), the density profile ρ can be determined.

This method is based on step-by-step integration from the lower to the upper levels. It is, therefore, necessary to have very accurate height and temperature data for the various levels.

6.5.2 Speed of sound, thermal conductivity and viscosity

Using the basic data for pressure and temperature, other parameters, which are essential for elaborating simulation models, are often computed, such as the following:

(a) The speed of sound V_s :

$$V_s = \left(\gamma R \frac{T}{M} \right)^{\frac{1}{2}} \tag{6.12}$$

where $\gamma = C_p/C_v$;

(b) The coefficient of thermal conductivity, κ , of the air, expressed in $W m^{-1} K^{-1}$:

$$\kappa = \frac{2.6502 \cdot 10^{-3} \cdot T^{\frac{3}{2}}}{T + 2454 \cdot 10^{\frac{12}{T}}} \tag{6.13}$$

(c) The coefficient of viscosity of the air μ , expressed in $N s m^{-2}$:

$$\mu = \frac{1.458 \cdot 10^{-6} \cdot T^{\frac{3}{2}}}{T + 110.4} \tag{6.14}$$

6.6 NETWORKS AND COMPARISONS

At present, only one or two countries carry out regular soundings of the upper atmosphere. Reduction in operational requirements and the high costs associated with the launch operation tend to limit the number of stations and launching frequency.

These include a 20-channel high-resolution infrared radiation sounder (HIRS), a 4-channel microwave sounding unit (MSU), and a 3-channel infrared stratospheric sounding unit (SSU). The instrument characteristics of the TOVS are described in Table 8.3, which shows the number of channels; the nadir field of view; the aperture; viewing scan angle; swath width; the number of pixels viewed per swath (steps); and data digitization level, for four instruments carried on NOAA series polar-orbiting satellites. Comparable data for the AVHRR are also included for comparison.

Annexes 8.A and 8.B contain details of the AVHRR and HIRS channels and their applications. There are other instruments on the NOAA polar orbiters, including the solar backscatter ultraviolet (SBUV) and the Earth radiation budget experiment (ERBE) radiometers.

In mid-latitudes, a polar orbiter passes overhead twice daily. Selection of the time of day at which this occurs at each longitude involves optimizing the operation of instruments and reducing the times needed between observations and the delivery of data to forecast computer models.

The addition of a 20-channel microwave sounder, the advanced microwave sounding unit, beginning on NOAA-K, will greatly increase the data flow from the spacecraft. This, in turn, will force changes in the direct-broadcast services. Two other sensors with a total of seven channels, the MSU and the SSU, are to be eliminated at the same time.

8.2.3.2 Geostationary satellites

Imager

The radiometer used on United States geostationary satellites up to GOES-7 (all of which were stabilized by spinning) has a name that reflects its lineage; visible infrared spin-scan radiometer (VISSR) refers to its imaging channels. As the VISSR atmospheric sounder (VAS), it now includes 12 infrared channels. Eight parallel visible fields of view (0.55–0.75 μm) view the sunlit Earth with 1 km resolution.

Sounder

Twelve infrared channels observe upwelling terrestrial radiation in bands from 3.945 to 14.74 μm . Of these, two are window channels and observe the surface, seven observe radiation in the atmospheric carbon dioxide absorption bands, while the remaining three observe radiation in the water vapour bands. The selection of channels has the effect of

observing atmospheric radiation from varying heights within the atmosphere. Through a mathematical inversion process, an estimate of temperatures versus height in the lower atmosphere and stratosphere can be obtained. Another output is an estimate of atmospheric water vapour, in several deep layers.

The characteristics of the VAS/VISSR instrument are shown in Table 8.4, which provides details of the scans by GOES satellites, including nadir fields of view for visible and infrared channels; scan angles (at the spacecraft); the resulting swath width on the Earth's surface; the number of picture elements (pixels) per swath; and the digitization level for each pixel.

Ancillary sensors

Two additional systems for data collection are operational on the GOES satellites. Three sensors combine to form the space environment monitor. These report solar X-ray emission levels and monitor magnetic field strength and arrival rates for high-energy particles. A data-collection system receives radioed reports from Earth-located data-collection platforms and, via transponders, forwards these to a central processing facility. Platform operators may also receive their data by direct broadcast.

New systems

GOES-8, launched in 1994, has three-axis stabilization and no longer uses the VAS/VISSR system. It has an imager and a sounder similar in many respects to AVHRR and TOVS, respectively, but with higher horizontal resolution.

8.2.4 **Current operational meteorological and related satellite series**

For details of operational and experimental satellites see WMO (1994b). For convenience, a brief description is given here.

The World Weather Watch global observation satellite system is summarized in Figure 8.4. There are many other satellites for communication, environmental and military purposes, some of which also have meteorological applications.

The following are low orbiting satellites:

- (a) *TIROS-N/NOAA-A series*: The United States civil satellites. The system comprises at least two satellites, the latest of which is NOAA-12, launched in 1991. They provide image

Table 8.3. Instrument systems on NOAA satellites

<i>Instrument</i>	<i>Number of channels</i>	<i>Field of view (km)</i>	<i>Aperture (cm)</i>	<i>Scan angle (°)</i>	<i>Swath width (km)</i>	<i>Steps</i>	<i>Data (bits)</i>
SSU	3	147	8	±40	±736	8	12
MSU	4	105	—	±47.4	±1 174	11	12
HIRS	20	17	15	±49.5	±1 120	56	13

Table 8.4. Visible and infrared instrument systems on NOAA spin-scanning geostationary satellites

<i>Channel</i>	<i>Field of view (km)</i>	<i>Scan angle (°)</i>	<i>Swath width (km)</i>	<i>Pixels/Swath</i>	<i>Digits (bits)</i>
Visible	1	±8.70	±9 050	8 x 15 228	6
Infrared	7-14	±3.45	±2 226	3 822	10

services and carry instruments for temperature sounding as well as for data collection and data platform location. Some of the products of the systems are provided on the Global Telecommunication System (GTS);

- (b) *DMSP series*: the United States military satellites. These provide image and microwave sounding data, and the SSM/I instrument provides microwave imagery. Their real-time transmissions are encrypted, but can be made available for civil use;
- (c) *METEOR-2, the Russian series*: These provide image and sounding services, but lower quality infrared imagery. Limited data available on the GTS includes cloud images at southern polar latitudes;
- (d) *FY-1 series*: Launched by China, providing imaging services, with visible and infrared channels;
- (e) *SPOT*: A French satellite providing commercial high-resolution imaging services;
- (f) *ERS-1*: An experimental European Space Agency satellite providing sea-surface temperatures, surface wind and wave information and other oceanographic and environmental data, launched in 1991.

The following are geostationary satellites:

- (a) *GOES*: The United States satellites. At present the GOES series products include imagery, soundings and cloud motion data. When two satellites are available, they are usually located at 75°W and 135°W;

- (b) *GMS*: The Japanese satellites, providing a range of services similar to GOES, but with no soundings, operating at 140°E;
- (c) *METEOSAT*: The EUMETSAT satellites built by the European Space Agency, providing a range of services similar to GOES, operating at zero longitude;
- (d) *INSAT*: The Indian satellite with three-axis stabilization located at 74°E initially launched in 1989, providing imagery, but only cloud-drift winds are available on the GTS.

There are, therefore, effectively four geosynchronous satellites presently in operation.

8.3 METEOROLOGICAL OBSERVATIONS

8.3.1 Retrieval of geophysical quantities from radiance measurements

The quantity measured by the sensors on satellites is radiance in a number of defined spectral bands. The data are transmitted to ground stations and may be used to compile images, or quantitatively to calculate temperatures, concentrations of water vapour and other radiatively active gases, and other properties of the Earth's surface and atmosphere. The measurements taken may be at many levels, and from them profiles through the atmosphere may be constructed.

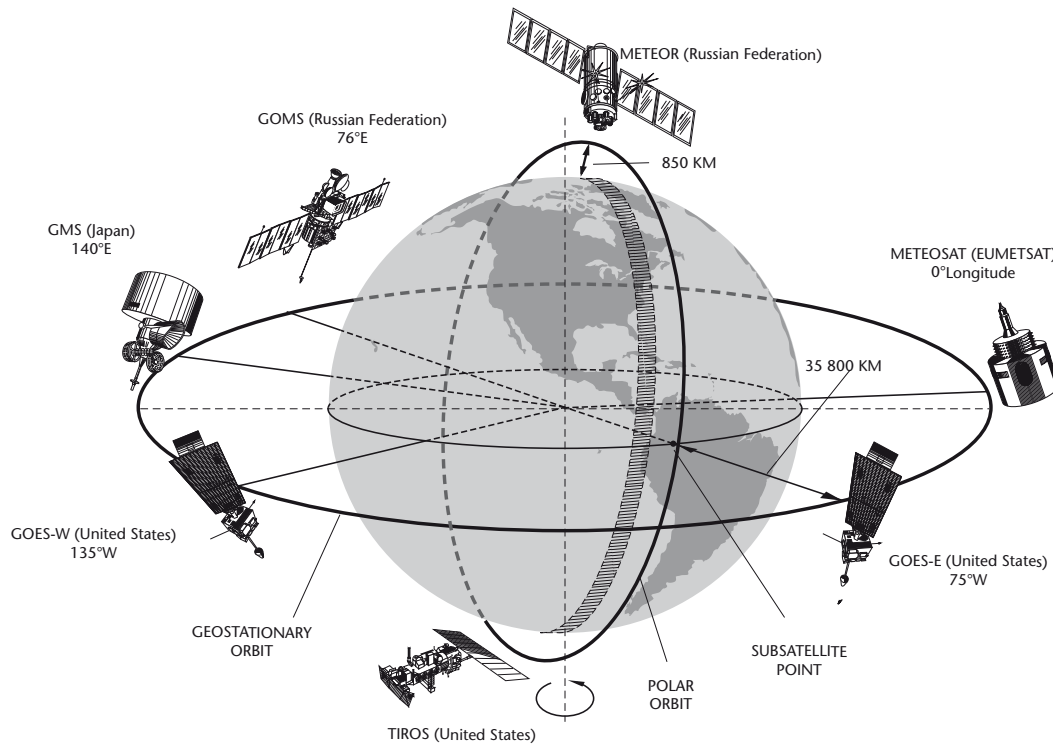

Figure 8.4. The World Weather Watch global observation satellite system

Conceptually, images are continuous two-dimensional distributions of brightness. It is this continuity that the brain seems so adept at handling. In practice, satellite images are arrangements of closely spaced picture elements (pixels), each with a particular brightness. When viewed at a suitable distance, they are indistinguishable from continuous functions. The eye and brain exploit the relative contrasts within scenes at various spatial frequencies, to identify positions and types of many weather phenomena.

It is usual to use the sounding data in numerical models, and hence, they, and most other quantitative data derived from the array of pixels, are often treated as point values.

The radiance data from the visible channels may be converted to brightness, or to the reflectance of the surface being observed. Data from the infrared channels may be converted to temperature, using the concept of brightness temperature (see section 8.3.1.1).

There are limits to both the amount and the quality of information that can be extracted from a field of radiances measured from a satellite. It is useful to consider an archetypal passive remote-sensing system to see where these limits arise. It is assumed that the surface

and atmosphere together reflect, or emit, or both, electromagnetic radiation towards the system. The physical processes may be summarized as follows.

The variations in reflected radiation are caused by:

- Sun elevation;
- Satellite-sun azimuth angle;
- Satellite viewing angle;
- Transparency of the object;
- Reflectivity of the underlying surface;
- The extent to which the object is filling the field of view;
- Overlying thin layers (thin clouds or aerosols).

Many clouds are far from plane parallel and horizontally homogeneous. It is also known, from the interpretation of common satellite images, that other factors of importance are:

- Sun-shadowing by higher objects;
- The shape of the object (the cloud topography) giving shades and shadows in the reflected light.

Variations in emitted radiation are mainly caused by:

- The satellite viewing angle;
- Temperature variations of the cloud;
- Temperature variations of the surface (below the cloud);

- (d) The temperature profile of the atmosphere;
- (e) Emissivity variations of the cloud;
- (f) Emissivity variations of the surface;
- (g) Variations within the field of view of the satellite instrument;
- (h) The composition of the atmosphere between the object and the satellite (water vapour, carbon dioxide, ozone, thin clouds, aerosols, etc.).

Essentially, the system consists of optics to collect the radiation, a detector to determine how much there is, some telecommunications equipment to digitize this quantity (conversion into counts) and transmit it to the ground, some more equipment to receive the information and decode it into something useful, and a device to display the information. At each stage, potentially useful information about a scene being viewed is lost. This arises as a consequence of a series of digitization processes that transform the continuous scene. These include resolutions in space, wavelength and radiometric product, as discussed in section 8.3.1.2.

8.3.1.1 Radiance and brightness temperature

Emission from a black body

A black body absorbs all radiation which falls upon it. In general, a body absorbs only a fraction of incident radiation; the fraction is known as the absorptivity, and it is wavelength dependent. Similarly, the efficiency for emission is known as the emissivity. At a given wavelength:

$$\text{emissivity} = \text{absorptivity} \tag{8.5}$$

This is Kirchhoff's law.

The radiance (power per unit area per steradian) per unit wavelength interval emitted by a black body at temperature T and at wavelength λ is given by:

$$B_{\lambda}(T) = \frac{2hc^2\lambda^{-5}}{\exp(hc/k\lambda T) - 1} \tag{8.6}$$

where B_{λ} ($\text{W m}^{-2} \text{sr}^{-1} \text{cm}^{-1}$) and its equivalent in wave number units, B_{ν} ($\text{W m}^{-2} \text{sr}^{-1} \text{cm}$), are known as the Planck function. c , h and k are the speed of light, the Planck constant, and the Boltzmann constant, respectively. The following laws can be derived from equation 8.6.

B_{λ} peaks at wavelength λ_m given by:

$$\lambda_m T = 0.29 \text{ deg.cm} \tag{8.7}$$

This is Wien's law. For the sun, T is 6 000 K and λ_m is 0.48μ . For the Earth, T is 290 K and λ_m is 10μ .

The total flux emitted by a black body is:

$$E = \int B_{\lambda} d\lambda = \sigma T^4 \tag{8.8}$$

Where σ is Stefan's constant. B is proportional to T at microwave and far infrared wavelengths (the Rayleigh-Jeans part of the spectrum). The typical dependence of B on T for λ at or below λ_m is shown in Figure 8.5.

If radiance in a narrow wavelength band is measured, the Planck function can be used to calculate the temperature of the black body that emitted it:

$$T_{\lambda} = \frac{c_2}{\lambda \ln \left[\frac{c_1}{\lambda^5 B_{\lambda}} + 1 \right]} \tag{8.9}$$

where c_1 and c_2 are derived constants. This is known as the brightness temperature, and for most purposes the radiances transmitted from the satellite are converted to these quantities T_{λ} .

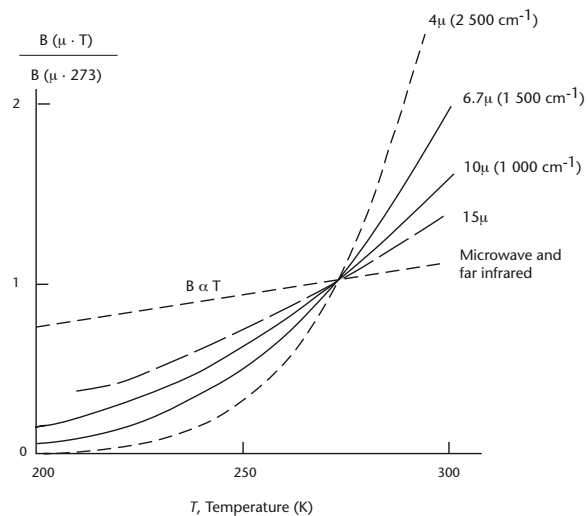

Figure 8.5. Temperature dependence of the Planck function

Atmospheric absorption

Atmospheric absorption in the infrared is dominated by absorption bands of water, carbon dioxide, ozone, and so on. Examination of radiation within these bands enables the characteristics of the atmosphere to be determined: its temperature and the concentration of the absorbers. However, there are regions of the spectrum where absorption is low, providing the possibility for a satellite sensor to view the surface or

cloud top and to determine its temperature or other characteristics. Such spectral regions are called “windows”. There is a particularly important window near the peak of the Earth/atmosphere emission curve, around $11 \mu\text{m}$ (see Figure 8.3).

8.3.1.2 Resolution

Spatial resolution

The continuous nature of the scene is divided into a number of discrete picture elements or pixels that are governed by the size of the optics, the integration time of the detectors and possibly by subsequent sampling. The size of the object that can be resolved in the displayed image depends upon the size of these pixels.

Owing to the effects of diffraction by elements of the optical system, the focused image of a distant point object in the scene has a characteristic angular distribution known as a point spread function or airy pattern (Figure 8.6(a)). Two distant point objects that are displaced within the field of view are considered separable (i.e. the Rayleigh criterion) if the angle between the maxima of their point spread functions is greater than λ/D , where λ is the wavelength of the radiation and D is the diameter of the beam (Figure 8.6(b)).

However, if these two point spread functions are close enough to be focused on the same detector, they cannot be resolved. In many remote-sensing systems, it is the effective displacement of adjacent detectors that limits the spatial resolution. Only if they are close together, as in Figure 8.6(c), can the two objects be resolved. A general method of determining the resolution of the optical system is by computing or measuring its modulation transfer function. The modulation of a sinusoidal function is the ratio of half its peak-to-peak amplitude to its mean value. The modulation transfer function is derived by evaluating the ratio of the output to input modulations as a function of the wavelength (or spatial frequency) of the sinusoid.

In practice, many space-borne systems use the motion of the satellite to extend the image along its track, and moving mirrors to build up the picture across the track. In such systems, the focused image of the viewed objects is scanned across a detector. The output from the detector is integrated over short periods to achieve the separation of objects. The value obtained for each integration is a complicated convolution of the point-spread functions of every

object within the scene with the spatial response of the detector and the time of each integration.

An alternative to scanning by moving mirrors is the use of linear arrays of detectors. With no moving parts, they are much more reliable than mirrors; however, they introduce problems in the intercalibration of the different detectors.

Radiometric resolution

The instantaneous scene is focused by the optics onto a detector which responds to the irradiance upon it. The response can either be through a direct effect on the electronic energy levels within the detector (quantum detection) or through the radiation being absorbed, warming the detector and changing some characteristic of it, such as resistance (thermal detection). Voltages caused by a number of extraneous sources are also detected, including those due to the following:

- The thermal motion of electrons within the detector (Johnson noise);
- Surface irregularities and electrical contacts;
- The quantum nature of electrical currents (shot noise).

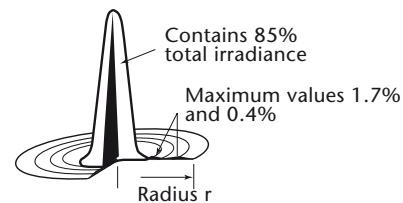

(a) The irradiance profile of the airy diffraction pattern

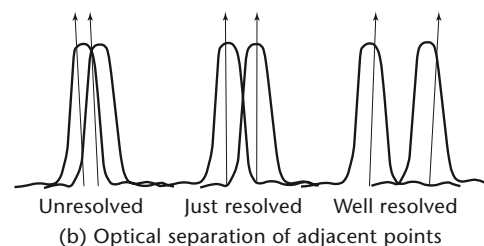

(b) Optical separation of adjacent points

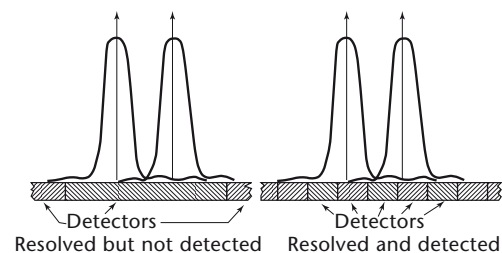

Figure 8.6. Optical resolution

To increase the signal to noise ratio, the system can be provided with large collecting optics, cooled detectors and long detector integration times. The combination of signal and noise voltages (an analogue signal) is integrated in time to produce a digital value. The sequence of integrated values corresponding to each line of the scene has then to be encoded and transmitted to the ground. Having received the data, decoded and processed them into useful products, the images can be displayed on a suitable device. Usually, this involves representing each pixel value as a suitable colour on a monitor or shade of grey on a facsimile recorder.

Display resolution

Thus, the continuous observed scene has been transformed into discrete pixels on a monitor. The discrete nature of the image is only noticeable when the resolutions of the image and the display device are grossly mismatched. The pixels on a typical monitor are separated by approximately 0.3 mm. Each pixel itself comprises three dots of different coloured phosphors. At a reasonable viewing distance of 75 cm, the eye can only resolve the pixels if they have high contrast. Note that the resolution of the eye, about 0.2 mrad, is limited by the separation of the photo-sensitive cells in the retina.

The last part of the system involves the interpretive skills of the forecaster, who uses the images to obtain information about weather systems.

8.3.1.3 Calibration

Calibration of the visible channels

The two visible channels on the AVHRR instrument are calibrated before launch. Radiances measured by the two channels are calculated from:

$$L_i = A_i S_i \tag{8.10}$$

and

$$A_i = G_i X_i + I_i \tag{8.11}$$

where i is the channel number; L is radiance ($W\ m^{-2}\ sr^{-1}$); X is the digital count (10 bits); G is the calibration gain (slope); I is the calibration intercept; A is equivalent albedo; and S is equivalent solar radiance, computed from the solar constant and the spectral response of each channel.

G and I are measured before launch. Equivalent albedo, A , is the percentage of the incoming top of the atmosphere solar radiance (with the sun in

zenith) that is reflected and measured by the satellite radiometer in the spectral interval valid for each channel. Atmospheric absorption and scattering effects are neglected. The term equivalent albedo is used here to indicate that it is not a strictly true albedo value due to the fact that measurements are taken in a limited spectral interval and that the values are not corrected for atmospheric effects.

To calculate the reflectance of each pixel (considering the dependence of varying solar zenith angle, varying satellite zenith angle and varying sun-satellite azimuth angle), the concept of bidirectional reflectance may be applied:

$$R_i(\mu_0, \mu, \phi) = A_i / \mu_0 \tag{8.12}$$

where R_i is bidirectional reflectance; μ_0 is the cosine of the solar zenith angle; μ is the cosine of the satellite zenith angle; and ϕ is the sun-satellite azimuth angle.

One disadvantage of a fixed pre-launch calibration algorithm is that conditions in the satellite orbit could be considerably different from ground conditions, thus leading to incorrect albedo values. The effects of radiometer degradations with time can also seriously affect the calibration. Both effects have been observed for earlier satellites. Also, changes in calibration techniques and coefficients from one satellite to the next in the series need attention by the user. The conclusion is that, until an on-board calibration technique can be realized, radiometer data from the visible channels have to be examined carefully to discover discrepancies from the nominal calibration algorithms.

Calibration of infrared channels

Unlike the visible channels, the infrared channels are calibrated continuously on board the satellite. A linear relation is established between the radiometer digital counts and radiance. The calibration coefficients may be estimated for every scan line by using two reference measurements. A cold reference point is obtained by viewing space which acts as a black body at about 3 K, essentially a zero radiance source. The other reference point is obtained from an internal black body, the temperature of which is monitored. The Planck function (see section 8.3.2) then gives the radiance ($W\ m^{-2}\ sr^{-1}$) at each wavelength. A linear relationship between radiance and digital counts derived from the fixed points is used. A small non-linear correction is also applied.

Difficulties of various sorts may arise. For example, during some autumn months, the calibration of NOAA-10 channel 3 data has suffered from

serious errors (giving temperatures too high). Although the reason for this is not clear, it may be caused by conditions when the satellite in the ascending node turns from illuminated to dark conditions. Rapid changes of internal black body temperatures could then occur and the application of a constant calibration algorithm may be incorrect.

Calibration of HIRS and MSU

For HIRS (see Annex 8.B), calibration measurements are taken every 40 scan lines and occupy 3 scan lines (for which no Earth-view data are available). The procedure is essentially the same as for the AVHRR, using the two known temperatures. For MSU (see Annex 8.B), the calibration sequence takes place at the end of each scan line and so that no Earth view data are lost. Again, a two-point calibration is provided from warm and cold reference sources. However, for MSU channel frequencies and typical Earth-view temperatures, the measured radiances are in the Rayleigh-Jeans tail of the Planck function, where radiance is proportional to brightness temperature. Therefore, the data may be calibrated into brightness temperature directly (see section 8.3.2).

8.3.1.4 Digitization

The digitization of the radiance provides a number of discrete values separated by constant steps. The temperature differences corresponding to these steps in radiance define the quanta of temperature in the final image. Owing to the non-linearity of the black-body function with temperature, the size of these steps depends upon the temperature. AVHRR data are digitized using 10 bits, thereby providing 1 024 different values. For the thermal infrared channels, the temperature step at 300 K is about 0.1 K, but it is 0.3 K at 220 K.

Other systems are digitized using different numbers of bits. The infrared images for METEOSAT use 8 bits, but the visible and water-vapour channels have only 6 significant bits. Interestingly, tests have demonstrated that a monochrome satellite image can be displayed without serious degradation using the equivalent of only 5 bits.

8.3.1.5 Remapping

The requirements for the rapid processing of large amounts of data are best met by using digital computers. In an operational system, the most intensive computational task is to change

the projection in which the image is displayed. This is necessary partly because of the distortions arising from viewing the curved Earth using a scanning mirror, and partly because of the need to use images in conjunction with other meteorological data on standard chart backgrounds. A key element in the process of remapping the image as seen from space ("space-view"), to fit the required projection, is knowing the position on the Earth of each pixel ("navigation"). This is achieved by knowing the orbital characteristics of the satellite (supplied by the satellite operator), the precise time at which each line of the image was recorded, and the geometry of the scan.

In practice, the remapping is carried out as follows. The position within the space-view scene that corresponds to the centre of each pixel in the final reprojected image is located, using the orbital data and the geometry of the final projection. The values of the pixels at, and in the locality of, this point are used to compute a new value. Effectively, this is a weighted average of the nearby values and is assigned to the pixel in the final image.

Many sophisticated methods have been studied to perform this weighted average. Most are not applicable to near-real-time applications due to the large amount of computing effort required. However, the increasing availability of parallel processing computing is expected to change this position.

8.3.2 Vertical profiles of temperature and humidity

8.3.2.1 The TIROS operational vertical sounder system

The TIROS-N/NOAA-A series of satellites carry the TOVS system, including the HIRS and MSU instruments. They observe radiation upwelling from the Earth and atmosphere, which is given by the radiative transfer equation (RTE):

$$L_{\lambda} = B_{\lambda}(T(P_s))\tau_{\lambda}(P_s) + \int_{p_s}^0 B_{\lambda}(T(p))\frac{d\tau_{\lambda}(p)}{dp} dp \quad (8.13)$$

where B is the Planck function at wavelength λ ; L_{λ} is the upwelling irradiance; $T(p)$ is the temperature as a function of pressure p ; p_s is the surface pressure; and τ_{λ} is the transmittance.

The first term is the contribution from the Earth's surface and the second the radiation from the atmosphere; $d\tau_x/dp$ is called the weighting function.

The solution of the RTE is the basis of atmospheric sounding. The upwelling irradiance at the top of the atmosphere arises from a combination of the Planck function and the spectral transmittance. The Planck function conveys temperature information; the transmittance is associated with the absorption and density profile of radiatively active gases; and the weighting function contains profile information. For different wavelengths, the weighting function will peak at different altitudes. Temperature soundings may be constructed if a set of wavelength intervals can be chosen such that the corresponding radiances originate to a significant extent from different layers in the atmosphere. Figure 8.7 shows typical weighting functions which have been used for processing data from HIRS.

The solution of the RTE is very complex, mainly because of the overlap in the weighting functions shown in Figure 8.7. A number of different methods have been developed to derive temperature and humidity profiles. A general account of several methods is given by Smith (1985), and develop-

ments are reported in the successive reports of the TOVS Study Conferences (CIMSS, 1991).

Early methods which were widely used were based on regressions between radiances and ground truth (from radiosondes), under various atmospheric conditions. Better results are obtained from solutions of the RTE, described as physical retrievals.

The basic principle by which water vapour concentration is calculated is illustrated by a procedure used in some physical retrieval schemes. The temperature profile is calculated using wavelengths in which carbon dioxide emits, and it is also calculated using wavelengths in which water vapour emits, with an assumed vertical distribution of water vapour. The difference between the two temperature profiles is due to the difference between the assumed and the actual water vapour profiles, and the actual profile may therefore be deduced.

In most Meteorological Services, the retrieval of geophysical quantities for use in numerical weather prediction is carried out by using physical methods. At NOAA, data are retrieved by obtaining a first guess using a library search method followed by a full physical retrieval based

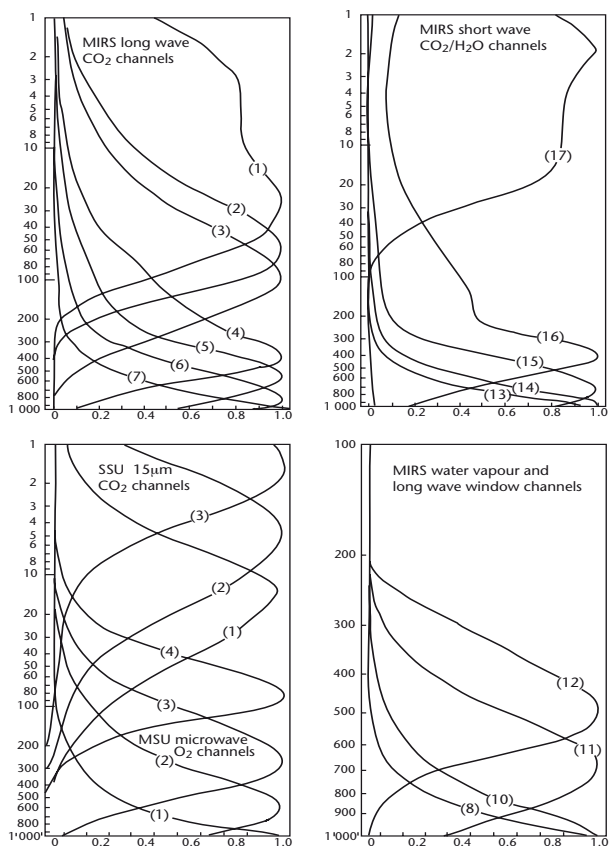

Figure 8.7. TOVS weighting functions (normalized)

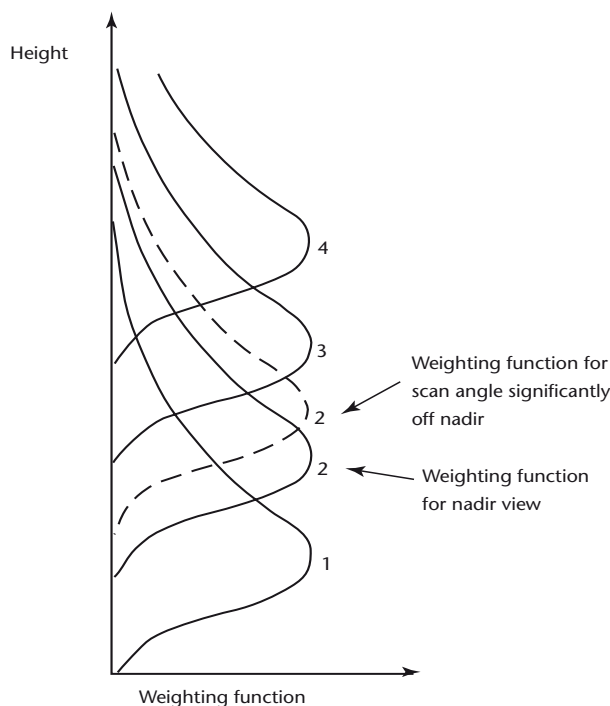

Figure 8.8. Schematic illustration of a group of weighting functions for nadir viewing and the effect of scanning off nadir on one of these functions

on a solution of the RTE. Other Services, such as the UK Met Office and the Australian Bureau of Meteorology, use a numerical model first guess followed by a full solution of the RTE.

The latest development is a trend towards a variational solution of the RTE in the presence of all other data available at the time of analysis. This can be extended to four dimensions to allow asynoptic data to contribute over a suitable period.

It is necessary for all methods to identify and use pixels with no cloud, or to allow for the effects of cloud. Procedures for this are described in section 8.3.3.

8.3.2.2 The limb effect

The limb effect is illustrated in Figure 8.8. As the angle of view moves away from the vertical, the path length of the radiation through the atmosphere increases. Therefore, the transmittances from all levels to space decrease and the peak of the weighting function rises. If the channel senses radiation from an atmospheric layer in which there is a temperature lapse rate, the measured radiance will change; for tropospheric channels it will tend to decrease. It is, therefore, necessary for some applications to convert the measured radiances to estimate the brightness temperature that would have been measured if the instrument had viewed the same volume vertically. The limb-correction method may be applied, or a physical retrieval method.

Limb corrections are applied to brightness temperatures measured at non-zero nadir angle. They are possible because the weighting function of the nadir view for one channel will, in general, peak at a level intermediate between the weighting function peaks of two channels at the angle of measurement. Thus, for a given angle, θ , the difference between the brightness temperature at nadir and at the angle of measurement may be expressed as a linear combination of the measured brightness temperatures in a number of channels:

$$(T_B)_i^{\theta=0} - (T_B)_i^{\theta} = a_{0i}^{\theta} + \sum_{j=1}^1 a_{ji}^{\theta} (T_B)_j^{\theta} \quad (8.14)$$

The coefficient a_{ji}^{θ} is found by multiple linear regression on synthetic brightness temperatures computed for a representative set of profiles.

It is possible to remove the need for a limb correction. For example, a temperature retrieval algorithm may be used with a different set of regression coefficients

for each scan angle. However, if a regression retrieval is performed in which one set of coefficients (appropriate to a zero scan angle) is used, all brightness temperatures must be converted to the same angle of view, usually the nadir.

The weakness of the regression approach to the limb effect is the difficulty of developing regressions for different cloud, temperature and moisture regimes. A better approach, which has now become operational in some centres, is to use the physical retrieval method in which the radiative transfer equation is solved for every scan angle at which measurements are required.

Limb scanning for soundings

Operational meteorological sounders look straight down from the satellite to the Earth's surface, but an alternative approach is to look at the Earth's limb. The weighting functions are very sharp for limb-scanning sensors and always peak at the highest pressure in the field of view. Hence, good vertical resolution (1 km) is obtained with a horizontal resolution of around 10 km. Somewhat poorer resolutions are available with vertical sounding, although it is not possible to make measurements lower than about 15 km altitude with limb-sounding techniques, and therefore vertical sounding is necessary for tropospheric measurements.

8.3.2.3 Resolution and accuracy

The accuracy of satellite retrievals is difficult to assess. As with many other observing systems, there is the problem of determining "what is truth?" A widely used method of assessing accuracy is the study of statistics of differences between retrievals and collocated radiosonde profiles. Such statistics will include the retrieval errors and will also contain contributions from radiosonde errors (which include the effects of both discrepancies from the true profile along the radiosonde ascent path and the degree to which this profile is representative of the surrounding volume of atmosphere) and collocation errors caused by the separation in space and time between the satellite sounding and the radiosonde ascent. Although retrieval-radiosonde collocation statistics are very useful, they should not be treated simply as measurements of retrieval error.

Brightness temperatures

It is important to note the strong non-linearity in the equations converting radiances to brightness temperatures. This means that, when dealing

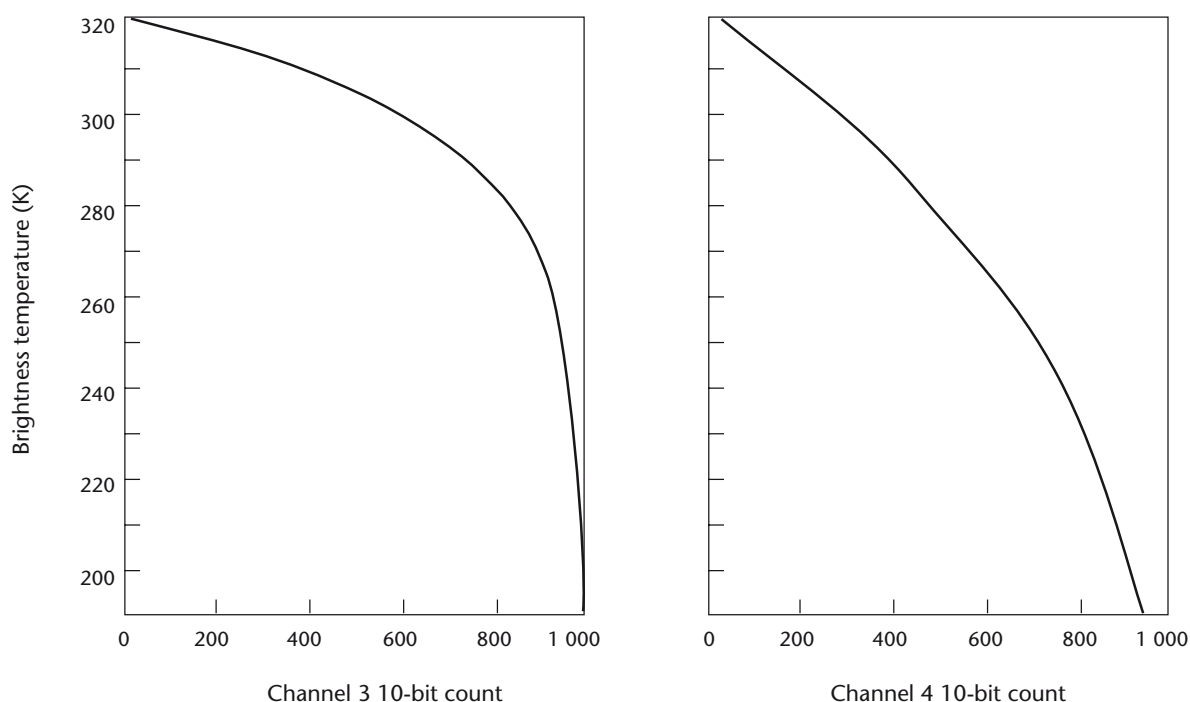

Figure 8.9. Typical calibration curves for AVHRR channels 3 and 4 digital counts to brightness temperatures. The curve for AVHRR channel 5 is very similar to the curve for AVHRR channel 4.

with brightness temperatures, the true temperature measurement accuracy of the radiometer varies with the temperature. This is not the case when handling radiances as these are linearly related to the radiometer counts. In the AVHRR, all three infrared channels have rapidly decreasing accuracy for lower temperatures. This can be seen in Figure 8.9 (which shows only two channels).

Table 8.5. Uncertainty (K) of AVHRR IR channels

Temperature (K)	Channel 3	Channel 4
200	~10	~0.3
220	2.5	0.22
270	0.18	0.10
320	0.03	0.06

Comparisons of measurement accuracies for channel 3 (Annex 8.A) and channel 4 show some differences. When treating 10-bit values, the uncertainties are as shown in Table 8.5. Channel 3 shows a stronger non-linearity than channel 4 leading to much lower accuracies for low temperatures than

channel 4. Channel 5 is very similar to channel 4. Channel 3 is much less accurate at low temperatures, but better than channel 4, at temperatures higher than 290 K.

Soundings

Figure 8.10 shows typical difference statistics from the UK Met Office retrieval system. The bias and standard deviation profiles for retrieval-radiosonde differences are shown. These are based on all collocations obtained from NOAA-11 retrievals during July 1991, with collocation criteria of 3 h time separation and 150 km horizontal separation. If the set of profiles in the collocations is large, and both are representative of the same population, the biases in these statistics should be very small. The biases found, about 1° at some pressure levels, are to be expected here, where collocations for a limited period and limited area may not be representative of a zonal set. The standard deviations, while they are larger than the equivalent values for retrieval errors alone, exhibit some of the expected characteristics of the retrieval error profile. They have a minimum in the mid-troposphere, with higher values near the surface and the tropopause. The lower tropospheric values reflect problems

associated with residual cloud contamination and various surface effects. Low-level inversions will also tend to cause retrieval problems. The tropopause values reflect both the lack of information in the radiances from this part of the profile, as well as the tendency of the retrieval method to smooth out features of this type.

Resolution

The field of view of the HIRS radiometer (Table 8.3) is about 17 km at the subsatellite point, and profile calculations can be made out to the edge of the swath, where the field is elliptical with an axis of about 55 km. Profiles can be calculated at any horizontal grid size, but they are not independent if they are closer than the field of view.

Temperature soundings are calculated down to the cloud top, or to the surface if the MSU instrument is used. Over land and close to the coast, the horizontal variability of temperature and emissivity cause uncertainties which limit their use in numerical models below about 500 hPa.

The vertical resolution of the observations is related to the weighting functions, and is typically about 3 km. This poor vertical resolution is one of the main shortcomings of the present sounding system for numerical weather prediction, and it will be improved in the next generation of sounding instruments, such as the atmospheric infrared sounder (AIRS) and the high-resolution interferometer sounder (HIS).

8.3.3 **Cloud and land surface characteristics and cloud clearing**

8.3.3.1 **Cloud and land surface observations**

The scheme developed at the UK Met Office is typical of those that may be used to extract information about clouds and the surface. It applies a succession of tests to each pixel within a scene in attempts to identify cloud. The first is a threshold test in the infrared; essentially, any pixels colder than a specified temperature are deemed to contain cloud.

The second test looks at the local variance of temperatures within an image. High values indicate either mixtures of clear and cloudy pixels or those containing clouds at different levels. Small values at low temperatures indicate fully cloudy pixels.

The brightness temperatures of an object in different channels depend upon the variations with wavelength, the emissivity of the object and the

attenuation of radiation by the atmosphere. For thin clouds, temperatures in AVHRR channels 3 ($3.7 \mu\text{m}$) (Annex 8.A) are warmer than those in channel 4 ($11 \mu\text{m}$) (see Figure 8.11(a)). The converse is true for thick low cloud, this being the basis of the fog detection scheme described by Eyre, Brownscombe and Allam (1984) (see Figure 8.11(b)). The difference between AVHRR channels 4 and 5 ($11 \mu\text{m}$ and $12 \mu\text{m}$) is sensitive to the thickness of cloud and to the water vapour content of the atmosphere. A threshold applied to this difference facilitates the detection of thin cirrus.

During the day, reflected solar radiation, adjusted to eliminate the effects of variations of solar elevation, can also be used. A threshold test separates bright cloud from dark surfaces. A fourth test uses the ratio for the radiance of the near infrared channel 2 ($0.9 \mu\text{m}$) to that of the visible channel 1 ($0.6 \mu\text{m}$). This ratio has a value that is:

- (a) Close to unity for clouds;
- (b) About 0.5 for water, due to the enhanced back-scattering by aerosols at short wavelengths;
- (c) About 1.5 for land, and particularly growing vegetation, due to the high reflectance of leafy structures in the near infrared.

Having detected the location of the pixels uncontaminated by cloud using these methods, it is possible to determine some surface parameters. Of these, the most important is sea-surface temperature (section 8.3.6). Land surfaces have highly variable emissivities that make calculations very uncertain.

Cloud parameters can be extracted using extensions to the series of tests outlined previously. These include cloud-top temperatures, fractional cloud cover and optical thickness.

The height of the cloud top may be calculated in several ways. The simplest method is to use brightness temperatures from one or more channels to calculate cloud-top temperature, and infer the height from a temperature profile, usually derived from a numerical model. This method works well for heavy stratiform and cumulus cloud fields, but not for semi-transparent clouds such as cirrus, or for fields of small cumulus clouds. Smith and Platt (1978) showed how to use the radiative transfer equation in close pairs of HIRS channels to calculate pressure and, hence, the height of the tops of scattered or thin cloud, with errors typically between half and a quarter of the cloud thickness of semi-transparent layers.

It should be stressed that such products can be derived only from data streams that contain precise calibration data.

These data can only be considered as images when they are displayed on a suitable device. Although in some cases they are derived to be used as input variables for mesoscale numerical models, much useful information can be gained through viewing them. Various combinations of radiometer channels are used to define particular types of clouds, snow and vegetation, as shown for example in Figure 8.12.

8.3.3.2 Soundings of the TIROS operational vertical sounder in the presence of cloud

Cloud clearing

Infrared radiances are affected markedly by the presence of clouds, since most are almost opaque in this wavelength region. Consequently, the algorithms used in the retrieval of tropospheric temperature must be able to detect clouds which have a significant effect on the radiances and, if possible, make allowances for these effects. This is usually done by

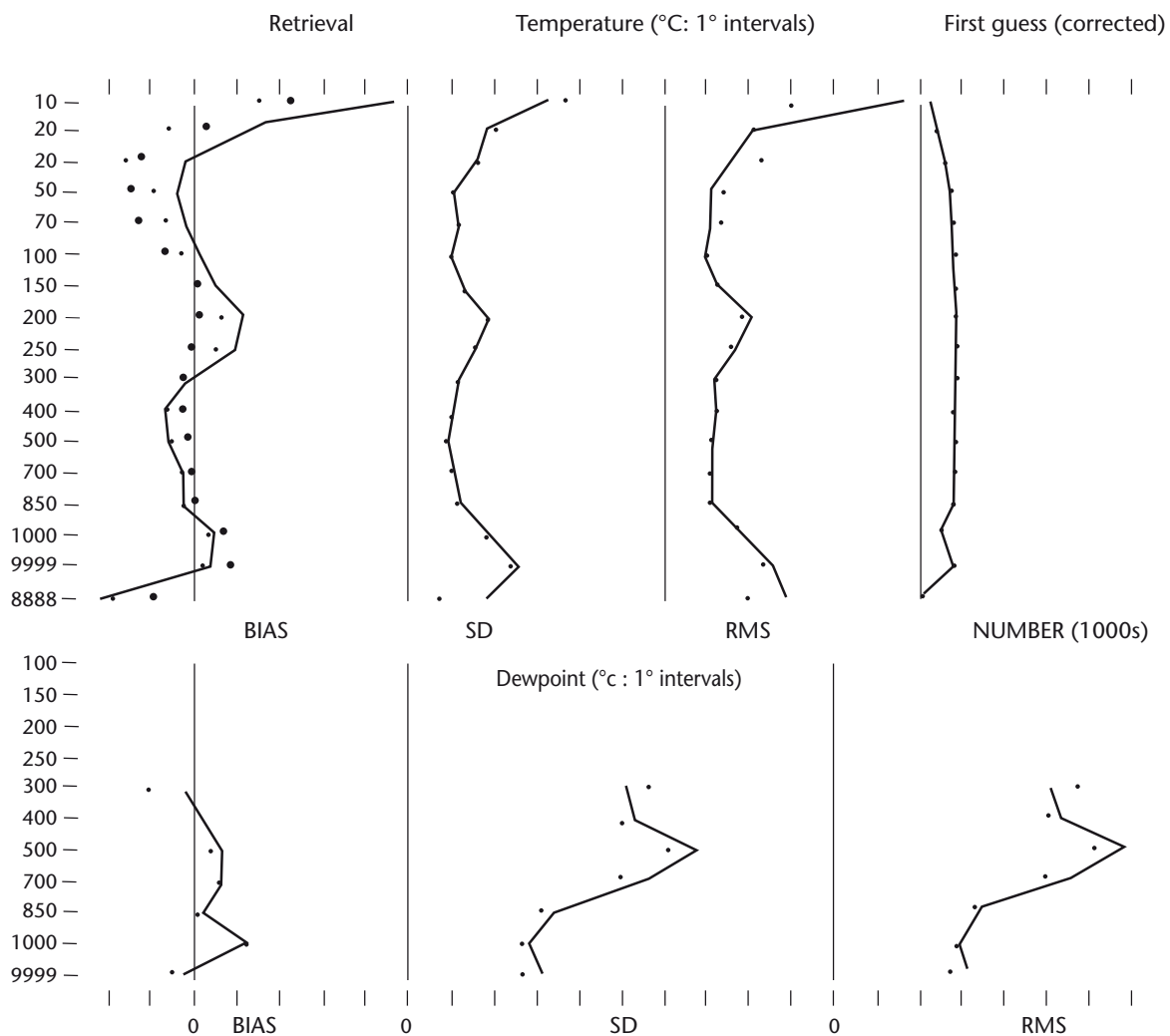

• Forecast bias correction (added)

8888 T8; 9999-1.5 m; All scan pos; No routes 1+2; All times; All surfaces (land + sea); BTRP > =-300; Elev < = 500 m; Col dist 0-150 km. Total profiles 9856; Sonde NOK 2122; BTRP NOK 1; Route NOK 166; Elev NOK 794.

Figure 8.10. Error statistics for vertical profiles (UK Met Office)

correcting the measured radiances to obtain “clear-column” values, namely, the radiances which would be measured from the same temperature and humidity profiles in the absence of cloud. In many retrieval schemes, the inversion process converts clear-column radiances to atmosphere parameters, and so a preliminary cloud-clearing step is required.

Many of the algorithms developed are variants of the adjacent field of view or N^* method (Smith, 1985). In this approach, the measured radiances, R_1

and R_2 , in two adjacent fields of view (hereafter referred to as “spots”) of a radiometer channel can, under certain conditions, be expressed as follows:

$$R_1 = N_1 R_{cloudy} + (1 - N_1) R_{clear}$$

$$R_2 = N_2 R_{cloudy} + (1 - N_2) R_{clear} \quad (8.15)$$

where R_{clear} and R_{cloudy} are the radiances appropriate to clear and completely overcast conditions, respectively; and N_1 and N_2 are the effective fractional

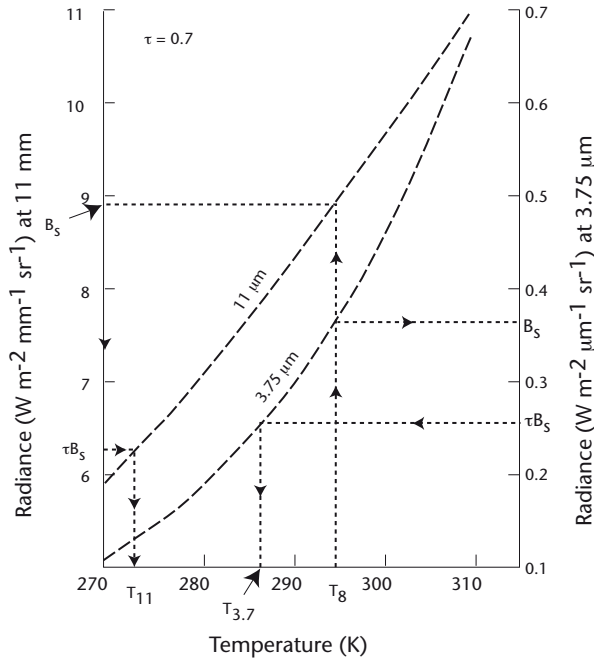

(a) The effect of semi-transparent cloud on radiances.

Surface radiance B_s is reduced by semi-transparent cloud to τB_s . Temperature corresponding to τB_s is higher for $3.7 \mu\text{m}$ than for $11 \mu\text{m}$.

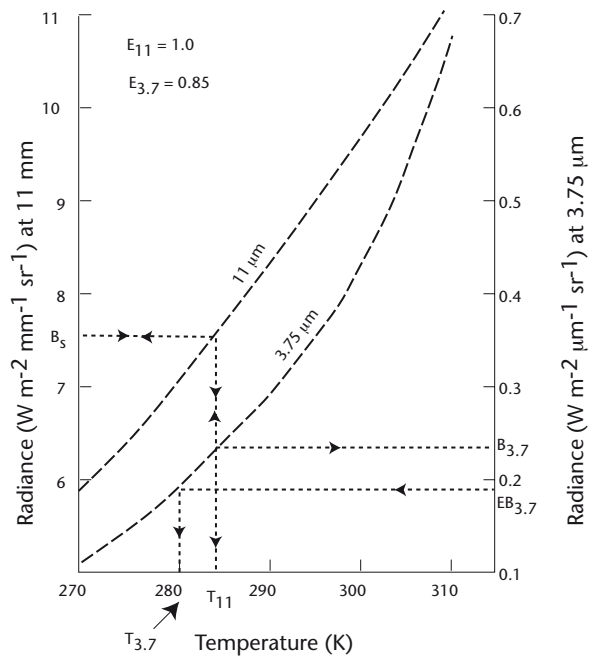

(b) The effect of different emissivity on radiances.

Radiance received at satellite, B_{sat} , is:

$$B_{sat} = E B(T_s)$$

where E is emissivity; B is black-body function; and T_s is surface temperature.

For low cloud and fog;

$$E_{11 \mu\text{m}} \approx 1.0$$

$$E_{3.7 \mu\text{m}} \approx 0.85$$

The temperature corresponding to $E B(T_s)$ is higher for $11 \mu\text{m}$ than for $3.7 \mu\text{m}$.

Figure 8.11. Calculation of temperature in the presence of clouds

cloud coverages in spots 1 and 2. In deriving these equations, the following assumptions have been made:

- (a) That the atmospheric profile and surface characteristics in the two spots are the same;
- (b) That only one layer of cloud is present;
- (c) That the cloud top has the same height (and temperature) in both spots.

If the fractional cloud coverages in the two spots are different ($N_1 \neq N_2$), equation 8.15 may be solved simultaneously to give the clear radiance:

$$R_{clear} = \frac{R_1 N^* R_2}{1 - N^*} \quad (8.16)$$

where $N^* = N_1/N_2$.

This method has been considerably elaborated, using HIRS and MSU channels, the horizontal resolution of which is the sufficient for the assumptions to hold true sufficiently often. In this method, regression between co-located measurements in the MSU2 channel and the HIRS channels is used, and the coefficients are updated regularly, usually on a weekly basis.

Newer methods are now being applied, using AVHRR data to help clear the HIRS field of view. Furthermore, full physical retrieval methods are possible, using AVHRR and TOVS data, in which the fractional cloud cover and cloud height and amount can be explicitly computed from the observed radiances.

8.3.4 Wind measurements

8.3.4.1 Cloud drift winds

Cloud drift winds are produced from geostationary satellite images by tracking cloud tops, usually for two half-hour periods between successive infrared images. The accuracy of the winds is limited to the extent that cloud motion represents the wind (for example a convective cloud cluster may move with the speed of a mesoscale atmospheric disturbance, and not with the speed of an identifiable wind). It also depends on the extent to which a representative cloud height can be determined from the brightness temperature field. In addition, the accuracy of the winds is dependent on the time interval and, to a limited extent, on the correlations between the cloud images used in their calculation, the spatial resolution of these images, the error in the first-guess fields, the degree to which the first-guess field limits the search for correlated patterns in sequential images, and the amount of development taking place in the clouds.

Mean vector differences between cloud drift winds and winds measured by wind-finding radars within 100 nm were typically 3, 5 and 7 m s⁻¹ for low, middle and high clouds, respectively, for one month. These indicate that the errors are comparable at low levels with those for conventional measurements.

The wind estimation process is typically fully automatic. Target cloud areas covering about 20 × 20 pixels are chosen from half-hourly images using criteria which include a suitable range of brightness temperatures and gradients within each trial area. Once the targets have been selected, auto-tracking is performed, using typically a 6 or 12 h numerical prognosis as a first-guess field to search for well-correlated target areas. Root-mean-square differences may be used to compare the arrays of brightness temperatures of the target and search areas in order to estimate motion. The first guess reduces the size of the search area that is necessary to obtain the wind vector, but it also constrains the results to lie within a certain range of the forecast wind field.

Error flags are assigned to each measurement on the basis of several characteristics, including the differences between the successive half-hour vectors and the difference between the measurement and the first-guess field. These error flags can be used in numerical analysis to give appropriate weight to the data.

The number of measurements for each synoptic hour is, of course, limited by the existence of suitable clouds and is typically of the order of 600 vectors per hemisphere.

At high latitudes, sequential images from polar-orbiting satellites can be used to produce cloud motion vectors in the latitudes not reached by the geostationary satellites.

A further development of the same technique is to calculate water vapour winds, using satellite images of the water vapour distribution.

8.3.4.2 Scatterometer surface winds

The scatterometer is an instrument on the experimental ERS-1 satellite, which produces routine wind measurements over the sea surface. The technique will become operational on satellites now being prepared.

As soon as microwave radar became widely used in the 1940s, it was found that at low elevation angles, surrounding terrain (or at sea, waves) caused large,

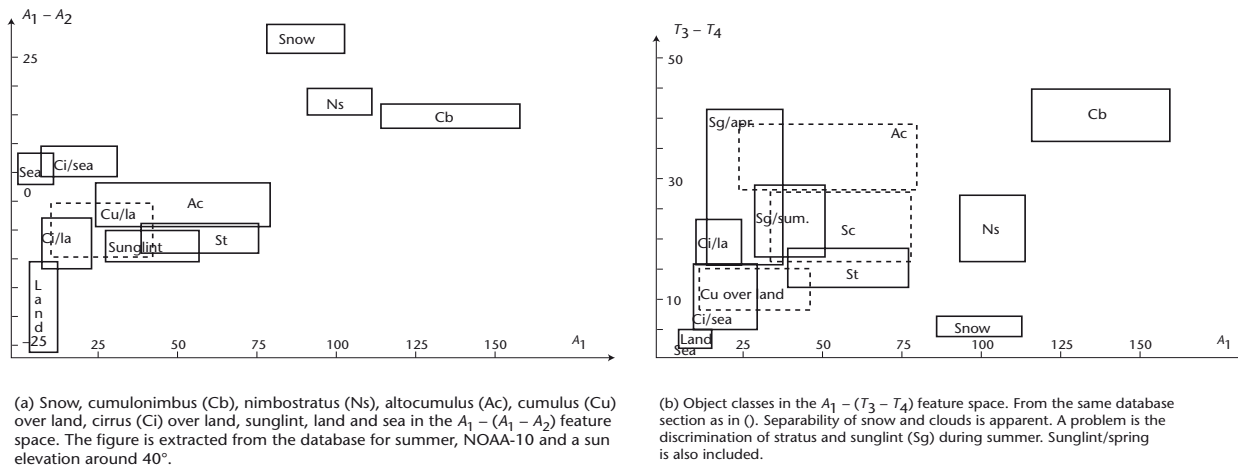

Figure 8.12. Identification of cloud and surface properties

unwanted echoes. Ever since, designers and users of radar equipment have sought to reduce this noise. Researchers investigating the effect found that the backscattered echo from the sea became large with increasing wind speed, thus opening the possibility of remotely measuring the wind. Radars designed to measure this type of echo are known as scatterometers.

Backscattering is due principally to in-phase reflections from a rough surface; for incidence angles of more than about 20° from the vertical, this occurs when the Bragg condition is met:

$$A \sin \theta_i = n \lambda / 2 \quad (8.17)$$

where A is the surface roughness wavelength; λ is the radar wavelength; and θ_i is the incidence angle and $n = 1, 2, 3 \dots$. First order Bragg scattering ($n=1$), at microwave frequencies, arises from the small ripples (cats' paws) generated by the instantaneous surface wind stress. The level of backscatter from an extended target, such as sea surface, is generally termed the normalized radar cross-section, or σ^0 . For a given geometry and transmitted power, σ^0 is proportional to the power received back at the radar. In terms of other known or measurable radar parameters:

$$\alpha^0 = \frac{P_R}{P_T} \cdot \frac{64 \pi^3 R^4}{\lambda^2 L_S G_0^2 (G/G_0)^2 A} \quad (8.18)$$

where P_T is the transmitted power and P_R is the power received back at the radar; R is the slant range to the target of area A ; λ is the radar wavelength; L_S includes atmospheric attenuation and other system losses; G_0 is the peak antenna gain; and G/G_0 is the relative antenna gain in the target direction. Equation 8.18 is

often referred to as the radar equation. σ^0 may be set in a linear form (as above) or in decibels (dB), i.e. $\sigma^0_{dB} = 10 \log_{10} \sigma^0_{lin}$.

Experimental evidence from scatterometers operating over the ocean shows that σ^0 increases with surface wind speed (as measured by ships or buoys), decreases with incidence angle, and is dependent on the radar beam angle relative to wind direction. Figure 8.13 is a plot of σ^0 aircraft data against wind direction for various wind speeds. Direction 0° corresponds to looking upwind, 90° to crosswind and 180° to downwind.

The European Space Agency has coordinated a number of experiments to confirm these types of curves at 5.3 GHz, which is the operating frequency for this instrument on the ERS-1 satellite. Several aircraft scatterometers have been flown close to instrumented ships and buoys in the North Sea, the Atlantic and the Mediterranean. The σ^0 data are then correlated with the surface wind, which has been adjusted to a common anemometer height of 10 m (assuming neutral stability). An empirical model function has been fitted to this data of the form:

$$\sigma^0 = a_0 \cdot U^\gamma (1 + a_1 \cos \phi + a_2 \cos^2 \phi) \quad (8.19)$$

where the coefficients a_0, a_1, a_2 and γ are dependent on the incidence angle. This model relates the neutral stability wind speed at 10 m, U , and the wind direction relative to the radar, ϕ , to the normalized radar cross-section.

It may also be the case that σ^0 is a function of sea-surface temperature, sea state and surface slicks (natural or man-made). However, these parameters have yet to be demonstrated as having any

significant effect on the accuracy of wind vector retrieval.

Since σ^0 shows a clear relationship with wind speed and direction, in principle, measuring σ^0 at two or more different azimuth angles allows both wind speed and direction to be retrieved. However, the direction retrieved may not be unique; there may be ambiguous directions.

In 1978, a wind scatterometer was flown on a satellite—the SEASAT-A satellite scatterometer (SASS)—for the first time and ably demonstrated the accuracy of this new form of measurement. The specification was for root-mean-square accuracies of 2 m s^{-1} for wind speed and 20° for direction. Comparisons with conventional wind measurements showed that these figures were met if the rough wind direction was known, so as to select the best from the ambiguous set of SASS directions.

The SASS instrument used two beams either side of the spacecraft, whereas the ERS-1 scatterometer uses a third, central beam to improve wind direction discrimination; however, since it is only a single-sided instrument, it provides less coverage. Each of the three antennas produces a narrow beam of radar energy in the horizontal, but wide beam in the vertical, resulting in a narrow band of illumination of the sea surface across the 500 km width of the swath. As the satellite travels

forward, the centre then rear beam measures from the same part of the ocean as the fore beam. Hence, each part of the swath, divided into 50 km squares, has three σ^0 measurements taken at different relative directions to the local surface wind vector.

Figure 8.14 shows the coverage of the scatterometer for the North Atlantic over 24 h. These swaths are not static and move westwards to fill in the large gaps on subsequent days. Even so, the coverage is not complete due to the relatively small swath width in relation to, for example, the AVHRR imager on the NOAA satellites. However, there is potentially a wind available every 50 km within the coverage area, globally, and the European Space Agency delivers this information to operational users within 3 h of the measurement time. The raw instrument data are recorded on board and replayed to European Space Agency ground stations each orbit, the principle station being at Kiruna in northern Sweden, where the wind vectors are derived.

As already mentioned, the scatterometer principally measures the power level of the backscatter at a given location at different azimuth angles. Since we know the geometry, such as range and incidence angles, equation 8.18 can be used to calculate a triplet of values of σ^0 for each cell.

In theory, it should be possible to use the model function (equation 8.19) to extract the two pieces of information required (wind speed and direction) using appropriate simultaneous equations. However, in practice, this is not feasible; the three σ^0 s will have a finite measurement error, and the function itself is highly nonlinear. Indeed, the model, initially based on aircraft data, may not be applicable to all circumstances. Wind speed and direction must be extracted numerically, usually by minimizing a function of the form:

$$R = \int_{i=1}^3 \left[\frac{\sigma_i^0 - \sigma^0(U, \phi_i, \theta_i)}{\sigma_i^0 K p_i} \right]^2 \quad (8.20)$$

where R is effectively the sum of squares of the residuals, comparing the measured values of σ^0 to those from the model function (using an estimate of wind speed and direction), weighted by the noise in each beam, $K p_i$, which is related to the S/N ratio. The wind vector estimate is refined so as to minimize R . Starting at different first-guess wind directions, the numerical solution can converge on up to four distinct, or ambiguous, wind vectors, although

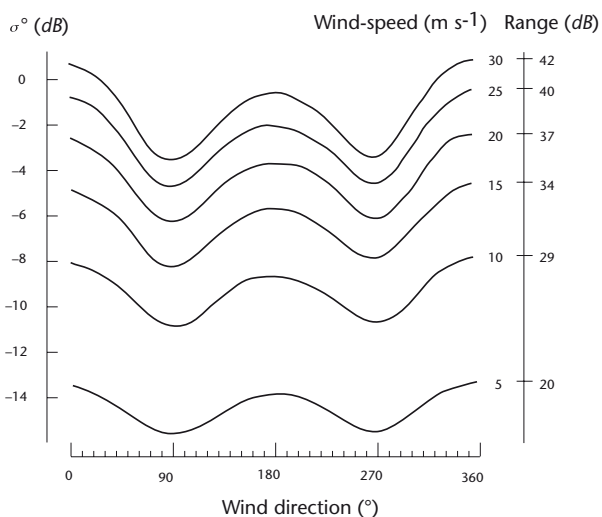

Figure 8.13. Measured backscatter, σ^0 (in decibels), against relative wind direction for different wind speeds. Data are for 13 GHz, vertical polarization.

there are often only two obviously different ones, usually about 180° apart. One of these is the “correct” solution, in that it is the closest to the true wind direction and within the required root-mean-square accuracies of 2 m s^{-1} and 20° . Algorithms have been developed to select the correct set of solutions. Numerical model wind fields are also used as first-guess fields to aid such analyses. Work is currently under way with ERS-1 data to calibrate and validate satellite winds using surface and low-level airborne measurements.

8.3.4.3 Microwave radiometer surface wind speed

The special sensor microwave imagers (SSM/I) flying on the DMSP satellite provide microwave radiometric brightness temperatures at several frequencies (19, 22, 37 and 85.5 GHz) and both vertical and horizontal polarization. Several algorithms have been developed to measure a variety of meteorological parameters. Surface wind speeds over sea

(not over land) can be measured to an accuracy of a few metres per second using a regression equation on the brightness temperatures in several channels. Work continues to verify and develop these algorithms, which are not yet used operationally.

8.3.5 Precipitation

8.3.5.1 Visible/infrared techniques

Visible/infrared techniques derive qualitative or quantitative estimates of rainfall from satellite imagery through indirect relationships between solar radiance reflected by clouds (or cloud brightness temperatures) and precipitation. A number of methods have been developed and tested during the past 15 years with a measured degree of success.

There are two basic approaches, namely the “life-history” and the “cloud-indexing” techniques. The first technique uses data from geostationary

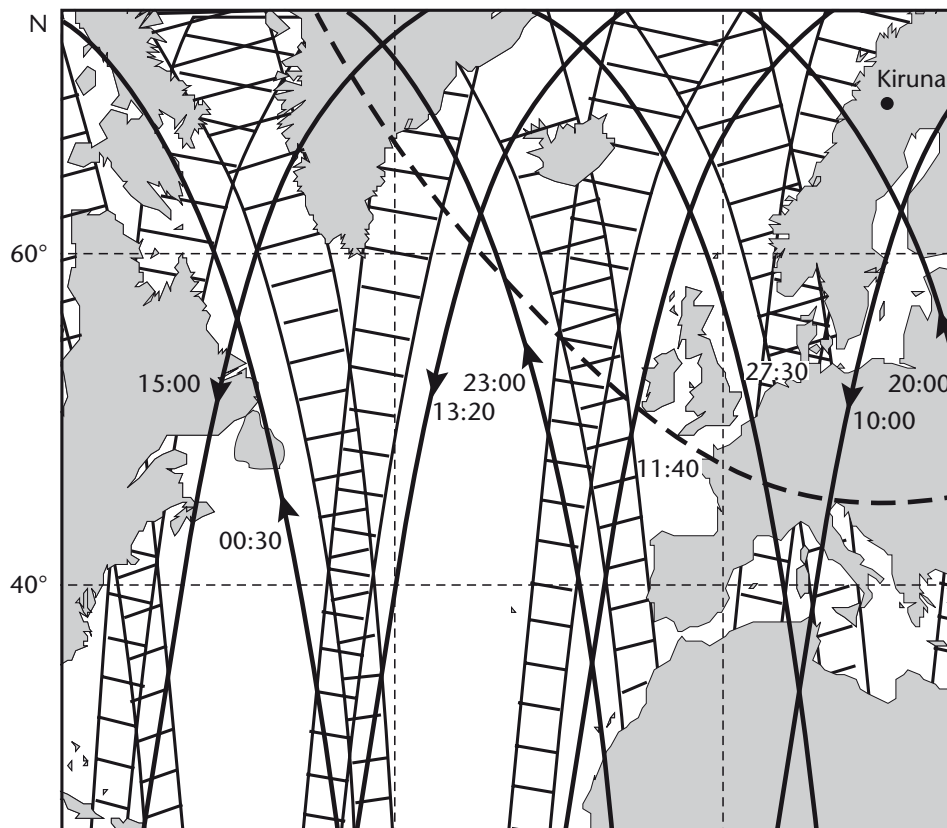

Figure 8.14. ERS-1 subsatellite tracks and wind scatterometer coverage of the North Atlantic region over one day. The large gaps are partially filled on subsequent days; nominally this occurs in a three-day cycle. The dashed lines show the limits of reception for the Kiruna ground station in Sweden.

satellites, which produce images usually every half hour, and has been mostly applied to convective systems. The second technique, also based on cloud classification, does not require a series of consecutive observations of the same cloud system. It must be noted, however, that, up to now, none of these techniques has been shown to be “transportable”. In other words, relationships derived for a given region and a given period may not be valid for a different location and/or season.

Other problems include difficulties in defining rain/no-rain boundaries and inability to cope with the rainfall patterns at the mesoscale or local scale. Scientists working in this field are aware of these problems; for this reason it is current practice to speak of the derivation of “precipitation indices” rather than rain rates.

8.3.5.2 Cloud-indexing methods

Cloud indexing was the first technique developed to estimate precipitation from space. It is based on the assumption that the probability of rainfall over a given area is related to the amount and type of cloudiness present over the area. Hence, it could be postulated that precipitation can be characterized by the structure of the upper surface of the associated cloudiness. In addition, in the case of convective precipitation, it could also be postulated that a relationship exists between the capacity of a cumuliform cloud to produce rain and its vertical as well as its horizontal dimensions. The vertical extent of a convective cloud is related to the cloud-top brightness temperature (higher cloud tops are associated with colder brightness temperatures).

The approach is, therefore, to perform a cloud structure analysis (objective or subjective) based on the definition of a criterion relating cloudiness to a coefficient (or index) of precipitation. This characteristic may be, for instance, the number of image pixels above a given threshold level.

The general approach for cloud-indexing methods involving infrared observations is to derive a relationship between a precipitation index (PI) and a function of the cloud surface area, $S(TBB)$, associated with the background brightness temperature (TBB) colder than a given threshold T_0 . This relationship can be generally expressed as follows:

$$PI = A_0 + \sum_i A_i S_i(TBB_i) \quad (8.21)$$

for $TBB_i < T_0$.

If desired, an additional term related to the visible image can be included on the right-hand side of equation 8.21.

The next step is to relate PI to a physical quantity related in some way to rain. This is done by adjusting the coefficients A and the threshold level T_0 by comparison with independent observations, such as raingauge or radar data.

One of the problems inherent in this technique is the bias created by the potential presence of high-level non-precipitating clouds such as cirrus. Another limitation resides in the fact that the satellite measurement represents an instantaneous observation integrated over space, while raingauge observations are integrated over time at a given site.

8.3.5.3 Life-history methods

Life-history methods, as indicated by their name, are based on the observation of a series of consecutive images obtained from a geostationary satellite.

It has been observed that the amount of precipitation associated with a given cloud is also related to its stage of development. Therefore, two clouds presenting the same aspect (from the visible infrared images point of view) may produce different quantities of rain, depending on whether they are growing or decaying.

As with the cloud-indexing technique, a relationship is derived between a PI and a function of the cloud surface area, $S(TBB)$, associated with a given brightness temperature (TBB) lying above a given threshold level. In addition, cloud evolution is taken into account and expressed in terms of the rate of change of $S(TBB)$ between two consecutive observations.

An equation, as complex as desired, may be derived between PI and functions of $S(TBB)$ and its derivative with respect to time:

$$PI = A + A_1 S(TBB) + A_2 \frac{d}{dt} S(TBB) \quad (8.22)$$

for $TBB < T_0$.

Here, also, another step is necessary in order to relate the PI defined by the equation to a physical quantity related to rain.

Many such relationships have already been published. These publications have been discussed extensively, and it has been demonstrated, at least

for one instance, that taking into account the cloud evolution with time added unnecessary complexity and that comparable success could be obtained with a simple cloud-indexing technique.

Recently, more physics has been introduced to the various schemes. Improvements include the following:

- (a) The use of cloud models to take into account the stratiform precipitation often associated with convective rainfall and to help with cloud classification;
- (b) The use of cloud microphysics, such as drop-size/rain-rate relations;
- (c) The introduction of simultaneous upper tropospheric water vapour observations;
- (d) The introduction of a time lag between the satellite observations and the ground-based measurements.

It has also become evident that satellite data could be used in conjunction with radar observations, not only to validate a method, but as a complementary tool. FRONTIERS (the forecasting rain optimized using new techniques of interactively enhanced radar and satellite), developed by the UK Met Office, provides an example of the combined use of satellite imagery and radar observations.

Various comparisons between different methods over the same test cases have now been performed and published. However, any final statement concerning the success (or lack thereof) of visible infrared methods must be treated with extreme caution. The degree of success is very strongly related to the space-time scales considered, and it cannot be expected that a regression developed and tested for use in climate studies will also be valid for the estimation of mesoscale precipitation. It must also be kept in mind that it is always easy to adjust regression coefficients for a particular case and claim that the method has been validated.

8.3.5.4 Microwave techniques

Visible infrared measurements represent observations of the upper surfaces of clouds only. In contrast, it is often believed that microwave radiation is not affected by the presence of clouds. This statement is not generally true. Its degree of validity varies with the microwave frequency used as well as with the type of cloud being observed.

One major difference between infrared and microwave radiation is the fact that, while the ocean surface emissivity is nearly equal to one in the infrared, its value (although variable) is much smaller in

the microwave region (from 5 to 200 GHz in this case). Therefore, the background brightness temperature (TBB) of the ocean surface appears much colder in the microwave. Over land, the emissivity is close to one, but varies greatly depending on the soil moisture.

As far as microwaves are concerned, several different effects are associated with the presence of clouds over the ocean. They are highly frequency dependent. Currently, active methods (space-borne radar) are being developed for experimental use.

8.3.6 Sea-surface temperatures

Satellite measurements of radiation emitted from the ocean surface may be used to derive estimates of sea-surface temperature, to complement in situ observation systems (for example, ships, drifting buoys), for use in real-time meteorological or oceanographic applications, and in climate studies. Although satellites measure the temperature from a layer of ocean less than about 1 mm thick, the satellite data compares very favourably with conventional data. The great advantage of satellite data is geographical coverage, which generally far surpasses that available by conventional means. Also, in many cases, the frequency of satellite observations is better than that obtained using drifting buoys, although this depends on the satellite and the latitude of observation, among other things.

Satellite sea-surface temperature measurements are most commonly made at infrared wavelengths and, to a lesser degree, at microwave wavelengths. Scanning radiometers are generally used. In the infrared, the essence of the derivation is to remove any pixels contaminated by cloud and to correct the measured infrared brightness temperatures for attenuation by water vapour. Cloud-free pixels must be identified extremely carefully so as to ensure that radiances for the ocean are not affected by clouds, which generally radiate at much colder temperatures than the ocean surface. Algorithms have been developed for the specific purpose of cloud clearing for infrared sea-surface temperature measurements (for example, Saunders and Kriebel, 1988).

The satellite infrared sea-surface temperatures can be derived only in cloud-free areas, whereas at microwave wavelengths, cloud attenuation is far smaller so that in all but heavy convective situations the microwave data measurements are available. The disadvantage with the microwave data is that the instrument spatial resolution is usually of the order of several tens of kilometres, whereas infrared resolution is generally around 1 to

5 km. Microwave sea-surface temperature measurements are discussed by Alishouse and McClain (1985).

8.3.6.1 Infrared techniques

Most satellite measurements are taken in the 10.5 to 12.5 μm atmospheric window, for which corrections to measured brightness temperatures due to water vapour attenuation may be as much as 10 K in warm moist (tropical) atmospheres. Sea-surface temperature derivation techniques usually address this problem in one of two ways.

In the differing path length (multilook) method, observations are taken of the same sea location at differing look angles. Because atmospheric attenuation is proportional to atmospheric path length, measurements at two look angles can be used to correct for the attenuation. An example of an instrument that uses this technique is the along track scanning radiometer (ATSR), a new generation infrared radiometer that has a dual angle view of the sea and is built specifically to provide accurate sea-surface temperature measurements (Prata and others, 1990). It is carried on board the European Space Agency remote-sensing satellite ERS-1, launched in July 1991.

In the split-window technique, atmospheric attenuation corrections can be made because of differential absorption in a given window region of the atmosphere (for example, 10.5 to 12.5 μm) and the highly wavelength-dependent nature of water vapour absorption. The differing infrared brightness temperatures measured for any two wavelengths within the infrared 10 to 12 μm window support theoretical studies which indicate a highly linear relation between any pair of infrared temperatures and the correction needed. Hence, the difference in atmospheric attenuation between a pair of wavelengths is proportional to the difference in attenuation between a second pair. One window is chosen as a perfect window (through which the satellite "sees" the ocean surface), and one wavelength is common to both pairs. A typical split window algorithm is of the form:

$$T_s = a_0 + T_{11} + a_1 (T_{11} - T_{12}) \quad (8.23)$$

where T_s is the sea-surface temperature; T values are brightness temperatures at 11 or 12 μm , as indicated; and a_0 and a_1 are constants. Algorithms of this general form have been derived for use with daytime or night-time measurements, and using several

infrared channels (for example, McClain, Pichel and Walton, 1985).

Instruments

A number of satellite-borne instruments have been used for sea-surface temperature measurements (Rao and others, 1990) as follows:

- (a) NOAA AVHRR;
- (b) GOES VAS;
- (c) NOAA HIRS/MSU;
- (d) GMS VISSR;
- (e) SEASAT and Nimbus-7 SMMR (scanning multichannel microwave radiometer);
- (f) DMSP SSM/T (special sensor microwave temperature sounder).

By far the most widely used source of satellite sea-surface temperatures has been the AVHRR, using channels 3, 4 and 5 (Annex 8.A).

8.3.6.2 Comparison with ground-based observations

Before considering the comparison of satellite-derived sea-surface temperatures with in situ measurements, it is important to understand what satellite instruments actually measure. Between about 3 and 14 μm , satellite radiometers measure only emitted radiation from a "skin" layer about 1 mm thick. The true physical temperature of this skin layer can differ from the sea temperature below (say, at a depth from a few metres to several tens of metres) by up to several K, depending on the prevailing conditions and on a number of factors such as:

- (a) The mixing of the upper layers of the ocean due to wind, or gravitational settling at night after the topmost layers radiatively cool;
- (b) Heating of the ocean surface by sunlight;
- (c) Evaporation;
- (d) Rainfall;
- (e) Currents;
- (f) Upwelling and downwelling.

The most serious of these problems can be the heating of the top layer of the ocean on a calm sunny day. To some degree, the disparity between satellite sea-surface temperatures is circumvented by using daytime and night-time algorithms, which have been specially tuned to take into account diurnal oceanic effects. Alternatively, night-time satellite sea-surface temperatures are often preferred because the skin effect and the oceanic thermocline are at a minimum at night. It should also be remembered that ship measurements refer to a point value at a given depth ("intake temperature") of 10 m or

more, whereas the satellite is measuring radiance averaged over a large area (from 1 up to several tens or hundreds of square kilometres). Note that the ship data can often be highly variable in terms of quality.

Rao and others (1990) show a comparison of global satellite multichannel satellite sea-surface temperatures with drifting buoys. The bias is very small and the root mean square deviation is about 0.5 K. Typically, comparisons of infrared satellite sea-surface temperatures with in situ data (for example, buoys) show biases within 0.1 K and errors in the range of 0.4 to 0.6 K.

Rao and others (1990) also show a comparison of microwave satellite sea-surface temperatures (using the SMMR instrument) with ship observations. The bias is 0.22 K and the standard deviation is 0.75 K for the one-month comparison.

In summary, satellite derived sea-surface temperatures provide a very important source of observations for use in meteorological and oceanographic applications. Because satellite instruments provide distinctly different measurements of sea temperature than do ships or buoys, care must be taken when merging the satellite data with conventional data. However, many of these possible problems of merging slightly disparate data sets have been overcome by careful tuning of satellite sea-surface temperature algorithms to ensure that the satellite data are consistent with a reference point defined by drifting buoy observations.

8.3.7 Upper tropospheric humidity

The method used to extract values of upper tropospheric humidity (from geostationary satellite data) is based on the interpretation of the 6.7 μm water-vapour channel radiances, and the results represent a mean value throughout a deep layer in the atmosphere between approximately 600 and 300 hPa. The limits of this atmospheric column cannot be precisely specified since the contribution function of the water-vapour channel varies in altitude in proportion to the water-vapour content of the atmosphere. The output of segment processing provides a description of all identified surfaces (cloud, land or sea), and the upper upper tropospheric humidity product is derived only for segments not containing medium and high cloud. The horizontal resolution is that of the nominal segment, and values are expressed as percentage relative humidity.

The product is extracted twice daily from METEOSAT (based on image data for 1100 and 2300 UTC) and are distributed over the GTS in the WMO SATOB code.

8.3.8 Total ozone

Solar ultraviolet light striking the atmosphere is partly absorbed and partly backscattered back to space. Since ozone is the principal backscatterer, the SBUV radiometer, which measures backscattered ultraviolet, allows calculations of the global distribution and time variation of atmospheric ozone. Measurements in the ultraviolet band, 160 to 400 μm , are now of great interest as being indicative of possible climate changes.

In addition to the SBUV, the total ozone mapping spectrometer (TOMS) instrument carried on board Nimbus-7 is a monochromator measuring radiation in six bands from 0.28 to 0.3125 μm . It has provided total ozone estimates within about 2 per cent of ground-based data for over a decade and has been one of the prime sources of data in monitoring the "ozone hole".

Rather than measure at ultraviolet or visible wavelengths, a 9.7 μm ozone absorption band in the thermal infrared has allowed measurement of total ozone column density by using satellite-borne radiometers which either limb scan or scan subsatellite (for example, the TOVS instrument package on NOAA satellites includes a 9.7 μm channel). The accuracy of this type of satellite measurement compared to ground-based (for example, Dobson spectrophotometer) data is around 10 per cent primarily because of the reliance upon only one channel (Ma, Smith and Woolf, 1984).

It should be noted that the great advantage of the satellite data over ground-based data (ozone sondes or Dobson measurements) is the temporal and wide spatial coverage, making such data extremely important in monitoring global ozone depletion, especially over the polar regions, where conventional observation networks are very sparse.

During the 1990s, further specialized satellite instruments which measure ozone levels or other related upper atmospheric constituents began to come into service. These included several instruments on the NASA upper atmosphere research satellite (UARS); the polar ozone and aerosol measurement instrument (POAM II) on Spot-3, a remote-sensing satellite launched in 1993; the stratospheric aerosol and gas experiment 3 (SAGE III); and a range of instruments

which were scheduled for launch on the Earth Observation System (EOS) polar orbiters in the late 1990s.

8.3.9 Volcanic ash detection

Volcanic ash clouds present a severe hazard to aviation. Since 1970 alone, there have been a large number of dangerous and costly incidents involving jet aircraft inadvertently flying through ash clouds ejected from volcanoes, especially in the Asian-Pacific region and the Pacific rim, where there are large numbers of active volcanoes. As a result of this problem, WMO, the International Civil Aviation Organization and other organizations have been working actively toward the provision of improved detection and warning systems and procedures so that the risk to passengers and aircraft might be minimized.

The discrimination of volcanic ash clouds from normal (water/ice) clouds using single channel infrared or visible satellite imagery is often extremely difficult, if not impossible, primarily because ash clouds often appear in regions where cloudiness and thunderstorm activity are common and the two types of clouds look similar. However, techniques have been developed for utilizing the split window channel on the NOAA AVHRR instrument to aid in distinguishing ash clouds from normal clouds, and to improve the delineation of ash clouds which may not be visible on single channel infrared images.

The technique involving AVHRR relies on the fact that the microphysical properties of ash clouds are different from those of water/ice clouds in the thermal infrared, so that over ash cloud the brightness temperature difference between channels 4 and 5 of the AVHRR instrument, T₄–T₅, is usually negative and up to about –10 K, whereas for water/ice clouds T₄–T₅ is close to zero or small and positive (Prata, 1989 and Potts, 1993).

This principle of detection of volcanic ash clouds is currently being used in the development of multichannel radiometers which are ground- or aircraft-based.

Very few studies have taken place with in situ observations of volcanic ash clouds in order to ascertain the quality and accuracy of volcanic ash cloud discrimination using AVHRR. Ground-based reports of volcanic eruptions tend to be used operationally to alert meteorologists to the fact that satellite imagery can then be used to monitor the subsequent evolution and movement of ash

clouds. It should be noted that the technique has its limitations, for example, in cases where the ash cloud may be dispersed and underlying radiation for water/ice clouds or sea/land surfaces may result in T₄–T₅ values being close to zero or positive, rather than negative as expected over volcanic ash cloud.

8.3.10 Normalized difference vegetation indices

Satellite observations may be used to identify and monitor vegetation (Rao and others, 1990). Applications include crop monitoring, deforestation, monitoring, forest management, drought assessment and flood monitoring. The technique relies on the fact that the reflectance of green vegetation is low at visible wavelengths but very high in the region from about 0.7 to 1.3 μm (owing to the interaction of the incident radiation with chlorophyll). However, the reflectance over surfaces such as soil or water remains low in the near-infrared and visible regions. Hence, satellite techniques for the assessment of vegetation generally use the difference in reflectivity between a visible channel and a near-infrared channel around 1 μm .

As an example, the normalized difference vegetation index (NDVI) using AVHRR data, which is very widely used, is defined as:

$$\text{NDVI} = (\text{Ch2} - \text{Ch1}) / (\text{Ch2} + \text{Ch1}) \quad (8.24)$$

Values for this index are generally in the range of 0.1 to 0.6 over vegetation, with the higher values being associated with greater greenness and/or density of the plant canopy. By contrast, over clouds, snow, water or rock, NDVI is either very close to zero or negative.

Satellite monitoring of vegetation was first used extensively around the mid-1970s. It has since been refined principally as a result of a gradual improvement in the theoretical understanding of the complex interaction between vegetation and incident radiation, and better knowledge of satellite instrument characteristics and corrections required for the satellite measurements. As with sea-surface temperature satellite measurements, the processing of satellite data for NDVIs involves many corrections – for geometry of satellite view and solar illumination, atmospheric effects such as aerosols and water vapour, instrument calibration characteristics, and so on. Also, at the outset, cloud clearing is carried out to obtain cloud-free pixels.

The three main instruments used in vegetation monitoring by satellite are the NOAA AVHRR, and the Landsat multispectral scanner and thematic mapper.

Interpretation of NDVIs and application to various areas of meteorology or to Earth system science rely on an understanding of exactly what the satellite instrument is measuring, which is a complex problem. This is because within the field of view green leaves may be oriented at different angles, there may be different types of vegetation and there may be vegetation-free parts of the field of view. Nevertheless, NDVI correlates with ground-measured parameters, as illustrated in Figure 8.15 (Paltridge and Barber, 1988), which shows NDVI

(called V_0) plotted against fuel moisture content derived from ground sampling of vegetation at various locations viewed by the NOAA AVHRR instrument. The graph shows that NDVI is well correlated with fuel moisture content, except beyond a critical value of fuel moisture content for which the vegetation is very green, and for which the NDVI remains at a constant level. Hence, NDVIs may be very useful in fire weather forecasting.

Figure 8.16 (Malingreau, 1986) shows NDVI development over a three-year period, in (a) a rice field area of Thailand and (b) a wheat-rice cropping system in China. Peaks in NDVI correspond to dry season and wet season rice crops in the (a) graph

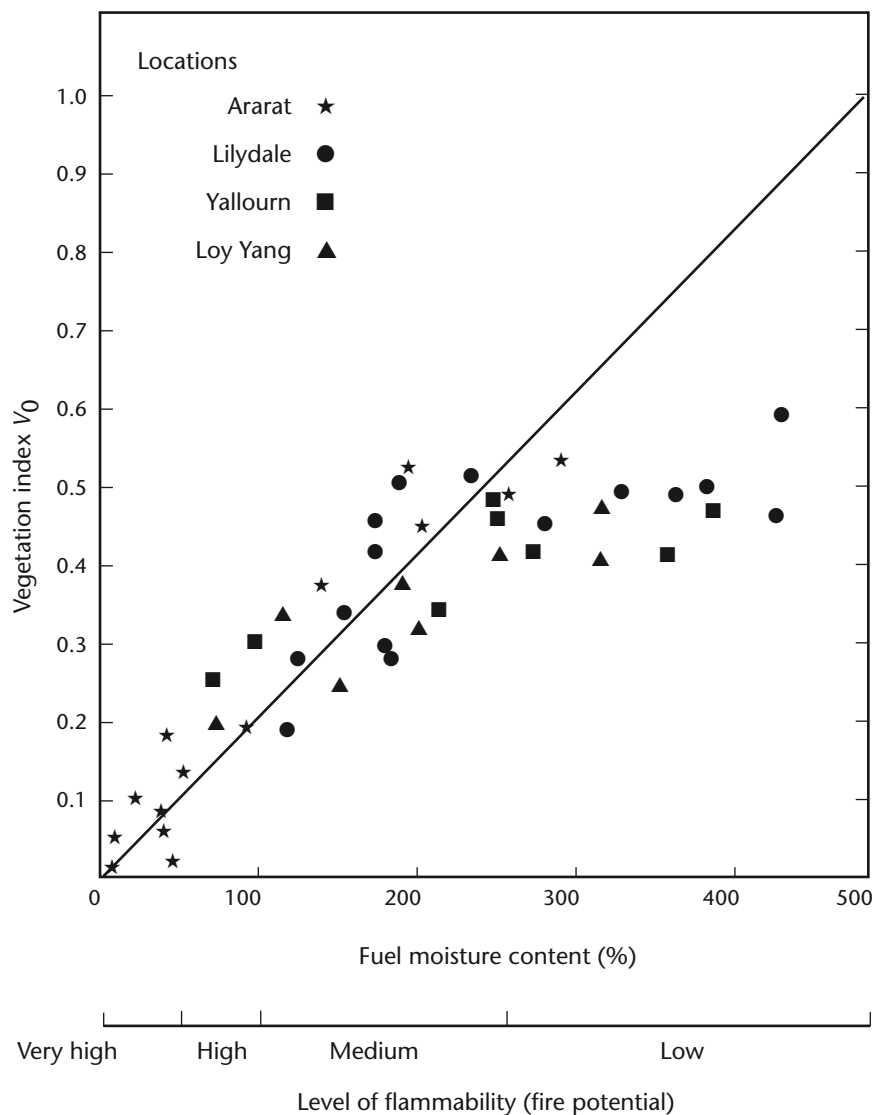

Figure 8.15. Full-cover, satellite-observed vegetation index as a function of fuel moisture content. Each point is a particular location average at a particular sampling time (see text).

and to wheat and rice crops in the (b) graph, respectively.

8.3.11 Other parameters

A number of other parameters are now being estimated from satellites, including various atmospheric trace gases, soil moisture (from synthetic aperture radar data (ERS-1)), integrated water vapour (SSM/I), cloud liquid water (SSM/I), distribution of flood waters, and the Earth's radiation budget (ERBE) (on the NOAA polar orbiters). Atmospheric pressure has not yet been reliably measured from space. Atmospheric instability can be measured from temperature and humidity profiles.

Bush-fires have been successfully monitored using satellite instruments, especially the NOAA AVHRR (Robinson, 1991). Channel 3 (at the 3.7 μm window) is extremely sensitive to the presence of "hot spots", namely, regions in which the brightness temperature may range from 400 up to about 1 000 K. It is sensitive because of the strong temperature sensitivity of the Planck function and the peaking of black-body radiance from hot objects at around 4 μm. Hot spots show up on channel 3 images extremely prominently, thereby allowing fire fronts

to be accurately detected. In combination with channel 1 and 4 images, which may be used for the identification of smoke and cloud, respectively, channel 3 images are very useful in fire detection.

Snow and ice can be detected using instruments such as AVHRR (visible and infrared) or the SMMR (microwave) on Nimbus-7 (Gesell, 1989). With AVHRR, the detection process involves the discrimination between snow/ice and various surfaces such as land, sea or cloud. The variation with wavelength of the spectral characteristics of these surfaces is exploited by using algorithms incorporating techniques such as thresholds; ratios of radiances or reflectivities at different wavelengths; differences between radiances or reflectivities; or spatial coherence. The disadvantage of using AVHRR is that detection is limited by the presence of cloud; this is important because cloudiness may be very high in the areas of interest.

At microwave wavelengths, sea-ice detection relies on the strong contrast between sea and ice, due to the widely differing emissivities (and hence brightness temperatures) of these surfaces at microwave wavelengths. The main advantage of microwave detection is the all-weather capability, although the spatial resolution is generally tens of kilometres compared to 1 km for AVHRR.

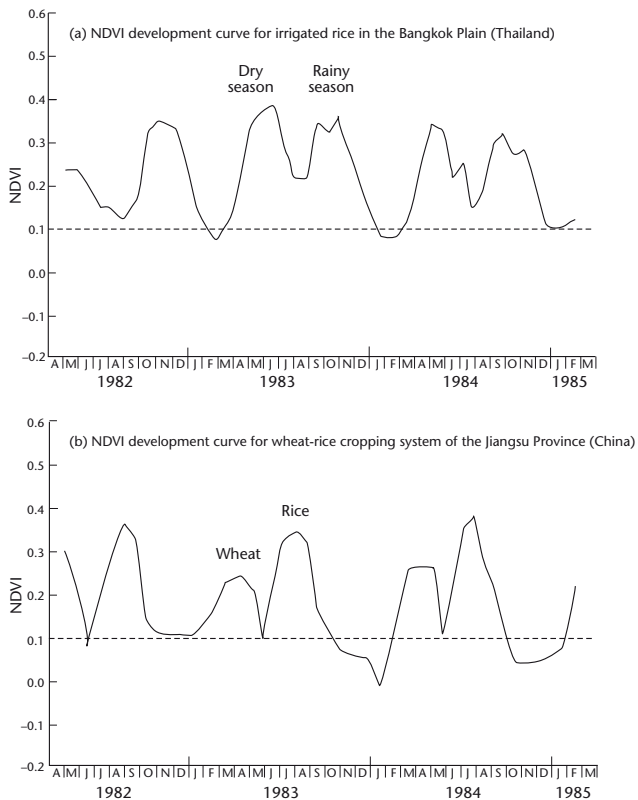

Figure 8.16. NDVI development curves for irrigated rice in Thailand and wheat-rice in China

8.4 RELATED FACILITIES

8.4.1 Satellite telemetry

All satellites receive instructions and transmit data using telemetry facilities. However, all weather satellites in geostationary orbit and some in polar orbits have on-board transponders which receive data telemetered to them from data collection platforms (DCPs) at outstations. This facility allows the satellites to act as telemetering relay stations.

The advantages offered by satellite telemetry are the following:

- (a) Repeater stations are not required;
- (b) The installation of outstations and receivers is simple;
- (c) Outstations can be moved from site to site with ease;
- (d) Outstations are unobtrusive; their antennas are small and do not require high masts;
- (e) There is little restriction through topography;
- (f) One receiver can receive data from outstations covering over a quarter of the Earth's surface;
- (g) Because power requirements are minimal, solar power is adequate;

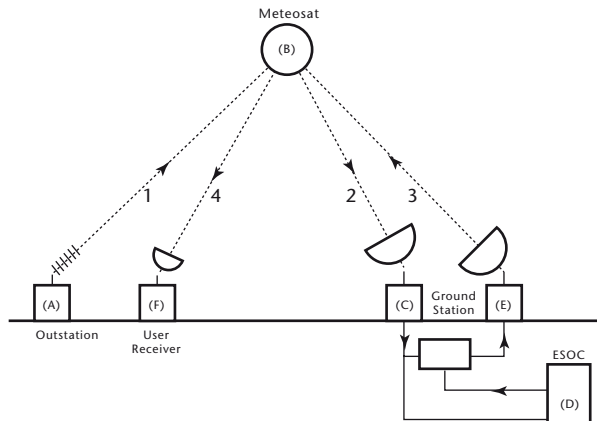

Figure 8.17. The METEOSAT DCP telemetry system

- (h) Equipment reliability is high, both on board the spacecraft and in the field;
- (i) A frequency licence is not required by the user, the satellite operator being licensed;
- (j) As many receivers as required can be operated, without the need to increase power or facilities at the outstations.

8.4.2 The METEOSAT data collection platform telemetry system

Figure 8.17 illustrates the METEOSAT DCP telemetry system. It should be noted that similar systems are implemented on the GOES, GMS and INSAT satellites and are outlined in WMO (1989). The systems for other geostationary satellites are similar. The outstation (A) transmits its measurements to METEOSAT (B) along path 1 at set time intervals (hourly, three-hourly, daily, etc.). It has a 1 min time slot in which to transmit its data, on a frequency of between 402.01 MHz and 402.20 MHz at a power of 5 W (25 to 40 W for mobile outstations, with omnidirectional antenna).

The satellite immediately retransmits these data to the European Space Operations Centre (ESOC) ground station (C), sited in the Odenwald near Michelstadt, Germany, along path 2 at a frequency of around 1 675 MHz. From here, the data are sent by landline to ESOC, some 40 km north-west of Odenwald in Darmstadt (D). Here they are quality controlled, archived and, where appropriate, distributed on the Global Telecommunications Network. They are also retained at the ground station and returned to METEOSAT (multiplexed with imagery data) from a second dish antenna (E), along path 3, for retransmission to users via the satellite along path 4.

The signal level is such that it can be received by a 2 m diameter dish antenna, although 1.5 m is often adequate. The dish houses a “down converter”, used to convert the incoming signal from 1 694.5 MHz to 137 MHz for input to a receiver, which decodes the transmissions, outputting the data in ASCII characters to a printer or personal computer.

The unit which forms the heart of an outstation is the DCP. This is an electronic unit, similar in many ways to a logger, which can accept either several analogue voltage inputs directly from sensors, or serial data (RS232) from a processing unit between the sensors and the DCP. It also contains a small memory to store readings taken between transmissions, a processor section for overall management, a clock circuit, the radio transmitter, and either a directional or omnidirectional antenna.

Up to 600 bytes can be stored in the memory for transmission at 100 bits per second. This capacity can be doubled, but this requires two 1 min time slots for transmission. The capacity is set by the amount of data that can be transmitted in a 1 min time slot.

When manufactured, DCPs are programmed with their address (an 8 digit octal number) and with their time of transmission, both specified by EUMETSAT. In future designs, these are likely to be programmable by the user, to provide greater flexibility.

In operation, an operator sets the DCP’s internal clock is set by to GMT. This is carried out either with a “synchronizer unit” or with a portable personal computer. Up to a 15 s drift is permitted either way; thereafter it must be reset.

At its appointed times, the DCP transmits the accumulated contents of its memory to METEOSAT, and thereafter clears it, ready to receive the next set of data for transmission at the next time slot. This operation is repeated indefinitely.

The synchronizer (or personal computer) can also be used to give the station a name (e.g. its location) and to carry out a range of tests which include checking the clock setting, battery voltage, transmitter state, analogue inputs and the memory contents. It is also possible to speed up the clock to test overall performance, including the making of a test transmission (into a dummy load to prevent interference by transmitting outside the allocated time slot).

A DCP will fit into a small housing and can be powered by a solar-charged battery. The remainder of the outstation comprises the sensors, which are similar to those at a conventional logging station or at a ground-based radio telemetry installation.

8.4.3 METEOSAT data handling

Images

The images are built up, line by line, by a multi-spectral radiometer (see previous sections).

METEOSAT spins on its axis at 100 revolutions per minute, scanning the Earth in horizontal lines from east to west. A mirror makes a small step from south to north at each rotation, building up a complete scan of the Earth in 25 min (including 5 min for resetting the mirror for the next scan).

The visible image is formed of 5 000 lines, each of 5 000 pixels, giving a resolution of 2.5 km immediately beneath the satellite (the resolution is less at higher latitudes). The two infrared images each comprise 2 500 lines of 2 500 picture elements, giving a subsatellite resolution of 5 km.

The images are transmitted digitally, line by line, at 330 000 bits per second, while the scanner is looking at space. These transmissions are not meant for the end-user and go directly to the ground station, where they are processed by ESOC and subsequently disseminated to users, back via METEOSAT, on two separate channels.

The first channel is for high-quality digital image data for reception by a primary data user station. The second channel transmits the images in the analogue form known as weather facsimile (WEFAX), a standard used by most meteorological satellites (including polar orbiters). These can be received by secondary data user stations.

Secondary data user stations receive images covering different sections of the Earth's surface in the METEOSAT field of view. Transmissions follow a daily schedule, one image being transmitted every 4 min. These stations also receive the DCP transmissions.

DCP data handling

In addition to acquiring and disseminating the images, METEOSAT also currently has 66 channels for relaying DCP data from outstations to the

ground station. Of these, half are reserved for international use, that is for mobile DCPs passing from the field of view of one geostationary meteorological satellite into that of the next. The remainder are for fixed "regional" DCPs. Each channel can accommodate as many DCPs as its frequency of reporting and their report lengths permit. Thus, with three-hourly reporting times and 1 min messages from all DCPs, and with a 30 s buffer period between each (to allow for clock drift), each channel could accommodate 120 DCPs, making a total of 7 920.

8.4.4 Polar-orbiting satellite telemetry systems

Polar satellites have low orbits in the north/south direction with a period of about 100 min. Consequently, they do not appear stationary at one point in the sky. Instead, they appear over the horizon, pass across the sky (not necessarily directly overhead) and set at the opposite horizon. They are visible for about 10 min at each pass, but this varies depending on the angle at which they are visible.

Such orbits dictate that a different mode of operation is necessary for a telemetry system using them. Unlike geostationary systems, the DCPs used with polar-orbiting satellites (called data collection systems – DCSs) cannot transmit at set times, nor can their antennas be directed at one point in the sky. Instead, the DCSs are given set intervals at which to transmit, ranging from 100 to 200 s. They use a similar, but not identical, frequency to DCPs, and their antennas are, necessarily, omnidirectional.

Each outstation is given a slightly different transmission interval so as to reduce the chances of coincidental transmissions from two stations. Further separation of outstations is achieved by the fact that, owing to the satellite's motion, a Doppler shift in received frequency occurs. This is different for each DCS because it occupies a different location relative to the satellite.

This last feature is also used to enable the position of moving outstations to be followed. This is one of the useful features of polar orbits, and can enable, for example, a drifting buoy to be both tracked and its data collected. Furthermore, the buoy can move completely around the world and still be followed by the same satellite. This is the basis of the Argos system which operates on the NOAA satellites and is managed by France. Even fixed DCSs can make use of the feature, in that it enables data to be

collected from any point on Earth via the one satellite.

The transmissions from DCSs are received by the satellite at some point in its overpass. The means of transferring the received data to the user has to be different from that adopted for METEOSAT. They follow two routes.

In the first route, the received data are immediately retransmitted, in real time, in the ultra high frequency range, and can be received by a user's receiver on an omnidirectional antenna. To ensure communication, both receiver and outstation must be within a range of not more than about 2 000 km of each other, since both must be able to see the satellite at the same time.

In the second route, the received data are recorded on a magnetic tape logger on board the spacecraft and retransmitted to ground stations as the satellite

passes over. These stations are located in the United States and France (Argos system). From here, the data are put onto the GTS or sent as a printout by post if there is less urgency.

The cost of using the polar satellites is not small, and, while they have some unique advantages over geostationary systems, they are of less general purpose use as telemetry satellites. Their greatest value is that they can collect data from high latitudes, beyond the reach of geostationary satellites.

They can also be of value in those areas of the world not currently covered by geostationary satellites. For example, the Japanese GMS satellite does not currently provide a retransmission facility, and users can receive data only via the GTS. Until such a time as all of the Earth's surface is covered by geostationary satellites with retransmission facilities, polar orbiting satellites will usefully fill the gap.

ANNEX 8.A

ADVANCED VERY HIGH RESOLUTION RADIOMETER CHANNELS

Nadir resolution 1.1 km: swath width > 2 600 km

<i>Channel</i>	<i>Wavelength μm</i>	<i>Primary uses</i>
1	0.58–0.68	Daytime cloud surface mapping
2	0.725–1.10	Surface water, ice, snowmelt
3	3.55–3.93	Sea-surface temperature, night-time cloud mapping
4	10.30–11.30	Sea-surface temperature, day and night cloud mapping
5	11.50–12.50	Sea-surface temperature, day and night cloud mapping

ANNEX 8.B

HIRS CHANNELS AND THEIR APPLICATIONS

The television infrared observation satellite operational vertical sounder high resolution infrared sounder channels

<i>Channel</i>	<i>Central wavelength μm</i>	<i>Primary uses</i>
1	15.00	Temperature sounding
2	14.70	
3	14.50	
4	14.20	
5	14.00	
6	13.70	
7	13.40	
8	11.10	Surface temperature and cloud detection
9	9.70	Total ozone
10	8.30	Water vapour sounding
11	7.30	
12	6.70	
13	4.57	Temperature sounding
14	4.52	
15	4.46	
16	4.40	
17	4.24	
18	4.00	Surface temperature
19	3.70	
20	0.70	Cloud detection

Microwave sounding unit channels

<i>Channel</i>	<i>Central wavelength GHz</i>	<i>Primary uses</i>
1	50.31	Surface emissivity and cloud attenuation
2	53.73	Temperature sounding
3	54.96	
4	57.95	

Stratospheric sounding unit channels

Three 15 μm channels for temperature sounding.

REFERENCES AND FURTHER READING

- Alishouse, J.C. and E.P. McClain, 1985: Sea surface temperature determinations. *Advances in Geophysics*, Volume 27, pp. 279-296.
- Cooperative Institute for Meteorological Satellite Studies, 1991: *Technical Proceedings of the Sixth International TOVS Study Conference*. University of Wisconsin (see also proceedings of previous conferences, 1989, 1988).
- Eyre, J.R., J.L. Brownscombe and R.J. Allam, 1984: Detection of fog at night using advanced very high resolution radiometer (AVHRR) imagery. *Meteorological Magazine*, 113, pp. 266-271.
- Gesell, G., 1989: An algorithm for snow and ice detection using AVHRR data. *International Journal of Remote-sensing*, Volume 10, pp. 897-905.
- King-Hele, D., 1964: *Theory of Satellite Orbits in an Atmosphere*. Butterworths, London.
- Ma, X.L., W.L. Smith and H.M. Woolf, 1984: Total ozone from NOAA satellites: A physical model for obtaining measurements with high spatial resolution. *Journal of Climate and Applied Meteorology*, Volume 23, Issue 9, pp. 1309-1314.
- Malingreau, J.P., 1986: Global vegetation dynamics: Satellite observations over Asia. *International Journal of Remote-sensing*, Volume 7, pp. 1121-1146.
- Massey, H., 1964: *Space Physics*. Cambridge University Press, London.
- McClain, E.P., W.G. Pichel and C.C. Walton, 1985: Comparative performance of AVHRR-based multichannel sea surface temperatures. *Journal of Geophysical Research*, Volume 90, pp. 11587-11601.
- Paltridge, G.W. and J. Barber, 1988: Monitoring grassland dryness and fire potential in Australia with NOAA/AVHRR data. *Remote-sensing of the Environment*, Volume 25, pp. 381-394.
- Potts, R.J., 1993: Satellite observations of Mt Pinatubo ash clouds. *Australian Meteorological Magazine*, Volume 42, pp. 59-68.
- Prata, A.J., 1989: Observations of volcanic ash clouds in the 10-12 micron window using AVHRR/2 data. *International Journal of Remote-sensing*, Volume 10, pp. 751-761.
- Prata, A.J., R.P. Cechet, I.J. Barton and D.T. Llewellyn-Jones, 1990: The along-track scanning radiometer for ERS-1: Scan geometry and data simulation. *IEEE Transactions on Geoscience and Remote-sensing*, Volume 28, pp. 3-13.
- Rao, P.K., S.J. Holmes, R.K. Anderson, J.S. Winston and P.E. Lehr, 1990: *Weather Satellites: Systems, Data, and Environmental Applications*. American Meteorological Society, Boston.
- Robinson, J.M., 1991: Fire from space: Global fire evaluation using infrared remote-sensing. *International Journal of Remote-sensing*, Volume 12, pp. 3-24.
- Saunders, R.W. and K.T. Kriebel, 1988: An improved method for detecting clear sky and cloudy radiances from AVHRR data. *International Journal of Remote-sensing*, Volume 9, pp. 123-150.
- Smith, W.L., 1985: Satellites. In D.D. Houghton (ed.): *Handbook of Applied Meteorology*, Wiley, New York, pp. 380-472.
- Smith, W.L. and C.M.R. Platt, 1978: Comparison of satellite-deduced cloud heights with indications from radiosonde and ground-based laser measurements. *Journal of Applied Meteorology*, Volume 17, Issue 17, pp. 1796-1802.
- World Meteorological Organization, 1989: *Guide on the Global Observing System*, WMO-No. 488, Geneva.
- World Meteorological Organization, 1994a: *Information on Meteorological and Other Environmental Satellites*. Third edition. WMO-No. 411, Geneva.
- World Meteorological Organization, 1994b: *Application of Satellite Technology: Annual Progress Report 1993*. WMO Satellite Report No. SAT-12, WMO/TD-No. 628, Geneva.
- World Meteorological Organization, 2003: *Manual on the Global Observing System*. WMO-No. 544, Geneva.

CHAPTER 9

RADAR MEASUREMENTS

9.1 GENERAL

This chapter is an elementary discussion of meteorological microwave radars – the weather radar – used mostly to observe hydrometeors in the atmosphere. It places particular emphasis on the technical and operational characteristics that must be considered when planning, developing and operating radars and radar networks in support of Meteorological and Hydrological Services. It is supported by a substantial list of references. It also briefly mentions the high frequency radar systems used for observation of the ocean surface. Radars used for vertical profiles are discussed in Part II, Chapter 5.

9.1.1 The weather radar

Meteorological radars are capable of detecting precipitation and variations in the refractive index in the atmosphere which may be generated by local variations in temperature or humidity. Radar echoes may also be produced from airplanes, dust, birds or insects. This chapter deals with radars in common operational usage around the world. The meteorological radars having characteristics best suited for atmospheric observation and investigation transmit electromagnetic pulses in the 3–10 GHz frequency range (10–3 cm wavelength, respectively). They are designed for detecting and mapping areas of precipitation, measuring their intensity and motion, and perhaps their type. Higher frequencies are used to detect smaller hydrometeors, such as cloud or even fog droplets. Although this has valuable applications in cloud physics research, these frequencies are generally not used in operational forecasting because of excessive attenuation of the radar signal by the intervening medium. At lower frequencies, radars are capable of detecting variations in the refractive index of clear air, and they are used for wind profiling. Although they may detect precipitation, their scanning capabilities are limited by the size of the antenna required to achieve effective resolution.

The returned signal from the transmitted pulse encountering a weather target, called an echo, has an amplitude, a phase and a polarization. Most operational radars worldwide are still limited to analysis of the amplitude feature that is related to the size distribution and numbers of particles in the (pulse) volume illuminated by the radar beam. The

amplitude is used to determine a parameter called the reflectivity factor (Z) to estimate the mass of precipitation per unit volume or the intensity of precipitation through the use of empirical relations. A primary application is thus to detect, map and estimate the precipitation at ground level instantaneously, nearly continuously and over large areas.

Some research radars have used reflectivity factors measured at two polarizations of the transmitted and received waveform. Research continues to determine the value and potential of polarization systems for precipitation measurement and target state, but operational systems do not exist at present.

Doppler radars have the capability of determining the phase difference between the transmitted and received pulse. The difference is a measure of the mean Doppler velocity of the particles — the reflectivity weighted average of the radial components of the displacement velocities of the hydrometeors in the pulse volume. The Doppler spectrum width is a measurement of the spatial variability of the velocities and provides some indication of the wind shear and turbulence. Doppler radars offer a significant new dimension to weather radar observation and most new systems have this capability.

Modern weather radars should have characteristics optimized to produce the best data for operational requirements, and should be adequately installed, operated and maintained to utilize the capability of the system to the meteorologists' advantage.

9.1.2 Radar characteristics, terms and units

The selection of the radar characteristics, and consideration of the climate and the application, are important for determining the acceptable accuracy of measurements for precipitation estimation (Tables 9.1, 9.2 and 9.3).

9.1.3 Meteorological applications

Radar observations have been found most useful for the following:

- (a) Severe weather detection, tracking and warning;

- (b) Surveillance of synoptic and mesoscale weather systems;
- (c) Estimation of precipitation amounts.

The radar characteristics of any one radar will not be ideal for all applications. The selection criteria of a radar system are usually optimized to meet several applications, but they can also be specified to best meet a specific application of major importance. The choices of wavelength, beamwidth, pulse length, and pulse repetition frequencies (PRFs) have particular consequences. Users should therefore carefully consider the applications and climatology before determining the radar specifications.

Severe weather detection and warning

A radar is the only realistic surface-based means of monitoring severe weather over a wide area. Radar echo intensities, area and patterns can be used to identify areas of severe weather, including thunderstorms with probable hail and damaging winds. Doppler radars that can identify and provide a measurement of intense winds associated with gust fronts, downbursts and tornadoes add a new dimension. The nominal range of coverage is about 200 km, which is sufficient for local short-range forecasting and warning. Radar networks are used to extend the coverage (Browning and others, 1982). Effective warnings require effective interpretation performed by alert and well-trained personnel.

Table 9.1. Radar frequency bands

<i>Radar band</i>	<i>Frequency</i>	<i>Wavelength</i>	<i>Nominal</i>
<i>UHF</i>	300-1 000 MHz	1-0.3 m	70 cm
<i>L</i>	1 000-2 000 MHz	0.3-0.15 m	20 cm
<i>S^a</i>	2 000-4 000 MHz	15-7.5 cm	10 cm
<i>C^a</i>	4 000-8 000 MHz	7.5-3.75 cm	5 cm
<i>X^a</i>	8 000-12 500 MHz	3.75-2.4 cm	3 cm
<i>K_u</i>	12.5-18 GHz	2.4-1.66 cm	1.50 cm
<i>K</i>	18-26.5 GHz	1.66-1.13 cm	1.25 cm
<i>K_a</i>	26.5-40 GHz	1.13-0.75 cm	0.86 cm
<i>W</i>	94 GHz	0.30 cm	0.30 cm

^a Most common weather radar bands.

Table 9.2. Some meteorological radar parameters and units

<i>Symbol</i>	<i>Parameter</i>	<i>Units</i>
<i>Z_e</i>	Equivalent or effective radar reflectivity	mm ⁶ m ⁻³ or dBZ
<i>V_r</i>	Mean radial velocity	m s ⁻¹
<i>σ_v</i>	Spectrum width	m s ⁻¹
<i>Z_{dr}</i>	Differential reflectivity	dB
<i>CDR</i>	Circular depolarization ratio	dB
<i>LDR</i>	Linear depolarization ratio	dB
<i>k_{dp}</i>	Propagation phase	Degree km ⁻¹
<i>ρ</i>	Correlation coefficient	

Table 9.3. Physical radar parameters and units

<i>Symbol</i>	<i>Parameter</i>	<i>Units</i>
<i>c</i>	Speed of light	m s ⁻¹
<i>f</i>	Transmitted frequency	Hz
<i>f_d</i>	Doppler frequency shift	Hz
<i>P_r</i>	Received power	mW or dBm
<i>P_t</i>	Transmitted power	kW
<i>PRF</i>	Pulse repetition frequency	Hz
<i>T</i>	Pulse repetition time (=1/PRF)	ms
<i>Ω</i>	Antenna rotation rate	Degree s ⁻¹ or rpm
<i>λ</i>	Transmitted wavelength	cm
<i>φ</i>	Azimuth angle	Degree
<i>θ</i>	Beamwidth between half power points	Degree
<i>τ</i>	Pulse width	μs
<i>γ</i>	Elevation angle	Degree

Surveillance of synoptic and mesoscale systems

Radars can provide a nearly continuous monitoring of weather related to synoptic and mesoscale storms over a large area (say a range of 220 km,

area 125 000 km²) if unimpeded by hills. Owing to ground clutter at short ranges and the Earth's curvature, the maximum practical range for weather observation is about 200 km. Over large water areas, other means of observation are often not available or possible. Networks can extend the coverage and may be cost effective. Radars provide a good description of precipitation. Narrower beamwidths provide better resolution of patterns and greater effectiveness at longer ranges. In regions where very heavy and extensive precipitation is common, a 10-cm wavelength is needed for good precipitation measurements. In other areas, such as mid-latitudes, 5 cm radars may be effective at much lower cost. The 3 cm wavelength suffers from too much attenuation in precipitation to be very effective, except for very light rain or snow conditions. Development work is beginning on the concept of dense networks of 3 cm radars with polarimetric capabilities that could overcome the attenuation problem of stand-alone 3 cm radars.

Precipitation estimation

Radars have a long history of use in estimating the intensity and thereby the amount and distribution of precipitation with a good resolution in time and space. Most studies have been associated with rainfall, but snow measurements can also be taken with appropriate allowances for target composition. Readers should consult reviews by Joss and Waldvogel (1990), and Smith (1990) for a comprehensive discussion of the state of the art, the techniques, the problems and pitfalls, and the effectiveness and accuracy.

Ground-level precipitation estimates from typical radar systems are made for areas of typically 2 km², successively for 5–10 minute periods using low elevation plan position indicator scans with beamwidths of 1°. The radar estimates have been found to compare with spot precipitation gauge measurements within a factor of two. Gauge and radar measurements are both estimates of a continually varying parameter. The gauge samples an extremely small area (100 cm², 200 cm²), while the radar integrates over a volume, on a much larger scale. The comparability may be enhanced by adjusting the radar estimates with gauge measurements.

9.1.4 **Meteorological products**

A radar can be made to provide a variety of meteorological products to support various applications. The products that can be generated by a weather

radar depend on the type of radar, its signal processing characteristics, and the associated radar control and analysis system. Most modern radars automatically perform a volume scan consisting of a number of full azimuth rotations of the antenna at several elevation angles. All raw polar data are stored in a three-dimensional array, commonly called the volume database, which serves as the data source for further data processing and archiving. By means of application software, a wide variety of meteorological products is generated and displayed as images on a high-resolution colour display monitor. Grid or pixel values and conversion to x-y coordinates are computed using three-dimensional interpolation techniques. For a typical Doppler weather radar, the displayed variables are reflectivity, rainfall rate, radial velocity and spectrum width. Each image pixel represents the colour-coded value of a selected variable.

The following is a list of the measurements and products generated, most of which are discussed in this chapter:

- (a) The plan position indicator: A polar format display of a variable, obtained from a single full antenna rotation at one selected elevation. It is the classic radar display, used primarily for weather surveillance;
- (b) The range height indicator: A display of a variable obtained from a single elevation sweep, typically from 0 to 90°, at one azimuth. It is also a classic radar display that shows detailed cross-section structures and it is used for identifying severe storms, hail and the bright band;
- (c) The constant altitude plan position indicator (CAPPI): A horizontal cross-section display of a variable at a specified altitude, produced by interpolation from the volume data. It is used for surveillance and for identification of severe storms. It is also useful for monitoring the weather at specific flight levels for air traffic applications. The “no data” regions as seen in the CAPPI (close to and away from the radar with reference to the selected altitude) are filled with the data from the highest and lowest elevation, respectively, in another form of CAPPI, called “Pseudo CAPPI”;
- (d) Vertical cross-section: A display of a variable above a user-defined surface vector (not necessarily through the radar). It is produced by interpolation from the volume data;
- (e) The column maximum: A display, in plan, of the maximum value of a variable above each point of the area being observed;
- (f) Echo tops: A display, in plan, of the height of the highest occurrence of a selectable reflectivity contour, obtained by searching in

the volume data. It is an indicator of severe weather and hail;

- (g) Vertically integrated liquid: An indicator of the intensity of severe storms. It can be displayed, in plan, for any specified layer of the atmosphere.

In addition to these standard or basic displays, other products can be generated to meet the particular requirements of users for purposes such as hydrology, nowcasting (see section 9.10) or aviation:

- (a) Precipitation-accumulation: An estimate of the precipitation accumulated over time at each point in the area observed;
- (b) Precipitation subcatchment totals: Area-integrated accumulated precipitation;
- (c) Velocity azimuth display (VAD): An estimate of the vertical profile of wind above the radar. It is computed from a single antenna rotation at a fixed elevation angle;
- (d) Velocity volume processing, which uses three-dimensional volume data;
- (e) Storm tracking: A product from complex software to determine the tracks of storm cells and to predict future locations of storm centroids;
- (f) Wind shear: An estimate of the radial and tangential wind shear at a height specified by the user;
- (g) Divergence profile: An estimation of divergence from the radial velocity data from which divergence profile is obtained given some assumptions;
- (h) Mesocyclone: A product from sophisticated pattern recognition software that identifies rotation signatures within the three-dimensional base velocity data that are on the scale of the parent mesocyclonic circulation often associated with tornadoes;
- (i) Tornadic vortex signature: A product from sophisticated pattern recognition software that identifies gate-to-gate shear signatures within the three-dimensional base velocity data that are on the scale of tornadic vortex circulations.

9.1.5 Radar accuracy requirements

The accuracy requirements depend on the most important applications of the radar observations. Appropriately installed, calibrated and maintained modern radars are relatively stable and do not produce significant measurement errors. External factors, such as ground clutter effects, anomalous propagation, attenuation and propagation effects, beam effects, target composition, particularly with variations and changes in the vertical,

and rain rate-reflectivity relationship inadequacies, contribute most to the inaccuracy.

By considering only errors attributable to the radar system, the measurable radar parameters can be determined with an acceptable accuracy (Table 9.4).

Table 9.4. Accuracy requirements

<i>Parameter</i>	<i>Definition</i>	<i>Acceptable accuracy^a</i>
ϕ	Azimuth angle	0.1°
γ	Elevation angle	0.1°
V_r	Mean Doppler velocity	1.0 m s ⁻¹
Z	Reflectivity factor	1 dBZ
σ_v	Doppler spectrum width	1 m s ⁻¹

^a These figures are relative to a normal Gaussian spectrum with a standard deviation smaller than 4 m⁻¹. Velocity accuracy deteriorates when the spectrum width grows, while reflectivity accuracy improves.

9.2 RADAR TECHNOLOGY

9.2.1 Principles of radar measurement

The principles of radar and the observation of weather phenomena were established in the 1940s. Since that time, great strides have been made in improving equipment, signal and data processing and its interpretation. The interested reader should consult some of the relevant texts for greater detail. Good references include Skolnik (1970) for engineering and equipment aspects; Battan (1981) for meteorological phenomena and applications; Atlas (1964; 1990), Sauvageot (1982) and WMO (1985) for a general review; Rinehart (1991) for modern techniques; and Doviak and Zrnic (1993) for Doppler radar principles and applications. A brief summary of the principles follows.

Most meteorological radars are pulsed radars. Electromagnetic waves at fixed preferred frequencies are transmitted from a directional antenna into the atmosphere in a rapid succession of short pulses. Figure 9.1 shows a directional radar antenna emitting a pulsed-shaped beam of electromagnetic

energy over the Earth's curved surface and illuminating a portion of a meteorological target. Many of the physical limitations and constraints of the observation technique are immediately apparent from the figure. For example, there is a limit to the minimum altitude that can be observed at far ranges due to the curvature of the Earth.

A parabolic reflector in the antenna system concentrates the electromagnetic energy in a conical-shaped beam that is highly directional. The width of the beam increases with range, for example, a nominal 1° beam spreads to 0.9, 1.7 and 3.5 km at ranges of 50, 100, and 200 km, respectively.

The short bursts of electromagnetic energy are absorbed and scattered by any meteorological targets encountered. Some of the scattered energy is reflected back to the radar antenna and receiver. Since the electromagnetic wave travels with the speed of light (that is, $2.99 \times 10^8 \text{ m s}^{-1}$), by measuring the time between the transmission of the pulse and its return, the range of the target is determined. Between successive pulses, the receiver listens for any return of the wave. The return signal from the target is commonly referred to as the radar echo.

The strength of the signal reflected back to the radar receiver is a function of the concentration, size and water phase of the precipitation particles that make up the target. The power return, P_r , therefore provides a measure of the characteristics of the meteorological target and is, but not uniquely, related to a precipitation rate depending on the form of precipitation. The "radar range equation"

relates the power-return from the target to the radar characteristics and parameters of the target.

The power measurements are determined by the total power backscattered by the target within a volume being sampled at any one instant — the pulse volume (i.e. sample volume). The pulse volume dimensions are dependent on the radar pulse length in space (h) and the antenna beam widths in the vertical (ϕ_b) and the horizontal (θ_b). The beam width, and therefore the pulse volume, increases with range. Since the power that arrives back at the radar is involved in a two-way path, the pulse-volume length is only one half pulse length in space ($h/2$) and is invariant with range. The location of the pulse volume in space is determined by the position of the antenna in azimuth and elevation and the range to the target. The range (r) is determined by the time required for the pulse to travel to the target and to be reflected back to the radar.

Particles within the pulse volume are continuously shuffling relative to one another. This results in phase effects in the scattered signal and in intensity fluctuations about the mean target intensity. Little significance can be attached to a single echo intensity measurement from a weather target. At least 25 to 30 pulses must be integrated to obtain a reasonable estimation of mean intensity (Smith, 1995). This is normally carried out electronically in an integrator circuit. Further averaging of pulses in range, azimuth and time is often conducted to increase the sampling size and accuracy of the estimate. It follows that the space resolution is coarser.

9.2.2 The radar equation for precipitation targets

Meteorological targets consist of a volume of more or less spherical particles composed entirely of ice and/or water and randomly distributed in space. The power backscattered from the target volume is dependent on the number, size, composition, relative position, shape and orientation of the scattering particles. The total power backscattered is the sum of the power backscattered by each of the scattering particles.

Using this target model and electromagnetic theory, Probert-Jones (1962) developed an equation relating the echo power received by the radar to the parameters of the radar and the targets' range and scattering characteristics. It is generally accepted as being a reliable relationship to provide quantitative reflectivity measurements with good accuracy, bearing in mind the generally realistic assumptions made in the derivation:

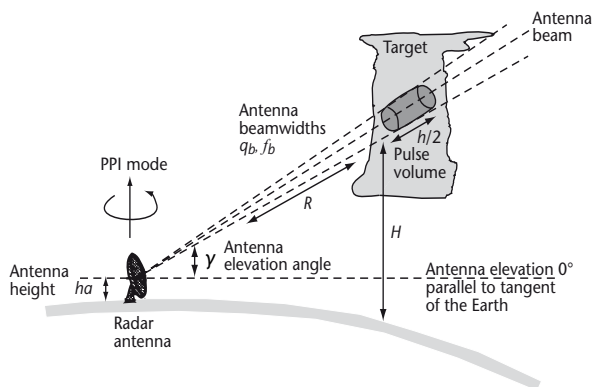

Figure 9.1. Propagation of electromagnetic waves through the atmosphere for a pulse weather radar; h_a is the height of the antenna above the Earth's surface, R is the range, h is the length of the pulse, $h/2$ is the sample volume depth and H is the height of the pulse above the Earth's surface

$$\bar{P}_r = \frac{\pi^3}{1024 \ln 2} \cdot \frac{P_t h G^2 \theta_b \phi_b}{\lambda^2} \cdot \frac{|K|^2 10^{-18} Z}{r^2} \quad (9.1)$$

where \bar{P}_r is the power received back at the radar, averaged over several pulses, in watts; P_t is the peak power of the pulse transmitted by the radar in watts; h is the pulse length in space, in metres ($h = c\tau/2$ where c is the speed of light and τ is the pulse duration); G is the gain of the antenna over an isotropic radiator; θ_b and ϕ_b are the horizontal and vertical beamwidths, respectively, of the antenna radiation pattern at the -3 dB level of one-way transmission, in radians; λ is the wavelength of the transmitted wave, in metres; $|K|^2$ is the refractive index factor of the target; r is the slant range from the radar to the target, in metres; and Z is the radar reflectivity factor (usually taken as the equivalent reflectivity factor Z_e when the target characteristics are not well known), in $\text{mm}^6 \text{m}^{-3}$.

The second term in the equation contains the radar parameters, and the third term the parameters depending on the range and characteristics of the target. The radar parameters, except for the transmitted power, are relatively fixed, and, if the transmitter is operated and maintained at a constant output (as it should be), the equation can be simplified to:

$$\bar{P}_r = \frac{C |K|^2 Z}{r^2} \quad (9.2)$$

where C is the radar constant.

There are a number of basic assumptions inherent in the development of the equation which have varying importance in the application and interpretation of the results. Although they are reasonably realistic, the conditions are not always met exactly and, under particular conditions, will affect the measurements (Aoyagi and Kodaira, 1995). These assumptions are summarized as follows:

- (a) The scattering precipitation particles in the target volume are homogeneous dielectric spheres whose diameters are small compared to the wavelength, that is $D < 0.06 \lambda$ for strict application of Rayleigh scattering approximations;
- (b) The pulse volume is completely filled with randomly scattered precipitation particles;
- (c) The reflectivity factor Z is uniform throughout the sampled pulse volume and constant during the sampling interval;
- (d) The particles are all water drops or all ice particles, that is, all particles have the same refractive index factor $|K|^2$ and the power scattering by the particles is isotropic;

- (e) Multiple scattering (among particles) is negligible;
- (f) There is no attenuation in the intervening medium between the radar and the target volume;
- (g) The incident and backscattered waves are linearly co-polarized;
- (h) The main lobe of the antenna radiation pattern is Gaussian in shape;
- (i) The antenna is a parabolic reflector type of circular cross-section;
- (j) The gain of the antenna is known or can be calculated with sufficient accuracy;
- (k) The contribution of the side lobes to the received power is negligible;
- (l) Blockage of the transmitted signal by ground clutter in the beam is negligible;
- (m) The peak power transmitted (P_t) is the actual power transmitted at the antenna, that is, all wave guide losses, and so on, and attenuation in the radar dome, are considered;
- (n) The average power measured (P_r) is averaged over a sufficient number of pulses or independent samples to be representative of the average over the target pulse volume.

This simplified expression relates the echo power measured by the radar to the radar reflectivity factor Z , which is in turn related to the rainfall rate. These factors and their relationship are crucial for interpreting the intensity of the target and estimating precipitation amounts from radar measurements. Despite the many assumptions, the expression provides a reasonable estimate of the target mass. This estimate can be improved by further consideration of factors in the assumptions.

9.2.3 Basic weather radar

The basic weather radar consists of the following:

- (a) A transmitter to produce power at microwave frequency;
- (b) An antenna to focus the transmitted microwaves into a narrow beam and receive the returning power;
- (c) A receiver to detect, amplify and convert the microwave signal into a low frequency signal;
- (d) A processor to extract the desired information from the received signal;
- (e) A system to display the information in an intelligible form.

Other components that maximize the radar capability are:

- (a) A processor to produce supplementary displays;

- (b) A recording system to archive the data for training, study and records.

A basic weather radar may be non-coherent, that is, the phase of successive pulses is random and unknown.

Almost exclusively current systems use computers for radar control, digital signal processing, recording, product displays and archiving.

The power backscattered from a typical radar is of the order of 10^{-8} to 10^{-15} W, covering a range of about 70 dB from the strongest to weakest targets detectable. To adequately cover this range of signals, a logarithmic receiver was used in the past. However, modern operational and research radars with linear receivers with 90 dB dynamic range (and other sophisticated features) are just being introduced (Heiss, McGrew and Sirmans, 1990; Keeler, Hwang and Loew, 1995). Many pulses must be averaged in the processor to provide a significant measurement; they can be integrated in different ways, usually in a digital form, and must account for the receiver transfer function (namely, linear or logarithmic). In practice, for a typical system, the signal at the antenna is received, amplified, averaged over many pulses, corrected for receiver transfer, and converted to a reflectivity factor Z using the radar range equation.

The reflectivity factor is the most important parameter for radar interpretation. The factor derives from the Rayleigh scattering model and is defined theoretically as the sum of particle (drops) diameters to the sixth power in the sample volume:

$$Z = \sum_{vol} D^6 \quad (9.3)$$

where the unit of Z is $\text{mm}^6 \text{m}^{-3}$. In many cases, the numbers of particles, composition and shape are not known and an equivalent or effective reflectivity factor Z_e is defined. Snow and ice particles must refer to an equivalent Z_e which represents Z , assuming the backscattering particles were all spherical drops.

A common practice is to work in a logarithmic scale or dBZ units which are numerically defined as $\text{dBZ} = 10 \log_{10} Z_e$.

Volumetric observations of the atmosphere are normally made by scanning the antenna at a fixed elevation angle and subsequently incrementing the elevation angle in steps at each revolution. An important consideration is the resolution of the targets. Parabolic reflector antennas are used to

focus the waves into a pencil shaped beam. Larger reflectors create narrower beams, greater resolution and sensitivity at increasing costs. The beamwidth, the angle subtended by the line between the two points on the beam where the power is one half that at the axis, is dependent on the wavelength, and may be approximated by:

$$\theta_e = \frac{70\lambda}{d} \quad (9.4)$$

where the units of θ_e are degrees; and d is the antenna diameter in the same units as λ . Good weather radars have beamwidths of 0.5 to 1°.

The useful range of weather radars, except for long-range detection only of thunderstorms, is of the order of 200 km. The beam at an elevation of, for example, 0.5° is at a height of 4 km above the Earth's surface. Also, the beamwidth is of the order of 1.5 km or greater. For good quantitative precipitation measurements, the range is less than 200 km. At long ranges, the beam is too high for ground estimates. Also, beam spreading reduces resolution and the measurement can be affected by underfilling with target. Technically, there is a maximum unambiguous range determined by the pulse repetition frequency (equation 9.6) since the range must be measured during the listening period between pulses. At usual PRFs this is not a problem. For example, with a PRF of 250 pulses per second, the maximum range is 600 km. At higher PRFs, typically 1 000 pulses per second, required for Doppler systems, the range will be greatly reduced to about 150 km. New developments may ameliorate this situation (Joe, Passarelli and Siggia, 1995).

9.2.4 Doppler radar

The development of Doppler weather radars and their introduction to weather surveillance provide a new dimension to the observations (Heiss, McGrew and Sirmans, 1990). Doppler radar provides a measure of the targets' velocity along a radial from the radar in a direction either towards or away from the radar. A further advantage of the Doppler technique is the greater effective sensitivity to low reflectivity targets near the radar noise level when the velocity field can be distinguished in a noisy Z field.

At the normal speeds of meteorological targets, the frequency shift is relatively small compared with the radar frequency and is very difficult to measure. An easier task is to retain the phase of the transmitted pulse, compare it with the phase of the received pulse and then determine the change in phase between successive pulses. The time rate

of change of the phase is then directly related to the frequency shift, which in turn is directly related to the target velocity – the Doppler effect. If the phase changes by more than $\pm 180^\circ$, the velocity estimate is ambiguous. The highest unambiguous velocity that can be measured by a Doppler radar is the velocity at which the target moves, between successive pulses, more than a quarter of the wavelength. At higher speeds, an additional processing step is required to retrieve the correct velocity.

The maximum unambiguous Doppler velocity depends on the radar wavelength (λ), and the PRF and can be expressed as:

$$V_{max} = \pm \frac{PRF \cdot \lambda}{4} \quad (9.5)$$

The maximum unambiguous range can be expressed as:

$$r_{max} = \frac{c}{PRF \cdot 2} \quad (9.6)$$

Thus, V_{max} and r_{max} are related by the equation:

$$V_{max} r_{max} = \pm \frac{\lambda c}{8} \quad (9.7)$$

These relationships show the limits imposed by the selection of the wavelength and PRF. A high PRF is desirable to increase the unambiguous velocity; a low PRF is desirable to increase the radar range. A compromise is required until better technology is available to retrieve the information unambiguously outside these limits (Doviak and Zrnic, 1993; Joe, Passarelli and Siggia, 1995). The relationship also shows that the longer wavelengths have higher limits. In numerical terms, for a typical S-band radar with a PRF of 1 000 Hz, $V_{max} = \pm 25 \text{ m s}^{-1}$, while for an X-band radar $V_{max} = \pm 8 \text{ m s}^{-1}$.

Because the frequency shift of the returned pulse is measured by comparing the phases of the transmitted and received pulses, the phase of the transmitted pulses must be known. In a non-coherent radar, the phase at the beginning of successive pulses is random and unknown, so such a system cannot be used for Doppler measurements; however, it can be used for the basic operations described in the previous section.

Some Doppler radars are fully coherent; their transmitters employ very stable frequency sources, in which phase is determined and known from pulse to pulse. Semi-coherent radar systems, in which the

phase of successive pulses is random but known, are cheaper and more common. Fully coherent radars typically employ klystrons in their high-power output amplifiers and have their receiver frequencies derived from the same source as their transmitters. This approach greatly reduces the phase instabilities found in semi-coherent systems, leading to improved ground clutter rejection and better discrimination of weak clear-air phenomena which might otherwise be masked. The microwave transmitter for non-coherent and semi-coherent radars is usually a magnetron, given that it is relatively simple, cheaper and provides generally adequate performance for routine observations. A side benefit of the magnetron is the reduction of Doppler response to second or third trip echoes (echoes arriving from beyond the maximum unambiguous range) due to their random phase, although the same effect could be obtained in coherent systems by introducing known pseudo-random phase disturbances into the receiver and transmitter.

Non-coherent radars can be converted relatively easily to a semi-coherent Doppler system. The conversion should also include the more stable coaxial-type magnetron.

Both reflectivity factor and velocity data are extracted from the Doppler radar system. The target is typically a large number of hydrometeors (rain drops, snow flakes, ice pellets, hail, etc.) of all shapes and sizes and moving at different speeds due to the turbulent motion within the volume and due to their fall speeds. The velocity field is therefore a spectrum of velocities — the Doppler spectrum (Figure 9.2).

Two systems of different complexity are used to process the Doppler parameters. The simpler pulse pair processing (PPP) system uses the comparison of successive pulses in the time domain to extract mean velocity and spectrum width. The second and more complex system uses a fast Fourier transform (FFT) processor to produce a full spectrum of velocities in each sample volume. The PPP system is faster, less computationally intensive and better at low signal-to-noise ratios, but has poorer clutter rejection characteristics than the FFT system. Modern systems try to use the best of both approaches by removing clutter using FFT techniques and subsequently use PPP to determine the radial velocity and spectral width.

9.2.5 Polarization diversity radars

Experiments with polarization diversity radars have been under way for many years to determine their potential for enhanced radar observations of

the weather (Bringi and Hendry, 1990). Promising studies point towards the possibility of differentiating between hydrometeor types, a step to discriminating between rain, snow and hail. There are practical technical difficulties, and the techniques and applications have not progressed beyond the research stage to operational usage. The potential value of polarization diversity measurements for precipitation measurement would seem to lie in the fact that better drop size distribution and knowledge of the precipitation types would improve the measurements. Recent work at the United States National Severe Storms Laboratory (Melnikov and others, 2002) on adding polarimetric capability to the NEXRAD radar has demonstrated a robust engineering design utilizing simultaneous transmission and reception of both horizontally and vertically polarized pulses. The evaluation of polarimetric moments, and derived products for rainfall accumulation and hydrometeor classification, has shown that this design holds great promise as a basis for adding polarization diversity to the entire NEXRAD network.

There are two basic radar techniques in current usage. One system transmits a circularly polarized wave, and the copolar and orthogonal polarizations are measured. The other system alternately transmits pulses with horizontal then vertical polarization utilizing a high-power switch. The linear system is generally preferred since meteorological information retrieval is less calculation intensive. The latter technique is more common as conventional radars

are converted to have polarization capability. However, the former type of system has some distinct technological advantages. Various polarization bases (Holt, Chandra and Wood, 1995) and dual transmitter systems (Mueller and others, 1995) are in the experimental phase. The main differences in requirements from conventional radars relate to the quality of the antenna system, the accuracy of the electronic calibration and signal processing. Matching the beams, switching polarizations and the measurement of small differences in signals are formidable tasks requiring great care when applying the techniques.

The technique is based on micro-differences in the scattering particles. Spherical raindrops become elliptically shaped with the major axis in the horizontal plane when falling freely in the atmosphere. The oblateness of the drop is related to drop size. The power backscattered from an oblate spheroid is larger for a horizontally polarized wave than for a vertically polarized wave assuming Rayleigh scattering. Using suitable assumptions, a drop size distribution can be inferred and thus a rainfall rate can be derived.

The differential reflectivity, called Z_{DR} , is defined as 10 times the logarithm of the ratio of the horizontally polarized reflectivity Z_H and the vertically polarized reflectivity Z_V . Comparisons of the equivalent reflectivity factor Z_e and the differential reflectivity Z_{DR} suggest that the target may be separated as being hail, rain, drizzle or snow (Seliga and Bringi, 1976).

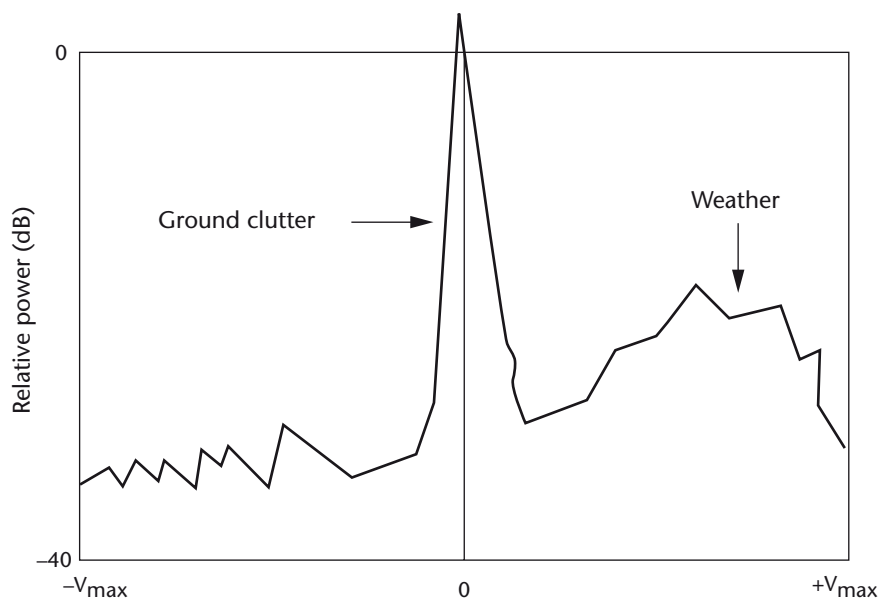

Figure 9.2. The Doppler spectrum of a weather echo and a ground target. The ground target contribution is centred on zero and is much narrower than the weather echo.

As an electromagnetic wave propagates through a medium with oblate particles, the phase of the incident beam is altered. The effect on the vertical and horizontal phase components depends on the oblateness and is embodied in a parameter termed the specific differential phase (K_{DP}). For heavy rainfall measurements, K_{DP} has certain advantages (Zrníc and Ryzhkov, 1995). English and others (1991) demonstrated that the use of K_{DP} for rainfall estimation is much better than Z for rainfall rates greater than about 20 mm hr⁻¹ at the S-band.

Propagation effects on the incident beam due to the intervening medium can dominate target backscatter effects and confound the interpretation of the resulting signal. Bebbington (1992) designed a parameter for a circularly polarized radar, termed the degree of polarization, which was insensitive to propagation effects. This parameter is similar to linear correlation for linearly polarized radars. It appears to have value in target discrimination. For example, extremely low values are indicative of scatterers that are randomly oriented such as those caused by airborne grass or ground clutter (Holt and others, 1993).

9.2.6 Ground clutter rejection

Echoes due to non-precipitation targets are known as clutter, and should be eliminated. Echoes caused by clear air or insects which can be used to map out wind fields are an exception. Clutter can be the result of a variety of targets, including buildings, hills, mountains, aircraft and chaff, to name just a few. Good radar siting is the first line of defence against ground clutter effects. However, clutter is always present to some extent. The intensity of ground clutter is inversely proportional to wavelength (Skolnik, 1970), whereas backscatter from rain is inversely proportional to the fourth power of wavelength. Therefore, shorter wavelength radars are less affected by ground clutter.

Point targets, like aircraft, can be eliminated, if they are isolated, by removing echoes that occupy a single radar resolution volume. Weather targets are distributed over several radar resolution volumes. The point targets can be eliminated during the data-processing phase. Point targets, like aircraft echoes, embedded within precipitation echoes may not be eliminated with this technique depending on relative strength.

Distributed targets require more sophisticated signal and data-processing techniques. A conceptually attractive idea is to use clutter maps. The patterns of radar echoes in non-precipitating conditions are

used to generate a clutter map that is subtracted from the radar pattern collected in precipitating conditions. The problem with this technique is that the pattern of ground clutter changes over time. These changes are primarily due to changes in meteorological conditions; a prime example is anomalous propagation echoes that last several hours and then disappear. Micro-changes to the environment cause small fluctuations in the pattern of ground echoes which confound the use of clutter maps. Adaptive techniques (Joss and Lee, 1993) attempt to determine dynamically the clutter pattern to account for the short-term fluctuations, but they are not good enough to be used exclusively, if at all.

Doppler processing techniques attempt to remove the clutter from the weather echo from a signal-processing perspective. The basic assumption is that the clutter echo is narrow in spectral width and that the clutter is stationary. However, to meet these first criteria, a sufficient number of pulses must be acquired and processed in order to have sufficient spectral resolution to resolve the weather from the clutter echo. A relatively large Nyquist interval is also needed so that the weather echo can be resolved. The spectral width of ground clutter and weather echo is generally much less than 1–2 m s⁻¹ and greater than 1⁻² m s⁻¹, respectively. Therefore, Nyquist intervals of about 8 m s⁻¹ are needed. Clutter is generally stationary and is identified as a narrow spike at zero velocity in the spectral representation (Figure 9.2). The spike has finite width because the ground echo targets, such as swaying trees, have some associated motions. Time domain processing to remove the zero velocity (or DC) component of a finite sequence is problematic since the filtering process will remove weather echo at zero velocity as well (Zrníc and Hamidi, 1981). Adaptive spectral (Fourier transform) processing can remove the ground clutter from the weather echoes even if they are overlapped (Passarelli and others, 1981; Crozier and others, 1991). This is a major advantage of spectral processing. Stripped of clutter echo, the significant meteorological parameters can be computed.

An alternative approach takes advantage of the observation that structures contributing to ground clutter are very small in scale (less than, for example, 100 m). Range sampling is carried out at a very fine resolution (less than 100 m) and clutter is identified using reflectivity and Doppler signal processing. Range averaging (to a final resolution of 1 km) is performed with clutter-free range bins. The philosophy is to detect and ignore range bins with clutter, rather than to correct for

the clutter (Joss and Lee, 1993; Lee, Della Bruna and Joss, 1995). This is radically different from the previously discussed techniques and it remains to be seen whether the technique will be effective in all situations, in particular in anomalous propagation situations where the clutter is widespread.

Polarization radars can also identify clutter. However, more work is needed to determine their advantages and disadvantages.

Clutter can be reduced by careful site selection (see section 9.7). Radars used for long-range surveillance, such as for tropical cyclones or in a widely scattered network, are usually placed on hilltops to extend the useful range, and are therefore likely to see many clutter echoes. A simple suppression technique is to scan automatically at several elevations, and to discard the data at the shorter ranges from the lower elevations, where most of the clutter exists. By processing the radar data into CAPPI products, low elevation data is rejected automatically at short ranges.

9.3 PROPAGATION AND SCATTERING OF RADAR SIGNALS

Electromagnetic waves propagate in straight lines, in a homogeneous medium, with the speed of light. The Earth's atmosphere is not homogeneous and microwaves undergo refraction, absorption and scattering along their path. The atmosphere is usually vertically stratified and the rays change direction depending on the changes in height of the refractive index (or temperature and moisture). When the waves encounter precipitation and clouds, part of the energy is absorbed and a part is scattered in all directions or back to the radar site.

9.3.1 Refraction in the atmosphere

The amount of bending of electromagnetic waves can be predicted by using the vertical profile of temperature and moisture (Bean and Dutton, 1966). Under normal atmospheric conditions, the waves travel in a curve bending slightly earthward. The ray path can bend either upwards (sub-refraction) or more earthward (super-refraction). In either case, the altitude of the beam will be in error using the standard atmosphere assumption.

From a precipitation measurement standpoint, the greatest problem occurs under super-refractive or "ducting" conditions. The ray can bend sufficiently

to strike the Earth and cause ground echoes not normally encountered. The phenomenon occurs when the index of refraction decreases rapidly with height, for example, an increase in temperature and a decrease in moisture with height. These echoes must be dealt with in producing a precipitation map. This condition is referred to as anomalous propagation (AP or ANAPROP).

Some "clear air" echoes are due to turbulent inhomogeneities in the refractive index found in areas of turbulence, layers of enhanced stability, wind shear cells, or strong inversions. These echoes usually occur in patterns, mostly recognizable, but must be eliminated as precipitation fields (Gossard and Strauch, 1983).

9.3.2 Attenuation in the atmosphere

Microwaves are subject to attenuation owing to atmospheric gases, clouds and precipitation by absorption and scattering.

Attenuation by gases

Gases attenuate microwaves in the 3–10 cm bands. Absorption by atmospheric gases is due mainly to water vapour and oxygen molecules. Attenuation by water vapour is directly proportional to the pressure and absolute humidity and increases almost linearly with decreasing temperature. The concentration of oxygen, to altitudes of 20 km, is relatively uniform. Attenuation is also proportional to the square of the pressure.

Attenuation by gases varies slightly with the climate and the season. It is significant at weather radar wavelengths over the longer ranges and can amount to 2 to 3 dB at the longer wavelengths and 3 to 4 dB at the shorter wavelengths, over a range of 200 km. Compensation seems worthwhile and can be quite easily accomplished automatically. Attenuation can be computed as a function of range on a seasonal basis for ray paths used in precipitation measurement and applied as a correction to the precipitation field.

Attenuation by hydrometeors

Attenuation by hydrometeors can result from both absorption and scattering. It is the most significant source of attenuation. It is dependent on the shape, size, number and composition of the particles. This dependence has made it very difficult to overcome in any quantitative way using radar observations alone. It has not been satisfactorily overcome for automated operational measurement systems yet. However, the phenomenon must be recognized and

the effects reduced by some subjective intervention using general knowledge.

Attenuation is dependent on wavelength. At 10 cm wavelengths, the attenuation is rather small, while at 3 cm it is quite significant. At 5 cm, the attenuation may be acceptable for many climates, particularly in the high mid-latitudes. Wavelengths below 5 cm are not recommended for good precipitation measurement except for short-range applications (Table 9.5).

Table 9.5. One-way attenuation relationships

Wavelength (cm)	Relation (dB km ⁻¹)
10	0.000 343 R ^{0.97}
5	0.00 18 R ^{1.05}
3.2	0.01 R ^{1.21}

After Burrows and Attwood (1949). One-way specific attenuations at 18°C. R is in units of mm hr⁻¹.

For precipitation estimates by radar, some general statements can be made with regard to the magnitude of attenuation. Attenuation is dependent on the water mass of the target, thus heavier rains attenuate more; clouds with much smaller mass attenuate less. Ice particles attenuate much less than liquid particles. Clouds and ice clouds cause little attenuation and can usually be ignored. Snow or ice particles (or hailstones) can grow much larger than raindrops. They become wet as they begin to melt and result in a large increase in reflectivity and, therefore, in attenuation properties. This can distort precipitation estimates.

9.3.3 Scattering by clouds and precipitation

The signal power detected and processed by the radar (namely, echo) is power backscattered by the target, or by hydrometeors. The backscattering cross-section (σ_b) is defined as the area of an isotropic scatterer that would return to the emitting source the same amount of power as the actual target. The backscattering cross-section of spherical particles was first determined by Mie (1908). Rayleigh found that, if the ratio of the particle diameter to the wavelength was equal to or less than 0.06, a simpler expression could be used to determine the backscatter cross-section:

$$\sigma_b = \frac{\pi^5 |K|^2 D^6}{\lambda^4} \tag{9.8}$$

which is the justification for equation 9.3. $|K|^2$, the refractive index factor, is equal to 0.93 for liquid water and 0.197 for ice.

The radar power measurements are used to derive the scattering intensity of the target by using equation 9.2 in the form:

$$z = \frac{C \bar{P}_r r^2}{|K|^2} \tag{9.9}$$

The method and problems of interpreting the reflectivity factor in terms of precipitation rate (R) are discussed in section 9.9.

9.3.4 Scattering in clear air

In regions without precipitating clouds, it has been found that echoes are mostly due to insects or to strong gradients of refractive index in the atmosphere. The echoes are of very low intensity and are detected only by very sensitive radars. Equivalent Z_e values for clear air phenomena generally appear in the range of -5 to -55 dBZ, although these are not true Z parameters, with the physical process generating the echoes being entirely different. For precipitation measurement, these echoes are a minor “noise” in the signal. They can usually be associated with some meteorological phenomenon such as a sea breeze or thunderstorm outflows. Clear air echoes can also be associated with birds and insects in very low concentrations. Echo strengths of 5 to 35 dBZ are not unusual, especially during migrations (Table 9.6).

Table 9.6. Typical backscatter cross-sections for various targets

Object	σ_b (m ²)
Aircraft	10 to 1 000
Human	0.14 to 1.05
Weather balloon	0.01
Birds	0.001 to 0.01
Bees, dragonflies, moths	3 x 10 ⁻⁶ to 10 ⁻⁵
2 mm water drop	1.8 x 10 ⁻¹⁰

Although normal radar processing would interpret the signal in terms of Z or R, the scattering properties of the clear atmosphere are quite different from that of hydrometeors. It is most often expressed in terms of the structure parameter of refractive index, C_n^2 . This is a measure of the mean-square fluctuations

of the refractive index as a function of distance (Gossard and Strauch, 1983).

9.4 VELOCITY MEASUREMENTS

9.4.1 The Doppler spectrum

Doppler radars measure velocity by estimating the frequency shift produced by an ensemble of moving targets. Doppler radars also provide information about the total power returned and about the spectrum width of the precipitation particles within the pulse volume. The mean Doppler velocity is equal to the mean motion of scatterers weighted by their cross-sections and, for near horizontal antenna scans, is essentially the air motion towards or away from the radar. Likewise, the spectrum width is a measure of the velocity dispersion, that is, the shear or turbulence within the resolution volume.

A Doppler radar measures the phase of the returned signal by referencing the phase of the received signal to the transmitter. The phase is measured in rectangular form by producing the in-phase (I) and quadrature (Q) components of the signal. The I and Q are samples at a fixed range location. They are collected and processed to obtain the mean velocity and spectrum width.

9.4.2 Doppler ambiguities

To detect returns at various ranges from the radar, the returning signals are sampled periodically, usually about every μs , to obtain information about every 150 m in range. This sampling can continue until it is time to transmit the next pulse. A sample point in time (corresponding to a distance from the radar) is called a range gate. The radial wind component throughout a storm or precipitation area is mapped as the antenna scans.

A fundamental problem with the use of any pulse Doppler radar is the removal of ambiguity in Doppler mean velocity estimates, that is, velocity folding. Discrete equi-spaced samples of a time-varying function result in a maximum unambiguous frequency equal to one half of the sampling frequency (f_s). Subsequently, frequencies greater than $f_s/2$ are aliased ("folded") into the Nyquist co-interval ($\pm f_s/2$) and are interpreted as velocities within $\pm \lambda f_s/4$, where λ is the wavelength of transmitted energy.

Techniques to dealias the velocities include dual PRF techniques (Crozier and others, 1991; Doviak

and Zrnic, 1993) or continuity techniques (Eilts and Smith, 1990). In the former, radial velocity estimates are collected at two different PRFs with different maximum unambiguous velocities and are combined to yield a new estimate of the radial velocity with an extended unambiguous velocity. For example, a C band radar using PRFs of 1 200 and 900 Hz has nominal unambiguous velocities of 16 and 12 m s⁻¹, respectively. The amount of aliasing can be deduced from the difference between the two velocity estimates to dealias the velocity to an extended velocity range of ± 48 m s⁻¹ (Figure 9.3).

Continuity techniques rely on having sufficient echo to discern that there are aliased velocities and correcting them by assuming velocity continuity (no discontinuities of greater than $2V_{max}$).

There is a range limitation imposed by the use of high PRFs (greater than about 1 000 Hz) as described in section 9.2. Echoes beyond the maximum range will be aliased back into the primary range. For radars with coherent transmitters (e.g. klystron systems), the echoes will appear within the primary range. For coherent-on-receive systems, the second trip echoes will appear as noise (Joe, and Passarelli and Siggia, 1995; Passarelli and others 1981).

9.4.3 Vertically pointing measurements

In principle, a Doppler radar operating in the vertically-pointing mode is an ideal tool for obtaining accurate cloud-scale measurements of vertical wind speeds and drop-size distributions (DSDs). However, the accuracy of vertical velocities and DSDs derived from the Doppler spectra have been limited by the strong mathematical interdependence of the two quantities. The real difficulty is that the Doppler spectrum is measured as a function of the scatterers' total vertical velocity – due to terminal hydrometeor fall speeds, plus updrafts or downdrafts. In order to compute the DSD from a Doppler spectrum taken at vertical incidence, the spectrum must be expressed as a function of terminal velocity alone. Errors of only ± 0.25 m s⁻¹ in vertical velocity can cause errors of 100 per cent in drop number concentrations (Atlas, Scrivastava and Sekhon, 1973). A dual-wavelength technique has been developed (termed the Ratio method) by which vertical air velocity may be accurately determined independently of the DSD. In this approach, there is a trade-off between potential accuracy and potential for successful application.

9.4.4 Measurement of velocity fields

A great deal of information can be determined in real time from a single Doppler radar. It should be noted that the interpretation of radial velocity estimates from a single radar is not always unambiguous. Colour displays of single-Doppler radial velocity patterns aid in the real-time interpretation of the associated reflectivity fields and can reveal important features not evident in the reflectivity structures alone (Burgess and Lemon, 1990). Such a capability is of particular importance in the identification and tracking of severe storms. On typical colour displays, velocities between $\pm V_{max}$ are assigned 1 of 8 to 15 colours or more. Velocities extending beyond the Nyquist interval enter the scale of colours at the opposite end. This process may be repeated if the velocities are aliased more than one Nyquist interval.

Doppler radar can also be used to derive vertical profiles of horizontal winds. When the radar's antenna is tilted above the horizontal, increasing range implies increasing height. A profile of wind with height can be obtained by sinusoidal curve-fitting to the observed data (termed velocity azimuth display (VAD) after Lhermitte and Atlas, 1961) if the wind is relatively uniform over the area of the scan. The winds along the zero radial velocity contour are perpendicular to the radar beam axis. The colour display may be used to easily interpret VAD data obtained from large-scale precipitation systems. Typical elevated conical scan patterns in widespread

precipitation reveal an S-shaped zero radial velocity contour as the mean wind veers with height (Wood and Brown, 1986). On other occasions, closed contours representing jets are evident.

Since the measurement accuracy is good, divergence estimates can also be obtained by employing the VAD technique. This technique cannot be accurately applied during periods of convective precipitation around the radar. However, moderately powerful, sensitive Doppler radars have successfully obtained VAD wind profiles and divergence estimates in the optically clear boundary layer during all but the coldest months, up to heights of 3 to 5 km above ground level. The VAD technique seems well suited for winds from precipitation systems associated with extratropical and tropical cyclones. In the radar's clear-air mode, a time series of measurements of divergence and derived vertical velocity is particularly useful in nowcasting the probability of deep convection.

Since the mid-1970s, experiments have been made for measuring three-dimensional wind fields using multiple Doppler arrays. Measurements taken at a given location inside a precipitation area may be combined, by using a proper geometrical transformation, in order to obtain the three wind components. Such estimations are also possible with only two radars, using the continuity equation. Kinematic analysis of a wind field is described in Browning and Wexler (1968).

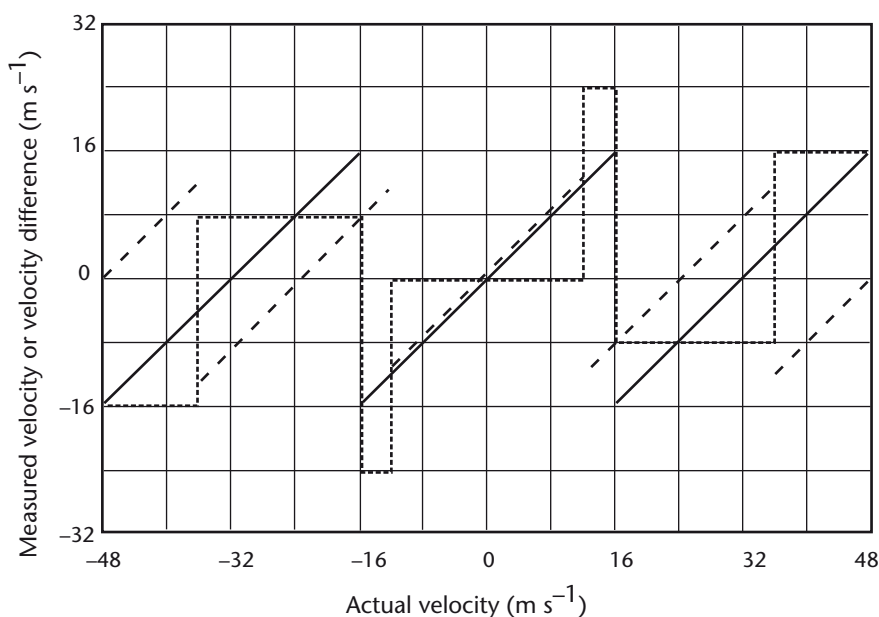

Figure 9.3. Solid and dashed lines show Doppler velocity measurements taken with two different pulse repetition frequencies (1 200 and 900 Hz for a C band radar). Speeds greater than the maximum unambiguous velocities are aliased. The differences (dotted line) between the Doppler velocity estimates are distinct and can be used to identify the degree of aliasing.

9.5 SOURCES OF ERROR

Radar beam filling

In many cases, and especially at large ranges from the radar, the pulse volume is not completely filled with homogeneous precipitation. Precipitation intensities often vary widely on small scales; at large distances from the radar, the pulse volume increases in size. At the same time, the effects of the Earth's curvature become significant. In general, measurements may be quantitatively useful for ranges of less than 100 km. This effect is important for cloud-top height measurements and the estimation of reflectivity.

Non-uniformity of the vertical distribution of precipitation

The first parameter of interest when taking radar measurements is usually precipitation at ground level. Because of the effects of beam width, beam tilting and the Earth's curvature, radar measurements of precipitation are higher than average over a considerable depth. These measurements are dependent on the details of the vertical distribution of precipitation and can contribute to large errors for estimates of precipitation on the ground.

Variations in the Z-R relationship

A variety of Z-R relationships have been found for different precipitation types. However, from the radar alone (except for dual polarized radars) these variations in the types and size distribution of hydrometeors cannot be estimated. In operational applications, this variation can be a significant source of error.

Attenuation by intervening precipitation

Attenuation by rain may be significant, especially at the shorter radar wavelengths (5 and 3 cm). Attenuation by snow, although less than for rain, may be significant over long path lengths.

Beam blocking

Depending on the radar installation, the radar beam may be partly or completely occulted by the topography or obstacles located between the radar and the target. This results in underestimations of reflectivity and, hence, of rainfall rate.

Attenuation due to a wet radome

Most radar antennas are protected from wind and rain by a radome, usually made of fibreglass. The

radome is engineered to cause little loss in the radiated energy. For instance, the two-way loss due to this device can be easily kept to less than 1 dB at the C band, under normal conditions. However, under intense rainfall, the surface of the radome can become coated with a thin film of water or ice, resulting in a strong azimuth dependent attenuation. Experience with the NEXRAD WSR-88D radars shows that coating radomes with a special hydrophobic paint essentially eliminates this source of attenuation, at least at 10 cm wavelengths.

Electromagnetic interference

Electromagnetic interference from other radars or devices, such as microwave links, may be an important factor of error in some cases. This type of problem is easily recognized by observation. It may be solved by negotiation, by changing frequency, by using filters in the radar receiver, and sometimes by software.

Ground clutter

The contamination of rain echoes by ground clutter may cause very large errors in precipitation and wind estimation. The ground clutter should first be minimized by good antenna engineering and a good choice of radar location. This effect may be greatly reduced by a combination of hardware clutter suppression devices (Aoyagi, 1983) and through signal and data processing. Ground clutter is greatly increased in situations of anomalous propagation.

Anomalous propagation

Anomalous propagation distorts the radar beam path and has the effect of increasing ground clutter by refracting the beam towards the ground. It may also cause the radar to detect storms located far beyond the usual range, making errors in their range determination because of range aliasing. Anomalous propagation is frequent in some regions, when the atmosphere is subject to strong decreases in humidity and/or increases in temperature with height. Clutter returns owing to anomalous propagation may be very misleading to untrained human observers and are more difficult to eliminate fully by processing them as normal ground clutter.

Antenna accuracy

The antenna position may be known within 0.2° with a well-engineered system. Errors may also be produced by the excessive width of the radar beam

or by the presence of sidelobes, in the presence of clutter or of strong precipitation echoes.

Electronics stability

Modern electronic systems are subject to small variations with time. This may be controlled by using a well-engineered monitoring system, which will keep the variations of the electronics within less than 1 dB, or activate an alarm when a fault is detected.

Processing accuracy

The signal processing must be designed to optimize the sampling capacities of the system. The variances in the estimation of reflectivity, Doppler velocity and spectrum width must be kept to a minimum. Range and velocity aliasing may be significant sources of error.

Radar range equation

There are many assumptions in interpreting radar-received power measurements in terms of the meteorological parameter Z by the radar range equation. Non-conformity with the assumptions can lead to error.

9.6 OPTIMIZING RADAR CHARACTERISTICS

9.6.1 Selecting a radar

A radar is a highly effective observation system. The characteristics of the radar and the climatology determine the effectiveness for any particular application. No single radar can be designed to be the most effective for all applications. Characteristics can be selected to maximize the proficiency to best suit one or more applications, such as tornado detection. Most often, for general applications, compromises are made to meet several user requirements. Many of the characteristics are interdependent with respect to performance and, hence, the need for optimization in reaching a suitable specification. Cost is a significant consideration. Much of the interdependence can be visualized by reference to the radar range equation. A brief note on some of the important factors follows.

9.6.2 Wavelength

The larger the wavelength, the greater the cost of the radar system, particularly antenna costs for comparable beamwidths (i.e. resolution). This is

due both to an increase in the amount of material and to the difficulty in meeting tolerances over a greater size. Within the bands of weather radar interest (S, C, X and K), the sensitivity of the radar or its ability to detect a target is strongly dependent on the wavelength. It is also significantly related to antenna size, gain and beamwidth. For the same antenna, the target detectability increases with decreasing wavelength. There is an increase in sensitivity of 8.87 dB in theory and 8.6 dB in practice from 5 to 3 cm wavelengths. Thus, the shorter wavelengths provide better sensitivity. At the same time, the beamwidth is narrower for better resolution and gain. The great disadvantage is that smaller wavelengths have much larger attenuation.

9.6.3 Attenuation

Radar rays are attenuated most significantly in rain, less in snow and ice, and even less in clouds and atmospheric gases. In broad terms, attenuation at the S band is relatively small and generally not too significant. The S band radar, despite its cost, is essential for penetrating the very high reflectivities in mid-latitude and subtropical severe storms with wet hail. X-band radars can be subject to severe attenuation over short distances, and they are not suitable for precipitation rate estimates, or even for surveillance, except at very short range when shadowing or obliteration of more distant storms by nearer storms is not important. The attenuation in the C band lies between the two.

9.6.4 Transmitter power

Target detectability is directly related to the peak power output of the radar pulse. However, there are practical limits to the amount of power output that is dictated by power tube technology. Unlimited increases in power are not the most effective means of increasing the target detectability. For example, doubling the power only increases the system sensitivity by 3 dB. Technically, the maximum possible power output increases with wavelength. Improvements in receiver sensitivity, antenna gain, or choice of wavelength may be better means of increasing detection capability.

Magnetrons and klystrons are common power tubes. Magnetrons cost less but are less frequency stable. For Doppler operation, the stability of klystrons was thought to be mandatory. An analysis by Strauch (1981) concluded that magnetrons could be quite effective for general meteorological applications; many Doppler radars today are based on magnetrons. Ground echo rejection techniques and clear air detection applications may favour

klystrons. On the other hand, magnetron systems simplify rejecting second trip echoes.

At normal operating wavelengths, conventional radars should detect rainfall intensities of the order of 0.1 mm h^{-1} at 200 km and have peak power outputs of the order of 250 kW or greater in the C band.

9.6.5 Pulse length

The pulse length determines the target resolving power of the radar in range. The range resolution or the ability of the radar to distinguish between two discrete targets is proportional to the half pulse length in space. For most klystrons and magnetrons, the maximum ratio of pulse width to PRF is about 0.001. Common pulse lengths are in the range of 0.3 to $4 \mu\text{s}$. A pulse length of $2 \mu\text{s}$ has a resolving power of 300 m, and a pulse of $0.5 \mu\text{s}$ can resolve 75 m.

Assuming that the pulse volume is filled with target, doubling the pulse length increases the radar sensitivity by 6 dB with receiver-matched filtering, while decreasing the resolution; decreasing the pulse length decreases the sensitivity while increasing the resolution. Shorter pulse lengths allow more independent samples of the target to be acquired in range and the potential for increased accuracy of estimate.

9.6.6 Pulse repetition frequency

The PRF should be as high as practical to obtain the maximum number of target measurements per unit time. A primary limitation of the PRF is the unwanted detection of second trip echoes. Most conventional radars have unambiguous ranges beyond the useful range of weather observation by the radar. An important limit on weather target useful range is the substantial height of the beam above the Earth even at ranges of 250 km.

For Doppler radar systems, high PRFs are used to increase the Doppler unambiguous velocity measurement limit. The disadvantages of higher PRFs are noted above.

The PRF factor is not a significant cost consideration but has a strong bearing on system performance. Briefly, high PRFs are desirable to increase the number of samples measured, to increase the maximum unambiguous velocity that can be measured, and to allow higher permissible scan rates. Low PRFs are desirable to increase the maximum unambiguous range that can be measured, and to provide a lower duty cycle.

9.6.7 Antenna system, beamwidth, and speed and gain

Weather radars normally use a horn fed antenna with a parabolic reflector to produce a focused narrow conical beam. Two important considerations are the beamwidth (angular resolution) and the power gain. For common weather radars, the size of the antenna increases with wavelength and with the narrowness of the beam required.

Weather radars normally have beamwidths in the range of 0.5 to 2.0° . For a 0.5 and 1.0° beam at a C band wavelength, the antenna reflector diameter is 7.1 and 3.6 m, respectively; at S band it is 14.3 and 7.2 m. The cost of the antenna system and pedestal increases much more than linearly with reflector size. There is also an engineering and cost limit. The tower must also be appropriately chosen to support the weight of the antenna.

The desirability of having a narrow beam to maximize the resolution and enhance the possibility of having the beam filled with target is particularly critical for the longer ranges. For a 0.5° beam, the azimuthal (and vertical) cross-beam width at 50, 100 and 200 km range is 0.4, 0.9 and 1.7 km, respectively. For a 1.0° beam, the widths are 0.9, 1.7 and 3.5 km. Even with these relatively narrow beams, the beamwidth at the longer ranges is substantially large.

The gain of the antenna is also inversely proportional to the beamwidth and thus, the narrower beams also enhance system sensitivity by a factor equal to differential gain. The estimates of reflectivity and precipitation require a nominal minimal number of target hits to provide an acceptable measurement accuracy. The beam must thus have a reasonable dwell time on the target in a rotating scanning mode of operation. Thus, there are limits to the antenna rotation speed. Scanning cycles cannot be decreased without consequences. For meaningful measurements of distributed targets, the particles must have sufficient time to change their position before an independent estimate can be made. Systems generally scan at the speed range of about 3 to 6 rpm.

Most weather radars are linearly polarized with the direction of the electric field vector transmitted being either horizontal or vertical. The choice is not clear cut, but the most common polarization is horizontal. Reasons for favouring horizontal polarization include: (a) sea and ground echoes are generally less with horizontal; (b) lesser sidelobes

in the horizontal provide more accurate measurements in the vertical; and (c) greater backscatter from rain due to the falling drop ellipticity. However, at low elevation angles, better reflection of horizontally polarized waves from plane ground surfaces may produce an unwanted range-dependent effect.

In summary, a narrow beamwidth affects system sensitivity, detectability, horizontal and vertical resolution, effective range and measurement accuracy. The drawback of small beamwidth is mainly cost. For these reasons, the smallest affordable beamwidth has proven to improve greatly the utility of the radar (Crozier and others, 1991).

9.6.8 Typical weather radar characteristics

The characteristics of typical radars used in general weather applications are given in Table 9.7.

Table 9.7. Specifications of typical meteorological radars

Type	Z only	Doppler	Z only	Doppler	Micro-Doppler
Band	C	C	S	S	C
Frequency (GHz)	5.6	5.6	3.0	2.8	5.6
Wavelength (cm)	5.33	5.33	10.0	10.7	5.4
Peak power (kw)	250	250	500	1 000	250
Pulse length (µs)	2.0	0.5, 2.0	0.25, 4.0	1.57, 4.5	1.1
PRF (Hz)	250–300	250–1 200	200–800	300–1 400	235–2 000
Receiver	Log	Log/Lin	Log	Log/Lin	Log/Lin
MDS (dBm)	-105	-105	-110	-113	-106
Antenna diameter (m)	3.7	6.2	3.7	8.6	7.6
Beamwidth (°)	1.1	0.6	1.8	1.0	0.5
Gain (dB)	44	48	38.5	45	51
Polarization	H	H	H	H	H
Rotation rate (rpm)	6	1-6	3	6	5

As discussed, the radar characteristics and parameters are interdependent. The technical limits on the radar components and the availability of manufactured components are important considerations in the design of radar systems.

The Z only radars are the conventional non-coherent pulsed radars that have been in use for decades and are still very useful. The Doppler radars are the new generation of radars that add a new dimension to the observations. They provide estimates of radial velocity. The micro-Doppler radars are radars developed for better detection of small-scale microbursts and tornadoes over very limited areas, such as for air-terminal protection.

9.7 RADAR INSTALLATION

9.7.1 Optimum site selection

Optimum site selection for installing a weather radar is dependent on the intended use. When there is a definite zone that requires storm warnings, the best compromise is usually to locate the equipment at a distance of between 20 and 50 km from the area of interest, and generally upwind of it according to the main storm track. It is recommended that the radar be installed slightly away from the main storm track in order to avoid measurement problems when the storms pass over the radar. At the same time, this should lead to good resolution over the area of interest and permit better advance warning of the coming storms (Leone and others, 1989).

In the case of a radar network intended primarily for synoptic applications, radars at mid-latitudes should be located at a distance of approximately 150 to 200 km from each another. The distance may be increased at latitudes closer to the Equator, if the radar echoes of interest frequently reach high altitudes. In all cases, narrow-beam radars will yield the best accuracy for precipitation measurements.

The choice of radar site is influenced by many economic and technical factors as follows:

- (a) The existence of roads for reaching the radar;
- (b) The availability of power and telecommunication links. It is frequently necessary to add commercially available lightning protection devices;

- (c) The cost of land;
- (d) The proximity to a monitoring and maintenance facility;
- (e) Beam blockage obstacles must be avoided. No obstacle should be present at an angle greater than a half beamwidth above the horizon, or with a horizontal width greater than a half beamwidth;
- (f) Ground clutter must be avoided as much as possible. For a radar to be used for applications at relatively short range, it is sometimes possible to find, after a careful site inspection and examination of detailed topographic maps, a relatively flat area in a shallow depression, the edges of which would serve as a natural clutter fence for the antenna pattern sidelobes with minimum blockage of the main beam. In all cases, the site survey should include a camera and optical theodolite check for potential obstacles. In certain cases, it is useful to employ a mobile radar system for confirming the suitability of the site. On some modern radars, software and hardware are available to greatly suppress ground clutter with minimum rejection of weather echoes (Heiss, McGrew and Sirmans, 1990);
- (g) When the radar is required for long-range surveillance, as may be the case for tropical cyclones or other applications on the coast, it will usually be placed on a hill-top. It will see a great deal of clutter, which may not be so important at long ranges (see section 9.2.6 for clutter suppression);
- (h) Every survey on potential sites should include a careful check for electromagnetic interference, in order to avoid as much as possible interference with other communication systems such as television, microwave links or other radars. There should also be confirmation that microwave radiation does not constitute a health hazard to populations living near the proposed radar site (Skolnik, 1970; Leone and others, 1989).

9.7.2 Telecommunications and remote displays

Recent developments in telecommunications and computer technology allow the transmission of radar data to a large number of remote displays. In particular, computer systems exist that are capable of assimilating data from many radars as well as from other data sources, such as satellites. It is also possible to monitor and to control remotely the operation of a radar which allows unattended operation. Owing to these technical

advances, in many countries, "nowcasting" is carried out at sites removed from the radar location.

Pictures may be transmitted by almost any modern transmission means, such as telephone lines (dedicated or not), fibre optic links, radio or microwave links, and satellite communication channels. The most widely used transmission systems are dedicated telephone lines, because they are easily available and relatively low in cost in many countries. It should be kept in mind that radars are often located at remote sites where advanced telecommunication systems are not available.

Radar pictures may now be transmitted in a few seconds due to rapid developments in communication technology. For example, a product with a 100 km range with a resolution of 0.5 km may have a file size of 160 kBytes. Using a compression algorithm, the file size may be reduced to about 20 to 30 kBytes in GIF format. This product file can be transmitted on an analogue telephone line in less than 30 s, while using an ISDN 64 kbps circuit it may take no more than 4 s. However, the transmission of more reflectivity levels or of additional data, such as volume scans of reflectivity or Doppler data, will increase the transmission time.

9.8 CALIBRATION AND MAINTENANCE

The calibration and maintenance of any radar should follow the manufacturer's prescribed procedures. The following is an outline.

9.8.1 Calibration

Ideally, the complete calibration of reflectivity uses an external target of known radar reflectivity factor, such as a metal-coated sphere. The concept is to check if the antenna and wave guides have their nominal characteristics. However, this method is very rarely used because of the practical difficulties in flying a sphere and multiple ground reflections. Antenna parameters can also be verified by sun flux measurements. Routine calibration ignores the antenna but includes the wave guide and transmitter receiver system. Typically, the following actions are prescribed:

- (a) Measurement of emitted power and waveform in the proper frequency band;
- (b) Verification of transmitted frequency and frequency spectrum;

- (c) Injection of a known microwave signal before the receiver stage, in order to check if the levels of reflectivity indicated by the radar are correctly related to the power of the input;
- (d) Measurement of the signal to noise ratio, which should be within the nominal range according to radar specifications.

If any of these calibration checks indicate any changes or biases, corrective adjustments need to be made. Doppler calibration includes: the verification and adjustment of phase stability using fixed targets or artificial signals; the scaling of the real and imaginary parts of the complex video; and the testing of the signal processor with known artificially generated signals.

Levelling and elevation are best checked by tracking the position of the sun in receive-only mode and by using available sun location information; otherwise mechanical levels on the antenna are needed. The presence or absence of echoes from fixed ground targets may also serve as a crude check of transmitter or receiver performance.

Although modern radars are usually equipped with very stable electronic components, calibrations must be performed often enough to guarantee the reliability and accuracy of the data. Calibration must be carried out either by qualified personnel, or by automatic techniques such as online diagnostic and test equipment. In the first case, which requires manpower, calibration should optimally be conducted at least every week; in the second, it may be performed daily or even semi-continuously. Simple comparative checks on echo strength and location can be made frequently, using two or more overlapping radars viewing an appropriate target.

9.8.2 Maintenance

Modern radars, if properly installed and operated, should not be subject to frequent failures. Some manufacturers claim that their radars have a mean time between failures (MTBF) of the order of a year. However, these claims are often optimistic and the realization of the MTBF requires scheduled preventive maintenance. A routine maintenance plan and sufficient technical staff are necessary in order to minimize repair time.

Preventive maintenance should include at least a monthly check of all radar parts subject to wear, such as gears, motors, fans and infrastructures. The results of the checks should be written in a radar logbook by local maintenance staff and, when appropriate, sent to the central maintenance facility. When there are

many radars, there might be a centralized logistic supply and a repair workshop. The latter receives failed parts from the radars, repairs them and passes them on to logistics for storage as stock parts, to be used as needed in the field.

For corrective maintenance, the Service should be sufficiently equipped with the following:

- (a) Spare parts for all of the most sensitive components, such as tubes, solid state components, boards, chassis, motors, gears, power supplies, and so forth. Experience shows that it is desirable to have 30 per cent of the initial radar investment in critical spare parts on the site. If there are many radars, this percentage may be lowered to about 20 per cent, with a suitable distribution between central and local maintenance;
- (b) Test equipment, including the calibration equipment mentioned above. Typically, this would amount to approximately 15 per cent of the radar value;
- (c) Well-trained personnel capable of identifying problems and making repairs rapidly and efficiently.

Competent maintenance organization should result in radar availability 96 per cent of the time on a yearly basis, with standard equipment. Better performances are possible at a higher cost.

Recommended minimum equipment for calibration and maintenance includes the following:

- (a) Microwave signal generator;
- (b) Microwave power meter;
- (c) MHz oscilloscope;
- (d) Microwave frequency meter;
- (e) Standard gain horns;
- (f) Intermediate frequency signal generator;
- (g) Microwave components, including loads, couplers, attenuators, connectors, cables, adapters, and so on;
- (h) Versatile microwave spectrum analyser at the central facility;
- (i) Standard electrical and mechanical tools and equipment.

9.9 PRECIPITATION MEASUREMENTS

The measurement of precipitation by radars has been a subject of interest since the early days of radar meteorology. The most important advantage of using radars for precipitation measurements is the coverage of a large area with high spatial and temporal resolution from a single observing point and in real time.

Furthermore, the two-dimensional picture of the weather situation can be extended over a very large area by compositing data from several radars. However, only recently has it become possible to take measurements over a large area with an accuracy that is acceptable for hydrological applications.

Unfortunately, a precise assessment of this accuracy is not possible – partly because no satisfactory basis of comparison is available. A common approach is to use a network of gauges as a reference against which to compare the radar estimates. This approach has an intuitive appeal, but suffers from a fundamental limitation: there is no reference standard against which to establish the accuracy of areal rainfall measured by the gauge network on the scale of the radar beam. Nature does not provide homogeneous, standard rainfall events for testing the network, and there is no higher standard against which to compare the network data. Therefore, the true rainfall for the area or the accuracy of the gauge network is not known. Indeed, there are indications that the gauge accuracy may, for some purposes, be far inferior to what is commonly assumed, especially if the estimates come from a relatively small number of raingauges (Neff, 1977).

9.9.1 **Precipitation characteristics affecting radar measurements: The Z-R relation**

Precipitation is usually measured by using the Z-R relation:

$$Z = A R^b \quad (9.10)$$

where A and b are constants. The relationship is not unique and very many empirical relations have been developed for various climates or localities and storm types. Nominal and typical values for the index and exponent are $A = 200$, $b = 1.60$ (Marshall and Palmer, 1948; Marshall and Gunn, 1952).

The equation is developed under a number of assumptions that may not always be completely valid. Nevertheless, history and experience have shown that the relationship in most instances provides a good estimate of precipitation at the ground unless there are obvious anomalies. There are some generalities that can be stated. At 5 and 10 cm wavelengths, the Rayleigh approximation is valid for most practical purposes unless hailstones are present. Large concentrations of ice mixed with liquid can cause anomalies, particularly near the melting level. By taking into account the refractive index factor for ice (i.e., $|K|^2 = 0.208$) and by choosing an appropriate relation between the reflectivity

factor and precipitation rate (Z_e against R), precipitation amounts can be estimated reasonably well in snow conditions (the value of 0.208, instead of 0.197 for ice, accounts for the change in particle diameter for water and ice particles of equal mass).

The rainfall rate (R) is a product of the mass content and the fall velocity in a radar volume. It is roughly proportional to the fourth power of the particle diameters. Therefore, there is no unique relationship between radar reflectivity and the precipitation rate since the relationship depends on the particle size distribution. Thus, the natural variability in drop-size distributions is an important source of uncertainty in radar precipitation measurements.

Empirical Z-R relations and the variations from storm to storm and within individual storms have been the subject of many studies over the past forty years. A Z-R relation can be obtained by calculating values of Z and R from measured drop-size distributions. An alternative is to compare Z measured aloft by the radar (in which case it is called the “equivalent radar reflectivity factor” and labelled Z_e) with R measured at the ground. The latter approach attempts to reflect any differences between the precipitation aloft and that which reaches the ground. It may also include errors in the radar calibration, so that the result is not strictly a Z-R relationship.

The possibility of accounting for part of the variability of the Z-R relation by stratifying storms according to rain type (such as convective, non-cellular, orographic) has received a good deal of attention. No great improvements have been achieved and questions remain as to the practicality of applying this technique on an operational basis. Although variations in the drop-size distribution are certainly important, their relative importance is frequently overemphasized. After some averaging over time and/or space, the errors associated with these variations will rarely exceed a factor of two in rain rate. They are the main sources of the variations in well-defined experiments at near ranges. However, at longer ranges, errors caused by the inability to observe the precipitation close to the ground and beam-filling are usually dominant. These errors, despite their importance, have been largely ignored.

Because of growth or evaporation of precipitation, air motion and change of phase (ice and water in the melting layer, or bright band), highly variable vertical reflectivity profiles are observed, both within a given storm and from storm to storm. Unless the beam width is quite narrow, this will

lead to a non-uniform distribution of reflectivity within the radar sample volume. In convective rainfall, experience shows that there is less difficulty with the vertical profile problem.

However, in stratiform rain or snow, the vertical profile becomes more important. With increasing range, the beam becomes wider and higher above the ground. Therefore, the differences between estimates of rainfall by radar and the rain measured at the ground also increase. Reflectivity usually decreases with height; therefore, rain is underestimated by radar for stratiform or snow conditions.

At long ranges, for low-level storms, and especially when low antenna elevations are blocked by obstacles such as mountains, the underestimate may be severe. This type of error often tends to dominate all others. This is easily overlooked when observing storms at close ranges only, or when analysing storms that are all located at roughly the same range.

These and other questions, such as the choice of the wavelength, errors caused by attenuation, considerations when choosing a radar site for hydrological applications, hardware calibration of radar systems, sampling and averaging, and meteorological adjustment of radar data are discussed in Joss and Waldvogel (1990), Smith (1990) and Sauvageot (1994). The following considers only rainfall measurements; little operational experience is available about radar measurements of snow and even less about measurements of hail.

9.9.2 Measurement procedures

The basic procedure for deducing rainfall rates from measured radar reflectivities for hydrological applications requires the following steps:

- (a) Making sure that the hardware is stable by calibration and maintenance;
- (b) Correcting for errors using the vertical reflectivity profile;
- (c) Taking into account all the information about the Z_e - R relationship and deducing the rainfall;
- (d) Adjustment with raingauges.

The first three parts are based on known physical factors, and the last one uses a statistical approach to compensate for residual errors. This allows the statistical methods to work most efficiently. In the past, a major limitation on carrying out these steps was caused by analogue circuitry and photographic techniques for data recording and analyses. It was, therefore, extremely difficult to determine and make the necessary adjustments, and certainly not

in real time. Today, the data may be obtained in three dimensions in a manageable form, and the computing power is available for accomplishing these tasks. Much of the current research is directed towards developing techniques for doing so on an operational basis (Ahnert and others, 1983).

The methods of approach for (b) to (d) above and the adequacy of results obtained from radar precipitation measurement greatly depend on the situation. This can include the specific objective, the geographic region to be covered, the details of the application, and other factors. In certain situations, an interactive process is desirable, such as that developed for FRONTIERS and described in Appendix A of Joss and Waldvogel (1990). It makes use of all pertinent information available in modern weather data centres.

To date, no one method of compensating for the effects of the vertical reflectivity profile in real time is widely accepted ((b) above). However, three compensation methods can be identified:

- (a) Range-dependent correction: The effect of the vertical profile is associated with the combination of increasing height of the beam axis and spreading of the beam with range. Consequently, a climatological mean range-dependent factor can be applied to obtain a first-order correction. Different factors may be appropriate for different storm categories, for example, convective versus stratiform;
- (b) Spatially-varying adjustment: In situations where the precipitation characteristics vary systematically over the surveillance area, or where the radar coverage is non-uniform because of topography or local obstructions, corrections varying with both azimuth and range may be useful. If sufficient background information is available, mean adjustment factors can be incorporated in suitable look-up tables. Otherwise, the corrections have to be deduced from the reflectivity data themselves or from comparisons with gauge data (a difficult proposition in either case);
- (c) Full vertical profiles: The vertical profiles in storms vary with location and time, and the lowest level visible to the radar usually varies because of irregularities in the radar horizon. Consequently, a point-by-point correction process using a representative vertical profile for each zone of concern may be needed to obtain the best results. Representative profiles can be obtained from the radar volume scan data themselves, from climatological summaries, or from storm models. This is the most complex approach but can be implemented

with modern data systems (Joss and Lee, 1993).

After making the profile corrections, a reflectivity/rain-rate relationship should be used which is appropriate to the situation, geography and season, in order to deduce the value of R ((c) in the first paragraph of this section). There is general agreement that comparisons with gauges should be made routinely, as a check on radar performance, and that appropriate adjustments should be made if a radar bias is clearly indicated ((d) in the first paragraph of this section). In situations where radar estimates are far from the mark due to radar calibration or other problems, such adjustments can bring about significant improvements.

However, the adjustments do not automatically ensure improvements in radar estimates, and sometimes the adjusted estimates are poorer than the original ones. This is especially true for convective rainfall where the vertical extent of echo mitigates the difficulties associated with the vertical profile, and the gauge data are suspect because of unrepresentative sampling. Also, the spatial decorrelation distance may be small, and the gauge-radar comparison becomes increasingly inaccurate with distance from the gauge. A general guideline is that the adjustments will produce consistent improvements only when the systematic differences (that is, the bias) between the gauge and radar rainfall estimates are larger than the standard deviation of the random scatter of the gauge versus radar comparisons. This guideline makes it possible to judge whether gauge data should be used to make adjustments and leads to the idea that the available data should be tested before any adjustment is actually applied. Various methods for accomplishing this have been explored, but at this time there is no widely accepted approach.

Various techniques for using polarization diversity radar to improve rainfall measurements have been proposed. In particular, it has been suggested that the difference between reflectivities measured at horizontal and vertical polarization (Z_{DR}) can provide useful information about drop-size distributions (Seliga and Bringi, 1976). An alternate method is to use K_{DP} that depends on large oblate spheroids distorting the shape of the transmitted wave. The method depends on the hydrodynamic distortions of the shapes of large raindrops, with more intense rainfalls with larger drops giving stronger polarization signatures. There is still considerable controversy, however, as to whether

this technique has promise for operational use for precipitation measurement (English and others, 1991).

At close ranges (with high spatial resolution), polarization diversity radars may give valuable information about precipitation particle distributions and other parameters pertinent to cloud physics. At longer ranges, it is impossible to be sure that the radar beam is filled with a homogeneous distribution of hydrometeors. Consequently, the empirical relationship of the polarimetric signature to the drop-size distribution increases uncertainty. Of course, knowing more about $Z-R$ will help, but, even if multiparameter techniques worked perfectly well, the error caused by $Z-R$ could be reduced only from 33 to 17 per cent, as shown by Ulbrich and Atlas (1984). For short-range hydrological applications, the corrections for other biases (already discussed) are usually much greater, perhaps by an order of magnitude or more.

9.9.3 State of the art and summary

Over the years, much research has been directed towards exploring the potential of radars as an instrument for measuring rain. In general, radar measurements of rain, deduced from an empirical $Z-R$ relation, agree well with gauge measurements for ranges close to the radar. Increased variability and underestimation by the radar occur at longer ranges. For example, the Swiss radar estimates, at a range of 100 km on average, only 25 per cent of the actual raingauge amount, despite the fact that it measures 100 per cent at close ranges.

Similar, but not quite so dramatic, variations are found in flat country or in convective rain. The reasons are the Earth curvature, shielding by topography and the spread of the radar beam with range. Thus, the main shortcoming in using radars for precipitation measurements and for hydrology in operational applications comes from the inability to measure precipitation close enough to the ground over the desired range of coverage. Because this problem often does not arise in well-defined experiments, it has not received the attention that it deserves as a dominant problem in operational applications.

Thanks to the availability of inexpensive, high-speed data-processing equipment, it is now possible to determine the echo distribution in the whole radar coverage area in three dimensions. This knowledge, together with knowledge about the position of the radar and the orography around it, makes it possible

to correct in real time for a large fraction of – or at least to estimate the magnitude of – the vertical profile problem. This correction allows extension of the region in which accuracy acceptable for many hydrological applications is obtained.

To make the best possible use of radars, the following rules should be respected:

- (a) The radar site should be chosen such that precipitation is seen by the radar as close as possible to the ground. “Seen” means here that there is no shielding or clutter echoes, or that the influence of clutter can be eliminated, for instance by Doppler analysis. This condition may frequently restrict the useful radar range for quantitative work to the nearest 50 to 100 km;
- (b) Wavelength and antenna size should be chosen such that a suitable compromise between attenuation caused by precipitation and good spatial resolution is achieved. At longer ranges, this may require a shorter wavelength to achieve a sufficiently narrow beam, or a larger antenna if S band use is necessary, due to frequent attenuation by huge intense cells;
- (c) Systems should be rigorously maintained and quality controlled, including by ensuring the sufficient stability and calibration of equipment;
- (d) Unless measurements of reflectivity are taken immediately over the ground, they should be corrected for errors originating from the vertical profile of reflectivity. As these profiles change with time, reflectivity should be monitored continuously by the radar. The correction may need to be calculated for each pixel, as it depends on the height of the lowest visible volume above the ground. It is important that the correction for the vertical reflectivity profile, as it is the dominant one at longer ranges, should be carried out before any other adjustments;
- (e) The sample size must be adequate for the application. For hydrological applications, and especially when adjusting radar estimates with gauges, it is desirable to integrate the data over a number of hours and/or square kilometres. Integration has to be performed over the desired quantity (the linear rainfall rate R) to avoid any bias caused by this integration.

Even a crude estimate of the actual vertical reflectivity profile can produce an important improvement. Polarimetric measurements may provide some further improvement, but it has yet to be demonstrated that the additional cost and

complexity and risk of misinterpreting polarization measurements can be justified for operational applications in hydrology.

The main advantages of radars are their high spatial and temporal resolution, wide area coverage and immediacy (real-time data). Radars also have the capability of measuring over inaccessible areas, such as lakes, and of following a “floating target” or a “convective complex” in a real-time sequence, for instance, to make a short-term forecast. Although it is only to a lesser degree suited to giving absolute accuracy in measuring rain amounts, good quantitative information is already obtained from radar networks in many places. It is unlikely that radars will ever completely replace the rain gauge, since gauges provide additional information and are essential for adjusting and/or checking radar indications. On the other hand, as many specialists have pointed out, an extremely dense and costly network of gauges would be needed to obtain a resolution that would be easily attainable with radars.

9.9.4 **Area-time integral technique**

Climatological applications not requiring real-time data can take advantage of the close relationship between the total amount of rainfall and the area and duration of a rain shower (Byers, 1948; Leber, Merrit and Robertson, 1961). Without using a Z - R relationship, Doneaud and others (1984; 1987) found a linear relationship between the rained-upon area and the total rainfall within that area with a very small dispersion. This relationship is dependent on the threshold selected to define the rain area. While this has limited use in real-time short-term forecasting applications, its real value should be in climatological studies and applications.

9.10 **SEVERE WEATHER DETECTION AND NOWCASTING APPLICATIONS**

9.10.1 **Utilization of reflectivity information**

The most commonly used criterion for radar detection of potentially severe thunderstorms today is reflectivity intensity. Operational forecasters are advised to look for regions of high reflectivities (50 dBZ or greater). These include the spiral-bands and eyewall structures that identify tropical cyclones. Hook or finger-like echoes, overhangs and other echo shapes obtained from radar volume scans are used to warn of tornadoes or severe thunderstorms

(Lemon, Burgess and Brown, 1978), but the false alarm rate is high.

Improved severe thunderstorm detection has been obtained recently through the processing of digital reflectivity data obtained by automatic volume-scanning at 5 to 10 minute update rates. Reflectivity mass measurements such as vertically integrated liquid and severe weather probability have led to improved severe thunderstorm detection and warning, especially for hail.

Many techniques have been proposed for identifying hail with 10 cm conventional radar, such as the presence of 50 dBZ echo at 3 or 8 km heights (Dennis, Schock and Koscielski, 1970; Lemon, Burgess and Brown, 1978). However, verification studies have not yet been reported for other parts of the world. Federer and others (1978) found that the height of the 45 dBZ contour must exceed the height of the zero degree level by more than 1.4 km for hail to be likely. An extension of this method has been verified at the Royal Netherlands Meteorological Institute and is being used operationally (Holleman, and others, 2000; Holleman, 2001). A different approach towards improved hail detection involves the application of dual-wavelength radars – usually X and S bands (Eccles and Atlas, 1973). The physics of what the radar sees at these various wavelengths is crucial for understanding the strengths and limitations of these techniques (hydrometeor cross-section changes or intensity distribution). Studies of polarization diversity show some promise of improved hail detection and heavy rainfall estimation based upon differential reflectivity (Z_{DR}) as measured by a dual-polarization Doppler radar (Seliga and Bringi, 1976).

Since the late 1970s, computer systems have been used to provide time lapse and zoom capabilities for radar data. The British FRONTIERS system (Browning and Collier, 1982; Collier, 1989), the Japanese AMeDAS system, the French ARAMIS system (Commission of the European Communities, 1989) and the United States PROFS system allow the user to interact and produce composite colour displays from several remote radars at once, as well as to blend the radar data with other types of information.

The synthesis of radar data with raingauge data provides a powerful nowcasting product for monitoring rainfall. “Radar-AMeDAS Precipitation Analysis” is one of the products provided in Japan (Makihara, 2000). Echo intensity obtained from a radar network is converted into precipitation rate using a Z_e - R relationship, and 1 h precipitation amount is estimated from the precipitation rate.

The estimated amounts are then calibrated using raingauge precipitation amounts to provide a map of 1 h precipitation amount with high accuracy.

9.10.2 Utilization of Doppler information

The best method for measuring winds inside precipitation is the multiple Doppler method, which has been deployed since the mid-1970s for scientific field programmes of limited duration. However, real-time operational use of dual- or triple-Doppler analyses is not anticipated at present because of spatial coverage requirements. An exception may be the limited area requirements of airports, where a bistatic system may be useful (Wurman, Randall and Burghart, 1995).

The application of Doppler radar to real-time detection and tracking of severe thunderstorms began in the early 1970s. Donaldson (1970) was probably the first to identify a vortex flow feature in a severe thunderstorm. Quasi-operational experiments have demonstrated that a very high percentage of these single-Doppler vortex signatures are accompanied by damaging hail, strong straight wind or tornadoes (Ray and others, 1980; JDOP, 1979).

Since then, the existence of two useful severe storm features with characteristic patterns or “signatures” has become apparent. The first was that of a mesocyclone, which is a vertical column of rising rotating air typically 2 to 10 km in diameter. The mesocyclone signature (or velocity couplet) is observed forming in the mid-levels of a storm and descending to cloud base, coincident with tornado development (Burgess, 1976; Burgess and Lemon, 1990). This behaviour has led to improved tornado warning lead times, of 20 min or longer, during quasi-operational experiments in Oklahoma (JDOP, 1979). Most of the Doppler observations have been made in the United States, and it is not known if this signature can be generalized yet. During experiments in Oklahoma, roughly 50 per cent of all mesocyclones produced verified tornadoes; also, all storms with violent tornadoes formed in environments with strong shear and possessed strong mesocyclones (Burgess and Lemon, 1990).

The second signature – the tornado vortex signature (TVS) – is produced by the tornado itself. It is the location of a very small circulation embedded within the mesocyclone. In some cases, the TVS has been detected aloft nearly half an hour or more before a tornado touched the ground. Several years of experience with TVS have demonstrated its great utility for determining tornado location, usually

within ± 1 km. It is estimated that 50 to 70 per cent of the tornadoes east of the Rocky Mountain high plains in the United States can be detected (Brown and Lemon, 1976). Large Doppler spectrum widths (second moment) have been identified with tornado location. However, large values of spectrum width have also been well correlated with large values during storm turbulence.

Divergence calculated from the radial velocity data appears to be a good measure of the total divergence. Estimations of storm-summit radial divergence match those of the echo-top height, which is an updraft strength indicator. Quasi-operational Doppler experiments have shown that an increase in divergence magnitude is likely to be the earliest indicator that a storm is becoming severe. Moreover, large divergence values near the storm top were found to be a useful hail indicator.

Low-level divergence signatures of downbursts have been routinely made with terminal Doppler weather radars for the protection of aircraft during take off and landing. These radars are specially built for limited area surveillance and repeated rapid scanning of the air space around the airport terminals. The microburst has a life cycle of between 10 to 20 min, which requires specialized radar systems for effective detection. In this application, the radar-computer system automatically provides warnings to the air-traffic control tower (Michelson, Schrader and Wieler, 1990).

Doppler radar studies of the role of boundary layer convergence lines in new thunderstorm formations support earlier satellite cloud-arc studies. There are indications that mesoscale boundary-layer convergence lines (including intersecting gust fronts from prior convection) play a major role in determining where and when storms will form. Wilson and Schreiber (1986) have documented and explained several cases of tornado genesis by non-precipitation induced wind shear lines, as observed by Doppler radar (Mueller and Carbone, 1987).

Recent improvements in digital radar data-processing and display techniques have led to the development of new quantitative, radar-based products for hydrometeorological applications. A number of European countries and Japan are using such radar products with numerical models for operational flood forecasting and control (for example, see Cluckie and Owens, 1987).

Thus, major advances now appear possible in the 0 to 2 h time-specific forecasts of thunderstorms. The development of this potential will require

the efficient integration of Doppler radar, high-resolution satellite data, and surface and sounding data.

Doppler radars are particularly useful for monitoring tropical cyclones and providing data on their eye, eyewall and spiral-band dynamic evolution, as well as the location and intensity of hurricane-force winds (Ruggiero and Donaldson, 1987; Baynton, 1979).

9.11 HIGH FREQUENCY RADARS FOR OCEAN SURFACE MEASUREMENTS

Radio signals in the high-frequency radio band (from 3 to 30 MHz) are backscattered from waves on the sea surface, and their frequency is Doppler shifted. They can be detected by a high-frequency radar set-up to observe them. The strength of the returned signal is due to constructive interference of the rays scattered from successive sea waves spaced so that the scattered rays are in resonance, as occurs in a diffraction grating. In the case of grazing incidence, the resonance occurs when the sea wavelength is half the radio wavelength. The returned signal is Doppler shifted because of the motion of the sea waves. From the Doppler spectrum it is possible to determine the direction of motion of the sea waves, with a left-right ambiguity across the direction of the beam that can be resolved by making use of other information, such as a first-guess field. If the sea waves are in equilibrium with the surface wind, this yields the wind direction; this is the basic sea measurement taken with high-frequency radar. Analysis of the returned spectrum can be developed further to yield the spectrum of sea waves and an indication of wind speed.

Measurements can be obtained up to 200 km or more with ground-wave radars, and up to 3 000 km or more with sky-wave radars (using reflection from the ionosphere). The latter are known as over-the-horizon radars.

Most operational high frequency radars are military, but some are used to provide routine wind direction data, over very wide areas, to Hydrometeorological Services.

Accounts of high frequency radars with meteorological applications, with extensive further references, are given in Shearman (1983), Dexter, Heron and Ward (1982), Keenan and Anderson (1987), and Harlan and Georges (1994).

REFERENCES AND FURTHER READING

- Ahnert, P.R., M. Hudlow, E. Johnson, D. Greene and M. Dias, 1983: Proposed on-site processing system for NEXRAD. *Preprints of the Twenty-first Conference on Radar Meteorology* (Edmonton, Canada), American Meteorological Society, Boston, pp. 378-385.
- Aoyagi, J., 1983: A study on the MTI weather radar system for rejecting ground clutter. *Papers in Meteorology and Geophysics*, Volume 33, Number 4, pp. 187-243.
- Aoyagi, J. and N. Kodaira, 1995: The reflection mechanism of radar rain echoes. *Preprints of the Twenty-seventh Conference on Radar Meteorology* (Vail, Colorado), American Meteorological Society, Boston, pp. 246-248.
- Atlas, D., 1964: Advances in radar meteorology. *Advances in Geophysics* (H.E. Landsberg and J. Van Meighem, eds.), Volume 10, Academic Press, New York, pp. 317-479.
- Atlas, D. (ed.), 1990: *Radar in Meteorology*. American Meteorological Society, Boston.
- Atlas, D., R.C. Scrivastava and R.S. Sekhon, 1973: Doppler radar characteristics of precipitation at vertical incidence. *Reviews of Geophysics and Space Physics*, Volume 11, Number 1, pp. 1-35.
- Battan, L.J., 1981: *Radar Observation of the Atmosphere*. University of Chicago Press, Chicago.
- Baynton, H.W., 1979: The case for Doppler radars along our hurricane affected coasts. *Bulletin of the American Meteorological Society*, Volume 60, pp. 1014-1023.
- Bean, B.R. and E.J. Dutton, 1966: *Radio Meteorology*. Washington DC, U.S. Government Printing Office.
- Bebbington, D.H.O., 1992: Degree of Polarization as a Radar Parameter and its Susceptibility to Coherent Propagation Effects. *Preprints from URSI Commission F Symposium on Wave Propagation and Remote Sensing* (Ravenscar, United Kingdom) pp. 431-436.
- Bringi, V.N. and A. Hendry, 1990: Technology of polarization diversity radars for meteorology. In: *Radar in Meteorology* (D. Atlas, ed.) American Meteorological Society, Boston, pp. 153-190.
- Browning, K.A. and R. Wexler, 1968: The determination of kinetic properties of a wind field using Doppler radar. *Journal of Applied Meteorology*, Volume 7, pp. 105-113.
- Brown, R.A. and L.R. Lemon, 1976: Single Doppler radar vortex recognition: Part II - Tornadic vortex signatures. *Preprints of the Seventeenth Conference on Radar Meteorology* (Seattle, Washington), American Meteorological Society, Boston, pp. 104-109.
- Browning, K.A. and C.G. Collier, 1982: *An integrated radar-satellite nowcasting system in the United Kingdom*. In: *Nowcasting* (K.A. Browning, ed.). Academic Press, London, pp. 47-61.
- Browning, K.A., C.G. Collier, P.R. Larke, P. Menmuir, G.A. Monk and R.G. Owens, 1982: On the forecasting of frontal rain using a weather radar network. *Monthly Weather Review*, Volume 110, pp. 534-552.
- Burgess, D.W., 1976: Single Doppler radar vortex recognition: Part I - Mesocyclone signatures. *Preprints of the Seventeenth Conference on Radar Meteorology*, (Seattle, Washington), American Meteorological Society, Boston, pp. 97-103.
- Burgess, D.W. and L.R. Lemon, 1990: Severe thunderstorm detection by radar. In *Radar in Meteorology* (D. Atlas, ed.). American Meteorological Society, Boston, pp. 619-647.
- Burrows, C.R. and S.S. Attwood, 1949: *Radio Wave Propagation*. Academic Press, New York.
- Byers, H.R., 1948: The use of radar in determining the amount of rain falling over a small area. *Transactions of the American Geophysical Union*, pp. 187-196.
- Cluckie, I.D. and M.E. Owens, 1987: *Real-time Rainfall Run-off Models and Use of Weather Radar Information*. In: *Weather Radar and Flood Forecasting* (V.K. Collinge and C. Kirby, eds). John Wiley and Sons, New York.
- Collier, C.G., 1989: *Applications of Weather Radar Systems: A Guide to Uses of Radar Data in Meteorology and Hydrology*. John Wiley and Sons, Chichester, England.
- Commission of the European Communities, 1990: *Une revue du programme ARAMIS* (J.L. Cheze). Seminar on Cost Project 73: Weather Radar Networking (Brussels, 5-8 September 1989), pp. 80-85.
- Crozier, C.L., P. Joe, J. Scott, H. Herscovitch and T. Nichols, 1991: The King City operational Doppler radar: Development, all-season applications and forecasting. *Atmosphere-Ocean*, Volume 29, pp. 479-516.
- Dennis, A.S., C.A. Schock, and A. Koscielski, 1970: Characteristics of hailstorms of western South Dakota. *Journal of Applied Meteorology*, Volume 9, pp. 127-135.
- Dexter, P.E., M.L. Heron and J.F. Ward, 1982: Remote sensing of the sea-air interface using HF radars. *Australian Meteorological Magazine*, Volume 30, pp. 31-41.

- Donaldson, R.J., Jr., 1970: Vortex signature recognition by a Doppler radar. *Journal of Applied Meteorology*, Volume 9, pp. 661–670.
- Doneaud, A.A., S. Ionescu-Niscov, D.L. Priegnitz and P.L. Smith, 1984: The area-time integral as an indicator for convective rain volumes. *Journal of Climate and Applied Meteorology*, Volume 23, pp. 555–561.
- Doneaud, A.A., J.R. Miller Jr., L.R. Johnson, T.H. Vonder Haar and P. Laybe, 1987: The area-time integral technique to estimate convective rain volumes over areas applied to satellite data: A preliminary investigation. *Journal of Climate and Applied Meteorology*, Volume 26, pp. 156–169.
- Doviak, R.J. and D.S. Zrnich, 1993: *Doppler Radar and Weather Observations*. Second edition, Academic Press, San Diego.
- Eccles, P.J. and D. Atlas, 1973: A dual-wavelength radar hail detector. *Journal of Applied Meteorology*, Volume 12, pp. 847–854.
- Eilts, M.D. and S.D. Smith, 1990: Efficient dealiasing of Doppler velocities using local environment constraints. *Journal of Atmospheric and Oceanic Technology*, Volume 7, pp. 118–128.
- English, M.E., B. Kochtubajda, F.D. Barlow, A.R. Holt and R. McGuinness, 1991: Radar measurement of rainfall by differential propagation phase: A pilot experiment. *Atmosphere-Ocean*, Volume 29, pp. 357–380.
- Federer, B., A. Waldvogel, W. Schmid, F. Hampel, E. Rosini, D. Vento and P. Admirat, 1978: Grossversuch IV: Design of a randomized hail suppression experiment using the Soviet method. *Pure and Applied Geophysics*, 117, pp. 548–571.
- Gossard, E.E. and R.G. Strauch, 1983: *Radar Observations of Clear Air and Clouds*. Elsevier Scientific Publication, Amsterdam.
- Harlan, J.A. and T.M. Georges, 1994: An empirical relation between ocean-surface wind direction and the Bragg line ratio of HF radar sea echo spectra. *Journal of Geophysical Research*, Volume 99, C4, pp. 7971–7978.
- Heiss, W.H., D.L. McGrew, and D. Sirmans, 1990: NEXRAD: Next generation weather radar (WSR-88D). *Microwave Journal*, Volume 33, Number 1, pp. 79–98.
- Holleman, I., 2001: *Hail Detection Using Single-polarization Radar*. Scientific Report, Royal Netherlands Meteorological Institute (KNMI) WR-2001-01, De Bilt.
- Holleman, I., H.R.A. Wessels, J.R.A. Onvlee and S.J.M. Barlag, 2000: Development of a hail-detection product. *Physics and Chemistry of the Earth*, Part B, 25, pp. 1293–1297.
- Holt, A.R., M. Chandra, and S.J. Wood, 1995: Polarisation diversity radar observations of storms at C-Band. *Preprints of the Twenty-seventh Conference on Radar Meteorology* (Vail, Colorado), American Meteorological Society, Boston, pp. 188–189.
- Holt, A.R., P.I. Joe, R. McGuinness and E. Torlaschi, 1993: Some examples of the use of degree of polarization in interpreting weather radar data. *Proceedings of the Twenty-sixth International Conference on Radar Meteorology*, American Meteorological Society, pp. 748–750.
- Joe, P., R.E. Passarelli and A.D. Siggia, 1995: Second trip unfolding by phase diversity processing. *Preprints of the Twenty-seventh Conference on Radar Meteorology* (Vail, Colorado), American Meteorological Society, Boston, pp. 770–772.
- Joint Doppler Operational Project, 1979: *Final Report on the Joint Doppler Operational Project*. NOAA Technical Memorandum, ERL NSSL-86, Norman, Oklahoma, National Severe Storms Laboratory.
- Joss, J. and A. Waldvogel, 1990: Precipitation measurement and hydrology. In: *Radar in Meteorology* (D. Atlas, ed.), American Meteorological Society, Boston, pp. 577–606.
- Joss, J. and R.W. Lee, 1993: Scan strategy, clutter suppression calibration and vertical profile corrections. *Preprints of the Twenty-sixth Conference on Radar Meteorology* (Norman, Oklahoma), American Meteorological Society, Boston, pp. 390–392.
- Keeler, R.J., C.A. Hwang and E. Loew, 1995: Pulse compression weather radar waveforms. *Preprints of the Twenty-seventh Conference on Radar Meteorology* (Vail, Colorado), American Meteorological Society, Boston, pp. 767–769.
- Keenan, T.D. and S.J. Anderson, 1987: Some examples of surface wind field analysis based on Jindalee skywave radar data. *Australian Meteorological Magazine*, 35, pp. 153–161.
- Leber, G.W., C.J. Merrit, and J.P. Robertson, 1961: WSR-57 Analysis of Heavy Rains. *Preprints of the Ninth Weather Radar Conference*, American Meteorological Society, Boston, pp. 102–105.
- Lee, R., G. Della Bruna and J. Joss, 1995: Intensity of ground clutter and of echoes of anomalous propagation and its elimination. *Preprints of the Twenty-seventh Conference on Radar Meteorology* (Vail, Colorado), American Meteorological Society, Boston, pp. 651–652.
- Lemon, L.R., D.W. Burgess and R.A. Brown, 1978: Tornadic storm airflow and morphology derived from single-Doppler radar measurements. *Monthly Weather Review*, Volume 106, pp. 48–61.

- Leone, D.A., R.M. Endlich, J. Petriceks, R.T.H. Collis and J.R. Porter, 1989: Meteorological considerations used in planning the NEXRAD network. *Bulletin of the American Meteorological Society*, Volume, 70, pp. 4–13.
- Lhermitte, R. and D. Atlas, 1961: Precipitation motion by pulse Doppler radar. *Preprints of the Ninth Weather Radar Conference*, American Meteorological Society, Boston, pp. 218–233.
- Makihara, Y., 2000: Algorithms for precipitation nowcasting focused on detailed analysis using radar and raingauge data. *Technical Report of the Meteorological Research Institute*, JMA, 39, pp. 63–111.
- Marshall, J.S. and K.L.S. Gunn, 1952: Measurement of snow parameters by radar. *Journal of Meteorology*, Volume 9, pp. 322–327.
- Marshall, J.S. and W.M. Palmer, 1948: The distribution of raindrops with size. *Journal of Meteorology*, Volume 5, pp. 165–166.
- Melnikov, V., D.S. Zrnica, R.J. Doviak and J.K. Carter, 2002: Status of the dual polarization upgrade on the NOAA's research and development WSR-88D. *Preprints of the Eighteenth International Conference on Interactive Information Processing Systems* (Orlando, Florida), American Meteorological Society, Boston, pp. 124–126.
- Michelson, M., W.W. Schrader and J.G. Wilson, 1990: Terminal Doppler weather radar. *Microwave Journal*, Volume 33, Number 2, pp. 139–148.
- Mie, G., 1908: Beiträge zur Optik träber Medien, speziell kolloidaler Metallösungen. *Annalen der Physik*, 25, pp. 377–445.
- Mueller, C.K. and R.E. Carbone, 1987: Dynamics of a thunderstorm outflow. *Journal of the Atmospheric Sciences*, Volume 44, pp. 1879–1898.
- Mueller, E.A., S.A. Rutledge, V.N. Bringi, D. Brunkow, P.C. Kennedy, K. Pattison, R. Bowie and V. Chandrasekar, 1995: CSU-CHILL radar upgrades. *Preprints of the Twenty-seventh Conference on Radar Meteorology* (Vail, Colorado), American Meteorological Society, Boston, pp. 703–706.
- Neff, E.L., 1977: How much rain does a rain gage gage? *Journal of Hydrology*, Volume 35, pp. 213–220.
- Passarelli, R.E., Jr., P. Romanik, S.G. Geotis and A.D. Siggia, 1981: Ground clutter rejection in the frequency domain. *Preprints of the Twentieth Conference on Radar Meteorology* (Boston, Massachusetts), American Meteorological Society, Boston, pp. 295–300.
- Probert-Jones, J.R., 1962: The radar equation in meteorology. *Quarterly Journal of the Royal Meteorological Society*, Volume 88, pp. 485–495.
- Ray, P.S., C.L. Ziegler, W. Bumgarner and R.J. Serafin, 1980: Single- and multiple-Doppler radar observations of tornadic storms. *Monthly Weather Review*, Volume 108, pp. 1607–1625.
- Rinehart, R.E., 1991: *Radar for Meteorologists*. Grand Forks, North Dakota, University of North Dakota, Department of Atmospheric Sciences.
- Ruggiero, F.H. and R.J. Donaldson, Jr., 1987: Wind field derivatives: A new diagnostic tool for analysis of hurricanes by a single Doppler radar. *Preprints of the Seventeenth Conference on Hurricanes and Tropical Meteorology* (Miami, Florida), American Meteorological Society, Boston, pp. 178–181.
- Sauvageot, H., 1982: *Radarmétéorologie*. Eyrolles, Paris.
- Sauvageot, H., 1994: Rainfall measurement by radar: A review. *Atmospheric Research*, Volume 35, pp. 27–54.
- Seliga, T.A. and V.N. Bringi, 1976: Potential use of radar differential reflectivity measurements at orthogonal polarizations for measuring precipitation. *Journal of Applied Meteorology*, Volume 15, pp. 69–76.
- Shearman, E.D. R., 1983: Radio science and oceanography. *Radio Science*, Volume 18, Number 3, pp. 299–320.
- Skolnik, M.I. (ed.), 1970: *Radar Handbook*. McGraw-Hill, New York.
- Smith, P.L., 1990: Precipitation measurement and hydrology: Panel report. *In: Radar in Meteorology*. (D. Atlas, ed.), American Meteorological Society, Boston, pp. 607–618.
- Smith, P.L., 1995: Dwell time considerations for weather radars. *Preprints of the Twenty-seventh Conference on Radar Meteorology* (Vail, Colorado), American Meteorological Society, Boston, pp. 760–762.
- Strauch, R.G., 1981: Comparison of meteorological Doppler radars with magnetron and klystron transmitters. *Preprints of the Twentieth Conference on Radar Meteorology* (Boston, Massachusetts), American Meteorological Society, Boston, pp. 211–214.
- Ulbrich, C.W. and D. Atlas, 1984: Assessment of the contribution of differential polarization to improve rainfall measurements. *Radio Science*, Volume 19, Number 1, pp. 49–57.
- Wilson, J.W. and W.E. Schreiber, 1986: Initiation of convective storms at radar-observed boundary-layer convergence lines. *Monthly Weather Review*, Volume 114, pp. 2516–2536.
- Wood, V.T. and R.A. Brown, 1986: Single Doppler velocity signature interpretation of nondivergent environmental winds. *Journal of Atmospheric and Oceanic Technology*, Volume 3, pp. 114–128.

- World Meteorological Organization, 1985: *Use of Radar in Meteorology* (G.A. Clift). Technical Note No. 181, WMO-No. 625, Geneva.
- Wurman, J., M. Randall and C. Burghart, 1995: Real-time vector winds from a bistatic Doppler radar network. *Preprints of the Twenty-seventh Conference on Radar Meteorology* (Vail, Colorado), American Meteorological Society, Boston, pp. 725-728.
- Zrnic, D.S. and S. Hamidi, 1981: *Considerations for the Design of Ground Clutter Cancelers for Weather Radar*. Report DOT/FAA/RD-81/72, NTIS, pp. 77.
- Zrnic, D.S. and A.V. Ryzhkov, 1995: Advantages of rain measurements using specific differential phase. *Preprints of the Twenty-seventh Conference on Radar Meteorology* (Vail, Colorado), American Meteorological Society, pp. 35-37.
-

CHAPTER 10

BALLOON TECHNIQUES

10.1 **BALLOONS**

10.1.1 **Main types of balloons**

Two main categories of balloons are used in meteorology, as follows:

- (a) Pilot balloons, which are used for the visual measurement of upper wind, and ceiling balloons for the measurement of cloud-base height. Usually they do not carry an appreciable load and are therefore considerably smaller than radiosonde balloons. They are almost invariably of the spherical extensible type and their chief requirement, apart from the ability to reach satisfactory heights, is that they should keep a good spherical shape while rising;
- (b) Balloons which are used for carrying recording or transmitting instruments for routine upper-air observations are usually of the extensible type and spherical in shape. They are usually known as radiosonde or sounding balloons. They should be of sufficient size and quality to enable the required load (usually 200 g to 1 kg) to be carried up to heights as great as 35 km (WMO, 2002) at a rate of ascent sufficiently rapid to enable reasonable ventilation of the measuring elements. For the measurement of upper winds by radar methods, large pilot balloons (100 g) or radiosonde balloons are used depending on the weight and drag of the airborne equipment.

Other types of balloons used for special purposes are not described in this chapter. Constant-level balloons that rise to, and float at, a pre-determined level are made of inextensible material. Large constant-level balloons are partly filled at release. Super-pressure constant-level balloons are filled to extend fully the balloon at release. Tetroons are small super-pressure constant-level balloons, tetrahedral in shape, used for trajectory studies. The use of tethered balloons for profiling is discussed in Part II, Chapter 5.

10.1.2 **Balloon materials and properties**

The best basic materials for extensible balloons are high-quality natural rubber latex and a synthetic latex based upon polychloroprene. Natural latex holds its shape better than polychloroprene – which

is stronger and can be made with a thicker film for a given performance. It is less affected by temperature, but more affected by the ozone and ultraviolet radiation at high altitudes, and has a shorter storage life. Both materials may be compounded with various additives to improve their storage life, strength and performance at low temperatures both during storage and during flight, and to resist ozone and ultraviolet radiation. As one of the precautions against explosion, an antistatic agent may also be added during the manufacture of balloons intended to be filled with hydrogen.

There are two main processes for the production of extensible balloons. A balloon may be made by dipping a form into latex emulsion, or by forming it on the inner surface of a hollow mould. Moulded balloons can be made with more uniform thickness, which is desirable for achieving high altitudes as the balloon expands, and the neck can be made in one piece with the body, which avoids the formation of a possible weak point.

Polyethylene is the inextensible material used for constant-level balloons.

10.1.3 **Balloon specifications**

The finished balloons should be free from foreign matter, pinholes or other defects and must be homogeneous and of uniform thickness. They should be provided with necks of between 1 and 5 cm in diameter and 10 to 20 cm long, depending on the size of the balloon. In the case of sounding balloons, the necks should be capable of withstanding a force of 200 N without damage. In order to reduce the possibility of the neck being pulled off, it is important that the thickness of the envelope should increase gradually towards the neck; a sudden discontinuity of thickness forms a weak spot.

Balloons are distinguished in size by their nominal weights in grams. The actual weight of individual balloons should not differ from the specified nominal weight by more than 10 per cent, or preferably 5 per cent. They should be capable of expanding to at least four times, and preferably five or six times, their unstretched diameter and of maintaining this expansion for at least 1 h. When inflated, balloons should be spherical or pear-shaped.

The question of specified shelf life of balloons is important, especially in tropical conditions. Artificial ageing tests exist but they are not reliable guides. One such test is to keep sample balloons in an oven at a temperature of 80°C for four days, this being reckoned as roughly equivalent to four years in the tropics, after which the samples should still be capable of meeting the minimum expansion requirement. Careful packing of the balloons so that they are not exposed to light (especially sunlight), fresh air or extremes of temperature is essential if rapid deterioration is to be prevented.

Balloons manufactured from synthetic latex incorporate a plasticizer to resist the stiffening or freezing of the film at the low temperatures encountered near and above the tropopause. Some manufacturers offer alternative balloons for daytime and night-time use, the amount of plasticizer being different.

10.2 BALLOON BEHAVIOUR

10.2.1 Rate of ascent

From the principle of buoyancy, the total lift of a balloon is given by the buoyancy of the volume of gas in it, as follows:

$$T = V (\rho - \rho_g) = 0.523 D^3 (\rho - \rho_g) \quad (10.1)$$

where T is the total lift; V is the volume of the balloon; ρ is the density of the air; ρ_g is the density of the gas; and D is the diameter of the balloon, which is assumed to be spherical.

All units are in the International System of Units. For hydrogen at ground level, the buoyancy $(\rho - \rho_g)$ is about 1.2 kg m⁻³. All the quantities in equation 10.1 change with height.

The free lift L of a balloon is the amount by which the total lift exceeds the combined weight W of the balloon and its load (if any):

$$L = T - W \quad (10.2)$$

namely, it is the net buoyancy or the additional weight which the balloon, with its attachments, will just support without rising or falling.

It can be shown by the principle of dynamic similarity that the rate of ascent V of a balloon in still air can be expressed by a general formula:

$$V = \frac{qL^n}{(L + W)^{1/3}} \quad (10.3)$$

in which q and n depend on the drag coefficient, and therefore on the Reynolds number, $v\rho D/\mu$ (μ being the viscosity of the air). Unfortunately, a large number of meteorological balloons, at some stages of flight, have Reynolds numbers within the critical region of 1.10^5 to 3.10^5 , where a rapid change of drag coefficient occurs, and they may not be perfectly spherical. Therefore, it is impracticable to use a simple formula which is valid for balloons of different sizes and different free lifts. The values of q and n in the above equation must, therefore, be derived by experiment; they are typically, very approximately, about 150 and about 0.5, respectively if the ascent rate is expressed in m min⁻¹. Other factors, such as the change of air density and gas leakage, can also affect the rate of ascent and can cause appreciable variation with height.

In conducting soundings during precipitation or in icing conditions, a free lift increase of up to about 75 per cent, depending on the severity of the conditions, may be required. An assumed rate of ascent should not be used in any conditions other than light precipitation. A precise knowledge of the rate of ascent is not usually necessary except in the case of pilot- and ceiling-balloon observations, where there is no other means of determining the height. The rate of ascent depends largely on the free lift and air resistance acting on the balloon and train. Drag can be more important, especially in the case of non-spherical balloons. Maximum height depends mainly on the total lift and on the size and quality of the balloon.

10.2.2 Balloon performance

The table below lists typical figures for the performance of various sizes of balloons. They are very approximate. If precise knowledge of the performance of a particular balloon and train is necessary, it must be obtained by analysing actual flights. Balloons can carry payloads greater than those listed in the table if the total lift is increased. This is achieved by using more gas and by increasing the volume of the balloon, which will affect the rate of ascent and the maximum height.

The choice of a balloon for meteorological purposes is dictated by the load, if any, to be carried, the rate of ascent, the altitude required, whether the balloon is to be used for visual tracking, and by the cloud cover with regard to its

Typical balloon performance

Weight (g)	10	30	100	200	350	600	1 000	1 500	3 000
Diameter at release (cm)	30	50	90	120	130	140	160	180	210
Payload (g)	0	0	0	250	250	250	250	1 000	1 000
Free lift (g)	5	60	300	500	600	900	1 100	1 300	1 700
Rate of ascent (m min ⁻¹)	60	150	250	300	300	300	300	300	300
Maximum height (km)	12	13	20	21	26	31	34	34	38

colour. Usually, a rate of ascent between 300 and 400 m min⁻¹ is desirable in order to minimize the time required for observation; it may also be necessary in order to provide sufficient ventilation for the radiosonde sensors. In choosing a balloon, it is also necessary to bear in mind that the altitude attained is usually less when the temperature at release is very low.

For balloons used in regular operations, it is beneficial to determine the free lift that produces optimum burst heights. For instance, it has been found that a reduction in the average rate of ascent from 390 to 310 m min⁻¹ with some mid-size balloons by reducing the amount of gas for inflation may give an increase of 2 km, on average, in the burst height. Burst height records should be kept and reviewed to ensure that optimum practice is sustained.

Daytime visual observations are facilitated by using uncoloured balloons on clear sunny days, and dark-coloured ones on cloudy days.

The performance of a balloon is best gauged by the maximum linear extension it will withstand before bursting and is conveniently expressed as the ratio of the diameter (or circumference) at burst to that of the unstretched balloon. The performance of a balloon in flight, however, is not necessarily the same as that indicated by a bursting test on the ground. Performance can be affected by rough handling when the balloon is filled and by stresses induced during launches in gale conditions. In flight, the extension of the balloon may be affected by the loss of elasticity at low temperatures, by the chemical action of oxygen, ozone and ultraviolet radiation, and by manufacture faults such as pinholes or weak spots. A balloon of satisfactory quality should, however, give at least a fourfold extension in an actual sounding. The thickness of

the film at release is usually in the range of 0.1 to 0.2 mm.

There is always a small excess of pressure p_1 within the balloon during ascent, amounting to a few hPa, owing to the tension of the rubber. This sets a limit to the external pressure that can be reached. It can be shown that, if the temperature is the same inside and outside the balloon, this limiting pressure p is given by:

$$p = \left(\frac{1.07W}{L_0} + 0.075 \right) p_1 \cong \frac{Wp_1}{L_0} \quad (10.4)$$

where W is the weight of the balloon and apparatus; and L_0 is the free lift at the ground, both expressed in grams. If the balloon is capable of reaching the height corresponding with p , it will float at this height.

10.3 HANDLING BALLOONS

10.3.1 Storage

It is very important that radiosonde balloons should be correctly stored if their best performance is still to be obtained after several months. It is advisable to restrict balloon stocks to the safe minimum allowed by operational needs. Frequent deliveries, wherever possible, are preferable to purchasing in large quantities with consequent long periods of storage. To avoid the possibility of using balloons that have been in storage for a long period, balloons should always be used in the order of their date of manufacture.

It is generally possible to obtain the optimum performance up to about 18 months after manufacture, provided that the storage conditions are

carefully chosen. Instructions are issued by many manufacturers for their own balloons and these should be observed meticulously. The following general instructions are applicable to most types of radiosondes balloons.

Balloons should be stored away from direct sunlight and, if possible, in the dark. At no time should they be stored adjacent to any source of heat or ozone. Balloons made of either polychloroprene or a mixture, or polychloroprene and natural rubber may deteriorate if exposed to the ozone emitted by large electric generators or motors. All balloons should be kept in their original packing until required for preflight preparations. Care should be taken to see that they do not come into contact with oil or any other substance that may penetrate the wrapping and damage the balloons.

Wherever possible, balloons should be stored in a room at temperatures of 15 to 25°C; some manufacturers give specific guidance on this point and such instructions should always be followed.

10.3.2 **Conditioning**

Balloons made from natural rubber do not require special heat treatment before use, as natural rubber does not freeze at the temperatures normally experienced in buildings used for human occupation. It is, however, preferable for balloons that have been stored for a long period at temperatures below 10°C to be brought to room temperature for some weeks before use.

Polychloroprene balloons suffer a partial loss of elasticity during prolonged storage at temperatures below 10°C. For the best results, this loss should be restored prior to inflation by conditioning the balloon. The manufacturer's recommendations should be followed. It is common practice to place the balloon in a thermally insulated chamber with forced air circulation, maintained at suitable temperature and humidity for some days before inflation, or alternatively to use a warm water bath.

At polar stations during periods of extremely low temperatures, the balloons to be used should have special characteristics that enable them to maintain strength and elasticity in such conditions.

10.3.3 **Inflation**

If a balloon launcher is not used, a special room, preferably isolated from other buildings, should be provided for filling balloons. It should be well

ventilated (e.g. NFPA, 1999). If hydrogen gas is to be used, special safety precautions are essential (see section 10.6). The building should be free from any source of sparks, and all electric switches and fittings should be spark-proof; other necessary details are given in section 10.6.2. If helium gas is to be used, provision may be made for heating the building during cold weather. The walls, doors and floor should have a smooth finish and should be kept free from dust and grit. Heating hydrogen-inflation areas can be accomplished by steam, hot water or any other indirect means; however, electric heating, if any, shall be in compliance with national electrical codes (e.g. NFPA 50A for Class I, Division 2, locations).

Protective clothing (see section 10.6.4) should be worn during inflation. The operator should not stay in a closed room with a balloon containing hydrogen. The hydrogen supply should be controlled and the filling operation observed, from outside the filling room if the doors are shut, and the doors should be open when the operator is in the room with the balloon.

Balloons should be inflated slowly because sudden expansion may cause weak spots in the balloon film. It is desirable to provide a fine adjustment valve for regulating the gas flow. The desired amount of inflation (free lift) can be determined by using either a filling nozzle of the required weight or one which forms one arm of a balance on which the balloon lift can be weighed. The latter is less convenient, unless it is desirable to allow for variations in the weights of balloons, which is hardly necessary for routine work. It is useful to have a valve fitted to the weight type of the filler, and a further refinement, used in some services, is to have a valve that can be adjusted to close automatically at the required lift.

10.3.4 **Launching**

The balloon should be kept under a shelter until everything is ready for its launch. Prolonged exposure to bright sunshine should be avoided as this may cause a rapid deterioration of the balloon fabric and may even result in its bursting before leaving the ground. Protective clothing should be worn during manual launches.

No special difficulties arise when launching radiosonde balloons in light winds. Care should always be taken to see that there is no risk of the balloon and instruments striking obstructions before they

rise clear of trees and buildings in the vicinity of the station. Release problems can be avoided to a large extent by carefully planning the release area. It should be selected to have a minimum of obstructions that may interfere with launching; the station buildings should be designed and sited considering the prevailing wind, gust effects on the release area and, in cold climates, drifting snow.

It is also advisable in high winds to keep the suspension of the instrument below the balloon as short as possible during launching, by using some form of suspension release or unwinder. A convenient device consists of a reel on which the suspension cord is wound and a spindle to which is attached an air brake or escapement mechanism that allows the suspension cord to unwind slowly after the balloon is released.

Mechanical balloon launchers have the great advantage that they can be designed to offer almost fool-proof safety, by separating the operator from the balloon during filling and launching. They can be automated to various degrees, even to the point where the whole radiosonde operation requires no operator to be present. They might not be effective at wind speeds above 20 m s^{-1} . Provision should be made for adequate ventilation of the radiosonde sensors before release, and the construction should desirably be such that the structure will not be damaged by fire or explosion.

10.4 ACCESSORIES FOR BALLOON ASCENTS

10.4.1 Illumination for night ascents

The light source in general use for night-time pilot-balloon ascents at night is a small electric torch battery and lamp. A battery of two 1.5 V cells, or a water-activated type used with a 2.5 V 0.3 A bulb, is usually suitable. Alternatively, a device providing light by means of chemical fluorescence may be used. For high-altitude soundings, however, a more powerful system of 2 to 3 W, together with a simple reflector, is necessary.

If the rate of ascent is to remain unchanged when a lighting unit is to be used, a small increase in free lift is theoretically required; that is to say, the total lift must be increased by more than the extra weight carried (see equation 10.3). In practice, however, the increase required is probably less than that calculated since the load improves the aerodynamic shape and the stability of the balloon.

At one time, night ascents were carried with a small candle in a translucent paper lantern suspended some 2 m or so below the balloon. However, there is a risk of flash or explosion if the candle is brought near the balloon or the source of hydrogen, and there is a risk of starting a forest fire or other serious fires upon return to the Earth. Thus, the use of candles is strongly discouraged.

10.4.2 Parachutes

In order to reduce the risk of damage caused by a falling sounding instrument, it is usual practice to attach a simple type of parachute. The main requirements are that it should be reliable when opening and should reduce the speed of descent to a rate not exceeding about 5 m s^{-1} near the ground. It should also be water-resistant. For instruments weighing up to 2 kg, a parachute made from waterproof paper or plastic film of about 2 m diameter and with strings about 3 m long is satisfactory. In order to reduce the tendency for the strings to twist together in flight it is advisable to attach them to a light hoop of wood, plastic or metal of about 40 cm in diameter just above the point where they are joined together.

When a radar reflector for wind-finding is part of the train it can be incorporated into the parachute and can serve to keep the strings apart. The strings and attachments must be able to withstand the opening of the parachute. If light-weight radiosondes are used (less than about 250 g), the radar reflector alone may provide sufficient drag during descent.

10.5 GASES FOR INFLATION

10.5.1 General

The two gases most suitable for meteorological balloons are helium and hydrogen. The former is much to be preferred on account of the fact that is free from risk of explosion and fire risks. However, since the use of helium is limited mainly to the few countries which have an abundant natural supply, hydrogen is more generally used (see WMO, 1982). The buoyancy (total lift) of helium is 1.115 kg m^{-3} , at a pressure of 1 013 hPa and a temperature of 15°C . The corresponding figure for pure hydrogen is 1.203 kg m^{-3} and for commercial hydrogen the figure is slightly lower than this.

It should be noted that the use of hydrogen aboard ships is no longer permitted under the general conditions imposed for marine insurance. In these

circumstances, the extra cost of using helium has to be reckoned against the life-threatening hazards to and the extra cost of insurance, if such insurance can be arranged.

Apart from the cost and trouble of transportation, the supply of compressed gas in cylinders affords the most convenient way of providing gas at meteorological stations. However, at places where the cost or difficulty of supplying cylinders is prohibitive, the use of an on-station hydrogen generator (see section 10.5.3) should present no great difficulties.

10.5.2 Gas cylinders

For general use, steel gas cylinders, capable of holding 6 m³ of gas compressed to a pressure of 18 MPa (10 MPa in the tropics), are probably the most convenient size. However, where the consumption of gas is large, as at radiosonde stations, larger capacity cylinders or banks of standard cylinders all linked by a manifold to the same outlet valve can be useful. Such arrangements will minimize handling by staff. In order to avoid the risk of confusion with other gases, hydrogen cylinders should be painted a distinctive colour (red is used in many countries) and otherwise marked according to national regulations. Their outlet valves should have left-handed threads to distinguish them from cylinders of non-combustible gases. Cylinders should be provided with a cap to protect the valves in transit.

Gas cylinders should be tested at regular intervals ranging from two to five years, depending on the national regulations in force. This should be performed by subjecting them to an internal pressure of at least 50 per cent greater than their normal working pressure. Hydrogen cylinders should not be exposed to heat and, in tropical climates, they should be protected from direct sunshine. Preferably, they should be stored in a well-ventilated shed which allows any hydrogen leaks to escape to the open air.

10.5.3 Hydrogen generators

Hydrogen can be produced on site in various kinds of hydrogen generators. All generator plants and hydrogen storage facilities shall be legibly marked and with adequate warnings according to national regulations (e.g. "This unit contains hydrogen"; "Hydrogen – Flammable gas – No smoking – No open flames"). The following have proven to be the most suitable processes for generating hydrogen for meteorological purposes:

- (a) Ferro-silicon and caustic soda with water;
- (b) Aluminium and caustic soda with water;
- (c) Calcium hydride and water;
- (d) Magnesium-iron pellets and water;
- (e) Liquid ammonia with hot platinum catalyst;
- (f) Methanol and water with a hot catalyst;
- (g) Electrolysis of water.

Most of the chemicals used in these methods are hazardous, and the relevant national standards and codes of practice should be scrupulously followed, including correct markings and warnings. They require special transportation, storage, handling and disposal. Many of them are corrosive, as is the residue after use. If the reactions are not carefully controlled, they may produce excess heat and pressure. Methanol, being a poisonous alcohol, can be deadly if ingested, as it may be by substance abusers.

In particular, caustic soda, which is widely used, requires considerable care on the part of the operator, who should have adequate protection, especially for the eyes, from contact not only with the solution, but also with the fine dust which is liable to arise when the solid material is being put into the generator. An eye-wash bottle and a neutralizing agent, such as vinegar, should be kept at hand in case of an accident.

Some of the chemical methods operate at high pressure, with a consequential greater risk of an accident. High-pressure generators should be tested every two years to a pressure at least twice that of the working pressure. They should be provided with a safety device to relieve excess pressure. This is usually a bursting disc, and it is very important that the operational instructions should be strictly followed with regard to the material, size and form of the discs, and the frequency of their replacement. Even if a safety device is efficient, its operation is very liable to be accompanied by the ejection of hot solution. High-pressure generators must be carefully cleaned out before recharging since remains of the previous charge may considerably reduce the available volume of the generator and, thus, increase the working pressure beyond the design limit.

Unfortunately, calcium hydride and magnesium-iron, which have the advantage of avoiding the use of caustic soda, are expensive to produce and are, therefore, likely to be acceptable only for special purposes. Since these two materials produce hydrogen from water, it is essential that they be stored in containers which are completely damp-proof. In

the processes using catalysts, care must be taken to avoid catalyst contamination.

All systems produce gas at sufficient pressure for filling balloons. However, the production rates of some systems (electrolysis in particular) are too low, and the gas must be produced and stored before it is needed, either in compressed form or in a gasholder.

The processes using the electrolysis of water or the catalytic cracking of methanol are attractive because of their relative safety and moderate recurrent cost, and because of the non-corrosive nature of the materials used. These two processes, as well as the liquid ammonia process, require electric power. The equipment is rather complex and must be carefully maintained and subjected to detailed daily check procedures to ensure that the safety control systems are effective. Water for electrolysis must have low mineral content.

10.6 USE OF HYDROGEN AND SAFETY PRECAUTIONS

10.6.1 General

Hydrogen can easily be ignited by a small spark and burns with a nearly invisible flame. It can burn when mixed with air over a wide range of concentrations, from 4 to 74 per cent by volume (NFPA, 1999), and can explode in concentrations between 18 and 59 per cent. In either case, a nearby operator can receive severe burns over the entire surface of any exposed skin, and an explosion can throw the operator against a wall or the ground, causing serious injury.

It is possible to eliminate the risk of an accident by using very carefully designed procedures and equipment, provided that they are diligently observed and maintained (Gremia, 1977; Ludtke and Saraduke, 1992; NASA, 1968). The provision of adequate safety features for the buildings in which hydrogen is generated and stored, or for the areas in which balloons are filled or released, does not always receive adequate attention (see the following section). In particular, there must be comprehensive training and continual meticulous monitoring and inspection to ensure that operators follow the procedures.

The great advantage of automatic balloon launchers (see section 10.3.4) is that they can be made practically fool-proof and prevent operator injuries,

by completely separating the operator from the hydrogen.

An essential starting point for the consideration of hydrogen precautions is to follow the various national standards and codes of practice concerned with the risks presented by explosive atmospheres in general. Additional information on the precautions that should be followed will be found in publications dealing with explosion hazards, such as in hospitals and other industrial situations where similar problems exist. The operator should never be in a closed room with an inflated balloon. Other advice on safety matters can be found throughout the chapter.

10.6.2 Building design

Provisions should be made to avoid the accumulation of free hydrogen and of static charges as well as the occurrence of sparks in any room where hydrogen is generated, stored or used. The accumulation of hydrogen must be avoided even when a balloon bursts within the shelter during the course of inflation (WMO, 1982).

Safety provisions must be part of the structural design of hydrogen buildings (NFPA, 1999; SAA, 1985). Climatic conditions and national standards and codes are constraints within which it is possible to adopt many designs and materials suitable for safe hydrogen buildings. Codes are advisory and are used as a basis of good practice. Standards are published in the form of specifications for materials, products and safe practices. They should deal with topics such as flame-proof electric-light fittings, electrical apparatus in explosive atmospheres, the ventilation of rooms with explosive atmospheres, and the use of plastic windows, bursting discs, and so on (WMO, 1982).

Both codes and standards should contain information that is helpful and relevant to the design of hydrogen buildings. Furthermore, it should be consistent with recommended national practice. Guidance should be sought from national standards authorities when hydrogen buildings are designed or when the safety of existing buildings is reviewed, in particular for aspects such as the following:

- (a) The preferred location for hydrogen systems;
- (b) The fire resistance of proposed materials, as related to the fire-resistance ratings that must be respected;
- (c) Ventilation requirements, including a roof of light construction to ensure that hydrogen

and products of an explosion are vented from the highest point of the building;

- (d) Suitable electrical equipment and wiring;
- (e) Fire protection (extinguishers and alarms);
- (f) Provision for the operator to control the inflation of the balloon from outside the filling room.

Measures should be taken to minimize the possibility of sparks being produced in rooms where hydrogen is handled. Thus, any electrical system (switches, fittings, wiring) should be kept outside these rooms; otherwise, special spark-proof switches, pressurized to prevent the ingress of hydrogen, and similarly suitable wiring, should be provided. It is also advisable to illuminate the rooms using exterior lights which shine in through windows. For the same reasons, any tools used should not produce sparks. The observer's shoes should not be capable of emitting sparks, and adequate lightning protection should be provided.

If sprinkler systems are used in any part of the building, consideration should be given to the possible hazard of hydrogen escaping after the fire has been extinguished. Hydrogen detection systems exist and may be used, for instance, to switch off power to the hydrogen generator at 20 per cent of the lower explosive limit and should activate an alarm, and then activate another alarm at 40 per cent of the lower explosive limit.

A hazard zone should be designated around the generator, storage and balloon area into which entry is permitted only when protective clothing is worn (see section 10.6.4).

Balloon launchers (see section 10.3.4) typically avoid the need for a special balloon-filling room, and greatly simplify the design of hydrogen facilities.

10.6.3 Static charges

The hazards of balloon inflation and balloon release can be considerably reduced by preventing static charges in the balloon-filling room, on the observer's clothing, and on the balloon itself. Loeb (1958) provides information on the static electrification process. Static charge control is effected by good earthing provisions for hydrogen equipment and filling-room fittings. Static discharge grips for observers can remove charges generated on clothing (WMO, 1982).

Charges on balloons are more difficult to deal with. Balloon fabrics, especially pure latex, are very good insulators. Static charges are generated when two insulating materials in contact with each are separated. A single brief contact with the observer's clothing or hair can generate a 20 kV charge, which is more than sufficient to ignite a mixture of air and hydrogen if it is discharged through an efficient spark. Charges on a balloon may take many hours to dissipate through the fabric to earth or naturally into the surrounding air. Also, it has been established that, when a balloon bursts, the separation of the film along a split in the fabric can generate sparks energetic enough to cause ignition.

Electrostatic charges can be prevented or removed by spraying water onto the balloon during inflation, by dipping balloons into antistatic solution (with or without drying them off before use), by using balloons with an antistatic additive in the latex, or by blowing ionized air over the balloon. Merely earthing the neck of the balloon is not sufficient.

The maximum electrostatic potential that can be generated or held on a balloon surface decreases with increasing humidity, but the magnitude of the effect is not well established. Some tests carried out on inflated 20 g balloons indicated that spark energies sufficient to ignite hydrogen-oxygen mixtures are unlikely to be reached when the relative humidity of the air is greater than 60 per cent. Other studies have suggested relative humidities from 50 to 76 per cent as safe limits, yet others indicate that energetic sparks may occur at even higher relative humidity. It may be said that static discharge is unlikely when the relative humidity exceeds 70 per cent, but this should not be relied upon (see Cleves, Sumner and Wyatt, 1971).

It is strongly recommended that fine water sprays be used on the balloon because the wetting and earthing of the balloon will remove most of the static charges from the wetted portions. The sprays should be designed to wet as large an area of the balloon as possible and to cause continuous streams of water to run from the balloon to the floor. If the doors are kept shut, the relative humidity inside the filling room can rise to 75 per cent or higher, thus reducing the probability of sparks energetic enough to cause ignition. Balloon release should proceed promptly once the sprays are turned off and the filling-shed doors opened.

Other measures for reducing the build-up of static charge include the following (WMO, 1982):

- (a) The building should be provided with a complete earthing (grounding) system, with all fittings, hydrogen equipment and the lightning conductor separately connected to a single earth, which itself must comply with national specifications for earth electrodes. Provision should be made to drain electrical charges from the floor;
- (b) Static discharge points should be provided for the observers;
- (c) The windows should be regularly coated with an antistatic solution;
- (d) Operators should be encouraged not to wear synthetic clothing or insulating shoes. It is good practice to provide operators with partially conducting footwear;
- (e) Any contact between the observer and the balloon should be minimized; this can be facilitated by locating the balloon filler at a height of 1 m or more above the floor.

10.6.4 **Protective clothing and first-aid facilities**

Proper protective clothing should be worn whenever hydrogen is being used, during all parts of the operations, including generation procedures, when handling cylinders, and during balloon inflation and release. The clothing should include a light-weight flame-proof coat with a hood made of non-synthetic, antistatic material and a covering for the lower face, glasses or goggles, cotton gloves, and any locally recommended anti-flash clothing (see Hoschke and others, 1979).

First-aid facilities appropriate to the installation should be provided. These should include initial remedies for flash burns and broken limbs. When chemicals are used, suitable neutralizing solutions should be on hand, for example, citric acid for caustic soda burns. An eye-wash apparatus ready for instant use should be available (WMO, 1982).

REFERENCES AND FURTHER READING

- Atmospheric Environment Service (Canada), 1978: *The Use of Hydrogen for Meteorological Purposes in the Canadian Atmospheric Environment Service*, Toronto.
- Cleves, A.C., J.F. Sumner and R.M.H. Wyatt, 1971: The Effect of Temperature and Relative Humidity on the Accumulation of Electrostatic Charges on Fabrics and Primary Explosives. *Proceedings of the Third Conference on Static Electrification*, (London).
- Gremia, J.O., 1977: *A Safety Study of Hydrogen Balloon Inflation Operations and Facilities of the National Weather Service*. Trident Engineering Associates, Annapolis, Maryland.
- Hoschke, B.N., and others, 1979: *Report to the Bureau of Meteorology on Protection Against the Burn Hazard from Exploding Hydrogen-filled Meteorological Balloons*. CSIRO Division of Textile Physics and the Department of Housing and Construction, Australia.
- Loeb, L.B., 1958: *Static Electrification*, Springer-Verlag, Berlin.
- Ludtke, P. and G. Saraduke, 1992: *Hydrogen Gas Safety Study Conducted at the National Weather Service Forecast Office*. Norman, Oklahoma.
- National Aeronautics and Space Administration, 1968: *Hydrogen Safety Manual*. NASA Technical Memorandum TM-X-52454, NASA Lewis Research Center, United States.
- National Fire Protection Association, 1999: *NFPA 50A: Standard for Gaseous Hydrogen Systems at Consumer Sites*. 1999 edition, National Fire Protection Association, Quincy, Maryland.
- National Fire Protection Association, 2002: *NFPA 68: Guide for Venting of Deflagrations*. 2002 edition, National Fire Protection Association, Batterymarch Park, Quincy, Maryland.
- National Fire Protection Association, 2005: *NFPA 70, National Electrical Code*. 2005 edition, National Fire Protection Association, Quincy, Maryland.
- National Fire Protection Association, 2006: *NFPA 220, Standard on Types of Building Construction*. 2006 edition, National Fire Protection Association, Quincy, Maryland.
- Rosen, B., V.H. Dayan and R.L. Proffit, 1970: *Hydrogen Leak and Fire Detection: A Survey*. NASA SP-5092.
- Standards Association of Australia, 1970: AS C99: *Electrical equipment for explosive atmospheres – Flameproof electric lightning fittings*.
- Standards Association of Australia, 1980: AS 1829: *Intrinsically safe electrical apparatus for explosive atmospheres*.
- Standards Association of Australia, 1985: AS 1482: *Electrical equipment for explosive atmospheres – Protection by ventilation – Type of protection V*.
- Standards Association of Australia, 1995: AS/NZS 1020: *The control of undesirable static electricity*.
- Standards Association of Australia, 2004: AS 1358: *Bursting discs and bursting disc devices – Application selection and installation*.
- World Meteorological Organization, 1982: *Meteorological Balloons: The Use of Hydrogen for Inflation of Meteorological Balloons*. Instruments and Observing Methods Report No. 13, Geneva.
-

URBAN OBSERVATIONS

11.1 GENERAL

There is a growing need for meteorological observations conducted in urban areas. Urban populations continue to expand, and Meteorological Services are increasingly required to supply meteorological data in support of detailed forecasts for citizens, building and urban design, energy conservation, transportation and communications, air quality and health, storm water and wind engineering, and insurance and emergency measures. At the same time, Meteorological Services have difficulty in making urban observations that are not severely compromised. This is because most developed sites make it impossible to conform to the standard guidelines for site selection and instrument exposure given in Part I of this Guide owing to obstruction of air-flow and radiation exchange by buildings and trees, unnatural surface cover and waste heat and water vapour from human activities.

This chapter provides information to enable the selection of sites, the installation of a meteorological station and the interpretation of data from an urban area. In particular, it deals with the case of what is commonly called a “standard” climate station. Despite the complexity and inhomogeneity of urban environments, useful and repeatable observations can be obtained. Every site presents a unique challenge. To ensure that meaningful observations are obtained requires careful attention to certain principles and concepts that are virtually unique to urban areas. It also requires the person establishing and running the station to apply those principles and concepts in an intelligent and flexible way that is sensitive to the realities of the specific environment involved. Rigid “rules” have little utility. The need for flexibility runs slightly counter to the general notion of standardization that is promoted as WMO observing practice. In urban areas, it is sometimes necessary to accept exposure

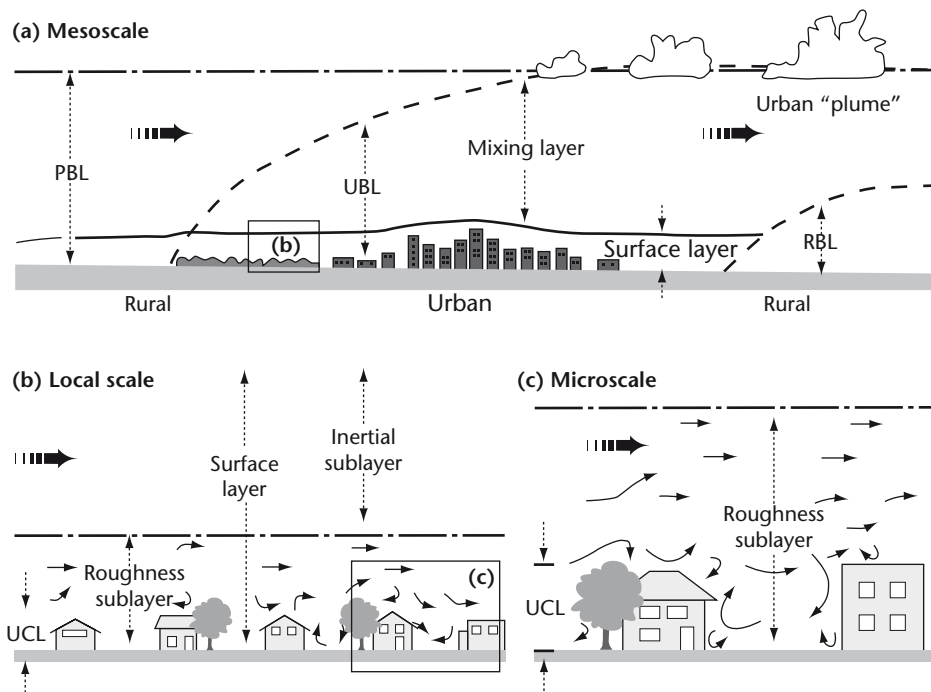

Figure 11.1. Schematic of climatic scales and vertical layers found in urban areas: planetary boundary layer (PBL), urban boundary layer (UBL), urban canopy layer (UCL), rural boundary layer (RBL) (modified from Oke, 1997).

over non-standard surfaces at non-standard heights, to split observations between two or more locations, or to be closer than usual to buildings or waste heat exhausts.

The units of measurement and the instruments used in urban areas are the same as those for other environments. Therefore, only those aspects that are unique to urban areas, or that are made difficult to handle because of the nature of cities, such as the choice of site, instrument exposure and the documentation of metadata, are covered in this chapter.

The timing and frequency of observations and the coding of reports should follow appropriate standards (WMO, 1983; 1988; 1995; 2003*b*; 2006).

With regard to automated stations and the requirements for message coding and transmission, quality control, maintenance (noting any special demands of the urban environment) and calibration, the recommendations of Part II, Chapter 1, should be followed.

11.1.1 Definitions and concepts

11.1.1.1 Station rationale

The clarity of the reason for establishing an urban station is essential to its success. Two of the most usual reasons are the wish to represent the meteorological environment at a place for general climatological purposes and the wish to provide data in support of the needs of a particular user. In both cases, the spatial and temporal scales of interest must be defined, and, as outlined below, the siting of the station and the exposure of the instruments in each case may have to be very different.

11.1.1.2 Horizontal scales

There is no more important an input to the success of an urban station than an appreciation of the concept of scale. There are three scales of interest (Oke, 1984; Figure 11.1):

- (a) **Microscale:** Every surface and object has its own microclimate on it and in its immediate vicinity. Surface and air temperatures may vary by several degrees in very short distances, even millimetres, and air-flow can be greatly perturbed by even small objects. Typical scales of urban microclimates relate to the dimensions of individual buildings, trees, roads, streets, courtyards, gardens, and so forth. Typical scales extend from less than 1 m to hundreds of metres. The formulation

of the guidelines in Part I of this Guide specifically aims to avoid microclimatic effects. The climate station recommendations are designed to standardize all sites, as far as practical. This explains the use of a standard height of measurement, a single surface cover, minimum distances to obstacles and little horizon obstruction. The aim is to achieve climate observations that are free of extraneous microclimate signals and hence characterize local climates. With even more stringent standards, first order stations may be able to represent conditions at synoptic space and time scales. The data may be used to assess climate trends at even larger scales. Unless the objectives are very specialized, urban stations should also avoid microclimate influences; however, this is hard to achieve;

- (b) **Local scale:** This is the scale that standard climate stations are designed to monitor. It includes landscape features such as topography, but excludes microscale effects. In urban areas this translates to mean the climate of neighbourhoods with similar types of urban development (surface cover, size and spacing of buildings, activity). The signal is the integration of a characteristic mix of microclimatic effects arising from the source area in the vicinity of the site. The source area is the portion of the surface upstream that contributes the main properties of the flux or meteorological concentration being measured (Schmid, 2002). Typical scales are one to several kilometres;
- (c) **Mesoscale:** A city influences weather and climate at the scale of the whole city, typically tens of kilometres in extent. A single station is not able to represent this scale.

11.1.1.3 Vertical scales

An essential difference between the climate of urban areas and that of rural or airport locations is that in cities the vertical exchanges of momentum, heat and moisture do not occur at a (nearly) plane surface, but in a layer of significant thickness, called the urban canopy layer (UCL) (Figure 11.1). The height of the UCL is approximately equivalent to that of the mean height of the main roughness elements (buildings and trees), z_H (see Figure 11.4 for parameter definitions). The microclimatic effects of individual surfaces and obstacles persist for a short distance away from their source and are then mixed and muted by the action of turbulent eddies. The distance required before the effect is obliterated depends on the magnitude of the effect, wind speed and stability (namely, stable, neutral or unstable).

This blending occurs both in the horizontal and the vertical. As noted, horizontal effects may persist up to a few hundred metres. In the vertical, the effects of individual features are discernible in the roughness sublayer (RSL), which extends from ground level to the blending height z_r , where the blending action is complete. Rule-of-thumb estimates and field measurements indicate that z_r can be as low as $1.5 z_H$ at densely built (closely spaced) and homogeneous sites, but greater than $4 z_H$ in low density areas (Grimmond and Oke, 1999; Rotach, 1999; Christen, 2003). An instrument placed below z_r may register microclimate anomalies, but, above that, it “sees” a blended, spatially averaged signal that is representative of the local scale.

There is another height restriction to consider. This arises because each local scale surface type generates an internal boundary layer, in which the flow structure and thermodynamic properties are adapted to that surface type. The height of the layer grows with increasing fetch (the distance upwind to the edge where the transition to a distinctly different surface type occurs). The rate at which the internal boundary layer grows with fetch distance depends on the roughness and stability. In rural conditions, the height to fetch ratios might vary from as small as 1:10 in unstable conditions to as large as 1:500 in stable cases, and the ratio decreases as the roughness increases (Garratt, 1992; Wieringa, 1993). Urban areas tend towards neutral stability owing to the enhanced thermal and mechanical turbulence associated with the heat island and their large roughness. Therefore, a height to fetch ratio of about 1:100 is considered typical. The internal boundary layer height is taken above the displacement height z_d , which is the reference level for flow above the blending height. (For an explanation of z_d , see Figure 11.4 and Note 2 in Table 11.2.)

For example, take a hypothetical densely built district with z_H of 10 m. This means that z_r is at least 15 m. If this height is chosen to be the measurement level, the fetch requirement over similar urban terrain is likely to be at least 0.8 km, since $\text{fetch} = 100(z_r - z_d)$, and z_d will be about 7 m. This can be a significant site restriction because the implication is that, if the urban terrain is not similar out to at least this distance around the station site, observations will not be representative of the local surface type. At less densely developed sites, where heat island and roughness effects are less, the fetch requirements are likely to be greater.

At heights above the blending height, but within the local internal boundary layer, measurements are within an inertial sublayer (Figure 11.1), where

standard boundary layer theory applies. Such theory governs the form of the mean vertical profiles of meteorological variables (including air temperature, humidity and wind speed) and the behaviour of turbulent fluxes, spectra and statistics. This provides a basis for:

- (a) The calculation of the source area (or “footprint”, see below) from which the turbulent flux or the concentration of a meteorological variable originates; hence, this defines the distance upstream for the minimum acceptable fetch;
- (b) The extrapolation of a given flux or property through the inertial layer and also downwards into the RSL (and, although it is less reliable, into the UCL). In the inertial layer, fluxes are constant with height and the mean value of meteorological properties are invariant horizontally. Hence, observations of fluxes and standard variables possess significant utility and are able to characterize the underlying local scale environment. Extrapolation into the RSL is less prescribed.

11.1.1.4 Source areas (“footprints”)

A sensor placed above a surface “sees” only a portion of its surroundings. This is called the “source area” of the instrument which depends on its height and the characteristics of the process transporting the surface property to the sensor. For upwelling radiation signals (short- and long-wave radiation and surface temperature viewed by an infrared thermometer) the field of view of the instrument and the geometry of the underlying surface set what is seen. By analogy, sensors such as thermometers, hygrometers, gas analysers and anemometers “see” properties such as temperature, humidity, atmospheric gases and wind speed and direction which are carried from the surface to the sensor by turbulent transport. A conceptual illustration of these source areas is given in Figure 11.2.

The source area of a downfacing radiometer with its sensing element parallel to the ground is a circular patch with the instrument at its centre (Figure 11.2). The radius (r) of the circular source area contributing to the radiometer signal at height (z_1) is given in Schmid and others (1991):

$$r = z_1 \left(\frac{1}{F} - 1 \right)^{-0.5} \quad (11.1)$$

where F is the view factor, namely the proportion of the measured flux at the sensor for which that area is responsible. Depending on its field of view, a radiometer may see only a limited circle, or it may

extend to the horizon. In the latter case, the instrument usually has a cosine response, so that towards the horizon it becomes increasingly difficult to define the actual source area seen. Hence, the use of the view factor which defines the area contributing a set proportion (often selected as 50, 90, 95, 99 or 99.5 per cent) of the instrument's signal.

The source area of a sensor that derives its signal via turbulent transport is not symmetrically distributed around the sensor location. It is elliptical in shape and is aligned in the upwind direction from the tower (Figure 11.2). If there is a wind, the effect of the surface area at the base of the mast is effectively zero, because turbulence cannot transport the influence up to the sensor level. At some distance in the upwind direction the source starts to affect the sensor; this effect rises to a peak, thereafter decaying at greater distances (for the shape in both the x and y directions see Kljun, Rotach and Schmid, 2002; Schmid, 2002). The distance upwind to the first surface area contributing to the signal, to the point of peak influence, to the furthest upwind surface influencing the measurement, and the area of the so-called "footprint" vary considerably over time. They depend on the height of measurement (larger at greater heights), surface roughness, atmospheric stability (increasing from unstable to stable) and whether a turbulent flux or a meteorological concentration is being measured (larger for the concentration) (Kljun, Rotach and Schmid, 2002).

Methods to calculate the dimensions of flux and concentration "footprints" are available (Schmid, 2002; Kljun and others, 2004).

Although the situation illustrated in Figure 11.2 is general, it applies best to instruments placed in the inertial sublayer, well above the complications of the RSL and the complex geometry of the three-dimensional urban surface. Within the UCL, the way in which the effects of radiation and turbulent source areas decay with distance has not yet been reliably evaluated. It can be surmised that they depend on the same properties and resemble the overall forms of those in Figure 11.2. However, obvious complications arise due to the complex radiation geometry, and the blockage and channeling of flow, which are characteristic of the UCL. Undoubtedly, the immediate environment of the station is by far the most critical and the extent of the source area of convective effects grows with stability and the height of the sensor. The distance influencing screen-level (~1.5 m) sensors may be a few tens of metres in neutral conditions, less when they are unstable and perhaps more than 100 m when they are stable. At a height of 3 m, the equivalent distances probably extend up to about 300 m in the stable case. The circle of influence on a screen-level temperature or humidity sensor is thought to have a radius of about 0.5 km typically, but this is likely to depend upon the building density.

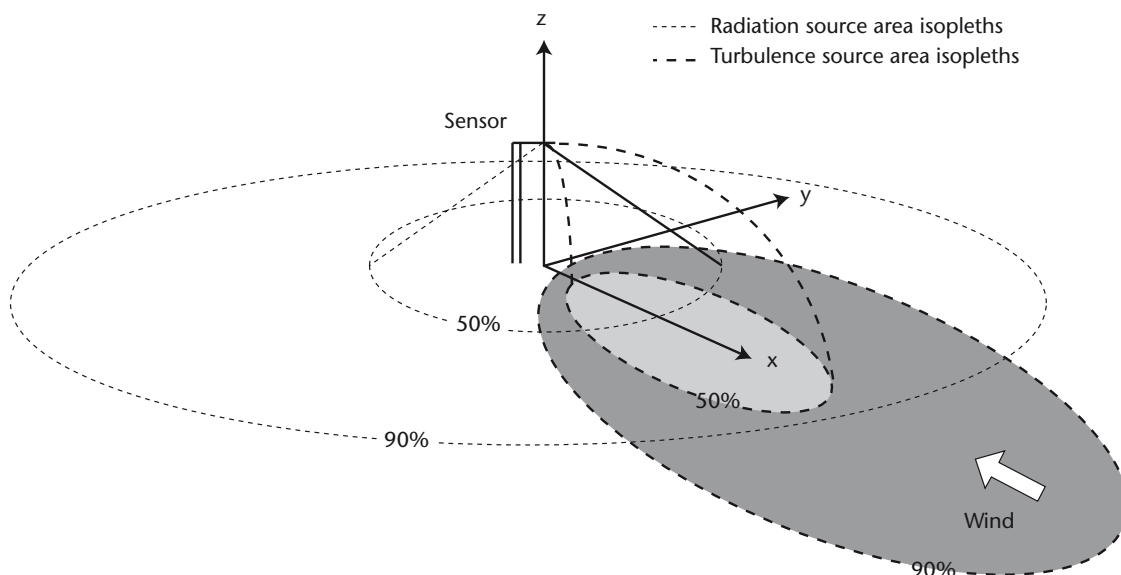

Figure 11.2. Conceptual representation of source areas contributing to sensors for radiation and turbulent fluxes of concentrations. If the sensor is a radiometer 50 or 90 per cent of the flux originates from the area inside the perspective circle. If the sensor is responding to a property of turbulent transport, 50 or 90 per cent of the signal comes from the area inside the respective ellipses. These are dynamic in the sense they are oriented into the wind and hence move with wind direction and stability.

11.1.1.5 Measurement approaches

It follows from the preceding discussion that, if the objective of an instrumented urban site is to monitor the local-scale climate near the surface, there are two viable approaches as follows:

- (a) Locate the site in the UCL at a location surrounded by average or “typical” conditions for the urban terrain, and place the sensors at heights similar to those used at non-urban sites. This assumes that the mixing induced by flow around obstacles is sufficient to blend properties to form a UCL average at the local scale;
- (b) Mount the sensors on a tall tower above the RSL and obtain blended values that can be extrapolated down into the UCL.

In general, approach (a) works best for air temperature and humidity, and approach (b) for wind speed and direction and precipitation. For radiation, the only significant requirement is for an unobstructed horizon. Urban stations, therefore, often consist of instruments deployed both below and above roof level; this requires that site assessment and description include the scales relevant to both contexts.

11.1.1.6 Urban site description

The magnitude of each urban scale does not agree precisely with those commonly given in textbooks. The scales are conferred by the dimensions of the morphometric features that make up an urban landscape. This places emphasis on the need to adequately describe properties of urban areas which affect the atmosphere. The most important basic features are the urban structure (dimensions of the buildings and the spaces between them, the street widths and street spacing), the urban cover (built-up, paved and vegetated areas, bare soil, water), the urban fabric (construction and natural materials) and the urban metabolism (heat, water and pollutants due to human activity). Hence, the characterization of the sites of urban climate stations must take account of these descriptors, use them in selecting potential sites, and incorporate them in metadata that accurately describe the setting of the station.

These four basic features of cities tend to cluster to form characteristic urban classes. For example, most central areas of cities have relatively tall buildings that are densely packed together, so the ground is largely covered with buildings or paved surfaces made of durable materials such as stone, concrete, brick and asphalt and where there are large releases from furnaces, air conditioners, chimneys and







vehicles. Near the other end of the spectrum there are districts with low density housing of one- or two-storey buildings of relatively light construction and considerable garden or vegetated areas with low heat releases, but perhaps large irrigation inputs.

No universally accepted scheme of urban classification for climatic purposes exists. A good approach to the built components is that of Ellefsen (1991) who developed a set of urban terrain zone (UTZ) types. He initially differentiates according to 3 types of building contiguity (attached (row), detached but close-set, detached and open-set). These are further divided into a total of 17 sub-types by function, location in the city, and building height, construction and age. Application of the scheme requires only aerial photography, which is generally available, and the scheme has been applied in several cities around the world and seems to possess generality.

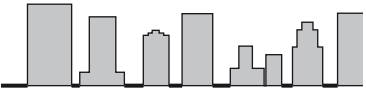
Ellefsen’s scheme can be used to describe urban structure for roughness, airflow, radiation access and screening. It can be argued that the scheme indirectly includes aspects of urban cover, fabric and metabolism because a given structure carries with it the type of cover, materials and degree of human activity. Ellefsen’s scheme is less useful, however, when built features are scarce and there are large areas of vegetation (urban forest, low plant cover, grassland, scrub, crops), bare ground (soil or rock) and water (lakes, swamps, rivers). A simpler scheme of urban climate zones (UCZs) is illustrated in Table 11.1. It incorporates groups of Ellefsen’s zones, plus a measure of the structure, z_H/W (see Table 11.1, Note c) shown to be closely related to both flow, solar shading and the heat island, and also a measure of the surface cover (% built) that is related to the degree of surface permeability.

The importance of UCZs is not their absolute accuracy to describe the site, but their ability to classify areas of a settlement into districts, which are similar in their capacity to modify the local climate, and to identify potential transitions to different UCZs. Such a classification is crucial when beginning to set up an urban station, so that the spatial homogeneity criteria are met approximately for a station in the UCL or above the RSL. In what follows, it is assumed that the morphometry of the urban area, or a portion of it, has been assessed using detailed maps, and/or aerial photographs, satellite imagery (visible and/or thermal), planning documents or at least a visual survey conducted from a vehicle and/or on foot. Although

TABLE 11.1. Simplified classification of distinct urban forms arranged in approximate decreasing order of their ability to have an impact on local climate (Oke, 2004 unpublished)

Urban climate zone ^a	Image	Roughness class ^b	Aspect ratio ^c	% built (impermeable) ^d
1. Intensely developed urban with detached close-set high-rise buildings with cladding, e.g. downtown towers		8	> 2	> 90%
2. Intensely high density urban with 2-5 storey, attached or very-close set buildings often of bricks or stone, e.g. old city core		7	1.0-2.5	> 85
3. Highly developed, medium density urban with row or detached but close-set houses, stores and apartments, e.g. urban housing		7	0.5-1.5	70-85
4. Highly developed, low or medium density urban with large low buildings and paved parking, e.g. shopping malls, warehouses		5	0.05-0.2	70-95
5. Medium development, low density suburban with 1 or 2 storey houses, e.g. suburban houses		6	0.2-0.6, p to > 1 with trees	35-65
6. Mixed use with large buildings in open landscape, e.g. institutions such as hospitals, universities, airports		5	0.1-0.5, depends on trees	< 40
7. Semi-rural development, scattered houses in natural or agricultural areas, e.g. farms, estates		4	> 0.05, depends on trees	< 10

Buildings;
 Impervious ground;
 Pervious ground;
 Vegetation

- a A simplified set of classes that includes aspects of the schemes of Auer (1978) and Ellefsen (1990/91) plus physical measures relating to wind, and thermal and moisture control (columns on the right). Approximate correspondence between UCZ and Ellefsen’s urban terrain zones is: 1 (Dc1, Dc8), 2 (A1-A4, Dc2), 3 (A5, Dc3-5, Do2), 4 (Do1, Do4, Do5), 5 (Do3), 6 (Do6), 7 (none).
- b Effective terrain roughness according to the Davenport classification (Davenport and others, 2000); see Table 11.2.
- c Aspect ratio = Z_p/W is the average height of the main roughness elements (buildings, trees) divided by their average spacing; in the city centre this is the street canyon height/width. This measurement is known to be related to flow regime types (Oke, 1987) and thermal controls (solar shading and longwave screening) Oke 1981. Tall trees increase this measure significantly.
- d Average proportion of ground plan covered by built features (buildings, roads and paved and other impervious areas); the rest of the area is occupied by pervious cover (green space, water and other natural surfaces). Permeability affects the moisture status of the ground and hence humidification and evaporative cooling potential.

land-use maps can be helpful, it should be appreciated that they depict the *function* and not necessarily the *physical form* of the settlement. The task of urban description should result in a map with areas of UCZs delineated.

Herein, the UCZs as illustrated in Table 11.1 are used. The categories may have to be adapted to accommodate special urban forms characteristic of some ancient cities or of unplanned urban development found in some less-developed countries. For example, many towns and cities in Africa and Asia do not have as large a fraction of the surface covered by impervious materials and roads may not be paved.

11.2 CHOOSING A LOCATION AND SITE FOR AN URBAN STATION

11.2.1 Location

First, it is necessary to establish clearly the purpose of the station. If there is to be only one station inside the urban area it must be decided if the aim is to monitor the greatest impact of the city, or of a more representative or typical district, or if it is to characterize a particular site (where there may be perceived to be climate problems or where future development is planned). Areas where there is the highest probability of finding maximum effects can be judged initially by reference to the ranked list of UCZ types in Table 11.1. Similarly, the likelihood that a station

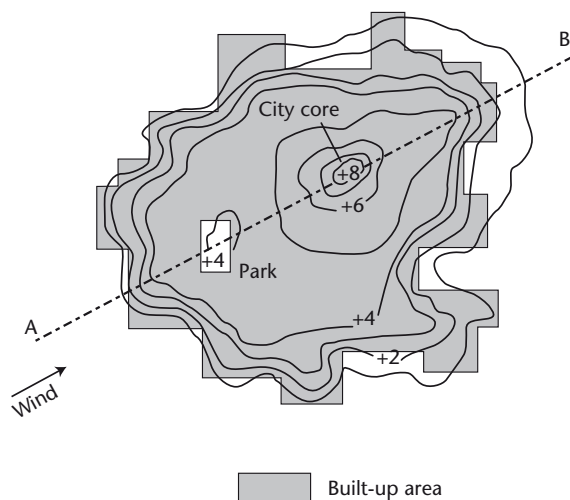

Figure 11.3. Typical spatial pattern of isotherms in a large city at night with calm, clear weather illustrating the heat island effect (after Oke, 1982).

will be typical can be assessed using the ideas behind Table 11.1 and choosing extensive areas of similar urban development for closer investigation.

The search can be usefully refined in the case of air temperature and humidity by conducting spatial surveys, wherein the sensor is carried on foot, or mounted on a bicycle or a car and taken through areas of interest. After several repetitions, cross-sections or isoline maps may be drawn (see Figure 11.3), revealing where areas of thermal or moisture anomaly or interest lie. Usually, the best time to do this is a few hours after sunset or before sunrise on nights with relatively calm air-flow and cloudless skies. This maximizes the potential for the differentiation of microclimate and local climate differences. It is not advisable to conduct such surveys close to sunrise or sunset because weather variables change so rapidly at these times that meaningful spatial comparisons are difficult.

If the station is to be part of a network to characterize spatial features of the urban climate, a broader view is needed. This consideration should be informed by thinking about the typical spatial form of urban climate distributions. For example, the isolines of urban heat and moisture “islands” indeed look like the contours of their topographic namesakes (Figure 11.3). They have relatively sharp “cliffs”, often a “plateau” over much of the urban area interspersed with localized “mounds” and “basins” of warmth/coolness and moistness/dryness. These features are co-located with patches of greater or lesser development such as clusters of apartments, shops, factories or parks, open areas or water. Therefore, a decision must be made: is the aim to make a representative sample of the UCZ diversity, or is it to faithfully reflect the spatial structure?

In most cases the latter is too ambitious with a fixed-station network in the UCL. This is because it will require many stations to depict the gradients near the periphery, the plateau region, and the highs and lows of the nodes of weaker and stronger than average urban development. If measurements are to be taken from a tower, with sensors above the RSL, the blending action produces more muted spatial patterns and the question of distance of fetch to the nearest border between UCZs, and the urban-rural fringe, becomes relevant. Whereas a distance to a change in UCZ of 0.5 to 1 km may be acceptable inside the UCL, for a tower-mounted sensor the requirement is likely to be more like a few kilometres of fetch.

Since the aim is to monitor local climate attributable to an urban area, it is necessary to avoid extraneous microclimatic influences or other local or mesoscale climatic phenomena that will complicate the urban record. Therefore, unless there is specific interest in topographically generated climate patterns, such as the effects of cold air drainage down valleys and slopes into the urban area, or the speed-up or sheltering of winds by hills and escarpments, or fog in river valleys or adjacent to water bodies, or geographically locked cloud patterns, and so on, it is sensible to avoid locations subject to such local and mesoscale effects. On the other hand, if a benefit or hazard is derived from such events, it may be relevant to design the network specifically to sample its effects on the urban climate, such as the amelioration of an overly hot city by sea or lake breezes.

11.2.2 **Siting**

Once a choice of UCZ type and its general location inside the urban area is made, the next step is to inspect the map, imagery and photographic evidence to narrow down candidate locations within a UCZ. Areas of reasonably homogeneous urban development without large patches of anomalous structure, cover or material are sought. The precise definition of “reasonably” however is not possible; almost every real urban district has its own idiosyncrasies that reduce its homogeneity at some scale. Although a complete list is therefore not possible, the following are examples of what to avoid: unusually wet patches in an otherwise dry area, individual buildings that jut up by more than half the average building height, a large paved car park in an area of irrigated gardens, a large, concentrated heat source like a heating plant or a tunnel exhaust vent. Proximity to transition zones between different UCZ types should be avoided, as should sites where there are plans for or the likelihood of major urban redevelopment. The level of concern about anomalous features decreases with distance away from the site itself, as discussed in relation to source areas.

In practice, for each candidate site a “footprint” should be estimated for radiation (for example, equation 11.1) and for turbulent properties. Then, key surface properties such as the mean height and density of the obstacles and characteristics of the surface cover and materials should be documented within these footprints. Their homogeneity should then be judged, either visually or using statistical methods. Once target areas of acceptable

homogeneity for a screen-level or high-level (above-RSL) station are selected, it is helpful to identify potential “friendly” site owners who could host it. If a government agency is seeking a site, it may already own land in the area which is used for other purposes or have good relations with other agencies or businesses (offices, work yards, spare land, rights of way) including schools, universities, utility facilities (electricity, telephone, pipelines) and transport arteries (roads, railways). These are good sites, because access may be permitted and also because they also often have security against vandalism and may have electrical power connections.

Building roofs have often been used as the site for meteorological observations. This may often have been based on the mistaken belief that at this elevation the instrument shelter is free from the complications of the UCL. In fact, roof-tops have their own very distinctly anomalous microclimates that lead to erroneous results. Air-flow over a building creates strong perturbations in speed, direction and gustiness which are quite unlike the flow at the same elevation away from the building or near the ground (Figure 11.5). Flat-topped buildings may actually create flows on their roofs that are counter to the main external flow, and speeds vary from extreme jetting to a near calm. Roofs are also constructed of materials that are thermally rather extreme. In light winds and cloudless skies they can become very hot by day and cold by night. Hence, there is often a sharp gradient of air temperature near the roof. Furthermore, roofs are designed to be waterproof and to shed water rapidly. This, together with their openness to solar radiation and the wind, makes them anomalously dry. In general, therefore, roofs are very poor locations for air temperature, humidity, wind and precipitation observations, unless the instruments are placed on very tall masts. They can, however, be good for observing incoming radiation components.

Once the site has been chosen, it is essential that the details of the site characteristics (metadata) be fully documented (see section 11.4).

11.3 **INSTRUMENT EXPOSURE**

11.3.1 **Modifications to standard practice**

In many respects, the generally accepted standards for the exposure of meteorological instruments set out in Part I of this Guide apply to urban sites. However, there will be many occasions when it is

impossible or makes no sense to conform. This section recommends some principles that will assist in such circumstances; however, all eventualities cannot be anticipated. The recommendations here remain in agreement with general objectives set out in Part I, Chapter 1.

Many urban stations have been placed over short grass in open locations (parks, playing fields) and as a result they are actually monitoring modified rural-type conditions, not representative urban ones. This leads to the curious finding that some rural-urban pairs of stations show no urban effect on temperature (Peterson, 2003).

The guiding principle for the exposure of sensors in the UCL should be to locate them in such a manner that they monitor conditions that are representative of the environment of the selected UCZ. In cities and towns it is inappropriate to use sites similar to those which are standard in open rural areas. Instead, it is recommended that urban stations should be sited over surfaces that, within a micro-scale radius, are representative of the local scale urban environment. The % built category (Table 11.1) is a crude guide to the recommended underlying surface.

The requirement that most obviously cannot be met at many urban sites is the distance from obstacles — the site should be located well away from trees, buildings, walls or other obstructions (Chapter 1, Part I). Rather, it is recommended that the urban station be centred in an open space where the surrounding aspect ratio (z_H/W) is approximately representative of the locality.

When installing instruments at urban sites it is especially important to use shielded cables because of the ubiquity of power lines and other sources of electrical noise at such locations.

11.3.2 Temperature

11.3.2.1 Air temperature

The sensors in general use to measure air temperature (including their accuracy and response characteristics) are appropriate in urban areas. Careful attention to radiation shielding and ventilation is especially recommended. In the UCL, a sensor assembly might be relatively close to warm surfaces, such as a sunlit wall, a road or a vehicle with a hot engine, or it might receive reflected heat from glassed surfaces. Therefore, the shields used should block radiation effectively. Similarly, because an assembly placed in

the lower UCL might be too well sheltered, forced ventilation of the sensor is recommended. If a network includes a mixture of sensor assemblies with/without shields and ventilation, this might contribute to inter-site differences. Practices should therefore be uniform.

The surface over which air temperature is measured and the exposure of the sensor assembly should follow the recommendations given in the previous section, namely, the surface should be typical of the UCZ and the thermometer screen or shield should be centred in a space with approximately average z_H/W . In very densely built-up UCZ this might mean that it is located only 5 to 10 m from buildings that are 20 to 30 m high. If the site is a street canyon, z_H/W only applies to the cross-section normal to the axis of the street. The orientation of the street axis may also be relevant because of systematic sun-shade patterns. If continuous monitoring is planned, north-south oriented streets are favoured over east-west ones because there is less phase distortion, although daytime course of temperature may be rather peaked.

At non-urban stations recommended screen height is between 1.25 and 2 m above ground level. While this is also acceptable for urban sites, it may be better to relax this requirement to allow greater heights. This should not lead to significant error in most cases, especially in densely built-up areas, because observations in canyons show very slight air temperature gradients through most of the UCL, provided that the location is more than 1 m from a surface (Nakamura and Oke, 1988). Measurements at heights of 3 or 5 m are not very different from those at the standard height, have slightly greater source areas and place the sensor beyond easy reach, thus preventing damage, and away from the path of vehicles. They also ensure greater dilution of vehicle exhaust heat and reduce contamination from dust.

Air temperatures measured above the UCL, using sensors mounted on a tower, are influenced by air exchanged with the UCL plus the effects of the roofs. Roofs have much more thermic variability than most surfaces within the UCL. Most roofs are designed to insulate and hence to minimize heat exchange with the interior of the building. As a result, roof-surface temperatures often become very hot by day, whereas the partially shaded and better conducting canyon walls and floor are cooler. At night circumstances are reversed with the roofs being relatively cold and

Table 11.2. Davenport classification of effective terrain roughness^a

Class	z_0 (m)	Landscape description
4 Roughly open	0.10	Moderately open country with occasional obstacles (e.g. isolated low buildings or trees) at relative horizontal separations of at least 20 obstacle heights
5 Rough	0.25	Scattered obstacles (buildings) at relative distances of 8 to 12 obstacle heights for low solid objects (e.g. buildings) (analysis may need z_d) ^b
6 Very rough	0.5	Area moderately covered by low buildings at relative separations of 3 to 7 obstacle heights and no high trees (analysis requires z_d) ^b
7 Skimming	1.0	Densely built-up area without much building height variation (analysis requires z_d) ^b
8 Chaotic	2.0	City centres with mix of low and high-rise buildings (analysis by wind tunnel advised)

^a Abridged version (revised 2000, for urban roughness only) of Davenport and others (2000); for classes 1 to 3 and for rural classes 4 to 8, see Part I, Chapter 5, annex to this Guide and WMO (2003a).

^b First order values of z_d are given as fractions of average obstacle height, i.e.: $0.5 z_H$, $0.6 z_H$ and $0.7 z_H$ for Davenport classes 5, 6 and 7, respectively.

canyon surfaces warmer as they release their daytime heat uptake. There may also be complications due to the release of heat from roof exhaust vents. Therefore, while there is little variation of temperature with height in the UCL, there is a discontinuity near roof level both horizontally and vertically. Hence, if a meaningful spatial average is sought, sensors should be well above mean roof level, $> 1.5 z_H$ if possible, so that the mixing of roof and canyon air is accomplished. In dealing with air temperature data from an elevated sensor, it is difficult to extrapolate these levels down towards screen level because currently no standard methods are available. Similarly, there is no simple, general scheme for extrapolating air temperatures horizontally inside the UCL. Statistical models work, but they require a large archive of existing observations over a dense network, which is not usually available.

11.3.2.2 Surface temperature

Surface temperature is not commonly measured at urban stations, but it can be a very useful variable to use as input in models to calculate fluxes. A representative surface temperature requires the averaging of an adequate sample of the many surfaces, vertical as well as horizontal, that make up an urban area. This is possible only using infrared remote sensing either from a scanner mounted on an aircraft or satellite, or a downward-facing pyrgeometer, or one or more radiation thermometers of which the combined field of view covers a representative sample of the urban district. Hence, to obtain accurate results, the target must be

sampled appropriately and its average emissivity known.

11.3.2.3 Soil and road temperature

It is desirable to measure soil temperature in urban areas. The heat island effect extends down beneath a city and this may be of significance to engineering design for water pipes or road construction. In practice, the measurement of this variable may be difficult at more heavily developed urban sites. Bare ground may not be available, the soil profile is often highly disturbed, and at depth there may be obstructions or anomalously warm or cool artefacts (for example, empty, full or leaky water pipes, sewers, heat conduits). In urban areas, the measurement of grass minimum temperature has almost no practical utility.

Temperature sensors are often embedded in road pavements, especially in areas subject to freezing. They are usually part of a monitoring station for highway weather. It is often helpful to have sensors beneath both the tire track area and the centre of the lane.

11.3.3 Atmospheric pressure

At the scale of urban areas it will probably not be necessary to monitor atmospheric pressure if there is already a synoptic station in the region. If pressure sensors are included, the recommendations of Part I, Chapter 3, apply. In rooms and elsewhere in the vicinity of buildings there is the probability of pressure “pumping” due to gusts. Also,

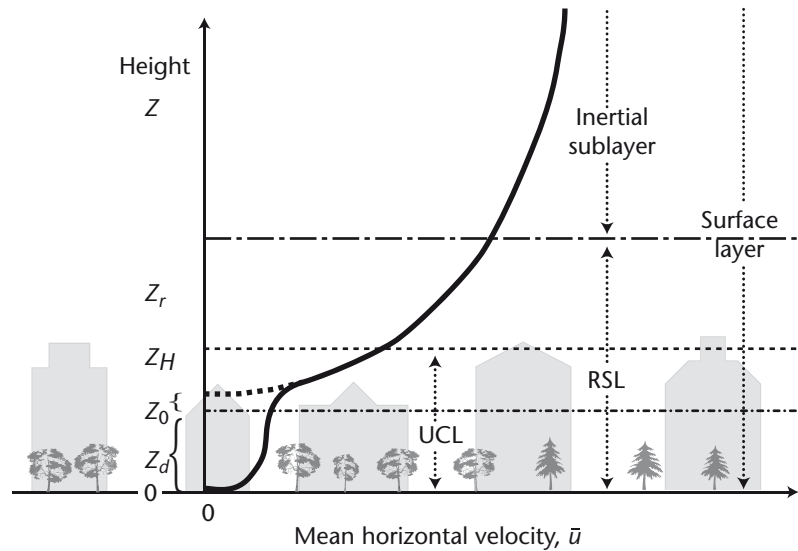

Figure 11.4. Generalized mean (spatial and temporal) wind velocity (u) profile in a densely developed urban area including the location of sublayers of the surface layer. The measures on the height scale are the mean height of the roughness elements (z_H) the roughness sublayer (z_r , or the blending height), the roughness length (z_0) and zero-plane displacement length (z_d). The dashed line represents the profile extrapolated from the inertial sublayer, the solid line represents the actual profile.

interior-exterior pressure differences may exist if the sensor is located in an air-conditioned room. Both difficulties can be alleviated if a static pressure head is installed (see Part I, Chapter 3, section 3.8).

11.3.4 Humidity

The instruments normally used for humidity (Part I, Chapter 4) are applicable to urban areas. The guidelines given in section 11.3.2.1 for the siting and exposure of temperature sensors in the UCL, and above the RSL, apply equally to humidity sensors.

Urban environments are notoriously dirty (dust, oils, pollutants). Several hygrometers are subject to degradation or require increased maintenance in urban environments. Hence, if psychrometric methods are used, the wet-bulb sleeve must be replaced more frequently than normal and close attention should be given to ensuring that the distilled water remains uncontaminated. The hair strands of a hair hygrometer can be destroyed by polluted urban air; hence, their use is not recommended for extended periods. The mirror of dew-point hygrometers and the windows of ultraviolet and infrared absorption hygrometers need to be cleaned frequently. Some instruments degrade to such an extent that the sensors have to be completely replaced fairly regularly. Because of shelter from wind in the UCL, forced ventilation at the rate recommended in Part I,

Chapter 4, section 4.2 is essential, as is the provision of shielding from extraneous sources of solar and long-wave radiation.

11.3.5 Wind speed and direction

The measurement of wind speed and direction is highly sensitive to flow distortion by obstacles. Obstacles create alterations in the average wind flow and turbulence. Such effects apply at all scales of concern, including the effects of local relief due to hills, valleys and cliffs, sharp changes in roughness or in the effective surface elevation (z_d , see below), perturbation of flow around clumps of trees and buildings, individual trees and buildings and even disturbance induced by the physical bulk of the tower or mounting arm to which the instruments are attached.

11.3.5.1 Mean wind profile

However, if a site is on reasonably level ground, has sufficient fetch downstream of major changes of roughness and is in a single UCZ without anomalously tall buildings, a mean wind profile such as that in Figure 11.4 should exist. The mean is both spatial and temporal. Within the UCL no one site can be expected to possess such a profile. Individual locations experience highly variable speed and direction shifts as the air-stream interacts with individual building arrangements, streets, courtyards and trees. In street canyons, the shape of the profile

is different for along-canyon versus across-canyon flow (Christen and others, 2002) and depends on position across and along the street (DePaul and Shieh, 1986). Wind speed gradients in the UCL are small until quite close to the surface. As a first approximation the profile in the UCL can be described by an exponential form (Britter and Hanna, 2003) merging with the log profile near the roof level (Figure 11.4).

In the inertial sublayer, the Monin-Obukhov similarity theory applies, including the logarithmic law:

$$\bar{u}_z = (u_* / k) \left\{ \ln[(z - z_d) / z_0] + \Psi_M \left(\frac{z}{L} \right) \right\} \quad (11.2)$$

where u_* is the friction velocity; k is von Karman's constant (0.40); z_0 is the surface roughness length; z_d is the zero-plane displacement height (Figure 11.4); L is the Obukhov stability length ($= -u_*^3 / [k(g/\theta_v)Q_H]$), where g is the gravitational acceleration, θ_v the virtual potential temperature and Q_H the turbulent sensible heat flux; and Ψ_M is a dimensionless function that accounts for the change in curvature of the wind profile away from the neutral profile with greater stability or instability¹. In the neutral case (typically with strong winds and cloud) when Ψ_M is unity, equation 11.2 reduces to:

$$\bar{u}_z = (u_* / k) \ln[(z - z_d) / z_0] \quad (11.3)$$

The wind profile parameters can be measured using a vertical array of anemometers, or measurements of momentum flux or gustiness from fast-response anemometry in the inertial layer, but estimates vary with wind direction and are sensitive to errors (Wieringa, 1996; Verkaik, 2000). Methods to parameterize the wind profile parameters z_0 and z_d for urban terrain are also available (for reviews, see Grimmond and Oke, 1999; Britter and Hanna, 2003). The simplest methods involve general descriptions of the land use and obstacles (see Tables 11.1 and 11.2 as well as Davenport and others, 2000; Grimmond and Oke, 1999), or a detailed description of the roughness element heights and their spacing from either a geographic information system of the building and street dimensions, or maps and aerial oblique photographs, or airborne/satellite imagery and the application of one of several empirical formulae (for recommendations, see Grimmond and Oke, 1999).

It is important to incorporate the displacement height z_d into urban wind-profile assessments. Effectively, this is equivalent to setting a base for the logarithmic wind profile that recognizes the physical bulk of the urban canopy. It is like setting a new "ground surface" aloft, where the mean momentum sink for the flow is located (Figure 11.4).

Depending on the building and tree density, this could set the base of the profile at a height of between 0.5 and 0.8 z_H (Grimmond and Oke, 1999). Hence, failure to incorporate it in calculations causes large errors. First estimates can be made using the fractions of z_H given in Table 11.2 (Note b).

11.3.5.2 Height of measurement and exposure

The choice of height at which wind measurements should be taken in urban areas is a challenge. However, if some basic principles are applied, meaningful results can be attained. The poor placement of wind sensors in cities is the source of considerable wasted resources and effort and leads to potentially erroneous calculations of pollutant dispersion. Of course, this is even a source of difficulty in open terrain due to obstacles and topographic effects. This is the reason why the standard height for rural wind observations is set at 10 m above ground, not at screen level, and why there the anemometer should not be at a horizontal distance from obstructions of less than 10 obstacle heights (Part I, Chapter 5, section 5.9.2). In typical urban districts it is not possible to find such locations, for example, in a UCZ with 10 m high buildings and trees it would require a patch that is at least 100 m in radius. If such a site exists it is almost certainly not representative of the zone. It has already been noted that the roughness sublayer, in which the effects of individual roughness elements persist, extends to a height of about 1.5 z_H in a densely built-up area and perhaps higher in less densely developed sites. Hence, in the example district the minimum acceptable anemometer height is at least 15 m, not the standard 10 m. When buildings are much taller, an anemometer at the standard 10 m height would be well down in the UCL, and, given the heterogeneity of urban form and therefore of wind structure, there is little merit in placing a wind sensor beneath, or even at about, roof level.

It is well known from wind tunnel and field observations that flow over an isolated solid obstacle, like a tall building, is greatly perturbed both

¹ For more details on L and the form of the Ψ_M function, see a standard micrometeorology text, for example, Stull, 1988; Garratt, 1992; or Arya, 2001. Note that u_* and Q_H should be evaluated in the inertial layer above the RSL.

immediately over and around it. These perturbations include modifications to the streamlines, the presence of recirculation zones on the roof and in the so-called “bubble” or cavity behind it, and wake effects that persist in the downstream flow for tens of building height multiples that affect a large part of the neighbourhood (Figure 11.5).

There are many examples of poorly exposed anemometer-vane systems in cities. The data registered by such instruments are erroneous, misleading, potentially harmful if used to obtain wind input for wind load or dispersion applications, and wasteful of resources. The inappropriateness of placing anemometers and vanes on short masts on the top of buildings cannot be over-emphasized. Speed and directions vary hugely in short distances, both horizontally and vertically. Results from instruments deployed in this manner bear little resemblance to the general flow and are entirely dependent on the specific features of the building itself, the mast location on the structure, and the angle-of-attack of the flow to the building. The circulating and vortex flows seen in Figure 11.5 mean that, if the mast is placed ahead of, on top of, or in the cavity zone behind a building, direction measurements could well be counter to those prevailing in the flow outside the influence of the building’s own wind climate (namely, in zone A of Figure 11.5a), and speeds are highly variable. To get outside the perturbed zone, wind instruments must be

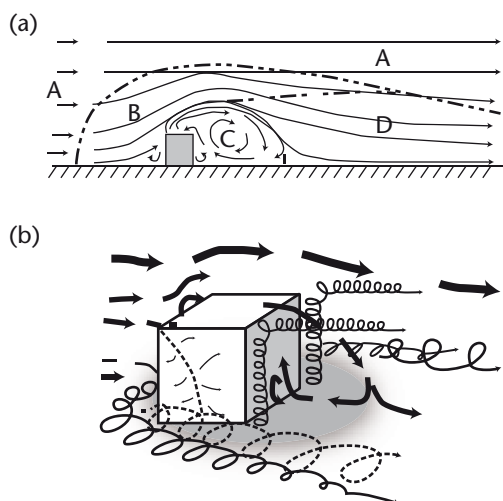

Figure 11.5. Typical two-dimensional flow around a building with flow normal to the upwind face (a): streamlines and flow zones; A represents undisturbed, B represents displacement, C represents cavity, D represents wake (after Halitsky, 1963), and (b): flow, and vortex structures (simplified after Hunt and others, 1978).

mounted at a considerable height. For example, it has been proposed that such sensors should be at a height greater than the maximum horizontal dimension of the major roof (Wieringa, 1996). This implies an expensive mast system, perhaps with guys that subtend a large area and perhaps difficulties in obtaining permission to install. Nevertheless, this is the only acceptable approach if meaningful data are to be measured.

Faced with such realities, sensors should be mounted so that their signal is not overly compromised by their support structure. The following recommendations are made:

- (a) In urban districts with low element height and density (UCZ 6 and 7), it may be possible to use a site where the “open country” standard exposure guidelines can be met. To use the 10 m height, the closest obstacles should be at least 10 times their height distant from the anemometer and not be more than about 6 m tall on average;
- (b) In more densely built-up districts, with relatively uniform element height and density (buildings and trees), wind speed and direction measurements should be taken with the anemometer mounted on a mast of open construction at a minimum height of 1.5 times the mean height of the elements;
- (c) In urban districts with scattered tall buildings the recommendations are as in (b), but with special attention to avoid the wake zone of the tall structures;
- (d) It is not recommended that measurements be taken of wind speed or direction in densely built areas with multiple high-rise structures unless a very tall tower is used.

Anemometers on towers with open construction should be mounted on booms (cross-arms) that are long enough to keep the sensors at least two (preferable three) tower diameters’ distance from the side of the mast (Gill and others, 1967). Sensors should be mounted so that the least frequent flow direction passes through the tower. If this is not possible, or if the tower construction is not very open, two or three booms with duplicate sensors may have to be installed to avoid wake effects and upwind stagnation produced by the tower itself.

If anemometer masts are to be mounted on tall or isolated buildings, the effects of the dimensions of that structure on the flow must be considered (see Part II, Chapter 5, section 5.3.3). This is likely to require analysis using wind tunnel, water flume or computational fluid dynamics models specifically

tailored to the building of interest, and including its surrounding terrain and structures.

The objective is to ensure that all wind measurements are taken at heights where they are representative of the upstream surface roughness at the local scale and are as free as possible of confounding influences from microscale or local scale surface anomalies. Hence the emphasis on gaining accurate measurements at whatever height is necessary to reduce error rather than measuring at a standard height. This may require splitting the wind site from the location of the other measurement systems. It may also result in wind observations at several different heights in the same settlement. That will necessitate extrapolation of the measured values to a common height, if spatial differences are sought or if the data are to form input to a mesoscale model. Such extrapolation is easily achieved by applying the logarithmic profile (equation 11.2) to two heights:

$$\bar{u}_1 / \bar{u}_{ref} = \ln(z_1 / z_0) / \ln(z_{ref} / z_0) \quad (11.4)$$

where z_{ref} is the chosen reference height; z_1 is the height of the site anemometer; and z_0 is the roughness length of the UCZ. In urban terrain it is correct to define the reference height to include the zero-plane displacement height, namely, both z_1 and z_{ref} have the form $(z_x - z_d)$, where the subscript x stands for “1” or “ref”. A suitable reference height could be 50 m above displacement height.

Other exposure corrections for flow distortion, topography and roughness effects can be made as recommended in Part I, Chapter 5 (see 5.9.4: Exposure correction). It may well be that suitable wind observations cannot be arranged for a given urban site. In that case, it is still possible to calculate the wind at the reference height using wind observations at another urban station or the airport using the “logarithmic transformation” model of Wieringa (1986):

$$\bar{u}_{zA} = \bar{u}_{zB} \left[\frac{\ln(z_r / z_{0B}) \cdot \ln(z_A / z_{0A})}{\ln(z_B / z_{0B}) \cdot \ln(z_r / z_{0A})} \right] \quad (11.5)$$

where the subscripts A and B refer to the site of interest where winds are wanted and the site where standard wind measurements are available, respectively. The blending height z_r should either be taken as $4 z_H$ (section 11.1.1.3) or be given a standard value of 60 m; the method is not very sensitive to this term. Again, if either site has dense, tall

roughness elements, the corresponding height scale should incorporate z_d .

11.3.5.3 Wind sensor considerations

Instruments used to measure wind speed and direction, gustiness and other characteristics of the flow in non-urban environments are applicable to urban areas. In cities, wind direction should always be measured, as well as speed, in order to allow azimuth-dependent corrections of tower influence to be made. If mechanical cup anemometers are used, because of the dirtiness of the atmosphere maintenance should be more frequent and close attention should be given to bearings and corrosion. If measurements are taken in the UCL, gustiness may increase the problem of cup over-speeding, and too much shelter may cause anemometers to operate near or below their threshold minimum speed. This must be dealt with through heightened maintenance and perhaps by using fast-response anemometers, propeller-type anemometers or sonic anemometers. Propeller anemometers are less prone to over-speeding, and sonic anemometers, having no moving parts, are practically maintenance-free. However, they are expensive and require sophisticated electronic logging and processing and not all models work when it is raining.

11.3.6 Precipitation

The instruments and methods for the measurement of precipitation given in Part I, Chapter 6 are also relevant to urban areas. The measurement of precipitation as rain or snow is always susceptible to errors associated with the exposure of the gauge, especially in relation to the wind field in its vicinity. Given the urban context and the highly variable wind field in the UCL and the RSL, concerns arise from four main sources as follows:

- (a) The interception of precipitation during its trajectory to the ground by nearby collecting surfaces such as trees and buildings;
- (b) Hard surfaces near the gauge which may cause splash-in into the gauge, and over-hanging objects which may drip precipitation into the gauge;
- (c) The spatial complexity of the wind field around obstacles in the UCL causes very localized concentration or absence of rain- or snow-bearing airflow;
- (d) The gustiness of the wind in combination with the physical presence of the gauge itself causes anomalous turbulence around it which leads to under- or over-catch.

In open country, standard exposure requires that obstacles should be no closer than two times their height. In some ways, this is less restrictive than for temperature, humidity or wind measurements. However, in the UCL the turbulent activity created by flow around sharp-edged buildings is more severe than that around natural obstacles and may last for greater distances in their wake. Again, the highly variable wind speeds and directions encountered on the roof of a building make these sites to be avoided.

On the other hand, unlike temperature, humidity and wind measurements, the object of precipitation measurements is often not for the analysis of local effects, except perhaps in the case of rainfall rate. Some urban effects on precipitation may be initiated at the local scale (for example, by a major industrial facility), but may not show up until well downwind of the city. Distinct patterns within an urban area are more likely to be due to relief or coastal topographic effects.

Selecting an extensive open site in the city, where normal exposure standards can be met, may be acceptable, but it almost certainly will mean that the gauge will not be co-located with the air temperature, humidity and wind sensors. While the latter sensors need to be representative of the local scale urban structure, cover, fabric and metabolism of a specific UCZ, this is not the case for precipitation.

However, the local environment of the gauge is important if the station is to be used to investigate intra-urban patterns of precipitation type. For example, the urban heat island has an influence on the survival of different forms of precipitation, for example, snow or sleet at the cloud base may melt in the warmer urban atmosphere and fall as rain at the ground. This may result in snow at rural and suburban sites when the city centre registers rain.

With regard to precipitation gauges in urban areas, it is recommended that:

- (a) Gauges should be located in open sites within the city where the standard exposure criteria can be met (for example, playing fields, open parkland with a low density of trees, urban airports);
- (b) Gauges should be located in conjunction with wind instruments if a representative exposure for them is found. In other than low density built-up sites, this probably entails mounting the gauge above roof level on a mast. This means that the gauge will be subject to greater than normal wind speed and hence the error of estimation will be greater than near the surface, and the gauge output will have to be corrected. Such correction is feasible if wind is measured on the same mast. It also means that automatic recording is favoured, and the gauge must be checked regularly to ensure that it is level and that the orifice is free of debris;
- (c) Gauges should not be located on the roofs of buildings unless they are exposed at a sufficient height to avoid the wind envelope of the building;
- (d) The measurement of snowfall depth should be taken at an open site or, if made at developed sites, that a large spatial sample should be obtained to account for the inevitable drifting around obstacles. Such sampling should include streets oriented in different directions.

Urban hydrologists are interested in rainfall rates, especially during major storm events. Hence, tipping-bucket rain gauges or weighing gauges have utility. The measurement of rain and snowfall in urban areas stands to benefit from the development of techniques such as optical raingauges and radar.

Dew, ice and fog precipitation also occurs in cities and can be of significance to the water budget, especially for certain surfaces, and may be relevant to applications such as plant diseases, insect activity, road safety and finding a supplementary source of water resources. The methods outlined in Part I, Chapter 6 are appropriate for urban sites.

11.3.7 Radiation

At present, there is a paucity of radiation flux measurements conducted in urban areas. For example, there are almost none in the Global Energy Balance Archive of the World Climate Programme and the Atmospheric Radiation Measurement Program of the US Department of Energy. Radiation measurement sites are often located in rural or remote locations specifically to avoid the aerosol and gaseous pollutants of cities which “contaminate” their records. Even when a station has the name of a city, the metadata usually reveal they are actually located well outside the urban limits. If stations are located in the built-up area, only incoming solar (global) radiation is likely to be measured; neither incoming long-wave radiation nor any fluxes with outgoing components are monitored. For the most part, short-term experimental projects focusing specifically on urban effects measure both the receipt and loss of radiation in cities. All short- and long-wave fluxes are affected by the special properties of the atmosphere and surface of cities, and the same is true for the net all-wave radiation balance that

effectively drives the urban energy balance (Oke, 1988*a*).

All of the instruments, calibrations and corrections, and most of the field methods outlined in relation to the measurement of radiation at open country sites in Part I, Chapter 7, apply to urban areas. Only differences, or specific urban needs or difficulties, are mentioned here.

11.3.7.1 Incoming fluxes

Incoming solar radiation is such a fundamental forcing variable of urban climate that its measurement should be given a high priority when a station is established or upgraded. Knowledge of this term, together with standard observations of air temperature, humidity and wind speed, plus simple measures of the site structure and cover, allows a meteorological pre-processor scheme (namely, methods and algorithms used to convert standard observation fields into the variables required as input by models, but not measured for example, fluxes, stability, mixing height, dispersion coefficients, and so on) such as the Hybrid Plume Dispersion Model (Hanna and Chang, 1992) or the Local-scale Urban Meteorological Parameterization Scheme (Grimmond and Oke, 2002) to be used to calculate much more sophisticated measurements such as atmospheric stability, turbulent statistics, the fluxes of momentum, heat and water vapour. These in turn make it possible to predict the mixing height and pollutant dispersion (COST 710, 1998; COST 715, 2001). Furthermore, solar radiation can be used as a surrogate for daytime cloud activity, and is the basis of applications in solar energy, daylight levels in buildings, pedestrian comfort, legislated rights to solar exposure and many other fields. At automatic stations, the addition of solar radiation measurement is simple and relatively inexpensive.

The exposure requirements for pyranometers and other incoming flux sensors are relatively easily met in cities. The fundamental needs are for the sensor to be level, free of vibration and free of any obstruction above the plane of the sensing element including both fixed features (buildings, masts, trees and hills) and ephemeral ones (clouds generated from exhaust vents or pollutant plumes). Therefore, a high, stable and accessible platform like the roof of a tall building is often ideal. It may be impossible to avoid the short-term obstruction of direct-beam solar radiation impinging on an up-facing radiometer by masts, antennas, flag poles and similar structures. If this occurs, the location of the obstruction and the typical duration of its impact on the sensing element should be fully

documented (see section 11.4). Methods to correct for such interference are mentioned in Part I, Chapter 7. It is also important to ensure that there is no excessive reflection from very light-coloured walls that may extend above the local horizon. It is essential to clean the upper domes at regular intervals. In heavily polluted environments this may mean on a daily basis.

Other incoming radiation fluxes are also desirable but their inclusion depends on the nature of the city, the potential applications and the cost of the sensors. These radiation fluxes (and their instruments) are the following: incoming direct solar beam (pyrheliometer), diffuse sky solar (pyranometer fitted with a shade ring or a shade disc on an equatorial mount), solar ultraviolet (broadband and narrowband sensors, and spectrometers) and long-wave (pyrgeometer). All of these radiation fluxes have useful applications: beam (pollution extinction coefficients), diffuse (interior daylighting, solar panels), ultraviolet (depletion by ozone and damage to humans, plants and materials) and long-wave (monitoring nocturnal cloud and enhancement of the flux by pollutants and the heat island effect).

11.3.7.2 Outgoing and net fluxes

The reflection of solar radiation and the emission and reflection of long-wave radiation from the underlying surface, and the net result of short-, long- and all-wave radiant fluxes, are currently seldom monitored at urban stations. This means that significant properties of the urban climate system remain unexplored. The albedo, which decides if solar radiation is absorbed by the fabric or is lost back to the atmosphere and space, will remain unknown. The opportunity to invert the Stefan-Boltzmann relation and solve for the surface radiant temperature is lost. The critical net radiation that supports warming/cooling of the fabric, and the exchanges of water and heat between the surface and the urban boundary layer, is missing. Of these, net all-wave radiation data lack the most. Results from a well-maintained net radiometer are invaluable to drive a pre-processor scheme and as a surrogate measurement of cloud.

The main difficulty in measuring outgoing radiation terms accurately is the exposure of the down-facing radiometer to view a representative area of the underlying urban surface. The radiative source area (equation 11.1 and Figure 11.2) should ideally “see” a representative sample of the main surfaces contributing to the flux. In the standard exposure cases, defined in the relevant sections of Part I, Chapter 7, a sensor height of 2

m is deemed appropriate over a short grass surface. At that height, 90 per cent of the flux originates from a circle with a diameter of 12 m on the surface. Clearly, a much greater height is necessary over an urban area in order to sample an area that contains a sufficient population of surface facets to be representative of that UCZ. Considering the case of a radiometer at a height of 20 m (at the top of a 10 m high mast mounted on a 10 m high building) in a densely developed district, the 90 per cent source area has a diameter of 120 m at ground level. This might seem sufficient to “see” several buildings and roads, but it must also be considered that the system is three-dimensional, not quasi-flat like grass. At the level of the roofs in the example, the source area is now only 60 m in diameter, and relatively few buildings may be viewed.

The question becomes whether the sensor can “see” an appropriate mix of climatically active surfaces. This means that the sensor must not only see an adequate set of plan-view surface types, but also sample appropriate fractions of roof, wall and ground surfaces, including the correct fractions of each that are in the sun or shade. This is a non-trivial task that depends on the surface structure and the positions of both the sensor and the sun in space above the array. Soux, Voogt and Oke, 2004, developed a model to calculate these fractions for relatively simple urban-like geometric arrays. However, more work is needed before guidelines specific to individual UCZ types are available. It seems likely that the sensor height has to be *greater* than that for turbulence measurements. The non-linear nature of radiative source area effects is clear from equation 11.1 (see Figure 11.2). The greater weighting of surfaces closer to the mast location means that the immediate surroundings are most significant. In the previous example of the radiometer at a height of 20 m on a 10 m high building, 50 per cent of the signal at the roof-level comes from a circle of only 20 m in diameter (perhaps only a single building). If the roof of that building, or any other surface on which the mast is mounted, has anomalous radioactive properties (albedo, emissivity or temperature), it disproportionately affects the flux, which is supposed to be representative of a larger area. Hence, roofs with large areas of glass or metal, or with an unusually dark or light colour, or those designed to hold standing water, should be avoided.

The problems associated with down-facing radiometers at large heights include: (a) the difficulty of ensuring that the plane of the sensing element is

level; (b) ensuring that at large zenith angles the sensing element does not “see” direct beam solar radiation or incoming long-wave radiation from the sky; (c) considering whether there is need to correct results to account for radiative flux divergence in the air layer between the instrument height and the surface of interest. To eliminate extraneous solar or long-wave radiation near the horizon, it may be necessary to install a narrow collar that restricts the field of view to a few degrees less than 2π . This will necessitate a small correction applied to readings to account for the missing diffuse solar input (see Part I, Chapter 7, Annex 7.E for the case of a shading ring) or the extra long-wave input from the collar.

Inverted sensors may be subject to error because their back is exposed to solar heating. This should be avoided by using some form of shielding and insulation. Maintaining the cleanliness of the instrument domes and wiping away deposits of water or ice may also be more difficult. The inability to observe the rate and effectiveness of instrument ventilation at a certain height means that instruments that do not need aspiration should be preferred. The ability to lower the mast to attend to cleaning, the replacement of desiccant or polyethylene domes and levelling is an advantage.

It is recommended that:

- (a) Down-facing radiometers be placed at a height at least equal to that of a turbulence sensor (namely, a minimum of $2z_H$ is advisable) and preferably higher;
- (b) The radiative properties of the immediate surroundings of the radiation mast should be representative of the urban district of interest.

11.3.8 Sunshine duration

The polluted atmospheres of urban areas cause a reduction in sunshine hours compared with their surroundings or pre-urban values (Landsberg, 1981). The instruments, methods and exposure recommendations given in Part I, Chapter 8 are applicable to an urban station.

11.3.9 Visibility and meteorological optical range

The effects of urban areas upon visibility and meteorological optical range (MOR) are complex because, while pollutants tend to reduce visibility and MOR through their impact on the attenuation of light and the enhancement of certain types of fog, urban heat and humidity island effects often act to diminish the frequency and severity of fog and low cloud. There is considerable practical value in having

urban visibility and MOR information for fields such as aviation, road and river transportation and optical communications, and thus to include these observations at urban stations.

The visual perception of visibility is hampered in cities. While there are many objects and lights that can serve as range targets, it may be difficult to obtain a sufficiently uninterrupted line of sight at the recommended height of 1.5 m. The use of a raised platform or the upper level of buildings is considered non-standard and is not recommended. Observations near roof level may also be affected by scintillation from heated roofs, or the "steaming" of water from wet roofs during drying, or pollutants and water clouds released from chimneys and other vents.

Instruments to measure MOR, such as transmissometers and scatter meters, generally work well in urban areas. They require relatively short paths and will give good results if the optics are maintained in a clean state. Naturally, the instrument must be exposed at a location that is representative of the atmosphere in the vicinity, but the requirements are no more stringent than for other instruments placed in the UCL. It may be that, for certain applications, knowledge of the height variation of MOR is valuable, for example, the position of the fog top or the cloud base.

11.3.10 Evaporation and other fluxes

Urban development usually leads to a reduction in evaporation primarily due to the fact that built features seal the surface and that vegetation has been removed. Nonetheless, in some naturally dry regions, an increase may occur if water is imported from elsewhere and used to irrigate urban vegetation.

Very few evaporation measurement stations exist in urban areas. This is understandable because it is almost impossible to interpret evaporation measurements conducted in the UCL using atmometers, evaporation pans or lysimeters. As detailed in Part I, Chapter 10, such measurements must be at a site that is representative of the area; not closer to obstacles than 5 times their height, or 10 times if they are clustered; not placed on concrete or asphalt; not unduly shaded; and free of hard surfaces that may cause splash-in. In addition to these concerns, the surfaces of the instruments are assumed to act as surrogates for vegetation or open water systems. Such surfaces are probably not representative of the surroundings at an urban site. Hence, they are in receipt of micro-advection

that is likely to force evaporation at unrealistically high rates.

Consider the case of an evaporation pan installed over a long period which starts out at a semi-arid site that converts to irrigated agricultural uses and is then encroached upon by suburban development and is later in the core of a heavily developed urban area. Its record of evaporation starts out very high, because it is an open water surface in hot, dry surroundings. Therefore, although actual evaporation in the area is very low, advection forces the loss from the pan to be large. Because the introduction of irrigation makes conditions cooler and more humid, the pan readings drop, but actual evaporation is large. Inasmuch as urban development largely reverses the environmental changes and reduces the wind speed near the ground, pan losses increase but the actual evaporation probably drops. Hence, throughout this sequence pan evaporation and actual evaporation are probably in anti-phase. During the agricultural period a pan coefficient might have been applied to convert the pan readings to those typical of short grass or crops. No such coefficients are available to convert pan to urban evaporation, even if the readings are not corrupted by the complexity of the UCL environment. In summary, the use of standard evaporation instruments in the UCL is not recommended.

The dimensions and heterogeneity of urban areas renders the use of full-scale lysimeters impractical (for example, the requirement to be not less than 100 to 150 m from a change in surroundings). Micro-lysimeters can give the evaporation from individual surfaces, but they are still specific to their surroundings. Such lysimeters need careful attention, including soil monolith renewal to prevent drying out, and are not suitable for routine long-term observations.

Spatially averaged evaporation and other turbulent fluxes (momentum, sensible heat, carbon dioxide) information can be obtained from observations above the RSL. Several of these fluxes are of greater practical interest in urban areas than in many open country areas. For example, the vertical flux of horizontal momentum and the integral wind statistics and spectra are needed to determine wind loading on structures and the dispersion of air pollutants. The sensible heat flux is an essential input to calculate atmospheric stability (for example, the flux Richardson number and the Obukhov length) and the depth of the urban mixing layer. Fast response eddy covariance or standard deviation methods are recommended, rather than

profile gradient methods. Appropriate instruments include sonic anemometers, infrared hygrometers and gas analysers and scintillometers. The sensors should be exposed in the same manner as wind sensors: above the RSL but below the internal boundary layer of the UCZ of interest. Again, such measurements rely on the flux “footprint” being large enough to be representative of the local area of interest.

If such flux measurements are beyond the financial and technical resources available, a meteorological pre-processor scheme such as the Ozone Limiting Method, the Hybrid Plume Dispersion Method or the Local-scale Urban Meteorological Parameterization Scheme (see section 11.3.7) can be an acceptable method to obtain aeri-ally representative values of urban evaporation and heat flux. Such schemes require only spatially representative observations of incoming solar radiation, air temperature, humidity and wind speed and general estimates of average surface properties such as albedo, emissivity, roughness length and the fractions of the urban district that are vegetated or built-up or irrigated. Clearly, the wind speed observations must conform to the recommendations in section 11.3.5. Ideally air temperature and humidity should also be observed above the RSL; however, if only UCL values are available, this is usually acceptable because such schemes are not very sensitive to these variables.

11.3.11 Soil moisture

Knowledge of urban soil moisture can be useful, for example, to gardeners and in the calculation of evaporation. Its thermal significance in urban landscapes is demonstrated by the remarkably distinct patterns in remotely sensed thermal imagery. By day, any patch with active vegetation or irrigated land is noticeably cooler than land that is built on, paved or bare. However, the task of sampling to obtain representative values of soil moisture is daunting.

Some of the challenges presented include the fact that large fractions of urban surfaces are completely sealed over by paved and built features; much of the exposed soil has been highly disturbed in the past during construction activity or following abandonment after urban use; the “soil” may actually be largely formed from the rubble of old buildings and paving materials or have been imported as soil or fill material from distant sites; or the soil moisture may be affected by seepage from localized sources such as broken water pipes or sewers or be the result

of irrigation. All of these elements lead to a very patchy urban soil moisture field that may have totally dry plots situated immediately adjacent to over-watered lawns. Hence, while some idea of local-scale soil moisture may be possible in areas with very low urban development, or where the semi-natural landscape has been preserved, it is almost impossible to characterize in most urban districts. Again, in this case it may be better to use rural values that give a regional background value rather than to have no estimate of soil moisture availability.

11.3.12 Present weather

If human observers or the usual instrumentation are available, the observation of present weather events and phenomena such as rime, surface ice, fog, dust and sand storms, funnel clouds and thunder and lightning can be valuable, especially those with practical implications for the efficiency or safety of urban activities, for example transportation. If archiving facilities are available, the images provided by webcams can provide very helpful evidence of clouds, short-term changes in cloud associated with fronts, fog banks that ebb and flow, low cloud that rises and falls, and the arrival of dust and sand storm fronts.

11.3.13 Cloud

Although cloud cover observation is rare in large urban areas, this information is very useful. All of the methods and instruments outlined in Part I, Chapter 15 are applicable to urban areas. The large number and intensity of light sources in cities, combined with a hazy, sometimes polluted, atmosphere, make visual observation more difficult. Where possible, the observational site should avoid areas with particularly bright lighting.

11.3.14 Atmospheric composition

The monitoring of atmospheric pollution in the urban environment is increasingly important. However, this is another specialist discipline and will not be dealt with in this chapter. Part I, Chapter 17 deals with the subject in the broader context of the Global Atmosphere Watch.

11.3.15 Profiling techniques for the urban boundary layer

Because urban influences extend throughout the planetary boundary layer (Figure 11.1), it is necessary to use towers and masts to obtain observations

above the RSL to probe higher. Of special interest are effects on the wind field and the vertical temperature structure including the depth of the mixing layer and their combined role in affecting pollutant dispersion.

All of the special profiling techniques outlined in Part II, Chapter 5 are relevant to urban areas. Acoustic sounders (sodars) are potentially very useful; nonetheless, it must be recognized that they suffer from two disadvantages: first, their signals are often interfered with by various urban sources of noise (traffic, aircraft, construction activity, and even lawnmowers); and second, they may not be allowed to operate if they cause annoyance to residents. Wind profiler radars, radio-acoustic sounding systems, microwave radiometers, microwave temperature profilers, laser radars (lidars) and modified ceilometers are all suitable systems to monitor the urban atmosphere if interference from ground clutter can be avoided. Similarly, balloons for wind tracking, boundary layer radiosondes (minisondes) and instrumented tethered balloons can all be used with good success rates as long as air traffic authorities grant permission for their use. Instrumented towers and masts can provide an excellent means of placing sensors above roof level and into the inertial sublayer, and very tall structures may permit measurements into the mixing layer above. However, it is necessary to emphasize the precautions given in Part II, Chapter 5, section 5.3.3 regarding the potential interference with atmospheric properties by the support structure. Although tall buildings may appear to provide a way to reach higher into the urban boundary layer, unless obstacle interference effects are fully assessed and measures instituted to avoid them, the deployment of sensors can be unfruitful and probably misleading.

11.3.16 **Satellite observations**

Remote sensing by satellite with adequate resolution in the infrared may be relevant to extended urban areas; however, a description of this is outside the scope of this chapter. Some information is available in Part II, Chapter 8, and a review is given in Voogt and Oke, 2003.

11.4 **METADATA**

The full and accurate documentation of station metadata (see Part I, Chapter 1) is absolutely essential for any station “to ensure that the final data user has no doubt about the conditions in which

data have been recorded, gathered and transmitted, in order to extract accurate conclusions from their analysis” (WMO, 2003*a*). It can be argued that this is even more critical for an urban station, because urban sites possess both an unusually high degree of complexity and a greater propensity to change. The complexity makes every site truly unique, whereas good open country sites conform to a relatively standard template. Change means that site controls are dynamic, meaning that documentation must be updated frequently. In Figure 11.6 it is assumed that the minimum requirements for station metadata set by WMO (2003*a*) are all met and that hopefully some or all of the best practices they recommend are implemented. Here, emphasis is placed on special urban characteristics that need to be included in the metadata, in particular under the categories of “local environment” and “historical events”.

11.4.1 **Local environment**

As explained in section 11.1.1, urban stations involve the exposure of instruments both within and above the urban canopy. Hence, the description of the surroundings must include both the microscale and the local scale. Following WMO (2003*a*), with adaptations to characterize the urban environment, it is recommended that the following descriptive information be recorded for the station:

- (a) A map at the local scale to mesoscale (~1:50 000) as in Figure 11.6(a), updated as necessary to describe large-scale urban development changes (for example, conversion of open land to housing, construction of a shopping centre or airport, construction of new tall buildings, cutting of a forest patch, drainage of a lake, creation of a detention pond). Ideally, an aerial photograph of the area should also be provided and a simple sketch map (at 1:500 000 or 1:1 000 000) to indicate the location of the station relative to the rest of the urbanized region (Figures 11.6(b) and (c)) and any major geographic features such as large water bodies, mountains and valleys or change in ecosystem type (desert, swamp, forest). An aerial oblique photograph can be especially illuminating because the height of buildings and trees can also be appreciated. If available, aerial or satellite infrared imagery may be instructive regarding important controls on microclimate. For example, relatively cool surfaces by day usually indicate the availability of moisture or materials with anomalous surface emissivity. Hotter than normal

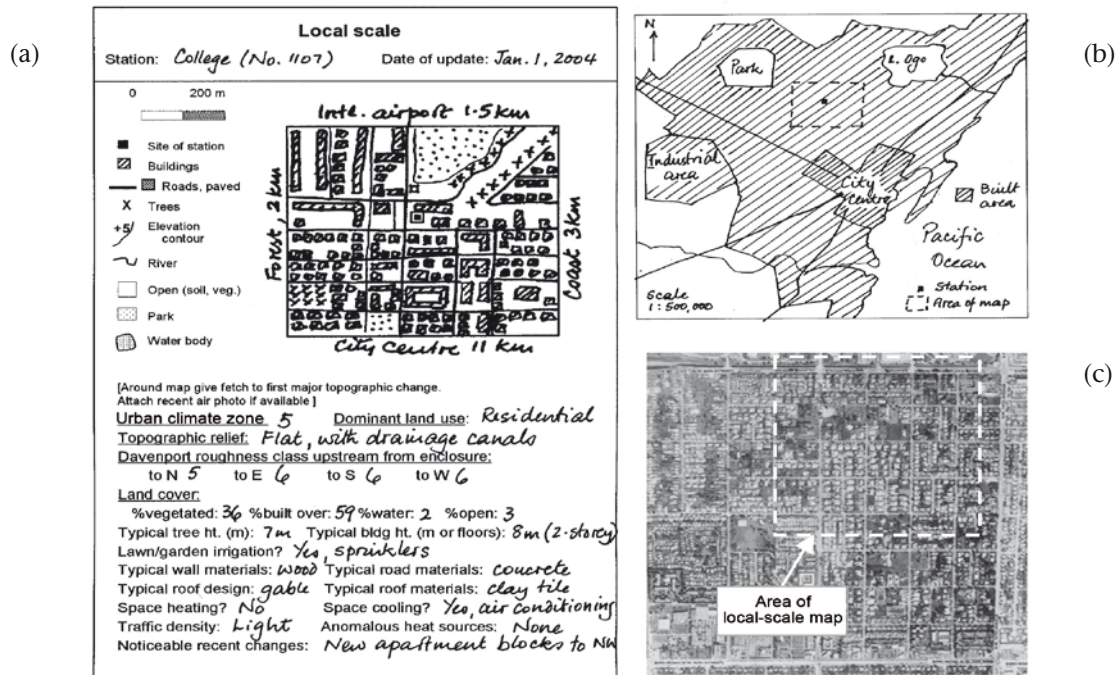

Figure 11.6. Minimum information necessary to describe the local-scale environment of an urban station, consisting of (a) a template to document the local setting; (b) a sketch map to situate the station in the larger urban region; and (c) an aerial photograph.

- areas may be very dry, or have a low albedo or very good insulation. At night, relative coolness indicates good insulation, and relative warmth the opposite, or it could be a material with high thermal admittance that is releasing stored daytime heat or there could be an anomalous source of anthropogenic heat. UCZ and Davenport roughness classes can be judged using Tables 11.1 or 11.2;
- (b) A microscale sketch map (~1:5 000), according to metadata guidelines, updated each year (Figure 11.7(a));
- (c) Horizon mapping using a clinometer and compass survey in a circle around the screen (as shown in the diagram at the base of the template, Figure 11.7(a), and a fisheye lens photograph taken looking vertically at the zenith with the camera's back placed on the ground near the screen, but not such that any of the sky is blocked by it (Figure 11.7(b)). If a fisheye lens is not available, a simpler approach is to take a photograph of a hemispheric reflector (Figure 11.7(c)). This should be updated every year or more frequently if there are marked changes in horizon obstruction, such as the construction or demolition of a new building nearby, or the removal of trees;
- (d) Photographs taken from cardinal directions of the instrument enclosure and of other instrument locations and towers;
- (e) A microscale sketch of the instrument enclosure, updated when instruments are relocated or other significant changes occur;
- (f) If some of the station's measurements (wind, radiation) are made away from the enclosure (on masts, roof-tops, more open locations) repeat steps (b) to (d) above for each site.

11.4.2 Historical events

Urban districts are subject to many forces of change, including new municipal legislation that may change the types of land uses allowed in the area, or the height of buildings, or acceptable materials and construction techniques, or environmental, irrigation or traffic laws and regulations. Quite drastic alterations to an area may result from central planning initiatives for urban renewal. More organic alterations to the nature of a district also arise because of in- or out-migrations of groups of people, or when an area comes into, or goes out of, favour or style as a place to live or work. The urban area may be a centre of conflict and destruction. Such events should be documented so that later users of the data understand some of the

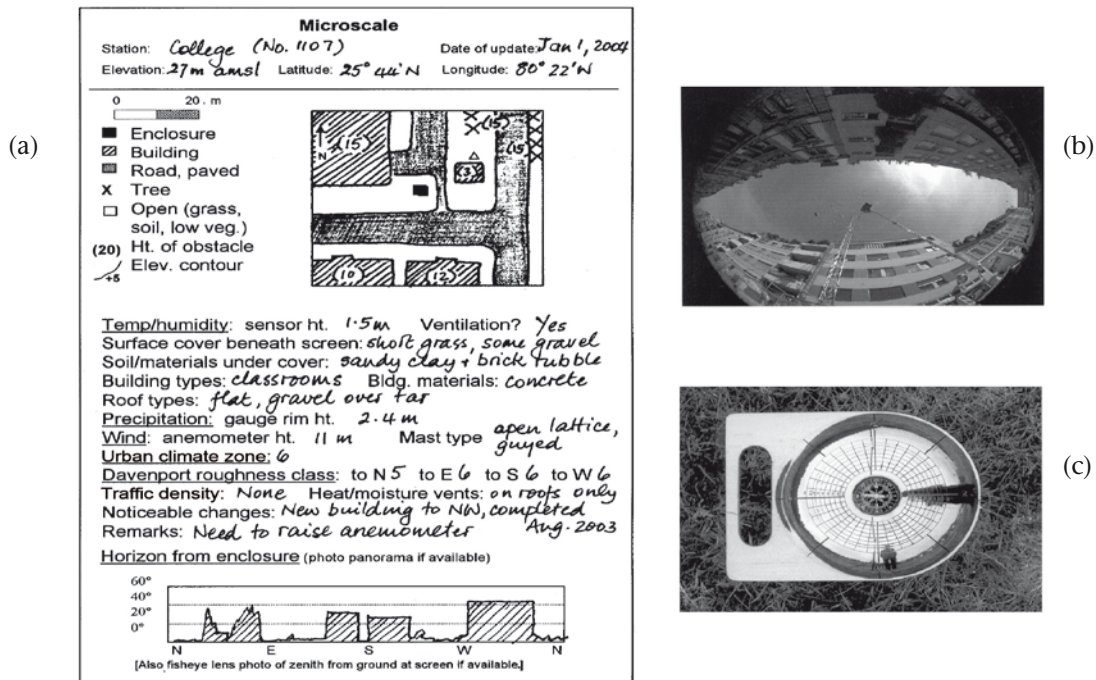

Figure 11.7. Information required to describe the microscale surroundings of an urban climate station; (a) a template for a metadata file; (b) an example of a fisheye lens photograph of a street canyon illustrating horizon obstruction; and (c) a UK Met Office hemispheric reflector placed on a rain gauge.

context of changes that might appear in the urban climate.

11.4.3 **Observance of other WMO recommendations**

All other WMO recommendations regarding the documentation of metadata, including station identifiers, geographical data, instrument exposure, types of instruments, instrument mounting and sheltering, data recording and transmission, observing practices, metadata storage and access and data processing should be observed at urban stations.

11.5 **ASSESSMENT OF URBAN EFFECTS**

The study of urban weather and climate possesses a perspective that is almost unique. People are curious about the role of humans in modifying the urban atmosphere. Therefore, unlike other environments of interest, where it is sufficient to study the atmosphere for its own sake or value, in urban areas there is interest in knowing about urban effects. This means assessing possible changes to meteorological variables as an urban area develops over time, compared to what would have happened had the settlement not been built.

This question that is essentially unanswerable when a settlement has been built, and, even if the settlement had not been built, the landscape may well have evolved into a different state compared with the pre-existing one (for example, owing to other human activity such as agriculture or forestry). The assessment of urban effects is therefore fraught with methodological difficulties and no “truth” is possible, only surrogate approximations. If an urban station is being established alone, or as part of a network, to assess urban effects on weather and climate, it is recommended that careful consideration be given to the analysis given in Lowry (1977), and Lowry and Lowry (2001).

11.6 **SUMMARY OF KEY POINTS FOR URBAN STATIONS**

11.6.1 **Working principles**

When establishing an urban station, the rigid guidelines for climate stations are often inappropriate. It is necessary to apply guiding principles rather than rules, and to retain a flexible approach. This often means different solutions for individual atmospheric properties and may mean that not all observations at a “site” are made at the same place.

Because the environment of urban stations changes often as development proceeds, frequently updated metadata are as important as the meteorological data gathered. Without good station descriptions it is impossible to link measurements to the surrounding terrain.

11.6.2 **Site selection**

An essential first step in selecting urban station sites is to evaluate the physical nature of the urban terrain, using a climate zone classification. This will reveal areas of homogeneity.

Several urban terrain types make up an urban area. In order to build a picture of the climate of a settlement, multiple stations are required. Sites should be selected that are likely to sample air drawn across relatively homogenous urban terrain and are thus representative of a single climate zone. Care must be taken to ensure that microclimatic effects do not interfere with the objective of measuring the local-scale climate.

11.6.3 **Measurements**

With regard to measurements, the following key points should be taken into account:

- (a) Air temperature and humidity measurements taken within the UCL can be locally representative if the site is carefully selected. If these variables are observed above roof level, including above the RSL, there is no established link between them and those within the UCL;
 - (b) Wind and turbulent flux measurements should be taken above the RSL but within the internal boundary layer of the selected UCZ. Such measurements must establish that the surface “footprint” contributing to the observations is representative of the climate zone. For wind, it is possible to link the flow at this level and that experienced within the canopy;
 - (c) Precipitation observations can be conducted either near the ground at an unobstructed site, or above the RSL, corrected according to parallel wind measurements;
 - (d) With the exception of incoming solar radiation measurements, roof-top sites are to be avoided, unless instruments are exposed on a tall mast;
 - (e) Measurements of the net and upwelling radiation fluxes must be taken at heights that make it possible to sample adequately the range of surface types and orientations typical of the terrain zone.
-

REFERENCES AND FURTHER READING

- Arya, P.S., 2001: *Introduction to Micrometeorology*. Academic Press, New York.
- Auer, A.H. Jr., 1978: Correlation of land use and cover with meteorological anomalies. *Journal of Applied Meteorology*, Volume 17, Issue 5 pp. 636–643.
- Britter, R.E. and S.R. Hanna, 2003: Flow and dispersion in urban areas. *Annual Review of Fluid Mechanics*, Volume 35, pp. 469–496.
- Christen, A., 2003: (personal communication). Institute of Meteorology, Climatology and Remote Sensing, University of Basel.
- Christen, A., R. Vogt, M.W. Rotach and E. Parlow, 2002: *First results from BUBBLE I: Profiles of fluxes in the urban roughness sublayer*. *Proceedings of the Fourth Symposium on Urban Environment*, (Norfolk, Virginia), American Meteorological Society, Boston, pp. 105–106.
- COST-710, 1998: *Final Report: Harmonisation of the Pre-processing of Meteorological Data for Atmospheric Dispersion Models*. European Commission. EUR 18195 EN.
- COST-715, 2001: *Preparation of Meteorological Input Data for Urban Site Studies*. European Commission, EUR 19446 EN.
- Davenport, A.G., C.S.B. Grimmond, T.R. Oke and J. Wieringa, 2000: *Estimating the roughness of cities and sheltered country*. *Proceedings of the Twelfth Conference on Applied Climatology* (Asheville, North Carolina), American Meteorological Society, Boston, pp. 96–99.
- DePaul, F.T. and C.M. Shieh, 1986: Measurements of wind velocity in a street canyon. *Atmospheric Environment*, Volume 20, pp. 455–459.
- Ellefsen, R., 1991: Mapping and measuring buildings in the canopy boundary layer in ten US cities. *Energy and Buildings*, Volume 16, pp. 1025–1049.
- Garratt, J.R., 1992: *The Atmospheric Boundary Layer*. Cambridge University Press, Cambridge.
- Gill, G.C., L.E. Olsson, J. Sela and M. Suda, 1967: Accuracy of wind measurements on towers or stacks. *Bulletin of the American Meteorological Society*, Volume 48, pp. 665–674.
- Grimmond, C.S.B. and T.R. Oke, 1999: Aerodynamic properties of urban areas derived from analysis of surface form. *Journal of Applied Meteorology*, Volume 38, Issue 9, pp. 1262–1292.
- Grimmond, C.S.B. and T.R. Oke, 2002: Turbulent heat fluxes in urban areas: Observations and a local-scale urban meteorological parameterization scheme (LUMPS). *Journal of Applied Meteorology*, Volume 41, Issue 7, pp. 792–810.
- Halitsky, J., 1963: Gas diffusion near buildings. *Transactions of the American Society of Heating, Refrigerating and Air-conditioning Engineers*, Volume 69, pp. 464–485.
- Hanna, S.R. and J. C. Chang, 1992: Boundary-layer parameterizations for applied dispersion modeling over urban areas. *Boundary-Layer Meteorology*, Volume 58, pp. 229–259.
- Hunt, J.C.R., C.J. Abell, J.A. Peterka and H.Woo, 1978: Kinematical studies of the flow around free or surface-mounted obstacles: Applying topology to flow visualization. *Journal of Fluid Mechanics*, Volume, 86, pp. 179–200.
- Kljun, N., M. Rotach, and H.P. Schmid, 2002: A three-dimensional backward Lagrangian footprint model for a wide range of boundary-layer stratifications. *Boundary-Layer Meteorology*, Volume 103, Issue 2, pp. 205–226.
- Kljun, N., P. Calanca, M.W. Rotach, H.P. Schmid, 2004: A simple parameterization for flux footprint predictions. *Boundary-Layer Meteorology*, Volume 112, pp. 503–523.
- Landsberg, H.E., 1981: *The Urban Climate*. Academic Press, New York.
- Lowry, W.P., 1977: Empirical estimation of urban effects on climate: A problem analysis. *Journal of Applied Meteorology*, Volume 16, Issue 2, pp. 129–135.
- Lowry, W.P. and P.P. Lowry, 2001: *Fundamentals of Biometeorology: Volume 2 – The Biological Environment*. Chapter 17, Peavine Publications, St Louis, Missouri, pp. 496–575.
- Nakamura, Y. and T.R. Oke, 1988: Wind, temperature and stability conditions in an east-west oriented urban canyon. *Atmospheric Environment*, 22, pp. 2691–2700.
- Oke, T.R. 1981: Canyon geometry and the nocturnal heat island: Comparison of scale model and field observations. *Journal of Climatology*, Volume 1, Issue 3, pp. 237–254.
- Oke, T.R., 1982: The energetic basis of the urban heat island. *Quarterly Journal of the Royal Meteorological Society*, Volume 108, Issue 455, pp. 1–24.
- Oke, T.R., 1984: Methods in urban climatology. In: *Applied Climatology* (W. Kirchofer, A. Ohmura and W. Wanner, eds). Zürcher Geographische Schriften, Volume 14, pp. 19–29.
- Oke, T.R., 1988a: The urban energy balance. *Progress in Physical Geography*, Volume 12, pp. 471–508.

- Oke, T.R., 1988b: Street design and urban canopy layer climate. *Energy and Buildings*, Volume 11, pp. 103–113.
- Oke, T.R., 1997: Urban environments. In: *The Surface Climates of Canada* (W.G. Bailey, T.R. Oke and W.R. Rouse, eds). McGill-Queen's University Press, Montreal, pp. 303–327.
- Peterson, T.C., 2003: Assessment of urban versus rural in situ surface temperatures in the contiguous United States: No difference found. *Journal of Climate*, Volume 16, pp. 2941–2959.
- Rotach, M.W., 1999: On the influence of the urban roughness sublayer on turbulence and dispersion. *Atmospheric Environment*, Volume 33, pp. 4001–4008.
- Schmid, H.P., 2002: Footprint modeling for vegetation atmosphere exchange studies: A review and perspective. *Agricultural and Forest Meteorology*, Volume 113, Number 1, pp. 159–183.
- Schmid, H.P., H.A. Cleugh, C.S.B. Grimmond and T.R. Oke, 1991: Spatial variability of energy fluxes in suburban terrain. *Boundary-Layer Meteorology*, Volume 54, Issue 3, pp. 249–276.
- Soux A., J.A. Voogt and T.R. Oke, 2004: A model to calculate what a remote sensor 'sees' of an urban surface. *Boundary-Layer Meteorology*, Volume 111, pp. 109–132.
- Stull, R.B., 1988: *An Introduction to Boundary Layer Meteorology*. Kluwer Academic Publishers, Dordrecht.
- Verkaik, J.W., 2000: Evaluation of two gustiness models for exposure correction calculations. *Journal of Applied Meteorology*, Volume 39, Issue 9, pp. 1613–1626.
- Voogt, J.A. and T.R. Oke, 2003: Thermal remote sensing of urban climates. *Remote Sensing of Environment*, Volume 86, Number 3, pp. 370–384.
- Wieringa, J., 1986: Roughness-dependent geographical interpolation of surface wind speed averages. *Quarterly Journal of the Royal Meteorological Society*, Volume 112, Issue 473, pp. 867–889.
- Wieringa, J., 1993: Representative roughness parameters for homogeneous terrain. *Boundary-Layer Meteorology*, Volume 63, Number 4, pp. 323–363.
- Wieringa, J., 1996: Does representative wind information exist? *Journal of Wind Engineering and Industrial Aerodynamics*, Volume 65, Number 1, pp. 1–12.
- World Meteorological Organization, 1983: *Guide to Climatological Practices*. Second edition, WMO-No. 100, Geneva.
- World Meteorological Organization, 1988: *Technical Regulations*. Volume I, WMO-No. 49, Geneva.
- World Meteorological Organization, 1995: *Manual on Codes*. WMO-No. 306, Geneva.
- World Meteorological Organization, 2003a: *Guidelines on Climate Metadata and Homogenization* (E. Aguilar, I. Auer, M. Brunet, T.C. Peterson and J. Wieringa). World Climate Data and Monitoring Programme No. 53, WMO/TD-No. 1186, Geneva.
- World Meteorological Organization, 2003b: *Manual on the Global Observing System*. WMO-No. 544, Geneva.
- World Meteorological Organization, 2006: *Initial Guidance to Obtain Representative Meteorological Observations at Urban Sites* (T.R. Oke). Instruments and Observing Methods Report No. 81, WMO/TD-No. 1250, Geneva.
-

CHAPTER 12

ROAD METEOROLOGICAL MEASUREMENTS

12.1 GENERAL

12.1.1 Definition

Road meteorological measurements are of particular value in countries where the serviceability of the transport infrastructure in winter exerts a great influence on the national economy. In some countries there will be other road hazards such as dust storms or volcanic eruptions. Safe and efficient road transport is adversely affected by the following conditions which affect speed, following distance, tyre adhesion and braking efficiency: poor visibility (heavy precipitation, fog, smoke, sand storm), high winds, surface flooding, land subsidence, snow, freezing precipitation and ice.

12.1.2 Purpose

The role of a road network manager is to ensure the optimal, safe, free flow of traffic on arterial routes. Operational decisions on the issuing of road weather information and on initiating de-icing and snow clearing operations are dependent on road meteorological observations that are increasingly made by special-purpose automatic weather stations (AWSs). While these stations should conform as far as practicable to the sensor exposure and measurement standards of conventional AWSs (see Part II, Chapter 1) they will have characteristics specific to their function, location and measurement requirements.

The reliability of road meteorological measurement stations which supply data to a transport decision support system is critical: Each station will relate to the immediate environment of important high-density transport routes and may be responsible for feeding data to road meteorology forecast routines and for generating automatic alarms. Thus, equipment reliability and maintenance, power supply, communications continuity and data integrity are all important elements in the selection, implementation and management of the weather measurement network. These concerns point to the benefits of an effective collaboration between road management services and the National Meteorological and Hydrological Service (NMHS).

12.1.3 Road meteorological requirements

This chapter should assist in standardizing road meteorological measurements with a method that adheres to WMO common standards as closely as possible. However, those users who may wish to employ road measurements in other meteorological applications will be advised of important deviations, in sensor exposure, for example.

The needs of road network managers focus in four main areas (WMO 1997; 2003a):

- (a) *Real-time observation of road meteorology:* The practical objective, on the one hand, is to inform road users of the risks (forecast or real-time) that they are likely to face on designated routes; and on the other hand, to launch a series of actions aimed at increasing road safety, such as scraping snow or spreading chemical melting agents;
- (b) *Improvement of pavement surface temperature forecasting:* The measurements of road AWSs are the important input data for the temperature and pavement condition forecasting programmes which may be run by the NMHS. This authority has the capability of ensuring continuity and timeliness in the observations and in the forecast service. In practice, two tools are available to forecasters. The first tool is a computer model for the transposition of a weather forecast of atmospheric conditions to a pavement surface temperature forecast, taking account of the physical characteristics of each station. The second tool is the application of an algorithm based on a specific climatological study of the pavement surface;
- (c) *Road climate database:* The establishment of a road climatological database is important because in many situations an assessment of current events at a well-instrumented location enables experienced road network managers to transpose the data using the climate model to other locations they know well. In some cases, thermal fingerprints can be taken in order to model this spatial relationship. The recording of road weather data will be useful for analysing previous winter disturbances and for carrying out specific road-dedicated climatology studies. National Meteorological

and Hydrological Services can fill the data gaps and compare and provide quality assurance for measurements coming from different sources;

- (d) *Reliable data*: Road managers do not need exceedingly accurate measurements (with the exception of road-surface temperature). Rather, they want the data to be as reliable as possible. That is to say the data must be a consistent reflection of the real situation, and the measuring devices must be robust. Communication and power supply continuity are often of prime importance.

12.2 ESTABLISHMENT OF A ROAD METEOROLOGICAL STATION

12.2.1 Standardized representative measurements

The general requirements for meteorological stations, their siting and the type and frequency of measurements are defined in WMO (1988; 2003a). It is recommended that these standards and other relevant material in this Guide should be adhered to closely when establishing road meteorological stations in order to make standardized, representative measurements that can be related to those from other road stations in the network and also to data from standard synoptic or climatological stations, except where the unique measurements for road meteorology demand other standards, for example, for the exposure of sensors. Advice on the optimum placement and density of stations may be obtained from the local branch office of the NHMS which will be able to access climatological data for the region.

A meteorological station site is chosen so that it will properly represent a particular geographic region. A road meteorological station will be sited to best represent part of the road network or a particular stretch of important roadway that is known to suffer from weather-related or other hazards. The station must therefore be adjacent to the roadway so that road-surface sensors may be installed, and therefore some compromise on “ideal” meteorological siting and exposure may occur. The sensors are installed so that their exposure enables the best representation in space and time of the variable being measured, without undue interference from secondary influences. In general, the immediate site adjacent to the roadway should be level, with short grass, and not shaded by buildings or trees.

12.2.2 Station metadata

In every case it is important that the location and characteristics of the site and the specification of equipment and sensors are fully documented, including site plans and photographs. These metadata (Part I, Chapter 1 and Part III, Chapter 1) are invaluable for the management of the station and for comparing the quality of the measurements with those from other sites.

12.3 OBSERVED VARIABLES

12.3.1 Road meteorological measurements

The important measurements at road weather stations for forecasting roadway conditions include air temperature and humidity, wind speed and direction, precipitation amount and type, visibility, global and long-wave radiation, road-surface temperature and road-surface condition. Some of the measurements, for example, temperature and humidity, will be used to forecast conditions of concern to road users, while others (wind and visibility) may indicate impending or real-time hazards; yet others (meteorological radiation, road-surface temperature and condition) are specific to predicting the performance of the road surface.

The sensors will be selected for their accuracy, stability, ease of maintenance and calibration, and for having electrical outputs suitable for connecting with the automatic data-acquisition system. The choice of sensors and their exposure should conform to standard WMO practice and recommendations (see the relevant chapters in Part I of this Guide), except when these are incompatible with the specific requirements of road meteorology. Measurement accuracy should generally conform to the performances quoted in Part I, Chapter 1, Annex 1B. Note also the recommendations on the measurements at AWSs in Part II, Chapter 1.

12.3.1.1 Air temperature

The sensor may be an electrical resistance thermometer (platinum or stable thermistor). The air-temperature sensor, its radiation shield or screen and exposure should conform to the guidelines of Part I, Chapter 2, with the shield mounted at a height of 1.25 to 2 m over short grass or natural soil.

Measurement issues: The sensor and screen should not be mounted above concrete or asphalt surfaces that could inflate the measured temperature. The placement of the shield should ensure that it is not subject to water spray from the wheels of passing traffic, which might cause significant sensing errors.

12.3.1.2 Relative humidity

The hygrometric sensor may be one of the thin-film electrical conductive or capacitive types (Part I, Chapter 4). A wet-bulb psychrometer is not recommended on account of the continual contamination of the wick by hydrocarbons. The sensor may be combined with or co-located with the air-temperature sensor in its radiation shield as long as the sensor thermal output (self-heating) is very low, so as not to influence the temperature measurement.

Measurement issues: Note the same water spray hazard as for the temperature sensor. Humidity-sensor performance is subject to the effects of contamination by atmospheric and vehicle pollution. Functional checks should be made regularly as part of the data-acquisition quality control, and calibration should be checked at least every six months, particularly before the winter season. A sensor that is not responding correctly must be replaced immediately.

12.3.1.3 Wind speed and direction

These variables are usually measured by either a pair of cup and vane sensors or by a propeller anemometer (Part I, Chapter 5) with pulse or frequency output. The sensors must be mounted at the standard height of 10 m above the ground surface and in a representative open area in order to carry out measurements not influenced by air-mass flow disturbances due to traffic and local obstacles.

Measurement issues: The freezing of moving parts, water ingress and corrosion and lightning strike are potential hazards.

12.3.1.4 Precipitation

(a) *Accumulated precipitation:* The tipping-bucket recording gauge (Part I, Chapter 6) where increments of usually 0.2 mm of precipitation are summed, is commonly used at automatic stations. Heated gauges may be employed to measure snow or other solid precipitation. A rate of precipitation may be estimated by registering the number of counts in a fixed time interval.

Measurement issues: The gauge must be kept level and the funnel and buckets clean and free from obstruction. The tipping-bucket gauge is not satisfactory for indicating the onset of very light rain, or in prolonged periods of freezing weather. Totals will be lower than the true values because of wind effects around the gauge orifice, evaporation from the buckets between showers, and loss between tips of the buckets in heavy rain;

(b) *Precipitation occurrence and type:* Sensors are available which use electronic means (including heated grids, conductance and capacitance measurement) to estimate the character of precipitation (drizzle, rain or snow) falling on them. Optical sensors that determine the precipitation characteristic (size, density and motion of particles) by the scattering of a semiconductor laser beam offer better discrimination at much greater expense.

Measurement issues: These sensing functions are highly desirable at all stations, but existing types of sensors are lacking in discrimination and stable reproducibility. Provisions must be made (heating cycles) to remove accumulated snow from the surface. The regular cleaning of sensitive elements and optical surfaces is required.

Only sensors that are well documented and that can be calibrated against an appropriate reference should be installed. If any system uses an algorithm to derive a variable indirectly, the algorithm should also be documented.

12.3.1.5 Meteorological radiation

(a) *Global radiation:* The solar radiation (direct and diffuse) received from a solid angle of 2π sr on a horizontal surface should be measured by a pyranometer using thermoelectric or photoelectric sensing elements (Part I, Chapter 7). The sensor should be located to have no significant nearby obstructions above the plane of the instrument and with no shadows or light reflections cast on the sensor. Although the location should be such as to avoid accidental damage to the sensor, it should be accessible for inspection and cleaning. Global radiation measured "on site" is particularly relevant to the road manager. It expresses the quantity of energy received by the road during the day. The relationship of incoming radiation to surface temperature and road inertia will depend on the constituent materials and dimensions of the pavement mass.

Measurement issues: Obstructed sensor horizon, sensor not level, surface dirt, snow or frost obscuring the glass dome or sensing surface, and water condensation inside the glass dome;

- (b) *Long-wave radiation:* A pyrgeometer may be used which measures radiation in the infrared by means of a thermopile, filtering out the visible spectrum. Mounted with the sensor facing upwards and a sufficiently unobstructed horizon, it determines the long-wave radiation received from the atmosphere, in particular at night, and gives an indication of cloud cover and therefore of roadway radiative cooling. A sensor sensitive to a spectrum from 5 to 50 μm , with a maximum sensitivity of 15 $\mu\text{V}/\text{Wm}^{-2}$ and a response time lower than 5 s is adequate for road weather forecasting purposes.

Measurement issues: See those for global radiation.

12.3.1.6 Visibility

Transmissometers and forward scatter meters may be applicable (Part I, Chapter 9).

Measurement issues: Road managers are interested in visibilities below 200 m (the danger threshold). Maintaining sensor windows and lenses clean is important. Some systems will compensate for a degree of window contamination. An appropriate calibration procedure should be carried out during routine maintenance.

12.3.1.7 Road-surface temperature

Active sensors based on a 100 ohm platinum resistance and providing serial digital transmission are available, and may be imbedded in the road surface. The manufacturer's instructions for the installation of the sensor and cabling and bonding to the road surface should be followed. The sensor has to be positioned out of the line of tyre tracks, otherwise the sensor surface will be soiled and measurements affected by friction heating. The sensor must lie in the road surface plane with no depression where water could gather and affect the measurement. The sensor's correct position must be checked on a regular basis.

Measurement issues: The thermal lag (time-constant) of the sensor and the imbedding material should match that of the road-surface composition. The sensor should have a surface finish with low absorptance in the infrared to

minimize radiation error. For long connecting cable lengths (over 20 m), cable resistance compensation is recommended.

12.3.1.8 Road-pavement temperature

Temperatures of the pavement at 5, 10 and 20 cm below the road surface may be determined by sinking appropriately sheathed electrical resistance sensors at corresponding depths and using suitable bonding material.

Measurement issues: See those for road-surface temperature.

12.3.1.9 Road-surface condition and freezing temperature

This sensor estimates the road-surface condition (dry, wet, frost, ice) and the freezing temperature of residual surface water. The sensor control circuit heats the sensor before cooling it, using the Peltier effect. The rate of cooling is a function of the surface condition and freezing temperature. See also Part I, Chapter 6, regarding ice on pavements. The sensor output should give road managers an indication of the chemical de-icing agent's persistence at the specific location and enable them to optimize chemical spreading operations.

Measurement issues: The sensor must not be covered by foreign matter or when road re-surfacing. The sensor requires regular cleaning. It is difficult to ensure a sensor response that is representative of the true road-surface condition because of the small sample size, the location on road surface and variable imbedding practices. Measurement depends on traffic density and is otherwise not very stable with time. This sensor, of which there are few alternative makes, may be difficult to obtain. The remote sensing of road-surface temperature by thermal infrared sensors is generally not practical because of the interference caused by water spray from vehicle tyres. Road-surface frost risk estimation may be improved through better measurement of temperature, air humidity and temperature in and on the road surface, namely, improved sensor exposure and reduction of systematic and random errors.

12.3.1.10 Video surveillance

Video surveillance is a component of what have come to be called intelligent transport systems. They are principally used for road-incident detection, but also give a useful indication of present weather for transport management. Image

processing algorithms will aid the discrimination between different weather conditions.

12.4 CHOOSING THE ROAD WEATHER STATION EQUIPMENT

Part II, Chapter 1, gives information that may be applied to road meteorological measurement applications. In what follows, attention is drawn to the particular issues and concerns from the experience of road network managers, in particular the need for high performance where public safety is a primary issue.

12.4.1 The road environment

A road weather station is subject to considerable stress due to the vicinity of the roadway: vibration, vehicle ignition interference, exhaust pollution, corrosion from salt spray, and unwelcome attention from members of the public. In some respects the station may be considered to operate in an industrial environment, with all that that implies for the robustness of the design and concern for data integrity. Frequently met problems are: lack of protection against over-voltage on sensor interface circuits; inadequate electrical isolation between sensors, sensor cables and the data-acquisition unit; variable connector contact resistance causing calibration drift; measurement failure; and extended maintenance attention.

12.4.2 Remote-station processing capability

There is a move in AWS design to include increased data-processing capacity and storage at the remote data-acquisition unit in order to employ processing algorithms that act on several sensor signals to give complex outputs; to provide for some level of quality assurance on the data; to provide two-way communications between the control centre and remote units for diagnostics of both the sensor and unit performance; and to provide for downloading new algorithms and software updates to the remote units. On the other hand, a network of remote stations which are not more complex than necessary for reliable data acquisition, and a central control and data-acquisition computer where the more complex algorithms, quality assurance and code translation is carried out as well as the higher level processing for road management decisions, may provide a more reliable and less costly overall system. Those planning for the

implementation of a road meteorological measurement network are encouraged to consider flexible and extendable equipment solutions with powerful programming options for sensor data processing and system control.

The station data processing may include: control of the measurement cycle (initiation, frequency, time and date); complex sensor management (power on/off, sampling regime); sensor signal processing (filtering, conversion to scientific units, algorithms); data quality checks; alarm generation (variables outside pre-set limits, partial system failure, station integrity breached); data storage (short-term storage and archiving); output message generation (code form, communications protocol); communications management; and station housekeeping (power supply, sensor checks, communications).

12.4.3 Network configuration and equipment options

The selection of station equipment, communications and network control (the network infrastructure) should reflect the particular demands of road meteorology and the road network management decision-making. These choices will be materially affected by the relationship between the road network authority and the local NMHS. For example, the road network authority might contract the NMHS to provide road meteorology forecasting services and specified road data, to which the road network managers apply their physical criteria to make operational decisions. In this case, it would be logical for the road network stations to be an extension of the NMHS AWS network employing common station hardware, communications and maintenance service, with particular attention to network reliability, and including the special sensors, algorithms and software for the road meteorological task. However, if such close integration is impractical, the road authority may still wish to adopt some commonality with NMHS systems to take advantage of operational experience and the supply of hardware and spare parts.

If an entirely new or separate network is required, the following guidelines are recommended for the choice of data-acquisition equipment and communications. Rather than develop new hardware and software for road meteorological measurement, it is wise to employ existing proven systems from reputable manufacturers and sources, with only necessary adaptation to the road network

application, and taking advantage of the experience and advice of other road network administrations. The equipment and its software should be modular to allow for future added sensors and changes in sensor specifications. To facilitate the extension of the network after a few years it is most helpful if the hardware is sourced from standardized designs from a sound manufacturing base where later versions are likely to maintain technical compatibility with earlier generations.

12.4.4 **Design for reliability**

Data-processing modules should be of industry-standard architecture with robust standard operating systems with a well-managed upgrade process. Application software should be written in a standard language and well documented. To achieve the desired reliability, special industrialized components and modules may be selected. A cheaper alternative may be to use standard commercial designs with redundant parallel or back-up systems to ensure system reliability. The design of the remote-unit power supply needs particular attention. An uninterruptible power supply may be recommended, but it should be recognized that communications systems will also depend on a functioning local power supply.

Whatever the system design, housing the electronics in a robust, corrosion-resistant, secure, even temperature, dust- and moisture-free enclosure will add much to its reliability. Connectors carrying the sensor signals should be of high-quality industrial or military grade and well protected against cable strain, water ingress and corrosion. Sensor cabling should have an earth shield and a robust, water-proof insulating sheath and be laid in conduit.

Special attention should be given to obviating the effect of electrical noise or interference introduced into the data-acquisition system through sensor cables, the power supply or communications lines. These unwanted electrical signals may cause sensor signal errors and corrupt data, and cause electronic failure, particularly in sensitive interface circuits. Great care needs to be given to: the design of sensor and communication line isolation and over-voltage protection, including an appropriate level of protection from atmospheric electricity; the adequate earthing or grounding of sensors, power supplies, communications modems and equipment cabinets; and to earth shielding all parts of the measurement chain, avoiding earth current loops which will cause measurement errors.

Good standardized installation and maintenance practices will contribute much to system reliability. System reliability is also related to the “mean time to repair”, which involves the call-out and travel time of maintenance staff to make equipment replacement from whole unit and module stock.

12.5 **MESSAGE CODING**

12.5.1 **Coding functions**

The message transmitted from the remote road meteorological station will contain a station identifier, the message time and date, sensor channel data, including channel identification, and some “housekeeping” data which may include information on station security, power supply, calibration and other data quality checks. This message will be contained in the code envelope relating to the communications channel with an address header, control information and redundancy check characters to provide for error detection. The road meteorological data part of the message may be coded in any efficient, unambiguous way that enables the central control and data-acquisition computer to decode and process before delivering intelligible guidance information to the network managers for their decision-making.

12.5.2 **WMO standard coding**

Designers of road meteorology measurement networks should also consider the value of WMO standard message coding (see WMO, 1995) which enables other users like NMHSs to receive the data by some arrangement and employ it in other meteorological applications. This message coding may be carried out at the remote AWS, which places demands on station software and processing, or, as is more likely, in the central control and data-acquisition computer after the completion of any quality assurance operations on the data.

12.6 **CENTRAL CONTROL AND DATA-ACQUISITION COMPUTER**

The functions of the central computer (or computers) have already been mentioned. The functions are to manage the network by controlling communications (see below), receive reports (road meteorological messages, AWS housekeeping messages and quality information), and process the road measurement data to give the road network managers the

operational information and decision-making tools that they require. The network architecture may be designed to enable the central computer to act as an Intranet or Web server to enable ready access to this information by regional managers and other users of the meteorological data.

A separate computer will probably be allocated to manage the road network climate database and to produce and distribute analyses and statistical summaries. In a sophisticated network the central computer will manage certain maintenance and calibration operations, change AWS operating modes and update AWS software.

12.7 COMMUNICATIONS CONSIDERATIONS

A reliable telecommunications service that enables the network of stations to be effectively managed while it delivers the requisite data on time is vital. Since communications charges will make up a large proportion of the annual operating cost, the analysis of communications options is important, so that the cost per message can be optimized with respect to the level of service required. A detailed review of telecommunications options for the data collection and management of the road AWS is beyond the scope of this chapter (see Part II, Chapter 1, for guidance on data transmission). The communications solution selected will depend on the management objectives of the road meteorological measurement network and the services offered by the telecommunications providers of the country, with their attendant tariffs.

12.8 SENSOR SIGNAL PROCESSING AND ALARM GENERATION

12.8.1 Signal processing algorithms

The raw signal data from sensors must be processed or filtered to produce representative average values. This is either done in some active sensors, in the sensor interface in the data-acquisition unit, or in the higher level data processing of the station. The specifications for averaging the sensor outputs may be found in Part I, Chapter 1, Annex 1B.

Algorithms which are applied to sensor outputs (or groups of outputs) either at the remote station or in the central computer should be from authoritative sources, rigorously tested and preferably published in the open literature. Any in-house algorithms

adopted by the road network management should be well defined and recorded in the station meta-data or network manuals.

12.8.2 Alarm generation

Alarm indications may be generated from sensor outputs when values exceed preset limits to initiate alarm messages from the AWS. The choice of alarms and limit tests will depend on national or regional practice. Some examples of alarms from road AWS follow. Note the use of the logical “and” and “or” combinations in the algorithms.

Examples of alarms include:

- Alarm 1: $T(\text{air})$ OR $T(\text{road surface}) \geq 3^{\circ}\text{C}$
AND
 $T(\text{extrapolated road surface})^a \leq 1^{\circ}\text{C}$
- Alarm 2: $T(\text{air}) \leq 0^{\circ}\text{C}$
- Alarm 3: First condition
 $T(\text{road surface}) \leq 1^{\circ}\text{C}$
OR $T(\text{extrapolated road surface}) \leq 0^{\circ}\text{C}$
OR $T(\text{pavement at } -5 \text{ cm}) \leq 0^{\circ}\text{C}$
OR $T(\text{pavement at } -10 \text{ cm}) \leq -1^{\circ}\text{C}$
OR $T(\text{pavement at } -20 \text{ cm}) \leq -2^{\circ}\text{C}$
AND
Second condition
Carriage-way is not dry
OR at least one precipitation count in the past hour
OR relative humidity $\geq 95\%$
OR $T(\text{road surface}) - T(\text{dewpoint}) \leq 1^{\circ}\text{C}$
- Alarm 4: $T(\text{road surface}) \leq 0^{\circ}\text{C}$ AND detected state: frost or black ice
- Alarm 5: First condition
Detected precipitation = snow or hail
AND
Second condition
 $T(\text{air}) \leq 2^{\circ}\text{C}$
OR $T(\text{road surface}) \leq 0^{\circ}\text{C}$
- Alarm 6: Wind average $\geq 11 \text{ m s}^{-1}$
AND
Wind direction referred to road azimuth, between 45° to 135° OR 225° to 315°
- Alarm 7: Visibility $\leq 200 \text{ m}$

a Extrapolated road-surface temperature is calculated with an algorithm that takes account of the last measures and creates a quadratic equation. This can be used to calculate estimates of temperatures over the next 3 h.

Other alarms may be set if faults are detected in sensors, message formats, power supplies or communications.

12.9 MEASUREMENT QUALITY CONTROL

Good decision-making for road management is dependent on reliable measurements so that, when sensors, their cabling or their interfaces in the AWS

develop a fault, the defective unit is detected and repaired without undue delay. It is very difficult for a road manager to detect erroneous measurements. Reference should be made to the guidance on quality control provided in Part II, Chapter 1 and in Part III, Chapter 1. Gross sensor faults may be detected by the AWS system software, which should then generate an alarm condition.

12.9.1 **Checking for spurious values**

Measurements that fall outside the expected operating range for the sensor, for example, 0° to 359° for a wind vane, and dewpoint not greater than air temperature, may be rejected by setting limits for each variable. Where there has been a faulty zero output, a rapid drift or step change in sensor response, invalid measurements may be rejected by software that performs statistical analysis of measurements over time, either in the AWS if it has sufficient processing power, or in the central data acquisition computer. In some of the examples that follow, the standard deviation of the last n values is compared with a parameterized threshold.

Examples of check algorithms (only for road meteorological measurements) include the following:

- (a) *Test for all temperatures:* Accept data only if standard deviation of the last 30 values is $\geq 0.2^\circ\text{C}$;
- (b) *Test for wind speed:* Accept data only if standard deviation of the last 20 values is $\geq 1 \text{ km hr}^{-1}$;
- (c) *Test for wind direction:* Accept data only if standard deviation of the last 30 values is $\geq 10^\circ$;
- (d) *Test for liquid precipitation:* Check for consistency of amount with previous day's count;
- (e) *Test for snow precipitation:* Check data if $T(\text{air}) > 4^\circ\text{C}$;
- (f) *Test for atmospheric long-wave radiation (AR) (related to cloud cover):* Refuse data if $AR > 130 \text{ W m}^{-2}$, if relative humidity $> 97\%$ and $AR > 10 \text{ W m}^{-2}$, and if relative humidity $\geq 90\%$ and $AR > 10 \text{ W m}^{-2}$, for four successive hours.

12.10 **ROAD WEATHER STATION MAINTENANCE**

12.10.1 **The road environment**

Reference should be made to Part I, Chapter 1 and Part II, Chapter 1 for the sections on inspection, maintenance and calibration. The chapters of Part I

include advice on the maintenance and calibration of specific sensors. Note, however, that the road AWS exists in an environment with peculiar problems: vulnerability of the AWS and its sensors to accidental or intentional damage; exposure to severe vehicle exhaust pollution; electrical interference from vehicle ignition and nearby high-tension power lines; corrosion from salt spray; and vibration (affecting connections between sensors and cables).

12.10.2 **Maintenance plans and documentation**

Because operational decisions affecting road safety may critically depend on reliable AWS data, there are stringent requirements for maintenance of specific stations at particular times of the year. These considerations are outlined in the maintenance management plan for the network, which should include scheduled routine preventive maintenance as well as effective response to known fault conditions.

The road network administration should have its own maintenance manual for its road meteorological stations, based on the manufacturer's recommendations, information gleaned from this Guide and from its own experience. A good manual contains checklists to aid inspection and the performance of maintenance tasks. The administration may decide to contract out inspection and maintenance work to the local NMHS, which should have experience with this kind of instrumentation.

12.10.3 **Inspections and work programmes**

Each station should undergo a complete maintenance programme twice a year, consisting of site maintenance (cutting grass and vegetation which could affect sensor exposure); checking enclosures for water ingress and replacing desiccants; treating and painting weathered and corroded enclosures, screens and supports; checking cable and connector integrity; cleaning and levelling sensors (noting the measurement issues referred to previously); and calibrating or replacing sensors and the AWS measurement chain.

Road managers should maintain a physical inspection programme to check for the integrity and proper operation of their stations once a month in winter and once every two months in the summer. When conducting any work on the road surface, the regulation warning signs must be set out and approved safety clothing must be worn.

12.11 TRAINING

To manage, operate and maintain a network of road meteorological stations in order to obtain a continuous flow of reliable data and to interpret that data to give fully meaningful information requires personnel with specific training in the necessary disciplines. Some of these areas of expertise are: the roadway environment and operational decision-making for the safe and efficient movement of traffic; remote data

acquisition, telecommunications and computing; the selection, application and maintenance of meteorological sensors and their signal processing; and the interpretation of meteorological and other data for the operational context. The administration responsible for the road network should collaborate with other agencies as necessary in order to ensure that the optimum mix of knowledge and training is maintained to ensure the successful operation of the road meteorological measurement network.

REFERENCES AND FURTHER READING

- World Road Association (PIARC), 2002: *Proceedings of the Eleventh PIARC International Winter Road Congress* (Sapporo, Japan).
- World Meteorological Organization, 1988: *Technical Regulations*. WMO-No. 49, Geneva.
- World Meteorological Organization, 1995: *Manual on Codes*. Volumes I.1 and I.2. WMO-No. 306, Geneva.
- World Meteorological Organization, 1997: *Road Meteorological Observations* (R.E.W. Pettifer and J. Terpstra). Instruments and Observing Methods Report No. 61, WMO/TD-No. 842, Geneva.
- World Meteorological Organization, 2003a: *Road Managers and Meteorologists over Road Meteorological Observations: The Result of Questionnaires* (J.M. Terpstra and T. Ledent). Instruments and Observing Methods Report No. 77, WMO/TD-No. 1159, Geneva.
- World Meteorological Organization, 2003b: *Manual on the Global Observing System*. WMO-No. 544, Geneva.
-

PART III

QUALITY ASSURANCE AND MANAGEMENT OF OBSERVING SYSTEMS

PART III. QUALITY ASSURANCE AND MANAGEMENT OF OBSERVING SYSTEMS

CONTENTS

	<i>Page</i>
CHAPTER 1. QUALITY MANAGEMENT	III.1-1
1.1 General.....	III.1-1
1.2 The ISO 9000 family, ISO/IEC 17025, ISO/IEC 20000 and the WMO Quality Management Framework	III.1-2
1.3 Introduction of quality management.....	III.1-6
1.4 Accreditation of laboratories	III.1-8
1.5 Quality management tools	III.1-9
1.6 Factors affecting data quality.....	III.1-9
1.7 Quality assurance (quality control)	III.1-12
1.8 Performance monitoring	III.1-14
1.9 Data homogeneity and metadata	III.1-14
1.10 Network management	III.1-16
References and further reading	III.1-18
CHAPTER 2. SAMPLING METEOROLOGICAL VARIABLES	III.2-1
2.1 General.....	III.2-1
2.2 Time series, power spectra and filters	III.2-3
2.3 Determination of system characteristics	III.2-11
2.4 Sampling	III.2-12
References and further reading	III.2-16
CHAPTER 3. DATA REDUCTION	III.3-1
3.1 General.....	III.3-1
3.2 Sampling	III.3-2
3.3 Application of calibration functions	III.3-3
3.4 Linearization	III.3-3
3.5 Averaging	III.3-3
3.6 Related variables and statistics.....	III.3-4
3.7 Corrections.....	III.3-4
3.8 Quality management	III.3-5
3.9 Compiling metadata	III.3-5
References and further reading	III.3-6
CHAPTER 4. TESTING, CALIBRATION AND INTERCOMPARISON.....	III.4-1
4.1 General.....	III.4-1
4.2 Testing.....	III.4-2
4.3 Calibration	III.4-4
4.4 Intercomparisons	III.4-6
Annex 4.A. Procedures of WMO global and regional intercomparisons of instruments.....	III.4-8
Annex 4.B. Guidelines for organizing WMO intercomparisons of instruments.....	III.4-9
Annex 4.C. Reports of international comparisons conducted under the auspices of the commission for instruments and methods of observation.....	III.4-14
References and further reading	III.4-16

CHAPTER 5. TRAINING OF INSTRUMENT SPECIALISTS	III.5-1
5.1 Introduction.....	III.5-1
5.2 Appropriate training for operational requirements.....	III.5-1
5.3 Some general principles for training	III.5-2
5.4 The training process.....	III.5-6
5.5 Resources for training	III.5-11
Annex. Regional training centres	III.5-15
References and further reading	III.5-16

CHAPTER 1

QUALITY MANAGEMENT

1.1 GENERAL

This chapter is general and covers operational meteorological observing systems of any size or nature. Although the guidance it gives on quality management is expressed in terms that apply to large networks of observing stations, it should be read to apply even to a single station.

Quality management

Quality management provides the principles and the methodological frame for operations, and coordinates activities to manage and control an organization with regard to quality. Quality assurance and quality control are the parts of any successful quality management system. Quality assurance focuses on providing confidence that quality requirements will be fulfilled and includes all the planned and systematic activities implemented in a quality system so that quality requirements for a product or service will be fulfilled. Quality control is associated with those components used to ensure that the quality requirements are fulfilled and includes all the operational techniques and activities used to fulfil quality requirements. This chapter concerns quality management associated with quality control and quality assurance and the formal accreditation of the laboratory activities, especially from the point of view of meteorological observations of weather and atmospheric variables.

The ISO 9000 family of standards is discussed to assist understanding in the course of action during the introduction of a quality management system in a National Meteorological and Hydrological Service (NMHS); this set of standards and contains the minimum processes that must be introduced in a quality management system for fulfilling the requirements of the ISO 9001 standard. The total quality management concept according to the ISO 9004 guidelines is then discussed, highlighting the views of users and interested parties. The ISO/IEC 17025 standard is introduced. The benefits to NMHSs and the Regional Instrument Centres (RICs) from accreditation through ISO/IEC 17025 are outlined along with a requirement for an accreditation process.

The ISO/IEC 20000 standard for information technology (IT) service management is introduced into the discussion, given that every observing system incorporates IT components.

Quality assurance and quality control

Data are of good quality when they satisfy stated and implied needs. Elsewhere in this Guide explicit or implied statements are given of required accuracy, uncertainty, resolution and representativeness, mainly for the synoptic applications of meteorological data, but similar requirements can be stated for other applications. It must be supposed that minimum total cost is also an implied or explicit requirement for any application. The purpose of quality management is to ensure that data meet requirements (for uncertainty, resolution, continuity, homogeneity, representativeness, timeliness, format, and so on) for the intended application, at a minimum practicable cost. All measured data are imperfect, but, if their quality is known and demonstrable, they can be used appropriately.

The provision of good quality meteorological data is not a simple matter and is impossible without a quality management system. The best quality systems operate continuously at all points in the whole observing system, from network planning and training, through installation and station operations to data transmission and archiving, and they include feedback and follow-up provisions on timescales from near-real time to annual reviews and end-to-end process. The amount of resources required for an effective quality management system is a proportion of the cost of operating an observing system or network and is typically a few per cent of the overall cost. Without this expenditure, the data must be regarded as being of unknown quality, and their usefulness is diminished.

An effective quality system is one that manages the linkages between preparation for data collection, data collection, data assurance and distribution to users to ensure that the user receives the required quantity. For many meteorological quantities, there are a number of these preparation-collection-assurance cycles between the field and the ultimate distribution to the user. It is essential that all these cycles are identified and the potential for divergence from the required quantity minimized. Many

of these cycles will be so closely linked that they may be perceived as one cycle. Most problems occur when there are a number of cycles and they are treated as independent of one another.

Once a datum from a measurement process is obtained, it remains the datum of the measurement process. Other subsequent processes may verify its worth as the quantity required, use the datum in an adjustment process to create the quality required, or reject the datum. However, none of these subsequent processes changes the datum from the measurement process. Quality control is the process by which an effort is made to ensure that the processes leading up to the datum being distributed are correct, and to minimize the potential for rejection or adjustment of the resultant datum.

Quality control includes explicit control of the factors that directly affect the data collected and processed before distribution to users. For observations or measurements, this includes equipment, exposure, measurement procedures, maintenance, inspection, calibration, algorithm development, redundancy of measurements, applied research and training. In a data transmission sense, quality control is the process established to ensure that for data that is subsequently transmitted or forwarded to a user database, protocols are set up to ensure that only acceptable data are collected by the user.

Quality assurance is the best-known component of quality management systems, and it is the irreducible minimum of any system. It consists of all the processes that are put in place to generate confidence and ensure that the data produced will have the required quality and also include the examination of data at stations and at data centres to verify that the data are consistent with the quality system goals, and to detect errors so that the data may be either flagged as unreliable, corrected or, in the case of gross errors, deleted. A quality system should include procedures for feeding back into the measurement and quality control process to prevent the errors from recurring. Quality assurance can be applied in real-time post measurement, and can feed into the quality control process for the next process of a quality system, but in general it tends to operate in non-real time.

Real-time quality assurance is usually performed at the station and at meteorological analysis centres. Delayed quality assurance may be performed at analysis centres for the compilation of a refined database, and at climate centres or databanks for archiving. In all cases, the results should be

returned to the observation managers for follow-up.

A common component of quality assurance is quality monitoring or performance monitoring, a non-real-time activity in which the performance of the network or observing system is examined for trends and systematic deficiencies. It is typically performed by the office that manages and takes responsibility for the network or system, and which can prescribe changes to equipment or procedures. These are usually the responsibility of the network manager, in collaboration with other specialists, where appropriate.

Modern approaches to data quality emphasize the advantages of a comprehensive system for quality assurance, in which procedures are laid down for continuous interaction between all parties involved in the observing system, including top management and others such as designers and trainers who may otherwise have been regarded as peripheral to operational quality concerns after data collection. The formal procedures prescribed by the International Organization for Standardization (ISO) for quality management and quality assurance, and other detailed procedures used in manufacturing and commerce, are also appropriate for meteorological data.

1.2 **THE ISO 9000 FAMILY, ISO/IEC 17025, ISO/IEC 20000 AND THE WMO QUALITY MANAGEMENT FRAMEWORK**

The chapter gives an explanation of the related ISO standards and how they interconnect.

Proficiency in ISO quality systems is available through certification or accreditation, and usually requires external auditing of the implemented quality system. Certification implies that the framework and procedures used in the organization are in place and used as stated. Accreditation implies that the framework and procedures used in the organization are in place, used as stated and technically able to achieve the required result. The assessment of technical competence is a mandatory requirement of accreditation, but not of certification. The ISO 9001 is a standard by which certification can be achieved by an organization, while accreditation against the ISO/IEC 17025 is commonly required for laboratories and routine observations.

The ISO 9000 standard has been developed to assist organizations of all types and sizes to implement and operate quality management systems. The ISO 9000 standard describes the fundamentals of quality management systems and gives definitions of the related terms (for example, requirement, customer satisfaction). The main concept is illustrated in Figure 1.1. The ISO 9001 standard specifies the requirements for a quality management system that can be certified in accordance with this standard. The ISO 9004 standard gives guidelines for continual improvement of the quality management system to achieve a total quality management system. The ISO 19011 standard provides the guidance on auditing the quality management system. All these standards are described in more detail in the related documents of the WMO Quality Management Framework.

1.2.1 ISO 9000: Quality management systems – Fundamentals and vocabulary

The following eight quality management principles are the implicit basis for the successful leadership of NMHSs of all sizes and for continual performance improvement:

- (a) Customer focus;
- (b) Leadership;
- (c) Involvement of people;
- (d) Process approach;
- (e) System approach to management;
- (f) Continual improvement;

- (g) Factual approach to decision-making;
- (h) Mutually beneficial supplier relationships.

All these principles must be documented and put to practice to meet the requirements of the ISO 9000 and 9001 standards to achieve certification. The main topic of these standards is the process approach, which can simply be described as activities that use resources to transform inputs into outputs.

The process-based quality management system is simply modelled in Figure 1.2. The basic idea is that of the mechanism likely to obtain continual improvement of the system and customer satisfaction through measuring the process indices (for example, computing time of a GME model, customer satisfaction, reaction time, and so forth), assessing the results, making management decisions for better resource management and obtaining inevitably better products.

1.2.2 ISO 9001: Quality management systems – Requirements

The basic requirements for a quality management system are given by this standard, including processes for improvement and complaint management and carrying out management reviews. These processes are normally incorporated in the quality manual. The ISO 9001 standard focuses on management responsibility rather than technical activities.

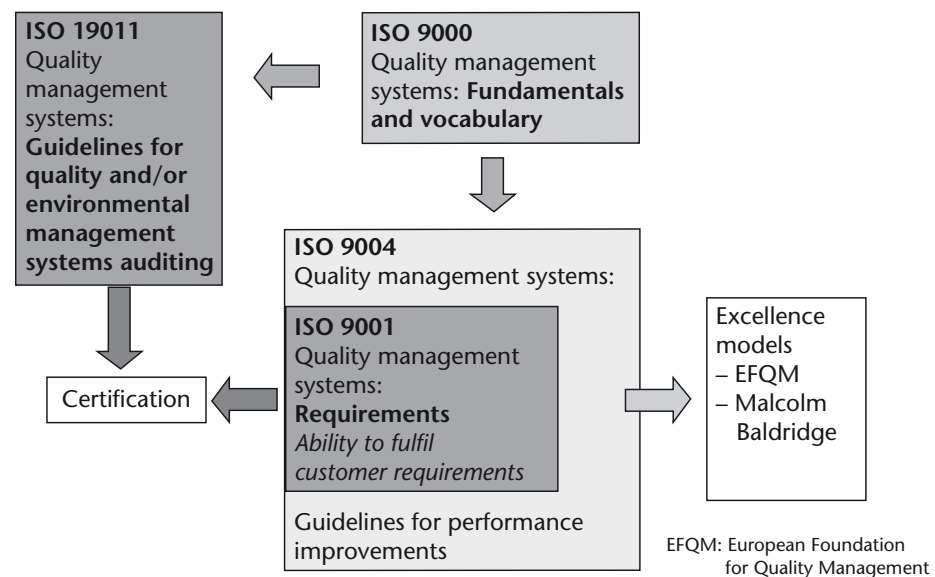

Figure 1.1. The main concept of the ISO 9000 standards and the dependencies

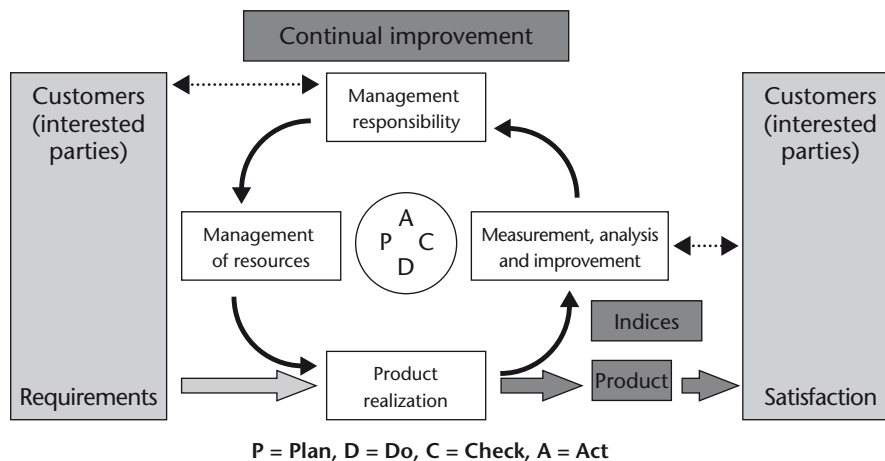

Figure 1.2. The PDCA control circuit (also named the Deming-circuit)

To achieve certification in ISO 9001, six processes must be defined and documented by the organization (NMHS), as follows:

- (a) Control of documents;
- (b) Control of records;
- (c) Control of non-conforming products;
- (d) Corrective action;
- (e) Preventive action;
- (f) Internal audit.

Furthermore, there must be a quality manual which states the policy (for example, the goal is to achieve regional leadership in weather forecasting) and the objectives of the organization (for example, improved weather forecasting: reduce false warning probability) and describes the process frameworks and their interaction. There must be statements for the following:

- (a) Management;
- (b) Internal communication;
- (c) Continual improvement;
- (d) System control (for example, through management reviews).

Exclusions can be made, for example, for development (if there are no development activities in the organization).

The documentation pyramid of the quality management system is shown in Figure 1.3. The process descriptions indicate the real activities in the organization, such as the data-acquisition process in the weather and climate observational networks. They provide information on the different process steps and the organizational units carrying out the steps, for cooperation and information sharing purposes. The documentation must differentiate between periodic and non-periodic

processes. Examples of periodic processes are data acquisition or forecast dissemination. Examples of non-periodic processes include the installation of measurement equipment which starts with a user or component requirement (for example, the order to install a measurement network).

Lastly, the instructions in ISO 9001 give detailed information on the process steps to be referenced in the process description (for example, starting instruction of an AWS). Forms and checklists are helpful tools to reduce the possibility that required tasks will be forgotten.

1.2.3 ISO 9004: Quality management systems – Guidelines for performance improvements

The guidelines for developing the introduced quality management system to achieve business excellence are formulated in ISO 9004. The main aspect is the change from the customer position to the position of interested parties. Different excellence models can be developed by the ISO 9004 guidelines, for example, the Excellence Model of the European Foundation for Quality Management (EFQM)¹ or the Malcolm Baldrige National Quality Award.² Both excellence models are appropriately established and well respected in all countries of the world.

The EFQM Excellence Model contains the following nine criteria which are assessed by an expert team of assessors:

1 See EFQM website at <http://www.efqm.org>.

2 See the NIST website at <http://www.quality.nist.gov>.

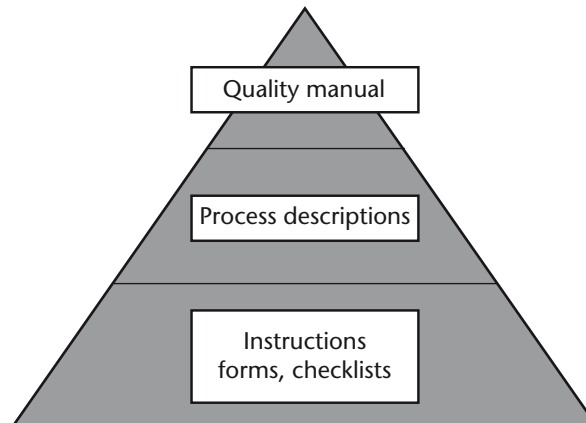

Figure 1.3. The documentation pyramid of a quality management system

- (a) Leadership;
- (b) People;
- (c) Policy and strategy;
- (d) Partnerships and resources;
- (e) Processes;
- (f) People results;
- (g) Customer results;
- (h) Society results;
- (i) Key performance results.

The Malcolm Baldrige model contains seven criteria similar to the EFQM Excellence Model, as follows:

- (a) Leadership;
- (b) Strategic planning;
- (c) Customer and market focus;
- (d) Measurement, analysis, and knowledge management;
- (e) Human resources focus;
- (f) Process management;
- (g) Results.

There is no certification process for this standard, but external assessment provides the opportunity to draw comparisons with other organizations according to the excellence model (see also Figure 1.1).

1.2.4 **ISO 19011: Guidelines for quality and/or environmental management systems auditing**

This standard is a guide for auditing quality or environmental management systems and does not have any regulatory character. The following detailed activities are described for auditing the organization:

- (a) Principles of auditing (ethical conduct, fair presentation, due professional care, independence, evidence-based approach);

- (b) Audit planning (establishing and implementing the audit programme);
- (c) Audit activities (initiating the audit, preparing and conducting on-site audit activities, preparing the audit report);
- (d) Training and education of the auditors (competence, knowledge, soft skills).

The manner in which audits are conducted depends on the objectives and scope of the audit which are set by the management or the audit client. The primary task of the first audit is to check the conformity of the quality management system with the ISO 9001 requirements. Further audits give priority to the interaction and interfaces of the processes.

The audit criteria are the documentation of the quality management system, the process descriptions, the quality manual and the unique individual regulations.

The audit planning published by the organization should specify the relevant departments of the organization, the audit criteria and the audit objectives, place, date and time to ensure a clear assignment of the audits.

1.2.5 **ISO/IEC 17025: General requirements for the competence of testing and calibration laboratories**

This set of requirements is applicable to facilities, including laboratories and testing sites, that wish to have external accreditation of their competence in terms of their measurement and testing processes.

The ISO/IEC 17025 standard aligns its management requirements with those of ISO 9001. This standard

is divided into two main parts: management requirements and technical requirements. Hence, the quality management system must follow the requirements of the ISO 9001 standard, which include described processes, a management handbook that provides a connection between processes and goals and policy statements, and that these aspects be audited regularly. All laboratory processes must be approved, verified and validated in a suitable manner to meet the requirements. Furthermore, the roles of the quality management representative (quality manager) and the head of the laboratory must be determined.

An essential component of the technical requirements is the development of uncertainty analyses for each of the measurement processes, including documented and verified traceability to international metrology standards.

1.2.6 **ISO/IEC 20000: Information technology – Service management**

NMHSs make use of IT equipment to obtain data from the measuring networks to use in GME/LM models and to provide forecasters with the outputs of models. The recommendations of this standard are helpful for the implementation of reliable IT services. The new ISO/IEC 20000 standard summarizes the old British standard BS-15000 and the IT Infrastructure Library (ITIL) recommendations. The division of requirements follows the ITIL structure.

The ITIL elements are divided into service delivery and service support with the following processes:

Service delivery:

- (a) Service-level management;
- (b) Financial management;
- (c) IT service continuity management;
- (d) Availability management;
- (e) Capacity management.

Service support:

- (a) Change management;
- (b) Incident management;
- (c) Problem management;
- (d) Release management;
- (e) Configuration management.

Security management is common to both areas.

All these require that:

- (a) The processes be adapted to the NMHS's organization;

- (b) Particular attention be paid to user support.

Special attention has been placed on the change-management process, which can contain release and configuration management. Incident and problem management is normally covered by the implementation of a user help desk.

1.2.7 **WMO Quality Management Framework**

The WMO Quality Management Framework gives the basic recommendations that were based on the experiences of NMHSs. The necessary conditions for successful certification against ISO 9001 are explained in WMO (2005a; 2005b).

The Quality Management Framework is the guide for NMHSs, especially for NMHSs with little experience in a formal quality management system. The introduction of a quality management system is described only briefly in the following section, noting that WMO cannot carry out any certification against ISO 9001.

1.3 **INTRODUCTION OF QUALITY MANAGEMENT**

The introduction of successful quality management depends heavily on the cooperation of senior management. The senior management of the NMHS must be committed to the quality management system and support the project team. The necessary conditions for successful certification are summarized and the terms of ISO 9001 standards are explained in ISO 20000.

Senior-level management defines a quality policy and the quality objectives (including a quality management commitment), and staff have to be trained in sufficient quality management topics to understand the basis for the quality management process (see section 1.2.2). Most importantly, a project team should be established to manage the transition to a formal quality management system including definition and analysis of the processes used by the organization.

To assist the project team, brief instructions can be given to the staff involved in the process definition, and these would normally include the following:

- (a) To document (write down) what each group does;
- (b) To indicate the existing documentation;

- (c) To indicate the proof or indicators of what is done;
- (d) To identify what can be done to continually improve the processes.

Given that the documentation specifies what the organization does, it is essential that the main processes reflect the functions of the organization of the NMHS. These can be a part of the named processes (see Figure 1.4), for example:

- (a) Weather forecasting (including hydro-meteorological, agrometeorological, human biometeorological aspects) and weather warnings;
- (b) Consulting services (including climate and environment);
- (c) Data generation (from measurement and observational networks);
- (d) International affairs;
- (e) Research and development (global modelling, limited area models, instrumentation);
- (f) Technical infrastructure (computing and communications, engineering support, data management and IT support);
- (g) Administration processes (purchasing, financial and personnel management, organization, administration offices and immovables, knowledge management, central planning and control and legal affairs).

Even though these processes will meet the individual needs of NMHSs and provide them with subprocesses, normally there should be regulations for remedying incidents (for example, system failures, staff accidents).

The processes must be introduced into the organization with clear quality objectives, and all staff must be trained in understanding the processes, including the use of procedures and checklists and the measurement of process indicators.

Before applying for certification, the quality management system must be reviewed by carrying out internal audits in the departments and divisions of the organization, to check conformity of the quality management system as stated and as enacted. These documented reviews can be performed on products by specialized and trained auditors. The requirements and recommendations for these reviews are given in ISO 19011 (see section 1.2.4).

The management review of the quality management system will include the following:

- (a) Audit results;
- (b) Customer feedback;
- (c) Process performance based on performance indicators;

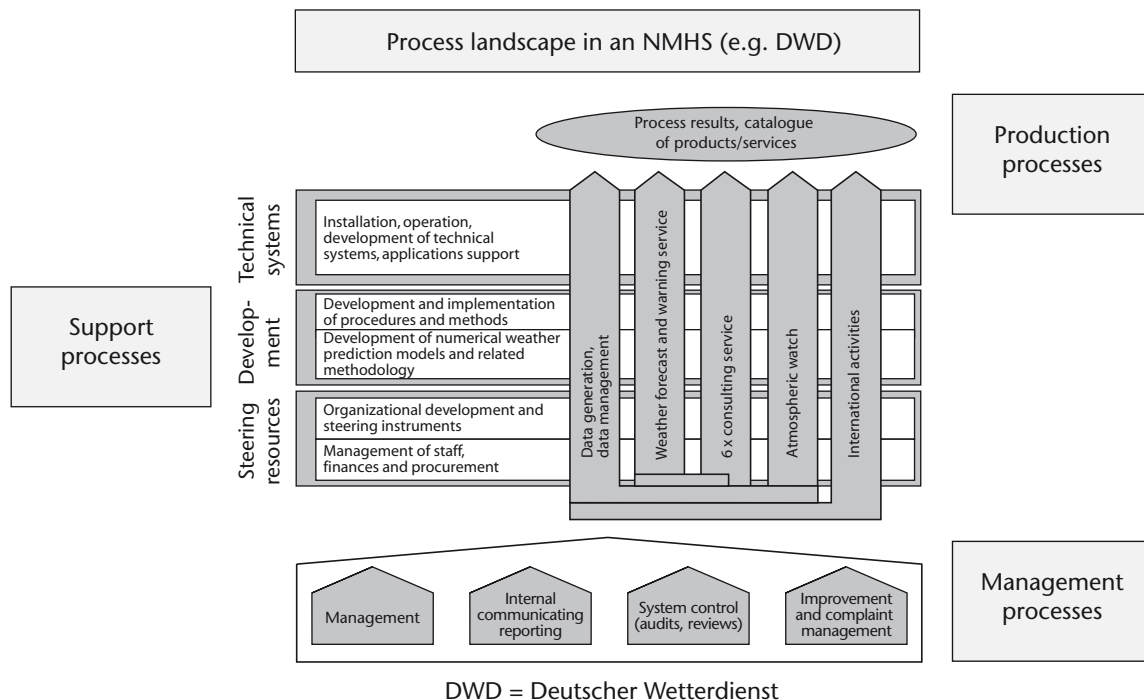

DWD = Deutscher Wetterdienst

Figure. 1.4. Process landscape of an NMHS (example: DWD, WMO 2005a)

- (d) Status of preventive and corrective actions;
- (e) Follow-up actions from previous management reviews;
- (f) Changes in the quality management system (policy of the organization);
- (g) Recommendations for improvement.

1.4 ACCREDITATION OF LABORATORIES

Accreditation requires additional processes and documentation and, most importantly, evidence that laboratory staff have been trained and have mastered the processes and methods to be accredited.

The documentation must contain the following aspects:

- (a) A management manual for the laboratory;
- (b) The process descriptions mentioned in section 1.2;
- (c) The documentation of all processes and methods;
- (d) Work instructions for all partial steps in the processes and methods;
- (e) Equipment manuals (manual including calibrating certificates);
- (f) Maintenance manuals.

Since procedures and methods are likely to change more frequently than the management aspects of the accreditation, the methods are usually not included in the management manual. However, there is specific reference to the procedures and methods used in the management manual.

As it is unlikely that all aspects of the accreditation will be covered once the quality management system is introduced, it is recommended that a pre-audit be conducted and coordinated with the certifying agency. In these pre-audits it would be normal for the certifying agency:

- (a) To assess staff and spatial prerequisites;
- (b) To assess the suitability of the management system;
- (c) To check the documentation;
- (d) To validate the scope of the accreditation.

The accreditation procedure consists of assessments by an expert panel (external to the organization), which includes a representative from the certifying agency. The assessment panel will focus on two main areas as follows:

- (a) Documentation;
- (b) An examination of the facilities included in the scope of the accreditation (for example, laboratories, special field sites).

The assessment of documentation covers verification of the following documents:

- (a) A management manual (or laboratory guide);
- (b) Procedure instructions;
- (c) Work instructions;
- (d) Test instructions;
- (e) Equipment manuals;
- (f) Maintenance manuals;
- (g) Uncertainty analyses of specific quantities, test results and calibrations;
- (h) Proof documents (for example, that staff training has occurred and that quantities are traceable);
- (i) Records (for example, correspondence with the customer, generated calibration certificates).

The external expert team could request additional documents, as all aspects of the ISO/EC 17025 standard are checked and in more detail than a certification under ISO 9001.

Besides the inspection of the measurement methods and associated equipment, the assessment of the facilities in the scope of the accreditation will include the following:

- (a) Assessment of the staff (including training and responsibility levels);
- (b) Assessment of the infrastructure that supports the methods (for example, buildings, access).

The following are also checked during the assessment to ensure that they meet the objectives required by management for accreditation:

- (a) Organizational structure;
- (b) Staff qualifications;
- (c) Adequacy of the technological facilities;
- (d) Customer focus.

In addition, the assessment should verify that the laboratory has established proof of the following:

- (a) Technical competence (choice and use of the measuring system);
- (b) Calibration of measurement equipment;
- (c) Maintenance of measurement equipment;
- (d) Verification and validation of methods.

Benefits and disadvantages of accreditation

Through initial accreditation by an independent certifying agency NMHSs prove their competence in the area of meteorological measuring and testing methods according to a recognized standard. Once accreditation is established, there is an ongoing periodic external audit, which provides additional proof that standards have been maintained, but more importantly it helps

the organization to ensure that its own internal quality requirements are met.

An accreditation with suitable scope also provides commercial opportunities for the calibration, verification and assessment of measurement devices.

For organizations that do not have a quality management system in place, the benefits of accreditation are significant. First, it documents the organization's system, and, through that, a process of analysis can be used to make the organization more efficient and effective. For example, one component of accreditation under ISO/EC 17025 requires uncertainty analyses for every calibration and verification test; such quantitative analyses provide information on where the most benefit can be achieved for the least resources.

Accreditation or certification under any recognized quality framework requires registration and periodic audits by external experts and the certifying agency. These represent additional costs for the organization and are dependent on the scope of the accreditation and certification.

Seeking accreditation before an effective quality management system is in place will lead to an increased use of resources and result in existing resources being diverted to establish a quality management system; there will also be additional periodic audit costs.

1.5 QUALITY MANAGEMENT TOOLS

Several well known tools exist to assist in the processes of a quality management system and its continuous improvement. Three examples of these tools are described below as an introduction: the Balanced Score card, Failure Mode and Effects Analysis, and Six Sigma.

The Balanced Scorecard (Kaplan and Norton, 1996) has at a minimum four points of focus: finances, the customer, processes and employees. Often the general public is added given that public interests must always be taken into account.

Each organization and organization element provides key performance indicators for each of the focus areas, which in turn link to the organization's mission (or purpose, vision or goals) and the strategy (or working mission and vision).

Failure Mode and Effects Analysis is a method for the examination of possible missing causes and faults and the probability of their appearance. The method can be used for analysing production processes and product specification. The aim of the optimization process is to reduce the risk priority number.

The Six Sigma method was developed in the communications industry and uses statistical process controls to improve production. The objective of this method is to reduce process failure below a specific value.

1.6 FACTORS AFFECTING DATA QUALITY

The life history of instruments in field service involves different phases, such as planning according to user requirements, selection and installation of equipment, operation, calibration, maintenance and training activities. To obtain data of adequate or prescribed quality, appropriate actions must be taken at each of these phases. Factors affecting data quality are summarized in this section, and reference is made to more comprehensive information available in other chapters of this Guide and in other WMO Manuals and Guides.

User requirements: The quality of a measuring system can be assessed by comparing user requirements with the ability of the systems to fulfil them. The compatibility of user data-quality requirements with instrumental performance must be considered not only at the design and planning phase of a project, but also continually during operation, and implementation must be planned to optimize cost/benefit and cost/performance ratios. This involves a shared responsibility between users, instrument experts and logistic experts to match technical and financial factors. In particular, instrument experts must study the data quality requirements of the users to be able to propose specifications within the technical state of the art. This important phase of design is called value analysis. If it is neglected, as is often the case, it is likely that the cost or quality requirements, or both, will not be satisfied, possibly to such an extent that the project will fail and efforts will have been wasted.

Functional and technical specifications: The translation of expressed requirements into functional specifications and then into technical specifications is a very important and complex task, which requires a sound knowledge of user requirements, meteorological measuring technology, methods of

observation, WMO regulations, and relevant operational conditions and technical/administrative infrastructures. Because the specifications will determine the general functioning of a planned measuring system, their impact on data quality is considerable.

Selection of instruments: Instruments should be carefully selected considering the required uncertainty, range and resolution (for definitions see Part I, Chapter 1), the climatological and environmental conditions implied by the users' applications, the working conditions, and the available technical infrastructure for training, installation and maintenance. An inappropriate selection of instruments may yield poor quality data that may not be anticipated, causing many difficulties when they are subsequently discovered. An example of this is an underspecification resulting in excessive wear or drift. In general, only high quality instruments should be employed for meteorological purposes. Reference should be made to the relevant information given in the various chapters in this Guide. Further information on the performance of several instruments can be found in the reports of WMO international instrument intercomparisons and in the proceedings of WMO/CIMO and other international conferences on instruments and methods of observation.

Acceptance tests: Before installation and acceptance, it is necessary to ensure that the instruments fulfil the original specifications. The performance of instruments, and their sensitivity to influence factors, should be published by manufacturers and are sometimes certified by calibration authorities. However, WMO instrument intercomparisons show that instruments may still be degraded by factors affecting their quality which may appear during the production and transportation phases. Calibration errors are difficult or impossible to detect when adequate standards and appropriate test and calibration facilities are not readily available. It is an essential component of good management to carry out appropriate tests under operational conditions before instruments are used for operational purposes. These tests can be applied both to determine the characteristics of a given model and to control the effective quality of each instrument.

When purchasing equipment, consideration should be given to requiring the supplier to set up certified quality assurance procedures within its organization according to the requirements of the NMHS, thus reducing the need for acceptance testing by

the recipient. The extra cost when purchasing equipment may be justified by consequent lower costs for internal testing or operational maintenance, or by the assured quality of subsequent field operations.

Compatibility: Data compatibility problems can arise when instruments with different technical characteristics are used for taking the same types of measurements. This can happen, for example, when changing from manual to automated measurements, when adding new instruments of different time-constants, when using different sensor shielding, when applying different data reduction algorithms, and so on. The effects on data compatibility and homogeneity should be carefully investigated by long-term intercomparisons. Reference should be made to the various WMO reports on international instrument intercomparisons.

Siting and exposure: The density of meteorological stations depends on the timescale and space scale of the meteorological phenomena to be observed and is generally specified by the users, or set by WMO regulations. Experimental evidence exists showing that improper local siting and exposure can cause a serious deterioration in the accuracy and representativeness of measurements. General siting and exposure criteria are given in Part I, Chapter 1, and detailed information appropriate to specific instruments is given in the various chapters of Part I. Further reference should be made to the regulations in WMO (2003). Attention should also be paid to external factors that can introduce errors, such as dust, pollution, frost, salt, large ambient temperature extremes or vandalism.

Instrumental errors: A proper selection of instruments is a necessary, but not sufficient, condition for obtaining good-quality data. No measuring technique is perfect, and all instruments produce various systematic and random errors. Their impact on data quality should be reduced to an acceptable level by appropriate preventive and corrective actions. These errors depend on the type of observation; they are discussed in the relevant chapters of this Guide (see Part I).

Data acquisition: Data quality is not only a function of the quality of the instruments and their correct siting and exposure, but also depends on the techniques and methods used to obtain data and to convert them into representative data. A distinction should be made between automated measurements and human observations. Depending on the technical characteristics of a

sensor, in particular its time-constant, proper sampling and averaging procedures must be applied. Unwanted sources of external electrical interference and noise can degrade the quality of the sensor output and should be eliminated by proper sensor-signal conditioning before entering the data-acquisition system. Reference should be made to sampling and filtering in Part II, Chapter 1 and in Part II, Chapter 2. In the case of manual instrument readings, errors may arise from the design, settings or resolution of the instrument, or from the inadequate training of the observer. For visual or subjective observations, errors can occur through an inexperienced observer misinterpreting the meteorological phenomena.

Data processing: Errors may also be introduced by the conversion techniques or computational procedures applied to convert the sensor data into Level II or Level III data. Examples of this are the calculation of humidity values from measured relative humidity or dewpoint and the reduction of pressure to mean sea level. Errors also occur during the coding or transcription of meteorological messages, in particular if performed by an observer.

Real-time quality control: Data quality depends on the real-time quality-control procedures applied during data acquisition and processing and during the preparation of messages, in order to eliminate the main sources of errors. These procedures are specific to each type of measurement but generally include gross checks for plausible values, rates of change and comparisons with other measurements (for example, dewpoint cannot exceed temperature). Special checks concern manually entered observations and meteorological messages. In AWSs, special built-in test equipment and software can detect specific hardware errors. The application of these procedures is most important since some errors introduced during the measuring process cannot be eliminated later. For an overview of manual and automatic methods in use, refer to other paragraphs of this chapter as well as to Part II, Chapter 1 and WMO (1989; 1992; 1993a; 2003).

Performance monitoring: As real-time quality-control procedures have their limitations and some errors can remain undetected, such as long-term drifts in sensors and errors in data transmission, performance monitoring at the network level is required at meteorological analysis centres and by network managers. This monitoring is described in section 1.8 of this chapter. Information can also be found in Part II, Chapter 1 and in WMO

(1989). It is important to establish effective liaison procedures between those responsible for monitoring and for maintenance and calibration, to facilitate rapid response to fault or failure reports from the monitoring system.

Testing and calibration: During their operation, the performance and instrumental characteristics of meteorological instruments change for reasons such as the ageing of hardware components, degraded maintenance, exposure, and so forth. These may cause long-term drifts or sudden changes in calibration. Consequently, instruments need regular inspection and calibration to provide reliable data. This requires the availability of standards and of appropriate calibration and test facilities. It also requires an efficient calibration plan and calibration house-keeping. See Part III, Chapter 4 for general information about test and calibration aspects and to the relevant chapters of Part I for individual instruments.

Maintenance: Maintenance can be corrective (when parts fail), preventive (such as cleaning or lubrication) or adaptive (in response to changed requirements or obsolescence). The quality of the data provided by an instrument is considerably affected by the quality of its maintenance, which in turn depends mainly on the ability of maintenance personnel and the maintenance concept. The capabilities, personnel and equipment of the organization or unit responsible for maintenance must be adequate for the instruments and networks. Several factors have to be considered, such as a maintenance plan, which includes corrective, preventive and adaptive maintenance, logistic management, and the repair, test and support facilities. It must be noted that the maintenance costs of equipment can greatly exceed its purchase costs (see Part II, Chapter 1).

Training and education: Data quality also depends on the skills of the technical staff in charge of testing, calibration and maintenance activities, and of the observers making the observations. Training and education programmes should be organized according to a rational plan geared towards meeting the needs of users, and especially the maintenance and calibration requirements outlined above, and should be adapted to the system; this is particularly important for AWSs. As part of the system procurement, the manufacturer should be obliged to provide very comprehensive operational and technical documentation and to organize operational and

technical training courses (see Part III, Chapter 5) in the NMHS.

Metadata: A sound quality assurance entails the availability of detailed information on the observing system itself and in particular on all changes that occur during the time of its operation. Such information on data, known as metadata, enables the operator of an observing system to take the most appropriate preventive, corrective and adaptive actions to maintain or enhance data quality. Metadata requirements are further considered in section 1.9. For further information on metadata, see Part I, Chapter 1 (and Annex 1.C).

1.7 QUALITY ASSURANCE (QUALITY CONTROL)

WMO (2003) prescribes that certain quality-control procedures must be applied to all meteorological data to be exchanged internationally. Level I and Level II data, and the conversion from one to the other, must be subjected to quality control. WMO (1992) prescribes that quality-control procedures must be applied by meteorological data processing centres to most kinds of weather reports exchanged internationally, to check for coding errors, internal consistency, time and space consistency, and physical and climatological limits, and it specifies the minimum frequency and times for quality control.

WMO (1989) gives general guidance on procedures. It emphasizes the importance of quality control at the station, because some errors occurring there cannot be subsequently corrected, and also points out the great advantages of automation. WMO (1993a) gives rather detailed descriptions of the procedures that may be used by numerical analysis centres, with advice on climatological limits, types of internal consistency checks, comparisons with neighbouring stations and with analyses and prognoses, and provides brief comments on the probabilities of rejecting good data and accepting false data with known statistical distributions of errors.

Quality control, as specifically defined in section 1.1, is implemented in real time or near-real time to data acquisition and processing. In practice, responsibility for quality control is assigned to various points along the data chain. These may be at the station, if there is direct manual involvement in data acquisition,

or at the various centres where the data are processed.

Quality assurance procedures must be introduced and reassessed during the development phases of new sensors or observing systems (see Figure 5).

1.7.1 Surface data

1.7.1.1 Manual observations and staffed stations

The observer or the officer in charge at a station is expected to ensure that the data leaving the station have been quality controlled, and should be

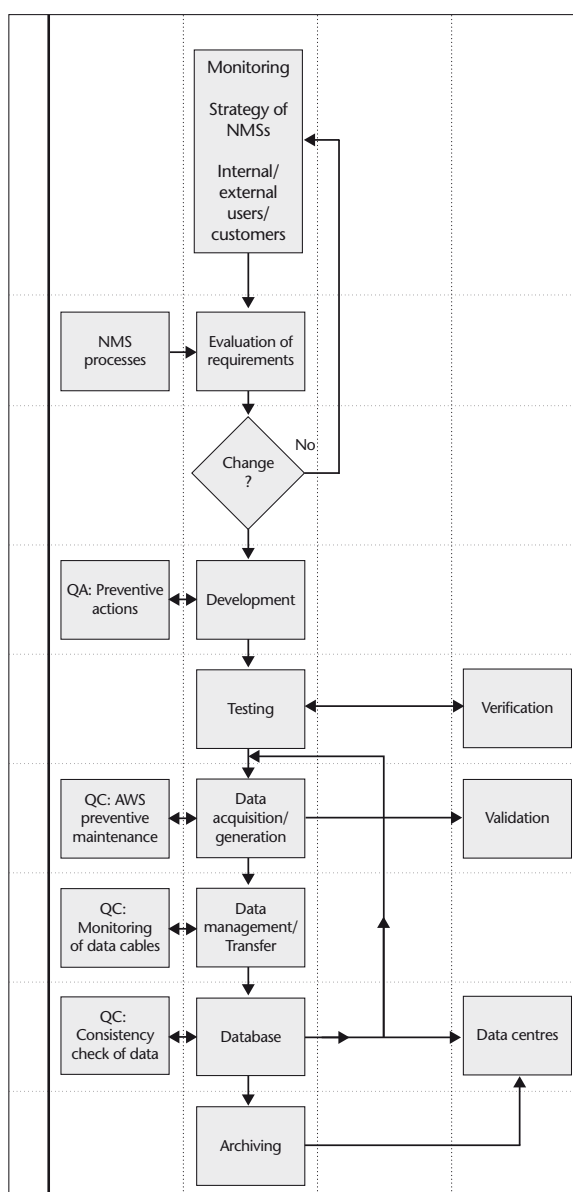

NMS: National Meteorological or Hydrological Service
 QA: Quality assurance
 QC: Quality control

Figure 1.5. Process for observation generation

provided with established procedures for attending to this responsibility. This is a specific function, in addition to other maintenance and record-keeping functions, and includes the following:

- (a) Internal consistency checks of a complete synoptic or other compound observation: In practice, they are performed as a matter of course by an experienced observer, but they should nevertheless be an explicit requirement. Examples of this are the relations between the temperature, the dewpoint and the daily extremes, and between rain, cloud and weather;
- (b) Climatological checks: These for consistency: The observer knows, or is provided with charts or tables of, the normal seasonal ranges of variables at the station, and should not allow unusual values to go unchecked;
- (c) Temporal checks: These should be made to ensure that changes since the last observation are realistic, especially when the observations have been made by different observers;
- (d) Checks of all arithmetical and table look-up operations;
- (e) Checks of all messages and other records against the original data.

1.7.1.2 Automatic weather stations

At AWSs, some of the above checks should be performed by the software, as well as engineering checks on the performance of the system. These are discussed in Part II, Chapter 1.

1.7.2 Upper-air data

The procedures for controlling the quality of upper-air data are essentially the same as those for surface data. Checks should be made for internal consistency (such as lapse rates and shears), for climatological and temporal consistency, and for consistency with normal surface observations. For radiosonde operations, it is of the utmost importance that the baseline initial calibration be explicitly and deliberately checked. The message must also be checked against the observed data.

The automation of on-station quality control is particularly useful for upper-air data.

1.7.3 Data centres

Data should be checked in real time or as close to real time as possible, at the first and subsequent points where they are received or used. It is highly advisable to apply the same urgent

checks to all data, even to those that are not used in real time, because later quality control tends to be less effective. If available, automation should of course be used, but certain quality-control procedures are possible without computers, or with only partial assistance by computing facilities. The principle is that every message should be checked, preferably at each stage of the complete data chain.

The checks that have already been performed at stations are usually repeated at data centres, perhaps in more elaborate form by making use of automation. Data centres, however, usually have access to other network data, thus making a spatial check possible against observations from surrounding stations or against analysed or predicted fields. This is a very powerful method and is the distinctive contribution of a data centre.

If errors are found, the data should be either rejected or corrected by reference back to the source, or should be corrected at the data centre by inference. The last of these alternatives may evidently introduce further errors, but it is nevertheless valid in many circumstances; data so corrected should be flagged in the database and should be used only carefully.

The quality-control process produces data of established quality, which may then be used for real-time operations and for a databank. However, a by-product of this process should be the compilation of information about the errors that were found. It is good practice to establish at the first or subsequent data-processing point a system for immediate feedback to the origin of the data if errors are found, and to compile a record for use by the network manager in performance monitoring, as discussed below. This function is best performed at the regional level, where there is ready access to the field stations.

The detailed procedures described in WMO (1993*a*) are a guide to controlling the quality control of data for international exchange, under the recommendations of WMO (1992).

1.7.4 Interaction with field stations

If quality is to be maintained, it is absolutely essential that errors be tracked back to their source, with some kind of corrective action. For data from staffed stations this is very effectively done in near-real time, not only because the data may be corrected, but also to identify the reason for the error and prevent it from recurring.

It is good practice to assign a person at a data centre or other operational centre with the responsibility for maintaining near-real-time communication and effective working relations with the field stations, to be used whenever errors in the data are identified.

1.8 PERFORMANCE MONITORING

The management of a network, or of a station, is greatly strengthened by keeping continuous records of performance, typically on a daily and monthly schedule. The objective of performance monitoring is to review continually the quality of field stations and of each observing system, such as for pressure measurement, or the radiosonde network.

There are several aspects to performance monitoring, as follows:

- (a) Advice from data centres should be used to record the numbers and types of errors detected by quality-control procedures;
- (b) Data from each station should be compiled into synoptic and time-section sets. Such sets should be used to identify systematic differences from neighbouring stations, both in spatial fields and in comparative time series. It is useful to derive statistics of the mean and the scatter of the differences. Graphical methods are effective for these purposes;
- (c) Reports should be obtained from field stations about equipment faults, or other aspects of performance.

These types of records are very effective in identifying systematic faults in performance and in indicating corrective action. They are powerful indicators of many factors that affect the data, such as exposure or calibration changes, deteriorating equipment, changes in the quality of consumables or the need for retraining. They are particularly important for maintaining confidence in automatic equipment.

The results of performance monitoring should be used for feedback to the field stations, which is important to maintain motivation. The results also indicate when action is necessary to repair or upgrade the field equipment.

Performance monitoring is a time-consuming task, to which the network manager must allocate adequate resources. WMO (1988) describes a system to monitor data from an AWS network, using a small, dedicated office with staff monitoring real-time output and advising the network managers

and data users. Miller and Morone (1993) describe a system with similar functions, in near-real time, making use of a mesoscale numerical model for the spatial and temporal tests on the data.

1.9 DATA HOMOGENEITY AND METADATA

In the past, observational networks were primarily built to support weather forecasting activities. Operational quality control was focused mainly on identifying outliers, but rarely incorporated checks for data homogeneity and continuity of time series. The surge of interest in climate change, primarily as a result of concerns over increases in greenhouse gases, changed this situation. Data homogeneity tests have revealed that many of the apparent climate changes can be attributed to inhomogeneities in time series caused only by operational changes in observing systems. This section attempts to summarize these causes and presents some guidelines concerning the necessary information on data, namely, metadata, which should be made available to support data homogeneity and climate change investigations.

1.9.1 Causes of data inhomogeneities

Inhomogeneities caused by changes in the observing system appear as abrupt discontinuities, gradual changes, or changes in variability. Abrupt discontinuities mostly occur due to changes in instrumentation, siting and exposure changes, station relocation, changes in the calculation of averages, data reduction procedures and the application of new calibration corrections. Inhomogeneities that occur as a gradually increasing effect may arise from a change in the surroundings of the station, urbanization and gradual changes in instrumental characteristics. Changes in variability are caused by instrument malfunctions. Inhomogeneities are further due to changes in the time of observations, insufficient routine inspection, maintenance and calibration, and unsatisfactory observing procedures. On a network level, inhomogeneities can be caused by data incompatibilities. It is obvious that all factors affecting data quality also cause data inhomogeneities.

The historical survey of changes in radiosondes (WMO, 1993*b*) illustrates the seriousness of the problem and is a good example of the careful work that is necessary to eliminate it.

Changes in the surface-temperature record when manual stations are replaced by AWSs, and changes in the upper-air records when radiosondes are changed, are particularly significant cases of data inhomogeneities. These two cases are now well recognized and can, in principle, be anticipated and corrected, but performance monitoring can be used to confirm the effectiveness of corrections, or even to derive them.

1.9.2 Metadata

Data inhomogeneities should, as far as possible, be prevented by appropriate quality-assurance procedures with respect to quality control. However, this cannot always be accomplished as some causes of inhomogeneities, such as the replacement of a sensor, can represent real improvements in measuring techniques. It is important to have information on the occurrence, type and, especially, the time of all inhomogeneities that occur. After obtaining such information, climatologists can run appropriate statistical programs to link the previous data with the new data in homogeneous databases with a high degree of confidence. Information of this kind is commonly available in what is known as metadata — information on data — also called station histories. Without such information, many of the above-mentioned inhomogeneities may not be identified or corrected. Metadata can be considered as an extended version of the station administrative record, containing all possible information on the initial set-up, and type and times of changes that occurred during the life history of an observing system. As computer data management systems are an important aspect of quality data delivery, it is desirable that metadata should be available as a computer database enabling computerized composition, updating and use.

1.9.3 Elements of a metadata database

A metadata database contains initial set-up information together with updates whenever changes occur. Major elements include the following:

- (a) Network information:
The operating authority, and the type and purpose of the network;
- (b) Station information:
 - (i) Administrative information;
 - (ii) Location: geographical coordinates, elevation(s);³
 - (iii) Descriptions of remote and immediate surroundings and obstacles;³

- (iv) Instrument layout;³
- (v) Facilities: data transmission, power supply, cabling;
- (vi) Climatological description;

- (c) Individual instrument information:
 - (i) Type: manufacturer, model, serial number, operating principles;
 - (ii) Performance characteristics;
 - (iii) Calibration data and time;
 - (iv) Siting and exposure: location, shielding, height above ground;³
 - (v) Measuring or observing programme;
 - (vi) Times of observations;
 - (vii) Observer;
 - (viii) Data acquisition: sampling, averaging;
 - (ix) Data-processing methods and algorithms;
 - (x) Preventive and corrective maintenance;
 - (xi) Data quality (in the form of a flag or uncertainty).

1.9.4 Recommendations for a metadata system

The development of a metadata system requires considerable interdisciplinary organization, and its operation, particularly the scrupulous and accurately dated record of changes in the metadata base, requires constant attention.

A useful survey of requirements is given in WMO (1994), with examples of the effects of changes in observing operations and an explanation of the advantages of good metadata for obtaining a reliable climate record from discontinuous data. The basic functional elements of a system for maintaining a metadatabase may be summarized as follows:

- (a) Standard procedures must be established for collecting overlapping measurements for all significant changes made in instrumentation, observing practices and sensor siting;
- (b) Routine assessments must be made of ongoing calibration, maintenance, and homogeneity problems for the purpose of taking corrective action, when necessary;
- (c) There must be open communication between the data collector and the researcher to provide feedback mechanisms for recognizing data problems, the correction or at least the potential for problems, and the improvement of, or addition to, documentation to meet initially unforeseen user requirements (for example, work groups);
- (d) There must be detailed and readily available documentation on the procedures, rationale, testing, assumptions and known problems involved in the construction of the data set from the measurements.

³ It is necessary to include maps and plans on appropriate scales.

These four recommendations would have the effect of providing a data user with enough metadata to enable manipulation, amalgamation and summarization of the data with minimal assumptions regarding data quality and homogeneity.

1.10 NETWORK MANAGEMENT

All the factors affecting data quality described in section 1.6 are the subject of network management. In particular, network management must include corrective action in response to the network performance revealed by quality-control procedures and performance monitoring.

Networks are defined in WMO (2003), and guidance on network management in general terms is given in WMO (1989), including the structure and functions of a network management unit. Network management practices vary widely according to locally established administrative arrangements.

It is highly desirable to identify a particular person or office as the network manager to whom operational responsibility is assigned for the impact of the various factors on data quality. Other specialists who may be responsible for the management and implementation of some of these factors must collaborate with the network manager and accept responsibility for their effect on data quality.

The manager should keep under review the procedures and outcomes associated with all of the factors affecting quality, as discussed in section 1.6, including the following considerations:

- (a) The quality-control systems described in section 1.1 are operationally essential in any meteorological network and should receive priority attention by the data users and by the network management;
- (b) Performance monitoring is commonly accepted as a network management function. It may be expected to indicate the need for action on the effects of exposure, calibration and maintenance. It also provides information on the effects of some of the other factors;
- (c) Field station inspection described below, is a network management function;
- (d) Equipment maintenance may be a direct function of the network management unit. If not, there should be particularly effective collaboration between the network manager and the office responsible for the equipment;

- (e) The administrative arrangements should enable the network manager to take, or arrange for, corrective action arising from quality-control procedures, performance monitoring, the inspection programme, or any other factor affecting quality. One of the most important other factors is observer training, as described in Part III, Chapter 5, and the network manager should be able to influence the content and conduct of courses and how they are conducted or the prescribed training requirements.

1.10.1 Inspections

Field stations should be inspected regularly, preferably by specially appointed, experienced inspectors. The objectives are to examine and maintain the work of the observers, the equipment and instrument exposure, and also to enhance the value of the data by recording the station history. At the same time, various administrative functions, which are particularly important for staffed stations, can be performed. The same principles apply to staffed stations, stations operated by part-time, voluntary or contract observers and, to a certain degree, to AWSs. Requirements for inspections are laid down in WMO (2003), and advice is given in WMO (1989).

Inspections reports are part of the performance monitoring record.

It is highly advisable to have a systematic and exhaustive procedure fully documented in the form of inspections and maintenance handbooks, to be used by the visiting inspectors. Procedures should include the details of subsequent reporting and follow-up.

The inspector should attend, in particular, to the following aspects of station operations:

- (a) *Instrument performance*: Instruments requiring calibration must be checked against a suitable standard. Atmospheric pressure is the prime case, as all field barometers can drift to some degree. Mechanical and electrical recording systems must be checked according to established procedures. More complex equipment such as AWSs and radars need various physical and electrical checks. Anemometers and thermometer shelters are particularly prone to deterioration of various kinds, which may vitiate the data. The physical condition of all equipment should be examined for dirt, corrosion and so on;

- (b) *Observing methods*: Bad practice can easily occur in observing procedures, and the work of all observers should be continually reviewed. Uniformity in methods recording and coding is essential for synoptic and climatological use of the data;
- (c) *Exposure*: Any changes in the surroundings of the station must be documented and corrected in due course, if practicable. Relocation may be necessary.

Inspections of manual stations also serve the purpose of maintaining the interest and enthusiasm of the observers. The inspector must be tactful, informative, enthusiastic and able to obtain willing cooperation.

A prepared form for recording the inspection should be completed for every inspection. It should include a checklist on the condition and installation of the equipment and on the ability and competence of the observers. The inspection form may also be used for other administrative purposes, such as an inventory.

It is most important that all changes identified during the inspection should be permanently recorded and dated so that a station history can be compiled for subsequent use for climate studies and other purposes.

An optimum frequency of inspection visits cannot be generally specified, even for one particular type of station. It depends on the quality of the observers and equipment, the rate at which the equipment and exposure deteriorates, and changes in the station staff and facilities. An inspection interval of two years may be acceptable for a well-established station, and six months may be appropriate for automatic stations. Some kinds of stations will have special inspection requirements.

Some equipment maintenance may be performed by the inspector or by the inspection team, depending on the skills available. In general, there should be an equipment maintenance programme, as is the case for inspections. This is not discussed here because the requirements and possible organizations are very diverse.

REFERENCES AND FURTHER READING

- Deming, W.E., 1986: *Out of the Crisis: Quality, Productivity and Competitive Position*. University of Cambridge Press, Cambridge.
- International Organization for Standardization, 2005: *Quality management systems – Fundamentals and vocabulary*. ISO 9000:2005.
- International Organization for Standardization, 2000: *Quality management systems – Requirements*. ISO 9001:2000.
- International Organization for Standardization, 2000: *Quality management systems – Guidelines for performance improvements*. ISO 9004:2000.
- International Organization for Standardization, 2002: *Guidelines for quality and/or environmental management systems auditing*. ISO 19011:2002.
- International Organization for Standardization International Electrotechnical Commission, 2005: *General requirements for the competence of testing and calibration laboratories*. ISO/IEC 17025:2005.
- International Organization for Standardization International Electrotechnical Commission, 2005: *Information technology – Service management – Part 1: Specification*. ISO/IEC 20000-1:2005.
- International Organization for Standardization: *Information technology – Service management – Part 2: Code of practice*, ISO/IEC 20000-2:2005-12, Geneva
- Kaplan, R.S., D.P. Norton, 1996: *The Balanced Scorecard: Translating Strategy into Action*. Harvard Business School Press, Boston.
- Miller, P.A. and L.L. Morone, 1993: Real-time quality control of hourly reports from the automated surface observing system. *Preprints of the Eighth Symposium on Meteorological Observations and Instrumentation*. American Meteorological Society, Boston, pp. 373-38.
- World Meteorological Organization, 1988: Practical experience of the operation of quality evaluation programmes for automated surface observations both on land and over the sea (M. Field and J. Nash). *Papers Presented at the WMO Technical Conference on Instruments and Methods of Observation (TECO-1988)*. Instruments and Observing Methods Report No. 33, WMO/TD-No. 222, Geneva, pp. 335-340.
- World Meteorological Organization, 1989: *Guide on the Global Observing and forecasting System*. WMO-No. 488, Geneva.
- World Meteorological Organization, 1992: *Manual on the Global Data-processing System*. WMO-No. 485, Geneva.
- World Meteorological Organization, 1993a: *Guide on the Global Data-Processing System*. WMO-No. 305, Geneva.
- World Meteorological Organization, 1993b: *Historical Changes in Radiosonde Instruments and Practices* (D.J. Gaffen). Instruments and Observing Methods Report No. 50, WMO/TD-No. 541, Geneva.
- World Meteorological Organization, 1994: Homogeneity of data and the climate record (K.D. Hadeen and N.B. Guttman). *Papers Presented at the WMO Technical Conference on Instruments and Methods of Observation (TECO-94)*, Instruments and Observing Methods Report No. 57, WMO/TD-No. 588, Geneva, pp. 3–11.
- World Meteorological Organization, 2003: *Manual on the Global Observing System*. Volume I, WMO-No. 544, Geneva.
- World Meteorological Organization, 2005a: *Quality Management Framework (QMF)*. First WMO Technical Report (revised edition), WMO/TD-No. 1268.
- World Meteorological Organization, 2005b: *Guidelines on Quality Management Procedures and Practices for Public Weather Services*. PWS-11, WMO/TD No. 1256, Geneva.
-

CHAPTER 2

SAMPLING METEOROLOGICAL VARIABLES

2.1 GENERAL

The purpose of this chapter is to give an introduction to this complex subject, for non-experts who need enough knowledge to develop a general understanding of the issues and to acquire a perspective of the importance of the techniques.

Atmospheric variables such as wind speed, temperature, pressure and humidity are functions of four dimensions – two horizontal, one vertical, and one temporal. They vary irregularly in all four, and the purpose of the study of sampling is to define practical measurement procedures to obtain representative observations with acceptable uncertainties in the estimations of mean and variability.

Discussion of sampling in the horizontal dimensions includes the topic of areal representativeness, which is discussed in Part I, Chapter 1, in other chapters on measurements of particular quantities, and briefly below. It also includes the topics of network design, which is a special study related to numerical analysis, and of measurements of area-integrated quantities using radar and satellites; neither of these is discussed here. Sampling in the vertical is briefly discussed in Part I, Chapters 12 and 13 and Part II, Chapter 5. This chapter is therefore concerned only with sampling in time, except for some general comments about representativeness.

The topic can be addressed at two levels as follows:

- (a) At an elementary level, the basic meteorological problem of obtaining a mean value of a fluctuating quantity representative of a stated sampling interval at a given time, using instrument systems with long response times compared with the fluctuations, can be discussed. At the simplest level, this involves consideration of the statistics of a set of measurements, and of the response time of instruments and electronic circuits;
- (b) The problem can be considered more precisely by making use of the theory of time-series analysis, the concept of the spectrum of fluctuations, and the behaviour of filters. These topics are necessary for the more complex problem of using relatively fast-response instruments to obtain satisfactory measurements of the mean or the spectrum

of a rapidly varying quantity, wind being the prime example.

It is therefore convenient to begin with a discussion of time series, spectra and filters in sections 2.2 and 2.3. Section 2.4 gives practical advice on sampling. The discussion here, for the most part, assumes digital techniques and automatic processing.

It is important to recognize that an atmospheric variable is actually never sampled. It is only possible to come as close as possible to sampling the output of a sensor of that variable. The distinction is important because sensors do not create an exact analogue of the sensed variable. In general, sensors respond more slowly than the atmosphere changes, and they add noise. Sensors also do other, usually undesirable, things such as drift in calibration, respond non-linearly, interfere with the quantity that they are measuring, fail more often than intended, and so on, but this discussion will only be concerned with response and the addition of noise.

There are many textbooks available to give the necessary background for the design of sampling systems or the study of sampled data. See, for example, Bendat and Piersol (1986) or Otnes and Enochson (1978). Other useful texts include Pasquill and Smith (1983), Stearns and Hush (1990), Kulhánek (1976), and Jenkins and Watts (1968).

2.1.1 Definitions

For the purposes of this chapter the following definitions are used:

Sampling is the process of obtaining a discrete sequence of measurements of a quantity.

A *sample* is a single measurement, typically one of a series of spot readings of a sensor system. Note that this differs from the usual meaning in statistics of a set of numbers or measurements which is part of a population.

An *observation* is the result of the sampling process, being the quantity reported or recorded (often also called a measurement). In the context of time-series analysis, an observation is derived from a number of samples.

The ISO definition of a *measurement* is a “set of operations having the object of determining the value of a quantity”. In common usage, the term may be used to mean the value of either a sample or an observation.

The *sampling time* or *observation period* is the length of the time over which one observation is made, during which a number of individual samples are taken.

The *sampling interval* is the time between successive observations.

The *sampling function* or *weighting function* is, in its simplest definition, an algorithm for averaging or filtering the individual samples.

The *sampling frequency* is the frequency at which samples are taken. The *sample spacing* is the time between samples.

Smoothing is the process of attenuating the high frequency components of the spectrum without significantly affecting the lower frequencies. This is usually done to remove noise (random errors and fluctuations not relevant for the application).

A *filter* is a device for attenuating or selecting any chosen frequencies. Smoothing is performed by a *low-pass* filter, and the terms *smoothing* and *filtering* are often used interchangeably in this sense. However, there are also *high-pass* and *band-pass* filters. Filtering may be a property of the instrument, such as inertia, or it may be performed electronically or numerically.

2.1.2 Representativeness in time and space

Sampled observations are made at a limited rate and for a limited time interval over a limited area. In practice, observations should be designed to be sufficiently frequent to be representative of the unsampled parts of the (continuous) variable, and are often taken as being representative of a longer time interval and larger area.

The user of an observation expects it to be representative, or typical, of an area and time, and of an interval of time. This area, for example, may be “the airport” or that area within a radius of several kilometres and within easy view of a human observer. The time is the time at which the report was made or the message transmitted, and the interval is an agreed quantity, often 1, 2 or 10 min.

To make observations representative, sensors are exposed at standard heights and at unobstructed locations and samples are processed to obtain mean values. In a few cases, sensors, for example transmissometers, inherently average spatially, and this contributes to the representativeness of the observation. The human observation of visibility is another example of this. However, the remaining discussion in this chapter will ignore spatial sampling and concentrate upon time sampling of measurements taken at a point.

A typical example of sampling and time averaging is the measurement of temperature each minute (the samples), the computation of a 10 min average (the sampling interval and the sampling function), and the transmission of this average (the observation) in a synoptic report every 3 h. When these observations are collected over a period from the same site, they themselves become samples in a new time sequence with a 3 h spacing. When collected from a large number of sites, these observations also become samples in a spatial sequence. In this sense, representative observations are also representative samples. In this chapter we discuss the initial observation.

2.1.3 The spectra of atmospheric quantities

By applying the mathematical operation known as the Fourier transform, an irregular function of time (or distance) can be reduced to its spectrum, which is the sum of a large number of sinusoids, each with its own amplitude, wavelength (or period or frequency) and phase. In broad contexts, these wavelengths (or frequencies) define “scales” or “scales of motion” of the atmosphere.

The range of these scales is limited in the atmosphere. At one end of the spectrum, horizontal scales cannot exceed the circumference of the Earth or about 40 000 km. For meteorological purposes, vertical scales do not exceed a few tens of kilometres. In the time dimension, however, the longest scales are climatological and, in principle, unbounded, but in practice the longest period does not exceed the length of records. At the short end, the viscous dissipation of turbulent energy into heat sets a lower bound. Close to the surface of the Earth, this bound is at a wavelength of a few centimetres and increases with height to a few metres in the stratosphere. In the time dimension, these wavelengths correspond to frequencies of tens of hertz. It is correct to say that atmospheric variables are bandwidth limited.

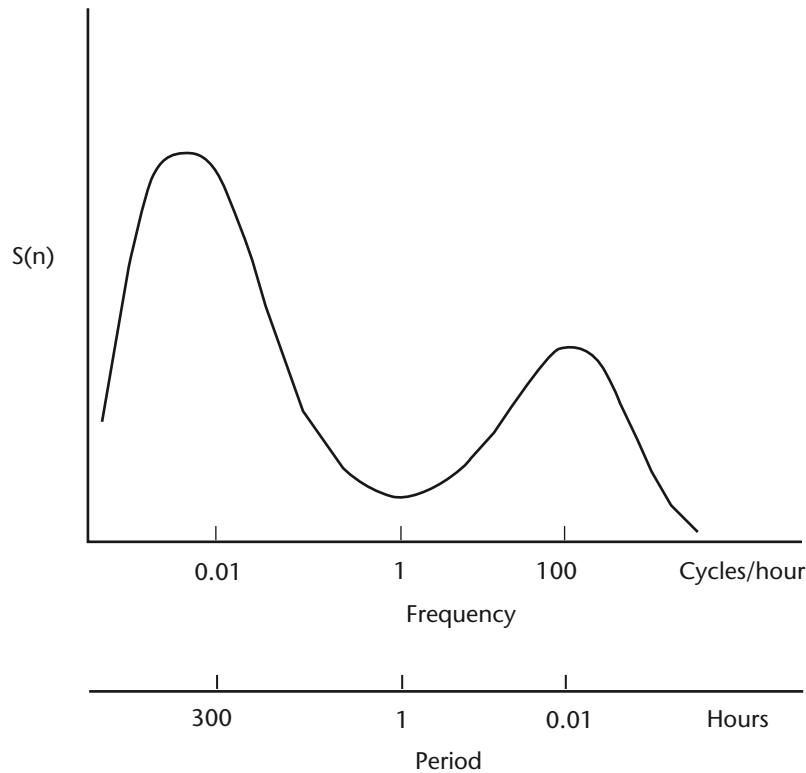

Figure 2.1. A typical spectrum of a meteorological quantity

Figure 2.1 is a schematic representation of a spectrum of a meteorological quantity such as wind, notionally measured at a particular station and time. The ordinate, commonly called energy or spectral density, is related to the variance of the fluctuations of wind at each frequency n . The spectrum in Figure 2.1 has a minimum of energy at the mesoscale around one cycle per hour, between peaks in the synoptic scale around one cycle per four days, and in the microscale around one cycle per minute. The smallest wavelengths are a few centimetres and the largest frequencies are tens of hertz.

2.2 TIME SERIES, POWER SPECTRA AND FILTERS

This section is a layperson's introduction to the concepts of time-series analysis which are the basis for good practice in sampling. In the context of this Guide, they are particularly important for the measurement of wind, but the same problems arise for temperature, pressure and other quantities. They became important for routine meteorological measurements when automatic measurements were introduced, because frequent fast sampling then became possible. Serious errors can occur in the

estimates of the mean, the extremes and the spectrum if systems are not designed correctly.

Although measurements of spectra are non-routine, they have many applications. The spectrum of wind is important in engineering, atmospheric dispersion, diffusion and dynamics. The concepts discussed here are also used for quantitative analysis of satellite data (in the horizontal space dimension) and in climatology and micro-meteorology.

In summary, the argument is as follows:

- (a) An optimum sampling rate can be assessed from consideration of the variability of the quantity being measured. Estimates of the mean and other statistics of the observations will have smaller uncertainties with higher sampling frequencies, namely, larger samples;
- (b) The Nyquist theorem states that a continuous fluctuating quantity can be precisely determined by a series of equispaced samples if they are sufficiently close together;
- (c) If the sampling frequency is too low, fluctuations at the higher unsampled frequencies (above the Nyquist frequency, defined in section 2.2.1) will affect the estimate of the mean value. They will also affect the computation of the lower frequencies, and

the measured spectrum will be incorrect. This is known as aliasing. It can cause serious errors if it is not understood and allowed for in the system design;

- (d) Aliasing may be avoided by using a high sampling frequency or by filtering so that a lower, more convenient sampling frequency can be used;
- (e) Filters may be digital or analogue. A sensor with a suitably long response time acts as a filter.

A full understanding of sampling involves knowledge of power spectra, the Nyquist theorem, filtering and instrument response. This is a highly specialized subject, requiring understanding of the characteristics of the sensors used, the way the output of the sensors is conditioned, processed and logged, the physical properties of the elements being measured, and the purpose to which the analysed data are to be put. This, in turn, may require expertise in the physics of the instruments, the theory of electronic or other systems used in conditioning and logging processes, mathematics, statistics and the meteorology of the phenomena, all of which are well beyond the scope of this chapter.

However, it is possible for a non-expert to understand the principles of good practice in measuring means and extremes, and to appreciate the problems associated with measurements of spectra.

2.2.1 Time-series analysis

It is necessary to consider signals as being either in the time or the frequency domain. The fundamental idea behind spectral analysis is the concept of Fourier transforms. A function, $f(t)$, defined between $t = 0$ and $t = \tau$ can be transformed into the sum of a set of sinusoidal functions:

$$f(t) = \sum_{j=0}^{\infty} [A_j \sin(j\omega t) + B_j \cos(j\omega t)] \quad (2.1)$$

where $\omega = 2\pi/\tau$. The right-hand side of the equation is a Fourier series. A_j and B_j are the amplitudes of the contributions of the components at frequencies $n_j = j\omega$. This is the basic transformation between the time and frequency domains. The Fourier coefficients A_j and B_j relate directly to the frequency $j\omega$ and can be associated with the spectral contributions to $f(t)$ at these frequencies. If the frequency response of an instrument is known – that is, the way in which it amplifies or attenuates certain frequencies – and if it is also known how these frequencies contribute to the original signal, the effect of the frequency response on the output signal can be calculated. The contribution of each

frequency is characterized by two parameters. These can be most conveniently taken as the amplitude and phase of the frequency component. Thus, if equation 2.1 is expressed in its alternative form:

$$f(t) = \sum_{j=0}^{\infty} \alpha_j \sin(j\omega t + \phi_j) \quad (2.2)$$

the amplitude and phase associated with each spectral contribution are α_j and ϕ_j . Both can be affected in sampling and processing.

So far, it has been assumed that the function $f(t)$ is known continuously throughout its range $t=0$ to $t=\tau$. In fact, in most examples this is not the case; the meteorological variable is measured at discrete points in a time series, which is a series of N samples equally spaced Δt apart during a specified period $\tau=(N-1)\Delta t$. The samples are assumed to be taken instantaneously, an assumption which is strictly not true, as all measuring devices require some time to determine the value they are measuring. In most cases, this is short compared with the sample spacing Δt . Even if it is not, the response time of the measuring system can be accommodated in the analysis, although that will not be addressed here.

When considering the data that would be obtained by sampling a sinusoidal function at times Δt apart, it can be seen that the highest frequency that can be detected is $1/(2\Delta t)$, and that in fact any higher frequency sinusoid that may be present in the time series is represented in the data as having a lower frequency. The frequency $1/(2\Delta t)$ is called the Nyquist frequency, designated here as n_y . The Nyquist frequency is sometimes called the folding frequency. This terminology comes from consideration of aliasing of the data. The concept is shown schematically in Figure 2.2. When a spectral analysis of a time series is made, because of the discrete nature of the data, the contribution to the estimate at frequency n also contains contributions from higher frequencies, namely from $2jn_y \pm n$ ($j = 1$ to ∞). One way of visualizing this is to consider the frequency domain as if it were folded, in a concertina-like way, at $n = 0$ and $n = n_y$ and so on in steps of n_y . The spectral estimate at each frequency in the range is the sum of all the contributions of those higher frequencies that overlie it.

The practical effects of aliasing are discussed in section 2.4.2. It is potentially a serious problem and should be considered when designing instrument systems. It can be avoided by minimizing, or reducing to zero, the strength of the signal at frequencies above n_y . There are a couple of ways of achieving this. First, the system can contain a low-pass filter that

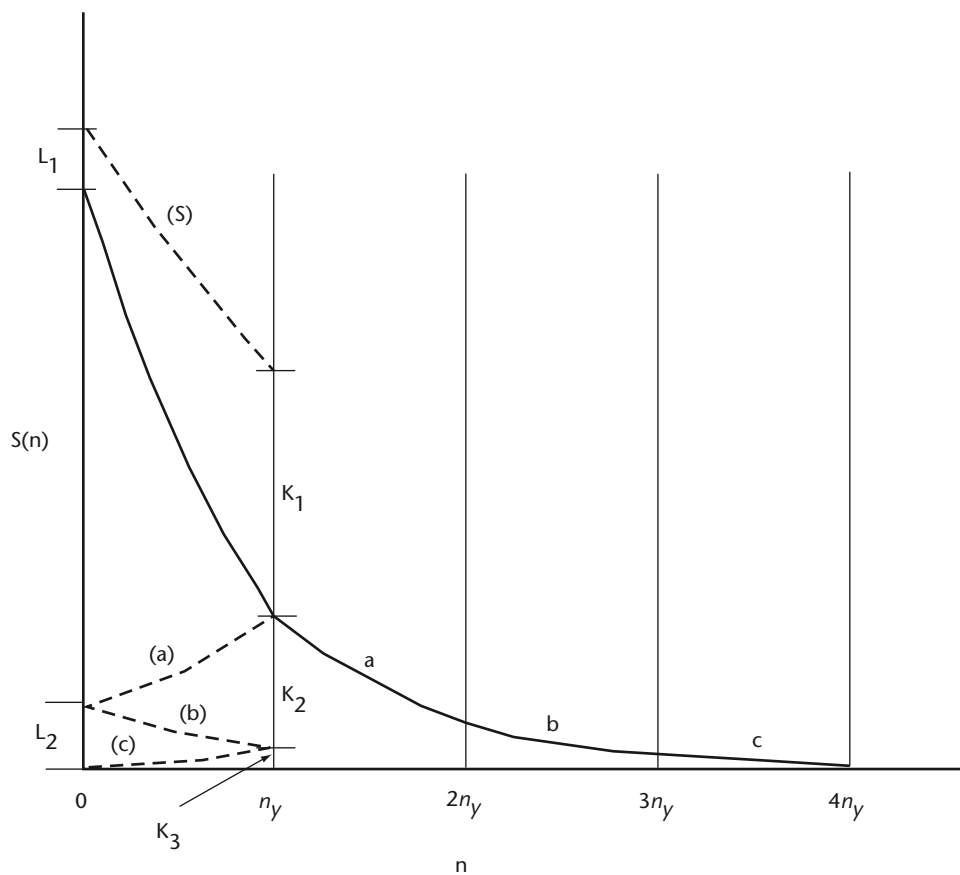

Figure 2.2. A schematic illustration of aliasing a spectrum computed from a stationary time series. The spectrum can be calculated only over the frequency range zero to the Nyquist frequency n_y . The true values of the energies at higher frequencies are shown by the sectors marked a, b and c. These are "folded" back to the $n = 0$ to n_y sector as shown by the broken lines (a), (b), (c). The computed spectrum, shown by the bold broken line (S), includes the sum of these.

attenuates contributions at frequencies higher than n_y , before the signal is digitized. The only disadvantage of this approach is that the timing and magnitude of rapid changes will not be recorded well, or even at all. The second approach is to have Δt small enough so that the contributions above the Nyquist frequency are insignificant. This is possible because the spectra of most meteorological variables fall off very rapidly at very high frequencies. This second approach will, however, not always be practicable, as in the example of three-hourly temperature measurements, where if Δt is of the order of hours, small scale fluctuations, of the order of minutes or seconds, may have relatively large spectral ordinates and alias strongly. In this case, the first method may be appropriate.

2.2.2 Measurement of spectra

The spectral density, at least as it is estimated from a time series, is defined as:

$$S(n_j) = (A_j^2 + B_j^2) / n_y = \alpha_j^2 / n_y \quad (2.3)$$

It will be noted that phase is not relevant in this case.

The spectrum of a fluctuating quantity can be measured in a number of ways. In electrical engineering it was often determined in the past by passing the signal through band-pass filters and by measuring the power output. This was then related to the power of the central frequency of the filter.

There are a number of ways of approaching the numerical spectral analysis of a time series. The most obvious is a direct Fourier transform of the time-series. In this case, as the series is only of finite length, there will be only a finite number of frequency components in the transformation. If there are N terms in the time-series, there will be $N/2$ frequencies resulting from this analysis. A direct calculation is very laborious, and other methods have been developed. The first development was by Blackman and Tukey (1958), who related the auto-correlation function to estimates of various

spectral functions. (The auto-correlation function $r(t)$ is the correlation coefficient calculated between terms in the time-series separated by a time interval t). This was appropriate for the low-powered computing facilities of the 1950s and 1960s, but it has now been generally superseded by the so-called fast Fourier transform (FFT), which takes advantage of the general properties of a digital computer to greatly accelerate the calculations. The main limitation of the method is that the time-series must contain 2^k terms, where k is an integer. In general, this is not a serious problem, as in most instances there are sufficient data to conveniently organize the series to such a length. Alternatively, some FFT computer programs can use an arbitrary number of terms and add synthetic data to make them up to 2^k .

As the time series is of finite duration (N terms), it represents only a sample of the signal of interest. Thus, the Fourier coefficients are only an estimate of the true, or population, value. To improve reliability, it is common practice to average a number of terms each side of a particular frequency and to assign this average to the value of that frequency. The confidence interval of the estimate is thereby shrunk. As a rule of thumb, 30° of freedom is suggested as a satisfactory number for practical purposes. Therefore, as each estimate made during the

Fourier transform has 2° of freedom (associated with the coefficients of the sine and cosine terms), about 15 terms are usually averaged. Note that 16 is a better number if an FFT approach is used as this is 2^4 and there are then exactly $2(k/2)^{-4}$ spectral estimates; for example, if there are 1 024 terms in the time series, there will be 512 estimates of the A s and B s, and 64 smoothed estimates.

Increasingly, the use of the above analyses is an integral part of meteorological systems and relevant not only to the analysis of data. The exact form of spectra encountered in meteorology can show a wide range of shapes. As can be imagined, the contributions can be from the lowest frequencies associated with climate change through annual and seasonal contributions through synoptic events with periods of days, to diurnal and semi-diurnal contributions and local mesoscale events down to turbulence and molecular variations. For most meteorological applications, including synoptic analysis, the interest is in the range minutes to seconds. The spectrum at these frequencies will typically decrease very rapidly with frequency. For periods of less than 1 min, the spectrum often takes values proportional to $n^{-5/3}$. Thus, there is often relatively little contribution from frequencies greater than 1 Hz.

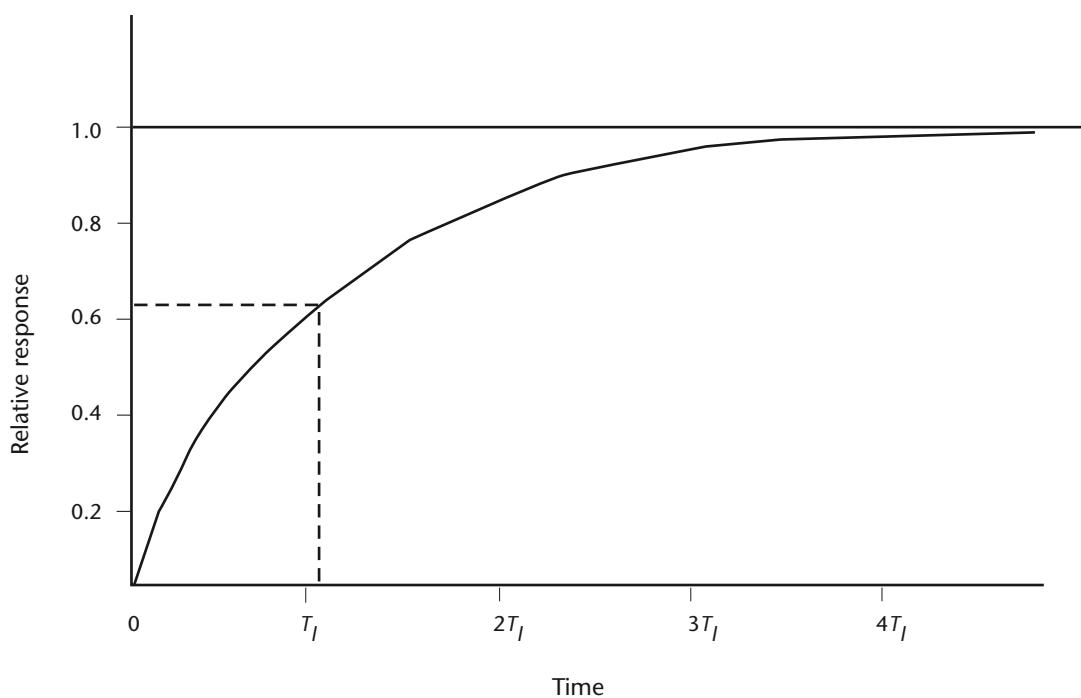

Figure 2.3. The response of a first order system to a step function. At time $T_{(l)}$ the system has reached 63 per cent of its final value.

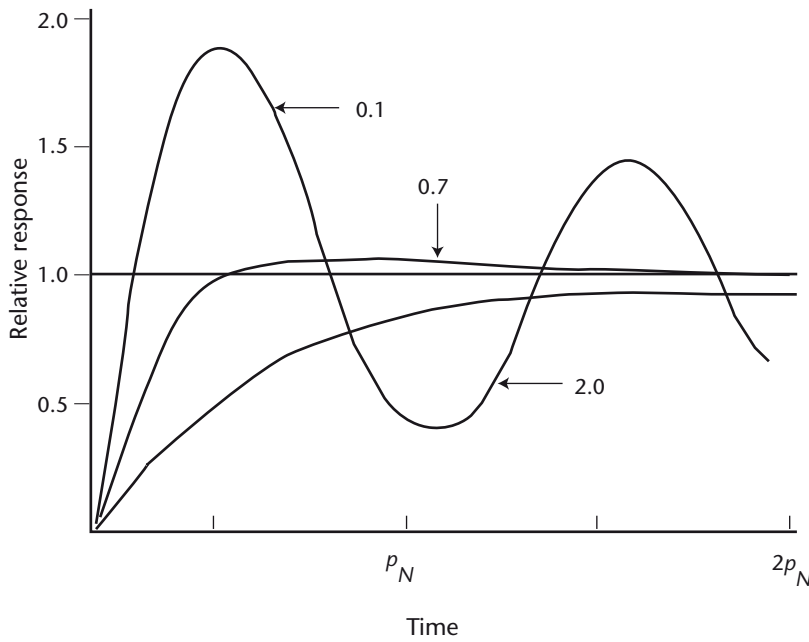

Figure 2.4. The response of a second order system to a step function. p_N is the natural period, related to k_1 in equation 2.7, which, for a wind vane, depends on wind speed. The curves shown are for damping factors with values 0.1 (very lightly damped), 0.7 (critically damped, optimum for most purposes) and 2.0 (heavily damped). The damping factor is related to k_2 in equation 2.7.

$$\sum_{j=0}^{\infty} S(n_j) = \sigma^2 \tag{2.4}$$

One of the important properties of the spectrum is that:

where σ^2 is the variance of the quantity being measured. It is often convenient, for analysis, to express the spectrum in continuous form, so that equation 2.4 becomes:

$$\int_0^{\infty} S(n) dn = \sigma^2 \tag{2.5}$$

It can be seen from equations 2.4 and 2.5 that changes caused to the spectrum, say by the instrument system, will alter the value of σ^2 and hence the statistical properties of the output relative to the input. This can be an important consideration in instrument design and data analysis.

Note also that the left-hand side of equation 2.5 is the area under the curve in Figure 2.2. That area, and therefore the variance, is not changed by aliasing if the time series is stationary, that is if its spectrum does not change from time to time.

2.2.3 Instrument system response

Sensors, and the electronic circuits that may be used with them comprising an instrument system, have response times and filtering characteristics that affect the observations.

No meteorological instrument system, or any instrumental system for that matter, precisely follows the quantity it is measuring. There is, in general, no simple way of describing the response of a system, although there are some reasonable approximations to them. The simplest can be classified as first and second order responses. This refers to the order of the differential equation that is used to approximate the way the system responds. For a detailed examination of the concepts that follow, there are many references in physics textbooks and the literature (see MacCready and Jex, 1964).

In the first order system, such as a simple sensor or the simplest low-pass filter circuit, the rate of change of the value recorded by the instrument is directly proportional to the difference between the value registered by the instrument and the true value of the variable. Thus, if the true value at time t is $s(t)$ and the value measured by the sensor

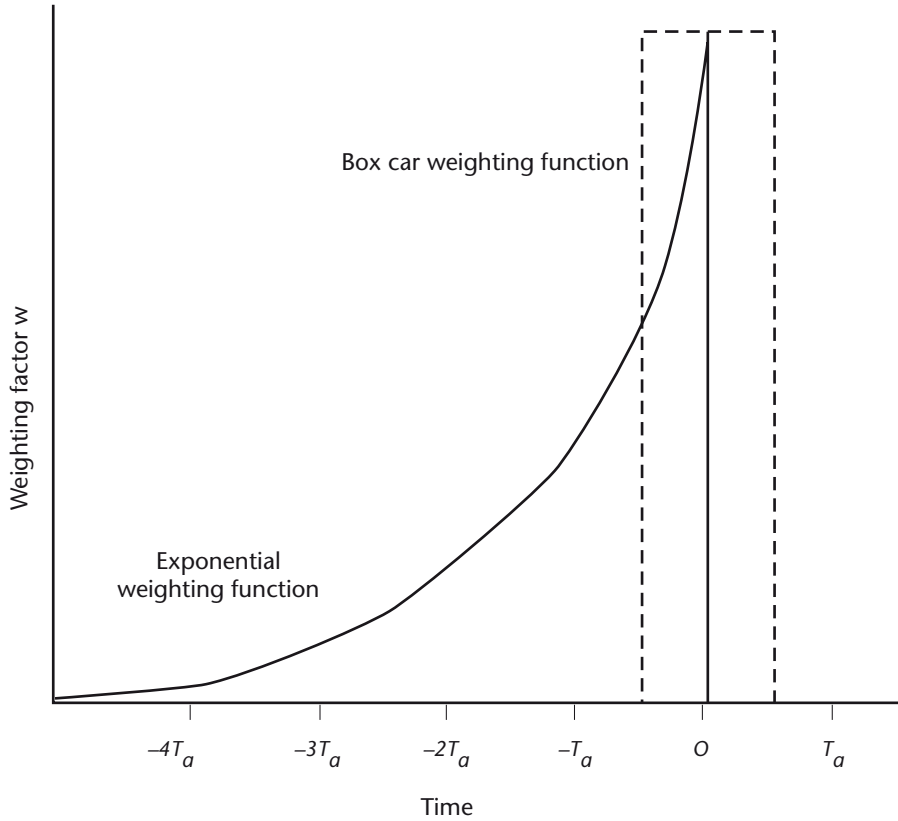

Figure 2.5. The weighting factors for a first order (exponential) weighting function and a box car weighting function. For the box car T_a is T_s , the sampling time, and $w = 1/N$. For the first order function T_a is T_f , the time constant of the filter, and $w(t) = (1/T_f) \exp(-t/T_f)$.

is $s_0(t)$, the system is described by the first order differential equation:

$$\frac{ds_0(t)}{dt} = \frac{s(t) - s_0(t)}{T_f} \quad (2.6)$$

where T_f is a constant with the dimension of time, characteristic of the system. A first order system's response to a step function is proportional to $\exp(-t/T_f)$, and T_f is observable as the time taken, after a step change, for the system to reach 63 per cent of the final steady reading. Equation 2.6 is valid for many sensors, such as thermometers.

A cup anemometer is a first order instrument, with the special property that T_f is not constant. It varies with wind speed. In fact, the parameter $s_0 T_f$ is called the distance constant, because it is nearly constant. As can be seen in this case, equation 2.6 is no longer a simple first order equation as it is now non-linear and consequently presents considerable problems in its solution. A further problem is that T_f also depends on whether the cups are speeding up or slowing down; that is, whether the right-hand side is positive or negative. This arises because the drag

coefficient of a cup is lower if the air-flow is towards the front rather than towards the back.

The wind vane approximates a second order system because the acceleration of the vane toward the true wind direction is proportional to the displacement of the vane from the true direction. This is, of course, the classical description of an oscillator (for example, a pendulum). Vanes, both naturally and by design, are damped. This occurs because of a resistive force proportional to, and opposed to, its rate of change. Thus, the differential equation describing the vane's action is:

$$\frac{d^2 \phi_0(t)}{dt^2} = k_1 [\phi_0(t) - \phi(t)] - k_2 \frac{d\phi_0(t)}{dt} \quad (2.7)$$

where ϕ is the true wind direction; ϕ_0 is the direction of the wind vane; and k_1 and k_2 are constants. The solution to this is a damped oscillation at the natural frequency of the vane (determined by the constant k_1). The damping of course is very important; it is controlled by the constant k_2 . If it is too small, the vane will simply oscillate at the natural frequency; if too great, the vane will not respond to changes in wind direction.

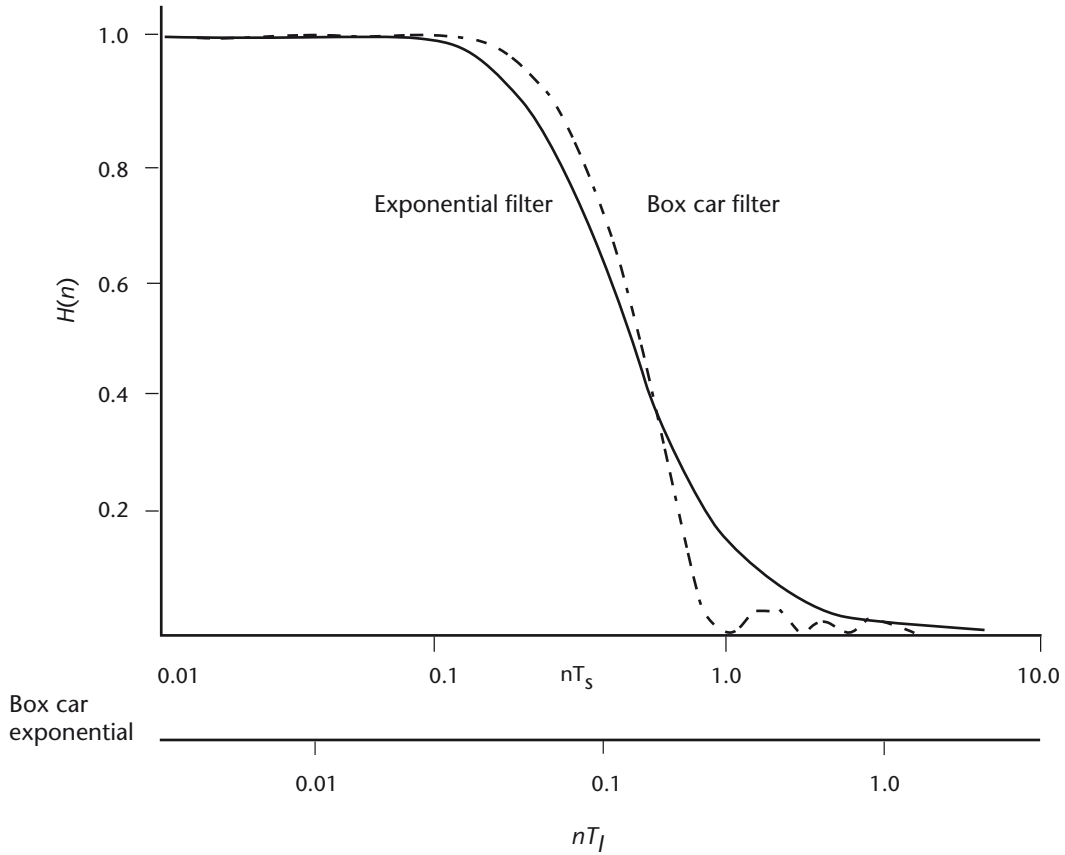

Figure 2.6. Frequency response functions for a first order (exponential) weighting function and a box car weighting function. The frequency is normalized for the first order filter by T_l , the time constant, and for the box car filter by T_s , the sampling time.

It is instructive to consider how these two systems respond to a step change in their input, as this is an example of the way in which the instruments respond in the real world. Equations 2.6 and 2.7 can be solved analytically for this input. The responses are shown in Figures 2.3 and 2.4. Note how in neither case is the real value of the element measured by the system. Also, the choice of the values of the constants k_1 and k_2 can have great effect on the outputs.

An important property of an instrument system is its frequency response function or transfer function $H(n)$. This function gives the amount of the spectrum that is transmitted by the system. It can be defined as:

$$S(n)_{out} = H(n) S(n)_{in} \quad (2.8)$$

where the subscripts refer to the input and output spectra. Note that, by virtue of the relationship in equation 2.5, the variance of the output depends on $H(n)$. $H(n)$ defines the effect of the sensor as a filter, as discussed in the next section. The ways in

which it can be calculated or measured are discussed in section 2.3.

2.2.4 Filters

This section discusses the properties of filters, with examples of the ways in which they can affect the data.

Filtering is the processing of a time series (either continuous or discrete, namely, sampled) in such a way that the value assigned at a given time is weighted by the values that occurred at other times. In most cases, these times will be adjacent to the given time. For example, in a discrete time series of N samples numbered 0 to N , with value y_i , the value of the filtered observation \bar{y}_i might be defined as:

$$\bar{y}_i = \sum_{j=-m}^m w_j y_{i+j} \quad (2.9)$$

Here there are $2m + 1$ terms in the filter, numbered by the dummy variable j from $-m$ to $+m$, and \bar{y}_i is centred at $j = 0$. Some data are rejected at the

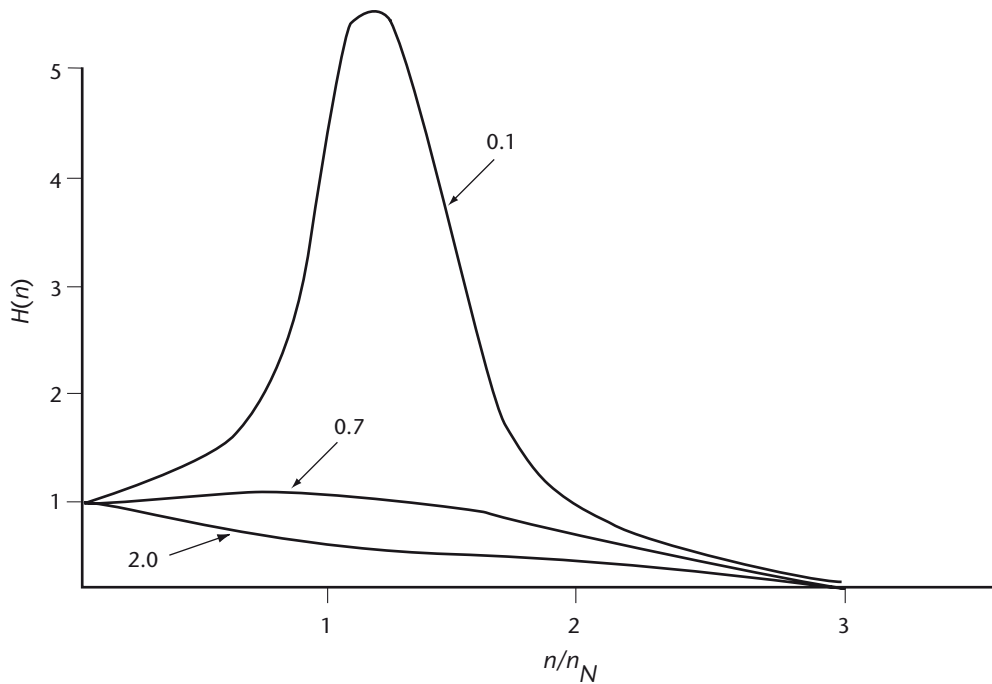

Figure 2.7. Frequency response functions for a second order system, such as a wind vane. The frequency is normalized by n_{Nv} , the natural frequency, which depends on wind speed. The curves shown are for damping factors with values 0.1 (very lightly damped), 0.7 (critically damped, optimum for most purposes) and 2.0 (heavily damped).

beginning and end of the sampling time. w_j is commonly referred to as a weighting function and typically:

$$\sum_{j=-m}^m w_j = 1 \tag{2.10}$$

so that at least the average value of the filtered series will have the same value as the original one.

The above example uses digital filtering. Similar effects can be obtained using electronics (for example, through a resistor and capacitor circuit) or through the characteristics of the sensor (for example, as in the case of the anemometer, discussed earlier). Whether digital or analogue, a filter is characterized by $H(n)$. If digital, $H(n)$ can be calculated; if analogue, it can be obtained by the methods described in section 2.3.

For example, compare a first order system with a response time of T_f , and a “box car” filter of length T_s on a discrete time series taken from a sensor with much faster response. The forms of these two filters are shown in Figure 2.5. In the first, it is as though the instrument has a memory which is strongest at the present instant, but falls off exponentially the further in the past the data goes. The box car filter has all weights of equal

magnitude for the period T_s , and zero beyond that. The frequency response functions, $H(n)$, for these two are shown in Figure 2.6.

In the figure, the frequencies have been scaled to show the similarity of the two response functions. It shows that an instrument with a response time of, say, 1 s has approximately the same effect on an input as a box car filter applied over 4 s. However, it should be noted that a box car filter, which is computed numerically, does not behave simply. It does not remove all the higher frequencies beyond the Nyquist frequency, and can only be used validly if the spectrum falls off rapidly above n_y . Note that the box car filter shown in Figure 2.6 is an analytical solution for w as a continuous function; if the number of samples in the filter is small, the cut-off is less sharp and the unwanted higher frequency peaks are larger.

See Acheson (1968) for practical advice on box car and exponential filtering, and a comparison of their effects.

A response function of a second order system is given in Figure 2.7, for a wind vane in this case, showing how damping acts as a band-pass filter.

It can be seen that the processing of signals by systems can have profound effects on the data output and must be expertly done.

Among the effects of filters is the way in which they can change the statistical information of the data. One of these was touched on earlier and illustrated in equations 2.5 and 2.8. Equation 2.5 shows how the integral of the spectrum over all frequencies gives the variance of the time series, while equation 2.8 shows how filtering, by virtue of the effect of the transfer function, will change the measured spectrum. Note that the variance is not always decreased by filtering. For example, in certain cases, for a second order system the transfer function will amplify parts of the spectrum and possibly increase the variance, as shown in Figure 2.7.

To give a further example, if the distribution is Gaussian, the variance is a useful parameter. If it were decreased by filtering, a user of the data would underestimate the departure from the mean of events occurring with given probabilities or return periods.

Also, the design of the digital filter can have unwanted or unexpected effects. If Figure 2.6 is examined it can be seen that the response function for the box car filter has a series of maxima at frequencies above where it first becomes zero. This will give the filtered data a small periodicity at these frequencies. In this case, the effect will be minimal as the maxima are small. However, for some filter designs quite significant maxima can be introduced. As a rule of thumb, the smaller the number of weights, the greater the problem. In some instances, periodicities have been claimed in data that only existed because the data had been filtered.

An issue related to the concept of filters is the length of the sample. This can be illustrated by noting that, if the length of record is of duration T , contributions to the variability of the data at frequencies below $1/T$ will not be possible. It can be shown that a finite record length has the effect of a high-pass filter. As for the low-pass filters discussed above, a high-pass filter will also have an impact on the statistics of the output data.

2.3 DETERMINATION OF SYSTEM CHARACTERISTICS

The filtering characteristics of a sensor or an electronic circuit, or the system that they comprise, must be known to determine the appropriate

sampling frequency for the time series that the system produces. The procedure is to measure the transfer or response function $H(n)$ in equation 2.8.

The transfer function can be obtained in at least three ways – by direct measurement, calculation and estimation.

2.3.1 Direct measurement of response

Response can be directly measured using at least two methods. In the first method a known change, such as a step function, is applied to the sensor or filter and its response time measured; $H(n)$ can then be calculated. In the second method, the output of the sensor is compared to another, much faster sensor. The first method is more commonly used than the second.

A simple example of how to determine the response of a sensor to a known input is to measure the distance constant of a rotating-cup or propellor anemometer. In this example, the known input is a step function. The anemometer is placed in a constant velocity air-stream, prevented from rotating, then released, and its output recorded. The time taken by the output to increase from zero to 63 per cent of its final or equilibrium speed in the air-stream is the time “constant” (see section 2.2.3).

If another sensor, which responds much more rapidly than the one whose response is to be determined, is available, then good approximations of both the input and output can be measured and compared. The easiest device to use to perform the comparison is probably a modern, two-channel digital spectrum analyser. The output of the fast-response sensor is input to one channel, the output of the sensor being tested to the other channel, and the transfer function automatically displayed. The transfer function is a direct description of the sensor as a filter. If the device whose response is to be determined is an electronic circuit, generating a known or even truly random input is much easier than finding a much faster sensor. Again, a modern, two-channel digital spectrum analyser is probably most convenient, but other electronic test instruments can be used.

2.3.2 Calculation of response

This is the approach described in section 2.2.3. If enough is known about the physics of a sensor/filter, the response to a large variety of inputs may

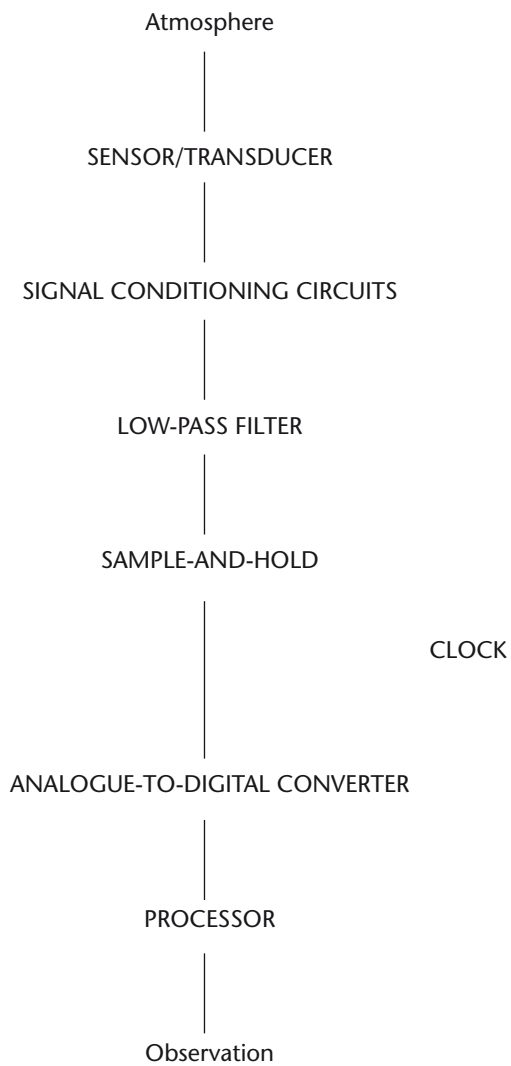

Figure 2.8. An instrument system

be determined by either analytic or numerical solution. Both the response to specific inputs, such as a step function, and the transfer function can be calculated. If the sensor or circuit is linear (described by a linear differential equation), the transfer function is a complete description, in that it describes the amplitude and phase responses as a function of frequency, in other words, as a filter. Considering response as a function of frequency is not always convenient, but the transfer function has a Fourier transform counterpart, the impulse response function, which makes interpretation of response as a function of time much easier. This is illustrated in Figures 2.3 and 2.4 which represent response as a function of time.

If obtainable, analytic solutions are preferable because they clearly show the dependence upon the various parameters.

2.3.3 Estimation of response

If the transfer functions of a transducer and each following circuit are known, their product is the transfer function of the entire system. If, as is usually the case, the transfer functions are low-pass filters, the aggregate transfer function is a low-pass filter whose cut-off frequency is less than that of any of the individual filters.

If one of the individual cut-off frequencies is much less than any of the others, then the cut-off frequency of the aggregate is only slightly smaller.

Since the cut-off frequency of a low-pass filter is approximately the inverse of its time-constant, it follows that, if one of the individual time-constants is much larger than any of the others, the time-constant of the aggregate is only slightly larger.

2.4 SAMPLING

2.4.1 Sampling techniques

Figure 2.8 schematically illustrates a typical sensor and sampling circuit. When exposed to the atmosphere, some property of the transducer changes with an atmospheric variable such as temperature, pressure, wind speed or direction, or humidity and converts that variable into a useful signal, usually electrical. Signal conditioning circuits commonly perform functions such as converting transducer output to a voltage, amplifying, linearizing, offsetting and smoothing. The low-pass filter finalizes the sensor output for the sample-and-hold input. The sample-and-hold and the analogue-to-digital converter produce the samples from which the observation is computed in the processor.

It should be noted that the smoothing performed at the signal conditioning stage for engineering reasons, to remove spikes and to stabilize the electronics, is performed by a low-pass filter; it reduces the response time of the sensor and removes high frequencies which may be of interest. Its effect should be explicitly understood by the designer and user, and its cut-off frequency should be as high as practicable.

So-called "smart sensors", those with microprocessors, may incorporate all the functions shown. The signal conditioning circuitry may not be found in all sensors, or may be combined with other circuitry. In other cases, such as with a

rotating-cup or propellor anemometer, it may be easy to speak only of a sensor because it is awkward to distinguish a transducer. In the few cases for which a transducer or sensor output is a signal whose frequency varies with the atmospheric variable being measured, the sample-and-hold and the analogue-to-digital converter may be replaced by a counter. But these are not important details. The important element in the design is to ensure that the sequence of samples adequately represents the significant changes in the atmospheric variable being measured.

The first condition imposed upon the devices shown in Figure 2.8 is that the sensor must respond quickly enough to follow the atmospheric fluctuations which are to be described in the observation. If the observation is to be a 1, 2 or 10 min average, this is not a very demanding requirement. On the other hand, if the observation is to be that of a feature of turbulence, such as peak wind gust, care must be taken when selecting a sensor.

The second condition imposed upon the devices shown in Figure 2.8 is that the sample-and-hold and the analogue-to-digital converter must provide enough samples to make a good observation. The accuracy demanded of meteorological observations usually challenges the sensor, not the electronic sampling technology. However, the sensor and the sampling must be matched to avoid aliasing. If the sampling rate is limited for technical reasons, the sensor/filter system must be designed to remove the frequencies that cannot be represented.

If the sensor has a suitable response function, the low-pass filter may be omitted, included only as insurance, or may be included because it improves the quality of the signal input to the sample-and-hold. As examples, such a filter may be included to eliminate noise pick-up at the end of a long cable or to further smooth the sensor output. Clearly, this circuit must also respond quickly enough to follow the atmospheric fluctuations of interest.

2.4.2 Sampling rates

For most meteorological and climatological applications, observations are required at intervals of 30 min to 24 hours, and each observation is made with a sampling time of the order of 1 to 10 min. Part I, Chapter 1, Annex 1.B gives a recent statement of requirements for these purposes.

A common practice for routine observations is to take one spot reading of the sensor (such as a thermometer) and rely on its time-constant to provide an approximately correct sampling time. This amounts to using an exponential filter (Figure 2.6). Automatic weather stations commonly use faster sensors, and several spot readings must be taken and processed to obtain an average (box car filter) or other appropriately weighted mean.

A practical recommended scheme for sampling rates is as follows:¹

- (a) Samples taken to compute averages should be obtained at equispaced time intervals which:
 - (i) Do not exceed the time-constant of the sensor; or
 - (ii) Do not exceed the time-constant of an analogue low-pass filter following the linearized output of a fast-response sensor; or
 - (iii) Are sufficient in number to ensure that the uncertainty of the average of the samples is reduced to an acceptable level, for example, smaller than the required accuracy of the average;
- (b) Samples to be used in estimating extremes of fluctuations, such as wind gusts, should be taken at rates at least four times as often as specified in (i) or (ii) above.

For obtaining averages, somewhat faster sampling rates than (i) and (ii), such as twice per time-constant, are often advocated and practised.

Criteria (i) and (ii) derive from consideration of the Nyquist frequency. If the sample spacing $\Delta t \leq T_L$, the sampling frequency $n \geq 1/T_L$ and $nT_L \geq 1$. It can be seen from the exponential curve in Figure 2.6 that this removes the higher frequencies and prevents aliasing. If $\Delta t = T_L$, $n_y = 1/2T_L$ and the data will be aliased only by the spectral energy at frequencies at $nT_L = 2$ and beyond, that is where the fluctuations have periods of less than $0.5T_L$.

Criteria (i) and (ii) are used for automatic sampling. The statistical criterion in (iii) is more applicable to the much lower sampling rates in manual observations. The uncertainty of the mean is inversely proportional to the square root of the number of observations, and its value can be determined from the statistics of the quantity.

¹ As adopted by the Commission for Instruments and Methods of Observation at its tenth session (1989) through Recommendation 3 (CIMO-X).

Criterion (b) emphasizes the need for high sampling frequencies, or more precisely, small time-constants, to measure gusts. Recorded gusts are smoothed by the instrument response, and the recorded maximum will be averaged over several times the time-constant.

The effect of aliasing on estimates of the mean can be seen very simply by considering what happens when the frequency of the wave being measured is the same as the sampling frequency, or a multiple thereof. The derived mean will depend on the timing of the sampling. A sample obtained once per day at a fixed time will not provide a good estimate of mean monthly temperature.

For a slightly more complex illustration of aliasing, consider a time series of three-hourly observations of temperature using an ordinary thermometer. If temperature changes smoothly with time, as it usually does, the daily average computed from eight samples is acceptably stable. However, if a mesoscale event (a thunderstorm) has occurred which reduced the temperature by many degrees for 30 min, the computed average is wrong. The reliability of daily averages depends on the usual weakness of the spectrum in the mesoscale and higher frequencies. However, the occurrence of a higher-frequency event (the thunderstorm) aliases the data, affecting the computation of the mean, the standard deviation and other measures of dispersion, and the spectrum.

The matter of sampling rate may be discussed also in terms of Figure 2.8. The argument in section 2.2.1 was that, for the measurement of spectra, the sampling rate, which determines the Nyquist frequency, should be chosen so that the spectrum of fluctuations above the Nyquist frequency is too weak to affect the computed spectrum. This is achieved if the sampling rate set by the clock in Figure 2.8 is at least twice the highest frequency of significant amplitude in the input signal to the sample-and-hold.

The wording "highest frequency of significant amplitude" used above is vague. It is difficult to find a rigorous definition because signals are never truly bandwidth limited. However, it is not difficult to ensure that the amplitude of signal fluctuations decreases rapidly with increasing frequency, and that the root-mean-square amplitude of fluctuations above a given frequency is either small in comparison with the quantization noise of the analogue-to-digital converter, small in comparison with an acceptable error or noise level in the

samples, or contributes negligibly to total error or noise in the observation.

Section 2.3 discussed the characteristics of sensors and circuits which can be chosen or adjusted to ensure that the amplitude of signal fluctuations decreases rapidly with increasing frequency. Most transducers, by virtue of their inability to respond to rapid (high-frequency) atmospheric fluctuations and their ability to replicate faithfully slow (low-frequency) changes, are also low-pass filters. By definition, low-pass filters limit the bandwidth and, by Nyquist's theorem, also limit the sampling rate that is necessary to reproduce the filter output accurately. For example, if there are real variations in the atmosphere with periods down to 100 ms, the Nyquist sampling frequency would be 1 per 50 ms, which is technically demanding. However, if they are seen through a sensor and filter which respond much more slowly, for example with a 10 s time-constant, the Nyquist sampling rate would be 1 sample per 5 s, which is much easier and cheaper, and preferable if measurements of the high frequencies are not required.

2.4.3 Sampling rate and quality control

Many data quality control techniques of use in automatic weather stations depend upon the temporal consistency, or persistence, of the data for their effectiveness. As a very simple example, two hypothetical quality-control algorithms for pressure measurements at automatic weather stations should be considered. Samples are taken every 10 s, and 1 min averages computed each minute. It is assumed that atmospheric pressure only rarely, if ever, changes at a rate exceeding 1 hPa per minute.

The first algorithm rejects the average if it differs from the previous one by more than 1 hPa. This would not make good use of the available data. It allows a single sample with as much as a 6 hPa error to pass undetected and to introduce a 1 hPa error in an observation.

The second algorithm rejects a sample if it differs from the previous one by more than 1 hPa. In this case, an average contains no error larger than about 0.16 (1/6) hPa. In fact, if the assumption is correct that atmospheric pressure only rarely changes at a rate exceeding 1 hPa per minute, the accept/reject criteria on adjacent samples could be tightened to 0.16 hPa and error in the average could be reduced even more.

The point of the example is that data quality control procedures that depend upon temporal consistency (correlation) for their effectiveness are best applied

to data of high temporal resolution (sampling rate). At the high frequency end of the spectrum in the sensor/filter output, correlation between adjacent samples increases with increasing sampling rate until the Nyquist frequency is reached, after which no further increase in correlation occurs.

Up to this point in the discussion, nothing has been said which would discourage using a sensor/filter with a time-constant as long as the averaging period required for the observation is taken as a single sample to use as the observation. Although this would be minimal in its demands upon the digital subsystem, there is another consideration needed for effective data quality control. Observations can be grouped into three categories as follows:

- (a) Accurate (observations with errors less than or equal to a specified value);
- (b) Inaccurate (observations with errors exceeding a specified value);
- (c) Missing.

There are two reasons for data quality control, namely, to minimize the number of inaccurate observations and to minimize the number of missing observations. Both purposes are served by ensuring that each observation is computed from a reasonably large number of data quality-controlled samples. In this way, samples with large spurious errors can be isolated and excluded, and the computation can still proceed, uncontaminated by that sample.

REFERENCES AND FURTHER READING

- Acheson, D.T., 1968: An approximation to arithmetic averaging for meteorological variables. *Journal of Applied Meteorology*, Volume 7, pp. 548–553.
- Bendat, J.S. and A.G. Piersol, 1986: *Random Data: Analysis and Measurement Procedures*. Second edition, John Wiley and Sons, New York.
- Blackman, R.B. and J.W. Tukey, 1958: *The Measurement of Power Spectra*. Dover Publications, New York.
- Jenkins, G.M. and D.G. Watts, 1968: *Spectral Analysis and its Applications*. Holden-Day, San Francisco.
- Kulhánek, O., 1976: *Introduction to Digital Filtering in Geophysics*. Elsevier, Amsterdam.
- MacCreedy, P.B. and H.R. Jex, 1964: Response characteristics and meteorological utilization of propeller and vane wind sensors. *Journal of Applied Meteorology*, Volume 3, Issue 2, pp. 182–193.
- Otnes, R.K. and L. Enochson, 1978: *Applied Time Series Analysis*. Volume 1: Basic techniques. John Wiley and Sons, New York.
- Pasquill, F. and F.B. Smith, 1983: *Atmospheric Diffusion*. Third edition. Ellis Horwood, Chichester.
- Stearns, S.D. and D.R. Hush, 1990: *Digital Signal Analysis*. Second edition. Prentice Hall, New Jersey.
-

CHAPTER 3

DATA REDUCTION

3.1 GENERAL

This chapter discusses in general terms the procedures for processing and/or converting data obtained directly from instruments into data suitable for meteorological users, in particular for exchange between countries. Formal regulations for the reduction of data to be exchanged internationally have been prescribed by WMO, and are laid down in WMO (2003). Part I, Chapter 1, contains some relevant advice and definitions.

3.1.1 Definitions

In the discussion of the instrumentation associated with the measurement of atmospheric variables, it has become useful to classify the observational data according to data levels. This scheme was introduced in connection with the data-processing system for the Global Atmospheric Research Programme, and is defined in WMO (1992; 2003).

Level I data, in general, are instrument readings expressed in appropriate physical units, and referred to with geographical coordinates. They require conversion to the normal meteorological variables (identified in Part I, Chapter 1). Level I data themselves are in many cases obtained from the processing of electrical signals such as voltages, referred to as raw data. Examples of these data are satellite radiances and water-vapour pressure.

The data recognized as meteorological variables are Level II data. They may be obtained directly from instruments (as is the case for many kinds of simple instruments) or derived from Level I data. For example, a sensor cannot measure visibility, which is a Level II quantity; instead, sensors measure the extinction coefficient, which is a Level I quantity.

Level III data are those contained in internally consistent data sets, generally in grid-point form. They are not within the scope of this Guide.

Data exchanged internationally are Level II or Level III data.

3.1.2 Meteorological requirements

Observing stations throughout the world routinely produce frequent observations in standard formats for exchanging high-quality information obtained by uniform observing techniques, despite the different types of sensors in use throughout the world, or even within nations. To accomplish this, very considerable resources have been devoted over very many years to standardize content, quality and format. As automated observation of the atmosphere becomes more prevalent, it becomes even more important to preserve this standardization and develop additional standards for the conversion of raw data into Level I data, and raw and Level I data into Level II data.

3.1.3 The data reduction process

The role of a transducer is to sense an atmospheric variable and convert it quantitatively into a useful signal. However, transducers may have secondary responses to the environment, such as temperature-dependent calibrations, and their outputs are subject to a variety of errors, such as drift and noise. After proper sampling by a data-acquisition system, the output signal must be scaled and linearized according to the total system calibration and then filtered or averaged. At this stage, or earlier, it becomes raw data. The data must then be converted to measurements of the physical quantities to which the sensor responds, which are Level I data or may be Level II data if no further conversion is necessary. For some applications, additional variables must be derived. At various stages in the process the data may be corrected for extraneous effects, such as exposure, and may be subjected to quality control.

Data from conventional and automatic weather stations (AWSs) must, therefore, be subjected to many operations before they can be used. The whole process is known as data reduction and consists of the execution of a number of functions, comprising some or all of the following:

- (a) Transduction of atmospheric variables;
- (b) Conditioning of transducer outputs;
- (c) Data acquisition and sampling;
- (d) Application of calibration information;
- (e) Linearization of transducer outputs;

- (f) Extraction of statistics, such as the average;
- (g) Derivation of related variables;
- (h) Application of corrections;
- (i) Data quality control;
- (j) Data recording and storage;
- (k) Compilation of metadata;
- (l) Formatting of messages;
- (m) Checking message contents;
- (n) Transmission of messages.

The order in which these functions are executed is only approximately sequential. Of course, the first and the last function listed above should always be performed first and last. Linearization may immediately follow or be inherent in the transducer, but it must precede the extraction of an average. Specific quality control and the application of corrections could take place at different levels of the data-reduction process. Depending on the application, stations can operate in a diminished capacity without incorporating all of these functions.

In the context of this Guide, the important functions in the data-reduction process are the selection of appropriate sampling procedures, the application of calibration information, linearization when required, filtering and/or averaging, the derivation of related variables, the application of corrections, quality control, and the compilation of metadata. These are the topics addressed in this chapter. More explicit information on quality management is given in Part III, Chapter 1, and on sampling, filtering and averaging in Part III, Chapter 2.

Once reduced, the data must be made available through coding, transmission and receipt, display, and archiving, which are the topics of other WMO Manuals and Guides. An observing system is not complete unless it is connected to other systems that deliver the data to the users. The quality of the data is determined by the weakest link. At every stage, quality control must be applied.

Much of the existing technology and standardized manual techniques for data reduction can also be used by AWSs, which, however, make particular demands. AWSs include various sensors, standard computations for deriving elements of messages, and the message format itself. Not all sensors interface easily with automated equipment. Analytic expressions for computations embodied in tables must be recovered or discovered. The rules for encoding messages must be expressed in computer languages with degrees of precision, completeness and unambiguousness not demanded by natural language instructions prepared for human observers. Furthermore, some human functions,

such as the identification of cloud types, cannot be automated using either current or foreseeable technologies.

Data acquisition and data-processing software for AWSs are discussed at some length in Part II, Chapter 1, to an extent which is sufficiently general for any application of electrical transducers in meteorology. Some general considerations and specific examples of the design of algorithms for synoptic AWSs are given in WMO (1987).

In processing meteorological data there is usually one correct procedure, algorithm or approach, and there may be many approximations ranging in validity from good to useless. Experience strongly suggests that the correct approach is usually the most efficient in the long term. It is direct, requires a minimum of qualifications, and, once implemented, needs no further attention. Accordingly, the subsequent paragraphs are largely limited to the single correct approach, as far as exact solutions exist, to the problem under consideration.

3.2 SAMPLING

See Part III, Chapter 2 for a full discussion of sampling. The following is a summary of the main outcomes.

It should be recognized that atmospheric variables fluctuate rapidly and randomly because of ever-present turbulence, and that transducer outputs are not faithful reproductions of atmospheric variables because of their imperfect dynamic characteristics, such as limited ability to respond to rapid changes. Transducers generally need equipment to amplify or protect their outputs and/or to convert one form of output to another, such as resistance to voltage. The circuitry used to accomplish this may also smooth or low-pass filter the signal. There is a cut-off frequency above which no significant fluctuations occur because none exist in the atmosphere and/or the transducer or signal conditioning circuitry has removed them.

An important design consideration is how often the transducer output should be sampled. The definitive answer is: at an equispaced rate at least twice the cut-off frequency of the transducer output signal. However, a simpler and equivalent rule usually suffices: the sampling interval should not exceed the largest of the time-constants of all the devices and

circuitry preceding the acquisition system. If the sampling rate is less than twice the cut-off frequency, unnecessary errors occur in the variance of the data and in all derived quantities and statistics. While these increases may be acceptable in particular cases, in others they are not. Proper sampling always ensures minimum variance.

Good design may call for incorporating a low-pass filter, with a time-constant about equal the sampling interval of the data-acquisition system. It is also a precautionary measure to minimize the effects of noise, especially 50 or 60 Hz pick-up from power mains by cables connecting sensors to processors and leakage through power supplies.

3.3 APPLICATION OF CALIBRATION FUNCTIONS

The WMO regulations (WMO, 2003) prescribe that stations be equipped with properly calibrated instruments and that adequate observational and measuring techniques are followed to ensure that the measurements are accurate enough to meet the needs of the relevant meteorological disciplines. The conversion of raw data from instruments into the corresponding meteorological variables is achieved by means of calibration functions. The proper application of calibration functions and any other systematic corrections are most critical for obtaining data that meet expressed accuracy requirements.

The determination of calibration functions should be based on calibrations of all components of the measurement chain. In principle at least, and in practice for some meteorological quantities such as pressure, the calibration of field instruments should be traceable to an international standard instrument, through an unbroken chain of comparisons between the field instrument and some or all of a series of standard instruments, such as a travelling standard, a working standard, a reference standard and a national standard (see Part I, Chapter 1 for definitions).

A description of the calibration procedures and systematic corrections associated with each of the basic meteorological variables is contained in each of the respective chapters in Part I.

Field instruments must be calibrated regularly by an expert, with corresponding revisions to the calibration functions. It is not sufficient to rely on calibration data that is supplied along with the calibration equipment. The supplier's calibration

equipment often bears an unknown relationship to the national standard, and, in any case, it must be expected that calibration will change during transport, storage and use. Calibration changes must be recorded in the station's metadata files.

3.4 LINEARIZATION

If the transducer output is not exactly proportional to the quantity being measured, the signal must be linearized, making use of the instrument's calibration. This must be carried out before the signal is filtered or averaged. The sequence of operations "average then linearize" produces different results from the sequence "linearize then average" when the signal is not constant throughout the averaging period.

Non-linearity may arise in the following three ways (WMO, 1987):

- (a) Many transducers are inherently nonlinear, namely, their output is not proportional to the measured atmospheric variable. A thermistor is a simple example;
- (b) Although a sensor may incorporate linear transducers, the variables measured may not be linearly related to the atmospheric variable of interest. For example, the photodetector and shaft-angle transducer of a rotating beam ceilometer are linear devices, but the ceilometer output signal (backscattered light intensity as a function of angle) is non-linear in cloud height;
- (c) The conversion from Level I to Level II may not be linear. For example, extinction coefficient, not visibility or transmittance, is the proper variable to average in order to produce estimates of average visibility.

In the first of these cases, a polynomial calibration function is often used. If so, it is highly desirable to have standardized sensors with uniform calibration coefficients to avoid the problems that arise when interchanging sensors in the field. In the other two cases, an analytic function which describes the behaviour of the transducer is usually appropriate.

3.5 AVERAGING

The natural small-scale variability of the atmosphere makes smoothing or averaging necessary for obtaining representative observations and compat-

ibility of data from different instruments. For international exchange and for many operational applications, the reported measurement must be representative of the previous 2 or 10 min for wind, and, by convention, of 1 to 10 min for other quantities. The 1 min practice arises in part from the fact that some conventional meteorological sensors have a response of the order of 1 min and a single reading is notionally a 1 min average or smoothed value. If the response time of the instrument is much faster, it is necessary to take samples and filter or average them. This is the topic of Part III, Chapter 2. See Part I, Chapter 1, (Annex 1.B), for the requirements of the averaging times typical of operational meteorological instrument systems.

Two types of averaging or smoothing are commonly used, namely, arithmetic and exponential. The arithmetic average conforms with the normal meaning of average and is readily implemented digitally; this is the box car filter described in Part III, Chapter 2. An exponential average is the output of the simplest low-pass filter representing the simplest response of a sensor to atmospheric fluctuations, and it is more convenient to implement in analogue circuitry than the arithmetic average. When the time-constant of a simple filter is approximately half the sampling time over which an average is being calculated, the arithmetic and exponential smoothed values are practically indistinguishable (see Part III, Chapter 2, and also Acheson, 1968).

The outputs of fast-response sensors vary rapidly thus necessitating high sampling rates for optimal (minimum uncertainty) averaging. To reduce the required sampling rate and still provide the optimal digital average, it could be possible to linearize the transducer output (where that is necessary), exponentially smooth it using analogue circuitry with time-constant t_c , and then sample digitally at intervals t_c .

Many other types of elaborate filters, computed digitally, have been used for special applications.

Because averaging non-linear variables creates difficulties when the variables change during the averaging period, it is important to choose the appropriate linear variable to compute the average. The table below lists some specific examples of elements of a synoptic observation which are reported as averages, with the corresponding linear variable that should be used.

3.6 RELATED VARIABLES AND STATISTICS

Besides averaged data, extremes and other variables that are representative for specific periods must be determined, depending on the purpose of the observation. An example of this is wind gust measurements, for which higher sampling rates are necessary.

Also, other quantities have to be derived from the averaged data, such as mean sea-level pressure, visibility and dewpoint. At conventional manual stations, conversion tables are used. It is common practice to incorporate the tables into an AWS and to provide interpolation routines, or to incorporate the basic formulas or approximations of them. See the various chapters of Part I for the data conversion practices, and Part II, Chapter 1 for AWS practice.

Quantities for which data conversion is necessary when averages are being computed

<i>Quantity to be reported</i>	<i>Quantity to be averaged</i>
Wind speed and direction	Cartesian components
Dewpoint	Absolute humidity
Visibility	Extinction coefficient

3.7 CORRECTIONS

The measurements of many meteorological quantities have corrections applied to them either as raw data or at the Level I or Level II stage to correct for various effects. These corrections are described in the chapters on the various meteorological variables in Part I. Corrections to raw data, for zero or index error, or for temperature, gravity and the like are derived from the calibration and characterization of the instrument. Other types of corrections or adjustments to the raw or higher level data include smoothing, such as that applied to cloud height measurements and upper-air profiles, and corrections for exposure such as those sometimes applied to temperature, wind and precipitation observations. The algorithms for these types of corrections may, in some cases, be based on studies that are not entirely definitive; therefore, while they no doubt improve the accuracy of the data, the possibility remains that different algorithms may be derived in the future. In such a case, it may become necessary to recover the original uncorrected data. It is, therefore, advisable for the algorithms to be well documented.

3.8 **QUALITY MANAGEMENT**

Quality management is discussed in Part III, Chapter 1. Formal requirements are specified by WMO (2003) and general procedures are discussed in WMO (1989).

Quality-control procedures should be performed at each stage of the conversion of raw sensor output into meteorological variables. This includes the processes involved in obtaining the data, as well as reducing them to Level II data.

During the process of obtaining data, the quality control should seek to eliminate both systematic and random measurement errors, errors due to departure from technical standards, errors due to unsatisfactory exposure of instruments, and subjective errors on the part of the observer.

Quality control during the reduction and conversion of data should seek to eliminate errors resulting from the conversion techniques used or the computational procedures involved. In order to improve the quality of data obtained at high sampling rates, which may generate increased

noise, filtering and smoothing techniques are employed. These are described earlier in this chapter, as well as in Part III, Chapter 2.

3.9 **COMPILING METADATA**

Metadata are discussed in Part I, Chapter 1, in Part III, Chapter 1, and in other chapters concerning the various meteorological quantities. Metadata must be kept so that:

- (a) Original data can be recovered to be re-worked, if necessary (with different filtering or corrections, for instance);
- (b) The user can readily discover the quality of the data and the circumstances under which it was obtained (such as exposure);
- (c) Potential users can discover the existence of the data.

The procedures used in all the data-reduction functions described above must therefore be recorded, generically for each type of data, and individually for each station and observation type.

REFERENCES AND FURTHER READING

- Acheson, D.T., 1968: An approximation to arithmetic averaging for meteorological variables. *Journal of Applied Meteorology*, Volume 7, Issue 4, pp. 548–553.
- World Meteorological Organization, 1987: *Some General Considerations and Specific Examples in the Design of Algorithms for Synoptic Automatic Weather Stations* (D.T. Acheson). Instruments and Observing Methods Report No. 19, WMO/TD-No. 230, Geneva.
- World Meteorological Organization, 1992: *Manual on the Global Data-Processing and Forecasting System*. Volume I, WMO-No. 485, Geneva.
- World Meteorological Organization, 1989: *Guide on the Global Observing System*. WMO-No. 488, Geneva.
- World Meteorological Organization, 2003: *Manual on the Global Observing System*. Volume I: Global aspects. WMO-No. 544, Geneva.
-

CHAPTER 4

TESTING, CALIBRATION AND INTERCOMPARISON

4.1 GENERAL

One of the purposes of WMO, set forth in Article 2 (c) of the WMO Convention, is “to promote standardization of meteorological and related observations and to ensure the uniform publication of observations and statistics”. For this purpose, sets of standard procedures and recommended practices have been developed, and their essence is contained in this Guide.

Valid observational data can be obtained only when a comprehensive quality assurance programme is applied to the instruments and the network. Calibration and testing are inherent elements of a quality assurance programme. Other elements include clear definition of requirements, instrument selection deliberately based on the requirements, siting criteria, maintenance and logistics. These other elements must be considered when developing calibration and test plans. On an international scale, the extension of quality assurance programmes to include intercomparisons is important for the establishment of compatible data sets.

Because of the importance of standardization across national boundaries, several WMO regional associations have set up Regional Instrument Centres¹ to organize and assist with standardization and calibration activities. Their terms of reference and locations are given in Part I, Chapter 1, Annex 1.A.

National and international standards and guidelines exist for many aspects of testing and evaluation, and should be used where appropriate. Some of them are referred to in this chapter.

4.1.1 Definitions

Definitions of terms in metrology are given by the International Organization for Standardization (ISO, 1993). Many of them are reproduced in Part I, Chapter 1, and some are repeated here for convenience. They are not universally used and differ in some respects from terminology commonly used in meteorological practice. However, the ISO definitions are recommended for use in meteorology.

¹ Recommended by the Commission for Instruments and Methods of Observation at its ninth session (1985) through Recommendation 19 (CI-MO-IX).

The ISO document is a joint production with the International Bureau of Weights and Measures, the International Organization of Legal Metrology, the International Electrotechnical Commission, and other similar international bodies.

The ISO terminology differs from common usage in the following respects in particular:

Accuracy (of a measurement) is the closeness of the agreement between the result of a measurement and its true value, and it is a qualitative term. The accuracy of an instrument is the ability of the instrument to give responses close to the true value, and it also is a qualitative term. It is possible to refer to an instrument or a measurement as having a high accuracy, but the quantitative measure of the accuracy is the uncertainty.

Uncertainty is expressed as a measure of dispersion, such as a standard deviation or a confidence level.

The *error* of a measurement is the result minus the true value (the deviation has the other sign), and it is composed of the random and systematic errors (the term *bias* is commonly used for systematic error).

Repeatability is also expressed statistically and is the closeness of agreement of measurements taken under constant (defined) conditions.

Reproducibility is the closeness of agreement under defined different conditions.

ISO does not define precision, and advises against the use of the term.

4.1.2 Testing and calibration programmes

Before using atmospheric measurements taken with a particular sensor for meteorological purposes, the answers to a number of questions are needed as follows:

- (a) What is the sensor or system accuracy?
- (b) What is the variability of measurements in a network containing such systems or sensors?
- (c) What change, or bias, will there be in the data provided by the sensor or system if its siting location is changed?

- (d) What change or bias will there be in the data if it replaces a different sensor or system measuring the same weather element(s)?

To answer these questions and to assure the validity and relevance of the measurements produced by a meteorological sensor or system, some combination of calibration, laboratory testing and functional testing is needed.

Calibration and test programmes should be developed and standardized, based on the expected climatic variability, environmental and electromagnetic interference under which systems and sensors are expected to operate. For example, considered factors might include the expected range of temperature, humidity and wind speed; whether or not a sensor or system must operate in a marine environment, or in areas with blowing dust or sand; the expected variation in electrical voltage and phase, and signal and power line electrical transients; and the expected average and maximum electromagnetic interference. Meteorological Services may purchase calibration and test services from private laboratories and companies, or set up test organizations to provide those services.

It is most important that at least two like sensors or systems be subjected to each test in any test programme. This allows for the determination of the expected variability in the sensor or system, and also facilitates detecting problems.

4.2 TESTING

4.2.1 The purpose of testing

Sensors and systems are tested to develop information on their performance under specified conditions of use. Manufacturers typically test their sensors and systems and in some cases publish operational specifications based on their test results. However, it is extremely important for the user Meteorological Service to develop and carry out its own test programme or to have access to an independent testing authority.

Testing can be broken down into environmental testing, electrical/electromagnetic interference testing and functional testing. A test programme may consist of one or more of these elements.

In general, a test programme is designed to ensure that a sensor or system will meet its specified

performance, maintenance and mean-time-between-failure requirements under all expected operating, storage and transportation conditions. Test programmes are also designed to develop information on the variability that can be expected in a network of like sensors, in functional reproducibility, and in the comparability of measurements between different sensors or systems.

Knowledge of both functional reproducibility and comparability is very important to climatology, where a single long-term database typically contains information from sensors and systems that through time use different sensors and technologies to measure the same meteorological variable. In fact, for practical applications, good operational comparability between instruments is a more valuable attribute than precise absolute calibration. This information is developed in functional testing.

Even when a sensor or system is delivered with a calibration report, environmental and possibly additional calibration testing should be performed. An example of this is a modern temperature measurement system, where at present the probe is likely to be a resistance temperature device. Typically, several resistance temperature devices are calibrated in a temperature bath by the manufacturer and a performance specification is provided based on the results of the calibration. However, the temperature system which produces the temperature value also includes power supplies and electronics, which can also be affected by temperature. Therefore, it is important to operate the electronics and probe as a system through the temperature range during the calibration. It is good practice also to replace the probe with a resistor with a known temperature coefficient, which will produce a known temperature output and operate the electronics through the entire temperature range of interest to ensure proper temperature compensation of the system electronics.

Users should also have a programme for testing randomly selected production sensors and systems, even if pre-production units have been tested, because even seemingly minor changes in material, configurations or manufacturing processes may affect the operating characteristics of sensors and systems.

The International Organization for Standardization has standards (ISO, 1989*a*, 1989*b*) which specify sampling plans and procedures for the inspection of lots of items.

4.2.2 Environmental testing

4.2.2.1 Definitions

The following definitions serve to introduce the qualities of an instrument system that should be the subject of operational testing:

Operational conditions: Those conditions or a set of conditions encountered or expected to be encountered during the time an item is performing its normal operational function in full compliance with its performance specification.

Withstanding conditions: Those conditions or a set of conditions outside the operational conditions which the instrument is expected to withstand. They may have only a small probability of occurrence during an item's lifetime. The item is not expected to perform its operational function when these withstanding conditions exist. The item is, however, expected to be able to survive these conditions and return to normal performance when the operational conditions return.

Outdoor environment: Those conditions or a set of conditions encountered or expected to be encountered during the time that an item is performing its normal operational function in an unsheltered, uncontrolled natural environment.

Indoor environment: Those conditions or a set of conditions encountered or expected to be encountered during the time that an item is energized and performing its normal operational function within an enclosed operational structure. Consideration is given to both the uncontrolled indoor environment and the artificially controlled indoor environment.

Transportation environment: Those conditions or a set of conditions encountered or expected to be encountered during the transportation portion of an item's life. Consideration is given to the major transportation modes – road, rail, ship and air transportation, and also to the complete range of environments encountered – before and during transportation, and during the unloading phase. The item is normally housed in its packaging/shipping container during exposure to the transportation environment.

Storage environment: Those conditions or a set of conditions encountered or expected to be encountered during the time an item is in its non-operational storage mode. Consideration is given to all types of storage, from the open storage situation, in which an

item is stored unprotected and outdoors, to the protected indoor storage situation. The item is normally housed in its packaging/shipping container during exposure to the storage environment.

The International Electrotechnical Commission also has standards (IEC, 1990) to classify environmental conditions which are more elaborate than the above. They define ranges of meteorological, physical and biological environments that may be encountered by products being transported, stored, installed and used, which are useful for equipment specification and for planning tests.

4.2.2.2 Environmental test programme

Environmental tests in the laboratory enable rapid testing over a wide range of conditions, and can accelerate certain effects such as those of a marine environment with high atmospheric salt loading. The advantage of environmental tests over field tests is that many tests can be accelerated in a well-equipped laboratory, and equipment may be tested over a wide range of climatic variability. Environmental testing is important; it can give insight into potential problems and generate confidence to go ahead with field tests, but it cannot replace field testing.

An environmental test programme is usually designed around a subset of the following conditions: high temperature, low temperature, temperature shock, temperature cycling, humidity, wind, rain, freezing rain, dust, sunshine (insolation), low pressure, transportation vibration and transportation shock. The ranges, or test limits, of each test are determined by the expected environments (operational, withstanding, outdoor, indoor, transportation, storage) that are expected to be encountered.

The purpose of an environmental test programme document is to establish standard environmental test criteria and corresponding test procedures for the specification, procurement, design and testing of equipment. This document should be based on the expected environmental operating conditions and extremes.

For example, the United States prepared its National Weather Service standard environmental criteria and test procedures (NWS, 1984), based on a study which surveyed and reported the expected operational and extreme ranges of the various weather elements in the United States operational area, and presented proposed test criteria (NWS, 1980). These criteria and procedures consist of three parts:

- (a) Environmental test criteria and test limits for outdoor, indoor, and transportation/storage environments;
- (b) Test procedures for evaluating equipment against the environmental test criteria;
- (c) Rationale providing background information on the various environmental conditions to which equipment may be exposed, their potential effect(s) on the equipment, and the corresponding rationale for the recommended test criteria.

4.2.3 **Electrical and electromagnetic interference testing**

The prevalence of sensors and automated data collection and processing systems that contain electronic components necessitates in many cases the inclusion in an overall test programme for testing performance in operational electrical environments and under electromagnetic interference.

An electrical/electromagnetic interference test programme document should be prepared. The purpose of the document is to establish standard electrical/electromagnetic interference test criteria and corresponding test procedures and to serve as a uniform guide in the specification of electrical/electromagnetic interference susceptibility requirements for the procurement and design of equipment.

The document should be based on a study that quantifies the expected power line and signal line transient levels and rise times caused by natural phenomena, such as thunderstorms. It should also include testing for expected power variations, both voltage and phase. If the equipment is expected to operate in an airport environment, or other environment with possible electromagnetic radiation interference, this should also be quantified and included in the standard. A purpose of the programme may also be to ensure that the equipment is not an electromagnetic radiation generator. Particular attention should be paid to equipment containing a microprocessor and, therefore, a crystal clock, which is critical for timing functions.

4.2.4 **Functional testing**

Calibration and environmental testing provide a necessary but not sufficient basis for defining the operational characteristics of a sensor or system, because calibration and laboratory testing cannot completely define how the sensor or system will operate in the field. It is impossible to simulate the

synergistic effects of all the changing weather elements on an instrument in all of its required operating environments.

Functional testing is simply testing in the outdoor and natural environment where instruments are expected to operate over a wide variety of meteorological conditions and climatic regimes, and, in the case of surface instruments, over ground surfaces of widely varying albedo. Functional testing is required to determine the adequacy of a sensor or system while it is exposed to wide variations in wind, precipitation, temperature, humidity, and direct, diffuse and reflected solar radiation. Functional testing becomes more important as newer technology sensors, such as those using electro-optic, piezoelectric and capacitive elements, are placed into operational use. The readings from these sensors may be affected by adventitious conditions such as insects, spiders and their webs, and the size distribution of particles in the atmosphere, all of which must be determined by functional tests.

For many applications, comparability must be tested in the field. This is done with side-by-side testing of like and different sensors or systems against a field reference standard. These concepts are presented in Hoehne (1971; 1972; 1977).

Functional testing may be planned and carried out by private laboratories or by the test department of the Meteorological Service or other user organization. For both the procurement and operation of equipment, the educational and skill level of the observers and technicians who will use the system must be considered. Use of the equipment by these staff members should be part of the test programme. The personnel who will install, use, maintain and repair the equipment should evaluate those portions of the sensor or system, including the adequacy of the instructions and manuals that they will use in their job. Their skill level should also be considered when preparing procurement specifications.

4.3 **CALIBRATION**

4.3.1 **The purpose of calibration**

Sensor or system calibration is the first step in defining data validity. In general, it involves comparison against a known standard to determine how closely instrument output matches the standard over the expected range of operation. Performing laboratory calibration carries the implicit assumption that the instrument's characteristics are stable enough to

retain the calibration in the field. A calibration history over successive calibrations should provide confidence in the instrument's stability.

Specifically, calibration is the set of operations that establish, under specified conditions, the relationship between the values indicated by a measuring instrument or measuring system and the corresponding known values of a measurand, namely the quantity to be measured. It should define a sensor/system's bias or average deviation from the standard against which it is calibrated, its random errors, the range over which the calibration is valid, and the existence of any thresholds or non-linear response regions. It should also define resolution and hysteresis. Hysteresis should be identified by cycling the sensor over its operating range during calibration. The result of a calibration is often expressed as a calibration factor or as a series of calibration factors in the form of a calibration table or calibration curve. The results of a calibration must be recorded in a document called a calibration certificate or a calibration report.

The calibration certificate or report should define any bias that can then be removed through mechanical, electrical or software adjustment. The remaining random error is not repeatable and cannot be removed, but can be statistically defined through a sufficient number of measurement repetitions during calibration.

4.3.2 Standards

The calibration of instruments or measurement systems is customarily carried out by comparing them against one or more measurement standards. These standards are classified according to their metrological quality. Their definitions (ISO, 1993) are given in Part I, Chapter 1 and may be summarized as follows:

Primary standard: A standard which has the highest metrological qualities and whose value is accepted without reference to other standards.

Secondary standard: A standard whose value is assigned by comparison with a primary standard.

International standard: A standard recognized by an international agreement to serve internationally as the basis for assigning values to other standards of the quantity concerned.

National standard: A standard recognized by a national decision to serve, in a country, as the basis for assigning values to other standards.

Reference standard: A standard, generally of the highest metrological quality available at a given location or in a given organization from which the measurements taken there are derived.

Working standard: A standard that is used routinely to calibrate or check measuring instruments.

Transfer standard: A standard used as an intermediary to compare standards.

Travelling standard: A standard, sometimes of special construction, intended for transport between different locations.

Primary standards reside within major international or national institutions. Secondary standards often reside in major calibration laboratories and are usually not suitable for field use. Working standards are usually laboratory instruments that have been calibrated against a secondary standard. Working standards that may be used in the field are known as transfer standards. Transfer standard instruments may also be used to compare instruments in a laboratory or in the field.

4.3.3 Traceability

Traceability is defined by ISO (1993) as:

“The property of the result of a measurement or the value of a standard whereby it can be related to stated references, usually national or international standards, through an unbroken chain of comparisons all having stated uncertainties.”

In meteorology, it is common practice for pressure measurements to be traceable through travelling standards, working standards and secondary standards to national or primary standards, and the accumulated uncertainties therefore are known (except for those that arise in the field, which have to be determined by field testing). Temperature measurements lend themselves to the same practice.

The same principle must be applied to the measurement of any quantity for which measurements of known uncertainty are required.

4.3.4 Calibration practices

The calibration of meteorological instruments is normally carried out in a laboratory where appropriate measurement standards and calibration devices are located. They may be national laboratories, private laboratories, or laboratories

established within the Meteorological Service or other user organization. A calibration laboratory is responsible for maintaining the necessary qualities of its measurement standards and for keeping records of their traceability. Such laboratories can also issue calibration certificates that should also contain an estimate of the accuracy of calibration. In order to guarantee traceability, the calibration laboratory should be recognized and authorized by the appropriate national authorities.

Manufacturers of meteorological instruments should deliver their quality products, for example, standard barometers or thermometers, with calibration certificates or calibration reports. These documents may or may not be included in the basic price of the instrument, but may be available as options. Calibration certificates given by authorized calibration laboratories may be more expensive than factory certificates. As discussed in the previous section, environmental, functional, and possibly additional calibration testing, should be performed.

Users may also purchase calibration devices or measurement standards for their own laboratories. A good calibration device should always be combined with a proper measurement standard, for example, a liquid bath temperature calibration chamber with a set of certified liquid-in-glass thermometers, and/or certified resistance thermometers. For the example above, further considerations, such as the use of non-conductive silicone fluid, should be applied. Thus, if a temperature-measurement device is mounted on an electronic circuit board, the entire board may be immersed in the bath so that the device can be tested in its operating configuration. Not only must the calibration equipment and standards be of high quality, but the engineers and technicians of a calibration laboratory must be well trained in basic metrology and in the use of available calibration devices and measurement standards.

Once instruments have passed initial calibration and testing and are accepted by the user, a programme of regular calibration checks and calibrations should be instituted. Instruments, such as mercury barometers, are easily subject to breakage when transported to field sites. At distant stations, these instruments should be kept stationary as far as possible, and should be calibrated against more robust travelling standards that can be moved from one station to another by inspectors. Travelling standards must be compared frequently against a working standard or reference standard in the

calibration laboratory, and before and after each inspection tour.

Details of laboratory calibration procedures of, for example, barometers, thermometers, hygrometers, anemometers and radiation instruments are given in the relevant chapters of this Guide or in specialized handbooks. These publications also contain information concerning recognized international standard instruments and calibration devices. Calibration procedures for automatic weather stations require particular attention, as discussed in Part II, Chapter 1.

WMO (1989) gives a detailed analysis of the calibration procedures used by several Meteorological Services for the calibration of instruments used to measure temperature, humidity, pressure and wind.

4.4 INTERCOMPARISONS

Intercomparisons of instruments and observing systems, together with agreed quality-control procedures, are essential for the establishment of compatible data sets. All intercomparisons should be planned and carried out carefully in order to maintain an adequate and uniform quality level of measurements of each meteorological variable. Many meteorological quantities cannot be directly compared with metrological standards and hence to absolute references — for example, visibility, cloud-base height and precipitation. For such quantities, intercomparisons are of primary value.

Comparisons or evaluations of instruments and observing systems may be organized and carried out at the following levels:

- (a) International comparisons, in which participants from all interested countries may attend in response to a general invitation;
- (b) Regional intercomparisons, in which participants from countries of a certain region (for example, WMO Regions) may attend in response to a general invitation;
- (c) Multilateral and bilateral intercomparisons, in which participants from two or more countries may agree to attend without a general invitation;
- (d) National intercomparisons, within a country.

Because of the importance of international comparability of measurements, WMO, through one of its constituent bodies, from time to time arranges for international and regional comparisons of instruments. Such intercomparisons or evaluations

of instruments and observing systems may be very lengthy and expensive. Rules have therefore been established so that coordination will be effective and assured. These rules are reproduced in Annexes 4.A and 4.B.² They contain general guidelines and should, when necessary, be supplemented by specific working rules for each intercomparison (see the relevant chapters of this Guide).

Reports of particular WMO international comparisons are referenced in other chapters in this

Guide (see, for instance, Part I, Chapters 3, 4, 9, 12, 14 and 15). Annex 4.C provides a list of the international comparisons which have been supported by the Commission for Instruments and Methods of Observation and which have been published in the WMO technical document series.

Reports of comparisons at any level should be made known and available to the meteorological community at large.

² Recommendations adopted by the Commission for Instruments and Methods of Observation at its eleventh session, through the annex to Recommendation 14 (CIMO-XI) and Annex IX (1994).

ANNEX 4.A

PROCEDURES OF WMO GLOBAL AND REGIONAL INTERCOMPARISONS OF INSTRUMENTS

1. A WMO intercomparison of instruments and methods of observation shall be agreed upon by the WMO constituent body concerned so that it is recognized as a WMO intercomparison.
 2. The Executive Council will consider the approval of the intercomparison and its inclusion in the programme and budget of WMO.
 3. When there is an urgent need to carry out a specific intercomparison that was not considered at the session of a constituent body, the president of the relevant body may submit a corresponding proposal to the President of WMO for approval.
 4. In good time before each intercomparison, the Secretary-General, in cooperation with the president of CIMO and possibly with presidents of other technical commissions or regional associations, or heads of programmes concerned, should make inquiries as to the willingness of one or more Members to act as a host country and as to the interest of Members in participating in the intercomparison.
 5. When at least one Member has agreed to act as host country and a reasonable number of Members have expressed their interest in participating, an international organizing committee should be established by the president of CIMO in consultation with the heads of the constituent bodies concerned, if appropriate.
 6. Before the intercomparison begins, the organizing committee should agree on its organization, for example, at least on the main objectives, place, date and duration of the intercomparison, conditions for participation, data acquisition, processing and analysis methodology, plans for the publication of results, intercomparison rules, and the responsibilities of the host(s) and the participants.
 7. The host should nominate a project leader who will be responsible for the proper conduct of the intercomparison, the data analysis, and the preparation of a final report of the intercomparison as agreed upon by the organizing committee. The project leader will be a member ex officio of the organizing committee.
 8. When the organizing committee has decided to carry out the intercomparison at sites in different host countries, each of these countries should designate a site manager. The responsibilities of the site managers and the overall project management will be specified by the organizing committee.
 9. The Secretary-General is invited to announce the planned intercomparison to Members as soon as possible after the establishment of the organizing committee. The invitation should include information on the organization and rules of the intercomparison as agreed upon by the organizing committee. Participating Members should observe these rules.
 10. All further communication between the host(s) and the participants concerning organizational matters will be handled by the project leader and possibly by the site managers unless other arrangements are specified by the organizing committee.
 11. Meetings of the organizing committee during the period of the intercomparison could be arranged, if necessary.
 12. After completion of the intercomparison, the organizing committee shall discuss and approve the main results of the data analysis of the intercomparison and shall make proposals for the utilization of the results within the meteorological community.
 13. The final report of the intercomparison, prepared by the project leader and approved by the organizing committee, should be published in the WMO Instruments and Observing Methods Report series.
-

ANNEX 4.B

**GUIDELINES FOR ORGANIZING WMO
INTERCOMPARISONS OF INSTRUMENTS****1. INTRODUCTION**

1.1 These guidelines are complementary to the procedures of WMO global and regional intercomparisons of meteorological instruments. They assume that an international organizing committee has been set up for the intercomparison and provide guidance to the organizing committee for its conduct. In particular, see Part I, Chapter 12, Annex 12.C.

1.2 However, since all intercomparisons differ to some extent from each other, these guidelines should be considered as a generalized checklist of tasks. They should be modified as situations so warrant, keeping in mind the fact that fairness and scientific validity should be the criteria that govern the conduct of WMO intercomparisons and evaluations.

1.3 Final reports of other WMO intercomparisons and the reports of meetings of organizing committees may serve as examples of the conduct of intercomparisons. These are available from the World Weather Watch Department of the WMO Secretariat.

**2. OBJECTIVES OF THE
INTERCOMPARISON**

The organizing committee should examine the achievements to be expected from the intercomparison and identify the particular problems that may be expected. It should prepare a clear and detailed statement of the main objectives of the intercomparison and agree on any criteria to be used in the evaluation of results. The organizing committee should also investigate how best to guarantee the success of the intercomparison, making use of the accumulated experience of former intercomparisons, as appropriate.

3. PLACE, DATE AND DURATION

3.1 The host country should be requested by the Secretariat to provide the organizing committee with a description of the proposed intercomparison

site and facilities (location(s), environmental and climatological conditions, major topographic features, and so forth). It should also nominate a project leader.³

3.2 The organizing committee should examine the suitability of the proposed site and facilities, propose any necessary changes, and agree on the site and facilities to be used. A full site and environmental description should then be prepared by the project leader. The organizing committee, in consultation with the project leader, should decide on the date for the start and the duration of the intercomparison.

3.3 The project leader should propose a date by which the site and its facilities will be available for the installation of equipment and its connection to the data-acquisition system. The schedule should include a period of time to check and test equipment and to familiarize operators with operational and routine procedures.

**4. PARTICIPATION IN THE
INTERCOMPARISON**

4.1 The organizing committee should consider technical and operational aspects, desirable features and preferences, restrictions, priorities, and descriptions of different instrument types for the intercomparison.

4.2 Normally, only instruments in operational use or instruments that are considered for operational use in the near future by Members should be admitted. It is the responsibility of the participating Members to calibrate their instruments against recognized standards before shipment and to provide appropriate calibration certificates. Participants may be requested to provide two identical instruments of each type in order to achieve more confidence in the data. However, this should not be a condition for participation.

3 When more than one site is involved, site managers shall be appointed, as required. Some tasks of the project leader, as outlined in this annex, shall be delegated to the site managers.

4.3 The organizing committee should draft a detailed questionnaire in order to obtain the required information on each instrument proposed for the intercomparison. The project leader shall provide further details and complete this questionnaire as soon as possible. Participants will be requested to specify very clearly the hardware connections and software characteristics in their reply and to supply adequate documentation (a questionnaire checklist is available from the WMO Secretariat).

4.4 The chairperson of the organizing committee should then request:

- (a) The Secretary-General to invite officially Members (who have expressed an interest) to participate in the intercomparison. The invitation shall include all necessary information on the rules of the intercomparison as prepared by the organizing committee and the project leader;
- (b) The project leader to handle all further contact with participants.

5. DATA ACQUISITION

5.1 Equipment set-up

5.1.1 The organizing committee should evaluate a proposed layout of the instrument installation prepared by the project leader and agree on a layout of instruments for the intercomparison. Special attention should be paid to fair and proper siting and exposure of instruments, taking into account criteria and standards of WMO and other international organizations. The adopted siting and exposure criteria shall be documented.

5.1.2 Specific requests made by participants for equipment installation should be considered and approved, if acceptable, by the project leader on behalf of the organizing committee.

5.2 Standards and references

The host country should make every effort to include at least one reference instrument in the intercomparison. The calibration of this instrument should be traceable to national or international standards. A description and specification of the standard should be provided to the organizing committee. If no recognized standard or reference exists for the variable(s) to be measured, the organizing committee should agree on a method to determine a reference for the intercomparison.

5.3 Related observations and measurements

The organizing committee should agree on a list of meteorological and environmental variables that should be measured or observed at the intercomparison site during the whole intercomparison period. It should prepare a measuring programme for these and request the host country to execute this programme. The results of this programme should be recorded in a format suitable for the intercomparison analysis.

5.4 Data-acquisition system

5.4.1 Normally the host country should provide the necessary data-acquisition system capable of recording the required analogue, pulse and digital (serial and parallel) signals from all participating instruments. A description and a block diagram of the full measuring chain should be provided by the host country to the organizing committee. The organizing committee, in consultation with the project leader, should decide whether analogue chart records and visual readings from displays will be accepted in the intercomparison for analysis purposes or only for checking the operation.

5.4.2 The data-acquisition system hardware and software should be well tested before the comparison is started and measures should be taken to prevent gaps in the data record during the intercomparison period.

5.5 Data-acquisition methodology

The organizing committee should agree on appropriate data-acquisition procedures, such as frequency of measurement, data sampling, averaging, data reduction, data formats, real-time quality control, and so on. When data reports have to be made by participants during the time of the intercomparison or when data are available as chart records or visual observations, the organizing committee should agree on the responsibility for checking these data, on the period within which the data should be submitted to the project leader, and on the formats and media that would allow storage of these data in the database of the host. When possible, direct comparisons should be made against the reference instrument.

5.6 Schedule of the intercomparison

The organizing committee should agree on an outline of a time schedule for the intercomparison, including normal and specific tasks, and prepare a

time chart. Details should be further worked out by the project leader and the project staff.

6. DATA PROCESSING AND ANALYSIS

6.1 Database and data availability

6.1.1 All essential data of the intercomparison, including related meteorological and environmental data, should be stored in a database for further analysis under the supervision of the project leader. The organizing committee, in collaboration with the project leader, should propose a common format for all data, including those reported by participants during the intercomparison. The organizing committee should agree on near-real-time monitoring and quality-control checks to ensure a valid database.

6.1.2 After completion of the intercomparison, the host country should, on request, provide each participating Member with a data set from its submitted instrument(s). This set should also contain related meteorological, environmental and reference data.

6.2 Data analysis

6.2.1 The organizing committee should propose a framework for data analysis and processing and for the presentation of results. It should agree on data conversion, calibration and correction algorithms, and prepare a list of terms, definitions, abbreviations and relationships (where these differ from commonly accepted and documented practice). It should elaborate and prepare a comprehensive description of statistical methods to be used that correspond to the intercomparison objectives.

6.2.2 Whenever a direct, time-synchronized, one-on-one comparison would be inappropriate (for example, in the case of spatial separation of the instruments under test), methods of analysis based on statistical distributions should be considered. Where no reference instrument exists (as for cloud base, meteorological optical range, and so on), instruments should be compared against a relative reference selected from the instruments under test, based on median or modal values, with care being taken to exclude unrepresentative values from the selected subset of data.

6.2.3 Whenever a second intercomparison is established some time after the first, or in a subsequent phase of an ongoing intercomparison, the methods of analysis and the presentation should

include those used in the original study. This should not preclude the addition of new methods.

6.2.4 Normally the project leader should be responsible for the data-processing and analysis. The project leader should, as early as possible, verify the appropriateness of the selected analysis procedures and, as necessary, prepare interim reports for comment by the members of the organizing committee. Changes should be considered, as necessary, on the basis of these reviews.

6.2.5 After completion of the intercomparison, the organizing committee should review the results and analysis prepared by the project leader. It should pay special attention to recommendations for the utilization of the intercomparison results and to the content of the final report.

7. FINAL REPORT OF THE INTERCOMPARISON

7.1 The organizing committee should draft an outline of the final report and request the project leader to prepare a provisional report based on it.

7.2 The final report of the intercomparison should contain, for each instrument, a summary of key performance characteristics and operational factors. Statistical analysis results should be presented in tables and graphs, as appropriate. Time-series plots should be considered for selected periods containing events of particular significance. The host country should be invited to prepare a chapter describing the database and facilities used for data-processing, analysis and storage.

7.3 The organizing committee should agree on the procedures to be followed for approval of the final report, such as:

- (a) The draft final report will be prepared by the project leader and submitted to all organizing committee members and, if appropriate, also to participating Members;
- (b) Comments and amendments should be sent back to the project leader within a specified time limit, with a copy to the chairperson of the organizing committee;
- (c) When there are only minor amendments proposed, the report can be completed by the project leader and sent to the WMO Secretariat for publication;
- (d) In the case of major amendments or if serious problems arise that cannot be resolved by

correspondence, an additional meeting of the organizing committee should be considered (the president of CIMO should be informed of this situation immediately).

7.4 The organizing committee may agree that intermediate and final results may be presented only by the project leader and the project staff at technical conferences.

8. RESPONSIBILITIES

8.1 Responsibilities of participants

8.1.1 Participants shall be fully responsible for the transportation of all submitted equipment, all import and export arrangements, and any costs arising from these. Correct import/export procedures shall be followed to ensure that no delays are attributable to this process.

8.1.2 Participants shall generally install and remove any equipment under the supervision of the project leader, unless the host country has agreed to do this.

8.1.3 Each participant shall provide all necessary accessories, mounting hardware, signal and power cables and connectors (compatible with the standards of the host country), spare parts and consumables for its equipment. Participants requiring a special or non-standard power supply shall provide their own converter or adapter. Participants shall provide all detailed instructions and manuals needed for installation, operation, calibration and routine maintenance.

8.2 Host country support

8.2.1 The host country should provide, if asked, the necessary information to participating Members on temporary and permanent (in the case of consumables) import and export procedures. It should assist with the unpacking and installation of the participants' equipment and provide rooms or cabinets to house equipment that requires protection from the weather and for the storage of spare parts, manuals, consumables, and so forth.

8.2.2 A reasonable amount of auxiliary equipment or structures, such as towers, shelters, bases or foundations, should be provided by the host country.

8.2.3 The necessary electrical power for all instruments shall be provided. Participants should be informed of the network voltage and frequency and their stability. The connection of instruments to the data-acquisition system and the power supply will be carried out in collaboration with the participants. The project leader should agree with each participant on the provision, by the participant or the host country, of power and signal cables of adequate length (and with appropriate connectors).

8.2.4 The host country should be responsible for obtaining legal authorization related to measurements in the atmosphere, such as the use of frequencies, the transmission of laser radiation, compliance with civil and aeronautical laws, and so forth. Each participant shall submit the necessary documents at the request of the project leader.

8.2.5 The host country may provide information on accommodation, travel, local transport, daily logistic support, and so forth.

8.3 Host country servicing

8.3.1 Routine operator servicing by the host country will be performed only for long-term inter-comparisons for which absence of participants or their representatives can be justified.

8.3.2 When responsible for operator servicing, the host country should:

- (a) Provide normal operator servicing for each instrument, such as cleaning, chart changing, and routine adjustments as specified in the participant's operating instructions;
- (b) Check each instrument every day of the intercomparison and inform the nominated contact person representing the participant immediately of any fault that cannot be corrected by routine maintenance;
- (c) Do its utmost to carry out routine calibration checks according to the participant's specific instructions.

8.3.3 The project leader should maintain in a log regular records of the performance of all equipment participating in the intercomparison. This log should contain notes on everything at the site that may have an effect on the intercomparison, all events concerning participating equipment, and all events concerning equipment and facilities provided by the host country.

9. **RULES DURING THE INTERCOMPARISON**

9.1 The project leader shall exercise general control of the intercomparison on behalf of the organizing committee.

9.2 No changes to the equipment hardware or software shall be permitted without the concurrence of the project leader.

9.3 Minor repairs, such as the replacement of fuses, will be allowed with the concurrence of the project leader.

9.4 Calibration checks and equipment servicing by participants, which requires specialist knowledge or specific equipment, will be permitted according to predefined procedures.

9.5 Any problems that arise concerning the participants' equipment shall be addressed to the project leader.

9.6 The project leader may select a period during the intercomparison in which equipment will be operated with extended intervals between normal routine maintenance in order to assess its susceptibility to environmental conditions. The same extended intervals will be applied to all equipment.

ANNEX 4.C

**REPORTS OF INTERNATIONAL COMPARISONS CONDUCTED UNDER
THE AUSPICES OF THE COMMISSION FOR INSTRUMENTS
AND METHODS OF OBSERVATION**

<i>Topic</i>	<i>Instruments and Observing Report No.</i>	<i>Title of report</i>
Pressure	46	<i>The WMO Automatic Digital Barometer Intercomparison (de Bilt, Netherlands, 1989–1991), J.P. van der Meulen, WMO/TD-No. 474 (1992).</i>
Humidity	34	<i>WMO Assmann Aspiration Psychrometer Intercomparison (Potsdam, German Democratic Republic, 1987), D. Sonntag, WMO/TD-No. 289 (1989).</i>
Humidity	38	<i>WMO International Hygrometer Intercomparison (Oslo, Norway, 1989), J. Skaar, K. Hegg, Moe and K.S. Smedstud, WMO/TD-No. 316 (1989).</i>
Wind	62	<i>WMO Wind Instrument Intercomparison (Mont Aigoual, France, 1992–1993), P. Gregoire and G. Oualid, WMO/TD-No. 859 (1997).</i>
Precipitation	17	<i>International Comparison of National Precipitation Gauges with a Reference Pit Gauge (1984), B. Sevruk and W.R. Hamon, WMO/TD-No. 38 (1984).</i>
Precipitation	67	<i>WMO Solid Precipitation Measurement Intercomparison – Final Report (1998), B.E. Goodison, P.Y.T. Louie and D. Yang, WMO/TD-No. 872. (1998).</i>
Radiation ^a	16	<i>Radiation and Sunshine Duration Measurements: Comparison of Pyranometers and Electronic Sunshine Duration Recorders of RA VI (Budapest, Hungary, July–December 1984), G. Major, WMO/TD-No. 146 (1986).</i>
Radiation ^a	43	<i>First WMO Regional Pyrheliometer Comparison of RA II and RA V (Tokyo, Japan, 23 January–4 February 1989), Y. Sano, WMO/TD-No. 308 (1989).</i>
Radiation ^a	44	<i>First WMO Regional Pyrheliometer Comparison of RA IV (Ensenada, Mexico, 20–27 April 1989), I. Galindo, WMO/TD-No. 345 (1989).</i>
Radiation ^a	53	<i>Segunda Comparación de la OMM de Pirheliómetros Patrones Nacionales AR III (Buenos Aires, Argentina, 25 November–13 December 1991), M. Ginzburg, WMO/TD-No. 572 (1992).</i>
Radiation ^a	64	<i>Tercera Comparación Regional de la OMM de Pirheliómetros Patrones Nacionales AR III – Informe Final (Santiago, Chile, 24 February–7 March 1997), M.V. Muñoz, WMO/TD-No. 861 (1997).</i>
Sunshine duration	16	<i>Radiation and Sunshine Duration Measurements: Comparison of Pyranometers and Electronic Sunshine Duration – Recorders of RA VI (Budapest, Hungary, July–December 1984), G. Major, WMO/TD-No. 146 (1986).</i>
Visibility	41	<i>The First WMO Intercomparison of Visibility Measurements (United Kingdom, 1988/1989), D.J. Griggs, D.W. Jones, M. Ouldrige and W.R. Sparks, WMO/TD-No. 401 (1990).</i>
Radiosondes	28	<i>WMO International Radiosonde Comparison, Phase I (Beaufort Park, United Kingdom, 1984), A.H. Hooper, WMO/TD-No. 174 (1986).</i>

^a The reports of the WMO International Pyrheliometer Intercomparisons, conducted by the World Radiation Centre at Davos (Switzerland) and carried out at five-yearly intervals, are also distributed by WMO.

<i>Topic</i>	<i>Instruments and Observing Report No.</i>	<i>Title of report</i>
Radiosondes	29	<i>WMO International Radiosonde Intercomparison, Phase II (Wallops Island, United States, 4 February–15 March 1985), F.J. Schmidlin, WMO/TD-No. 312 (1988).</i>
Radiosondes	30	<i>WMO International Radiosonde Comparison (United Kingdom, 1984/ United States, 1985), J. Nash and F.J. Schmidlin, WMO/TD-No. 195 (1987).</i>
Radiosondes	40	<i>WMO International Radiosonde Comparison, Phase III (Dzhambul, USSR, 1989), A. Ivanov, A. Kats, S. Kurnosenko, J. Nash and N. Zaitseva, WMO/TD-No. 451 (1991).</i>
Radiosondes	59	<i>WMO International Radiosonde Comparison, Phase IV (Tsukuba, Japan, 15 February–12 March 1993), S. Yagy, A. Mita and N. Inoue, WMO/TD-No. 742 (1996).</i>
Radiosondes	76	<i>WMO Intercomparison of GPS Radiosondes – Executive Summary (Alcantãra, Maranhão, Brazil, 20 May–10 June 2001), R.B. da Silveira, G. Fisch, L.A.T. Machado, A.M. Dall’Antonia Jr., L.F. Sapucci, D. Fernandes and J. Nash, WMO/TD-No. 1153 (2003).</i>
Radiosondes	83	<i>WMO Intercomparison of Radiosonde Systems (Vacoas, Mauritius, 2–25 February 2005), J. Nash, R. Smout, T. Oakley, B. Pathack and S. Kurnosenko, WMO/TD-No. 1303 (2006).</i>
Cloud-base height	32	<i>WMO International Ceilometer Intercomparison (United Kingdom, 1986), D.W. Jones, M. Ouldrige and D.J. Painting, WMO/TD-No. 217 (1988).</i>
Present weather	73	<i>WMO Intercomparison of Present Weather Sensors/Systems – Final Report (Canada and France France, 1993–1995), M. Leroy, C. Bellevaux, J.P. Jacob, WMO/TD-No. 887 (1998).</i>

REFERENCES AND FURTHER READING

- International Electrotechnical Commission, 1990: *Classification of Environmental Conditions*. IEC 721.
- International Organization for Standardization, 1989a: *Sampling Procedures for Inspection by Attributes*. – Part I: Sampling plans indexed by acceptable quality level (AQL) for lot-by-lot inspection. ISO 2859-1: 1989.
- International Organization for Standardization, 1989b: *Sampling Procedures and Charts for Inspection by Variables for Percent Nonconforming*. ISO 3951: 1989.
- International Organization for Standardization, 1993: *International Vocabulary of Basic and General Terms in Metrology*. Second edition, ISO Guide 99:1993.
- Hoehne, W.E., 1971: *Standardizing Functional Tests*. NOAA Technical Memorandum, NWS T&EL-12, United States Department of Commerce, Sterling, Virginia.
- Hoehne, W.E., 1972: Standardizing functional tests. *Preprints of the Second Symposium on Meteorological Observations and Instrumentation*, American Meteorological Society, pp. 161–165.
- Hoehne, W.E., 1977: *Progress and Results of Functional Testing*. NOAA Technical Memorandum NWS T&EL-15, United States Department of Commerce, Sterling, Virginia.
- National Weather Service, 1980: *Natural Environmental Testing Criteria and Recommended Test Methodologies for a Proposed Standard for National Weather Service Equipment*. United States Department of Commerce, Sterling, Virginia.
- National Weather Service, 1984: *NWS Standard Environmental Criteria and Test Procedures*. United States Department of Commerce, Sterling, Virginia.
- World Meteorological Organization/International Council of Scientific Unions, 1986: *Revised Instruction Manual on Radiation Instruments and Measurements* (C. Fröhlich and J. London, eds). World Climate Research Programme Publications Series No. 7, WMO/TD-No. 149, Geneva.
- World Meteorological Organization, 1989: *Analysis of Instrument Calibration Methods Used by Members* (H. Doering). Instruments and Observing Methods Report No. 45, WMO/TD-No. 310, Geneva.
-

CHAPTER 5

TRAINING OF INSTRUMENT SPECIALISTS

5.1 INTRODUCTION

5.1.1 General

Given that the science and application of meteorology are based on continuous series of measurements using instruments and systems of increasing sophistication, this chapter is concerned with the training of those specialists who deal with the planning, specification, design, installation, calibration, maintenance and application of meteorological measuring instruments and remote-sensing systems. This chapter is aimed at technical managers and trainers and not least at the instrument specialists themselves who want to advance in their profession.

Training skilled personnel is critical to the availability of necessary and appropriate technologies in all countries so that the WMO Global Observing System can produce cost-effective data of uniform good quality and timeliness. However, more than just technical ability with instruments is required. Modern meteorology requires technologists who are also capable as planners and project managers, knowledgeable about telecommunications and data processing, good advocates for effective technical solutions, and skilled in the areas of financial budgets and people management. Thus, for the most able instrument specialists or meteorological instrument systems engineers, training programmes should be broad-based and include personal development and management skills as well as expertise in modern technology.

Regional Training Centres (RTCs) have been established in many countries under the auspices of WMO, and many of them offer training in various aspects of the operation and management of instruments and instrument systems. Regional Training Centres are listed in the annex. Similarly, Regional Instrument Centres (RICs) have been set up in many places, and some of them can provide training. Their locations and functions are listed in Part I, Chapter 1, Annex 1. A and are discussed briefly in section 5.5.1.2.

5.1.2 Technology transfer

Training is a vital part of the process of technology transfer, which is the developmental process of introducing new technical resources into service to improve quality and reduce operating costs. New

resources demand new skills for the introductory process and for ongoing operation and maintenance. This human dimension is more important in capacity building than the technical material.

As meteorology is a global discipline, the technology gap between developed and developing nations is a particular issue for technology transfer. Providing for effective training strategies, programmes and resources which foster self-sustaining technical infrastructures and build human capacity in developing countries is a goal that must be kept constantly in view.

5.1.3 Application to all users of meteorological instruments

This chapter deals with training mainly as an issue for National Hydrometeorological Services. However, the same principles apply to any organizations that take meteorological measurements, whether they train their own staff or expect to recruit suitably qualified personnel. In common with all the observational sciences, the benefits of training to ensure standardized measurement procedures and the most effective use and care of equipment, are self-evident.

5.2 APPROPRIATE TRAINING FOR OPERATIONAL REQUIREMENTS

5.2.1 Theory and practice

Taking measurements using instrument systems depends on physical principles (for example, the thermal expansion of mercury) to sense the atmospheric variables and transduce them into a standardized form that is convenient for the user, for example, a recorded trace on a chart or an electrical signal to input into an automatic weather station. The theoretical basis for understanding the measurement process must also take into account the coupling of the instrument to the quantity being measured (the representation or “exposure”) as well as the instrumental and observational errors with which every measurement is fraught. The basic measurement data is then often further processed and coded in more or less complex ways, thus requiring further theoretical understanding, for example, the reduction of atmospheric pressure to

mean sea level and upper-air messages derived from a radiosonde flight.

Taking the measurement also depends on practical knowledge and skill in terms of how to install and set up the instrument to take a standardized measurement, how to operate it safely and accurately, and how to carry out any subsequent calculations or coding processes with minimal error.

Thus, theoretical and practical matters are closely related in achieving measurement data of known quality, and the personnel concerned in the operation and management of the instrument systems need theoretical understanding and practical skills which are appropriate to the complexity and significance of their work. The engineers who design or maintain complex instrumentation systems require a particularly high order of theoretical and practical training.

5.2.2 Matching skills to the tasks

Organizations need to ensure that the qualifications, skills and numbers of their personnel or other contractors (and thus training) are well matched to the range of tasks to be performed. For example, the training needed to read air temperature in a Stevenson screen is at the lower end of the range of necessary skills, while theoretical and practical training at a much higher level is plainly necessary in order to specify, install, operate and maintain automatic weather stations, meteorological satellite receivers and radars.

Therefore, it is useful to apply a classification scheme for the levels of qualification for operational requirements, employment, and training purposes. The national grades of qualification in technical education applicable in a particular country will be important benchmarks. To help the international community achieve uniform quality in their meteorological data acquisition and processing, WMO recommends the use of its own classification of personnel with the accompanying duties that they should be expected to carry out competently.

5.2.3 WMO classification of personnel

The WMO classification scheme¹ identifies two broad categories of personnel: graduate professionals and technicians (WMO, 2002*a*). For meteorological and hydrological personnel, these categories are designated as follows: meteorologist

and meteorological technician, and hydrologist and hydrological technician, respectively. The recommended syllabus for each class includes a substantial component on instruments and methods of observation related to the education, training and duties expected at that level. The WMO classification of personnel also sets guidelines for the work content, qualifications and skill levels required for instrument specialists. Section 7.3 of WMO (2002*a*) includes an example of competency requirements, while WMO (2002*b*) offers detailed syllabus examples for the initial training and specialization of meteorological personnel. These guidelines enable syllabi and training courses to be properly designed and interpreted; they also assist in the definition of skill deficits and aid the development of balanced national technical skill resources.

5.3 SOME GENERAL PRINCIPLES FOR TRAINING

5.3.1 Management policy issues

5.3.1.1 A personnel plan

It is important that National Meteorological Services have a personnel plan that includes instrument specialists, recognizing their value in the planning, development and maintenance of adequate and cost-effective weather observing programmes. The plan would show all specialist instrument personnel at graded levels (WMO, 2002*a*) of qualification. Skill deficits should be identified and provision made for recruitment and training.

5.3.1.2 Staff retention

Every effort should be made to retain scarce instrumentation technical skills by providing a work environment that is technically challenging, has opportunities for career advancement, and has salaries comparable with those of other technical skills, both within and outside the Meteorological Service.

5.3.1.3 Personnel development

Training should be an integral part of the personnel plan. The introduction of new technology and re-equipment imply new skill requirements. New recruits will need training appropriate to their previous experience, and skill deficits can also be made up by enhancing the skills of other staff. This training also provides the path for career progression. It is helpful if each staff member has a career profile showing training, qualifications and career

¹ Classification scheme approved by the WMO Executive Council at its fiftieth session (1998), and endorsed by the World Meteorological Congress at its thirteenth session (1999).

progression, maintained by the training department, in order to plan personnel development in an orderly manner.

5.3.1.4 **Balanced training**

National training programmes should aim at a balance of skills over all specialist classes giving due attention to the training, supplementation and refresher phases of training, and which result in a self-sustaining technical infrastructure.

5.3.2 **Aims and objectives for training programmes**

In order to achieve maximum benefits from training it is essential to have clear aims and specific objectives on which to base training plans, syllabi and expenditure. The following strategic aims and objectives for the training of instrument specialists may be considered.

5.3.2.1 **For managers**

Management aims in training instrument specialists should be, among others:

- (a) To improve and maintain the quality of information in all meteorological observing programmes;
- (b) To enable National Meteorological and Hydrological Services (NMHSs) to become self-reliant in the knowledge and skills required for the effective planning, implementation and operation of meteorological data-acquisition programmes, and to enable them to develop maintenance services ensuring maximum reliability, accuracy and economy from instrumentation systems;
- (c) To realize fully the value of capital invested in instrumentation systems over their optimum economic life.

5.3.2.2 **For trainers**

The design of training courses should aim:

- (a) To provide balanced programmes of training which meet the defined needs of the countries within each region for skills at graded levels;
- (b) To provide effective knowledge transfer and skill enhancement in National Meteorological Services by using appropriately qualified tutors, good training aids and facilities, and effective learning methods;
- (c) To provide for monitoring the effectiveness of training by appropriate assessment and reporting procedures;
- (d) To provide training at a minimum necessary cost.

5.3.2.3 **For trainers and instrument specialists**

The general objective of training is to equip instrument specialists and engineers (at graded levels of training and experience):

- (a) To appreciate the use, value and desirable accuracy of all instrumental measurements;
- (b) To understand and apply the principles of siting instrument enclosures and instruments so that representative, homogeneous and compatible data sets are produced;
- (c) To acquire the knowledge and skill to carry out installations, adjustments and repairs and to provide a maintenance service ensuring maximum reliability, accuracy and economy from meteorological instruments and systems;
- (d) To be able to diagnose faults logically and quickly from observed symptoms and trace and rectify systematically their causes;
- (e) To understand the sources of error in measurements and be competent in the handling of instrument standards and calibration procedures in order to minimize systematic errors;
- (f) To keep abreast of new technologies and their appropriate application and acquire new knowledge and skills by means of special and refresher courses;
- (g) To plan and design data-acquisition networks, and manage budgets and technical staff;
- (h) To manage projects involving significant financial, equipment and staff resources and technical complexity;
- (i) To modify, improve, design and make instruments for specific purposes;
- (j) To design and apply computer and telecommunications systems and software, control measurements and process raw instrumental data into derived forms and transmit coded messages.

5.3.3 **Training for quality**

Meteorological data acquisition is a complex and costly activity involving human and material resources, communication and computation. It is necessary to maximize the benefit of the information derived while minimizing the financial and human resources required in this endeavour.

The aim of quality data acquisition is to maintain the flow of representative, accurate and timely instrumental data into the national meteorological processing centres at the least cost. Through every stage of technical training, a broad appreciation of

how all staff can affect the quality of the end product should be encouraged. The discipline of total quality management (Walton, 1986, and Imai, 1986) considers the whole measurement environment (applications, procedures, instruments and personnel) in so far as each of its elements may affect quality. In total quality management, the data-acquisition activity is studied as a system or series of processes. Critical elements of each process, for example, time delay, are measured and the variation in the process is defined statistically. Problem-solving tools are used by a small team of people who understand the process, to reduce process variation and thereby improve quality. Processes are continuously refined by incremental improvement.

WMO (1990) provides a checklist of factors under the following headings:

- (a) Personnel recruitment and training;
- (b) Specification, design and development;
- (c) Instrument installation;
- (d) Equipment maintenance;
- (e) Instrument calibration.

All of the above influence data quality from the instrument expert's point of view. The checklist can be used by managers to examine areas over which they have control to identify points of weakness, by training staff within courses on total quality management concepts, and by individuals to help them be aware of areas where their knowledge and skill should make a valuable contribution to overall data quality.

The International Organization for Standardization provides for formal quality systems, defined by the ISO 9000 group of specifications (ISO, 1994a; 1994b), under which organizations may be certified by external auditors for the quality of their production processes and services to clients. These quality systems depend heavily on training in quality management techniques.

5.3.4 How people learn

5.3.4.1 The learning environment

Learning is a process that is very personal to the individual, depending on a person's needs and interests. People are motivated to learn when there is the prospect of some reward, for example, a salary increase. Nonetheless, job satisfaction, involvement, personal fulfilment, having some sense of power or influence, and the affirmation of peers and superiors are also strong motivators. These rewards come through enhanced work

performance and relationships with others on the job.

Learning is an active process in which the student reacts to the training environment and activity. A change of behaviour occurs as the student is involved mentally, physically and emotionally. Too much mental or emotional stress during learning time will be counterproductive.

Trainers and managers should attempt to stimulate and encourage learning by creating a conducive physical and psychological climate and by providing appropriate experiences and methods that promote learning. Students should feel at ease and be comfortable in the learning environment, which should not provide distractions. The "psychological climate" can be affected by the student's motivation, the manner and vocabulary of the tutor, the affirmation of previously-acquired knowledge, avoiding embarrassment and ridicule, establishing an atmosphere of trust, and the selection of teaching methods.

5.3.4.2 Important principles

Important principles for training include the following:

- (a) *Readiness*: Learning will take place more quickly if the student is ready, interested and wants to learn;
- (b) *Objectives*: The objectives of the training (including performance standards) should be clear to those responsible and those involved;
- (c) *Involvement*: Learning is more effective if students actively work out solutions and do things for themselves, rather than being passively supplied with answers or merely shown a skill;
- (d) *Association*: Learning should be related to past experiences, noting similarities and differences;
- (e) *Learning rate*: The rate of training should equal the rate at which an individual can learn (confirmed by testing), with learning distributed over several short sessions rather than one long session being more likely to be retained;
- (f) *Reinforcement*: Useful exercises and repetition will help instil new learning;
- (g) *Intensity*: Intense, vivid or dramatic experiences capture the imagination and make more impact;
- (h) *Effectiveness*: Experiences which are satisfying are better for learning than those which are embarrassing or annoying. Approval encourages learning;

- (i) *Support*: The trainee's supervisor must be fully supportive of the training and must be able to maintain and reinforce it;
- (j) *Planning and evaluation*: Training should be planned, carried out and evaluated systematically, in the context of organizational needs.

5.3.4.3 Varying the methods

People in a group will learn at different speeds. Some training methods (see section 5.4) will suit some individuals better than others and will be more effective under different circumstances. Using a variety of training methods and resources will help the group learn more rapidly.

Research (Moss, 1987) shows that, through the senses, our retention of learning occurs from the following:

- (a) Sight (83 per cent);
- (b) Hearing (11 per cent);
- (c) Other senses (6 per cent).

However, we learn best by actually performing the task. Methods or training media in general order of decreasing effectiveness are:

- (a) Real experience;
- (b) Simulated practical experience;
- (c) Demonstrations and discussions;
- (d) Physical models and text;
- (e) Film, video and computer animation;
- (f) Graphs, diagrams and photographs;
- (g) Written text;
- (h) Lectures.

These methods may, of course, be used in combination. A good lecture may include some of the other methods.

Traditional educational methods rely heavily on the spoken and written word, whereas evidence shows that visual and hands-on experience are far more powerful.

Training for instrument specialists can take advantage of the widest range of methods and media. The theoretical aspects of measurement and instrument design are taught by lectures based on text and formulas and supported by graphs and diagrams. A working knowledge of the instrument system for operation, maintenance and calibration can be gained by the use of photographs with text, films or videos showing manual adjustments, models which may be disassembled, demonstrations, and ultimately practical experience in operating systems. Unsafe practices or modes of use may be simulated.

5.3.5 Personal skills development

A meteorological instrument systems engineering group needs people who are not only technically capable, but who are broadly educated and are able to speak and write well. Good personal communication skills are necessary to support and justify technical programmes and particularly in management positions. Skilled technologists should receive training so that they can play a wider role in the decisions that affect the development of their Meteorological Service.

There is a tendency for staff who are numerate and have practical, manual ability to be less able with verbal and written linguistic skills. In the annual personal performance review of their staff, managers should identify any opportunities for staff to enhance their personal skills by taking special courses, for example, in public speaking, negotiation, letter and report writing or assertiveness training. Some staff may need assistance in learning a second language in order to further their training.

5.3.6 Management training

Good management skills are an important component of engineering activity. These skills involve time management; staff motivation, supervision and performance assessment (including a training dimension); project management (estimation of resources, budgets, time, staff and materials, and scheduling); problem solving; quality management; and good verbal and written communication skills. Instrument specialists with leadership aptitude should be identified for management training at an appropriate time in their careers.

Today's manager may have access to a personal computer and be adept in the use of office and engineering software packages to be used, for example, for word processing, spreadsheets, databases, statistical analysis with graphics, engineering drawing, flow charting, and project management. Training in the use of these tools can add greatly to personal productivity.

5.3.7 A lifelong occupation

5.3.7.1 Three training phases

Throughout their working lives, instrument specialists should expect to be engaged in repeated cycles of personal training, both through structured study and informal on-the-job training or self-study. Three phases of training can be recognized as follows:

- (a) A developmental, training phase when the trainee acquires general theory and practice at graded levels;
- (b) A supplementation phase where the training is enhanced by learning about specific techniques and equipment;
- (c) A refresher phase where some years after formal training the specialist needs refresher training and updates on current techniques and equipment.

5.3.7.2 Training

For instrument specialists, the training phase of technical education and training usually occurs partly in an external technical institute and partly in the training establishment of the NMHS where a basic course in meteorological instruments is taken. Note that technical or engineering education may extend over both WMO class levels.

5.3.7.3 Specialist training

The supplementation phase will occur over a few years as the specialist takes courses on special systems, for example, automatic weather stations, or radar, or on disciplines like computer software or management skills. Increasing use will be made of external training resources, including WMO-sponsored training opportunities.

5.3.7.4 Refresher training

As the instrument specialist's career progresses there will be a need for periodic refresher courses to cover advances in instrumentation and technology, as well as other supplementary courses.

There is an implied progression in these phases. Each training course will assume that students have some prerequisite training on which to build.

5.4 THE TRAINING PROCESS

5.4.1 The role of the trainer

Most instrument specialists find themselves in the important and satisfying role of trainer from time to time and for some it will become their full-time work, with its own field of expertise. All trainers need an appreciation of the attributes of a good trainer.

A good trainer is concerned with quality results, is highly knowledgeable in specified fields, and has good communication skills. He or she will have

empathy with students, and will be patient and tolerant, ready to give encouragement and praise, flexible and imaginative, and practised in a variety of training techniques.

Good trainers will set clear objectives and plan and prepare training sessions well. They will maintain good records of training prescriptions, syllabi, course notes, courses held and the results, and of budgets and expenditures. They will seek honest feedback on their performance and be ready to modify their approach. They will also expect to be always learning.

5.4.2 Task analysis

The instrument specialist must be trained to carry out many repetitive or complex tasks for the installation, maintenance and calibration of instruments, and sometimes for their manufacture. A task analysis form may be used to define the way in which the job is to be done, and could be used by the tutor in training and then as a checklist by the trainee. First, the objective of the job and the required standard of performance is written down. The job is broken down into logical steps or stages of a convenient size. The form might consist of a table whose columns are headed, for example with: steps, methods, measures, and reasons:

- (a) Steps (what must be done): These are numbered and consist of a brief description of each step of the task, beginning with an active verb;
- (b) Methods (how it is to be done): An indication of the method and equipment to be used or the skill required;
- (c) Measures (the standard required): Includes a qualitative statement, reference to a specification clause, test, or actual measure;
- (d) Reasons (why it must be done): A brief explanation of the purpose of each step.

A flow chart would be a good visual means of relating the steps to the whole task, particularly when the order of the steps is important or if there are branches in the procedure.

5.4.3 Planning the training session

The training process consists of four stages, as shown in the opposite figure:

- (a) Planning:
 - (i) Review the training objectives, established by the employing organization or standards-setting body (for example, WMO);
 - (ii) Analyse the features of the body of knowledge, task or skill that is the subject of the session;

- (iii) Review the characteristics of the students: qualifications, work experience, language ability, specific problems;
 - (iv) Assess the required level of training (Which students may need special attention?);
 - (v) Determine the objectives for the session (What results are required? How can they be measured?);
- (b) Preparation:
- (i) Select course content: Assemble information, organize it in a logical sequence;
 - (ii) Determine training methods and media: appropriate to the topic, so as to create and maintain interest (see section 5.4.5);
 - (iii) Prepare a session plan: Set out the detailed plan with the time of each activity;
 - (iv) Plan evaluation: What information is required and how is it to be collected? Select a method and prepare the questions or assignment;
- (c) Presentation:
- (i) Carry out training, using the session plan;
 - (ii) Encourage active learning and participation;
- (iii) Use a variety of methods;
 - (iv) Use demonstrations and visual aids;
- (d) Evaluation:
- (i) Carry out the planned evaluation with respect to the objectives;
 - (ii) Summarize results;
 - (iii) Review the training session for effectiveness in light of the evaluation;
 - (iv) Consider improvements in content and presentation;
 - (v) Write conclusions;
 - (vi) Apply feedback to the next planning session.

All training will be more effective if these stages are worked through carefully and systematically.

5.4.4 Effectiveness of training

5.4.4.1 Targeted training

With the limited resources available for training, real effort should be devoted to maximizing the effectiveness of training. Training courses and resources should be dedicated to optimizing the benefits of training the right personnel at the most useful time. For example, too little training may be a waste of resources, sending management staff to a course for maintenance technicians would be inappropriate, and it is pointless to train people 12 months before they have access to new technology.

Training opportunities and methods should be selected to best suit knowledge and skills requirements and trainees, bearing in mind their educational and national backgrounds. To ensure maximum effectiveness, training should be evaluated.

5.4.4.2 Evaluating the training

Evaluation is a process of obtaining certain information and providing it to those who can influence future training performance. Several approaches to evaluating training may be applied, depending on who needs the information among the following:

- (a) WMO, which is concerned with improving the quality of data collected in the Global Observing System. It generates training programmes, establishes funds and uses the services of experts primarily to improve the skill base in developing countries;
- (b) The National Meteorological Service, which needs quality weather data and is concerned with the overall capability of the division that performs data acquisition and particular instrumentation tasks within

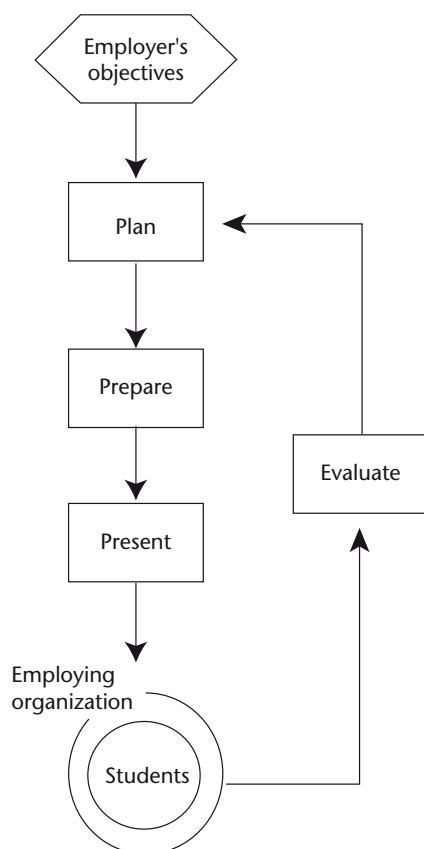

Figure 5.2. Stages in the training process

certain staff number constraints. It is interested in the budget and cost-benefit of training programmes;

- (c) The training department or Regional Training Centre, which is concerned with establishing training programmes to meet specified objectives within an agreed budget. Its trainers need to know how effective their methods are in meeting these objectives and how they can be improved;
- (d) Engineering managers, who are concerned with having the work skills to accomplish their area of responsibility to the required standard and without wasting time or materials;
- (e) Trainees, who are concerned with the rewards and job satisfaction that come with increased competence. They will want a training course to meet their needs and expectations.

Thus, the effectiveness of training should be evaluated at several levels. National and Regional Training Centres might evaluate their programmes annually and triennially, comparing the number of trainees in different courses and pass levels against budgets and the objectives which have been set at the start of each period. Trainers will need to evaluate the relevance and effectiveness of the content and presentation of their courses.

5.4.4.3 Types of evaluation

Types of evaluation include the following:

- (a) A training report, which does not attempt to measure effectiveness. Instead, it is a factual statement of, for example, the type and the number of courses offered, dates and durations, the number of trainees trained and qualifying, and the total cost of training. In some situations, a report is required on the assessed capability of the student;
- (b) Reaction evaluation, which measures the reaction of the trainees to the training programme. It may take the form of a written questionnaire through which trainees score, at the end of the course, their opinions about relevance, content, methods, training aids, presentation and administration. As such, this method cannot improve the training that they receive. Therefore, every training course should have regular opportunities for review and student feedback through group discussion. This enables the trainer to detect any problems with the training or any individual's needs and to take appropriate action;
- (c) Learning evaluation, which measures the trainee's new knowledge and skills, which are best compared against a pre-training test.

Various forms of written test (essay, short answer questions, true or false questions, multiple-choice questions, drawing a diagram or flow chart) can be devised to test a trainee's knowledge. Trainees may usefully test and score their own knowledge. Skills are best tested by a set practical assignment or by observation during on-the-job training (WMO, 1990). A checklist of required actions and skills (an observation form) for the task may be used by the assessor;

- (d) Performance evaluation, which measures how the trainee's performance on the job has changed after some time, in response to training, which is best compared with a pre-training test. This evaluation may be carried out by the employer at least six weeks after training, using an observation form, for example. The training institution may also make an assessment by sending questionnaires to both the employer and the trainee;
- (e) Impact evaluation, which measures the effectiveness of training by determining the change in an organization or work group. This evaluation may require planning and the collection of baseline data before and after the specific training. Some measures might be: bad data and the number of data elements missing in meteorological reports, the time taken to perform installations, and the cost of installations.

5.4.4.4 Training for trainers

Trainers also require training to keep abreast of technological advances, to learn about new teaching techniques and media, and to catch a fresh vision of their work. There should be provision in their NMHS's annual budget to allow the NMHS's training staff to take training opportunities, probably in rotation.

Some options are: personal study; short courses (including teaching skills) run by technical institutes; time out for study for higher qualifications; visits to the factories of meteorological equipment manufacturers; visits and secondments to other NMHS and RICs; and attendance at WMO and other training and technical conferences.

5.4.5 Training methods and media

The following list, arranged in alphabetical order, contains only brief notes to serve as a reminder or to suggest possibilities for training methods (more details may be found in many other sources, such as Moss (1987) and Craig (1987)):

- (a) Case study:
 - (i) A particular real-life problem or development project is set up for study by individuals, or often a team;
 - (ii) The presentation of the results could involve formal documentation as would be expected in a real situation;
- (b) Classroom lecture:
 - (i) This is most suitable for developing an understanding of information which is best mediated in spoken and written form: basic knowledge, theoretical ideas, calculations, procedures;
 - (ii) Visual media and selected printed hand-out material are very useful additions;
 - (iii) There should be adequate time for questions and discussion;
 - (iv) Lectures tend to be excessively passive;
- (c) Computer-assisted instruction:
 - (i) This uses the capability of the personal computer to store large amounts of text and images, organized by the computer program into learning sequences, often with some element of interactive choice by the student through menu lists and screen selection buttons;
 - (ii) The logical conditions and branching and looping structures of the program simulate the learning processes of selecting a topic for study based on the student's needs, presenting information, testing for understanding with optional answers and then directing revision until the correct answer is obtained;
 - (iii) Some computer languages, for example, ToolBook for the IBM personal computer and HyperCard for the Macintosh, are designed specifically for authoring and presenting interactive training courses in what are known as "hypermedia";
 - (iv) Modern systems use colour graphic screens and may include diagrams, still pictures and short moving sequences, while a graphical user interface is used to improve the interactive communication between the student and the program;
 - (v) Entire meteorological instrument systems, for example, for upper-air sounding, may be simulated on the computer;
 - (vi) Elaborate systems may include a laser video disc or DVD player or CD-ROM cartridge on which large amounts of text and moving image sequences are permanently stored;
- (vii) The software development and capital cost of computer-assisted instruction systems range from modest to very great; they are beginning to replace multimedia and video tape training aids;
- (d) Correspondence courses:
 - (i) The conventional course consists of lessons with exercises or assignments which are mailed to the student at intervals;
 - (ii) The tutor marks the assignments and returns them to the student with the next lesson;
 - (iii) Sometimes it is possible for students to discuss difficulties with their tutor by telephone;
 - (iv) Some courses may include audio or video tapes, or computer disks, provided that the student has access to the necessary equipment;
 - (v) At the end of the course an examination may be held at the training centre;
- (e) Demonstrations:
 - (i) The tutor demonstrates techniques in a laboratory or working situation;
 - (ii) This is necessary for the initial teaching of manual maintenance and calibration procedures;
 - (iii) Students must have an opportunity to try the procedures themselves and ask questions;
- (f) Distance learning:
 - (i) Students follow a training course, which is usually part-time, in their own locality and at times that suit their work commitments, remote from the training centre and their tutor;
 - (ii) Study may be on an individual or group basis;
 - (iii) Some institutions specialize in distance-learning capability;
 - (iv) Distance learning is represented in this section by correspondence courses, television lectures and distance learning with telecommunications;
- (g) Distance learning with telecommunications:
 - (i) A class of students is linked by special telephone equipment to a remote tutor. They study from a printed text. Students each have a microphone which enables them to enter into discussions and engage in question and answer dialogue. Any reliable communications medium could be

- used, including satellite, but obviously communications costs will be an issue;
- (ii) In more elaborate and costly systems, all students have computers that are linked to each other and to the remote tutor's computer via a network; or the tutor teaches from a special kind of television studio and appears on a television monitor in the remote classroom, which also has a camera and microphones so that the tutor can see and hear the students;
- (h) Exercises and assignments:
 - (i) These often follow a lecture or demonstration;
 - (ii) They are necessary so that students actively assimilate and use their new knowledge;
 - (iii) An assignment may involve research or be a practical task;
 - (i) Exhibits:
 - (i) These are prepared display material and models which students can examine;
 - (ii) They provide a useful overview when the real situation is complex or remote;
 - (j) Field studies and visits:
 - (i) Trainees carry out observing practices and study instrument systems in the field environment, most usefully during installation, maintenance or calibration;
 - (ii) Visits to meteorological equipment manufacturers and other Meteorological Services will expand the technical awareness of specialists;
 - (k) Group discussion/problem solving:
 - (i) The class is divided into small groups of four to six persons;
 - (ii) The group leader should ensure that all students are encouraged to contribute;
 - (iii) A scribe or recorder notes ideas on a board in full view of the group;
 - (iv) In a brainstorming session, all ideas are accepted in the first round without criticism, then the group explores each idea in detail and ranks its usefulness;
 - (l) Job rotation/secondment:
 - (i) According to a timetable, the student is assigned to a variety of tasks with different responsibilities often under different supervisors or trainers in order to develop comprehensive work experience;
 - (ii) Students may be seconded for a fixed term to another department, manufacturing company or another Meteorological Service in order to gain work experience that cannot be obtained in their own department or Service;
 - (iii) Students seconded internationally should be very capable and are usually supported by bilateral agreements or scholarships;
 - (m) Multimedia programmes:
 - (i) These include projection transparencies, video tapes and computer DVDs and CD-ROMs;
 - (ii) They require access to costly equipment which must be compatible with the media;
 - (iii) They may be used for class or individual study;
 - (iv) The programmes should include exercises, questions and discussion topics;
 - (v) Limited material is available for meteorological instrumentation;
 - (n) One-to-one coaching:
 - (i) The tutor works alongside one student who needs training in a specific skill;
 - (ii) This method may be useful for both remedial and advanced training;
 - (o) On-the-job training:
 - (i) This is an essential component of the training process and is when the trainee learns to apply the formally acquired skills in the wide variety of tasks and problems which confront the specialist. All skills are learnt best by exercising them;
 - (ii) Certain training activities may be best conducted in the on-the-job mode, following necessary explanations and cautions. These include all skills requiring a high level of manipulative ability and for which it is difficult or costly to reproduce the equipment or conditions in the laboratory or workshop. Examples of this are the installation of equipment, certain maintenance operations and complex calibrations;
 - (iii) This type of training uses available personnel and equipment resources and does not require travel, special training staff or accommodation, and is specific to local needs. It is particularly relevant where practical training far outweighs theoretical study, such as for training technicians;
 - (iv) The dangers are that on-the-job training may be used by default as the "natural" training method in cases where more structured training with a sound

theoretical component is required to produce fully rounded specialists; that supervisors with indifferent abilities may be used; that training may be too narrow in scope and have significant gaps in skills or knowledge; and that the effectiveness of training may not be objectively measured;

- (v) The elements necessary for successful on-the-job training are as follows:
 - a. A training plan that defines the skills to be acquired;
 - b. Work content covering the required field;
 - c. A work supervisor who is a good trainer skilled in the topic, has a good teaching style and is patient and encouraging;
 - d. Adequate theoretical understanding to support the practical training;
 - e. A work diary for the trainee to record the knowledge acquired and skills mastered;
 - f. Progress reviews conducted at intervals by the training supervisor;
 - g. An objective measure of successfully acquired skills (by observation or tests);
- (p) Participative training:
 - (i) This gives students active ownership of the learning process and enables knowledge and experience to be shared;
 - (ii) Students are grouped in teams or syndicates and elect their own leaders;
 - (iii) This is used for generating ideas, solving problems, making plans, developing projects, and providing leadership training;
- (q) Peer-assisted learning:
 - (i) This depends on prior common study and preparation;
 - (ii) In small groups, students take it in turns to be the teacher, while the other students learn and ask questions;
- (r) Programmed learning:
 - (i) This is useful for students who are not close to tutors or training institutions;
 - (ii) Students work individually at their own pace using structured prepared text, multimedia or computer-based courses;
 - (iii) Each stage of the course provides self-testing and revision before moving on to the next topic;
 - (iv) Training materials are expensive to produce and course options may be limited.

Good teaching is of greater value than expensive training aids.

5.4.6 **Television lectures**

Some teaching institutions which provide predominantly extramural courses broadcast lectures to their correspondence students over a special television channel or at certain times on a commercial channel.

5.4.7 **Video programmes**

Video programmes offer a good training tool because of the following:

- (a) They provide a good medium for recording and repeatedly demonstrating procedures when access to the instrument system and a skilled tutor is limited;
- (b) The programme may include pauses for questions to be discussed;
- (c) A video programme can be optimized by combining it with supplementary written texts and group discussions;
- (d) Although professionally made videos are expensive and there is limited material available on meteorological instruments, amateurs can make useful technical videos for local use with modest equipment costs, particularly with careful planning and if a sound track is added subsequently.

5.5 **RESOURCES FOR TRAINING**

Other than the media resources suggested in the previous section, trainers and managers should be aware of the sources of information and guidance available to them; the external training opportunities which are available; the training institutions which can complement their own work; and, not least, the financial resources which support all training activities.

5.5.1 **Training institutions**

5.5.1.1 **National education and training institutions**

In general, NMHSs will be unable to provide the full range of technical education and training required by their instrument specialists, and so will have varying degrees of dependence on external educational institutions for training, supplementary and refresher training in advanced technology. Meteorological engineering managers will need to be conversant

with the curricula offered by their national institutions so that they can advise their staff on suitable education and training courses of. WMO (2002*a*; 2002*b*) give guidance on the syllabi necessary for the different classes of instrument specialists.

When instrument specialists are recruited from outside the NMHS to take advantage of well-developed engineering skills, it is desirable that they have qualifications from a recognized national institution. They will then require further training in meteorology and its specific measurement techniques and instrumentation.

5.5.1.2 The role of WMO Regional Instrument Centres in training

On the recommendation of CIMO,² several WMO regional associations set up RICs to maintain standards and provide advice. Their terms of reference and locations are given in Part I, Chapter 1, Annex 1.A.

RICs are intended to be centres of expertise on instrument types, characteristics, performance, application and calibration. They will have a technical library on instrument science and practice; laboratory space and demonstration equipment; and will maintain a set of standard instruments with calibrations traceable to international standards. They should be able to offer information, advice and assistance to Members in their Region.

Where possible, these centres will combine with a Regional Radiation Centre and should be located within or near an RTC in order to share expertise and resources.

A particular role of RICs is to assist in organizing regional training seminars or workshops on the maintenance, comparison and calibration of meteorological instruments and to provide facilities and expert advisors.

RICs should aim to sponsor the best teaching methods and provide access to training resources and media which may be beyond the resources of NMHSs. The centres will need to provide refresher training for their own experts in the latest technology available and training methods in order to maintain their capability.

² Recommended by the Commission for Instruments and Methods of Observation at its ninth session (1985) through Recommendation 19 (CIMO-IX).

Manufacturers of meteorological instrumentation systems could be encouraged to sponsor training sessions held at RICs.

5.5.2 WMO training resources

5.5.2.1 WMO education and training syllabi

WMO (2002*a*; 2002*b*) include syllabi for specialization in meteorological instruments and in meteorological telecommunications. The education and training syllabi are guidelines that need to be interpreted in the light of national needs and technical education standards.

5.5.2.2 WMO survey of training needs

WMO conducts a periodic survey of training needs by Regions, classes and meteorological specialization. This guides the distribution and kind of training events sponsored by WMO over a four-year period. It is important that Member countries include a comprehensive assessment of their need for instrument specialists in order that WMO training can reflect true needs.

5.5.2.3 WMO education and training publications

These publications include useful information for instrument specialists and their managers. WMO (1986) is a compendium in two volumes of lecture notes on training in meteorological instruments at technician level which may be used in the classroom or for individual study.

5.5.2.4 WMO training library

The library produces a catalogue (WMO, 1983) of training publications, audiovisual aids and computer diskettes, some of which may be borrowed, or otherwise purchased, through WMO.

5.5.2.5 WMO instruments and observing methods publications

These publications, including reports of CIMO working groups and rapporteurs and instrument intercomparisons, and so forth, provide instrument specialists with a valuable technical resource for training and reference.

5.5.2.6 Special WMO-sponsored training opportunities

The Managers of engineering groups should ensure that they are aware of technical training opportunities announced by WMO by maintaining contact

with their training department and with the person in their organization who receives correspondence concerning the following:

- (a) Travelling experts/roving seminars/workshops: From time to time, CIMO arranges for an expert to conduct a specified training course, seminar or workshop in several Member countries, usually in the same Region. Alternatively, the expert may conduct the training event at a RIC or RTC and students in the region travel to the centre. The objective is to make the best expertise available at the lowest overall cost, bearing in mind the local situation;
- (b) Fellowships: WMO provides training fellowships under its Technical Cooperation Programme. Funding comes from several sources, including the United Nations Development Programme, the Voluntary Cooperation Programme, WMO trust funds, the regular budget of WMO and other bilateral assistance programmes. Short-term (less than 12 months) or long-term (several years) fellowships are for studies or training at universities, training institutes, or especially at WMO RTCs, and can come under the categories of university degree courses, postgraduate studies, non-degree tertiary studies, specialized training courses, on-the-job training, and technical training for the operation and maintenance of equipment. Applications cannot be accepted directly from individuals. Instead, they must be endorsed by the Permanent Representative with WMO of the candidate's country. A clear definition must be given of the training required and priorities. Given that it takes an average of eight months to organize a candidate's training programme because of the complex consultations between the Secretariat and the donor and recipient countries, applications are required well in advance of the proposed training period. This is only a summary of the conditions. Full information and nomination forms are available from the WMO Secretariat. Conditions are stringent and complete documentation of applications is required.

5.5.3 Other training opportunities

5.5.3.1 Technical training in other countries

Other than WMO fellowships, agencies in some countries offer excellent training programmes which may be tailored to the needs of the candidate. Instrument specialists should enquire about these opportunities with the country or agency representative in their own country.

5.5.3.2 Training by equipment manufacturers

This type of training includes the following:

- (a) New data-acquisition system purchase: All contracts for the supply of major data-acquisition systems (including donor-funded programmes) should include an adequate allowance for the training of local personnel in system operation and maintenance. The recipient Meteorological Service representatives should have a good understanding of the training offered and should be able to negotiate in view of their requirements. While training for a new system is usually given at the commissioning stage, it is useful to allow for a further session after six months of operational experience or when a significant maintenance problem emerges;
- (b) Factory acceptance/installation/commissioning: Work concerned with the introduction of a major data-acquisition facility, for example, a satellite receiver or radar, provides unique opportunities for trainees to provide assistance and learn the stringent technical requirements.

Acceptance testing is the process of putting the system through agreed tests to ensure that the specifications are met before the system is accepted by the customer and despatched from the factory.

During installation, the supplier's engineers and the customer's engineers often work together. Other components, such as a building, the power supply, telecommunications and data processing, may need to be integrated with the system installation.

Commissioning is the process of carrying out agreed tests on the completed installation to ensure that it meets all the specified operational requirements.

A bilateral training opportunity arises when a country installs and commissions a major instrumentation system and trainees can be invited from another country to observe and assist in the installation.

5.5.3.3 International scientific programmes

When international programmes, such as the World Climate Programme, the Atmospheric Research and Environment Programme, the Tropical Cyclone Programme or the Tropical Ocean and Global Atmosphere Programme, conduct large-scale experiments, there may be opportunities for local instrument specialists to be associated with senior colleagues in the measurement programme and to thereby gain valuable experience.

5.5.3.4 **International instrument intercomparisons sponsored by the Commission for Instruments and Methods of Observation**

From time to time, CIMO nominates particular meteorological measurements for investigation as a means of advancing the state of knowledge. Instruments of diverse manufacture and supplied by Members are compared under standard conditions using the facilities of the host country. An organizing committee plans the intercomparison and, in its report, describes the characteristics and performance of the instruments.

If they can be associated with these exercises, instrument specialists would benefit from involvement in some of the following activities: experimental design, instrument exposure, operational techniques, data sampling, data acquisition, data processing, analysis and interpretation of results. If such intercomparisons can be conducted at RICs, the possibility of running a parallel special training course might be explored.

5.5.4 **Budgeting for training costs**

The meteorological engineering or instrumentation department of every NMHS should provide an adequate and clearly identified amount for staff training in its annual budget, related to the Service's personnel plan. A lack of training also has a cost: mistakes, accidents, wastage of time and material, staff frustration, and a high staff turnover resulting in poor quality data and meteorological products.

5.5.4.1 **Cost-effectiveness**

Substantial costs are involved in training activities, and resources are always likely to be limited. Therefore, it is necessary that the costs of various training options should be identified and compared, and that the cost-effectiveness of all training activities should be monitored, and appropriate decisions taken. Overall, the investment in training by the NMHS must be seen to be of value to the organization.

5.5.4.2 **Direct and indirect costs**

Costs may be divided into the direct costs of operating certain training courses and the indirect or overhead costs of providing the training facility. Each training activity could be assigned some proportion of the overhead costs as well as the direct operating costs. If the facilities are used by many activities throughout the year, the indirect cost apportioned to any one activity will be low and the facility is being used efficiently.

Direct operating costs may include trainee and tutor travel, accommodation, meals and daily expenses, course and tutor fees, WMO staff costs, student notes and specific course consumables, and trainee time away from work.

Indirect or overhead costs could include those relating to training centre buildings (classrooms, workshops and laboratories), equipment and running costs, teaching and administration staff salaries, WMO administration overheads, the cost of producing course materials (new course design, background notes, audiovisual materials), and general consumables used in training.

In general, overall costs for the various modes of training may be roughly ranked from the lowest to the highest as follows (depending on the efficiency of resource use):

- (a) On-the-job training;
 - (b) Correspondence courses;
 - (c) Audiovisual courses;
 - (d) Travelling expert/roving seminar, in situ course;
 - (e) National course with participants travelling to a centre;
 - (f) Computer-aided instruction (high initial production cost);
 - (g) Regional course with participants from other countries;
 - (h) Long-term fellowships;
 - (i) Regional course at a specially equipped training centre.
-

ANNEX

REGIONAL TRAINING CENTRES

<i>Country</i>	<i>Name of centre</i>	<i>WMO Region</i>
Algeria	Hydrometeorological Institute for Training and Research (IHFR), Oran	I
Angola ^a	Regional Training Centre, Mulemba	I
Egypt	Regional Training Centre, Cairo	I
Kenya ^b	Institute for Meteorological Training and Research, Nairobi; and Department of Meteorology, University of Nairobi, Nairobi	I
Madagascar	École supérieure polytechnique d'Antananarivo, University of Antananarivo, Antananarivo	I
Niger	African School of Meteorology and Civil Aviation (EAMAC), Niamey; and Regional Training Centre for Agrometeorology and Operational Hydrology and their Applications (AGRHYMET), Niamey	I
Nigeria ^b	Meteorological Research and Training Institute, Lagos; and Department of Meteorology, Federal University of Technology, Akure	I
China ^b	Nanjing Institute of Meteorology, Nanjing; and China Meteorological Administration Training Centre, Beijing	II
India ^b	Telecommunication and Radiometeorological Training Centre, New Delhi; and Training Directorate, Pune	II
Iran (Islamic Republic of)	Advanced Meteorological Sciences Training Centre, Tehran	II
Iraq	Regional Training Centre, Baghdad	II
Uzbekistan	Hydrometeorological Technical School, Tashkent	II
Argentina ^b	Department of Atmospheric Science, University of Buenos Aires, Buenos Aires; and Department of Education and Training of the National Meteorological Service, Buenos Aires;	III
Brazil	Department of Meteorology, Federal University of Pará, Belém	III
Venezuela	Department of Meteorology and Hydrology, Central University of Venezuela, Caracas	III
Barbados ^b	Caribbean Institute for Meteorology and Hydrology, Bridgetown; and University of the West Indies, Bridgetown	IV
Costa Rica	Section of Atmospheric Physics, School of Physics, University of Costa Rica, San José	IV
Philippines ^b	Department of Meteorology and Oceanography, University of the Philippines; and Training Centre of the Philippine Atmospheric, Geophysical and Astronomical Services Administration (PAGASA), Quezon City	V
Israel	Postgraduate Training Centre for Applied Meteorology, Bet Dagan	VI
Italy ^b	International School of Meteorology of the Mediterranean, Erice, Sicily; and Institute of Agrometeorology and Environment Analysis for Agriculture, Florence	VI
Russian Federation ^b	Advanced Training Institute and Moscow Hydrometeorological College, Moscow; and Russian State Hydrometeorological Institute, St Petersburg	VI
Turkey	Anatolian Meteorological Technical High School, Ankara	VI

a RTC Angola re-opening operations are under way.

b These Centres have a university component.

REFERENCES AND FURTHER READING

- Craig, R.L. (ed.), 1987: *Training and Development Handbook: A Guide to Human Resource Development*. McGraw-Hill, New York.
- Imai, M., 1986: *Kaizen: The Key to Japan's Competitive Success*. Random House, New York.
- International Organization for Standardization, 1994a: *Quality Management and Quality Assurance Standards – Part 1: Guidelines for Selection and Use*. ISO 9000-1; 1994, Geneva.
- International Organization for Standardization, 1994b: *Quality Management and Quality System Elements – Part 1: Guidelines*. ISO 9004-1; 1994, Geneva.
- Moss, G., 1987: *The Trainer's Handbook*. Ministry of Agriculture and Fisheries, New Zealand.
- Walton, M., 1986: *The Deming Management Method*. Putnam Publishing, New York.
- World Meteorological Organization, 1983: *Catalogue of Meteorological Training Publications and Audiovisual Aids*. Third edition, Education and Training Programme Report No. 4, WMO/TD-No. 124, Geneva.
- World Meteorological Organization, 1986: *Compendium of Lecture Notes on Meteorological Instruments for Training Class III and Class IV Meteorological Personnel* (D.A. Simidchiev). WMO-No. 622, Geneva.
- World Meteorological Organization, 1989: *Guide on the Global Observing System*. WMO-No. 488, Geneva.
- World Meteorological Organization, 1990: *Guidance for the Education and Training of Instrument Specialists* (R.A. Pannett). Education and Training Programme Report No. 8, WMO/TD-No. 413, Geneva.
- World Meteorological Organization, 2002a: *Guidelines for the Education and Training of Personnel in Meteorology and Operational Hydrology*. Volume I: Meteorology. Fourth edition, WMO-No. 258, Geneva.
- World Meteorological Organization, 2002b: *Initial Formation and Specialisation of Meteorological Personnel: Detailed Syllabus Examples*. WMO/TD-No. 1101, Geneva.
-

APPENDIX

LIST OF CONTRIBUTORS TO THE GUIDE

Artz, R. (United States)	Luke, R. (United States)
Ball, G. (Australia)	Nash, J. (United Kingdom)
Behrens, K. (Germany)	Oke, T. (Canada)
Bonnin, G.M. (United States)	Painting, D.J. (United Kingdom)
Bower, C.A. (United States)	Pannett, R.A. (New Zealand)
Canterford, R. (Australia)	Qiu Qixian (China)
Childs, B. (United States)	Rudel, E. (Austria)
Claude, H. (Germany)	Saffle, R. (United States)
Crum, T. (United States)	Schmidlin, F.J. (United States)
Dombrowsky, R. (United States)	Sevruk, B. (Switzerland)
Edwards, M. (South Africa)	Srivastava, S.K. (India)
Evans, R.D. (United States)	Steinbrecht, W. (Germany)
Feister, E. (Germany)	Stickland, J. (Australia)
Forgan, B.W. (Australia)	Stringer, R. (Australia)
Hilger, D. (United States)	Sturgeon, M.C. (United States)
Holleman, I. (Netherlands)	Thomas, R.D. (United States)
Hoogendijk, K. (Netherlands)	Van der Meulen, J.P. (Netherlands)
Johnson, M. (United States)	Vanicek, K. (Czech Republic)
Klapheck, K.-H. (Germany)	Wieringa, J. (Netherlands)
Klausen, J. (Switzerland)	Winkler, P. (Germany)
Koehler, U. (Germany)	Zahumensky, I. (Slovakia)
Ledent, T. (Belgium)	Zhou Weixin (China)

www.wmo.int