

THE OLYMPIC GAMES
OF STOCKHOLM 1912

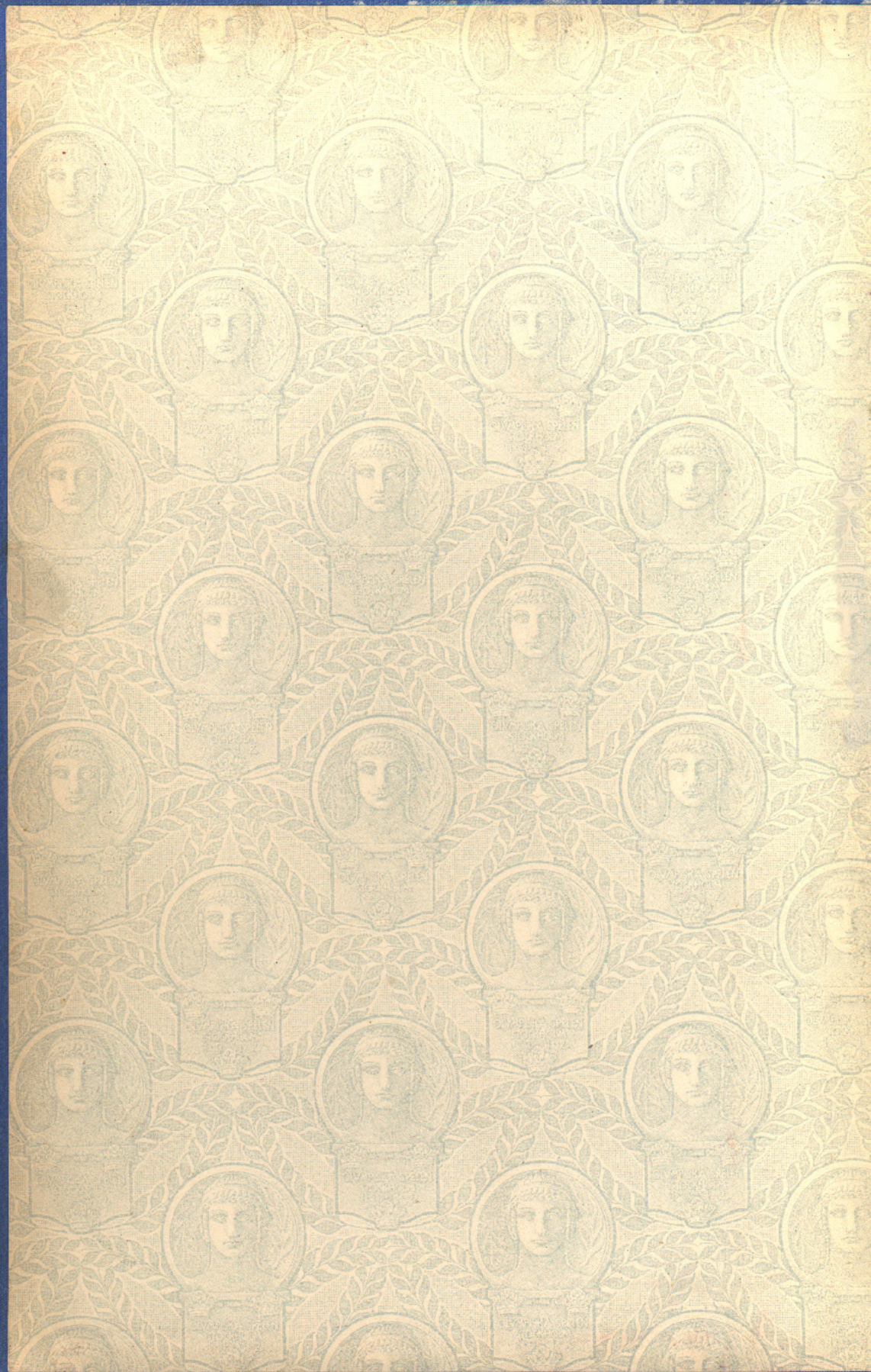

OFFICIAL REPORT





*The Right Hon.
Lord Desborough of Taplow
from*

ORGANISATIONSKOMMITTÉN FÖR
OLYMPISKA SPELEN 1 STOCKHOLM 1912



HATMA
SIOGREN
DEL 1913



THE
FIFTH OLYMPIAD

THE OFFICIAL
REPORT

OF THE

OLYMPIC GAMES
OF STOCKHOLM 1912

ISSUED BY
THE SWEDISH OLYMPIC COMMITTEE

EDITED BY
ERIK BERGVALL

TRANSLATED BY
EDWARD ADAMS-RAY



PUBLISHED BY
WAHLSTRÖM & WIDSTRAND
STOCKHOLM

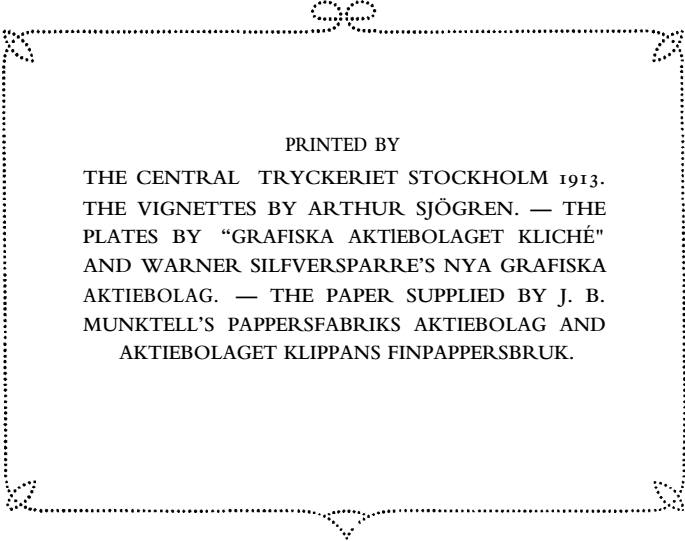

PRINTED BY
THE CENTRAL TRYCKERIET STOCKHOLM 1913.
THE VIGNETTES BY ARTHUR SJÖGREN. — THE
PLATES BY "GRAFISKA AKTIEBOLAGET KLICHÉ"
AND WARNER SILFVERSPARRE'S NYA GRAFISKA
AKTIEBOLAG. — THE PAPER SUPPLIED BY J. B.
MUNKTELL'S PAPPERSFABRIKS AKTIEBOLAG AND
AKTIEBOLAGET KLIPPANS FINPAPPERSBRUK.

P R E F A C E .

The Swedish Olympic Committee for the Olympic Games of Stockholm, 1912, considered it to be its duty to publish a full report of the Fifth Olympiad and its competitions, but it was not before the beginning of 1913, when the somewhat lengthy process of winding up the affairs of the vast organization for the Games was almost at an end, that the work could be begun, under the immediate direction of the Executive Committee and the Finance Section.

Mr. Erik Bergvall was entrusted with the task of editing the report. The following persons have contributed special articles on the branches of athletics mentioned:

FIELD AND TRACK ATHLETICS:	S. LÅFTMAN, Esq.
TUG-OF-WAR AND CYCLING	Captain C. G. DRAKE.
FENCING:	Captain E. FICK.
FOOTBALL:	T. HUSÉN, Esq.
GYMNASTICS:	Captains E. NERMAN and C. HJORTH.
HORSE RIDING COMPETITIONS:	Lieutenant C. TRÄGÅRDH.
LAWN TENNIS :	Fleet-Paymaster K. ZETTERBERG.
MODERN PENTATHLON:	Lieutenant F. S. GRANFELT.
ROWING:	U. SALCHOW, Esq.
SHOOTING:	V. WAHLQVIST, Esq. C. G. BOIVIE, Esq. E. MELIN, Esq.
SWIMMING:	ERIK BERGVALL, Esq.
WRESTLING:	J. BORG, Esq.
YACHT RACING:	H. ANDERSSON, Esq., C. E.

Other articles of a more special character, such as the description of the origin of the Stadium and the arrangement of the sites of the competitions, the reports issued by the Reception-, Accommodation- and Press Committees, etc., have been written

by various experts. The account of the work of advertising the Games has been contributed by KRISTIAN HELLSTRÖM, Esq., the General Secretary, and the statistical material has been collected and revised by Mr. JOHN WIDENFELT. Much care has been taken with this part of the work, in order to have every name and figure as correct as possible.

The Official Report thus edited and now published is issued in two different editions, one in Swedish and one in English.

The translation of the English edition has been carried out by Mr. EDWARD ADAMS-RAY.

THE SWEDISH OLYMPIC COMMITTEE FOR THE
OLYMPIC GAMES OF STOCKHOLM, 1912.

Stockholm, December 1913.

	Page.
Instructions for the officials for the competitions in gymnastics	123
» » » » » » swimming competitions.....	128
» » » » » and competitors at the shooting competitions	148
<i>The medals, badges and diplomas of the Fifth Olympiad</i>	160
» <i>challenge prizes of the Olympic Games</i>	164
<i>Guarantee</i>	165
 PREPARING THE SITES OF THE COMPETITIONS.....	 167
<i>The Stadium.</i>	
The origin of the building	168
» Building Committee	172
» building site	173
» contractor's work	174
» architecture of the Stadium	178
» grand stands and standing places	183
» interior premises.....	187
» arena, tracks and gardens.....	189
Description of the construction of the tracks and pitches at the Stadium	191
Technical building arrangements.....	205
Bunting	207
The bazaar buildings and the kiosks in Valhallavägen	209
Building- and other expenses	210
<i>The Swimming Stadium</i>	211
The swimming course	215
The diving platform	216
The stands	216
<i>Other competing places.</i>	
Ostermalm Athletic Grounds.....	218
Lawn Tennis	219
Fencing	220
Football	221
Horse Riding competitions	221
Rowing competitions.....	221
Shooting.....	222
Yacht Racing.....	224
 THE ARRANGEMENTS MADE FOR THE RECEPTION AND ACCOM- MODATION OF COMPETITORS, ETC.	
Report issued by the Reception Committee	226
» of the Accommodation Committee: Preparatory work. — The cheaper forms of accommodation. — Correspondence with the foreign delegates. — Accommodation provided for the various nations. — The sleeping accom- modation in the schools. — Boarding arrangements for the competitors. — Procural of rooms for tourists. — The number of rooms available...	229
Report of the Press Committee.....	241
Telegraph and telephone arrangements	249
Traffic- and customs-arrangements	254
Flag labels.....	256
Tramway traffic.....	257
 HOW THE OLYMPIC GAMES OF STOCKHOLM 1912 WERE ADVER- TISED:	
Newspaper cuttings. — The General Programme. — Circular. — The Ad- vertisement Committees. — Official poster and advertising stamp. — Distribution of the advertising material. — Literary and journalistic ad- vertising. — Other measures employed for advertising the Games. — Distribution office. — Advertising the Games in Sweden. — Local ad- vertising.....	258

	Page.
THE TRAINING OF THE SWEDISH ATHLETES FOR THE OLYMPIC GAMES	286
Athletics.....	286
Tug-of-war.....	292
Cycling	292
Fencing	293
Football.....	293
Gymnastics.....	294
Horse Riding competitions	295
Lawn Tennis.....	296
Modern Pentathlon.....	296
Rowing	296
Shooting.....	298
Swimming.....	299
Wrestling.....	300
List of the Try Outs for the Olympic Games of Stockholm, 1912.....	300

COMPETITIONS AND FESTIVITIES.

THE SOLEMN OPENING OF THE GAMES.....	307
Olympic Games Triumphant March	312

FIELD AND TRACK ATHLETICS:

General organization of preparatory work	323
Choosing the branches of athletics to be represented at the Games; drawing up the general regulations.....	324
The question of penalizing false starts	327
Calculation of points for the Pentathlon.....	328
Drawing up the rules for the Decathlon.....	328
The athletic-technical details in the Stadium.....	337
The arrangements for the competitions in the Stadium, etc.	338
Making known the results to the public and the Press	343
The athlete's pocket-book with detailed regulations of the competitions and P. M.	344
Description of the automatic timing- and judging apparatus used at the Olympic Games of Stockholm 1912	348
Arrangements for the training of the athletes from abroad.....	349

The Competitions:

Running:

100 metres Flat.....	350
200 » »	354
400 » »	357
800 » »	360
1,500 » »	364
5,000 » »	366
10,000 » »	368
Hurdle race, 110 metres	371
Relay race, 400 »	373
» » 1,600 »	375
Team race, 3,000 »	376
Cross-country race, 8,000 metres	378
The Marathon Race	382
Walking race, 10,000 metres	391

Jumping Competitions

Running High Jump	392
Standing »	394
Running Broad Jump.....	395

	Page.
Standing Broad Jump	396
Hop, Step and »	398
Pole jump	399
<i>Throwing Competitions:</i>	
Throwing the Javelin, best hand	401
» » » right and left hand	403
» » Discus, best hand	404
» » » right and left hand	405
Putting the Weight, best hand	407
» » » right and left hand	408
Throwing the Hammer	409
The Pentathlon and the Decathlon	410
Some general reflections and wishes concerning Field and Track Athletics	420
Tables showing the position of the various countries as regards points obtained in Field and Track events	421
Diplomas of Merit	422

THE TUG-OF-WAR:

Its organization	423
<i>The Competition</i>	424

CYCLING:

Organization	427
The method of starting	429
» prevention of pacing	429
» arrangements along the course	430
» number of competitors	431
» draw for the start	432
» management of the competition	433
Alterations made in the rules	434
P. M. for competitors	435
Reception of the foreign guests. Meetings, etc.	436
<i>The Race</i>	438
Table showing the best 25 men in the race	443
General Protocol	444
Comparisons	450
General Protocol of the Team Competition	450
Comparative table of results gained by the nations represented	452
Presentation of the prizes	452
Reflections	453

FENCING:

Organization	455
Rules for the fencing competitions	455
Time Table for the fencing competitions	458
The principles for the judging	460
The technical arrangements	460
<i>The Fencing:</i>	
Individual competition with foils	463
Épée team competition	468
Individual épée competition	469
Sabre team competition	473
Individual sabre competition	474
Experiences gained by the competitions	477
The relative position of the nations in the fencing competitions	478

FOOTBALL:	Page.
The inclusion of football in the programme of the Fifth Olympiad	479
The technical management of the competition	480
Special arrangements for the Football competitions	481
<i>The Competitions:</i>	
First round	484
Second round	487
Semi-finals	491
Final	493
Match for the third prize	495
<i>Consolation Series:</i>	
First round	496
Semi-Finals	497
Final	499
Results of the Football Competitions of the Fifth Olympiad	500
Some General Reflections and Wishes	501
GYMNASTICS:	
The Committee for Gymnastics	504
Drawing up the Programme for Gymnastics	504
General preparations; apparatus; dressing rooms; officials	506
<i>The Competitions and Displays:</i>	510
<i>Team Competition I</i>	511
Sweden	511
Norway	513
Denmark	514
General Protocol	515
<i>Team Competition II</i>	516
Luxemburg	516
Hungary	520
Germany	525
Great Britain	528
Italy	534
General Protocol	540
<i>Team Competition III</i>	542
Germany	542
Norway	545
Denmark	546
Finland	548
Luxemburg	550
General Protocol	554
<i>Individual Competition</i>	555
General Protocol	558
<i>Displays</i>	555
Swedish team of men gymnasts	555
» » » women gymnasts	555
Danish » » » »	556
» » » men »	556
Norwegian team of women gymnasts	556
Finnish » » »	557
Hungarian » » men »	557
Russian » » » »	557
Comparative view of the Competitions and Displays	557
HORSE RIDING COMPETITIONS:	564
Organising- and preparatory work	565
General regulations, programme and propositions	569
Preparations for Sweden's participation in the competitions	573

	Page.
Subcommittees	576
Challenge Prizes.....	579
Entertainments	580
<i>The Competitions:</i>	
The Military	583
Prize Riding	593
Prize Jumping.....	595
Individual competition	596
Team competition	600
Presentation of the Prizes	604
P. M. and Instructions, etc., issued by the Committee for the Horse Riding Competitions	604
Relative position of the Nations in the Horse Riding Competitions	615
 LAWN TENNIS:	
Report of the Labours of the Committee	616
<i>The Competitions:</i>	
<i>The covered court competitions</i>	618
Gentlemen's singles	619
Ladies' singles	621
Gentlemen's doubles	623
Mixed doubles	624
Presentation of the prizes.....	626
Placing of the Nations in the covered court competitions	630
<i>Out-of-door court competitions:</i>	630
Gentlemen's singles	631
» doubles	633
Ladies' singles	636
Mixed doubles.....	637
Presentation of the prizes.....	639
Placing of the Nations in the out-of-door court competitions	639
 MODERN PENTATHLON:	
Preparatory work of the Committee.....	640
Judging the Competition	645
The Committee for the Modern Pentathlon	646
<i>The Competition:</i>	646
Duel-shooting.....	647
Swimming	650
Fencing	651
Riding.....	654
Cross-country run	655
Final Result	656
 ROWING:	
Organization and preparation	658
The programme.....	659
The course.....	659
The housing of the boats.....	661
<i>The Olympic Regatta at Stockholm:</i>	661
Eights, outriggers	662
Fours, »	667
» inriggers.....	671
Single Sculls	673
Concluding remarks	676
Relative position of the Nations in the Rowing competitions.....	676

SHOOTING:

Page.

The Shooting Committee	677
Programme and rules for the competition	678
Special arrangements for shooting-ranges, etc.	678
<i>The Competitions:</i>	
<i>Shooting with Army-rifle</i>	679
The Chief Committee of the Swedish Shooting Association and the Shooting competitions of the Olympic Games	679
Rifle-Shooting Committee	679
Shooting-Ranges	680
The arrangements for the shooting	681
The shooting in the competitions	681
Team competition, distance 200, 400, 500 and 600 metres	682
Individual competition, distance 600 metres	684
» » » 300 »	685
Team » » » international target	687
Individual » » » » » »	689
<i>Shooting with Miniature rifles, revolver and pistols</i>	691
Team competition, miniature rifle shooting, distance 50 metres	692
Individual » with miniature rifle, » » »	693
Team » » » » » 25 »	695
Individual » » » » » »	696
Team » » revolver and pistol, distance 50 metres	697
Individual » » » » » » »	698
Team » » » » » 30 »	700
Individual » » » » » » »	701
<i>Clay bird and running deer shooting:</i>	704
Clay bird shooting, team competition	705
» » » individual »	706
Running deer » team distance 100 metres, single shots	708
» » » individual » » » »	709
» » » » » » » » double »	710
Comparison between the results of the clay bird- and running deer shooting in London, 1908, and in Stockholm, 1912	711
Relative positions of the Nations in the shooting competitions	711
<i>SWIMMING:</i>	
The general organization	712
The programme	713
Drawing up the rules and regulations	714
Arrangements in the Swimming Stadium	715
<i>The Competitions:</i>	
<i>The Swimming Races:</i>	
100 metres free style	716
400 » » »	718
1,500 » » »	720
100 » back stroke	721
200 » breast »	722
400 » » »	723
800 » team race	724
<i>Ladies:</i>	
100 metres free style	725
400 » team race	726
<i>Diving Competitions:</i>	
<i>High diving:</i>	
High diving for men	727
Plain and variety diving combined	731
Plain diving for ladies	738
Spring-board diving	739

	Page.
<i>Water Polo:</i>	741
First round	742
Semi-final	744
Final	745
Qualifying match for second prize	746
» » » third »	746
Deciding match for second and third prizes	747
Table showing the results of the Olympic Water Polo competition ...	748
Table showing the number of matches played and goals made in the Water Polo competitions of the Fifth Olympiad	748
Concluding words	748
Relative position of the Nations in the Swimming competitions	750

WRESTLING:

Organization	751
Rules and regulations	751
The question of officials	752
The number of entries	752
<i>The Competitions:</i>	
Feather weight	753
Light weight	753
Middle weight A.	763
» » B.	763
Heavy weight	764
Reflections	764
Relative positions of the Nations in the Wrestling competitions	765

YACHT RACING:

The origin of the regatta	766
Preparations	767
Preparatory work of the Yacht Racing Committee.....	768
The Finance Committee and its work.....	769
The Advertisement Committee and its work	770
The work of the Traffic- and Accommodation Committee	770
» » » » Press Committee	772
» » » » Reception and the Entertainments Committee	772
» » » » Special Yacht Racing Committee	773
<i>The three Olympic days at Nynäs:</i>	
The racing on July 20:	
The 12-Metre class	775
» 10- » »	775
» 8- » »	776
» 6- » »	776
» racing protocol	776
The racing on July 21:	
The 12-Metre class	777
» 10- » »	778
» 8- » »	778
» 6- » »	778
» racing protocol	779
The result of the first two days' Olympic racing	780
» re-sailing of the ties on July 22	780
Result of the re-sailing of the ties	782
Final results of the Olympic Yacht Racing.....	782
Relative positions of the Nations in the Yacht Racing.....	783

	Page.
THE PRESENTATION OF THE PRIZES	784
OFFICIAL FESTIVITIES	786
Festivities organized by the Swedish Olympic Committee.....	786
Entertainment given by Skansen for the competitors and officials	789
Festivities arranged by the Special Committees.....	794
Other festivities and receptions.....	798
THE PROPOSED PRIZE FOR MOUNTAIN ASCENTS	800
THE PROPOSED PRIZE FOR GAME SHOOTING	803
CONCOURS D'ART.....	806
The relative positions of the Nations in the Concours d'Art	811
DISPLAYS, ETC., IN CONNECTION WITH THE OLYMPIC GAMES ...	812
The cooperation of, and displays by, boy scouts	812
Displays of Gottland Games and Icelandic "Glima".....	817
"Pärkspel"	818
Quoits	820
Tossing the caber	821
Icelandic "Glima"-wrestling	821
Baseball	823
Report of the Entertainments Committee:	
The decoration of the city	825
Excursions in the vicinity of Stockholm.....	826
Publications for the guidance of visitors.....	826
Gala- and other theatrical performances	827
Open air entertainments.....	828
Special arrangements made by Public Institutions.....	828
The great Swedish choral festival	830
MEDICAL AID DURING THE GAMES:	
The competitions in the Stadium.....	832
The organization of the medical staff.....	832
Medical aid given in the Stadium	834
Nationality of the men patients	835
Complaints and injuries of the men patients	835
Nationality of the women patients	837
Complaints and injuries of the women patients.....	837
The Marathon race.....	838
The cycling race round Lake Mälär	841
The rowing competitions	841
The swimming competitions	842
STATISTICS. LIST OF OFFICIALS AND COMPETITORS.	
THE OLYMPIC GAMES OF TO-DAY. A short review	845
Athens 1896	846
Paris 1900	846
St. Louis 1904	846
Athens 1906	847
London 1908	847
Results in the preceding Olympic Games in the so-called Stadium events	848
OLYMPIC RECORDS.....	850

	Page.
PRIZE WINNERS AT THE OLYMPIC GAMES OF STOCKHOLM 1912...	852
List of winners of the Olympic challenge prizes	862
» » » » three first prizes	862
» » » » two » »	863
THE OFFICIAL CALCULATION OF POINTS:	864
Calculation of points for the Concours d'Art	864
Comparison between the Swedish Official calculation of points and the so-called English method of calculating points	865
List of the prizes gained by the Nations at the Olympic Games of Stockholm, 1912	866
Table showing number of prizes gained by the Nations in the various branches of athletics	874
LIST OF THE DIPLOMAS OF MERIT AWARDED AT THE OLYMPIC GAMES OF STOCKHOLM, 1912	876
Table showing number of diplomas of merit awarded at the Olympic Games of Stockholm, 1912	888
TABLE SHOWING THE NUMBER OF STARTERS IN ALL THE COMPETITIONS OF THE OLYMPIC GAMES OF 1912	884
TABLE SHOWING THE NUMBER OF STARTERS IN THE VARIOUS BRANCHES OF ATHLETICS	889
TABLE SHOWING PROPORTION BETWEEN THE NUMBER OF ENTRIES AND THE NUMBER OF ATHLETES ACTUALLY COMPETING	890
LIST OF COMPETITORS IN THE OLYMPIC GAMES OF STOCKHOLM, 1912	891
LIST OF THE LEADING ATHLETIC- AND OTHER SPORTING ORGANIZATIONS REPRESENTED AT THE GAMES OF STOCKHOLM	951
LIST OF THE FOREIGN OFFICIAL REPRESENTATIVES AND FUNCTIONARIES AT THE OLYMPIC GAMES OF STOCKHOLM...	957
Table showing the number of the Foreign Official representatives and functionaries at the Games of Stockholm	973
LIST OF THE SWEDISH MEMBERS OF COMMITTEES AND OFFICIALS	974
LIST OF THE FOREIGN JOURNALISTS AT THE GAMES.....	991
Table showing the number of foreign journalists present at the Games of Stockholm	997

RULES AND REGULATIONS FOR THE COMPETITIONS.

FIELD AND TRACK ATHLETICS	1001
TUG-OF WAR	1013
CYCLING.....	1015
FENCING.....	1016
FOOTBALL.....	1025
GYMNASTICS.....	1026
HORSE RIDING COMPETITIONS	1034

	Page.
LAWN TENNIS	1045
MODERN PENTATHLON	1049
ROWING	1051
SHOOTING	1055
SWIMMING	1068
WRESTLING	1094
YACHT RACING	1097

AFTERMATH.

LETTERS FROM VARIOUS OFFICIAL INSTITUTIONS, ETC.....	1103
—	
CORRECTIONS	1117

LIST OF ILLUSTRATIONS.

PORTRAITS.

	Pl.
H. M. King Gustaf V. Patron of the Olympic Games of Stockholm 1912	1
H. R. H. Crown Prince Gustaf Adolf. Hon. President of the Swedish Olympic Committee for the Olympic Games of Stockholm 1912.....	2
H. R. H. Prince Wilhelm. Hon. President of the Swedish Olympic Lawn Tennis Committee.....	3
H. R. H. Prince Carl. Hon. President of the Swedish Olympic Committee for the Horse Riding Competitions.....	4
Members of the Swedish Olympic Committee for the Olympic Games of Stockholm 1912.....	5—6
Presidents of the Special Committees.....	7—8
Baron Pierre de Coubertin. President of the International Olympic Committee.....	9
The leading personages of the foreign Olympic Committees.....	10—13

WINNERS IN THE FIFTH OLYMPIAD:

R. C. Craig. 100 and 200 m. Flat.....	14
C. D. Reidpath. 400 m. Flat.....	14
J. Meredith. 800 m. Flat.....	14
A. N. Jackson. 1,500 m. Flat.....	14
H. Kolehmainen. 5,000 m. and 10,000 m. Flat and Cross-Country Race	14
F. W. Kelly. Hurdle Race 110 m.....	14
Great Britain's team in Relay Race, 400 m.....	15
U. S. A.'s team in Relay Race, 1,600 m.....	15
» » Team Race, 3,000 ».....	16
Sweden's team in Cross Country Race, 8,000 m.....	16
K. K. Mc Arthur. Marathon Race.....	17
G. H. Goulding. Walking Race, 10,000 m.....	17
A. W. Richards. Running High Jump.....	17
Platt Adams. Standing High Jump.....	17
A. L. Gutterson. Running Broad Jump.....	17
C. Tsiclitiras. Standing » ».....	17
G. Lindblom. Hop, Step and Jump.....	18
H. S. Babcock. Pole Jump.....	18
E. Lemming. Throwing the Javelin, best h.....	18
J. Saaristo. » » » r. & l. h.....	18
A. R. Taipale » » Discus, b. h., r & l. h.....	18
P. Mc Donald. Putting the Weight, b. h.....	18
Ralph Rose. » » » r. & l. h.....	19
M. J. Mc Grath. Throwing the Hammer.....	19
F. R. Bie, Pentathlon.....	19
H. Wieslander, Decathlon.....	19
Sweden's team in Tug-of-War ..	19
K. Koskelo. Wrestling; Feather Weight.....	20
E. E. Wäre. » Light Weight.....	20
C. E. Johansson. » Middle Weight A.....	20
A. O. Ahlgren. » » » B.....	20

	Pl.
I. T. Böling. Wrestling; Middle Weight B	20
U. Saarela. » Heavy Weight	20
R. Lewis. Cycling Road Race round Lake Mälär	21
Sweden's team in Cycling Road Race round Lake Mälär	21
Great Britain's team in Football Comp	22
Belgium's team in Épée Team Comp	22
N. Nadi. Fencing with Foils " Ind. Comp	23
P. Anspach. Fencing with Épée; Ind. »	23
J. Fuchs. » » Sabre; » »	23
Hungary's team in Sabre Team Comp.	23
Sweden's » » Gymnastic » I	24
Italy's » » » » II	24
G. A. Braglia. Gymnastics, Ind. Comp	25
Norway's team in Gymnastics, Comp. III	25
A. Nordlander. Military	26
Sweden's team in Military	26
C. Bonde. Prize Riding	27
J. Cariou. » Jumping. Ind. Comp	27
Sweden's team in Prize Jumping	28
A. Gobert. Lawn Tennis (covered courts) Gentlemen's Singles and Gentlemen's Doubles	28
Edith M. Hannam. Lawn Tennis (covered courts). Ladies' Singles and Mixed Doubles	28
C. P. Dixon. Lawn Tennis (covered courts). Mixed Doubles	28
M. Germot. Lawn Tennis (covered courts). Gentlemen's Doubles	29
H. A. Kitson. Lawn Tennis (out-of-door courts). Gentlemen's Doubles	29
C. L. Winslow. Lawn Tennis (out-of-door courts). Gentlemen's Singles and Gentlemen's Doubles	29
Marguerite Broquedis. Lawn Tennis (out-of-door courts). Ladies' Singles	29
D. Köring and H. Schomburgk. Lawn Tennis (out-of-door courts). Mixed Doubles	29
G. Lilliehöök. Modern Pentathlon	30
W. D. Kinnear. Rowing. Single Sculls	30
Leander Club. Rowing. Eights, outriggers	30
Ludwigshafen R. V. Rowing. Fours, outriggers	31
Nykjøbing R. C. » » inriggers	31
Magda IX. Yacht Racing; 12-m. class	32
Kitty » » 10 » »	32
Taifun » » 8 » »	33
Mac Miche » » 6 » »	33
D. P. Kahanamoku. 100m. free style	34
It. Hebner. 100m. back stroke	34
W. Bathe. 200 and 400 m. breast stroke	34
G. Hodgson. 400 and 1,500 m. free style	34
E. Adlerz. High (plain) diving. Plain and variety diving	34
P. Günther. Spring-board diving	34
Australia's team in 800 m. team race	35
Great Britain's Water Polo team	35
Fanny Durack. 100m. free style for ladies	36
Greta Johansson. High (plain) diving for ladies	36
Great Britain's team in 400 m. team race for ladies	36
P. R. Colas. Shooting; Individual comp. b., and Individual comp. e	37
A. Prokopp. » » » c	37
U. S. A.'s team in Shooting: Team comp. a	37
Sweden's » » » » d	38
Great Britain's team in Shooting-Team comp. f	38
F. S. Hird. Shooting " Ind. comp. g	39
W. Carlberg » » » i	39
A. P. Lane » » » k. and Ind. comp. m	39
Sweden's team in Shooting; Team comp. h	39

	Pl. Page.
U. S. A.'s team in Shooting; Team comp. j.	40
Sweden's » » » » » l.	40
A. Swahn. Shooting; Ind. comp. q.	41
J. R. Graham. » » » o.	41
Å Lundeberg » » » r.	41
U. S. A.'s team in Clay Bird Shooting; Team comp. n.	41
Sweden's team in Running Deer Shooting; Team comp. p.	42

ILLUSTRATIONS IN THE TEXT.

Entry form for the Olympic Games of Stockholm, 1912:	
Face	24
Back	25
Series-tickets to the Stadium (Faces)	31
» » » » (Backs)	32
Illustration of method of marking in Team Shooting Competition a)	149
» » » » » Individual Shooting Competition b) ...	151
» » » » » » » » c) ...	153
» » » » » Team » » d) ...	155

PRIZES AND BADGES:

Olympic Prize- and Commemoration medals, 1912	43 160
Badges worn by the members of the International Olympic Committee, the National Olympic Committees and the Swedish Olympic Committee	44
Badges for officials, competitors and pressmen	45
H. M. King Gustaf V's medal in memory of the Olympic Games of Stock- holm, 1912	46
Prize Diploma, Olympic Games, 1912	47 162

CHALLENGE PRIZES:

Group of Olympic Challenge prizes	48 164
For the Marathon race, presented by H. M., the King of Greece	49
» Throwing the Discus, » » Mme G. De Montgomery	49
» the Pentathlon, » » H. M. The King of Sweden ...	50
» Decathlon, » » H. I. M. The Emperor of Russia	50
» Wrestling, Heavy Weight, » » The Gold- and Silversmith's Co	51
» Football, » » the English Football Association	51
» Fencing, Épée competition, » » the British Fencers	52
» » Sabre Team » » » the City of Buda-Pesth	52
» Gymnastics, Ind. » » » the City of Prague	53
» Horse Riding, the Military, » » H. I. M. The Emperor of Germany	53
» » » Prize Riding, » » H. I. M. The Emperor of Austria ...	54
» » » » Jumping, Ind. competition, presented by Count Géza Andrassy	54
» » » » Team » » » H. M. The King of Italy	55
» » » Challenge prize for the Horse Riding competitions presented by the Swedish Cavalry	55
» the Modern Pentathlon, presented by Baron P. de Coubertin	56
» Rowing, Eights, outriggers, » » Count Brunetta d'Usseaux	56
» Yacht Racing, 6-m. class, » » the French Government	57
» Swimming race, 1,500 metres, » » Count Brunetta d'Usseaux	57
» High plain Diving for Ladies, » » Countess de Casa Miranda ...	58
» Clay Bird Shooting, Ind. competition, presented by Lord Westbury	58
Sèvres Vase, presented by the President of the French Republic	59
Sèvres Dish, » » » the President of the French Republic	59

THE STADIUM:

Plan of the Stadium boundaries and those of the old Athletic Park	174
One of the gates at Sofiavägen Road	175

	Pl. Page.
Elevation of one of the side entrances	176
A side entrance, seen from within	177
Some of the brickwork patterns	179—180
View of the interior of the Stadium	184
Benches in the east amphitheatre, arranged as private boxes	186
Corridor in the east amphitheatre	188
A dressing-room and its furniture	189
The shower-baths	191
The premises beneath the amphitheatre as used during the Games, with the dressing-rooms for the various nations	192
South gate of the Stadium	60 192
A comer of the south gardens of the Stadium	61
The gardens and south arcade » » »	62
The south gateway	63
View of the gardens and east exterior of the Stadium	64
West side (exterior) of the Stadium	65
East side of the Stadium	66
East beacon- or clock-tower	67
The south arcade	68
A part of the south arcade	69
North arcade	70
Drinking fountain at the west beacon-tower	71
View from one of the east amphitheatre balconies	72
From the opening of the Stadium	73—75
Premises in the West tower	193
» » » East »	193
Entrance to the Royal Box	203
Folding gate in the south entry	206
Plan of the flag decoration of the Stadium	208
The Stadium Arena during the Olympic Games	76 208
» » » after the Games	77
» » » as a riding ground in the Horse Riding Comp.	78
Tools and implements for arranging the arena	79—82
Plan of the Postal- Telegraph- and Selling-booth arrangements in Valhalla- vägen, outside the Stadium	209
Telegraph- and Telephone-pavilion outside the Stadium	83 216
 THE SWIMMING STADIUM:	
Diving platform » » » »	212
Plan of Swimming Stadium	214
The starting place at the Swimming Stadium	215
The Swimming Stadium during the Olympic Games of 1912	84 216
» Royal Box at the Swimming Stadium	85
» Press Stand » » »	85
 OTHER COMPETING PLACES:	
Map of the environs of Stockholm, showing the situation of the scenes of the Olympic competitions	200
The Östermalm Athletic Grounds	86 216
» Råsunda Athletic Grounds	87
» Traneberg Athletic Grounds	88
» The Royal Tennis Pavilion (covered courts comp.)	89
Principal Courts for the Lawn Tennis out-of-door competitions	90
Map of the immediate neighbourhood of the Stadium, showing the Choir- Hall, the Östermalm Athletic Grounds, the Riding Grounds and the Olympia Pleasure Gardens	218
Plan of principal Lawn Tennis courts for out-of-door competitions	220
Plan of the Råsunda Athletic Grounds	221
View of Djurgårdsbrunnsviken and the Rowing Course	222
Plan of the Ranges for the rifle- and pistol shooting comp.	223

	Pl.	Page.
View from Nynäs. The scene of the Olympic Yacht Racing.....		223
The Yacht Racing courses at Nynäshamn		224
Maps of the Rowing-, Swimming-, and Shooting competitions, Yacht Racing courses and the course for the Marathon Race	91	224
Maps of the environs of Stockholm, showing the scenes of the Olympic Competitions, and the course for the Cycling Road Race round Lake Mälär, with the various control stations	92	225
The Official Poster of the Olympic Games 1912	93	264
Torsten Schonberg's design for poster.....		265
The advertising stamp and the text in various languages.....		269
Heading of advert. in the Continental Daily Mail.....		278
Postal Advertisement Stamp		279
New Year's Card issued by the Swedish Telegraph Officials, 1912		280
Heading of Poster for Swimming Competitions		283
Poster for Horse Riding Competitions.....		284
THE SOLEMN OPENING OF THE GAMES:		
The Royal Procession	94	304
A group of members of the International Olympic Committee and of the Swedish Olympic Committee.....		95
H. M. the King declares the Olympic Games opened.....		96
The Nations drawn up in the arena of the Stadium		97
The Grand March Past of the Athletes, seen from the north arcade.....		98
THE GRAND MARCH PAST OF THE NATIONS		
Belgium		99
Chili.....		100
Denmark.....		101
France		102
The United States of America		103
Greece.....		104
Holland and Italy		105
Japan, Luxemburg and Norway		106
Russia		107
Finland		108
Great Britain		109
Canada, Australasia and South Africa.....		110
Germany.....		111
Austria and Bohemia.....		112
Hungary		113
Sweden		114
The Swedish Officials		115
The Swedish team of Women Gymnasts		116
The Swedish team of Men Gymnasts		117
ATHLETICS:		
Group of Officials	118	344
Leaders' Platform		119
The connection of the electric timing apparatus with the starter's pistol		119
Stand for judges at finish.....		120
Group of timekeepers and the electric apparatus for timetaking.....		121
Plan of the Arena of the Stadium		345
Final, 100 m. Flat. The Start	122	352
» 100 » » Immediately after the Start.....		122
» 100 » » The Finish		123
Start for 200 m. Flat.....		124
Final, 200 m. Flat. The Finish		125
Start for 400 m. Flat. Semi-Final.....		126
400 m. Flat. Paul Zerling (Sweden) beating Mishima (Japan).....		126

	Pl. Page.
Final, 400 m. Flat. The Finish	127 368
» 400 » » »	128
» 800 » » The Start	128
» 800 » » During the race	129
» 1,500 m. Flat. The Start.....	129
» 800 m. Flat. The Finish.....	130
» 1,500 m. Flat. The Finish.....	131
» 5,000 m. Flat. The Start	132
» » » » During the race.....	132
10,000 m. Flat. H. Kolehmainen, Finland, winner.....	133
Final, 5,000 m. Flat. Kolehmainen and Bouin. The Finish	133
» Hurdle Race	134 376
Hurdle Race 110 m. F. W. Kelly, winner.....	135
Relay Race 400 in. Trial Heat. Sweden—Hungary	136
Final, Relay Race 400 m. During the race	136
» » » » The Finish	137
Relay Race 1,600 in. The second handing on of staff by U. S. A. team	137
Final. Team Race 3,000 in.....	138
» » » » The Finish	139
» » » »	140
Swedish competitors in the Cross-Country race.....	140
Cross-country race. The Start.....	141
The Start for the Marathon Race	142 384
The Marathon runners leave the Stadium	143
Marathon Race. Mc Arthur at the entrance of the Stadium	144
» » Mc Arthur, winner	145
» » C. W. Gitsam, 2:nd man	145
» » C. Strobino, 3:rd man	146 388
» » Sigge Jacobsson, best European.....	146
Walking Race 10,000 m. G. H. Goulding, winner	147
» » » »	147
Monument at Sollentuna. The turn in the Olympic Marathon Race.....	148 390
Running High Jump. A. W. Richards, winner	148 400
» » » H. Liesche, 2:nd man... ..	149
» » » G. Horine, 3:rd man.....	149
Standing » » C. Tsiclitiras	150
» » » Platt Adams, winner	150
» » »	151
Running Broad Jump. A. L. Gutterson.....	151
» » » C. D. Bricker, 2:nd man.....	152
» » » G. Åberg, 3:rd man.....	152
» » » A. L. Guttersson, winner.....	153
Standing » » Platt Adams	153
» » » » 2:nd man.....	154
» » » C. Tsiclitiras, winner	154
» » » G. Malmsten, 4:th man	155
» » » Ben Adams	155
The Hop, Step and Jump. G. Åberg	156
» » » G. Lindblom, winner	156
Pole Jump. B. Uggla, bracketed 3:rd man	157
» » H. S. Babcock, winner	157
» » F. T. Nelson, 2:nd man.....	158
» » M. S. Wright, bracketed 2:nd man	159
Throwing the Javelin, best hand. E. Lemming, winner	160 408
» » » r. & l. h. J. Saaristo, winner	161
» » Discus. A. R. Taipale, winner	162
» » »	163
» » » R. L. Byrd, 2:nd man	164
» » » E. Magnusson, 3:rd man	164
» » » J. H. Duncan, 3:rd man	165

Fifth Olympiad.

	Pl. Page
Putting the Weight Competition	166
» » » P. Mc Donald, b. h., winner	167
» » » Ralph Rose, r. & i. h., winner	168
» » » E. Niklander, 3:rd man	168
Throwing the Hammer, M. J. Mc Grath, winner	169
Decathlon. Broad Jump. H. Wieslander	170
» » » E. L. Mercer	170
» Pole » H. Wieslander	171
» » » J. Thorpe	171
 TUG-OF-WAR:	
Great Britain's Tug-of-War team	172 424
The first bout, G. Britain v. Sweden, won by the Swedish team	172
Tug-of-War. Great Britain v. Sweden	173
Second bout in Tug-of-War	173
 CYCLING:	
R. Lewis, winner, chaired by his countrymen	174 440
» » about to ride in through the grand south entrance of the Stadium	175
 FENCING:	
Group of competitors and officials	176 456
Épée Team Competition	177
Final in Épée Competition. Anspach v. Seligman	178
Final in Sabre Competition. Fuchs v. Nadi	179
Group of Competitors in Final of Foil Comp.	180
Final in Foil competition., Berti v. Békesy	180
Group of competitors in Épée Individual Comp.	181
Great Britain's team in Épée Competition	181
Sweden's team in Épée Competition	182
Group of competitors in Final of Sabre Individual Competition	182
Great Britain's team in Sabre Competition	183
Italy's team in Sabre Competition	183
 FOOTBALL:	
Great Britain v. Denmark in the Football Final at the Stadium	184 480
H. R. H. the Crown Prince and the Hungarian Football team	185
From the Football Final. The Danish captain at work	186
» » » » The British goal in danger	187
Football. Holland v. Sweden. The Dutch goalkeeper saving	188 496
» Great Britain v. Hungary	189
» Finland v. Italy	189
» Great Britain v. Finland	190
» Austria v. Germany	190
Denmark's Football Team	191
Finland's » »	191
Holland's » »	192
Italy's » »	192
Norway's » »	193
Russia's » »	193
Sweden's » »	194
Germany's » »	194
Hungary's » »	195
Austria's » »	195
 GYMNASTICS:	
One side of fixed gymnastic apparatus	506
Detail-drawing, showing method of fixing the ribb-stalls, and the beams and the bands of iron across the beams	507

	Pl. Page.
Plan of the removable gymnastic apparatus, with one side turned outwards	507
Detail-drawing of iron sockets sunk in arena and of the posts, for fixed gymnastic apparatus	508
Plan, showing the beams, and the iron-bands across them for fixing the ribb-stalls	508
Detail-drawing showing method of fastening together the top beams	509
Detail-drawing of the top beams and of the iron band around them	509
Plan showing mountings for fastening of ribb-stalls	510
Swedish Gymnasts in Team Competition I. Balance-walk on beam	196 512
Norwegian Gymnasts in Team Competition I. "Steep-hanging"	197
Swedish Gymnasts in Team Comp. I. Arch-steep-standing	198
Danish Gymnasts in Team Comp. I.	198
Hungarian Gymnasts in Team Comp. II	199
British » » » » II on pommel horse	199
» » » » II » » » »	200
» » » » II	201
German » » » » II	201
Luxemburg » » » » II	202
Norwegian » » » » III	203
Finnish » » » » III Forward Bow-lying with living support	203
The Norwegian Gymnasts in Team Comp. III Straddle-vault over horse from spring-board	204 528
The Danish Gymnasts in Team Comp. III (Parallel bars)	204
Display team of Swedish Men Gymnasts. March at the double	205
» by Swedish Gymnasts. Various styles of vaulting	205
» » Swedish Gymnasts	206
» » » »	207
Display team of Danish Gymnasts	208 544
Display by Russian Gymnasts	209
» » Norwegian Women Gymnasts	209
March past: Danish » » » »	210
Display by » » » » Inside vault over horse	210
» » » » Wing-step-position. Side-twisting	211
» » Finnish » » » »	212 552
» » » » » » » »	213
» » » » » » » »	213
Swedish Women Gymnasts march into the Stadium	214 560
Display team : Swedish Women Gymnasts	214
» by » » » »	215
» » » » » » » »	216
» » » » » » » » Climbing vertical ropes	217

HORSE RIDING COMPETITIONS :

Committee for Horse Riding Competitions at the Olympic Games of Stockholm, 1912	218 568
The Stadium during the Prize Jumping. In the foreground H. R. H. Prince Friedrich Karl of Prussia	219
Arrival in state of Their Majesties, The King and Queen	220
The competitors in the Horse Riding Events presented to H. M. the King	221
Map of the course for the Distance- and Cross-Country Riding in the Military	584
Germany's team in the Field Competition "Military"	222 592
U. S. A.'s » » » » » » » »	222
Lieutenant von Rochow in the "Military"	223
Count C. Bonde in the Prize Riding	223
Captain Cariou » » » » Jumping	224
Baron de Blommaert in the Prize Jumping	224
H. R. H. Prince Friedrich Karl of Prussia in the Prize Jumping	225
Captain Rodzianko in the Prize Jumping	225

	Pl.	Page.
Count C. Lewenhaupt in the Prize Jumping	226	
The team of France in Team Prize Jumping.....	226	
Germany's team in Team Prize Jumping.....	227	
Russia's team » » » »	227	
H. M. the King presenting the Swedish Cavalry's prize to H. R. H. Prince Carl of Sweden	228	
H. M. the King presenting the 1:st prize for Individual Prize Jumping to Captain Cariou.....	229	
Plan of Stadium Stables. Steeple-chase course, etc.....	608	
Face of Entry-form for Horse Riding Competitions.....	611	
Back » » » » »	612	

LAWN TENNIS:

Final in Mixed Doubles (covered courts)	230	624
C. Kempe and G. Setterwall in Gentlemen's Doubles (covered courts)...	231	
Final in Gentlemen's Singles (out-of-door courts).....	231	
View from Lawn Tennis Comp. (» »).....	232	632
Final in Gentlemen's Doubles (» »).....	233	
» » Mixed Doubles (» »).....	234	
H. M. the King presenting prizes for Lawn Tennis Competitions (out-of- door courts).....	235	

MODERN PENTATHLON:

Épée Fencing.....	236	640
» » Wersäll v. Åsbrink	236	
» » De Mas Latrie v. G. Patton	237	
» » Aejmelaens v. Mannström	237	
Cross-Country Race. Grönhagen leaving the Stadium	238	644
» » » Asbrink re-entering the Stadium.....	239	
» » » Grönhagen re-entering the Stadium.....	239	
» » » G. de Laval at the tape	240	
Singing Swedish National Anthem in Stadium, when the three Swedish prize-flags were hoisted for the Modern Pentathlon	241	

ROWING:

Eights, outriggers. Semi-final. Leander C. beating Australasia.....	242	672
Leander Rowing Club's Eight.....	243	
Eights, outriggers. Final	244	
» » Berliner R. G. beating Sport Borussia	244	
» » Sweden beating Norway.....	245	
Fours, » Final. Germany beating Thames R. C.....	245	
» » Thames Rowing Club.....	246	
» inriggers. Denmark leading.....	246	
» » Sweden beating Ormsund	247	
Single Sculls. P. Veirman	247	
» » Kinnear v. Veirman.....	248	
» » » v. Butler.....	248	
Stockholm Rowing Club's Boat-house.....	249	

SHOOTING :

Group of all the foreign and Swedish leaders of the Shooting competitions	250	680
Rifle Competitions, Kaknäs	251	
» » »	252	
» » »	252	
U. S. A. Rifle-team competing.....	253	
» Marksmen at Kaknäs	254	704
» Army-rifle shown to H. M. The King	255	
» Rifle-team	255	
Denmark's »	256	
Rifle-team of France	256	
Norway's Rifle-team	257	

	Pl. Page.
South Africa's Rifle-team	257
Sweden's Rifle-team	258
» Pistol-shooting-team	258
A Pistol-shooting competition	259
A Clay Bird shooting competition	260
Spectators at Clay Bird shooting	261

SWIMMING:

Long Distance Swimming. G. Hodgson	262	720
Start for Swimming Race	262	
100 m. Free Style, Ladies. Final	263	
Start for Team Race, Ladies	264	
Plain and Variety Diving. Albert Zürner	264	
Plain Diving. Men. Erik Adlerz	265	
» » » Toivo Aro	265	
Plain and Variety Diving. Hjalmar Johansson	266	744
» » » George Yvon	266	
Plain Diving. Men. German style	267	
Plain Diving. Ladies. Greta Johansson	268	
» » » Lisa Regnell	269	
» » » Isabelle White	270	
» » » Tora Larsson	271	
Water Polo. Sweden v. France	272	
» » Belgium v. Hungary. In front of Hungary's goal	273	
» » Belgium v. Hungary. In front of Belgium's goal	273	

WRESTLING:

Feather Weight. A double-nelson by Larsson parried by Stein	274	752
» » A chancery-hold by Hansen parried by Andersson	274	
» » Persson compelled to bridge by Gullaksen	275	
Middle Weight B. Fogelmark v. Salila	275	
» » A. Klein v. Asikainen	276	
» » A. Clas Johansson at work	276	
» » B. Ahlgren v. Béla Varga	277	
» » B. Ahlgren v. » »	277	

YACHT RACING:

Vessels with spectators, Nynäshamn	278	766
Journalists on Steam-Yacht "Saga"	279	
View of Starting-place for Olympic Yacht Racing	280	768
Erna-Signe	281	
Erna-Signe—Heatherbell	282	
Nina	283	
Sans Atout	284	
Lucky Girl	285	
Taifun. Norman. Örn	286	
Nurdug II	287	

PRESENTATION OF THE PRIZES:

Distribution of Prizes at the Olympic Games of Stockholm, 1912. General view	288	784
Challenge prizes and oak-wreaths	289	
H. M. The King crowning the winner of the 100 m. flat	290	
H. M. The King crowning the winner of the Marathon Race	291	
H. Kolehmainen at the distribution of prizes	292	
The winner in Swimming, 100 m., Ladies, receiving her prize	292	
H. R. H. the Crown Prince presenting the 2:nd prize for the Modern Pentathlon	293	
H. R. II. the Crown Prince presenting the 2:nd prize for Team Swimming Race, 400 m. Ladies	294	

	Pl. Page.
H. R. H. Prince Carl presenting the 3:rd prize for Throwing the Discus	294
H. M. The King presenting the 1:st prize in the Military	295

DISPLAYS, etc.:

A corner of boy scouts' camp, Djurgården	296	816
Boy scouts saluting the Swedish flag	297	
One of the foreign ensigns chaired	298	
Gymnastics in boy scouts' camp	298	
Gymnastic display by boy scouts in the Stadium	299	
Icelandic "Glima"-wrestling	300—	301 820
Västerås Baseball-Club team	302	824
Baseball match, U. S. A. v. Sweden. Axell, Sweden, batsman : Davenport, U. S. A., catcher	302	
Baseball match, U. S. A. v. Sweden. Practice before game. Holdan, batsman. Davenport, catcher	303	
Baseball match, U. S. A. v. Sweden. Wickman, Sweden, making a two-base hit to centre-field. Davenport, catcher	303	
Baseball match, U. S. A. v. Sweden. Welin, Sweden, racing to 1:st base after a short hit. Blanchard at 1:st base	304	
Baseball match, U. S. A. v. Sweden. Sweden in. U. S. A. fielding. Adams batsman. Davenport catcher	304	
Choral festival in the Stadium, 13 July, 1912	305	

RULES AND REGULATIONS FOR THE COMPETITIONS :

Placing of the jurors for judging the Fencing	1018
Horse Riding Competitions. Example of the Display programme	1039
» » » Obstacles used in the competitions	1042
» » » » in the "Military"	1044
» » » » » Prize Jumping	1044
Modern Pentathlon. Figure for Duel-Shooting	1049
Drawing of a Four-oared Inrigger	1053
Apparatus for measuring a Four-oared Inrigger	1054
Shooting. Target for 200 metres	1056
» » » 400, 500 and 600 metres	1057
» Stationary ("Precision") Target	1058
» Half-figure	1059
» Target for 300 metres. (Comps. d and e)	1060
» » » 50 metres. (Comps. f and g)	1061
» Whole-figure for competitions h, i, l and m	1062
» Target for 50 metres (Comps. j and k)	1063
» Running Deer	1066
Swimming. High Dive. Plain Header	1077
» » » Backward Header	1078
» » » » Somersault	1078
» » » » spring outwards and turning inwards with header	1079
» » » » spring outwards and turning inwards with somersault	1080
» » » » spring outwards and turning inwards with 1½ somersault	1080
» » » » Armstand with header	1081
» » » » » overback	1082
» » » » » somersault	1083
» » » » One somersault forwards	1084
» » » » Flying somersault forwards	1085
» » » » One and a half somersault forwards	1086
» » » » Isander's dive	1087
» » » » Mollberg's »	1088
Spring-Board Dive. Plain Header	1089

	Page.
Spring Board Dive. Falling Dive Forwards	1089
» » Ordinary header forwards (arms by sides)	1089
» » Screw Dive forwards with half turn	1089
» » » » one turn.	1090
» » Pike Dive forwards	1090
» » » » (arms by sides)	1090
» » Forward somersault	1090
» » Flying » forwards	1091
» » One and a half somersault	1091
» » » » » (arms stretched by sides)	1091
» » Isander's dive	1092
» » Mollberg's dive	1092
» » Falling dive backwards	1092
» » Ordinary header backwards	1092
» » Pike dive with backward spring and turning inwards	1093
» » Backward somersault	1093
» » Pike dive with backward spring, turning inwards and somersault	1093
» » Pike dive with backward spring, turning inwards and 1 somersault	1093



Gustaf

H. M. KING GUSTAF V.
PATRON
OF
THE OLYMPIC GAMES OF STOCKHOLM 1912.

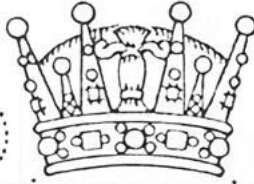

H. R. H. CROWN PRINCE GUSTAF ADOLF

HON. PRESIDENT OF THE
SWEDISH OLYMPIC COMMITTEE
FOR THE OLYMPIC GAMES
OF STOCKHOLM 1912.

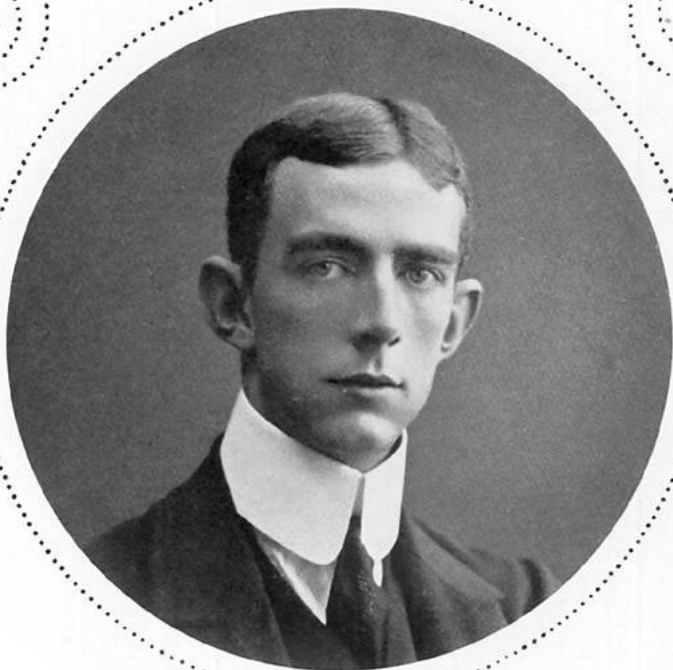

H. R. H. PRINCE WILHELM

HON. PRESIDENT OF THE SWEDISH OLYMPIC
LAWN TENNIS COMMITTEE.





H. R. H. PRINCE CARL

HON. PRESIDENT OF THE SWEDISH OLYMPIC COMMITTEE
FOR THE HORSE RIDING COMPETITIONS.

ES

MEMBERS OF THE SWEDISH OLYMPIC COMMITTEE FOR THE
OLYMPIC GAMES OF STOCKHOLM, 1912.

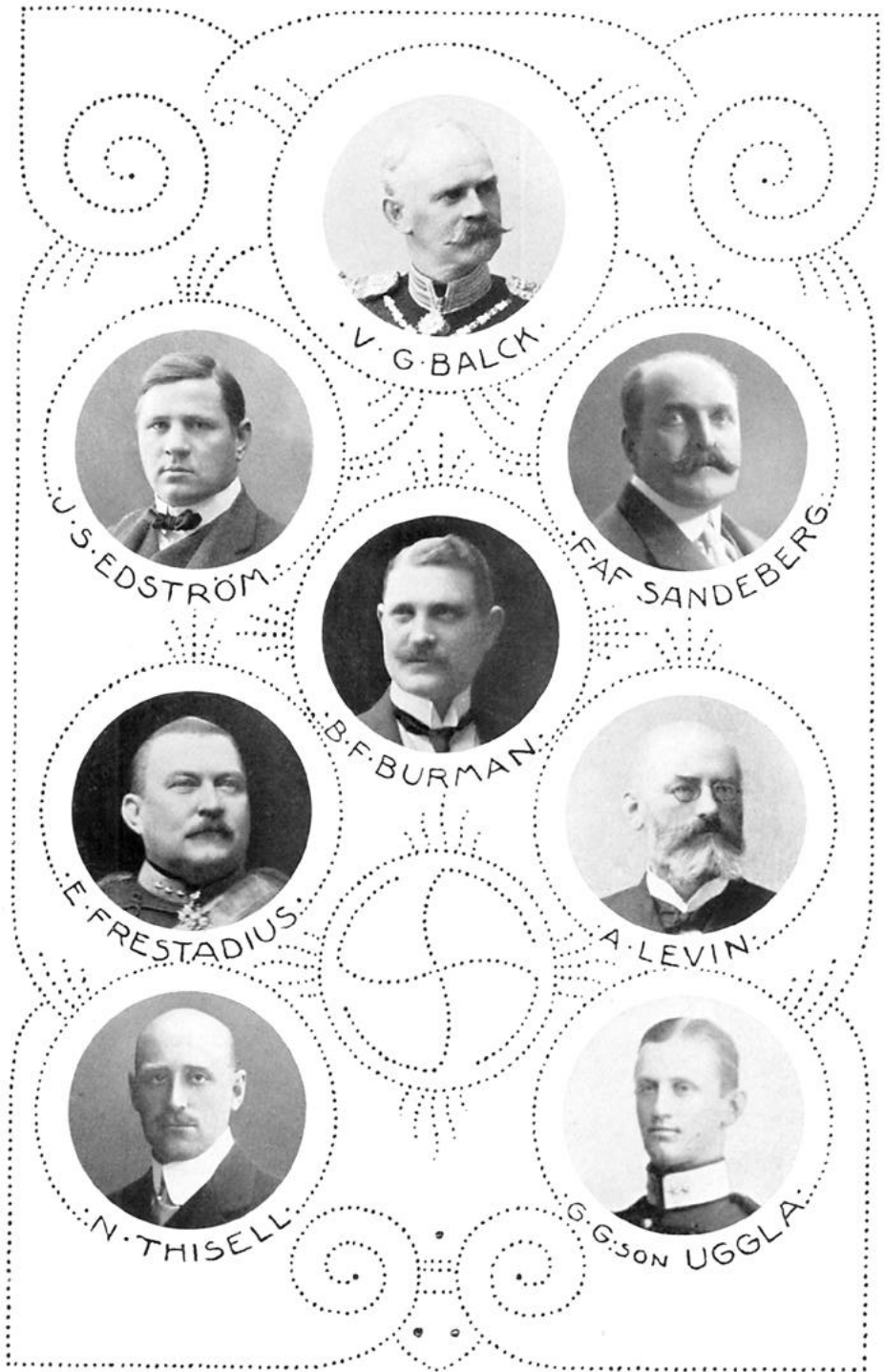

MEMBERS OF THE SWEDISH OLYMPIC COMMITTEE FOR THE
OLYMPIC GAMES OF STOCKHOLM, 1912.



PRESIDENTS OF THE SPECIAL COMMITTEES.



V.G. BALCK
ATHLETICS
MODERN PENTATHLON



O. BERGSTROM
ACCOMODATION COM.



E. BERGVALL
SWIMMING



FR. BJÖRKENSTAM
CLAY BIRD AND
RUNNING DEER
SHOOTING



C. GÖSTA DRAKE
CYCLING-TUG-OF-WAR



EMIL FICK
FENCING



E. FRESTADIUS
RECEPTION COM.



C. HELGESSON
WRESTLING.



S. HERMELIN
PRESS COMMITTEE

PRESIDENTS OF THE SPECIAL COMMITTEES.

O. HOLTERMANN
YACHT RACING

AXEL LIJJA
ENTERTAINMENTS COM.

C.L. KORNERUP
ADVT'S COM. - FOOTBALL

C. LEWENHAUPT
GAME SHOOTING

N. LJUNGGREN
ROWING

E. NERMAN
GYMNASTICS

E.C.G. OXENSTIERNA
HORSE RIDING COMR

C.E. TAUBE
RIFLE SHOOTING

A. WALLENBERG
LAWN TENNIS

E. ULLÉN
MOUNTAIN - ASCENTS

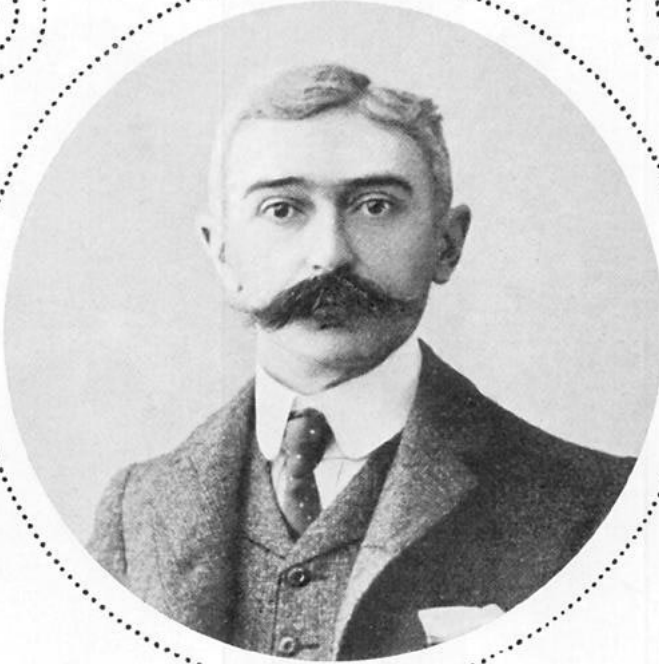

BARON PIERRE DE COUBERTIN

PRESIDENT OF THE INTERNATIONAL OLYMPIC
COMMITTEE.

ES

THE LEADING PERSONAGES OF THE FOREIGN OLYMPIC COMMITTEES.



COLONEL ROBERT M. THOMPSON

PRESIDENT AMERICAN OLYMP. COM.



LEON MUELLER

SECR. AUSTRIAN OLYMP. COM.



BARON DE LAVELEYE

PRESIDENT BELGIAN OLYMP. COM.



JAMES E. SULLIVAN

SECR. AMERICAN OLYMP. COM.



DR. JIRI GUTH

PRESIDENT BOHEMIAN OLYMP. COM.



J. ROESSLER-OROVSKY

SECR. BOHEMIAN OLYMP. COM.



JAMES G. MERRICK, B.A.

PRES. CANADIAN OLYMP. COM.



LT. COL. F. HANSEN

PRESIDENT DANISH OLYMP. COM.



LT. IVAR NYHOLM

SECR. DANISH OLYMP. COM.



NORTON H. CROW

SECR. CANADIAN OLYMP. COM.

THE LEADING PERSONAGES OF THE FOREIGN OLYMPIC COMMITTEES.

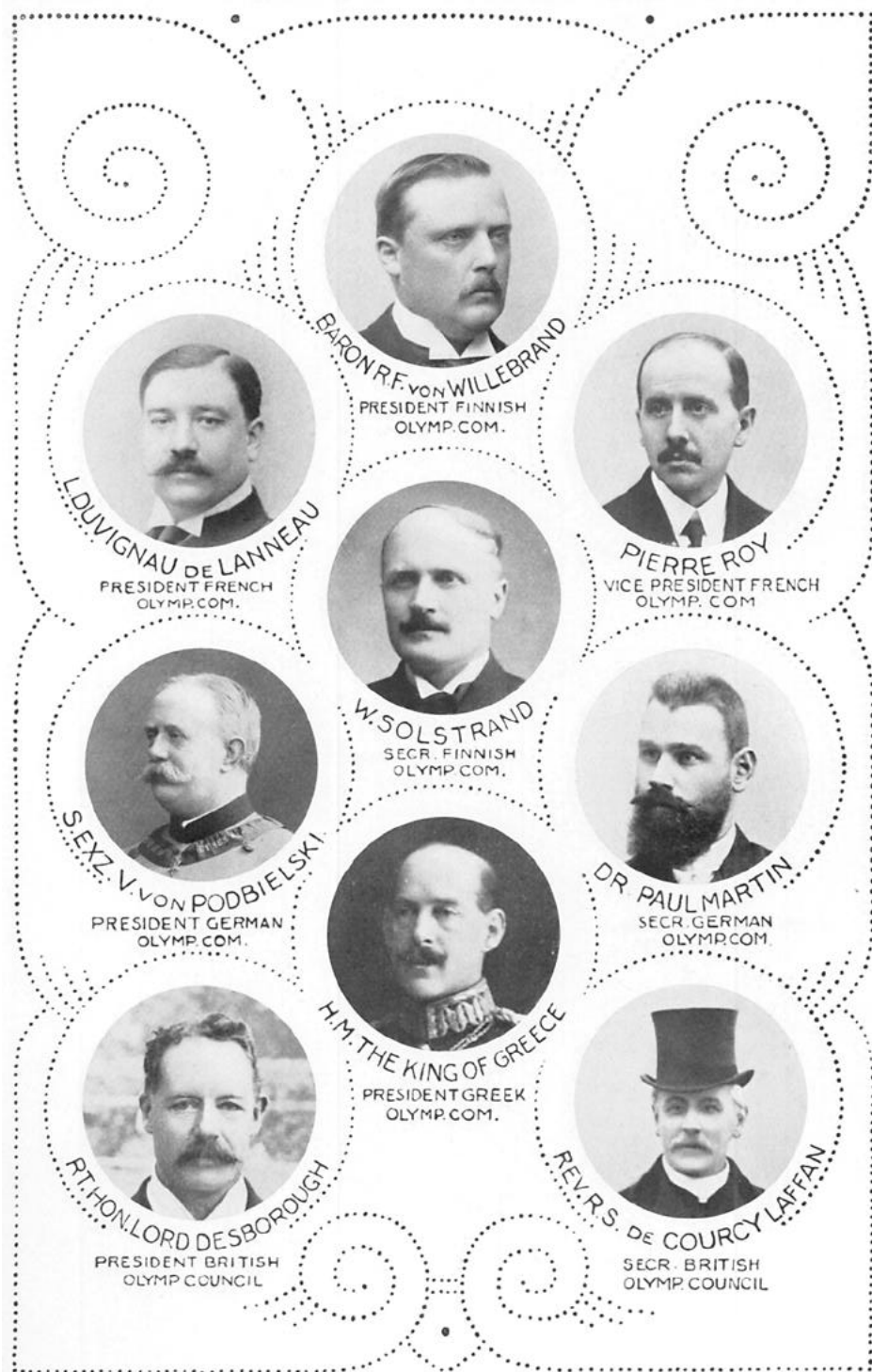

THE LEADING PERSONAGES OF THE FOREIGN OLYMPIC COMMITTEES.



PROF. SP. LAMBROS

SECR. GREEK OLYMP. COM.



BARON F. W. DE TUYLL

PRESIDENT DUTCH OLYMP. COM.



COUNT W. DE STIRUM

SECR. DUTCH OLYMP. COM.



JULIUS VON MUSZA

PRESIDENT HUNGARIAN OLYMP. COM.



MARQUIS COMPANS DE BRICHANTEAU

PRESIDENT ITALIAN OLYMP. COM.



F. BALLERINI

TREASURER ITALIAN OLYMP. COM.



DESIDER LAUBER

SECR. HUNGARIAN OLYMP. COM.



MAURICE PESCATORE

PRESIDENT LUXEMBURG OLYMP. COM.



ALOYS KAYSER

SECR. LUXEMBURG OLYMP. COM.

THE LEADING PERSONAGES OF THE FOREIGN OLYMPIC COMMITTEES.



DIRECTOR JIGORO KANO
PRESIDENT JAPANESE
OLYMP. COM.



CAPTAIN JOHAN SVERRE
PRESIDENT NORWEGIAN
OLYMP. COM.



LT. C. FROLICH-HANSEN
SECR. NORWEGIAN
OLYMP. COM.



DR. J. MAUPERRIN SANTOS
PRESIDENT PORTUGUESE
OLYMP. COM.

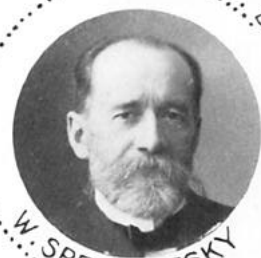

W. SRESNEFFSKY
PRESIDENT RUSSIAN
OLYMP. COM.



HENRY NOURSE
PRESIDENT SOUTH AFRICAN
OLYMP. COM.



DR. JOSE PONTES
SECR. PORTUGUESE
OLYMP. COM.



BARON G. DE BLONAY
PRESIDENT SWISS
OLYMP. COM.



PROF. E. RICHÈME
SECR. SWISS
OLYMP. COM.

WINNERS IN THE FIFTH OLYMPIAD.



R. C. CRAIG,
U. S. A.
100 and 200 m. Flat.



C. D. REIDPATH,
U. S. A.
400 m. Flat.



J. MEREDITH,
U. S. A.
800 m. Flat.



A. N. JACKSON,
Great Britain.
1,500 m. Flat.



H. KOLEHMAINEN,
Finland.
5,000 m. and 10,000 m. Flat
and Cross Country Race.



F. W. KELLY,
U. S. A.
Hurdle Race 110 m.

WINNERS IN THE FIFTH OLYMPIAD.

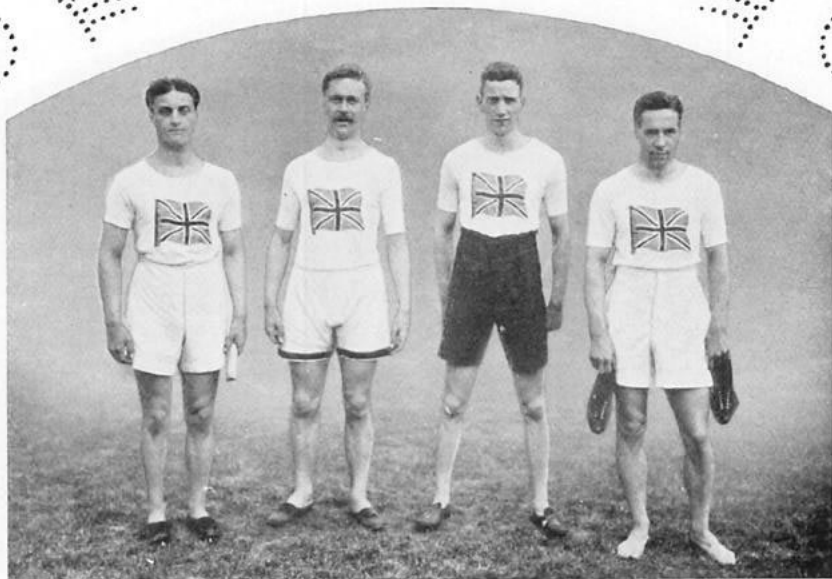

Great Britain's team in Relay Race 400 m.

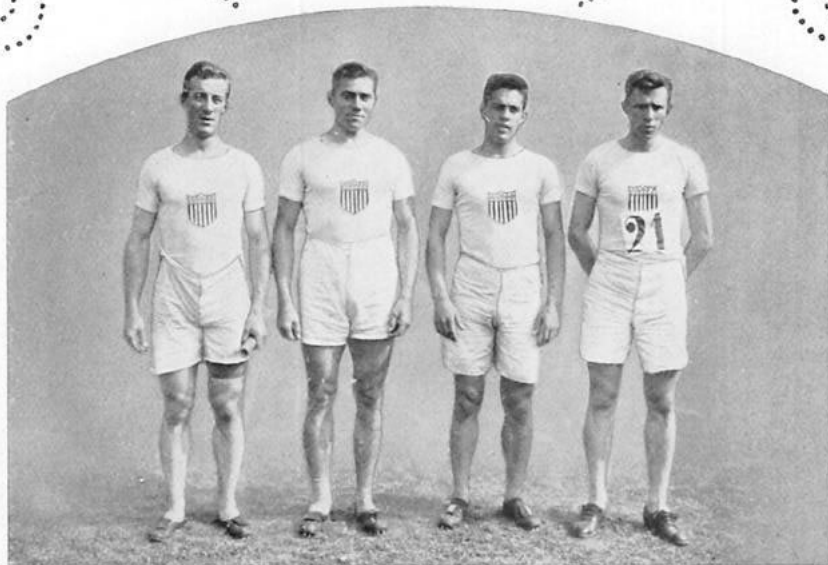

U. S. A.'s team in Relay Race, 1,600 m.

WINNERS IN THE FIFTH OLYMPIAD.



U. S. A.'s team in Team Race, 3,000 m.



Sweden's team in Cross Country Race, 8,000 m.

WINNERS IN THE FIFTH OLYMPIAD.



K. K. Mc ARTHUR
South Africa.
Marathon Race.



G. H. GOULDING.
Canada.
Walking Race, 10,000 m.



A. W. RICHARDS,
U. S. A.
Running High Jump.



PLATT AL ADAMS,
U. S. A.
Standing High Jump.



A. L. GUTTERSON,
U. S. A.
Running Broad Jump.



C. TSICLITIRAS,
Greece.
Standing Broad Jump.

WINNERS IN THE FIFTH OLYMPIAD.



G. LINDBLOM,
Sweden.
Hop, Step and Jump.



H. S. BABCOCK,
U. S. A.
Pole Jump.



E. LEMMING,
Sweden.
Throwing the Javelin, best. h.



J. SAARISTO,
Finland.
Throwing the Javelin, r. & l. h.



A. R. TAIPALE,
Finland.
Throwing the Discus, b. h.; r. & l. h.



P. MC DONALD,
U. S. A.
Putting the Weight, b. h.

WINNERS IN THE FIFTH OLYMPIAD.



RALPH ROSE,
U. S. A.
Putting the Weight,
r. & l. h.



M. J. MC GRATH,
U. S. A.
Throwing the Hammer.



F. R. BIE,
Norway.
Pentathlon.



H. WIESLANDER,
Sweden.
Decathlon.



Sweden's team in Tug-of-War.

WINNERS IN THE FIFTH OLYMPIAD.



K. KOSKELO,
Finland.
Wrestling; Feather Weight

E. E. WARE,
Finland.
Wrestling; Light Weight.

C. E. JOHANSSON,
Sweden.
Wrestling; Middle Weight A.



A. O. AHLGREN,
Sweden.
Wrestling; Middle Weight B.

I. T. BÖLING,
Finland.
Wrestling; Middle Weight B.

U. SAARELA,
Finland.
Wrestling; Heavy Weight.

WINNERS IN THE FIFTH OLYMPIAD.



R. LEWIS,
South Africa.
Cycling Road Race round Lake Mälär. Ind. Comp.

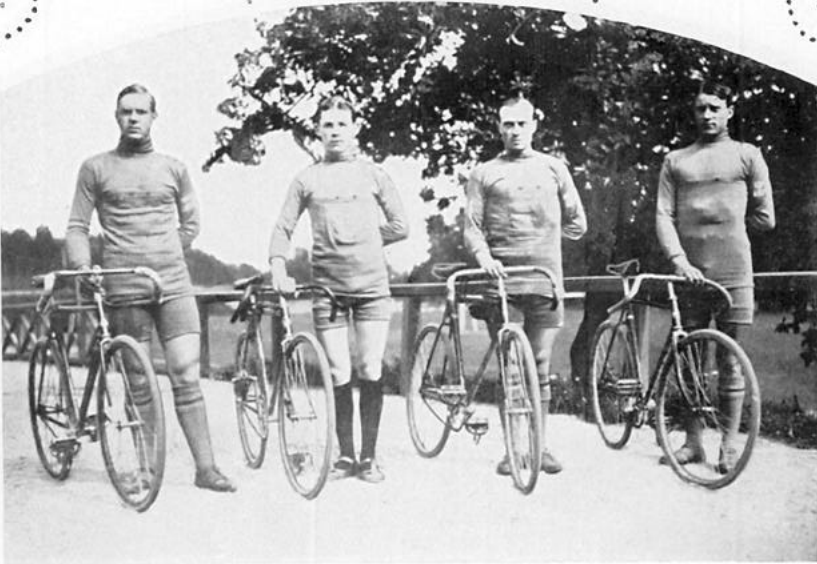

Sweden's team in Cycling Road Race round Lake Mälär. Team Comp.

WINNERS IN THE FIFTH OLYMPIAD.



Great Britain's team in Football Comp.



Belgium's team in Épée Team Comp.

WINNERS IN THE FIFTH OLYMPIAD.



N. NADI,
Italy.
Fencing with Foils; Ind. Comp.



P. ANSPACH,
Belgium.
Fencing with Épée; Ind. Comp.



J. FUCHS,
Hungary.
Fencing with Sabre; Ind. Comp.

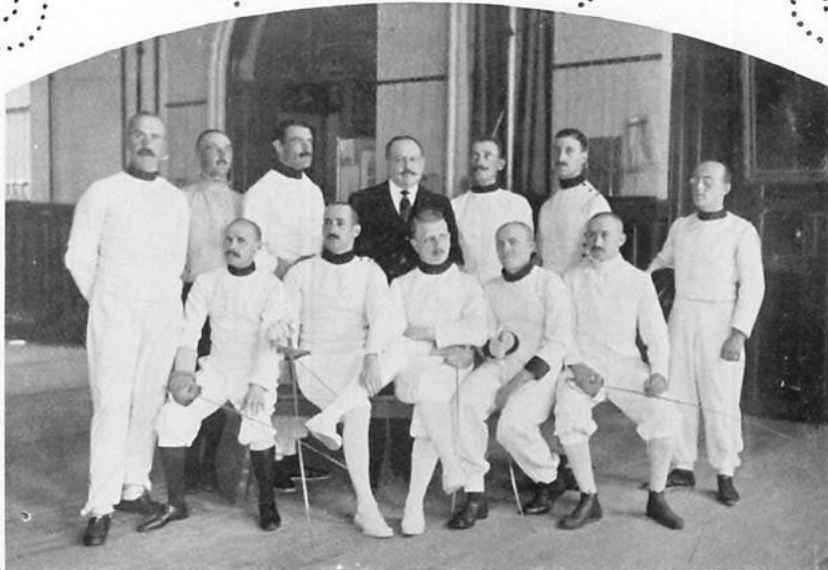

Hungary's team in Sabre Team Comp.

WINNERS IN THE FIFTH OLYMPIAD.

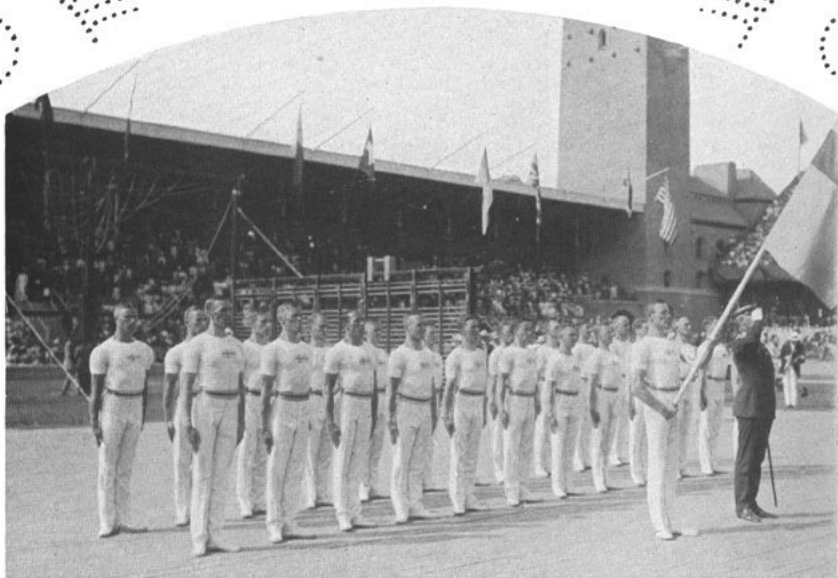

Sweden's team in Gymnastic Comp. I.



Italy's team in Gymnastic Comp. II.

WINNERS IN THE FIFTH OLYMPIAD.



G. A. BRAGLIA,
Italy.
Gymnastics; Individual Comp.

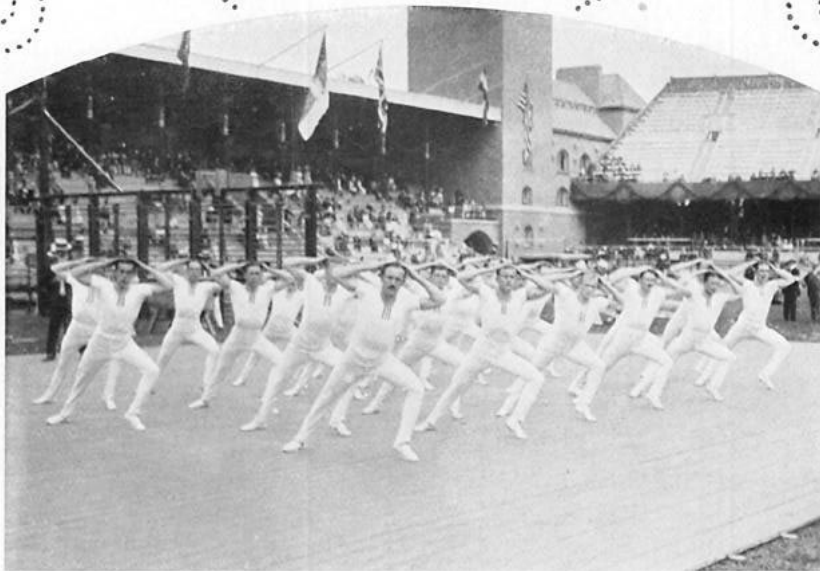

Norway's team in Gymnastic Comp. III.

WINNERS IN THE FIFTH OLYMPIAD.



Lieutenant A. NORDLANDER,
Sweden.
Military; Ind. Comp.

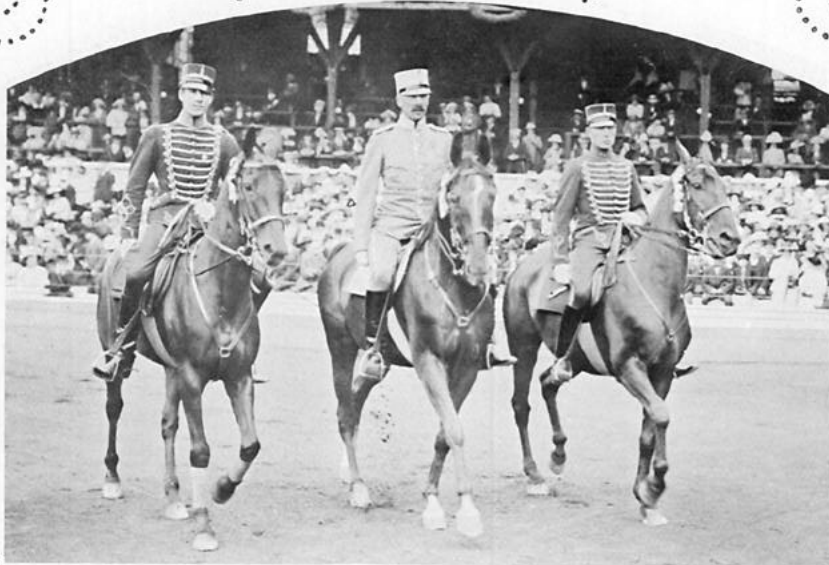

Sweden's team in the Military.

WINNERS IN THE FIFTH OLYMPIAD.

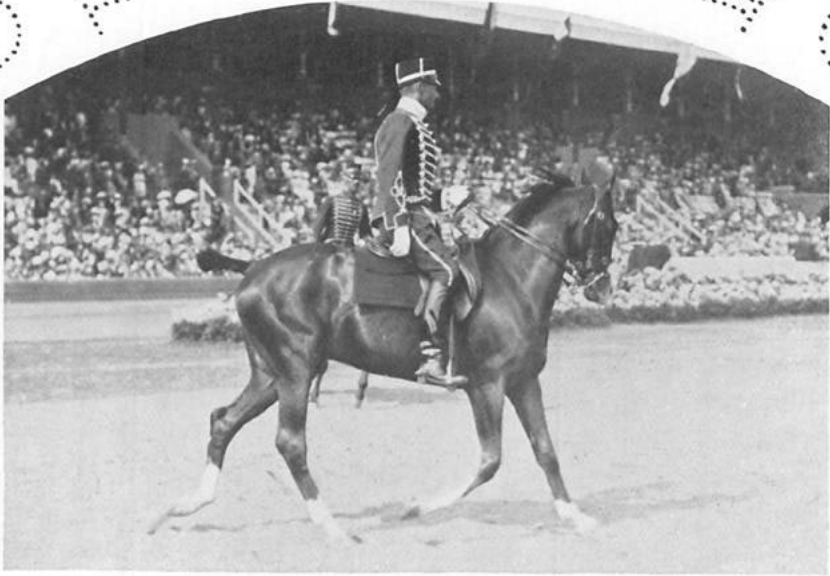

Count C. BONDE,
Sweden.
Prize Riding.



Captain J. CARIOU,
France.
Prize Jumping; Ind. Comp.

WINNERS IN THE FIFTH OLYMPIAD.

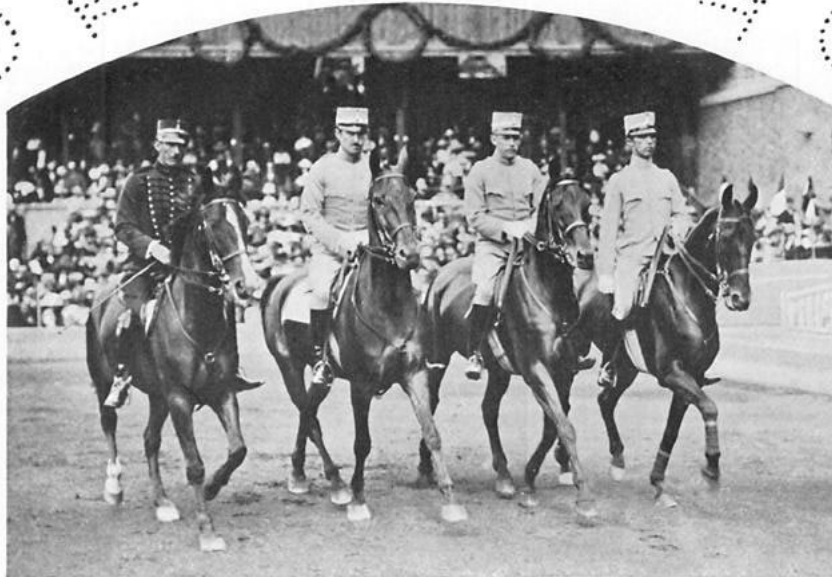

Sweden's team in Prize Jumping.



A. GOBERT,
France.
Lawn Tennis (covered courts).
Gentlemen's Singles and
Gentlemen's Doubles.



Mrs. E. M. HANNAM,
Great Britain.
Lawn Tennis (covered courts).
Ladies' Singles and Mixed
Doubles.



C. P. DIXON,
Great Britain.
Lawn Tennis (covered courts).
Mixed Doubles.

WINNERS IN THE FIFTH OLYMPIAD.



M. GERMOT,
France.
Lawn Tennis (covered courts).
Gentlemen's Doubles.

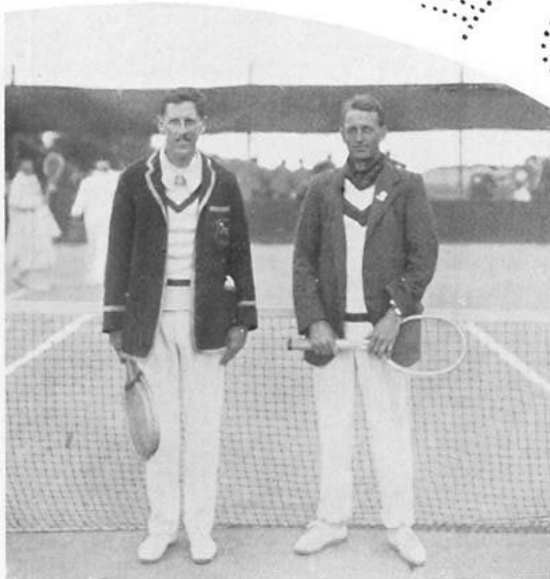

H. A. KITSON
South Africa.
Lawn Tennis (out-of-door courts).
Gentlemen's Doubles.

C. L. WINSLOW,
South Africa.
Lawn Tennis (out-of-door courts).
Gentlemen's Singles.
Gentlemen's Doubles.



Melle BROQUEDIS,
France.
Lawn Tennis (out-of-door courts).
Ladies' Singles.



Fril. KÖRING and H. SCHOMBURGK,
Germany.
Lawn Tennis (out-of-door courts).
Mixed Doubles.

WINNERS IN THE FIFTH OLYMPIAD.



Lieut. G. LILLIEHÖÖK,
Sweden.
Modern Pentathlon.



W. D. KINNEAR,
Great Britain.
Single Sculls.



Leander Club, Great Britain.
Rowing. Eights, outriggers.

WINNERS IN THE FIFTH OLYMPIAD.



Ludwigshafen R. C., Germany.
Rowing. Fours, outriggers.



Nykjoberg R. C., Denmark.
Rowing. Fours, inriggers.

WINNERS IN THE FIFTH OLYMPIAD.

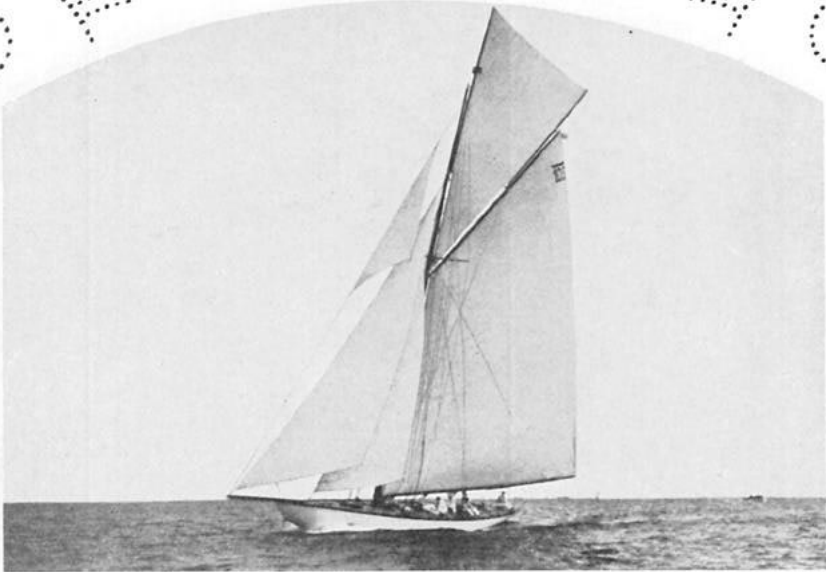

Magda IX, Norway.
Yacht Racing; 12 m. class.



Kitty, Sweden.
Yacht Racing ; 10 m. class.

WINNERS IN THE FIFTH OLYMPIAD.

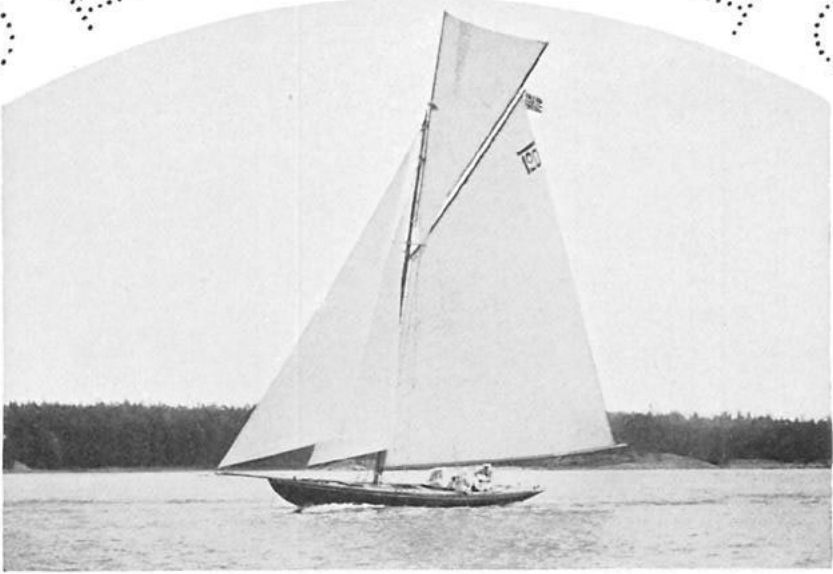

Taifun, Norway.
Yacht Racing; 8 m. class



Mac Miche, France.
Yacht Racing; 6 m. class.

WINNERS IN THE FIFTH OLYMPIAD.



D. P. KAHANAMOKU,
U. S. A.
100 m. free style.



H. HEBNER,
U. S. A.
100 m. back stroke.

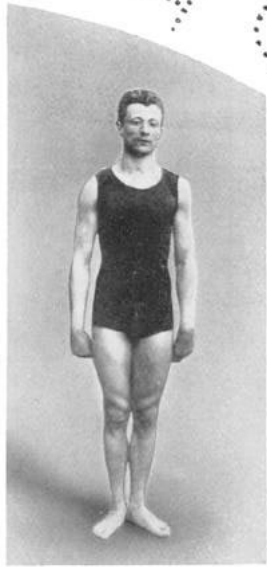

W. BATHE,
Germany.
200 and 400 m. breast stroke.



G. HODGSON
Canada.
400 and 1,500 m. free style.



E. ADLERZ
Sweden.
High (Plain) Diving.
Plain and Variety Diving.



P. GÜTHER,
Germany.
Spring-board Diving.

WINNERS IN THE FIFTH OLYMPIAD.

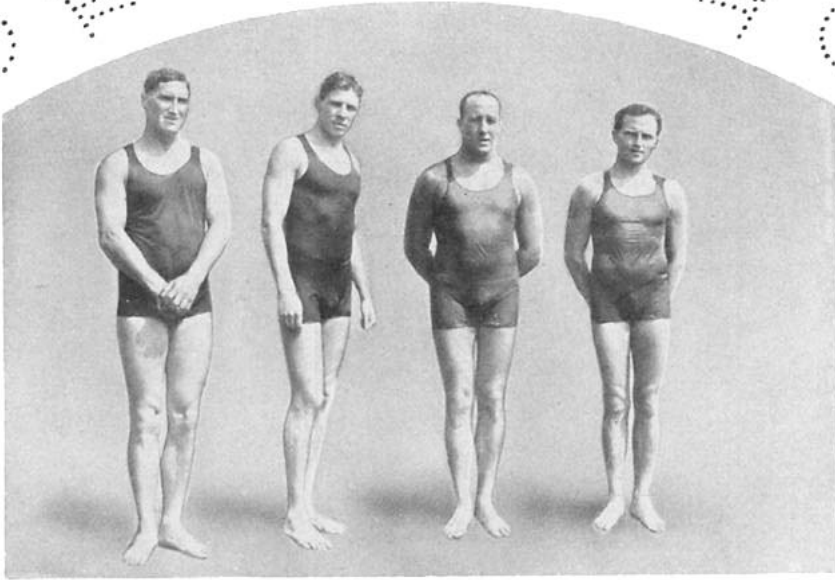

Australia's team in 800 m. Team Race.



Great Britain's Water Polo Team.

WINNERS IN THE FIFTH OLYMPIAD.



FANNY DURACK,
Australia.
100 m. free style for ladies.



GRETA JOHANSSON,
Sweden.
High (Plain) Diving for ladies.



Great Britain's team in 400 m Team Race for ladies.

WINNERS IN THE FIFTH OLYMPIAD.



P. R. COLAS,
France.

Shooting : Individual Comp. *b.*, and
Individual Comp. *e.*

A. PROKOPP,
Hungary.

Shooting: Individual Comp. *c.*



U. S. A.'s team in Shooting: Team Comp. *a.*

WINNERS IN THE FIFTH OLYMPIAD.



Sweden's team in Shooting: Team Comp. *d.*



Great Britain's team in Shooting: Team Comp. *f.*

WINNERS IN THE FIFTH OLYMPIAD.



F. S. HIRD,
U. S. A.
Shooting: Ind comp *g*.



W. CARLBERG,
Sweden.
Shooting: Ind. Comp. *i*.



A. P. LANE,
U. S. A.
Shooting: Ind. Comp. *k*. and
Ind. Comp. *m*.

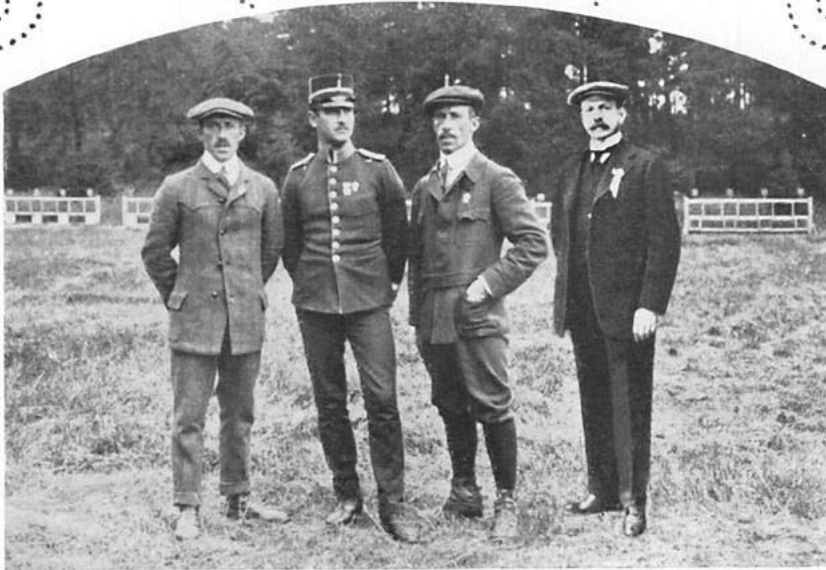

Sweden's team in Shooting: Team Comp. *h*.

WINNERS IN THE FIFTH OLYMPIAD.

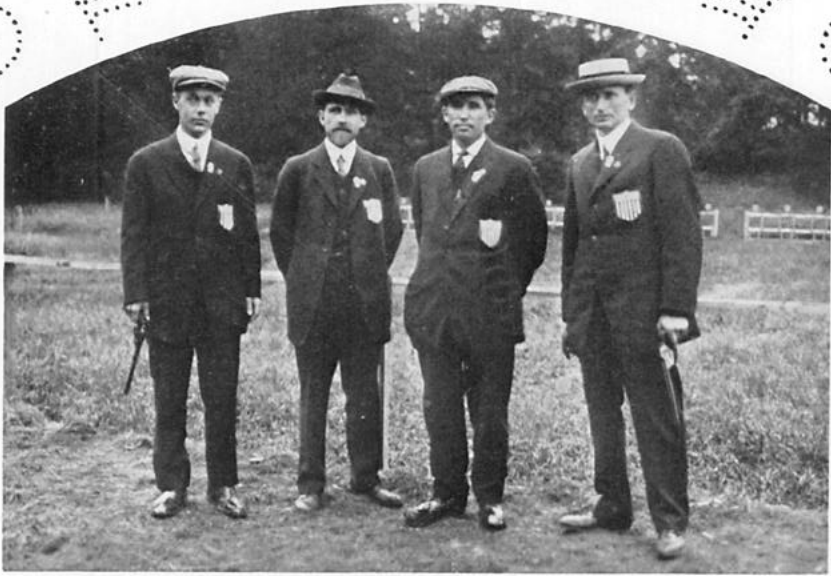

U. S. A.'s team in Shooting, Team Comp. *j.*



Sweden's team in Shooting: Team Comp. *l.*

WINNERS IN THE FIFTH OLYMPIAD.



A. SWAHN,
Sweden.
Shooting; Ind. Comp. *q.*

J. R. GRAHAM,
U. S. A.
Shooting; Ind. Comp. *o.*

Å. LUNDEBERG,
Sweden.
Shooting; Ind. Comp. *r.*



U. S. A.'s team in Clay Bird Shooting; Team Comp. *n.*

WINNERS IN THE FIFTH OLYMPIAD.

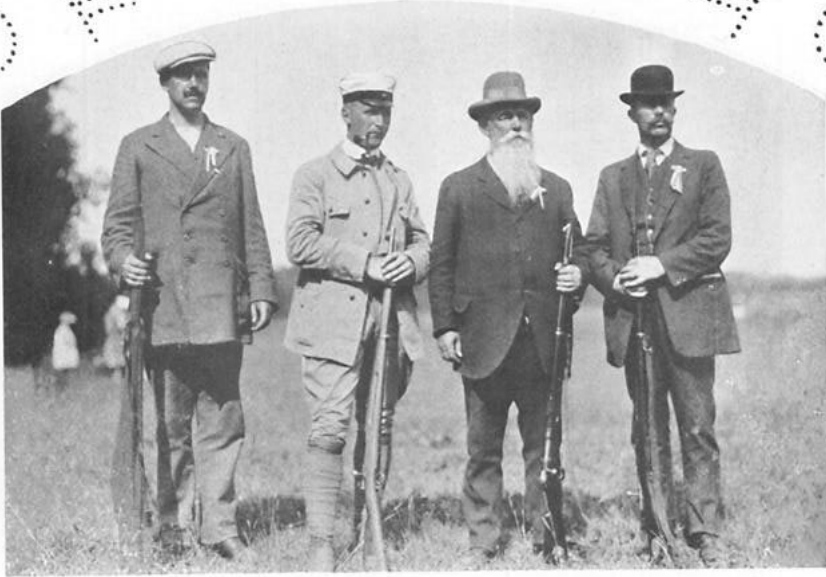

Sweden's team in Shooting: Running Deer Team Comp. *p.*

THE ORGANIZATION AND PRE- LIMINARY ARRANGEMENTS

1. *Fifth Olympiad.*

LIST OF COMMITTEES.

The International Olympic Committee.

PRESIDENT:

BARON PIERRE DE COUBERTIN.

MEMBERS:

Australasia	R. COOMBES.
Austria	PRINCE OTTO VON WINDISCH-GRÄTZ. COUNT RUD. VON COLLOREDO-MANNSFELD.
Bohemia	DR. JIRI GUTH.
Belgium	COUNT HENRY DE BAILLET-LATOURE.
Bulgaria	E.-N. TZOKOW.
Canada	BRIG. GENERAL, SIR HANBURY WILLIAMS.
Chili	O. N. GARCIA.
Denmark	CAPTAIN TORBEN GRUT.
Egypt	ANGELO C. BOLANACHI.
France	A. BALLIF. COUNT ALB. DE BERTIER DE SAUVIGNY. E. CALLOT.
Germany	COUNT A. F. SIERSTORPFF. COUNT C. VON WARTENSLEBEN. BARON VON VENNINGEN.
Great Britain	LORD DESBOROUGH OF TAPLOW. REV. R. S. DE COURCY LAFFAN. TH. A. COOK.
Greece	COUNT ALEX. MERCATI.
Holland	BARON F. W. DE TUYLL DE SEROOSKERKEN.
Hungary	COUNT GEZA ANDRASSY. JULES DE MUZSA.
Italy	COUNT EUGÈNE BRUNETTA D'USSEUX. ATTILIO BRUNIALTI.
Japan	DR. JIGORO KANO.
Luxemburg	MAURICE PESCATORE.
Mexico	MIGUEL DE BEISTEGUI.
Monaco	COUNT ALBERT GAUTIER-VIGNAL.
Norway	CAPTAIN JOHAN SVERRE.
Peru	CARLOS F. DE CANDAMO.
Portugal	DR. D. A. DE LANCASTRE.
Roumania	GEORGES A. PLAGINO.
Russia	COUNT DE RIBEAUPIERRE. PRINCE LÉON OROUSSOFF. BARON R. F. VON WILLEBRAND.
Finland	MARQUIS DE VILLAMEJOR.
Spain	COLONEL V. G. BALCK.
Sweden	COUNT CLARENCE VON ROSEN.
Switzerland	BARON GODEFROY DE BLONAY.
Turkey	SELIM SIRRI BEY.
United States of America	PROFESSOR W. M. SLOANE. ALLISON V. ARMOUR. EVERT J. WENDELL.

The Swedish Olympic Committee for the Olympic Games of Stockholm, 1912

<i>Hon. President:</i>	H. R. H. THE CROWN PRINCE OF SWEDEN.
<i>President:</i>	COLONEL V. G. BALCK.
<i>Vice- President:</i>	J. S. EDSTRÖM, ESQ.
<i>Members:</i>	CAPTAIN E. FRESTADIUS; DR. ASTLEY LEVIN; F. AF SANDEBERG, ESQ.; NORE THISELL, ESQ.
<i>Deputy Members:</i>	COUNT CLARENCE VON ROSEN, MASTER OF THE HORSE; LIEUT. G. G:SON UGGLA.
<i>Adjoined Members:</i>	CHARLES DICKSON, ESQ., BANK DIRECTOR; COLONEL, BARON S. D. A. HERMELIN; CAPT. O. HOLTERMANN, GENTLEMAN OF THE BEDCHAMBER; S. A. LINNÉR, ESQ., UNDER-SECRETARY OF STATE; FREDRIK LÖWENADLER, ESQ., GENTLEMAN-IN-WAITING; WALTER MURRAY, ESQ., UNDER-SECRETARY OF STATE; HARALD SOHLMAN, ESQ.
<i>Secretary:</i>	KRISTIAN HELLSTRÖM, ESQ.

Sections of the Swedish Olympic Committee.

<i>Executive Committee:</i>	COLONEL V. G. BALCK. J. S. EDSTRÖM, ESQ. KRISTIAN HELLSTRÖM, ESQ. NORE THISELL, ESQ., Deputy Member. LIEUT. G. G:SON UGGLA, Deputy Member.
<i>Finance Section:</i>	CHARLES DICKSON, ESQ., BANK DIRECTOR. DR. ASTLEY LEVIN. S. N. LINNÉR, ESQ. WALTER MURRAY, ESQ. F. AF SANDEBERG, ESQ. BARON FREDRIK RAMEL, Adjoined Member, pro-tem. Secretary: E. E. LOMM, ESQ.
<i>Medal and Badge Com- mittee:</i>	DR. ASTLEY LEVIN.
<i>Technical Section:</i>	J. S. EDSTRÖM, ESQ. LIEUT. G. G:SON UGGLA.
<i>Programme Section:</i>	NORE THISELL, ESQ. LIEUT. G. G:SON UGGLA.

The Chief Members of the Special Committees.

Athletics:	COLONEL, V. G. BALCK, President. L. ENGLUND, ESQ., Secretary. KRISTIAN HELLSTRÖM, ESQ., 2:nd Secretary.
Tug-of-War:	CAPTAIN C. G. DRAKE, President. KRISTIAN HELLSTRÖM, ESQ., Secretary.
Cycling:	CAPTAIN C. G.
Fencing:	CAPTAIN EMIL FICK, President. LIEUT. B. CNATTINGIUS, Secretary.
Football:	C. L. KORNERUP, ESQ., President. ANTON JOHANSSON, Secretary.
Game Shooting: ...	COUNT CLAES LEWENHAUPT, LORD OF THE BEDCHAMBER., President.
Gymnastics:	CAPTAIN EINAR NERMAN, President. LIEUT. WILHELM CARLBERG, Secretary.
Horse Riding Com- petitions:	H. R. H. PRINCE CARL, Hon Pres. COLONEL, COUNT E. C. G. OXENSTIERNA, President. COUNT CLARENCE VON ROSEN, MASTER OF THE HORSE, General-Secretary. LIEUT. C. TRÄGÅRDH, SECRETARY.
Lawn Tennis:	H. R. H. PRINCE WILHELM, Hon. Pres. CAPT. A. WALLENBERG, President. KURT ZETTERBERG, ESQ., Secretary.
Modern Pentathlon:	COLONEL V. G. BALCK, President. KRISTIAN HELLSTRÖM, ESQ., Secretary.
Mountain Climbing:	DR. ERIK ULLÉN, President.
Rowing:	FREDRIK LÖWENADLER, ESQ., GENTLEMAN-IN-WAITING, Hon. President. NILS LJUNGGREN, ESQ., President. ULRICH SALCHOW, ESQ., Secretary.
Shooting:	COLONEL, COUNT C. E. TAUBE, President. GUSTAF C. BOIVIE, ESQ., Secretary. FR. BJÖRKENSTAM, ESQ. MASTER OF THE HOUNDS. Pre- sident of Clay Bird Shooting Com. ERNEST MELLIN, ESQ., Secretary in Clay Bird Shooting Com.

- Swimming: ERIK BERGVALL, ESQ., President.
KRISTIAN HELLSTRÖM, ESQ., Secretary.
- Wrestling: CARL HELGESSON, ESQ., President.
STELLAN WARELIUS, ESQ., Secretary.
- Yacht Racing: CAPTAIN OSCAR HOLTERMANN, GENTLEMAN OF THE BED-
CHAMBER, President.
KNUT BOVIN, ESQ., BANK DIRECTOR, Secretary.
HUGO ANDERSSON, ESQ., C. E., Assist. Secretary.
- Accommodation
Committee: CAPTAIN OTTO BERGSTRÖM, President.
C. FRIES, ESQ., Secretary.
- Advertisement Com-
mittee: C. L. KORNERUP, ESQ., President.
KRISTIAN HELLSTRÖM, ESQ., Secretary.
- Building Committee: COLON EL V. G. BALCK, President.
ALEX. LINDMAN ESQ., Secretary.
- Entertainments
Committee: A. LILJA, ESQ., COURT INTENDANT, President.
D. BLOMBERG, ESQ., Secretary.
- Press Committee: ... COLONEL, BARON S. D. A. HERMELIN, President.
ERIK PALLIN, ESQ., Secretary.
- Reception Com-
mittee: CAPTAIN E. FRESTADIUS, President.
NILS LUNDGREN, ESQ., Secretary.



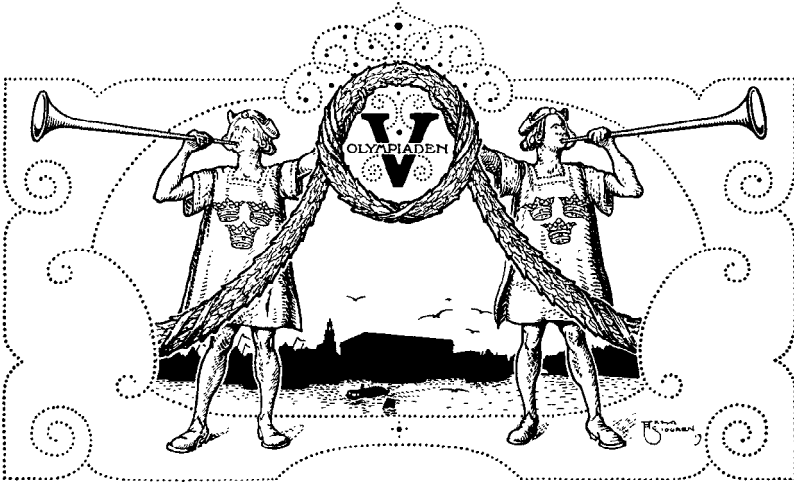

THE FIFTH OLYMPIAD

THE CHIEF GENERAL FEATURES OF THE OLYMPIC GAMES OF STOCKHOLM, 1912.

The choice of Stockholm for the Games.

The determination to celebrate the Fifth Olympiad in the capital of Sweden in 1912 — a resolve so full of importance for the athletic movement in this country — was come to on the 28 May, 1909, at the Meeting of the International Olympic Committee held in Berlin. But, even at the Games of London, in 1908, the International athletic world began to be familiarized with the thought, that the task of arranging the next Olympic Games would be entrusted to Sweden, although, it is true, the German capital had been thought of in the same connection and, in consequence, as soon as the Games of London were over, the Swedish athletes began to take measures to prepare themselves for the undertaking. First of all, an investigation was made as to whether there was any possibility of Sweden being able to carry out the Games in a way worthy of the country, and the two representatives of Sweden in the International Olympic Committee, Colonel V. G. Balck and Count Clarence von Rosen, addressed themselves to the two leading athletic organizations in Sweden —

the Swedish National Gymnastic and Sporting Association, and the Central Association for the Promotion of Athletics, begging them to investigate the matter in question.

The Chief Committee of the National Association, after hearing the opinions of the individual Unions and the Administration Committee, determined, at a meeting held on the 18 April, 1909, to support the proposal of choosing Stockholm as the scene of the Olympic Games of 1912, but on the supposition that the financial side of the question could be satisfactorily arranged. The Association based its recommendation on the ground, that the fact of having the Games at Stockholm would not only promote the healthy development of the athletic movement in Sweden, but would also be of the greatest importance for the country as a whole. But it also pointed out that, although the experience gained on the occasions when other important athletic meetings had been held in this country showed that the Swedes could be considered quite competent to organize and carry out the various competitions in the Games, the financial side of the question was one that had to be dealt with very cautiously.

The Central Association also made an investigation respecting the question of finances. It was assumed that a very simple Stadium, seating a somewhat limited number of spectators, should be erected in the Östermalm Athletic Grounds, and other extensive curtailments were made, for the sake of economy. For example, it was proposed to erect only one grand stand of reinforced concrete as a permanency in this Stadium, while the other stands were to be of timber, so that they could be removed after the close of the Games. It was also calculated that the Games would last only 8 days, instead of 12 as in London in 1908. The receipts, it was estimated, would amount to 80,000 Kronor (£ 4,400: \$ 22,000). The cost of the Stadium itself with its fittings and apparatus would, it was calculated, amount to 235,000 Kronor (£ 13,050: \$ 65,250); the expenses of the Secretariat to 37,000 Kronor (£ 2,050: \$ 10,250); the cost of advertising the Games in five different languages, 20,000 Kronor (£ 1,100: \$ 5,500); while diverse charges and unforeseen expenses were estimated to amount to 23,000 Kronor (£ 1,280: \$ 6,400). The total cost was thus, put at 415,000 Kronor (£ 23,050: \$ 115,250).

In consequence of this report, the Central Association, on the 6 May, 1909, presented a humble petition to H. M. the King, begging that His Majesty's Government, by permitting another drawing in the

Athletic Lottery, and by some other measures, would make it possible for the Swedish athletes to undertake the task of arranging the Games in this country. This petition was granted by the Government.

At the Meeting of the International Olympic Committee held in Berlin in May, 1909, the Swedish representatives were thus able to declare that Sweden, after the financial question had been assured by the indirect guarantee given by its Government, was prepared to carry out the Games of 1912, although on a somewhat reduced scale. The Congress then resolved unanimously to entrust Sweden with the task.

Baron Pierre de Coubertin, President of the International Olympic Committee, spoke as follows at the meeting:

“With regard to the question of making Stockholm the scene of the next Olympic Games it may be stated, that Germany’s representative, too, has promised to vote for the motion, on the assumption that Berlin is to hold them in 1916. We can expect a unanimous vote in favour of Stockholm, but only on the express condition that Sweden will give an explicit declaration that we need not have any doubts in the matter, and that the Committee can fully rely on Sweden’s not only undertaking the work of organizing the Olympic Games of 1912, but of carrying them out too. This we must demand, remembering the regrettable episode in the case of Rome, which first undertook the task of arranging the Games of 1908 and then took back its promise.

The doubt, quite a natural one, that possibly exists in Stockholm, whether financial difficulties may not prove an obstacle in this matter, is one that exists in every country and arose in England too, but ought not deter Sweden from the undertaking; for the profit that is made by a country — and a little country, especially — that becomes the scene of the Olympic Games, will be certain and of various kinds, both material and ideal. If doubts caused by financial reasons were allowed to have too great an influence, nothing would ever be undertaken.

Of all countries in the world, Sweden, at the present moment, possesses the best conditions necessary for organizing the Olympic Games in a way that will perfectly satisfy all the claims that athletics and our expectations can demand. The Olympic Games of Stockholm are, even now, assured of perfect success.

It will be necessary to avoid attempting to copy the Olympic Games of London. The next Olympiads must not have such a character; they must not be so comprehensive. There was altogether too much in London. The Games must be kept more purely athletic; they must be more dignified, more discreet; more in accordance with classic and artistic requirements; more intimate, and, above all, less expensive.

act as a deterrent. With the natural resources already possessed by Stockholm; with the experience already gained by leading athletic circles in Sweden; with the Northern Games as a model, we are led to consider that a grant of 300,000 francs, over and above the receipts that may be counted on from the sale of tickets, ought to be sufficient security for an Olympic Committee.

Do all that you can in order to have Sweden chosen as the meeting place of the world's athletes, for the Olympic Games now stand at the parting of the ways and — *we need Sweden*. Besides this, the present moment is a most favourable one for Sweden if she wishes to celebrate the Olympic Games. To delay doing so to an uncertain future will confer no advantage, but *rather the opposite*."

The Organization of the work.

The task of organizing and carrying out the Olympic Games of 1912 was a responsible and laborious one, but thanks to the generosity of the Swedish nation in general, to the enthusiasm that everywhere prevailed, and the appreciation and complaisance on the part of the authorities, for all of which the various Committees wish to express their deep gratitude, it was found possible to carry out the work thus undertaken to a most satisfactory conclusion.

When the work was begun, there was no one that could rightly measure the proportions it eventually assumed. The number of entries for the competitions of the Fifth Olympiad was, in the end, far greater than for any of the preceding Games, and the result-lists show that no less than 3,282 persons, representing 27 different nations, took part in the various events. In addition to this, Sweden was visited during the course of the Games by, altogether, 487 foreign official representatives, functionaries and members of juries, and also by 260 journalists from various parts of the world, exclusive of Sweden.

The opinion prevailed in Swedish athletic circles that the Olympic Games of to-day ought to be given a greater classic simplicity than had marked the modern Olympiads last celebrated, and that there was much that had hitherto been more or less intimately associated with these newer celebrations, and which had detracted from their real character, that ought to be banished from them. In spite of this determination, however, there were no less than 103 various competitions on the programme, and the carrying-out of these necessitated a total of 3,516 different preparatory or final heats.

Those persons that, in Sweden's name, undertook the task of arranging the competitions, were confronted by two tasks; on the one hand there was the drawing up the plan of the great athletic festival and of bringing it to a successful issue, and, on the other, the preparations necessary for the participation of Swedish representatives in the Games. This double task could be solved in one way only, and that was, by adopting as a guiding principle from the very beginning that, first and foremost, the competitions must be arranged in

such a way that all the competitors would be treated with equal justice, and that the arrangements, from an athletic-technical point of view, would be the best possible, and then, in the second place, steps should be taken to have the training of the Swedish athletes carried on in such a way, that the result would be the greatest possible number of victories for the nation.

In the autumn of 1909, the Swedish athletic world proceeded to the election of the Swedish Olympic Committee for the Games of Stockholm, 1912. In accordance with an agreement made between the Swedish National Gymnastic and Sporting Association and the Central Association for the Promotion of Athletics in Sweden, the Committee in question consisted of three representatives and one reserve deputy for each of these organizations. The National Association elected J. S. Edström, Esq.; F. af Sandeberg, Esq., and N. Thisell, Esq.; Lieutenant G. G:son Uggla being chosen as the reserve deputy, while the Central Association was represented by Colonel V. G. Balck, B. F. Burman, Esq., and Captain E. Frestadius, with Doctor Astley Levin as the reserve deputy. On the lamented death of Mr Burman in May 1912, Doctor Levin was chosen to fill his place as one of the representatives of the Central Association, Count Clarence von Rosen being at the same time appointed reserve deputy.

The Committee begged H. R. H. the Crown Prince Gustaf Adolf of Sweden to act as the leader of the work for the Games, by accepting the post of Honorary President of the Swedish Olympic Committee.

Colonel V. G. Balck was elected President of the Swedish Olympic Committee, and J. S. Edström, Esq., Vice-President. Nore Thisell, Esq., acted as Secretary until the 1 May, 1910, when Kristian Hellström, Esq., entered on his duties as Secretary to the Committee.

According to the scheme of work, the Swedish Olympic Committee was to undertake the financial and general direction of the whole, while the technical details were to be confided to special committees, nominated by the leading Swedish athletic associations.

The first meeting of the Swedish Olympic Committee was held on the 7 October 1909, and, on the 11 October of the same year, it resolved to request the National Association to beg the various athletic unions to elect committees for pure athletics, (field and track events), gymnastics, wrestling, swimming and fencing, as these branches of athletics could, even then, be considered as being certain of a place

on the programme of the Fifth Olympiad. Then, by degrees, special committees were appointed for the other branches of sport that were to form part of the programme, the final list of these committees being as follows:

The Committee for Athletics		elected by the Swedish Athletic Association;
» » Tug-of-War	» » »	Swedish Athletic Association;
» » Cycling	» » »	Swedish Cycling Association;
» » Fencing	» » »	Swedish Fencing Association;
» » Football	» » »	Swedish Football Association;
» » Gymnastics	» » »	Swedish Gymnastic Association;
» » Game Shooting ..	» » »	Swedish Olympic Committee;
» » Horse Riding Competitions ...	» » »	H. R. H., Prince Carl, Duke of Vestergötland, Inspector of the Swedish Cavalry;
» » Lawn Tennis ...	» » »	Swedish Lawn Tennis Association;
» » Modern Pentathlon	» » »	Swedish Olympic Committee and those of the Olympic Special Committees concerned in the competitions;
» » Mountain Ascents	» » »	Swedish Olympic Committee;
» » Rowing	» » »	Swedish Rowing Association;

The Committee for Shooting elected by the Chief Committee
of the Shooting
Association ;

» » Swimming » » » Swedish Swimming
Association ;

» » Wrestling » » » Swedish Wrestling
Association ;

» » Yacht Racing ... » » » Royal Swedish
Yacht Club.

When their numbers were at length complete, these special committees reckoned, altogether, 187 members, whose names can be found in the reports made by each committee.

In proportion with the growth of the work of the Swedish Olympic Committee, its numbers were increased by means of adjoined members, until, finally, it reckoned 17 in all. A scheme of work for the Committee was drawn up and was as follows:

**THE SCHEME OF WORK FOR THE SWEDISH OLYMPIC
COMMITTEE.**

Adopted at the meeting held on the 17 May, 1910.

§ 1.

The Committee shall consist of six (6) unpaid members, three nominated by the Swedish Central Association for the Promotion of Athletics, and three by the Swedish National Gymnastic and Sporting Association.

A president shall be chosen from each group, one of whom shall act as the ordinary president of the committee, while the other shall take the chair on those occasions when the first is absent. An Honorary President shall also be elected.

§ 2.

The committee shall be subdivided into sections, each with a special field of work, viz.. the Programme section, the Technical Section, the Finance Section and the Advertising- and Reception Section.

The spheres of labour of the various sections are shown by the following scheme;

Programme Section: The programme; allotment of days and hours. Time and place for the various kinds of competitions. The length of time to be allotted to each competition. The general programme and the detailed programme of each branch of athletics; competing-places other than the Stadium and for certain branches of sport; the cost of these.

Technical Section. Athletic-Technical details. Rules and regulations for competitions; amateur definitions; disqualification regulations. Judges and other officials. Trainers. The branches of athletics (in the general sense of the word) which are to be placed on the programme. Athletic apparatus. Athletic-technical questions respecting the Stadium which have been re-

ferred to the Swedish Olympic Committee by the Building Committee. Athletic-technical questions respecting other premises and places where competitions are to be held. Details of arrangements for competitors' dressing rooms. Questions concerning the number of competitors in each branch of athletics that may be entered by each nation.

Finance Section. General and detailed schemes respecting the question of the finances (with the exception of those concerning the building of the Stadium) shall be drawn up by this Section, while the accounts are to be kept so as to show, from day to day, the expenditure determined by the Committee, so that there will be no difficulty at any time in obtaining a view of the financial position. This section shall deal with all questions standing in connection with the expenditure, such as that caused by payments to the various special committees, by travelling expenses, the purchase of necessary material, and other questions of a financial or legal nature.

Advertisement and Reception Committee. (To be divided later on into several different sub-sections). Accommodation; journeys; carriage. Food supply questions; medical attendance; massage. Posters; badges; tickets and the rules regulating the control of the same. Attendants and ticket sellers. The daily programme. The proclamation of the results of the competitions. Entertainments and excursions. Medals, diplomas and other prizes.

Questions concerning advertisements of all kinds, the Press, correspondence, etc., shall, on the other hand, be in the domain of the Secretariat.

General Instructions for the Sections.

As soon as a question (a written communication, or the like) which has to be discussed by the Committee as a whole, has been brought forward, it is forwarded at once by the secretary to the Section (or Sections, if several sections are affected by the matter) in whose province it lies. Should the President desire to do so, however, he may first make himself acquainted with the matter, if it can be done without any loss of time.

The Section shall then investigate the matter and give its decided opinion on the subject (preferably in writing), after which, the Olympic Committee, as a whole, shall decide the question at one of its meetings, when the President of the Section shall lay the matter before the Committee.

A Section has the right to add temporarily to its numbers other persons than those belonging to the Section, for the purpose of properly discussing certain questions, or certain groups of questions. Such persons, however, have merely the right to express their opinion on the matter.

If a question is of such a general nature that it is considered as not properly coming within the province of any special section or sections, then it shall first be investigated by the President and the Secretary, after which, the former shall lay the matter before the Olympic Committee at a meeting.

A Section can only bring forward such questions as lie within its province, and must place its well-grounded proposals before the Olympic Committee as a whole.

A Section must not come to any decision that will be binding on the Olympic Committee, nor issue written communications, nor enter into verbal or written agreements in the name of the Olympic Committee, unless the latter has expressly commissioned the Section to do so.

The same rule shall hold good for the Secretary and for each individual member of the Committee.

§ 3.

In order to make the arrangements for the various competitions of the Olympic Games, the Swedish Olympic Committee shall work by means of Special Committees, nominated by the sectional committees of the National Association, or by the proper Shooting-, Yachting-, and Horse Riding Associations, etc.

The Special Committees in question shall be named, for example, "The Olympic Sub-Committee for Athletics", "The Olympic Sub-Committee for Swimming", etc., and each shall deal with everything lying within its province that is not of general interest or of a financial nature. Such matters as those last mentioned shall be decided by the Swedish Olympic Committee, which is empowered to call to its meetings all the members of such a Special Committee should the matter be one respecting one certain branch of athletics, or the Presidents of some or all of the Sub-Committees, when the question concerns several or all branches of athletics.

Decisions arrived at by the Special Committees must be submitted to the Olympic Committee for its approval and sanction.

§ 4.

The Swedish Olympic Committee shall appoint a salaried Secretary, who shall devote all his time and energy to the work of the Olympic Committee, and he shall:

- a) keep the minutes of the meetings of the Swedish Olympic Committee;
- b) prepare the agenda of the meetings before the latter are held;
- c) draft and countersign the written communications to be despatched;
- d) manage the work at the Secretariat in accordance with the instructions given by the Olympic Committee, and shall carry out the decisions of the said Committee;
- e) act as Secretary at the meetings of the Sections mentioned in §2, and shall be present at the meetings of the Special (Sub) Committees mentioned in §3 and, if so desired, shall act as Secretary at the last-mentioned meetings, too;
- f) execute the commissions entrusted to him by the Olympic Committee.

The Secretary shall not have the right to vote at the meetings of the Committee, but he may express his opinion on such occasions, when necessary.

§ 5.

The following resolutions were come to, respecting the work of the Swedish Olympic Committee:

All decisions shall be settled by means of voting. When the number of votes on each side are equal, the question shall be decided at a fresh meeting of the Committee under the chairmanship of the Honorary President, who shall then have the casting vote.

All decisions shall be entered in the minutes.

An account shall be kept of all the receipts and expenditure of the Olympic Committee.

Two auditors shall be appointed to examine the books of the Olympic Committee; one of these shall be nominated by the Central Association and the other by the National Association. These auditors shall give annual reports of their examination of the books to the Associations above mentioned.

§6.

Alterations in, and additions to, this scheme of work can be determined on by the Olympic Committee, only if all the members of the said Committee are present when such alteration or addition is resolved on.

Addenda to the scheme of work.

At a meeting of the Swedish Olympic Committee on the 9 January, 1911, it was determined to recast § 2 of the scheme of work as far as regards what was there said concerning the Advertisement- and Reception Section. This was now to read as follows:

Advertisement- and Reception Section. This section shall be divided into the following sub-committees, each of which shall work independently of the others;

The Accommodation Committee. Quartering of competitors, etc.; carriage of luggage, apparatus etc.; travelling arrangements.

The Medal- and Badges Committee. Badges; medals; challenge-cups; diplomas and other prizes.

The Reception Committee. The question of food supplies for competitors; entertainments; excursions, etc.

Advertisement and Information Committee. Advertisements, information, etc.

Questions concerning the daily programme, the Press, correspondents in different places, etc., were to lie in the province of the Secretariat.

As, during the year immediately preceding the Games, there was a steady increase in the amount of work to be performed, the Swedish Olympic Committee, on the 11 December, 1911, appointed a special Executive Committee, for the purpose of preparing and making preliminary investigations concerning questions to be discussed at the meetings of the Olympic Committee, and it was also empowered to decide matters of an important and pressing nature. The burden laid on this special Committee was a very heavy one as, during the months immediately preceding the Games, the work increased to an enormous degree, while every item of business required to be thoroughly investigated.

Colonel V. Balck and J. S. Edström, Esq., were nominated by the Swedish Olympic Committee to act as a special executive during the course of the Games.

The various sections and sub-committees of the Swedish Olympic Committee were as follows:

Executive Committee:

Colonel V. G. BALCK,
J. S. EDSTRÖM, Esq.,
K. HELLSTRÖM, Esq., *Secretary*,
NORE THISSELL, Esq., *Deputy member*,
Lieutenant G. G:SON UGGLA, *Deputy member*.

Finance Section:

CHARLES DICKSON, Esq.,
Dr. ASTLEY LEVIN,
S. N. LINNÉR, Esq.,
WALTER MURRAY, Esq.,
F. AF SANDEBERG, Esq.,
Baron FREDRIK RAMEL, *Adjoined member, pro tem*.
E. E. LOMM, Esq., *Secretary*.

Programme Section:

NORE THISSELL, Esq.,
Lieutenant G. G:SON UGGLA.

Medal- and Badge Committee:

Dr ASTLEY LEVIN.

Technical Section:

J. S. EDSTRÖM, Esq.,
Lieutenant G. G:SON UGGLA.

The Swedish Olympic Committee also appointed a number of special committees, in addition to those that had been created for the various branches of athletics, for the purpose of dealing with matters which were of some scope but were not directly connected with the athletic competitions. These were:

The Entertainments Committee,
The Accomodation Committee,
The Reception Committee,
The Press Commiltee, and
The Advertisement Committee,

with a total of 47 members.

² *Fifth Olympiad.*

Finally, for the purpose of carrying out the building of the Stadium there was elected by the Central Association a special *Building Committee* of six members, three of whom belonged to the Swedish Olympic Committee.

The number of the persons sitting in the various committees of the Olympic Games of Stockholm, and the sections to which they belonged may be seen from the following table.

Resumé of the number of members of the various Committees for the Olympic Games of Stockholm, 1912.

	Nr. of members	Of which, belonging to the Swedish Olympic Committee	Of which, belonging to other Committees mentioned here	Total nr. of persons
The Swedish Olympic Committee	17	—	—	17
Executive Committee of d:o	5	5	—	—
Finance Section	7	5	—	2
Medal and Badge Committee	1	1	—	—
Programme Section	2	2	—	—
Technical Section	2	2	—	—
Building Committee	6	3	—	3
Entertainments Committee	9	2	—	7
Accommodation Committee	7	3	—	4
Reception Committee	7	2	1	4
Press Committee	18	2	1	15
Advertisement Committee	6	1	—	5
Committee for Athletics	18	5	—	13
» » Tug-of-War	12	1	1	10
» » Cycling	10	—	1	9
» » Fencing	6	—	—	6
» » Football	17	—	5	12
» » Game Shooting	5	—	—	5
» » Gymnastics	5	—	—	5
» » Horse Riding Competitions	12	1	—	11
» » Lawn Tennis	9	—	—	9
» » Modern Pentathlon	14	3	6	5
» » Mountain Ascents	1	—	—	1
» » Rowing	11	1	2	8
» » Shooting	16	—	3	13
» » Swimming	15	1	4	10
» » Wrestling	8	—	—	8
» » Yacht Racing	6	1	—	5
	252	41	24	187

The Swedish Olympic Committee and the Technical Special Committees for the various branches of athletics, held the following number of meetings during the course of their work on behalf of the Games :

The Swedish Olympic Committee	90
(H. R. H. the Crown Prince presided on 56 of these occasions.)	
The Committee for Athletics, and its Executive Committee	31
» » » Tug of War	13
» » » Cycling	36
» » » Fencing	10
» » » Football	21
» » » Gymnastics	60
» » » Horse Riding Competitions	41
(30 of these were under the presidency of H. R. H. Prince Carl).	
» » » Lawn Tennis	8
» » » Modern Pentathlon	10
» » » Rowing	27
» » » Shooting	21
» » » Swimming	22
» » » Wrestling	20
» » » Yacht Racing and sub-divisions	66

As necessity arose, agreements, embodying the following principles together with others of lesser importance, were, by degrees, made between the Swedish Olympic Committee and the Special Committees:

- that the Special Committees undertook to be responsible for:
- a) the preparatory work for the worthy carrying out of their respective branches of athletics at the Games of 1912, and for the "try outs" which might eventually be necessary;
 - b) the technical arrangements and the procuring of the necessary apparatus, etc., necessary for the athletic competitions;
 - c) the direction of their respective branches of athletics during the Games themselves;
- that the rules for the competitions, and the general regulations for the various branches of athletics, together with the names of

those persons proposed as judges and other officials, should be submitted to the Swedish Olympic Committee for approval; that the chief direction of the whole should lie in the hands of the Swedish Olympic Committee, which was to determine the days and the hours when the various competitions were to take place; confirm the programmes proposed; prepare a place at the Stadium, or elsewhere, as the scene of the Games, and — in the event of no other agreement having been come to — was to undertake the payment of the expenses incurred, in accordance with the estimates sent in and approved of: that — unless a different agreement had been come to — the Swedish Olympic Committee alone was to have the disposal of all the money obtained by the sale of tickets, etc.

The weightiest tasks of the Committees.

The tasks that had to be taken in hand first of all were: the drawing up of the general programme; the settlement of the financial question; the putting in order of the places where the various competitions were to be held; the drawing up of the rules for the competitions, and the preparation and training of the Swedish athletes.

As was just mentioned, the predominant feeling in Swedish athletic circles was, that the programme of the Olympic Games ought to be made as simple as possible, and that it should chiefly embrace such branches of athletics as are common to the civilized nations of the present day and which, from their character, can be practised by everybody, without reference to either social or financial position.

In accordance with this principle, the Swedish delegates at the Meeting of the International Olympic Committee, held in Berlin in May, 1909, brought forward a scheme for a standard programme for future Olympic Games, in which the events were restricted to pure athletics, wrestling, gymnastics and swimming. This proposal was not approved of by the Meeting, the representatives of several other nations demanding a far more comprehensive programme. On the basis of these last-mentioned wishes, the Swedish Olympic Committee drew up a fresh draft of a programme for the Fifth Olympiad, which was laid before the International Olympic Committee at its Meeting at Luxemburg, in June, 1910. This second scheme was not found satisfactory, either, and so the Swedish representatives came forward

with a third proposal at the Meeting of Buda-Pesth, in 1911, which gained the approval of the International Olympic Committee. At these meetings, Sweden was represented by J. S. Edström, Esq., and K. Hellström, Esq., Vice-President and Secretary, respectively, of the Swedish Olympic Committee.

But, the lengthier the programme became, the heavier grew the labours of the Swedish Olympic Committee, and the solution of the economic question became a problem of ever increasing difficulty, in consequence of the new demands constantly made on the arrangers of the Fifth Olympiad. Scarcely had estimates been drawn up, based on the plans entertained for the moment by the Swedish Olympic Committee, than the scope of the Games was so altered that the Finance Committee had to begin its labours over again. The demand for additional sites and premises for the Competitions increased, too, as the programme lengthened. Not only had a Stadium to be built for the competitions in athletics, but other, and special, localities had to be prepared for the swimming, lawn tennis, football, rowing, wrestling and other events, while extensive alterations and improvements had to be carried out at the places intended for the competitions in fencing, sailing and shooting, etc. And as the Swedish Olympic Committee had also been entrusted with the task of making the necessary preparations for the participation of Swedish athletes in the Games, fresh difficulties arose here, too, in consequence of the uncertainty that prevailed with regard to the programme. In this connection, the Committee had to obtain leave of absence for such athletes and officials as belonged to the army, and special arrangements had also to be made, in order to give Swedes living abroad an opportunity of taking part in the Games as representatives of their native country.

The task of drawing up the rules and regulations for the competitions became a most exhaustive one which, as the programme gradually took shape, was completed by the General Secretariat working in collaboration with the various Special Committees, after the rules, etc., had been submitted for the approval of the Technical Section. The general regulations finally decided on, as well as the rules of the competitions, will be found in their own chapter at the end of this book. Special care was paid to the amateur question, and an endeavour was made to create, as far as possible, one uniform rule for all the various branches of athletics.

Table showing the number of copies printed of the general, Programme and of the Rules and Regulations for the Olympic Games of Stockholm

	Swedish	English	French	German	Total
General Programme	45,200	68,100	31,500	48,200	193,000
Athletics	7,400	6,000	7,600	3,000	24,000
Tug of War	3,000	3,000	1,500	1,100	8,600
Cycling	2,800	1,700	1,100	2,800	8,400
Fencing	1,000	1,000	2,100	1,000	5,100
Football	2,000	1,500	1,100	2,000	6,600
Gymnastics	5,500	2,000	2,200	2,000	11,700
Horse Riding	2,500	1,500	1,500	1,500	7,000
Lawn Tennis	2,500	1,000	1,000	1,000	5,500
Modern Pentathlon	3,200	1,500	1,600	2,600	8,900
Rowing	2,400	1,500	1,000	2,000	6,900
Shooting	3,900	3,000	1,000	2,000	9,900
Swimming	3,000	3,500	1,100	1,900	9,500
Wrestling	2,200	2,000	1,100	2,100	7,400
Yacht Racing	1,000	800	—	600	2,400
	87,600	98,100	55,400	73,800	314,900

During the first twelve months, the General Secretariat had its offices at 5 B, Norra Blasieholmshamnen, but in the spring of 1911 these premises proved insufficient, and on the 1 April of that year a flat of 11 rooms was taken at 1 A, Hamngatan on behalf of the Committee. In addition to the secretary, K. Hellström, Esq., and his principal assistant, John Widenfelt, Esq., the Secretariat had a staff during its busiest season of 32 persons, this exclusive of almost the same number of clerical and other assistants at the offices of the Accommodation-, and Reception-bureaus, and at that for the sale of tickets.

Some idea of the great amount of work performed by the General Secretariat may be seen from the accompanying table of the postal matter despatched from the office; the grand total of letters, etc., amounting, in round numbers, to 90,000.

Table of the Postal Matter despatched from the Secretariat of the Swedish Olympic Committee.

Month.	1910		1911		1912		1913	
	Letters	Printed Matter	Letters	Printed Matter	Letters	Printed Matter	Letters	Printed Matter
January	—	—	530	21	1,768	5,137	424	17
February	—	—	443	12	2,104	4,638	552	27
March	—	—	486	120	2,182	4,605	465	30
April	—	—	576	7	2,579	6,633	410	42
May	114	—	798	111	3,054	6,581	481	944
June	83	—	657	9	2,646	3,237	605	4,179
July	103	—	932	517	933	2,394	445	2,464
August	170	—	782	103	707	1,044		
September	150	19	1,163	5,169	773	336		
October	182	2	986	1,488	848	540		
November	448	—	1,160	457	713	326		
December	335	9	1,097	2,830	487	247		
Total	1,585	30	9,610	10,844	18,794	35,718	3,382	7,703

Official Invitation to the Games of Stockholm 1912.

The official invitation to participation in the Olympic Games of Stockholm, 1912, was issued on the 18 November, 1910, to the Olympic Committees of the following countries: Belgium, Bohemia, Denmark, Egypt, Germany, Great Britain, Greece, Hungary, Norway, Russia and the U. S. A., and to the representatives of the International Olympic Committee in Australia, Bulgaria, Finland, France, Holland, Italy, Japan, Mexico, Monaco, Peru, Portugal, Roumania, Spain, Switzerland and Turkey. Other countries which had no representatives on the International Olympic Committee could not, in consequence, receive any official invitation at this date. These countries were: The Argentine, Bolivia, Brazil, Chili and other South American nations; Austria, Canada, China, Cuba, India, Luxemburg, New Zealand, Persia, Poland, Servia and Siam.

As this latter circumstance, it was feared, might lead to complications in the international athletic world, especially as regards the difficulty of determining which nations were to be considered as entitled to independent representation at the Games, the attention of

the International Olympic Committee was drawn to the matter, and the desirability was at the same time pointed out, of a number, at least, of these countries being given the opportunity of nominating representatives to the International Committee. The Swedish Olympic Committee obtained from the countries in question lists of the leading athletic organizations there, and, on receipt of the informa-

<u>ATHLETICS</u>
FIFTH OLYMPIAD
OLYMPIC GAMES
OF
STOCKHOLM 1912.
ENTRY FORM
<p>This form — carefully filled up — is to be forwarded by the Olympic Committees of the respective countries to the Swedish Olympic Committee under the address <i>OLYMPISKA SPELEN STOCKHOLM</i></p>
<p><i>EXTRACT FROM THE GENERAL REGULATIONS FOR THE OLYMPIC GAMES</i></p>
<p>3 The various competitions of the Olympic Games are confined exclusively to amateurs</p>
<p>6 A "nation", in the Olympic sense, is any country having separate representation on the International Olympic Committee, or, where no such representation exists, any country recognized as a "nation" at the last Olympic Games and, further, any sovereign state not forming part of a states-union, as well as any states-union under one and the same sovereign jurisdiction</p>
<p>Natural-born or naturalised subjects of a "nation", or of a sovereign state of which a "nation" forms part, are alone eligible to represent that "nation" as competitors in the Olympic Games</p>
<p>7 The amateur status of every competitor, as defined in the regulations for the different sports, must be guaranteed by the organisation that, in his own country, governs the sport in which he desires to enter as a competitor, or where no such governing organisation exists, by the Olympic Committee of that country</p>
<p>8. The minimum age for competitors in the Games is 17 years, subject to exceptions in special cases where the entry is accompanied by a doctor's certificate testifying to his fitness</p>
<p>10 Entries should be made <u>through the Olympic Committee of each country by the governing organisation for each branch of sport</u> (or, where no such governing organisation exists, direct by the Olympic Committee) <u>to the Swedish Olympic Committee</u></p>
<p>11 No entry can be considered unless in the hands of the Swedish Olympic Committee, at the latest, by the dates specified in the Programme for entries for the various competitions</p>
<p>For non-European countries, however, entries close 8 days after the specified date Entries made by telegram will not be accepted.</p>
<p>12. The Swedish Olympic Committee reserves to itself the right to refuse entries without being bound to give reasons for its decision</p>
<p>In such an event, however, the reason will be communicated confidentially to the Olympic Committee concerned</p>
• • •

P. T. C.

tion in question, sent them the official invitation to take part in the Games of Stockholm.

Entry-forms (see pp. 24,25), to be filled in with the names of the competitors and other necessary information, were posted in the spring of 1912 to all the Olympic Committees and leading athletic organizations of the various nations.

ENTRY FORM

FOR

ATHLETICS

(IN THE STADIUM, SATURDAY, JULY 6th - MONDAY, JULY 15th, 1912.)

ENTRIES CLOSE JUNE 6th, 1912.

The Entry therefore, must be in the hands of the Swedish Olympic Committee not later than 12 o'clock midnight between the 6 and 7 of June, 1912.

Entries made later will not be accepted. (For exception, see Section 11 on the opposite side.)

Entry shall be made in typed or other distinct Latin characters.

A separate form for each event must be filled in by each competitor.

In case of team competitors, one **SPECIAL ENTRY FORM** must be filled in for each member of the team, including the reserves, and **ONE SPECIAL ENTRY FORM** signed by the governing athletic organization of the country—for the entire team (competitors and reserves)

<p>1 COMPETITION</p> <p>2 NATION which the competitor represents</p> <p>3 NAME of Competitor in full <i>(Write distinctly!)</i></p> <p>4 DATE of BIRTH</p> <p>5 PLACE of BIRTH</p> <p>6 Date of NATURALISATION <small>(To be filled in if the competitor be not a natural-born subject or citizen of the "nation" he represents, but be qualified as a fully naturalised subject or citizen—see Section 6 of the General Regulations for the Olympic Games—)</small></p>	<p>.....</p> <p>.....</p> <p>.....</p> <p>.....</p> <p>.....</p> <p>.....</p>
--	---

<p style="text-align: center;">Declaration to be signed by the competitor</p> <p>I hereby declare that the above statements are correct and that I am an amateur in accordance with the following definition</p> <p>An amateur is one who has never:</p> <ul style="list-style-type: none"> a) competed for a money prize or for monetary consideration, or in any way drawn pecuniary gain from the exercise of his sport b) competed against a professional; c) taught in any branch of athletics for payment d) sold, pawned, hired out, or exhibited for payment any prize won in a competition. <p>In addition, I engage to accept and observe the Rules, Regulations and Conditions for the Olympic Games of Stockholm 1912</p> <p>I also engage, in the event of my winning a Challenge Cup, to give the guarantee stipulated in Section 16 of the General Regulations for the Olympic Games</p> <p><i>Signature of Competitor:</i></p> <p>.....</p>	<p style="text-align: center;">Declaration to be signed by the Governing Athletic Organisation of the country</p> <p>This declaration must be signed by the Governing Athletic Association which enters the competitor, or—where no such governing organization exists—by the Olympic Committee of the country in question</p> <p>We hereby declare that the above statements are correct to the best of our knowledge and belief, and we herewith nominate the competitor for the event-mentioned above.</p> <p><i>Signature:</i></p> <p>.....</p>
--	--

Tables showing the total number of printed entry-forms issued.

	Swedish	English	French	German	Total
Athletics (individ.)	1,000	5,000	2,000	2,000	10,000
» (team).....	500	1,000	500	500	2,500
Cycling	250	500	300	250	1,300
Fencing (individ.).....	300	500	750	400	1,950
» (team)	100	150	250	100	600
» (judges)	100	150	250	100	600
Football (individ.).....	500	1,000	500	500	2,500
» (team)	100	150	100	100	450
Gymnastics (individ.)	150	400	400	200	1,150
» (team, ind.)	500	1,500	1,500	1,500	5,000
» (team).....	100	150	150	100	500
» (display, ind.)	2,000	1,500	1,000	1,000	5,500
» (display, team)....	100	200	150	100	550
Horse Riding Competitions ...	400	400	400	400	1,600
Lawn Tennis (singles) (out of door c.)	250	500	500	250	1,500
» » » (covered courts)	300	300	300	300	1,200
» » (doubles) (out of door c.)	250	500	500	250	1,500
» » » (covered courts)	300	300	300	300	1,200
Modern Pentathlon	300	1,000	500	500	2,300
Rowing (individ.)	300	1,000	500	1,000	2,800
» (team)	100	500	250	500	1,350
» (boats)	100	150	150	150	550
Shooting (individ.)	1,500	2,000	1,500	1,000	6,000
» (team).....	250	500	500	300	1,550
Swimming (individ.)	750	1,500	1,000	1,000	4,250
» (team)	150	300	300	250	1,000
Wrestling	400	1,000	500	500	2,400
	11,050	22,150	15,050	13,550	61,800

Measures taken for the convenience and comfort of visitors to Stockholm.

The Swedish Olympic Committee considered that it was its duty to do its best to ensure the convenience and comfort of the foreign competitors and visitors expected to the Games. In consequence, a reduction was obtained of 50% in the fares on the State Railways for all the functionaries and competitors in the Games, in addition to the free transport of all apparatus, horses, etc. Some 20 salaried interpreters

were instructed to be in attendance on visitors at the principal railway stations, steamboat piers and other public places; a number of persons were chosen to act as hosts for the teams representing the various nationalities, for the purpose of assisting them with advice and information during their stay in Stockholm; official printed guides were issued, containing maps and detailed information, and there was also published a daily programme of entertainments and general information. Aided by a grant from the Swedish Olympic Committee, "The Olympic News" was issued daily in English and Swedish, published by three Swedish Athletic journals in common. By this means, the numerous competitors at the Fifth Olympiad were able to obtain early and reliable information respecting the past and the coming events of the Games.

In order to meet the demand of the public for meals and refreshments in the immediate neighbourhood of the Stadium, the Swedish Olympic Committee took steps to have the large lawn-tennis covered courts, close to the grounds, transformed into a first-class restaurant. Measures were also taken to provide for the entertainment of visitors; Pleasure Gardens were opened at Sturevägen Road, just north of the Stadium; gala performances were given at the Royal Opera, and Music Festivals and other festivities amply sufficed for the entertainment of the general public.

REPORT OF THE FINANCE COMMITTEE.

The composition of the Finance Committee and its secretariat.

After the Swedish Olympic Committee had begun the work of the organization of the Olympic Games of Stockholm on 7 Oct. 1909, B. Burman, Esq., Bank Director, and F. af Sandeberg, Esq., were chosen on Nov. 15, to deal with the preparatory work concerning all questions of finance and the administration of the funds of the Committee.

In proportion as the labour of these two gentlemen increased, however, the section for finance found itself obliged to add to its numbers. On the 27 June 1911, Walter Murray, Esq., Under-Secretary of State, was elected a member of the Committee for Finance; Dr Astley Levin and S. Linnér, Esq., Under-Secretary of State, were nominated as temporary adjoined members of the Committee on the 6 Febr. 1912; on the 27 Febr. 1912, Baron Fredrik Ramel, Secretary to the Cabinet, entered the Committee as temporary adjoined member; Dr Astley Levin and S. Linnér, Esq., were elected ordinary members on the 2 April 1912 and, on the 21 May 1912, Charles Dickson, Esq., Bank Director, was also elected an ordinary member of the Subcommittee for Finance.

E. Lomm, Esq., was chosen as Secretary of the Finance Committee on the 1 March 1912.

On the 1 May 1912, the Sub-committee for Finance had to deplore the loss of one of its members, Bernhard Burman, Esq., who died that day after a very short illness. Bernhard Burman, who had for many years belonged to the Board of the Central Swedish Athletic Association, and who, during that period, contributed very greatly to the promotion of athletics in this country, had, during the time he was a member of the Swedish Olympic Committee, and of its Sub-committee for Finance especially, shown the greatest interest in his task, his extremely valuable aid in these Committees contributing in no little degree to the surmounting of many of the difficulties that stood in the way of the organization and carrying out of the Games. The Sub-committee for Finance desires to take this opportunity of expressing its gratitude for the work performed by Bernhard Burman, and its deep sense of the loss it sustained by his death.

INCOME.

Funds and Lotteries.

The first task of the Finance Committee was of course to endeavour to make an estimate of the probable expenses of the Games, and then to take the necessary steps for procuring the money requisite to cover these expenses.

On the occasion when the question was debated whether Sweden, at the Meeting of the International Olympic Committee which was to be held in Berlin on the 27 May 1909, in the event of its being offered the privilege of arranging the next Olympic Games, should declare itself ready and willing to undertake the task, the matter was first of all referred to the National Gymnastic and Sporting Association. This Association stated that it was willing to undertake the arrangement of the competitions in branches of athletics which were within its sphere, and which were to form part of the programme at the Games but, at the same time, the National Association expressly declared that it was totally without the pecuniary means necessary for this purpose, so that the responsibility of procuring the money necessary for the organization and carrying out of the Games, over and above the sum that could be expected from the sale of tickets, etc., would rest exclusively on the Central Association.

To begin with, the Swedish Central Association for the Promotion of Athletics made a gift to the Finance Committee of the sum of 13,000 Kronor (£ 720: \$ 3,600), the surplus remaining to the Central Association of the sum that had been collected to pay the expenses of the Swedish athletes who took part in the Olympic Games of Athens 1906, and of London 1908.

The amount that the Sub-committee for Finance next received was 130,000 Kronor (£ 7,200: \$ 36,000), which the Central Association received from the Government on the 30 June, 1910, to be placed at the disposal of the Swedish Olympic Committee, and which sum, it was

hoped at the time by those concerned, would be sufficient to cover the expenses of the Games.

The estimates of the budget of the Games which was made by the Finance Committee about the 30 June, 1911, in drawing up which, the greatest care had been taken to endeavour to make a list, as detailed and complete as possible, of all the possible sources of income, and of the expenses that would prove to be unavoidable, clearly showed, however, the necessity of further financial aid, especially as there were many immediate expenses that had to be paid long before anything would be received by the sale of tickets, etc.

On the recommendation of the Central Association, therefore, the Swedish Olympic Committee, on the 25 September, 1911, asked the Government for permission to obtain an advance of 250,000 Kronor (£ 13,880: \$69,400) from the funds of the Central Association, this application being granted on the 15 October, 1911.

From the report sent in to the Swedish Olympic Committee by the Stadium Building Committee it was seen, that the means at the disposal of the Building Committee would not suffice for the completion of the work in question. In consequence of this report, the Swedish Olympic Committee petitioned the Corporation of Stockholm for a grant of 100,000 Kronor (£ 5,550: \$ 27,750) to be used for the completion of the Stadium and the carrying out of the Games. On the 4 March, 1912, the Corporation so far acceded to this request as to make a grant of 50,000 Kronor (£ 2,775: \$ 13,875), on certain conditions which, later on, were approved of by the Central Association, the money being received by the Olympic Committee on the 31 May, 1912.

By the 30 March, 1912, the Sub-committee for Finance was ready with fresh estimates, in which were included, not only the receipts and expenditure as calculated for the time between the date mentioned and the opening of the Games, but also those that could be expected during the progress of the Games and after their completion, until the final closing of the accounts. These estimates showed that, as time went on, all the earlier calculations made respecting the debit and credit of the Olympic Games of Stockholm, were unreliable. For, even if the hope could be entertained that the monies received during the Games would probably be considerably in excess of what had first been expected, still, on the other hand, the expenses had shown a most unexpected tendency to increase, this being chiefly due to the facts that, on account of the great athletic-technical demands made, the construction of the Stadium and the putting into order of the athletic grounds at Östermalm, Råsunda and Traneberg, had become far more expensive a matter than had been expected; that a very large sum was necessary for the training of the Swedish representatives, and, finally, that in consequence of the entries of competitors from abroad greatly exceeding the number that had been expected, the sum required by the Reception and Entertainments Committee had also risen very much.

At this period, the agreements with the various sections of the athletic associations (for pure athletics, swimming, football, etc.), men-

tioned in greater detail farther on, had in nearly every case been concluded, and the fact could no longer be concealed that, although a sum of 325,000 Kronor (£ 18,000: \$ 90,000) had been obtained by the sale of series-tickets, the estimates showed that a further sum of 400,000 Kronor (£ 22,200: \$ 111,000) was still needed. Through the Swedish Olympic Committee, therefore, the Sub-committee for Finance applied to the Government for permission to obtain a further advance from the funds of the Central Association to the amount last mentioned. This permission was granted by an official rescript dated the 1 June, 1912, the Finance Committee receiving the sum in question on the same date. As far as can be estimated at the moment of writing this report, about one half of this sum will have to be used, after the payment of some outstanding items and the receipt of certain sums of money still owing to the Finance Committee.

The Sale of Tickets.

Entrance to the Stadium was obtained either by series-tickets, which were sold at the office at Norrmalmstorg ; by day-tickets, as they were termed, which could be had at the turnstiles N:os 7—12 and 21—28 at the Stadium, or else on payment of the necessary sum at the turnstiles N:os 1—4, 13—20 and 29—32. There were 32 turnstiles in all, 2 at the entrance to each section of seats. One ticket seller and one controller were stationed at each turnstile, there thus being 64 such officials.

The Section for the booking of seats, which began its work as early as November, 1911, in the offices of the Central Association, moved on the 1 February, 1912, to 4 Norrmalmstorg, where, until the 15 August of the same year, it occupied a flat of 9 rooms, some of which, however, served as offices for the Reception Committee, the Accommodation Committee, the Inquiry Office, etc.

The preparatory work for the sale of tickets, which, amongst other things, included a very lively early booking of tickets, was carried out at the offices of the Central Association, under the direction of Mrs. Dagmar Waldner, who had two assistants.

After Mrs. Waldner had transferred her services to the Reception Committee, Mr. Carl Smith was chosen on the 1 February, 1912, as the director of the section for the booking of tickets. He was assisted by Mr. N. Wennerström, as cashier, and a staff of 6 other persons, in addition to a porter. During the period when the Games were going on, however, the number of the staff had to be doubled. Mr. Julius Höglund acted as controller of the cash-department.

The sale of series-tickets to the general public commenced on the 18 February, 1912, the hours between 11 a. m. and 1.30 p. m. being reserved for the issue of tickets previously booked, while the hours between 2 p. m. and 4 p. m. were devoted to the sale of fresh tickets.

In order to make it as easy as possible for intending purchasers of tickets to choose their seats, there was placed in one of the rooms at Norrmalmstorg a plaster model of the Stadium, drawn accurately to scale, in addition to which, plans of the various sections of the reserved

seats could be seen, all necessary information being supplied by members of the staff.

The stream of purchasers proved to be quite as large as had been expected, and there was a very lively demand for seats the whole of the time. Until the Games began, only *series-tickets* were sold, the prices being £2.15.6, £4.3.0, £5.10.9 and £11.1.6¹ for Stadium seats; £1.2.0, £1.12.9 and £2.15.6² for series-tickets to the Swimming Stadium; 11/-³ for the Fencing Competitions, and £1.7.9⁴ for series-tickets for the Lawn Tennis and Football Competitions. In addition to these, there were also sold single day-tickets for the Horse Riding Competitions on the 16 and 17 July, which cost 5 sh. 6 d., 10/- and £1.2.2⁵ each, according to the position of the seats.



Faces of the Series Tickets to the Stadium.

The demand for tickets for the Stadium, especially, was very great, and the sections of seats first offered for sale were soon all disposed of, fresh sections having then to be offered to the public, although care was taken to reserve the necessary numbers of seats for sale on each day of the Games. The ratio between the above-mentioned reserved seats sold at the various prices proved to be a very good one, the number of tickets disposed of in each class being proportionally the same.

Carl Hellberg, Esq., was appointed director of the Finance Office at the Stadium. The preparatory work here consisted of the drawing up of the forms necessary for exercising control over the business done and for statistical purposes. These forms proved to answer their purpose, a fact confirmed by the report sent in

¹ \$ 13.40; 20.10; 26.30; 52.60. ² \$ 5.36; 8.04; 13.40. ³ \$ 2.68. ⁴ \$ 6.70. ⁵ \$ 1.34; 2.68; 5.36.

by the scrutineer of the figures. Messrs. H. Juhlin and E. Svensson were chosen to assist Mr. Hellberg in his work. Six lady-assistants were appointed for the purpose of counting the money received from the sale of day-tickets at the Stadium and of seeing that it was

correct. The finance-office in question was opened on the 1 June, 1912, when the great try outs began at the Stadium, the general rehearsal thus obtained being of the very greatest use, not only for the office but also for the attendants etc.

The Finance Office was opened officially for the Games on the 26 June, and was closed at midnight on the 20 July. The work began as a rule, at 7 a. m. and finished at midnight, with intervals for meals.

Full accounts were kept of all the monies received at the Stadium, as well as complete statistics of the number of persons admitted at the different turnstiles, to each of the various groups of competitions. The sale of day-tickets for the Stadium took place each day immediately before the competitions began, in order to avoid speculation, and also that there should be tickets available at almost the very last moment for sightseers arriving by train or boat. The day-tickets were of two kinds, one, numbered, to a total of about 3,000, which were to be had at the ticket-selling offices at Norrmalmstorg, and the other unnumbered, there being some 10,000 tickets in this class, which, under the direction of Mr. Carl Hellberg, were sold at the turnstiles admitting to the Stadium. Perfectly satisfactory measures were taken to hinder the purchase of day-tickets for the purpose of speculating in them, and the most perfect order was always observed by the purchasing public, in spite of the fact that, on those

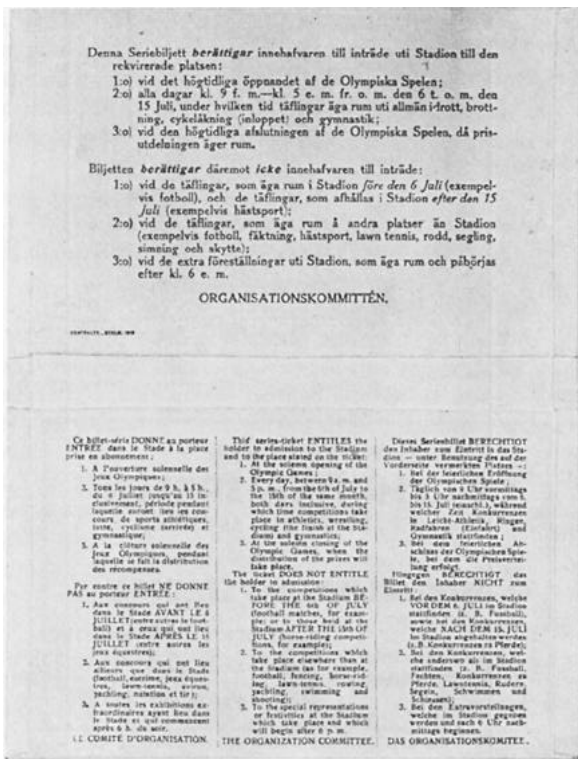

Backs of the Series Tickets for the Stadium.

days when very interesting events were to come off, queues were often formed, each numbering several thousand persons. The prices of the day-tickets was from 1 krona to 25 kronor (circa 1 sh. 1 $\frac{1}{2}$ d., to £1 . 7.9: 27 c.—\$ 6.70).

The sale and distribution of the official Stadium-programme was confided to the Section for the sale of tickets, which received valuable assistance from the Stockholm boy-scout corps. It should also be mentioned that the sale of a very large proportion of the tickets for the various entertainments given in connection with the Games, was also in the hands of the Section mentioned above.

It is clear, however, that the sale of tickets could not take place exclusively in Stockholm, and considerable numbers of tickets were sold and sent by post, to every part of the world. Prospectuses with the prices of the tickets and plans of the seats in the Stadium were printed in the languages of most civilized countries, so that the public abroad could easily make suitable arrangements for the purchase of series-tickets for the Games.

The Committee for Finance was also commissioned to undertake the presentation of complimentary tickets to honoraries, guests from abroad, etc., both for the solemn opening of the Games and for the whole of the competitions.

Extra sources of Income.

In order to employ all the possible sources of income that might be to the profit of the Swedish Olympic Committee, the Sub-committee for Finance had made arrangements with a number of firms for the purchase by these of certain sole rights in connection with the Games. For example, an agreement was made with the Granberg Industrial-Art Co., whereby the firm in question was granted the sole right of publishing and selling picture postcards with reproductions of photographs of the Games, taken inside the Stadium and at the other grounds where sections of the Games were held. In the agreement in question it was stipulated, that these picture post-cards were to be made in Sweden, and that the firm was, as far as possible, to publish views of interesting, actual incidents of the Games the day after the photographs had been taken, and that the firm should do everything in its power to push the sale of the cards. The Finance Committee placed one large and one little stall at the disposal of the Company, for the sale of the post-cards. The agreement proved to be an exceedingly advantageous one, the firm having already paid the Committee about 13,000 kronor (£ 720: \$ 3,600), showing that there has been a great demand for the cards, awakened, in no small degree, by the excellence of the work.

For the right of taking and selling photographs of the Games, an agreement was entered into with the most important of the Stockholm daily papers, the sporting press and a number of weekly journals, who were to be represented by 7 of the most experienced photographers in this line in Sweden. In accordance with this agreement, the journals

mentioned, in consideration of being allowed to take photographs gratis in the arena of the Stadium and at the other places where any of the Games were held, to the extent that the local conditions permitted this to be done, engaged to deliver the negatives of these photographs, before 10 a. m. the next day, at the Photographic Agency of the Olympic Games, represented by the Hasselblad-Scholander Photographic Stores, Ltd., at the risk of otherwise losing the right of taking photographs during the remainder of the Games at the places where the competitions were held. The Agency was to have the full right of the disposal of the negatives until the 15 September, 1912, and, until this date, the newspapers above-mentioned were to make no other use of the photographs in question than for the purpose of illustration in the respective papers; neither were they to exhibit the photographs in other places than in their own offices, where, however, no copies of them were to be sold.

An agreement was, further, entered into with the Hasselblad-Scholander Photographic Stores, Ltd., as the sole photographic agents of the Swedish Olympic Committee, regarding the sale of the photographs taken from the negatives sent in to the firm in accordance with the above-mentioned agreement made with the newspapers, or from negatives taken by the photographers of the Agency itself. The sale of photographs took place in the Hasselblad-Scholander Stores, and also at stalls in the immediate neighbourhood of the Stadium which the Finance Committee placed at the disposal of the firm, free of charge. The firm in question engaged to communicate with those newspapers and journals abroad that had no photographers here, for the purpose of supplying them with photographic illustrations. The Agency sent a great number of foreign journals photographs of each day's competitions by the night express every evening. The Agency also undertook to pay the expenses of developing and copying the photographs, and of their distribution.

Spectators of the Games were allowed to take photographic apparatuses with them to their seats inside the Stadium, but not such as were intended for the production of moving pictures, while those visitors that desired to take photographs from the seats had previously to give the Agency a signed declaration, stating that the photographs in question would not be exposed for sale, or used for the purpose of advertisement.

The agreement with the Hasselblad-Scholander Stores also fixed the price of the photographs sold to the public, and to Swedish and foreign journals with the right of reproduction. The Swedish Olympic Committee reserved the right of choosing from amongst the negatives at the disposal of the Agency, copies of photographs for the Committee's archives and for its official report, as well as the right of reproduction. This agreement, which the Hasselblad-Scholander Stores did everything in their power to carry to a successful issue, and one result of which has been the publication of the magnificent photographic album of the Games issued by the firm of Messrs. Åhlén & Åkerlund, has, at present, brought in the Finance Committee a sum of about 13,000 kronor (£714: \$ 3,570).

The right of taking cinema-photographic pictures of the Games was disposed of by the Sub-committee for Finance to the Swedish-American Films Co., Ltd., the Company being granted the sole right, during the period June 1 to July 19, 1912, of taking cinema-photographs in the arena of the Stadium and at other places where Olympic Competitions were to be held and which were at the disposal of the Committee for that purpose, subject to the condition that, in the opinion of these members of the Swedish Olympic Committee responsible for the technical arrangements of the Games, the taking of such pictures would not hinder the proper carrying out of the competitions, and on the understanding that the Company was assured such sole rights only when the local conditions prevailing at the places where the various competitions were held, enabled the Swedish Olympic Committee to take measures against the infringement of the rights in question. The agreement also covered the try outs that were to take place during the first days of June, 1912, in connection with the opening of the newly-finished Stadium, and permitted the Company to have on the ground not more than 6 apparatus at one and the same time, with 6 photographers and 4 assistants, 2 groundsmen and the necessary number of attendants. The apparatus were to be placed in such positions as were assigned them by the leaders of the various competitions after consultation with the representatives of the Company, for whom a room was reserved at the Stadium. The Swedish Olympic Committee reserved the right of choosing and obtaining, for its archives, free of charge, perfect copies of the films taken by the Company during the Games, while the Company engaged not to employ the negatives and copies they had taken for any other purpose than for moving-picture performances. The agreement thus made was not to infringe in any manner, however, on the right of taking photographs, for picture post-cards or photographs for sale to the general public or to the Press, which had been granted by the Committee to the Hasselblad-Scholander Stores Co.

The Sub-committee had, at various times, received tenders made by other firms provisionally offering larger amounts for the cinematographic rights than were finally obtained, but nothing came of them.

Agreements, bringing in smaller sums, were made with other firms. Östberg and Lenhardtson, Ltd., was granted the sole right of reproducing in metal the various official illustrated posters, the commemoration medal, a view of the Stadium, and all the other drawings and sketches made for the account of the Swedish Olympic Committee, and of which the Committee had the sole right of disposal.

Other agreements were made respecting the hiring-out in the Stadium of field-glasses; the sale of cheap fans for use in the hot weather; the sole right of selling purses and pocket-books on which copies of the registered illustrated advertisements issued by the Swedish Olympic Committee were pressed or printed; the right of using copies of the official poster of the Games on match-boxes, and of placing weighing-machines in the grounds, etc.

In consequence of special arrangements made with the Swedish Athletic Sports Association and the Swedish Athletic Association, the Sub-committee for Finance received a considerable amount from the try outs for the Games that took place in the Stadium on the 2, 3, 5 and 6 June, 1912.

An arrangement was entered into with the Swedish Choral Union, in virtue of which the Union was granted permission to give an open-air concert in the Stadium at 6.30 p. m., Saturday, 13 July, at the close of the grand procession of the singers through the town.

Agreements made with the Swedish Trotting Club, the Stockholm Trotting Club and the Stockholm Racing Club, brought in the Finance Committee part of the receipts of matches arranged by these bodies and which took place during the Games, though in no sort of connection with them.

Agreements made by the Olympic Entertainments Committee also brought the Finance Committee in fairly considerable sums. For example, the Fair that went under the name of "The Olympian Fields", paid the Swedish Olympic Committee a certain percentage of the amount charged for admission, the total thus received coming to about 29,000 Kronor (£ 1,600: \$ 8,000). The amount received from Stockholm section of the Swedish Association of Musicians on the occasion of the great military concert given at the Stadium by this body on the 6 July, was about 7,000 Kronor (£ 380: \$ 1,900), in the addition to which, the Finance Committee received some small amounts as its share of the receipts from the Boy Scouts' Display at the Stadium; from the soiree given by the Club for the Promotion of Swedish National Dances, the pleasure trips made by the steam-yacht "Brevik" etc.

An agreement made with the Tennis Covered Courts Co, placed the pavilion just behind the Stadium at the disposal of the Finance Committee at a low rent during the period June 1—July 31. This large hall was afterwards sub-let for the same period by the Finance Committee to Mr. Carl Löfvander, of the Kronprinsens Hotel, for a consideration of 2,000 Kronor (£ 110: \$ 550).

By an agreement made with Mr. E. W. Hjertberg, the athletic trainer engaged by the Swedish Olympic Committee, he was given an assistant, in consideration of a payment by Mr. Hjertberg of the sum of 2,500 Kronor (£ 138: \$ 690) out of the profits obtained by the sale of his book entitled "Athletic Training".

Other Agreements.

Amongst the agreements which did not bring in the Committee any money may be mentioned:

a) that with the publishing firm of Hasse W. Tullberg, arranging for the issue of the official guide to Stockholm in Swedish, English, French, German and Russian, and of a daily programme of entertainments, in which latter publication, two sides were placed at the disposal of the Swedish Olympic Committee for the insertion of information respecting the Games. This publication appeared from June 29 — July 15;

b) that with Erik Bergvall, Esq., Editor of the Nordiskt Idrottslif, respecting the issue of the paper "The Olympic News", between June 17 and July 27 with the text in Swedish and English, and which appeared every day between the 25 June and 20 July. The publication of this journal was made possible by the coalescence, for the time, of the three athletic newspapers, "Idrotts bladet", "Nordiskt Idrottslif" and "Ny Tidning för Idrott". A four column side was placed, gratis, at the disposal of the Swedish Olympic Committee for the publication of its notices, in addition to which, the Committee was to have the right to make use, free of charge, of the articles and illustrations of the Olympic News for its coming publications. The amount of 3,000 Kronor (£ 160: \$ 800) granted by the Swedish Olympic Committee in aid of the enterprise, was to be returned after the payment of all current expenses and after the publisher had obtained a certain profit on his total expenditure, but as there were no returns on the venture, it has not been possible to refund any part of the sum advanced.

EXPENDITURE.

The Swedish Olympic Committee, on first beginning its labours, had its offices in the premises of the Central Association for the Promotion of Athletics, 5 B, Norra Blasieholmshamnen, Stockholm, where a large room was placed at the disposal of the Committee for the purpose of meetings, two smaller rooms being set aside as the secretarial offices. From the 1 April, 1911, however, the Sub-committee for Finance found itself obliged to take a large flat, consisting of 11 rooms and the usual offices, on the second floor at 1 A, Hamngatan, to which the whole of the work was transferred, and where the meetings of the various committees were held. The different sections had rooms placed at their disposal for their meetings and the preservation of their archives, and all the work was carried on here until the 1 October, 1912, when the Secretariat was removed to offices at the Stadium.

In addition to the Secretary to the Swedish Olympic Committee — Mr. Kristian Hellström, who was appointed to his post on the 1 May, 1910 — and his principal assistant, Mr. John Widenfelt, there were no less than 24 clerks (20 of whom were women) at work here during the busiest period before and during the Games; there were also 4 porters and the same number of errand-boys, or, in all, 34 persons, and this in spite of the fact that the aid of type-writing offices and printing-offices was very often employed.

Agreements made with the Athletic Committees.

Before the Finance Committee began its negotiations with the various Athletic Committees, it drew up and submitted to the Swedish Olympic Committee, a general form of agreement, according to which, each of the said Athletic Association Committees was to engage to make the arrangements for its own branch of athletics, in agreement with

the programme of the Olympic Games and the international regulations in force, each of the said Athletic Committees being enjoined:

a) to carry out the preparatory work for the worthy representation of its special branch of athletics, this including the arrangement of any try outs that might be found necessary;

b) to make such technical arrangements as were in its power, such as procuring the materials necessary for the carrying out of the respective competitions ; and

c) to lead, or direct, its respective branch of sport during the Games.

The rules for the competitions and the general regulations, as well as the lists of judges and other officials proposed by the Athletic Committees, had to be submitted to the consideration, and for the approbation, of the Swedish Olympic Committee. The chief direction of the whole was in the hands of the Swedish Olympic Committee, which fixed the day, hour and place for each competition, and confirmed the programme that had been drawn up.

The agreements contained clauses respecting the disposal of the money received from the sale of tickets and programmes, and other stipulations concerning the measures to be taken for such sale, and determining the number of complimentary tickets to be placed at the disposal of each section of the Athletic Committees. Another paragraph dealt with the ownership of the material purchased, while there were clauses fixing the amount to which the various Athletic Committees were entitled, to cover the expenses of training and of the arrangements for the try outs.

The books of the Athletic Committees were to be submitted for the inspection and approval of the Swedish Olympic Committee.

The correspondence on technical matters was left in the hands of each of the Committees, while that on other matters was managed by the Secretariat of the Olympic Committee. Copies of the direct correspondence carried on by the committees in question; together with general reports of the progress of the work, had to be sent in without delay to the Secretariat of the Swedish Olympic Committee, so that the latter body might have knowledge at first-hand of the measures taken by the said committees. The Committees of the Associations were not empowered to come to any decisions binding on the Olympic Committee, or to make any verbal or written agreements in the name of the Swedish Olympic Committee, unless on the written instructions of the said Committee. All entries were to be sent direct to the Swedish Olympic Committee.

The first agreement made was that with the *Swedish Football Association*, on the 22 January, 1911, according to which, the Association which, at the time, considered it was in a position to take upon itself the whole economical risk of arranging the football competition, agreed to pay the Swedish Olympic Committee 25% of the gross receipts. One year later, however, the Football Association stated that it considered it was not in a position to carry out its undertaking, and

that it found itself obliged to ask for a grant amounting to no less than 48,500 Kronor (£ 2,690: \$ 13,450). This sum proved to be necessary to cover the training expenses of the Swedish football team, of the arrangement of the various matches in the Olympic Competition, and of putting in order the grounds at Råsunda and Traneberg. The Swedish Olympic Committee granted the sum asked for, but, at the same time, took over the financial direction of the Football Competitions, agreeing, at the same time, that part of the surplus which might remain after the repayment of the above sum to the Swedish Olympic Committee, should be given to the Swedish Football Association, and to the Råsunda Athletic Grounds.

Later on, agreements were made with:

- The Fencing Committee*, on the 15 April, 1911, when a grant was made to the said Sub-committee of 2,500 Kronor (£ 135: \$ 675).
- The Clay-Bird and Running Deer Shooting Committee*, on the 4 May, 1911, a grant being made to this Sub-committee of 10, 168 Kronor (£ 560: £ 2,800).
- The Cycling Committee*, on the 24 May, 1911, a grant being made to the said Sub-committee of 5,800 Kronor (£ 320: \$ 1,600).
- The Athletic Committee*, on the 18 August, 1911, a grant being made amounting to 9,215 Kronor (£ 510: \$ 2,550). This Sub-committee also had the arrangement of the *Tug-of-War* Competition.
- The Wrestling Committee*, on the 18 August, 1911, to which a grant was made of 6,685 Kronor (£ 370: \$ 1,850).
- The Rowing Committee*, on the 29 August, 1911, a grant being allowed of 10,200 Kronor (£ 560: \$ 2,800).
- The Army Rifle- and Miniature Rifle Shooting Committee*, on the 6 September, 1191, to whom a grant was made of 6,000 Kronor (£ 330: \$ 1,654).
- The Yacht Racing Committee*, represented by the Royal Swedish Yacht Club, which undertook the financing of the sailing competitions. This agreement was made on the 20 November, 1911.
- The Horse Riding Committee*, on the 20 November, 1911. This Committee, which had the independent control of its economy, was guaranteed a sum of 15,000 Kronor (£ 824: \$ 4,120), on condition that its budget did not exceed 100,000 Kronor (£ 5,550: \$ 27,750) and that there were guarantees to that amount.
- The Swimming Committee*, on the 7 February, 1912, a grant being made of 4,200 Kronor (£ 230: \$ 1,150), together with a loan of 16,600 Kronor (£ 910: \$ 4,600).
- The Lawn Tennis Committee*, on the 15 March, 1912, to which a grant was made of 14,860 Kronor (£ 820: \$ 4,550).
- The Gymnastic Committee*, in May, 1912, a grant being allowed of 23,000 Kronor (£ 1,290: \$ 6,350).
- The Västerås Baseball Club*, on the 13 June, 1912, a grant being made of 835 Kronor (£ 46: \$ 230).

The Modern Pentathlon Committee, on the 30 June, 1912, to which a grant was made of 1,000 Kronor (£ 55: \$ 275)

As a rule, it proved that the grants thus made were not sufficient, and the Sub-committee for Finance was therefore obliged, every now and then, to make additional grants. The totals of the amounts are given in the table of estimates, and so it will not be necessary to mention here more than the most important of the extra grants.

The Athletic Committee, received on the 9 January, 1912, an extra grant of about 20,000 Kronor (£ 1,110: \$ 5,550), in addition to which, the Finance Committee, on the 19 June, 1912, gave the Athletic Committee leave to draw on it for payment of the expenses incurred over and above this sum, caused by the furnishing, etc., of the Home for the Swedish Athletes in training, the Tug-of-War competition and the Marathon Race.

The Wrestling Committee received an extra grant to pay for 5 try outs.

The Rowing Committee, which, when it first drew up its estimates, had calculated on receiving 15 or 20 entries from 6 or 7 different nations, but, instead, received 66 entries from 15 nations, and consequently found itself obliged, on the 2 June, 1912, to ask, for an additional grant of no less than 32,477 Kronor (£ 1,800: \$ 5,400), part of which sum was to be spent on the erection of stands, boat-houses, etc.

In accordance with an agreement made on the 20 June, 1912, with the *Horse Riding Committee*, the latter was granted the free disposal of 200 series-tickets to the Stadium, both for the Games proper and during the Horse Riding Competitions, the selling-value of which finally proved to amount to 57,340 Kronor (£ 3,180: \$ 15,900).

On closing the accounts of the *Swimming Committee*, it has proved that the said Committee was obliged to spend a sum of 57,843: 98 Kronor (£ 3, 123: \$ 15,615) on the erection of stands and for carrying out the competitions. Out of the surplus obtained from the sale of tickets, etc., the Swedish Swimming Association, in accordance with the agreement made, has received a sum of 11,606: 44 kronor (£ 635: \$3,175)

In consequence of the large number of entries for the Lawn Tennis Competitions, out-of-door courts, the Finance Committee was obliged to make a further grant to the *Lawn Tennis Committee* for the purpose of constructing two new courts at the Östermalm Athletic Grounds in addition to the two already existing there. The new courts and material came to about 10,000 Kronor (£ 550: \$ 2,750.)

Finally, a considerable increase had to be made in the grant first given towards carrying out the *Modern Pentathlon*, in order to cover the expenses of training and of the competition itself.

Agreements made with Trainers. Other Training Expenses.

A not unessential part of the time of the Sub-committee for Finance was taken up with the negotiations necessary before agreements could be made with the various trainers finally engaged for the Swedish

athletes, and for the agreements and financial estimates made with and for the Athletic Associations concerned.

Mr. E. W. Hjertberg, of New York, was appointed athletic trainer from the 16 July, 1910, to the 15 July, 1912, and his assistant, Mr. A. E. Ahhlqvist, was engaged from the 16 April, 1911.

Mr. Charles Hurley, of Leicester, England, was engaged from the 1 July, 1910, to the 30 September, 1910, and again from the 1 February, 1911, to the 31 August, 1911, for the purpose of training the Swedish swimmers that were to take part in the Olympic competitions.

The Committee engaged Mr. Ivan Tuomisto, Finland, from the 15 January, 1911, to the 15 April, 1911, and from the 1 November, 1911, to the 15 July, 1912, for the training of the Swedish wrestlers.

The other persons that were engaged as trainers besides those now mentioned, were engaged direct by the various sections of athletics taking part in the Games, such as those for Rowing, Football, the Modern Pentathlon, etc.

The Swedish Olympic Committee took steps to have the following Athletic Grounds placed at its disposal for training purposes: that at Östermalm, during the whole of June and July; that at Råsunda from the 15 April until the 15 July, both days inclusive, and that at Traneberg from the 1 June to the 5 July, both days inclusive. Before the dates on which training began, however, all these grounds had been put in first-class order at the expense, and under the direction, of the Swedish Olympic Committee.

A grant received from the Swedish Olympic Committee enabled the Sub-committee for Athletics to arrange a Home in the immediate neighbourhood of the Stadium, where the Swedish competitors in Athletics went to stay for a month before the beginning of the Games, and where they were placed in the charge of the trainer, Mr. Hjertberg. They received board and lodging gratis until the close of the competitions in question. Out at Djurgården, a similar home was arranged for the Swedish oarsmen by the Olympic Committee for Rowing.

Other Expenses.

For the purpose of providing sleeping accommodation for those of the competitors in the Games that did not prefer to stay elsewhere, the Sub-committee for Finance made an arrangement with the School Board for Stockholm, in virtue of which the Committee had placed at its disposal, during the period June 18—July 31, certain rooms in the primary schools at 54 Linnégatan, 34 Mariebergsgatan and 44 Tegnér-gatan. In addition to these premises, the Finance Committee hired from Captain Gustaf Örn, the Riding Institute and the open space around it, in the immediate neighbourhood of the Stadium, from the 15 June to the 15 July.

In order to obtain the requisite accommodation for visitors to Stockholm during the progress of the Olympic Games, the Finance Committee made agreements with the house agencies, Nya Aktiebolaget Tjäders Byrå, and the Stockholms Uthyrningsbyrå, by which the two establishments were appointed the official representatives of the Swedish

Olympic Committee for the purpose of procuring the accommodation in question. These agreements, which, it is true, were not intended to be sources of income for the Committee, but which were quite necessary and obviated the necessity of any expenditure in this direction, contained detailed regulations respecting the establishment of special offices, in central positions, which were to be open during the months of June and July and were to be properly staffed with assistants able to attend to the wants of travellers who spoke no Swedish. The Accommodation Offices engaged to follow the advice and directions that might be given by the Swedish Olympic Committee through the Sub-committee for Finance or the Olympic Accommodation Committee, and to obey the ruling of the Finance Committee in matters concerning the price of rooms, etc. All the apartments intended for letting to visitors had to be inspected by representatives of the Offices, and the rents were to vary between Kr. 3 (3 sh. 4 d.: 81 c.) and Kr. 10(11 /-: \$2.68) per room, according to the accommodation provided, the prices to be in agreement with those charged at the time by Stockholm hotels of the second rank. Only in exceptional cases was the rent to exceed the highest of the figures given above, and then only with the consent, in each case, of the Olympic Accommodation Committee, and to an amount approved of by this body. The work carried out by the Offices was subject to inspection by the Olympic Accommodation Committee, and any clear and serious infringement of the regulations laid down in the agreement could lead to the public annulment of the contract in question, unless the matter was at once rectified after proper notice.

There may also be mentioned the agreements that had to be made during the course of the earlier preparations for the Games, such as

a) that with A. Börtzell's Printing C:o, for the printing of the official placard of the Games, which was executed with the text in 16 different languages, the whole edition numbering 88,350 copies ;

b) that with the Central Printing C:o, Stockholm, for the printing of the advertisement-pamphlet in 4 languages, the edition numbering 260,000 copies; and also for the printing of the advertisement stamp, with the text in 16 different languages, the edition numbering 4,782,200 copies;

c) that with E. G. Ekstrand, Gymnastic Apparatus Maker, for providing the gymnastic apparatus required by the Swedish and foreign gymnastic teams ;

d) that with the Furnishing Department of the Nordiska C:o., Ltd. for supplying the furniture required for all the rooms in the Stadium buildings, and that with the same Company and the Union Tailoring C:o., for supplying uniforms for the attendants at the Stadium; and

e) those with the Norra Sverige Bank and the Norrland Bank for the opening of banking accounts.

The Finance Committee, in co-operation with the Entertainments Committee, made the necessary arrangements for the issue of invitations to the festivities during the course of the Games.

The Finance Committee has also had to make the arrangements respecting the publication of the official report of the Fifth Olympiad, its translation into English, and the printing and issuing of the work.

Mr. Erik Bergvall was appointed the editor, assisted by the General Secretariat. The translation of all the official reports, etc., of the Games has been carried out by Mr. Edward Adams-Ray. The printing of both editions (the Swedish and the English) was entrusted to the Central Printing Co., Ltd.* The paper used has been supplied by two firms, the Klippan Paper Works and the Grycksbo Paper Works. The binding has been executed by the Central Printing Co., Ltd., while Wahlström & Widstrand, Publishers, issued the work in Sweden.

During the whole of the period covered by the preparatory work for the Games, the competitions themselves and the closing labours of the Swedish Olympic Committee, the Sub-committee for Finance has had to undertake the custody of the money received, to make all necessary payments; to draw up and have the custody of all the agreements or contracts; to keep a cash book and a ledger; to carry on an extensive correspondence; to examine all accounts and to balance the books.

The Central Association for the Promotion of Athletics has been given all the material left on hand which was considered necessary for the completion of the Stadium, and for the preparatory work for the Olympic Games of Berlin in 1916.

TABULATED VIEW OF THE INCOME AND EXPENDITURE OF THE OLYMPIC GAMES OF STOCKHOLM.

Up to May 31, 1913.

(The expenditure is inclusive of the cost of the erection of the Stadium).

1 krona = 1 s. 1 d.; 27 cents ; 1 Mk. 12 pfgr. ; 1 frc. 40 cs.;
1 Mk. 40 pen. (Finnish); 52 Kopek.

Income:

(Olympic Games Fund	13,000: —	
Grant from City of Stockholm.....	50,000: —	
Swedish Central Association for Promotion of Athletics	1,276,019: 97	
Granberg's Art-Industry Co., Ltd.....	12,910: 60	
Hasselblad & Scholander's, Ltd , Photographers.....	13,275: 02	
Östberg & Lenhardtson & Co.....	2,299: 75	
Sale of Cinema rights	20,446: 90	
Restaurant in Tennis Pavilion	2,000: —	
Series-tickets acct.	429,560: —	
Day-tickets acct.....	250,762: 50	
Day Programmes & advertisements in them	18,848: 54	
Section for Athletics:		
Undergraduates' Amateur Theatricals	411: 37	
Choral Society's ("Orfei Drängar") matinée	647: 14	
Try outs	509: 99	1,568: 50
Section for Cycling:		
per Sale of Programmes	2,913: 14	
Sundries	67: 90	2,981: 04

Carried Forward: Kronor: 2,093,672: 82

* A.-B. Centraltryckeriet.

Brought Forward: Kronor 2,093,672: 82

Section for Fencing:			
Try outs	76: —		
Tickets sold during Games	1,636: —		
Inventories sold, and Sundries	664: 50		2,376: 50
Section for Football:			
Grant from Football Association	1,000: —		
Try outs	552: 54		
Tickets sold during Games	62,503: 50		
Inventories sold	350: —		64,406: 04
Section for Gymnastics:			
Apparatus and Inventories sold			1,025: —
Section for Horse Riding Competitions			123,539: 69
Section for Lawn Tennis:			
Sale of Tickets for the competitions	21,708: —		
Sale of Programmes	260: 93		
Sale of Inventories	946: —		22,914: 93
Section for Rowing:			
Gift from F. Löwenadler, Esq.	5,000: —		
Tickets sold during the Games	11,664: —		
Sale of Programmes	567: 90		
Sale of Inventories etc.	567: 48		17,799: 38
Section for Army Rifle Shooting:			
Sundry receipts from competitions			528: —
Section for Clay Bird Shooting:			
Gift from the Skånska Powder Mfg. Co.	360: 56		
Sale of Inventories, etc.	4,000: —		4,360: 56
Section for Miniature Rifle Shooting:			
Sundry receipts from competitions	85: 30		
Sale of Inventories	299: 82		385: 12
Section for Swimming:			
Try outs	2,122: 74		
Sale of Tickets during Games	69,287: 50		
Sale of Programmes	1,005: 70		
“Children’s Day” Festival, etc.	2,040: 92		
Sale of timber	5,972: 70		
Sale of sundry Inventories	370: —		80,799: 56
Section for Wrestling:			
Try outs			1,433: 64
Accommodation Committee’s acct.:			
Fees for Accommodation	8,870: 05		
Sale of Inventories	568: —		9,438: 05
Entertainments Committee’s acct.:			
“Olympia Gardens”	28,814: 94		
Concerts by Military Bands	7,164: 03		
Boy Scouts’ display; Entertainment given by the Club “Folkdansens Vänner”; S/S “Brevik” (pleasure trip), etc.	685: 36		36,664: 33
The Choral Association			13,943: 70
Inventories :			
Sale of sundry furniture, etc.			1,678: 75

Carried Forward: Kronor: 2,474,966: 07

Brought Forward: Kronor 2,474,966: 07

Sundries :		
Try outs	3,105: 82	
From Racing Club.....	625: 59	
» the Stockholm Trotting Club.....	103: 10	
Commission on hire of Lavatories, field-glasses, fans, etc. 615: 95	4,450: 46	

Total: Kronor 2,479,416: 53

C:a £ 136,082: \$ 680,410.

Expenditure:

Inventories:		
Furniture, etc.....	13,695: 57	
Interest:		
Interest on bank acct. and acct. current	2,252: 26	
Sundries.....	18,423: 09	
Posters and other Advertisements:		
Posters, advertisements of various kinds pamphlets, advertisement marks, photographs, expenses of distribution, etc.	106,638: 47	
Ticket Office:		
Rent, salaries and sundry expenses.....	31,995: 54	
General Secretariat's Office:		
Rent, heating and lighting, etc.....	16,264: 45	
Salaries:		
Salaries, etc. for the General Secretariat	67,768: 98	
Stationery :		
Type-writing machines and stationery; printed matter; forms; etc. for the General Secretariat	50,421: 99	
Postage and Carriage:		
Telegram and telephone charges; postage and carriage; advertisements, etc., for the General Secretariat.....	63,137: 32	
Medals and Diplomas:		
Sundry expenses for Printing, and for striking Medals	25,770: 40	
Programmes:		
Competition- and Day Programmes	70,878: 31	
Representation Acct.:.....	43,474: 09	
Olympic Games Fund:		
Tug-of-War Team's participation in the Olympic Games of London	400: —	
Accommodation Committee's Acct.:		
Expenses of Administration and Representation.....	8,469: 40	
Rent of premises: Hire of furniture, etc.....	2,302: 32	
Salaries of watchmen and control officials	1,298: —	
Inventories	2,092: 25	14,161: 97
Press Committee :		
Salaries and sundry expenses.....	3,131: 70	
Reception Committee :		
Salaries and sundry expenses	10,423: 75	
Information Bureau:		
Salaries and sundry expenses.....	1,175: 22	
Entertainments Committee :		
Sundry expenses	974: 22	
	Carried Forward: Kronor	540,987: 33

	Brought Forward: Kronor	540,987: 33
Idrottstidning ("The Olympic News") :		
Grant to		3,000: —
Daily Expenses Acct. of Stadium:		
Office expenses	2,448: 72	
Attendants, uniforms and caps	20,770: 95	
Expenses of competitions	21,986: 46	
Decorations, flags, music and lighting	15,427: 83	
Inventories	1,825: 18	
Supplementary expenses and sundries	5,187: 74	67,646: 88
Finance Office, Stadium:		
Salaries, and expenses of sale of day-tickets		3,444: 81
Tennis Co. Ltd.:		
Repairs, etc., to Tennis Pavilion		3,050: —
Foreign Committees		2,594: 55
Official Report of the Olympic Games:		
Sundry expenses		8,455: 47
Råsunda Athletic Grounds:		
Grant to, and share of profits		25,550: 43
Traneberg Athletic Grounds:		
Grant to		9,800: —
Östermalm Athletic Grounds:		
Tennis Pavilion	115,000: —	
Arena and Running Track	10,359: 10	
Sundry complementary work	7,272: 45	
Attendants and sundries	3,377: 74	136,009: 29
The Stadium:		
Preparatory work ; expenses of pulling down the old building	11,919: 51	
Foundations; permanent buildings and stands; tunnel to arena	627,319: 68	
Provisional stands around the arena	43,169: 70	
Provisional stand (now removed)	41,918: 80	
Arena and Running Track	122,609: 21	
Railings and Turnstiles	38,545: 03	
Entries and Lavatories	43,159: 35	
Gardens and roads	44,743: 49	
Gas-, water-, and heating-pipes	100,755: 06	
Electric lighting	15,745: 82	
Tower Clock	2,292: 59	
Inventories and furniture	33,118: 12	
Architects and Experts	37,212: 50	
Office- and Administration expenses; taxes; interest and insurances	17,219: 84	
Sundries	8,151: 27	1,187,879: 97
Section for Athletics:		
Office charges	3,951: 52	
Trainer's salaries and travelling expenses	35,666: 65	
Travelling-, boarding-, and training expenses of Swedish competitors	32,894: 13	
Athletic apparatus, etc., and sundry inventories	11,109: 10	
Attendants and sundry expenses of the Marathon Race	2,508: 70	
Sundry expenses of competitions in the Games	4,097: 10	90,227: 20
	Carried Forward: Kronor	90,227: 20 1,988,418: 73

	Brought Forward: Kronor	90,227: 20	1,988,418: 73
Section for Cycling:			
Office expenses	2,466: 78		
Trainer's expenses	440: —		
Training expenses of Swedish competitors	5,696: 35		
Athletic materials and sundries	624: 05		
Sundry expenses during the Games.....	<u>3,528: 76</u>	12,755: 94	
Section for Fencing :			
Office charges	1,149: 73		
Trainer's salary	750: —		
Swedish competitors' training expenses...	304: 52		
Athletics materials and sundry inventories	2,237: 35		
Sundry expenses of competitions; stand etc.	<u>3,022: 19</u>	7,463: 79	
Section for Football:			
Office expenses	3,284: 12		
Trainer's salary and travelling expenses	2,838: 65		
Swedish competitors' training expenses	10,006: 15		
Athletic materials and sundry inventories	2, 132: 32		
Expenses of competitions; attendants; travelling, etc.....	<u>5,792: 46</u>	24,053: 70	
Section for Gymnastics:			
Office expenses	1,068: 33		
Swedish male gymnasts' training expenses	5,149: 87		
Women-gymnasts' do.	1,200: —		
Apparatus and sundry invent.....	8,424: 13		
Sundry expenses during Games.....	<u>5,310: 30</u>	21,152: 63	
Section for Horse Riding Competitions:			
Office and Administration charges; print- ing and representation	40,687: 89		
Expenses of training.....	24,301: 78		
Attendants; decorations and music	5,427: 47		
Accommodation charges	15,484: 81		
Expenses of competitions	<u>18,090: 06</u>	103,992: 01	
Section for Lawn Tennis:			
Office expenses	2,028: 42		
Trainer's salary and travelling expenses	1,950: —		
Training expenses.....	519: —		
Sundry materials and inventories.....	6,268: 98		
Stands, courts, etc.....	17,706: 42		
Sundry expenses for competitions	<u>2,647: 58</u>	31,120: 40	
Section for Modern Pentathlon:			
Office charges.....	654: 47		
Trainer's salary and travelling expenses	825: —		
Swedish competitors' training expenses	1,393: 95		
Materials and sundry inventories	155: 92		
Expenses of competition	<u>2,174: 64</u>	5,203: 98	
Section for Rowing:			
Office expenses	4,122: 14		
Trainer's salary and travelling expenses	3,716: 72		
Travelling-, training-, and boarding ex- penses of Swedish competitors.....	12,790: 38		
Materials and sundry inventories	7,633: 31		
Grand Stand	10,376: 17		
Expenses of competitions; hire of tents; attendants; music; tug-boats, etc.....	<u>12,458: 86</u>	51,097: 58	
	Carried Forward: Kronor	347,067: 23	1,988,418: 73

	Brought Forward: Kronor		347,067: 23	1,988,418: 73
Section for Army Rifle Shooting:				
Office charges	729: 49			
Training expenses	630: 35			
Sundry materials and inventories	185: 24			
Sundry expenses for competitions; targets; ranges, etc.	7,406: 96	8,952: 04		
Section for Clay Bird Shooting:				
Office expenses	396: 73			
Training expenses	1,140: 62			
Materials; clay birds and cartridges	2,835: 84			
Ranges	7,525: —			
Sundry expenses of competition	2,266: 94	14,165: 13		
Section for Miniature Rifle Shooting:				
Training expenses	318: 90			
Sundry materials and inventories	18: 45			
Expenses of competition; targets, etc. . .	2,279: 81	2,617: 16		
Section for Swimming :				
Office expenses; programmes and advertisements	9,370: 18			
Trainer's salary and travelling expenses	5,577: 09			
Training expenses of Swedish competitors	5,478: 21			
Materials and sundry inventories	3,984: 63			
Stands and sundry building arrangements	39,157: 39			
Expenses of competitions: attendants; music, etc.	5,323: 09			
Removal of stands	4,170: 74			
To Swedish Swimming Association, as per agreement	11,606: 44	84,668: 67		
Section for Tug-of-War :				
Office expenses ..	668: 35			
Training expenses	1,396: 63			
Materials and sundry inventories	344: 72	2,409: 70		
Section for Wrestling:				
Office expenses	826: 45			
Trainer's salary and travelling expenses	10,040: 20			
Training expenses of competitors	5,933: 56			
Materials and sundry inventories	3,219: —			
Sundry expenses during Games ..	3,369: 81	23,389: 02		
Section for Baseball:				
Materials and sundry inventories	385: 11			
Expenses of competition	306: 80	691: 91		
Section for Concours d'Art:				
Sundry expenses	2,390: 43	486,351: 29		
Cheque Acct., Cervin & Co., Bankers	1,302: 06			
General Secretariat:				
Balance according to A. C.	344: 45			
On Deposit	3,000: —	4,646: 51		
		Total: Kronor 2,479,416: 53		

C:a £136,082: \$680,410.

Summary of the above Accounts.

Income:

Funds and Grants	1,339,019: 97
Sale of tickets and Programmes for Stadium.....	699,171: 04
Sale of Tickets and Programmes, and sundry receipts, per the various Sections of the Games and the Horse Riding Committee	324,117: 96
For rights sold, and sundry receipts	117,107: 56
	Kronor 2,479,416: 53

Expenditure:

Expenses of Organization and Administration incurred by the Swedish Olympic Committee and the various sub-committees, together with the expenditure at the Stadium during the Games	629,179: 04
Training expenses, and expenditure of the various gymnastic and athletic sections, and of the Horse Riding Committee	486,351: 29
Råsunda Athletic Grounds	25,550: 43
Traneberg Athletic Grounds	9,800: —
Östermalm Athletic Grounds	136,009: 29
The Stadium:	
Cost of erection, inclusive of temporary stands; arena and running track; railing, garden and walks; inventories, etc.....	1,187,879: 97
Cash in hand on deposit	4,646: 51
	Kronor 2,479,416: 53

C:a £ 136,200: \$ 681,000: *Fres.* 3,405,000: *Mks* 2,775,000.

In addition to the above assets, amounting to Kr. 4,646: 51, the Finance Section has also at its disposal a total sum of 132,955: 31, on deposit-receipt, for the payment of the expenses incurred by the publication of the Official Report of the Games, etc.

Statistics

showing the number of paying Visitors present at the various competitions of the Olympic Games.

Fencing Competitions.

Total 1,010 persons paid.

Football Competitions.

	The Stadium.	Råsunda.	Traneberg.
Saturday, 29 June	5,357	560	231
Sunday, 30 »	3,397	1,445	239
Monday, 1 July	—	1,405	134
Tuesday, 2 »	4,374	—	—
Wednesday, 3 »	1,340	441	—
Thursday, 4 »	13,865	448	—
Friday, 5 »	—	628	—
	28,333	4,927	604

Total: 33,864 persons paid.

Horse Riding Competitions. (Stadium)

	Standing Places	North Stand	Other Seats	Total number of person with day-tickets
16 July	3,149	1,703	12,398	17,250
17 »	2,036	968	6,877	9,881
Total	5,185	2,671	19,275	27,131 persons paid.

Lawn Tennis Competition:

Covered Court competitions, May 5—12..... c/a 3,000
 Out-of-door » » June 28—July 5..... » 10,000

Total: 13,000 persons paid.

Rowing Competitions.

Number of persons with day-tickets, July 17 1,679
 » » » » » 18 1,722
 » » » » » 19 817

Total 4,218 persons paid.

Swimming Competitions.

Forenoon competitions, etc. 14,040
 Evening » 34,520

Total: 48,560 persons paid.

Track and Field events at the Stadium.

	Standing Places	North Stand	Other Seats	Total number of persons with day- tickets	Series Tickets	Total
6 July	382	3,086	4,563	8,031	5,622	13,653
7 » forenoon ...	410	98	350	858	5,622	6,480
» afternoon ...	3,641	288	3,115	7,044	5,622	12,666
8 » forenoon ...	274	226	1,201	1,701	5,622	7,323
» afternoon ...	1,381	531	2,907	4,819	5,622	10,441
9 » forenoon ...	214	104	314	632	5,622	6,254
» afternoon ...	1,379	633	2,496	4,508	5,622	10,130
10 » forenoon ...	103	369	819	1,291	5,622	6,913
» afternoon ...	2,044	3,100	3,511	8,655	5,622	14,277
11 » forenoon ...	79	439	618	1,136	5,622	6,758
» afternoon ...	1,110	2,145	3,298	6,553	5,622	12,175
12 » forenoon ...	180	892	1,378	2,450	5,622	8,072
» afternoon ...	1,796	2,374	3,508	7,678	5,622	13,300
13 » forenoon ...	186	601	1,008	1,795	5,622	7,417
» afternoon ...	3,854	3,357	4,423	11,634	5,622	17,256
14 » forenoon ...	255	49	2,870	3,174	5,622	8,796
» afternoon ...	3,723	4,031	5,337	13,091	5,622	18,713
15 » forenoon ...	210	30	550	790	5,622	6,412
» afternoon ...	2,957	540	3,350	6,847	5,622	12,469
Total	24,178	22,893	45,616	92,687	106,818	199,505

Grand Totals:

Fencing Competitions 1,010
 Football Competitions 33,864
 Horse Riding Competitions 27,131
 Lawn Tennis Competitions 13,000
 Rowing Competitions 4,218
 Swimming Competitions 48,560
 Track and Field events 199,505

327,288

CONCLUSION.

On looking back at the Olympic Games of Stockholm it is easily seen that they were much more comprehensive than they had ever been expected to become. A natural consequence of this was, that the work inseparable from them underwent a very considerable increase, while, at the same time, the expenses, in spite of every effort to keep them within bounds, were augmented to an unheard-of degree. The work of organizing and carrying-out the Olympic Games of Stockholm, which, with very few exceptions, was entrusted to committees, whose members, although unsalaried, showed, none the less, the warmest interest in their labours, made great demands on the willingness of these persons to offer both time and personal convenience in the cause they had promised to assist. The fact that it was found possible to carry the Games to a successful issue without the necessity of appealing to the generosity of private individuals for pecuniary help, must be considered a singularly fortunate circumstance, for which we have to thank the readiness of the Swedish Central Association for the Promotion of Athletics to place at the disposal of the Swedish Olympic Committee (with the permission of the Government), the considerable amount of about 800,000 Kronor (£ 44,400: \$ 222,000) of the funds acquired by the Central Association by means of the Athletic Lottery.

The experience of the Fifth Olympiad most incontestably shows, that, to carry out the Olympic Games of the present day, there are required not only personal effort on the part of the organizers, but also the most ample financial resources.

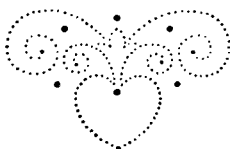

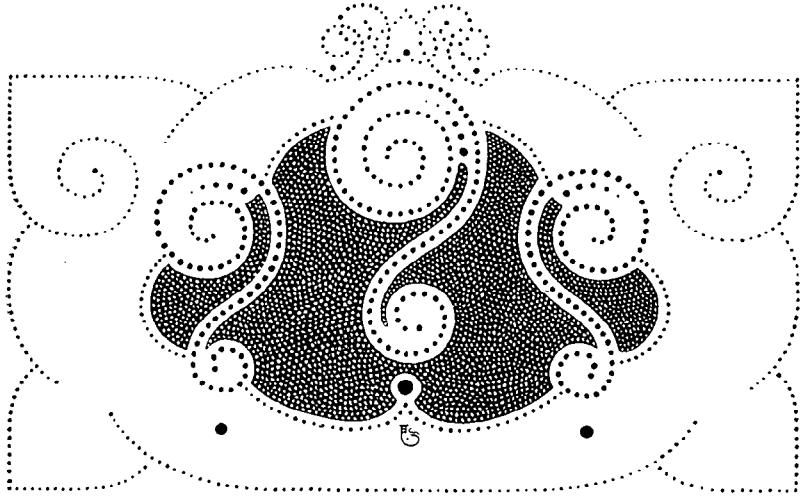

GENERAL QUESTIONS.

THE PROGRAMME OF THE FIFTH OLYMPIAD.

THE ORIGINAL PROGRAMME AND ITS ORIGIN.



At the Meeting of the International Olympic Committee, held in Berlin, May 27—31, 1909, the Swedish delegates brought forward the proposal that there should be adopted a normal (standard) programme for future Olympic Games. The Swedish motion aimed also at the restriction of the programme, as a whole, to *pure athletics*,* *wrestling*, *gymnastics* and *swimming*, or, in other words, to such branches of athletics as, from their very character, are accessible to all, and which would not, by being specially adapted to one nation in particular, confer any advantage in one direction or another.

But while the International Committee, as such, did not express any direct opinion on this question of principle, there were present at the Congress eager advocates for the inclusion in the programme of other branches of athletic-sport, such as *fencing*, *yachting* and *rowing*. On the other hand, the opinion was expressed that football, motor-racing and cycling were unsuitable, with the exception, perhaps, of long distance cycle-racing on ordinary roads.

It was on the basis of these opinions that the Swedish Olympic Committee was to draft a programme to be laid before the International Olympic Committee at its Meeting at Luxemburg, in June, 1910.

On the 11 October, 1909, the Swedish Olympic Committee resol-

* Field and track events.

ved that *pure athletics, fencing, gymnastics, swimming and wrestling* should, as a matter of course, find a place on the programme, and requested the Swedish National Association of the Swedish Gymnastic and Athletic Clubs to take steps to have special committees elected for these branches of athletic sport.

On January 26, 1910, a proposal was made at a meeting of the Swedish Olympic Committee, that, in addition to these five branches of athletics, the adoption of which had already been decided on, as forming the programme proper of the so-called Olympic Week, *yacht racing, skating, lawn tennis, shooting, horse riding* competitions and *cycle road-racing* should also be placed on the programme, the competitions in these branches to be carried out in connection with the Olympic Week, and either immediately before or after the Games. It was determined to write to the respective Swedish Associations or Clubs for yacht racing, lawn tennis, shooting and horse riding, requesting them to state their opinion on the matter and, if possible, to send in a plan for the competitions referred to.

On February 7 the question of including skating in the programme of the Olympic Games was again debated, the Swedish Olympic Committee then coming to the unanimous decision that the step proposed would be a somewhat unsuitable one, as there are, of course, other branches of winter sport that would, in such a case, be equally entitled to a place on the programme, and also because the "Northern Games", which have now become a regular institution, and which were to be next held in February, 1913, the year after the Olympic Games, could be considered as in some measure supplying the place of the latter athletic festival as far as winter sports were concerned.

The Swedish Olympic Committee resolved, on the other hand, to include *horse riding, lawn tennis, yachting and shooting* in the draft programme that it intended to lay before the International Olympic Committee at its next meeting.

On February 14, 1910, the question was brought forward and discussed, of the arrangement of a *concours d'art*. No definite resolve was come to at this meeting, however, but it was decided to make further inquiries respecting the conditions that would have to be laid down for such a competition. These inquiries showed that the arrangement of the proposed *concours* would be a matter of the utmost difficulty. The International Committee, itself, however, took the necessary steps for holding the said competition in connection with the Fifth Olympiad, and a detailed account of the matter is given at another place in this book.

But propositions were made from various quarters respecting the groups of athletics already placed upon the draft-programme, and this led to the amplification of the detail-programmes drawn up by the special committees, this step being taken by the Swedish Olympic Committee on the 6 of June, 1910. For example, *water-polo, the tug-of-war, a cycle road-race, cross country running and pentathlon* were included in the draft programme, while, on the other

hand, *boxing*, *lacrosse*, *rackets*, *hockey*, *polo* (on horseback), *motor-boat racing* and *cycle track-racing*, all of which had formed part of the programme of the Olympic Games of 1908, were definitely excluded, as well as *skating* and *football*, which had already been excised at a previous meeting.

In accordance with the above-mentioned resolution, the draft programme that was to be laid before the Meeting at Luxemburg, was as follows:

Athletics; (track and field events):

Running. 100, 200, 400, 800, 1,500, 5,000 and 10,000 metres; the Marathon Race, 40,200 metres; hurdles, 110 metres; cross country race, 8,000 metres; relay races, 400 metres (4 men, each running 100 metres) and 1,600 metres (4 men, each running 400 metres), and a team race, 3,000 metres (5 starting in each team; 3 to count points).

Jumping. High jump and broad jump (running and standing); hop, step and jump; and straddle-jump (across vaulting-horse).

Throwing. Throwing the javelin (javelin held in the middle); throwing the discus (free and "classic" styles), and putting the weight; all of these to be with best hand, and right and left hands; throwing the hammer.

Combined competitions. The Pentathlon, consisting of broad jump, throwing the discus (free style); throwing the javelin (free style), running 200 and 1,500 metres. The latter race was instead of the final competition, wrestling, in the pentathlon of the Athenian Games.

The *Decathlon*, or ten-event competition, consisting of: (1:st day); 100 metres Flat, broad jump, putting the weight, high jump, and 400 metres Flat; (2:nd day): hurdles, 110 metres; throwing the discus, throwing the javelin, pole-jump, and 1,500 metres.

Tug- of- War. Teams, 8 men strong.

Cycle road-race. Distance not then fixed.

Fencing. Individual and team competitions with épée and foil, and individual competition with sabre.

Gymnastics. Individual competitions, and team-displays.

Swimming. 100, 400 and 1,500 metres, free style; 200 and 400 metres breast-stroke; 100 metres back stroke; 800 metres team race (4 men, each 200 metres); spring-board diving and high diving. Water-polo, teams of 7.

Wrestling Graeco-Roman, divided into 5 weight-classes.

<i>Horse Riding competitions.</i>	} The programme was not then determined.
<i>Lawn Tennis.</i>	
<i>Shooting.</i>	
<i>Yacht Racing.</i>	

With regard to the *walking race*, the Swedish Olympic Committee determined to keep to an earlier resolution, according to which, the branch of athletics in question was to be eliminated as a matter of principle, unless the International Olympic Committee, at its Meeting at Luxemburg, absolutely insisted on its retention. The Swedish representatives at the Meeting, were instructed, however, to point out to the International Committee the difficulties connected with such

a competition, especially as regards the ability of the judges to decide with perfect equity in the question of "fair walking".

As regards the individual and team competitions in gymnastics, the Swedish Olympic Committee determined, out of principle, to replace *team competitions in gymnastics* by *team displays*, but it resolved, at the same time, to refer the question of women taking part in the displays, to the Meeting at Luxemburg. It was resolved, however, to arrange the *individual competition in gymnastics*.

The question of a competition in *clay bird shooting* was also referred to the Meeting, and the Swedish representatives were instructed to state that the Swedish Olympic Committee, was ready to arrange such a competition if so desired, but that the question had not yet been thoroughly gone into.

Finally, as regards *rowing*, the Swedish Olympic Committee determined not to place competitions in this branch of athletics on the programme for the present, but that, in the event of the Luxemburg Meeting positively insisting on such competitions being held, the Swedish delegates were to state that they were ready to comply with this wish, if all difficulties could be overcome.

The question of the *Modern Pentathlon* was deferred for the time being, until the opinion of the Meeting could be had.

Respecting the question of the most suitable time for holding the Olympic Games of 1912, the Swedish Olympic Committee unanimously declared for the second week in July.

Concerning the programme as a whole, the Swedish Olympic Committee resolved to determine, temporarily:

a) that the competitions in lawn tennis and shooting should be held *before* the "Week" proper;

b) that the competitions in athletics, tug-of-war, cycling, fencing, gymnastics, swimming, and wrestling, should take place during the Week itself;

c) that the horse riding competitions and the yacht racing should be held immediately after the close of the Olympic Week.

The draft=programme of the Swedish Olympic Committee and the Meeting at Luxemburg, June, 1910.

The programme drawn up by the Swedish Olympic Committee was not adopted by the Luxemburg Meeting, but was returned to the Committee with the following statement:

Athletics. The programme here was accepted in its entirety, and the Meeting expressed its approval of the so-called "free style" alone being adopted for the discus throwing competition, and of the "classic" Grecian style being omitted. The principle of the throwing competitions being divided into "best hand", and total of both right and left hand throw, was approved of. As regards "throwing the javelin", the Congress desired the so-called "free style", i. e., free grasp of the javelin, to be included in the programme. Great Britain proposed the inclusion of a walking match, 10,000 metres. A majority of those present at the Meeting was in favour of the Swedish proposal to replace wrestling in the Pentathlon, by

the 1,500 metres flat. No resolve was come to respecting the adoption of the Decathlon.

In addition to the above, the arrangement of a cross-country race of about 5 English miles was recommended, while, as regards the straddle jump (with vaulting horse), it was stated that such a competition could very suitably be transferred to the individual gymnastic competition.

The Marathon Race. Count Brunetta d'Usseaux reminded the Meeting of the painful impression that the entry into the London Stadium in 1908 of his countryman, Dorando caused in consequence of his exhausted condition, and the Count therefore asked the Swedish Olympic Committee to make the following regulations for the competition in question:

1) No one shall be allowed to accompany the competitors, either in motor-cars, on cycles, or on foot.

2) A strict watch shall be kept along the whole of the course to prevent any of the competitors interfering with, or in any other way hindering, a fellow-competitor, at the risk of disqualification.

3) As many places as may be necessary shall be arranged, where refreshments may be had. The *chief attendants* at these places shall be exclusively Swedes, whose *assistants* — Swedish runners —, shall have the task of running in company with the competitors for some few hundred metres, for the purpose of supplying the men with the refreshments they may require.

4) It is forbidden for any person other than a member of the International Olympic Committee of the same nation as a competitor to accompany the latter on to and up the running track at the Stadium; should the competitor fall and be assisted to rise, the competitor in question shall be disqualified.

5) No doctor may assist a fallen competitor or express an opinion as to his condition unless with the assistance and under the control of a delegate, (or, still better, of a member of the International Olympic Committee) of the nation to which the competitor belongs.

The Tug-of-War. Competition approved of.

Gymnastics. The Swedish principle that there shall be no team competitions but only team displays, was not approved of; the Meeting expressed its wish to have a competition, with liberty for those nations that so desired, to give a display instead of taking part in the competition. The Swedish proposal with regard to individual competition was approved of.

The Cycling Competition. Several voices were raised on behalf of a track race, but the Meeting resolved unanimously to decide in favour of a cycle road-race only, as proposed by the Swedish Olympic Committee.

Wrestling. Great Britain and the U. S. A. proposed the placing of the 'Catch-as catch-can' style of wrestling on the programme, but the Meeting decided to approve of the Swedish plan, which allows of nothing but Graeco-Roman wrestling, with five weight-classes.

Fencing. The Swedish scheme was adopted, with the addition of a team sabre competition.

Lawn Tennis. Regarding lawn tennis it was resolved that ladies' competitions ought to be added to the programme. Both covered court and out-of-door competitions were asked for.

Swimming. Ladies' Competitions were proposed from various quarters.

Shooting. No special expression of opinion was made with regard to these competitions, but a proposal was brought forward for the adoption of a short distance shooting competition.

Yacht Racing. The adoption of the Swedish scheme was recommended.

Horse Riding Competitions. The principle was adopted that there should be no money-prize or any prize of monetary value.

Rowing. The Meeting expressed its decided opinion that rowing should find a place on the programme of the Games.

Football. Norway urged the adoption of a football competition, but the Meeting expressed no decided opinion in the matter.

Boxing. Great Britain urged that boxing should be placed on the programme.

The *Modern Pentathlon* was agreed to in principle. The adoption of the following branches was recommended: 1) steeple-chase, 2) shooting, 3) swimming, 4) riding, 5) some personal contest, either fencing, boxing or wrestling.

Concours d'art. The proposer of this competition, Baron de Coubertin, exhorted the Swedish Olympic Committee in the warmest terms to place this competition on the programme, and referred to the decision in this direction that had been come to at an earlier date by the International Olympic Committee.

Other details. As regards other details of the programme, the representatives of Great Britain expressed some apprehension respecting the employment of Sundays for athletic competitions, as many British sportsmen would, most certainly, abstain from taking part in competitions on that day. The matter was referred to the Swedish Olympic Committee for decision.

The principles laid down by Sweden respecting the appointment of the judges and the sending in of entries, was approved of by the Congress.

ADDITIONS AND ALTERATIONS.

In consequence of the above expressions of opinion made by the Meeting at Luxemburg, the Swedish Olympic Committee resolved to once more discuss the question of the programme:

On the 8 of August, 1910, *rowing* was definitely placed on the programme of the Games.

The desirability of including *football* in the programme was emphasized from several quarters, especially as it would be possible to arrange the competition during the same week as that when the shooting and lawn tennis competitions were to be held, viz., June 30—July 6. After a thorough investigation of the matter, the Swedish Olympic Committee finally determined to include this branch of sport in the draft-programme that was to be laid before the International Olympic Committee's Meeting at Buda-Pesth, in May, 1911.

From the Russian Olympic Committee there was received a letter, dated March 30, 1910, proposing the inclusion of a *weight lifting* competition in the programme. The proposal was negated at the Meeting at Buda-Pesth.

In consequence of the wished expressed at the Luxemburg Meeting, the detail-programme for the *Swimming* competition was amplified as to include a *100 metres' race for ladies* and a *ladies' high diving competition*.

Gymnastics. The Swedish Olympic Committee also determined to comply with the wished expressed by the Luxemburg Meeting, and to add *team competitions in gymnastics* to the programme, and to divide these team competitions into two different groups: 1. *Gymnastics according to Ling's system*; 2. *Gymnastics based on any other system*.

A written proposal, dated April 29, 1911, was received from the Danish Olympic Committee, concerning the inclusion of *boxing* in the programme, but the Swedish Olympic Committee considered that it ought to maintain its previous stand-point, and not add the sport in question to the number already adopted, boxing not being practised in Sweden and it being an absolute impossibility to obtain suitable judges and officials for the proper carrying-out of the proposed competition.

Baron Pierre de Coubertin had made a proposal that, apart from the Olympic Games proper, there should be awarded Olympic gold medals to those persons that, since the previous Olympiad, had performed the greatest feat in *Mountain Ascents*, *Game Shooting* and *Aeronautics*. The Technical Section, after investigating the matter, recommended the adoption of the proposal as far as game shooting and mountain ascents were concerned. Respecting aeronautics, however, the Section considered that it was not desirable to place it on the programme, partly because the branch of sport in question is, at present, in an early stage of development, and partly because aeronauts themselves, unlike hunters and mountain-climbers, are, in general, professionals, and the best aeronautical feats will, undoubtedly, always be performed by professional airmen.

The Swedish Olympic Committee determined, therefore, on February 20, 1911, to award, apart from the Games proper, the Olympic gold medal to the person or the persons that had performed the greatest feats in mountaineering and in game shooting since May, 1908; Baron Coubertin's proposal to make a similar award for aeronautics was, on the other hand, negatived.

According to the regulations determined on in connection with this resolution, a gold medal was to be awarded to the person or persons who, during the years 1908—1911 had performed the greatest feats in mountain ascents and in game shooting. The leading Alpine- and shooting associations in the various countries should have the right of entering candidates for the prizes, the entries to be in the hands of the Swedish Olympic Committee not later than March 1, 1912; and should contain an account and full details of the feats in question, together with special reference to such circumstances as might be considered as entitling the competitors to a prize.

The prize-judging was to be carried out by two different juries, one for shooting and one for mountain ascents, both appointed by the Swedish Olympic Committee. The decisions of the juries were to be

given in writing, and were to be in the hands of the Swedish Olympic Committee not later than June 1, 1912.

A decision was come to in good time regarding a number of questions connected with the drawing up of the programme. For example, as early as December, 1910, the principle was adopted of fixing one month before the date of the beginning of any competition as the time for the close of *entries* for the event in question. This time could be shortened, however, in certain exceptional cases, if the Swedish special committee concerned applied for this step to be taken.

Respecting the *maximum number of competitors* in each branch of athletics (in general) that could be entered by each nation, the rule was made — also before the close of 1910 — that no more than 12 persons could be entered for individual competitions, and no more than 1 team for team competitions.

With the additions thus made to the draft-programme after the Luxemburg Meeting, in 1910, there was laid before the Meeting of the International Olympic Committee, at Buda-Pesth, in May, 1911, a fresh draft, based, however, on that presented to the Luxemburg Meeting. This new scheme had been sent to the members of the International Committee and to the Olympic Committees of the various countries before the Buda-Pesth Meeting was held.

Wishes expressed by the International Olympic Committee,
at the Meeting at Buda=Pesth, May, 1911.

After considering the draft-programme laid before the Meeting of the International Olympic Committee at Buda-Pesth by the Swedish representatives, the International Committee made the following report :

Straddle Jump. (with vaulting horse). Removed from programme.

Throwing with both the right and left hand. By 10 votes to 8, the Meeting expressed its wish that there should be no competition with the results of both left and right hand reckoned together.

Cycling. Great Britain proposed the adoption of an individual 100 kilometres road race instead of the 100 kilometres track-race held at the London Games. No resolution was come to.

Football. The Congress voted in favour of Great Britain's proposal that each nation should be permitted to enter 4 teams for this competition.

Gymnastics. Norway proposed a competition in one class only, with an international jury. The Congress, however, expressed its approval of the Swedish plan.

The Modern Pentathlon. On the proposal of Great Britain it was resolved that those competitors in the Modern Pentathlon that could not bring their on-n horses to the Games, should have others placed at their disposal by the Swedish Olympic Committee. The wish was also expressed that the distance for the cross country race should be diminished.

Swimming. Great Britain proposed the addition to the programme of some more events for ladies. Hungary proposed the following competitions: 200 metres

race, free style; 800 metres race, free style; 100 metres, breast stroke; 200 metres team race (4 men, each taking 50 metres; one man breast stroke, the second, back stroke, the third, side stroke and the fourth, free style); 400 metres team race (4 men, each 100 metres), any style.

The Meeting came to no decision in the matter.

Shooting. Great Britain proposed the inclusion of a 250 metres Running Deer competition. The Meeting made no decision in the matter.

Boxing. The Meeting expressed the wish that boxing might be included in the programme, and regretted that the Swedish Olympic Committee thought that it would be prevented from including boxing in its programme for the Fifth Olympiad, more especially as the sport in question was of such great educational importance.

Weight Lifting competition. Russia's representative proposed the inclusion of a weight lifting competition. The Meeting negated the adoption of this resolution.

Hockey. Great Britain proposed that hockey should be added to the programme. The Meeting adopted no resolution in the matter.

Winter Sports. The Italian representative proposed that winter sports should be placed on the programme, ski-running in particular, this being of great military importance. The Meeting was of the opinion, however, that winter sports should not be included.

The Arrangement of the Preliminary Heats. The representative of the U. S. A. begged the Swedish Olympic Committee to so arrange the preliminary heats that the principal competitors of each nation should, as far as possible, be placed in different heats. He also proposed that the trial heats in the various competitions should come off as close after each other as possible, so that, consequently, they might be held under somewhat similar conditions of wind and weather, etc. He also hoped that the second man in each trial heat would be entitled to take part in the succeeding heat.

The holding of competitions on Sundays. The representative of the U. S. A. begged the Swedish Olympic Committee to consider whether it would not be possible to have no competitions on Sundays, and to arrange displays or, eventually, trials on that day, as otherwise there would be a danger of some of the best competitors being prevented, on religious grounds, from taking part in the contests.

THE FINAL PROGRAMME.

The following alterations were made in the draft programme, in accordance with the wishes expressed by the Buda-Pesth Congress.

The Straddle jump: (with vaulting horse): Omitted.

Football: Each nation allowed to enter 4 teams.

Gymnastics: The time for sending in the lists of the apparatus that the various teams might wish to have at their disposal in the Stadium, was extended to January 31, 1912. In addition to this, the principle was laid down, that the same team was entitled to take part in both classes of competitions.

Lawn Tennis: In consideration of the heat that prevailed, the lawn tennis competitions were changed to out-of-door competitions, at the date previously

fixed. The question of having covered court competitions, too, was laid on the table.

The Modern Pentathlon: Horses were to be placed at the disposal of those competitors that did not bring their own mounts. Applications from such competitors as did not intend to bring their own horses, should, however, be in the hands of the Swedish Olympic Committee not later than April 1, 1912. The distance for the cross country run was diminished from 6,000 to 4,000 metres.

Rowing: The members of any one boat-crew need not necessarily be members of one and the same club.

Swimming: In accordance with the opinion of the International Swimming Federation (Fédération Internationale de Natation Amateur), the swimming programme was lengthened by the addition of the following events: high plain diving for men, ladies' team race, 400 metres (4 ladies, each 100 metres).

Shooting: Great Britain's proposal to add to the programme a competition in *Running Deer Shooting at 250 metres* was not adopted.

A detailed, general programme was posted to the various nations in June 1911; it was printed in four editions: English, French, German and Swedish.

After the Swedish Olympic Committee had determined to retain *lawn tennis covered court competitions* on the programme, and to hold them between May 5—12, 1912, and also to make some other alterations, such as, for example, that the *team competition in gymnastics should be divided into three classes*, the General Programme was, definitely, as follows :

GENERAL PROGRAMME.

Athletics.

In the Stadium, Saturday, July 6th—Monday, July 15th, 1912.

Entries close June 6th, 1912.

I. INDIVIDUAL EVENTS.

Max. number of competitors from each nation in each event: 12.

100 metres Flat.

200 » »

400 » »

800 » »

1,500 » »

5,000 » »

10,000 » »

Marathon Race (40,200 metres = abt. 25 miles).

Hurdle Race, 110 metres.

Walking Race, 10,000 metres.

Running High Jump.

standing » »

Running Broad Jump.

Standing » »

Hop, Step, and Jump.

Pole Jump.

Throwing the Javelin (with the Javelin held in the middle), best hand.
Throwing the Javelin (with the Javelin held in the middle), right and left hand.

Throwing the Discus, best hand.

Throwing the Discus, right and left hand.

Putting the Weight, best hand.

Putting the Weight, right and left hand.

Throwing the Hammer

Pentathlon, comprising:

1. Running Broad Jump.
 2. Throwing the Javelin (with the Javelin held in the middle), best hand.
 3. 200 metres Flat.
 4. Throwing the Discus, best hand.
 5. 1,500 metres Flat.
- } July 7th.

Decathlon, comprising:

1. 100 metres Flat.
 2. Running Broad Jump.
 3. Putting the Weight, best hand.
 4. Running High Jump.
 5. 400 metres Flat.
- } July 14th.
6. Hurdle Race, 110 metres.
 7. Throwing the Discus, best hand
 8. Pole Jump.
 9. Throwing the Javelin (with the Javelin held in the middle), best hand.
- } July 15th.
10. 1,500 metres Flat.

II. TEAM COMPETITIONS.

Max. number of Teams from each nation in each event: 1 team.

Relay Race, 400 metres.

Teams of 4, each man to run 100 metres, with max. 2 reserves.

Relay Race, 1,600 metres.

Teams of 4, each man to run 400 metres, with max. 2 reserves.

Team Race, 3,000 metres.

5 to run, 3 to count. Max. 3 reserves. The team having the lowest aggregate of points will be declared the winner. In the event of a tie, the total time taken by the three men scoring of each team shall decide.

Tug-of-War. Team of 8.

Max. 4 reserves. Teams may not be captained by anyone who is not a member of the team.

III. COMBINED INDIVIDUAL AND TEAM COMPETITION.

Cross Country Race, about 8,000 metres.

Simultaneous start. Start and finish in the Stadium.

The race is partly individual, partly a team race.

Max. number of competitors from each nation: 12.

The team competition will be so arranged that the best three from each nation will be considered as forming a team, the aggregate place-numbers for these three deciding the relative order of the teams. In the event of a tie, the total time taken shall decide.

Cycling Road Race.

Round Lake Mälär.

About 320 kilometres (198 miles).

Sunday, July 7th, 1912, 2 a. m.

(the night between Saturday and Sunday).

Competitors start singly at intervals of 3 minutes.

Entries close June 7th, 1912.

The competition is only open to amateurs provided with a license from the Union Cycliste Internationale or any Association affiliated to the above-mentioned Union. A certified copy of such license shall accompany each entry.

The race is partly individual, partly a team race.

Max. number of competitors from each nation: 12.

The team competition will be so arranged that the four from each nation will be considered as forming a team, and the total time taken shall decide.

Fencing.

Saturday, July 6th—Monday, July 15th, 1912.

Entries close June 6th, 1912.

Max. number of competitors from each nation:

In the individual events: 12.

In the team events : 1 team.

I. Foils.

Individual.

II. Épée.

International teams of 8, out of whom any 4 fencers may be chosen for each series.

III. Épée.

Individual.

IV. Sabre.

International teams of 8, out of whom any 4 fencers may be chosen for each series.

V. Sabre.

Individual.

Football.

(Association).

Saturday, June 29th—Friday, July 5th, 1912.

Entries close May 29th, 1912.

Each national Football Association belonging to a nation recognized as such by the International Olympic Committee and affiliated to the International Football Federation (Federation Internationale de Football Association) is entitled to send four teams (of eleven men each).

A number of reserves, not exceeding 22, may be entered.

A statement as to the definitive compositions of the team must be in the hands of the Swedish Olympic Committee on June 20th, 1912, at the latest.

The competition shall be conducted on the CupTie system. (elimination system, after the drawing of lots.)

Gymnastics.

In the Stadium, Saturday July 6th—Monday, July 15th, 1912.

Entries close June 6th, 1912.

Max. number of competitors from each nation:

In the individual competition: 6.

In each of the team competitions; 1 team.

- I. **Team competition with exercises according to the Swedish system.**
Teams of not less than 16 nor more than 40.
Time limit, 1 hour.
- II. **Team competition with exercises according to special conditions.**
Teams of not less than 16 nor more than 40.
Time limit, 1 hour.
- III. **Team Competition with free choice of movements and apparatus.**
Teams of not less than 16 nor more than 40.
Time limit, 1 hour.
- IV. **Individual Competition** with exercises on horizontal bar, parallel bars and other fixed apparatus.
- V. **Displays.**

Non-competitive displays in which each nation may be represented by one team of men and one team of ladies.

All the members of such teams will receive Commemorative Medals.

Time limit, 45 minutes.

A statement as to the apparatus which will be brought by, or required to be placed at the disposal of, the various teams, should be forwarded to the Swedish Olympic Committee, at the latest, by May 1st, 1912.

Stationary apparatus will, as far as possible, be procured by the Swedish Olympic Committee.

Horse Riding Competitions.

Saturday, July 13th—Wednesday, July 17th, 1912.

Entries close June 1st, 1912.

Max number of competitors from each nation:

In individual events: 6 (with max. 3 reserves);

In team events, and

In the combined team and individual competition: 1 team of 4 (with max. 2 reserves), 3 to count.

Each competitor may enter max. 2 horses, but may ride only one and the same horse in the same event.

- I. **“Military”.** Combined team and individual competition, comprising:

1. Distance Ride, 55 kilometres (ca 34 miles), of which 5 kilometres (ca:3 miles) is a
2. Cross Country Ride.
3. Individual Steeple-chase Ride.
4. Prize Jumping.
5. Prize Riding.

- II. **Prize Riding.**

Individual competition.

- III. **Prize Jumping.**

A. Individual competition.

B. Team competition.

Lawn Tennis.

I. COVERED COURTS.

Sunday, 5th—Sunday, 12th May, 1912.

Entries close April 5th, 1912.

II. OUT-OF-DOOR COURTS.

Saturday, June 29th — Friday, July 5th, 1912.

Max. number of competitors from each nation:

In the Singles: 8.

In the Doubles: 4 pairs.

Programme for both Competitions:

I. Gentlemen's Singles.

II. Ladies' Singles.

III. Gentlemen's Doubles.

IV. Mixed Doubles.

Modern Pentathlon.

Sunday, July 7th—Thursday, July 11th, 1912.

Max. number of competitors from each nation: 12.

The competition comprises the following events:

I. Duel-Shooting, distance 25 metres. 20 shots in 4 series of 5 shots each. 2 sighters. Target, whole-figure, 1.7 metre high, divided into zones. The target will be visible 3 seconds, with an interval of 10 seconds between each shot. Weapon, any revolver or pistol with open fore- and back-sight.

II. Swimming, 300 metres, free style.

III. Fencing. Weapon: Épée.

IV. Riding singly over a special, marked course, not exceeding 5,000 metres. Horses may be provided by the competitors themselves or will, if desired, be supplied by the Swedish Olympic Committee.

Competitors not providing horses themselves shall clearly state so at the time of entering.

V. Cross Country Race, ca. 4,000 metres. Competitors start singly, at intervals of 1 minute. Start and finish in the Stadium.

One day will be reserved for each event in the order stated above.

The relative order of the prize-winners will be determined by points corresponding to the place-numbers in the five events, the number of victories (or best relative places) deciding in case of any prize-winners obtaining the same number of points.

Rowing.

Thursday, July 18th—Friday, July 19th, 1912.

Entries close May 18th, 1912.

Max. number of entries from each nation in each event: 2 boats.

A statement as to the definite composition of the crews must be in the hands of the Swedish Olympic committee at the latest by July 1st, 1912.

Length of course in all events: 2,000 metres (abt. 1 $\frac{1}{4}$ miles).

I. Eights, outriggers (best boats) with cox.

II. Fours, » » » » »

5 Fifth Olympiad.

III. Fours, inriggers, sliding seats, with cox, in accordance with the Swedish Rowing Association's special definition, which will be found under the Special Rules.

IV. Single Sculls.

Shooting.

Saturday, June 29th —Friday, July 5th, 1912.

Entries close May 29th, 1912.

Max. number of competitors from each nation:

In each of the individual competitions: 12.

In each of the team competitions: 1 team.

I. ARMY RIFLE SHOOTING

The National Military weapon of each country according to adopted model, without any alteration or addition.

- a. **Team competition** ("International"). Distances 200, 400, 500 and 600 metres.
Teams of 6, with max. 3 reserves. 2 sighters and 15 shots at each range.
- b. **Individual competition.** Distance 600 metres.
5 sighters and 20 shots.
- c. **Individual competition.** Distance 300 metres.
20 shots in 2 series
1 series of 10 shots (4 lying down, 4 kneeling, and 2 standing), at stationary target, 140 x 170 centimetres, divided into 5 zones. Time limit, 3 min. 2 sighters.
1 series of 10 shots (5 lying down and 5 kneeling) at a half-figure. Time limit, 3 min. No sighters.

II. SHOOTING WITH ANY RIFLE.

Fore- and back-sight open.

- d. **Team competition.** Distance 300 metres.
Teams of 6, with max. 3 reserves. 120 shots (40 standing, 40 kneeling, and 40 lying down). 10 sighters in each position.
- e. **Individual competition.** Distance 300 metres.
120 shots (40 standing, 40 kneeling, and 40 lying down). 10 sighters in each position.

III. MINIATURE-RIFLE SHOOTING.

Any breech-loading rifle, with calibre not exceeding 6 mm., using miniature ammunition intended for competition.

Any fore- and back-sight, except magnifying or telescopic.

- f. **Team competition.** Distance 50 metres.
Teams of 4, with max. 2 reserves. 40 shots in 4 series of 10 shots each. 4 sighters.
Target: white, with black bull's-eye.
- g. **Individual competition.** Distance 50 metres.
Same regulations as for f.
- h. **Team competition.** Distance 25 metres.
Teams of 4, with max. 2 reserves. 25 shots in 5 series of 5 shots each. 2 sighters. Target (disappearing): reduced whole-figure, 12 centimetres high, divided into zones. The target will appear 25 times, each time for 3 seconds, with intervals of 5 seconds between the appearances.
- i. **Individual competition.** Distance 25 metres.
Same regulations as for h.

IV. REVOLVER AND PISTOL SHOOTING.

Any revolver or pistol with open fore- and back-sight.

Ammunition with metal cartridge-case.

j. Team competition. Distance 50 metres.

Teams of 4, with max. 2 reserves. 60 shots in 10 series of 6 shots each. 2 sighters. Target: white, 50 centimetres in diam., divided into 10 zones, $2\frac{1}{2}$ centimetres between each, counting from 1 to 10. Bull's-eye black, 20 centimetres in diam. Position: standing, right or left hand, with arm extended.

k. Individual competition. Distance 50 metres.

Same regulations as for j.

l. Duel-Shooting. Team competition. Distance 30 metres.

Teams of 4, with max. 2 reserves. 30 shots in 6 series of 5 shots each. 2 sighters. Target: whole-figure, 1.7 metre high, divided into zones: The target will appear 30 times, each time for 3 seconds, with intervals of 10 seconds between the appearances. Starting position: arm stretched downwards, the muzzle turned towards the ground.

m. Duel-Shooting. Individual competition. Distance 30 metres.

Same regulations as for l.

V. CLAY BIRD SHOOTING.

n. Team Competition. Teams of 6, with max. 3 reserves.

3 stages.

1st stage: Teams shoot at 20 birds per man in 2 rounds.

2nd » » » » » » » » » »
3rd » » » » » » » » » »

o. Individual competition.

3 stages.

1st stage: Teams shoot at 20 birds per man in 2 rounds.

2nd » » » » » » » » » 2 »
3rd » » » » » » » » » 4 »

VI. RUNNING DEER SHOOTING.

Rifles of any construction and calibre.

p. Team competition. Distance 100 metres. Single shots. Teams of 4, with max. 2 reserves. 10 shots, one at each run. 2 sighters. Any position.

q. Individual competition. Distance 100 metres. Single shots. Same regulations as for p.

r. Individual competition. Distance 100 metres. Double shot. 20 shots, 2 at each run. 2 sighters. Any position.

Swimming.

Saturday, July 6th—Monday, July 15th, 1912.

Entries close June 6th, 1912.

I. INDIVIDUAL EVENTS.

Max. number of competitors from each nation in each event. 12.

A. For Men.

1. 100 metres, free style.
2. 100 » back stroke.
3. 200 » breast stroke.
4. 400 » free style.
5. 400 » breast stroke.
6. 1,500 » free style.
7. **High Diving.** Plain Diving from heights of 5 and 10 metres.
8. **High Diving.** Plain and Variety Diving combined, from heights of 5 and 10 metres.
9. **Spring-board Diving.**

B. For ladies.

1. 100 metres, free style.
2. **High Diving.** Plain Diving from heights of 5 and 10 metres.

II. TEAM EVENTS.

Max. number of teams from each nation in each event: 1 team.

A. For Men.

1. 800 metres **Team Race.** Teams of 4, each to swim 200 metres. Free style. Max. 2 reserves.
2. **Water Polo.** Teams of 7, with a sufficient number of reserves.

B. For ladies.

- 400 metres **Team Race.** Teams of 4, each to swim 100 metres. Free style.
Max. number of reserves: 2.

Yacht Racing.

In connection with the Olympic Games, THE KUNGL. SVENSKA SEGEL-SÄLLSKAPET (Royal Swedish Yacht Club)

will hold an International Yacht Racing Week at Stockholm,

the **Olympic Races** being sailed on Saturday, July 20th,
Sunday, July 21st. and Monday, July 22nd,
over courses at Nynäshamn.

Entries close June 20th, 1912.

The classes for which races will be arranged are those of

6 metres
8 »
10 »
12 »

Max. number of yachts from each nation in each class: 2 yachts.
(No entrance fee.)

GENERAL REGULATIONS

for the Yacht Racing.

The Races will be held under the International Racing and Measurement Rules. The helmsman and every member of the crew of each yacht must be an amateur. In each class, there will be 2 races, with the following method of scoring:

1st place = 7 points
2nd » = 3 »
3rd » = 1 »

and, if necessary, an extra race between yachts with the same number of points.

Wrestling.

Saturday, July 6th—Monday, July 15th, 1912

Entries close June 6th, 1912.

Graeco-Roman style. 5 weights :

- a) Feather weight up to 60 kilos (c:a 132 lbs.)
- b) Light weight » » $67\frac{1}{2}$ » (» 149 »)
- c) Middle weight, A » » » (» 165 »)
- d) Middle weight, B » » $82\frac{1}{2}$ » (» 182 »)
- e) Heavy weight over $82\frac{1}{2}$ » (» 182 »)

Max. number of competitors from each nation in each class: 12

Concours d'Art.

The Fifth Olympiad will include competitions in Architecture, Sculpture, Painting, Music, and Literature.

The Jury can only consider subjects not previously published, exhibited or performed, and having some direct connection with sport.

The winner of each of the five competitions will be awarded the Gold Olympic medal. The exhibits selected will, as far as possible, be published, exhibited or performed during the Olympic Games of 1912.

Competitors must notify their intention of entering for one or more of these competitions before January 15th, 1912, and the exhibits themselves must be in the hands of the Jury before March 1st, 1912.

No limitation as to size or for are laid down for manuscripts, plans, drawings or canvases, but sculptors are required to send in clay models not exceeding 80 centimetres in height, length or width.

For further information, application should be made to M. le Président du Comité International Olympique, 20, Rue Oudinot, Paris.

Game=Shooting and Mountain Ascents.

In connection with the Olympic Games, a Gold Olympic Medal will be awarded for the finest performances during the years 1908—1911 in Game-Shooting and Mountain Ascents respectively.

The leading shooting and Alpine Clubs in the different countries have the right to propose candidates for these prizes.

The proposals must be in the hands of the Swedish Olympic Committee by March 1st, 1912, at the latest, and shall contain an account and full details of the achievements in question, with special reference to such circumstances as may be considered to entitle the competitor to the prize.

The judging will be carried out by two special juries, one for Shooting and one for Mountain Ascents, both chosen by the Swedish Olympic Committee.

The decision of each jury shall be given in writing, and shall be in the hands of the Swedish Olympic Committee, at the latest, by June 1st, 1912.

Displays.

A written communication from the French Olympic Committee, dated June 22, 1911, and proposing that an aeronautic competition should be arranged in connection with the Games, was dealt with at a meeting of the Swedish Olympic Committee on the 27 June, when it was proposed and adopted: that the holding of competitions

during the progress of the Games but outside their scope of action, should be avoided as much as possible.

Representations were made from several quarters, however, concerning the arrangement of various displays and competitions in connection with the Games, some of which the Swedish Committee, after due consideration, found that it could approve of. Amongst these for example, were horse racing and trotting matches at Lindarängen; a baseball exhibition match at the Östermalm Athletic Grounds; a review of Boy Scouts, Gottland games and Icelandic "Glima"-wrestling, at the Stadium; swimming and fireworks displays at Djurgårdsbrunnsviken Channel, etc.

The Programme of Festivities.

Although at first the Swedish Olympic Committee laid down the principle that as few festivities as possible ought to be arranged, in consequence of their disturbing influence on the work of the competitors at the Games, a number of banquets and other entertainments were given, however, in accordance with the following preliminary programme:

FRIDAY, JUNE 28

Strand Hotel

Reception festivities, arranged by the Football Committee in honour of all those taking part in the Olympic football competitions.

SUNDAY, JUNE 30

The Football Committee's dinner for honorees.

WEDNESDAY, JULY 3

7.30 p. m.

Dinner by Colonel Robert M. Thompson, President of the American Olympic Committee, on his yacht "Katrina", for the Presidents of the International Olympic Committee and of the Olympic Committees of the Nations represented at the Games.

THURSDAY, JULY 4

Riksdag House

11.00 a. m.

Hasselbacken

1.00 p. m.

Solemn Opening of the meetings of the International Olympic Committee.

The Swedish Olympic Committee's lunch for the International Olympic Committee with ladies.

Reception on board S/S "Finland" by the American Team for the representatives (athletes and officials) of the Nations represented at the Games.

FRIDAY, JULY 5

Hasselbacken

Grand Hotel Royal.

8.00 p. m.

Colonel V. G. Balck's dinner for the International Olympic Committee.

Farewell festivities, arranged by the Shooting Committee.

Reception festivities, arranged by the Cycling Committee in honour of the officials and honorees.

SATURDAY, JULY, 6

At the Palace, Logården.

4.15 p. m.

The Stadium.

8.00 p. m.

H. M. the King's Garden Party.

Grand Military Concert, arranged by the Swedish Musicians' Association, and in which 10 conductors and 300 musicians will take part. Only Swedish compositions will be played.

SUNDAY, JULY 7

Grand Hotel Royal.

8.00 p. m.

The Stadium

7.30 p. m.

The Royal Opera

8.00 p. m.

Official dinner given by the Swedish Olympic Committee for officials and honoratores.

(Conclusion of evening at the Opera Terrace.)

Display of Gotland Popular Sports, and of the Icelandic Glima.

1st Representation given by the "Folkdansens Vänner" (Club for the Promotion of Swedish national dances).

MONDAY, JULY 8

The hotel of the Minister for

Foreign Affairs

Hasselbacken

Reception by His Excellency the Minister for Foreign Affairs.

Farewell festivities, arranged by the Cycling Committee for competitors and officials of the cycling competition, and for honoratores.

TUESDAY, JULY 9

The Stadium.

7.30 p. m.

The Palace.

Skansen

8.00—11.30 p. m.

Concert.

Dinner given by H. R. H. The Crown Prince. Skansen's Olympic Festivities for competitors in the Games.

WEDNESDAY, JULY 10

Saltsjöbaden

Colonel V. G. Balck's reception.

Banquet given by the "Publicistklubben" (Swedish Institute of Journalists) for the representatives of the foreign Press.

THURSDAY, JULY 11

The Palace

The Choir Hall

(Östermalm Primary Sch.) 6.00 p. m.

Hasselbacken

The Royal Opera House

9.00 p. m.

Dinner given by H. R. H. the Crown Prince.

Children's concert, arranged by the Swedish Choral Society.

Dinner by the Fencing Committee.

Gala Performance.

FRIDAY, JULY 12

5.00 p. m.

The Choir Hall

(Östermalm Primary Sch.)

6.00 p. m.—8.00 p. m.

The Stadium

7.30 p. m.

"Five-o'clock-tea", given by Baron Pierre de Coubertin, President of the International Olympic Committee.

1st Concert by the Swedish Choral Society.

Review of Swedish Roy-Scouts, embracing concert by the boys' brass bands affiliated to the Swedish Boy Scout Clubs ; gymnastics, signalling exercises, popular outdoor games, etc.

SATURDAY, JULY 13

The Stadium
6.30 p. m.—8.00 m p. m.

Hasselbacken
8.30 p. m.

Grand Choral Festival arranged by the Swedish Choral Society. The singers will assemble at 4.30 p. m. at Stortorget. Reception Banquet given by the Committee for the Horse Riding competitions.

SUNDAY, JULY 14

Hasselbacken
5.30 p. m.
The Royal Opera House
8.00 p. m.
The Choir Hall
(Östermalm Primary Sch.), 8.00 p.m.
The Stadium
9.00 p. m.

Dinner for the competitors in the Modern Pentathlon.
2nd Representation by the "Folkdansens Vänner".
2nd Concert by the Swedish Choral Society.

Farewell festivities in honour of the assembled athletes. After supper, singing by a choir of more than 3,000 men. Music, Fireworks, etc. The public will be allowed to purchase tickets for seats for the latter part of the entertainment.

MONDAY, JULY 15

Djurgårdsbrunnsviken.
8.00 p. m.

Aquatic festival (illumination, etc.), arranged by the "Stockholms Kappsimmingsklubb" (Stockholms Swimming Club), the Swedish Amateur Swimming Association, and the Committee for the "Barnens Dag" (Children's Summer Holiday Fund).

TUESDAY, JULY 16

The Palace
Djurgårdsbrunnsviken.
8.00 p. m.

Dinner given by H. M. The King.
Aquatic festival (illumination, etc.), arranged by the "Stockholms Kappsimmingsklubb" (Stockholm Swimming Club), the Swedish Amateur Swimming Association, and the Committee for the "Barnens Dag" (Children's Summer Holiday Fund).

Stockholm—Sandhamn.
10.00 a. m.

Steamboat excursion and farewell festivities for all the foreign swimmers and officials, arranged by the Swimming Committee.

WEDNESDAY, JULY 17

Saltsjöbaden

Hasselbacken

The Stadium
9.30 p. m.

Farewell festivities, arranged by the Officers of the garrison of Stockholm.
Reception festivities, arranged by the Rowing Committee.
Fireworks and illumination.

THURSDAY, JULY 18

H. R. H. Prince Wilhelm's
Palace.
Hasselbacken

Dinner given by H. R. H. Prince Wilhelm.
Subscription Ball arranged by "Fältridtklubben". (the Stockholm Cross Country Riding Club).

FRIDAY, JULY 19

Nynäshamn

The Royal Swedish Yacht Club's Reception festivities.
Farewell festivities of the Rowing Committee.

SATURDAY, JULY 20

Nynäshamn

Dinner given by Capt. O. Holtermann, Gentleman of the Bedchamber.

SATURDAY, JULY 27

*H. R. H. Prince Wilhelm's
Palace
Hasselbacken
7.00 p. m.*

H. R. H. Prince Wilhelm's Garden Party for yachtsmen.
Farewell banquet given by the "Kungl. Svenska Segel Sällskapet" (Royal Swedish Yacht Club).

DRAWING UP THE DAILY PROGRAMME OF THE COMPETITIONS.

In consequence of the great number of inquiries from various countries, received as early as the beginning of 1910, concerning the programme of the Games, a preliminary investigation was made in the April of that year for the purpose of discovering the number of days that would be necessary for the completion of the programme which, at an earlier period, had been decided on for the Games. It was, of course, impossible at that early date to draw up a complete daily programme, as the probable number of competitors in the various branches of athletics was still unknown.

In drafting this first preliminary daily programme, there was taken as the starting point the principle, that persons interested in several branches of athletic sport ought to be given the opportunity of seeing, for example, both field and track events and swimming as well. It was considered, too, that an athlete who wished to take part in more than one competition ought not to be obliged to appear in several or all of these on the same day, or on many successive days. The endeavour to observe these two points gave rise to many difficulties, however. The first draft daily programme, which was laid before the Swedish Olympic Committee early in 1910, included competitions in pure athletics and swimming, extending over a period of 10 days, from the Saturday in the one week until the Monday week following, both days inclusive. It afterwards proved necessary to make somewhat essential alterations in this plan, the number of competitors being so immensely greater than had been expected, and, in consequence of this latter fact, the Committee found itself obliged in the case of several branches of athletics, to divide the events into forenoon- and afternoon competitions. Even at the beginning of 1912, the select Committee appointed for drawing up the programme considered that it was unable to do more than to fix the days for the competitions in the various branches of sport, together with the sequence of the events on each successive day. It was impossible, however, to determine the hours when the various competitions were to begin, until all the entries had been received.

It was not before the entries had closed, and a calculation had been made of the approximate number of competitors that were to start in each event, that the select committee, in collaboration with the General Secretariat, began to draw up the daily programme in detail, giving both the names of the various competitions that were to be held each day, and the hour at which each event should begin. This labour was, in some degree, facilitated by a plan that had, some

time before, been adopted by the Swedish Olympic Committee, viz., that of writing to various well-known officials in the Swedish athletic world, begging them to observe the length of time occupied by the various competitions, and to make a note of the number of competitors on these occasions. The material thus obtained beforehand, now served to determine the time that could be allowed for the competitions in the daily programme, and after one or two changes, the programme in question was finally drawn up at the beginning of June, 1912.

A thorough alteration in the draft programme had to be made, however, as regards the Decathlon, which was extended over three days instead of two. Here, in Sweden, the Decathlon is considered to be a proof of endurance as well as a trial of the all-round athletic skill of the competitor. In consequence of the great number of entries, however, the test of endurance had to be neglected, and the prize was to be awarded to the one who could gain the best total results in the ten events, so that bodily vigour and endurance did not obtain that place of honour originally intended for them.

The following International Athletic Congresses were held in Stockholm during, and in connection with, the Fifth Olympiad:

That of the International Football Federation.
» » » International Swimming Federation.
» » » Northern Rowing Association.
» » » Northern Bandy Association.
» » » Northern Skating Association.
» » » Swedish Athletic Association, for the formation of an International Amateur Athletic Federation.

A special general daily programme was issued in English, French, German and Swedish, in addition to which, the special committees issued technical daily programmes to the extent they were needed.

With regard to the holding of competitions on Sundays, the resolution was come to on the 27 June, 1911, that no competitions should take place during the hours of Divine Service, with the exception, however, of the cycling road race round Lake Mälär; the traffic, and other special circumstances making it an impossibility to hold fast to the rule in question on that occasion.

In accordance with these principles, the select committee drew up the following, definite general daily programme.

GENERAL DAILY PROGRAMME.

Sunday, May 5th.

The Tennis Pavilion.

Lawn Tennis (covered courts).

1.15 p. m.

Gentlemen's Singles.

Monday, May 6th.

The Tennis Pavilion.

	Lawn Tennis (covered courts).	
11.00 a. m.—6.00 p. m.	{	Gentlemen's Singles.
		Ladies' Singles.
		Gentlemen's Doubles.
		Mixed Doubles.

Tuesday, May 7th.

The Tennis Pavilion.

	Lawn Tennis (covered courts).	
12.00 noon—6.00 p.m.	{	Ladies' Singles.
		Gentlemen's Doubles.
		Mixed Doubles.

Wednesday, May 8th.

The Tennis Pavilion.

	Lawn Tennis (covered courts).	
12.00 noon—6.00 p. m.	{	Gentlemen's Singles.
		Gentlemen's Doubles.
		Mixed Doubles.

Thursday, May 9th.

The Tennis Pavilion.

	Lawn Tennis (covered courts).	
12.00 noon—6.00 p. m.	{	Gentlemen's Singles.
		Ladies' Singles.
		Gentlemen's Doubles.
		Mixed Doubles.

Friday, May 10th.

The Tennis Pavilion.

	Lawn Tennis (covered courts).		
12.00 noon—6.00 p. m.	{	Gentlemen's Singles.	<i>Semi-finals.</i>
		Ladies' Singles.	•
		Gentlemen's Doubles.	•

Saturday, May 11th.

The Tennis Pavilion.

	Lawn Tennis (covered courts).		
12.00 noon—6.00 p. m.	{	Gentlemen's Singles for 3:rd prize.	
		Ladies' Singles.	<i>Final.</i>
		Gentlemen's Doubles.	•
		Mixed Doubles.	

Sunday, May 12th.

The Tennis Pavilion.

	Lawn Tennis (covered courts).		
1.15 p. m.	{	Gentlemen's Singles.	<i>Final.</i>
		Mixed Doubles.	•

Friday, June 28th.

Östermalm Tennis Grounds.

	Lawn Tennis (out-of-door courts).	
9.00 a. m.—6.00 p. m.	{	Gentlemen's Singles.

Saturday, June 29th.

Traneberg.		
11.00 a. m.	Football. Finland v. Italy.	First round.
Råsunda.		
3.00 p. m.	» Germany v. Austria.	First round.
The Stadium.		
7.00 p. m.	» Sweden v. Holland.	First round.

Östermalm Tennis Ground.

	Lawn Tennis (out-of-door courts).
9.00 a. m.—7.00 p. m.	Gentlemen's Singles.
	Gentlemen's Doubles.

Kaknäs.

	Shooting.
	<i>Army Rifle Shooting.</i>
10.00 a. m.—12.30 p. m.	a) Team Competition ("International") : 200 metres.
12.30 p. m.—2.00 p. m.	D:o 400 metres.
4.00 p. m.—5.30 p. m.	D:o 500 »
5.30 p. m.—7.00 p. m.	D:o 600 »
	<i>Revolver and Pistol Shooting</i>
9.00 a. m.—2.00 p. m.	m) Individual Competition (Duel-Shooting) : 30 metres.
3.00 p. m.—7.00 p. m.	l) Team » » 30 »

Råsunda.

	<i>Clay Bird Shooting.</i>
9.00 a. m.—12.00 noon. 1.30 p. m.—until the first and second rounds, as well as the necessary re- shootings, are finished.	n) Team Competition.
	<i>Running Deer Shooting.</i>
10.00 a. m.—12.00 noon 1.30 p. m.—6.00 p. m.	q) Individual Competition : 100 metres ; single shots.

Sunday, June 30th.

Traneberg.		
10.00 a. m.	Football. Italy or Finland v. Russia.	Second round.
The Stadium.		
1.30 p. m.	» England v. Hungary.	Second round.
Råsunda.		
4.30 p. m.	» Norway v. Denmark.	Second round.
6.30 p. m.	» Germany or Austria v. Holland or Sweden.	Second round.

Östermalm Tennis Ground.

	Lawn Tennis (out-of-door courts).
9.00 a. m.—11.00 a. m. 1.00 p. m.—7.00 p. m.	Gentlemen's Singles.
	Gentlemen's Doubles.

Monday, July 1st.

Råsunda or Traneberg.
9.00 a. m. }
11.00 a. m. } Football.
4.00 p. m. } Consolation series : 4 matches. First round.
7.00 p. m. }

Östermalm Tennis Ground.

9.00 a. m.—7.00 p. m. } Lawn Tennis (out-of-door courts).
} Gentlemen's Singles.
} Gentlemen's Doubles.
} Ladies' Singles.
} Mixed Doubles.

Kaknäs.

9.00 a. m.—2.00 p. m. } Shooting.
3.00 p. m.—6.00 p. m. } *Army Rifle Shooting.*
c) Individual Competition : 300 metres.
b) " " " 600 "

12.00 noon—7.00 p. m. } *Revolver and Pistol Shooting.*
k) Individual competition : 50 metres.

Råsunda

9.00 a. m.—12.00 noon. } *Clay Bird Shooting*
1.30 p. m.—until the }
third round and any ne- } n) Team Competition.
cessary re-shootings are }
finished. }

9.00 a. m.—12.00 noon. } *Running Deer Shooting*
1.30 p. m.—until the com- }
petition and any necessary } q) Individual Competition : 100 metres ; single shots.
re-shootings are finished. }

Tuesday, July 2nd.

The Stadium.
3.00 p. m. } Football. Semi-final.

Östermalm Tennis Ground.

9.00 a. m.—6.00 p. m. } Lawn Tennis (out-of-door courts).
} Gentlemen's Singles.
} Gentlemen's Doubles.
} Ladies' Singles.
} Mixed Doubles.

Kaknäs.

11.00 a. m.—2.00 p. m. } Shooting.
4.00 p. m.—7.00 p. m. } *Shooting with any rifle.*
} e) Individual Competition : 300 metres.

12.00 noon—7.00 p. m. } *Revolver and Pistol Shooting.*
j) Team Competition: 50 metres.

Råsunda.

Clay Bird Shooting.

9.00 a. m.—12.00 noon.
1.30 p. m.—until the first
round and any necessary
re-shootings are finished. } o) Individual Competition.

Running Deer Shooting.

9.03 a. m.—12.00 noon.
1.30 p. m.— 6.00 p. m. } r) Individual Competition : 100 metres ; double shots.

The Stadium.

7.00 p. m. Football. Semi-final.

Wednesday, July 3rd.

Råsunda or Traneberg.

3.00 p. m. Football. Consolation series. Semi-final.

Ötermalm Tennis Ground.

Lawn Tennis (out-of-door courts).

9.00 a. m.—6.m p. m. } Gentlemen's Singles.
Gentlemen's Doubles.
Ladies' Singles.
Mixed Doubles. } Semi-finals.

Kaknäs.

Shooting.

Miniature-Rifle Shooting.

12.00 noon—7.m p. m. g) Individual Competition: 50 metres.

Råsunda

Clay Bird Shooting.

9.00 a. m.—12.00 noon.
1.30 p. m.—until the second
round, and any necessary
re-shootings are finished. } o) Individual Competition.

Running Deer Shooting.

9.00 a. in.—12.00 noon.
1.30 p. m.—until the com-
petition and any necessary
re-shootings are finished. } r) Individual Competition : 100 metres ; double shots.

Råsunda or Traneberg.

7.00 p. m. Football. Consolation series. Semi-final.

Thursday, July 4th.

The Stadium.

3.00 p. m. Football. Deciding match for 3rd prize.

Östermalm Tennis Ground.

Lawn Tennis (out-of-door courts).

12.00 noon—6.00 p. m. } Gentlemen's Singles. Semi-finals.
Gentlemen's Doubles. Final.
Ladies' Singles. Final.
Mixed Doubles. Semi-finals.

Kaknäs.

Shooting.

Shooting with any rifle.

11.00 a. m.—2.00 p. m. }
4.00 p. m.—9.00 p. m. } d) Team Competition : 300 metres.

Miniature-Rifle Shooting.

12.00 noon—7.00 p. m. f) Team Competition: 50 metres.

Råsunda.

Clay Bird Shooting.

9.00 a. m.—12.00 noon. }
1.30 p. m.—until the 3rd } o) Individual Competition.
round is finished. }

Running Deer Shooting.

10.00 a. m.—12.00 noon. }
1.30 p. m.—until the com- } p) Team Competition : 100 metres ; single shots.
petition and any necessary }
re-shootings are finished. }

The Stadium.

7.00 p. m. Football. *Final.*

Friday, July 5th.

Östermalms Tennis Ground.

Lawn Tennis (out-of-door courts).

1.15 p. m.—6.03 p. m. {
Gentlemen's Singles. *Final.*
Mixed Doubles. *Final.*

Kaknäs.

Shooting.

Miniature-Rifle Shooting.

10.00 a. m.—2.00 p. m. i) Individual Competition : 25 metres.
3.00 p. m.—7.03 p. m. h) Team Competition: 25 metres.

Råsunda.

Clay Bird Shooting.

10.00 a. m.—until the ne- }
cessary re-shootings are } o) Individual Competition.
finished. }

Råsunda or Traneberg.

7.00 p. m. Football. Consolation Series. *Final.*

Saturday, July 6th.

The Stadium.

11.00 a.m. The Solemn Opening of the Games.

Gymnastics.

12.00 noon—1.30 p. m. *Sweden.* Display by Men Gymnasts.
» » » Lady »

Athletics.

(1.30 p. m.—4.15 p. m.).

1.30 p. m. Throwing the Javelin, best hand. *Final.*
1.30 p. m. 100 metres Flat. 1st round (16 heats).
2.45 p. m. 800 » » » » (9 »).
3.45 p. m. 100 » » 2nd » (6 »).

The Stadium.

	Wrestling.	
1.30 p. m.—2. m p. m.	Roll-call of the competitors.	
2.00 p. m.—3.30 p. m.	Weighing and Drawing for Feather Weight, Light Weight and Middle Weight A.	
	{ Feather Weight. Light Weight. Middle Weight A.	
3.30 p. m.—6.00 p. m.		

The Östermalm Tennis Pavillion.

8.00 a. m.—10.00 a. m.	Fencing.
1.00 p. m.—5.00 p. m.	»

Djurgårdsbrunnsviken.

	Swimming.	
7.00 p. m.	100 metres, free style.	1st round (II heats).
7.30 p. m.	High (plain) diving from heights of 5 and 10 metres.	» » (2 »)
7.45 p. m.	1,500 metres, free style.	» » (2 »)
8.45 p. m.	Water Polo: Match a).	

The Royal Palace (Logården).

4.15 p. m.	<i>Garden Party, given by Their Majesties, the King and Queen of Sweden.</i>
------------	--

The Stadium.

8.00 p. m.	Grand Military Concert, arranged by the Swedish Musician's Association, and in which 10 conductors and 300 musicians will take part. Only Swedish compositions will be played.
------------	--

The Premises of the National Association.

The Congress of the Northern Bandy-Federation.
 (Countries represented : Denmark, Finland, Russia and Sweden.)

Sunday, July 7th.

Liljeholmen.

2.00 a. m. (the night between Saturday and Sunday)—c:a 7 a. m.	Cycling Road Race round Lake Mälär (c:a 320 kilometres). <i>Start.</i> Competitors start singly, at intervals of 2 minutes.
--	--

The Stadium.

	Athletics.		
	(9.00 a. m.—10.30 a. m.)		
	(1.30 p. m.— 5.30 p. m.)		
9.00 a. m.	Running High Jump.	Trial Heats.	
9.00 a. m.	10,000 metres Flat.	Trials { 1st Heat. 2nd » 3rd »	
9.45 a. m.	10,000 » »		
1.30 p. m.	10,000 » »		
	<i>Pentathlon.</i>		
1.30 p. m.	{ Running Broad Jump. Throwing the Javelin, best hand. 200 metres Flat. Throwing the Discus, best hand. 1,500 metres Flat. 100 metres Flat. 800 metres Flat.		
1.30 p. m.			
4.00 p. m.			
5.00 p. m.			
5.45 p. m.			<i>Final.</i>
2.45 p. m.			<i>Final.</i>
3.15 p. m.	Tug-of-War.		

The Stadium.

	Wrestling.
8.00 a.m.—9.00 a.m.	{ Weighing for Middle Weight B.
	{ Draws for Middle Weight B and Heavy Weight.
9.00 a.m.—10.30 a.m.	{ Middle Weight B.
1.30 p.m.—4.30 p.m.	{ Heavy Weight.
	{ Feather Weight.

Cycling Road Race round Lake Mälär.

c:a 1.00 p.m.—c:a 10.00 p.m. Arrival of the cyclists in the Stadium.

The Östermalm Tennis Pavilion.

9.00 a.m.—10.30 a.m.	Fencing.
1.30 p.m.—5.00 p.m.	»

Kaknäs.

	Modern Pentathlon.
9.00 a.m.	I. Duel-shooting: 25 metres.

Djurgårdsbrunnsviken.

	Swimming.
1.30 p.m.	100 metres ; Free style. 2nd round (4 Heats).
1.30 p.m.	High (plain) Diving, from heights of 5 and 10 metres. 1st » (2 »).
1.50 p.m.	200 metres; Breast Stroke. » » (4 »).
2.15 p.m.	1,500 » Free Style. » » (4 »).
7.00 p.m.	Swedish Swimming Display.
7.30 p.m.	200 metres Breast Stroke. » » (2 »).
8.00 p.m.	100 » Free Style. Semi-finals (2 »).
8.20 p.m.	1,500 » » » First round (2 »).

Lindarängen.

3.00 p.m.—6.00 p.m.	Horse Racing.
---------------------	---------------

The Stadium.

7.30 p.m.	Display of Gottland Popular Sports. ("Pärk", quoit-throwing, and tossing the caber).
-----------	--

The Royal Opera.

8.00 p.m.	Display of Icelandic Wrestling. ("Glima").
	First Gala representation given by "Folkdansens Vänner" (The Society for the promotion of Swedish National Dances).

Grand Hotel Royal

8.00 p.m.	The Official Dinner given by the Swedish Olympic Committee for Honoratiorees and Officials. (Conclusion of evening at the Opera Terrassen.)
-----------	---

Monday, July 8th.

The Stadium.

	Athletics.
	(9.30 a.m.—12.30 p.m.)
	(2.00 p.m.—5.00 p.m.)
9.30 a.m.	Walking Race; 10,000 metres. Trial (1st Heat).
10.30 a.m.	Standing Broad Jump. Final.
12.00 noon.	Relay Race ; 400 metres. Trials (6 Heats).
2.00 p.m.	Walking Race ; 10,000 metres. (2nd Heat).
3.03 p.m.	Running High Jump. Final.

6 *Fifth Olympiad.*

The Stadium.

3.30 p.m. Relay Race, 400 metres. Semi-finals (3 Heats).
 4.15 p.m. 10,000 metres Flat. Final.
 Tug-of-War.

Wrestling.

9.30 a.m.—12.30 p.m. { Light Weight.
 2.00 p.m.— 5.00 p.m. { Middle Weight A.
 Middle Weight B.

Gymnastics.

9.30 a.m.—11.00 a.m. Denmark: Display by Men Gymnasts.
 » » » Lady »
 11.00 a.m.—11.45 a.m. Norway: » » » »
 11.45 a.m.—12.30 p.m. Finland: » » » »
 2.00 p.m.— 3.00 p.m. Sweden: Team Competition I (with exercises according
 to the Swedish system).
 3.00 p.m.— 4.00 p.m. Norway: » » »
 4.00 p.m.— 5.00 p.m. Denmark: » » »

Östermalms Tennis Pavilion.

9.00 a.m.—12.00 noon. Fencing.
 1.00 p.m.— 5.00 p.m. »

Djurgårdsbrunnsviken.

11.00 a.m. Modern Pentathlon.
 II. Swimming 300 metres; Free Style.

Barkaby.

5.00 p.m. The riding course will be shown to competitors.
 (Train from the Central Station, 4.25 p.m.)

Djurgårdsbrunnsviken.

Swimming.
 12.00 noon. 400 metres; Breast Stroke. First round (4 Heats).
 12.40 p.m. 1,500 » Free Style. (If necessary.) Second » (2)
 1.30 p.m. Water Polo: Match b).
 7.00 p.m. 400 metres; Breast Stroke. First » (3).
 7.00 p.m. Spring-Board Diving. » » (3).
 7.30 p.m. 100 metres ; Free Style. Ladies. » » (2).
 7.40 p.m. 100 » » » Final.
 7.45 p.m. 1,500 » » » Second round (2 Heats).

The Hotel of H. E. the Minister for Foreign Affairs.

9.30 p.m. Reception by H. Ex., the Minister for Foreign Affairs.

Hasselbacken.

4.00 p.m. Farewell entertainment given by the Cycling Committee for the competitors, officials and honoratiories of the Cycling competition.
 Dinner given by the Swedish Swimming Association, for the delegates to the Congress of the International Swimming Federation.

The Riksdag House.

9.30 a. m. Congress of the International Swimming Federation.

Tuesday, July 9th.

The Stadium.

Athletics.

(9.30 a.m.—12.30 p. m.)

(2.00 p. m.— 5.00 p. m.)

9.30 a.m.	5,000 metres Flat.	Trials (3 Heats).
2.00 p.m.	Throwing the Javelin, right and left hand.	<i>Final.</i>
2.30 p.m.	1,500 metres Flat.	Trials (10 Heats).
4.00 p.m.	Relay Race: 400 Metres.	<i>Final.</i>
4.15 p.m.	5,000 metres Flat.	Trials (2 Heats).
	Tug-of-war.	

Wrestling.

9.30 a.m.—12.30 p.m.	{ Heavy Weight.	
2.00 p.m.—5.00 p.m.		{ Feather Weight.
		{ Light Weight.

Östermalm Tennis Courts.

Modern Pentathlon.

9.00 a.m.—5.00 p.m.	III. Fencing. Weapon: Epée.
---------------------	-----------------------------

Östermalm Tennis Pavilion.

9.00 a. m.—12.00 noon.	Fencing.
1.00 p.m. — 5. p. m.	»

Djurgårdsbrunnsviken.

Swimming.

12.00 noon.	100 metres, Free Style : Ladies. First round (3 Heats).
12.15 p.m.	100 » Back Stroke. » » (4 »).
12.35 p.m.	1,500 » Free Style. Semi-finals (2 »).
1.35 p.m.	Water Polo. Match c).
7.00 p.m.	Ladies' Swimming Display.
7.30 p.m.	100 metres, Back Stroke. First round (3 Heats).
7.40 p.m.	Spring-Board Diving. <i>Final.</i>
8.15 p.m.	200 metres, Breast Stroke. Intermediate Heats (3 Heats).

Lindarängen.

4.30 p.m.—6.30 p.m.	Trotting Races.
---------------------	-----------------

The Stadium.

7.30 p.m.	Concert.
-----------	----------

Skansen.

8.00 p.m.—11.30 p.m.	Skansen's Olympic Festivities for Competitors in the Games.
----------------------	---

The Royal Palace.

Dinner given by H. R. H. the Crown Prince.

The Riksdag House.

9.30 a.m.	<i>Congress of the International Swimming Federation.</i>
-----------	---

Wednesday, July 10th.

The Stadium.

Athletics.

(9.30 a. m.—12.30 p. m.)

(2.00 p. m.—5.00 p. m.)

9.30 a.m.	Putting the Weight, best hand.	<i>Final.</i>
10.30 a.m.	200 metres Flat.	First round (18 Heats).

The Stadium.

2.00 p. m.	5,000 metres Flat.	<i>Final.</i>
2.15 p. m.	Pole Jump.	Heats.
3.30 p. m.	1,500 metres Flat.	<i>Final.</i>
4.00 p. m.	200 » »	Second round (6 Heats).

Wrestling.

9.30 a.m.—12.30 p.m.	{ Middle Weight A.
2.00 p.m.— 5.00 p.m.	
	{ Heavy Weight.

Gymnastics.

9.30 a.m.—10.30 p.m.	<i>Germany.</i> Team Competition III. (With free choice of movements and apparatus.)
10.30 a.m.—11.30 a.m.	<i>Norway.</i> Do. do.
11.30 a.m.—12.30 p.m.	<i>Denmark.</i> Do. do.
2.00 p.m.—3.00 p.m.	<i>Finland.</i> Do. do.
3.00 p.m.—4.00 p.m.	<i>Luxemburg.</i> Do. do.
4.00 p.m.—4.45 p.m.	<i>Hungary.</i> Display by Men Gymnasts.

Östermalm Tennis Pavilion.

9.00 a. m.—12.m noon.	Fencing.
1.00 p. m.— 5.00 p. m.	»

Östermalm Tennis Courts.

	Modern Pentathlon.
9.00 a.m.—5.00 p.m.	III. Fencing. Weapon : Épée.

Djurgårdsbrunnsviken.

	Swimming.
12.00 noon.	100 metres, Back Stroke. Second round (3 Heats).
12.15 p.m.	High (plain) Diving from heights of 5 and 10 metres. Ladies. First » (3 »).
12.30 p.m.	Water Polo. Match d): Loser in a) meets loser in c).
7.00 p.m.	100 metres, Back Stroke. Intermediate Heats (2 Heats).
7.00 p.m.	High (plain) Diving, from heights of 5 and 10 metres. Ladies. First round.
7.30 p.m.	200 metres, Breast Stroke. <i>Final</i> (7 start).
7.40 p.m.	1,500 » Free Style. <i>Final.</i>

Lindarängen.

3.00 p.m.—6.00 p.m.	Horse Racing.
---------------------	---------------

Saltsjöbaden.

Reception by Colonel V. G. Balck.

Banquet given by the Association of Journalists in honor of the representatives the Press from abroad.

The Stadium.

Thursday, July, 11th.

	Athletics.
	(9.30 a. m.—12.30 p. m.)
	(2.00 p. m.— 5.00 p. m.)
9.30 a. m.	Hurdle Race, 110 metres. First round (12 Heats).
11.15 a. m.	Walking Race, 10,000 metres. <i>Final.</i>

The Stadium.

2.00 p.m.	Putting the Weight, right and left hand.	<i>Final</i>
3.00 p.m.	200 metres Flat.	<i>Final.</i>
3.15 p.m.	Pole Jump.	<i>Final.</i>
4.15 p.m.	Hurdle Race, 110 metres.	Second round (6 Heats).

Wrestling.

9.30 a.m.—12.30 a.m.	Semi-final bouts (until 3 are left) in Feather Weight,
2.00 p.m.—5.00 p.m.	Light Weight and Middle Weight A.

Gymnastics.

9.30 a.m.— 10.30 a.m.	<i>Luxemburg.</i> Team Competition II. (With exercises according to special conditions.)
10.30 a.m.—11.30 a.m.	<i>Hungary.</i> Do. do.
11.30 a.m.—12.30 p.m.	<i>Germany.</i> Do. do.
2.00 p.m.— 3.00 p.m.	<i>Great Britain.</i> Do. do.
3.00 p.m.— 4.00 p.m.	<i>Italy.</i> Do. do.
4.00 p.m.— 4.45 p.m.	<i>Russia.</i> Display by Men Gymnasts.

Barkaby.

Modern Pentathlon.

12.15 p. m. (Train from the Central Station, 11.40 a. m.).	IV. Riding singly over a special, marked course, not exceeding 5,000 metres.
--	--

Östermalm Tennis Pavilion.

9.00 a. m.—12.00 noon.	Fencing.
1.00 p. m.—5.00 p. m.	»

Djurgårdsbrunnsviken.

Swimming.

12.00 noon.	100 metres, Free Style; Ladies. Semi-finals (2 Heats).
12.10 p.m.	400 » » » First round (8 »).
7.00 p.m.	400 » » » » » (3 »).
7.30 p.m.	High (plain) Diving, from heights of 5 and 10 metres. <i>Final.</i>
7.30 p.m.	400 metres ; Breast Stroke. Semi-finals (3 Heats).
8.00 p.m.	Water Polo. Match e). Winner in a) meets winner in b).

Lindarängen.

4.30 p.m—6.30 p.m.	Trotting Races. (Principal events.)
--------------------	-------------------------------------

The Choir Hall. (Östermalm's Primary School)

6.00 p.m.	<i>Children's Concert</i> , arranged by the Swedish Choral Society.
-----------	---

The Royal Opera.

9.00 p.m.	<i>Gala Performance.</i>
-----------	--------------------------

The Royal Palace.

Dinner given by H. R. H. the Crown Prince.

Hasselbacken.

Banquet given by the Fencing Committee.

Friday, July 12th.

The Stadium.

Athletics.

	(9.30 a. m.—12.30 p. m.)	
	(2. m p. m.—5.00 p. m.)	
9.30 a.m.	Throwing the Discus, best hand.	<i>Final.</i>
11.00 a.m.	400 metres Flat.	First round (15 Heats).
2.00 p.m.	Running Broad Jump.	<i>Final.</i>
3.00 p.m.	Team Race, 3,000 metres.	Trials (3 Heats).
4.00 p.m.	Hurdle Race, 110 »	<i>Final.</i>
4.15 p.m.	400 metres Flat.	Second round (5 Heats).

Wrestling.

9.30 a.m.—2.30 p.m.	}	<i>Semi-finals</i> (until 3 are left) in Middle Weight B, and Heavy Weight.
2.00 p.m.—5.00 p.m.		<i>Final</i> , between the best three in Feather Weight.

Gymnastics.

9.30 a.m.—12.30 p.m.	}	Individual Competition, with exercises on horizontal bar, parallel bars, rings and pommel horses.
2.00 p.m.—5.00 p.m.		

Östermalm Tennis Pavilion.

9.00 a. m.—12.00 noon.	Fencing.
1.00 p. m.—5.00 p. m.	»

The Stadium. (Start and Finish)

Modern Pentathlon.

11.00 a. m.	V. Cross Country Race, ca. 4,000 metres. Competitors start singly at intervals of 1 minute.
-------------	---

Djurgårdsbrunnsviken.

Swimming.

12.00 noon.	400 metres, Free Style.	Second round (4 Heats).
12.40 p.m.	High Diving. Plain and variety diving combined; from heights of 5 and 10 metres.	First » (2 »).
12.40 p. m.	Water Polo. Match f). Loser in b) meets winner in d).	
7.00 p.m.	800 metres Team Race.	First round (2 Heats).
7.30 p.m.	100 » Free Style ; Ladies.	<i>Final.</i>
7.35 p.m.	400 » Breast Stroke.	<i>Final.</i>
7.45 p.m.	High Diving. Plain and variety diving combined, from heights of 5 and 10 metres.	» » (1 »).

Lindarängen.

4.30 p.m.—6.30 p.m.	Trotting Races.
---------------------	-----------------

The Choir Hall (Östermalm Primary School).

6.00 p.m.—8.00 p.m.	<i>First Concert by Swedish Choral Society.</i>
---------------------	---

The Stadium.

7.30 p.m.	<i>General Review of Swedish Boy Scouts</i> , embracing concert by the boys' brass bands affiliated to the Swedish Boy Scout Federation; gymnastics, signalling exercises; popular outdoor games etc.
5.00 p.m.	<i>"Five o'clock Tea"</i> , given by Baron Pierre de Coubertin, President of the International Olympic Committee.

The Riksdag House.

The 3rd Meeting of the International Olympic Committee.

The Stadium.

Saturday, July 13th.

Athletics.

(9.00 a. m.—12.30 p. m.)

(2.00 p. m.— 5.00 p. m.)

9.30 a.m.	Standing High Jump.	Trials.
10.00 a.m.	<i>Decathlon: 1st Day.</i>	
11.00 a.m.	100 metres Flat.	
2.00 p.m.		
2.00 p.m.	Putting the Weight, best hand.	
2.00 p.m.	Throwing the Discus, right and left hand.	<i>Final.</i>
3.00 p.m.	400 metres Flat.	<i>Final.</i>
3.30 p.m.	Team Race, 3,000 metres.	<i>Final.</i>
4.00 p.m.	Standing High Jump.	<i>Final.</i>

Wrestling.

9.30 a.m.—12.30 p.m.	} <i>Finals</i> between the best three in Light Weight and in Middle Weight A.
2.00 p.m.— 5.00 p.m.	

Östermalm Tennis Pavilion.

9.00 a.m.— 12.00 noon.	Fencing.
1.00 p.m.—5.00 p. m.	»

Djurgårdsbrunnsviken.

Swimming.

7.00 p.m.	400 metres, Free Style.	Semi-finals (2 Heats).
7.15 p.m.	High (plain) Diving from heights of 5 and 10 metres ; Ladies.	<i>Final.</i>
7.40 p.m.	100 metres, Back Stroke.	<i>Final.</i>
7.50 p.m.	Water Polo: Match g).	
	Winner in e) meets winner in c).	<i>Final.</i>

Course of the "Fältridtklubben" (Stockholm Cross Country Riding Club).
Start and Finish.

Horse Riding Competitions.

I. "Military".

1) Distance Ride.

2) Cross Country Ride.

The Stadium.

6.30 p.m.—8.00 p.m.	<i>Grand Choral Festival</i> , arranged by the Swedish Choral Society.
	The singers will assemble at 4.30 p.m., at Stortorget. At 5.30 p.m. they will start for the Stadium, where they will arrive at about 6.15 p.m., the open air concert beginning directly afterwards.

Hasselbacken.

8.30 p.m.	<i>Reception banquet given by the Committee for the Horse Riding Competitions.</i>
-----------	--

Sunday, July 14th.

The Stadium.

Athletics.

(9.00 a.m.—10.30 a.m.)
(1.30 p.m.—5.00 p.m.)

Decathlon. (2nd Day):

9.00 a.m.	}	Running High Jump.	
1.30 p.m.		400 metres Flat.	
2.45 p.m.		Hurdle Race, 110 metres.	
4.30 p.m.		Throwing the Discus, best hand.	
1.30 p.m.		Throwing the Hammer.	
1.45 p.m.		<i>Marathon Race</i> (40,200 metres; ca. 25 miles). <i>Final.</i>	
2.45 p.m.		Relay Race, 1,600 metres.	Trials (3 Heats).

Wrestling.

8.30 a.m.—10.30 a.m.	}	<i>Finals</i> between the best three in Middle Weight B
1.30 p.m.—4.30 p.m.		and in Heavy Weight.

Östermalm Tennis Pavilion.

9.00 a.m.—10.30 a.m.	Fencing.
1.30 p.m.—4.30 p.m.	»

Djurgårdsbrunnsviken.

Swimming.

7.00 p.m.	Grand General Display of Swimming.	
7.15 p.m.	400 metres, Free Style.	<i>Final.</i>
8.00 p.m.	Water Polo: Match h), for 2nd prize.	
	Losers in e) meets losers in g).	

Hasselbacken.

5.30 p.m.	<i>Banquet for competitors in Modern Pentathlon.</i>
-----------	--

The Royal Opera.

8.00 p.m.	<i>Second Gala Representation by the "Folkdansens Vänner".</i>
-----------	--

The Choir Hall (Östermalm Primary School.)

Second Concert by Swedish Choral Society.

The Stadium.

9.00 p.m.	<i>Farewell Festivities in honour of the athletes.</i>
	Farewell Festivities in honour of the lady officials and competitors in Gymnastics and Swimming.

Monday, July 15th.

The Stadium.

Athletics.

(9.30 a.m.—12.30 p.m.)
(2.00 p.m.—5.00 p.m.)

Decathlon (3rd Day):

9.30 a.m.	}	Pole Jump.	
2.00 p.m.		Throwing the Javelin, best hand.	
3.45 p.m.		1,500 metres Flat.	
2.00 p.m.		Hop, Step and Jump.	<i>Final.</i>
2.15 p.m.		Cross Country Race; ca. 8,000 metres.	<i>Final.</i>
2.30 p.m.		Relay Race, 1,600 metres.	<i>Final.</i>

Östermalm Tennis Pavilion.

9.00 a.m.—12.00 noon. Fencing.
1.00 p.m.—4.00 p.m. »

Djurgårdsbrunnsviken.

Swimming.
12.00 noon. 400 metres Team Race; Ladies. *Final.*
12.15 p.m. High Diving; plain and variety diving combined, from heights of 5 and 10 metres. *Final.*
12.45 p.m. 800 metres, Team Race. *Final.*
1.00 p.m. Water Polo: Match j) for and prize.
Loser in h) meets winner in d).

The Stadium.

5.00 p.m. Presentation of Prizes.

Djurgårdsbrunnsviken.

8.00 p.m. Aquatic Festival (illuminations, etc.) arranged by the Stockholms Kappsimmingsklubb (the Stockholm Swimming Club), the Swedish Amateur Swimming Association and the Committee for the "Barnens Dag" Fund (Children's Summer Holiday Fund).

Lindarängen.

Horse Riding Competitions.
I. "Military".
3) Individual Steeple-chase Ride.
II. Prize Riding. (Course of the Field Riding Club).

Östermalm Athletic Grounds.

10.00 a.m. Baseball Display.
America v. Sweden.

Tuesday, July 16th.

The Stadium.

Horse Riding Competitions.
I. "Military".
4 Prize Jumping.
III. Prize Jumping A. (Individual Competition).

Östermalm Tennis Pavilion.

9.00 a.m.—12.00 noon. Fencing.
1.00 p.m.—5.00 p.m. »

Djurgårdsbrunnsviken.

Swimming.
7.00 p.m. Water Polo (if necessary): Match k).
Winner in j) meets winner in g).
8.00 p.m. *Aquatic Festival*, arranged by the Stockholm Swimming Club, the Swedish Swimming Association, and the Committee for the "Barnens Dag" Fund.

The Royal Palace.

Dinner given by Their Majesties the King and Queen

Wednesday, July 17th.

The Stadium.

Horse Riding Competitions.

I. "Military".

5) Prize Riding.

III. Prize Jumping B. (Team Competition.)

Presentation of Prizes.

Östermalm Tennis Pavilion.

9.00 a.m.—12.00 noon. Fencing.

1.00 p.m.—5.00 p.m. 2

Djurgårdsbrunnsviken.

10.00 a.m.—8.00 p.m. Rowing.

Saltsjöbaden.

Farewell festivities (arranged by the Officers of the garrison of Stockholm).

Hasselbacken.

Reception Festivities arranged by the Rowing Committee.

Riksdag House.

5.00 p.m.

Congress of the Swedish National Athletic Association for the formation of an International Amateur Athletic Federation.

Hasselbacken.

8.00 p.m.

Banquet given by the Swedish National Athletic Association in honour of the Delegates to the above-mentioned Congress.

Thursday, July 18th.

Djurgårdsbrunnsviken.

10.00 a.m.—8.00 p.m. Rowing.

The Residence of H. R. H. Prince Wilhelm.

Dinner given by H. R. H. Prince Wilhelm.

Hasselbacken.

Subscription Ball, arranged by the Stockholm Field Riding Club.

Riksdag House.

4th Meeting of the International Olympic Committee.

Northern Skating Congress.

Friday, July 19th.

Djurgårdsbrunnsviken.

4.00 p.m.—5.00 p.m.

Rowing.

Finals.

Nynäshamn.

Reception of Foreign Yachts.

Reception festivities arranged by the Royal Swedish Yacht Club.

Hasselbacken.

Farewell Festivities arranged by the Rowing Committee.

Saturday, July 20th.

- Nynäshamn.
11.00 a. m. Yacht Racing.
First start in the Olympic Yacht Racing.
First Day.
- Djurgårdsbrunnsviken.
4.00 p. m. Rowing.
Northern Championship Races.
- Nynäshamn.
Dinner given by Captain O. Holtermann, Gentleman of the Bedchamber.

Sunday, July 21st.

- Nynäshamn.
11.00 a. m. Yacht Racing.
First start in the Olympic Yacht Racing.
Second Day.
- Riksdag House.
1.00 p. m. *Congress of the Northern Rowing Association.*

Monday, July 22nd.

- Nynäshamn.
11.00 a.m. Yacht Racing.
First start in the Olympic Yacht Racing.
Finals in those classes in which a tie has to be sailed off.

Tuesday, July 23rd.

- Riksdag House.
5th Meeting of the International Olympic Committee.

Saturday, July 27th.

- Hasselbacken.
6.00 p.m. *Presentation of Yachting Prizes.*
- The Residence of H. R. H. Prince Wilhelm.
Garden Party, given by H. R. H. Prince Wilhelm, in honour of the Yachtsmen at the Games.

DRAWING UP THE RULES FOR THE COMPETITIONS.

Simultaneously with the work of determining the programme of the Games, there was carried out the task of drawing up the rules for the competitions in the various branches of athletics. This work was divided amongst the special committees, the Secretary General giving his help and advice whenever necessary, in addition to which, the rules were revised by the Technical Section.

In those cases when there was any branch of athletics which, at the time when the rules were being drawn up, stood under the jurisdiction of an International Athletic Association and possessed fixed rules for competitions, or when the athletic regulations in force in any country had been so generally adopted that they were comparable to those just mentioned, the said rules and regulations were adopted by the Swedish Committee with as little change as possible. This was partly or wholly the case respecting cycling, football, lawn tennis, swimming, and yacht-racing, but altogether new rules had to be drawn up for athletics, fencing, gymnastics, the horse riding competitions, the modern pentathlon, rowing, shooting, the tug-of-war and wrestling. As far as possible, the regulations in force at the Fourth Olympiad, in London, in 1908, were taken as the basis of these new rules, while, at the same time, the greatest possible consideration was paid to those already existing in the various countries competing, and an endeavour was made to make a series of regulations that should harmonize as much as possible with all these elements. A more detailed account of the work of drawing up the rules for the competitions is given in the special report of the different branches of athletics, and all the rules in force at the competitions of the Fifth Olympiad are given in a special place and in extenso at the end of the book.

Rules common to all the various branches of athletics, such as those respecting jurisdiction over the competitions; the right of representation; the number of competitors each nation was entitled to enter; the right of protest, etc., were collected into one group called "General Regulations" and then submitted to the International Olympic Committee for approval.

These general regulations ran as follows:

GENERAL REGULATIONS FOR THE OLYMPIC GAMES.

1. In accordance with the decision of the International Olympic Committee at the Berlin Meeting in 1909, the Olympic Games of 1912 will be held in Stockholm.
2. The Swedish Olympic Committee arranges and is responsible for the Games. The actual management of the different sports has been delegated to Sub-Committees appointed by the Governing Sporting Associations of Sweden.

All arrangements in connection with the Horse Riding Competitions and the Olympic Yacht Racing, however, have been entrusted to the Committee for Horse

Riding and the Kungl. Svenska Segel Sällskapet (Royal Swedish Yacht Club) respectively.

3. The various competitions of the Olympic Games are confined exclusively to amateurs.

4. The definition of an "amateur" qualified to compete in any sport will be found in the detailed regulations under the heading of that sport. (See Section 18.)

5. The entries from each "nation" (see Section 6) in the different events will be limited in number, the maximum number being as a rule:

for individual events..... **12**
,, team events ... **1** team.

Definite numbers are specified in the programme.

6. A "nation", in the Olympic sense, is any country having separate representation on the International Olympic Committee, or, where no such representation exists, any country recognised as a "nation" at the last Olympic Games and, further, any sovereign state not forming part of a states-union, as well as any states-union under one and the same sovereign jurisdiction.

Natural-born or naturalised subjects of a "nation", or of a sovereign state of which a "nation" forms part, are alone eligible to represent that "nation" as competitors in the Olympic Games.

7. The amateur status of every competitor, as defined in the regulations for the different sports (see Section 4), must be guaranteed by the organisation that, in his own country governs the sport in which he desires to enter as a competitor, or, where no such governing organisation exists, by the Olympic Committee of that country.

8. The minimum age for competitors in the Games is 17 years, subject to exceptions in special cases where the entry is accompanied by a doctor's certificate testifying to his fitness.

9. There will be no entrance fee for any events.

10. Entries should be made through the Olympic Committee of each country by the governing organisation for each branch of sport, or, where no such governing organisation exists, direct by the Olympic Committee to the Swedish Olympic Committee.

11. Entries should be made (*in typed or other distinct Latin characters*) on the special Entry Form issued by the Swedish Olympic Committee, and it should be observed that *a separate form for each event must be filled in by each competitor*. This rule also refers to all persons, reserves as well as competitors, entered for team events.

No Entry can be considered unless in the hands of the Swedish Olympic Committee, at the latest, by the dates specified in the Programme for entries for the various competitions.

For non-European countries, however, entries close 8 days after the specified date.

Entries made by telegram will not be accepted.

12. The Swedish Olympic Committee reserves to itself the right to refuse entries, without being bound to give reasons for its decision.

In such an event, however, the reason will be communicated confidentially to the Olympic Committee concerned.

13. Objections to the qualification of a competitor must be made in writing, and be forwarded without delay to the Swedish Olympic Committee.

No such objection shall be entertained unless accompanied by a deposit of 20 Swedish Kronor and received by the Swedish Olympic Committee before the lapse of 30 days from the distribution of the prizes.

The Swedish Olympic Committee shall decide on such objections after having obtained all necessary information, and its decision shall be final.

The deposit shall be forfeited if the objection shall appear to have been made on unreasonable grounds. If, on the other hand, the objection is upheld or appears to have been made on reasonable grounds, the deposit will be returned.

14. As a rule, Swedes only will be appointed judges and referees etc. The Swedish Olympic Committee, however, reserves to itself the right of appointing foreign judges for certain events, if such a step be deemed necessary.

Decisions of judges concerning matters of fact cannot be appealed against.

For the different branches of sport, International Juries, consisting of, in all, from 5—9 representatives of "nations" taking part in the Games, will be formed by the Swedish Olympic Committee, to act as a Court of Appeal in questions arising from the interpretation and application of the rules governing the Games.

15. Protests against the decisions of the judges in questions not connected with matters of fact (see Section 14) shall be placed before the President of the Jury of the competition in question by a specially appointed member of the Olympic Committee of the country concerned, or by a person empowered to act on his behalf.

No such protest shall be entertained after the lapse of one hour after the announcement of the decision of the Judges on the question to which the protest refers.

The Jury, having fully investigated the matter, shall decide the question, and its decision shall be final.

16. The prizes in the Olympic Games will consist of Olympic medals and diplomas. Each prize-medal will be accompanied by a diploma. In team events a diploma will also be awarded to the winning team.

In some events, Challenge Cups will be presented to the winners, in whose possession they may remain until further notice.

Challenge Cups will not be handed over unless the winner and at least two members of the Olympic Committee concerned give a written obligation — signed on a form provided by the Swedish Olympic Committee — to deliver the Cup before January 1st, 1916, in an undamaged condition to the Organisation Committee for the next Olympic Games, and to *make good* any damage that may have happened to it.

A Diploma, which shall remain in the possession of the winner, accompanies every Challenge Cup.

Competitors who achieve a high standard of excellence, without being awarded a prize, may receive special Diplomas of Merit.

In the Olympic Yacht Racing, Olympic medals will be awarded to the helmsmen and the crews of prize winning yachts.

All competitors starting in the Games will be presented with commemorative medals.

17. The Swedish Olympic Committee will make no contribution to the expenses of the competitors. In order to minimise these, however, the Swedish Olympic Committee intends, for the convenience of those competitors for whom applications are received in good time, to make arrangements for lodging at a moderate price.

Further particulars with regard to this matter will be issued at a later date.

18. *Special, detailed rules and regulations will be issued in separate books for every branch of sport.*

19. The Swedish Olympic Committee reserves to itself the right to make, in cases of absolute necessity, changes in and additions to the programme, rules and regulations.

20. In the event of disputes arising as to the interpretation of any point in the programme, rules, and regulations, the Swedish version alone shall be official.

N.B. I. *The following sections are not applicable:—*

- a) 6 to Cycling,
- b) 6 „ Football,
- c) 10—13 and 17..... „ Horse Riding Competitions,
- d) 13—15 „ Rowing,
- e) 8, 10—15, and 19 „ Yacht Racing,

for which competitions there are special regulations in these respects (see Section 18).

II. No competitions will be held during the hours of Divine Service.

In the autumn of 1911, the rules for the various competitions were ready, and were printed in Swedish, English, French and German editions. All the Olympic Committees abroad had been previously requested in good time to inform the Swedish Olympic Committee of the number of copies of the rules for the different competitions they would require, and these were now forwarded to all the nations that intended taking part in the Games.

The English translation of the programme and the rules for the competitions, was carried out by Mr. E. Adams-Ray, Mr. Donald E. Kidd and Mr. E. P. Allen, and that of the instructions to the officials, etc., by Mr. E. Adams-Ray; the French version was executed by M^{lle} S. Harel, and the German by the Rev. G. Sterzel, D. D.

As a general opinion respecting the rules for the competitions, it may be said that, in practice, they proved very satisfactory. Their issue in four different languages should be of no little importance for the world of athletics, a foundation having by this means been laid for the creation of an international series of uniform rules for the branches of athletics represented.

AMATEUR DEFINITIONS.

The task of properly defining the term “Amateur” was a most delicate one, as various athletic associations in different countries had long ago adopted such widely varying laws in this respect. One indispensable condition had to be laid down, however, viz., that only real amateurs should be allowed the privilege of taking part in the competitions of the Games.

It was not within the bounds of possibility to draw up a definition of the term "Amateur" that should be common to all branches of athletics, and it was, therefore found necessary, in consideration of the many different demands that existed, to make a special definition of the term for each division of sport. It was an easy task to do this in those cases where there existed an international federation, as the Swedish Olympic Committee could at once adopt the amateur definition fixed by the international organization in question. But this could be done only in the cases of *Cycling*, *Football* and *Swimming*, and special definitions had to be drawn up for all the other branches of athletics.

An attempt was made, however, when drawing up these amateur definitions, to create something which, as far as possible, should be a norm, from which deviations would be made only to the degree rendered necessary by the principles already generally adopted by various branches of athletics.

This general amateur rule, which was the same for *Athletics*, the *Tug-of-War* and *Wrestling*, was as follows:

The competition shall be confined to amateurs according to the following definition : —

An amateur is one who has never

- a) competed for a money prize or for monetary consideration, or in any way drawn pecuniary gain from the exercise of his sport;
- b) competed against a professional ;
- c) taught in any branch of sport for payment;
- d) sold, pawned, hired out or exhibited for payment, any prize won in a competition.

In *Cycling*, where, according to the agreement come to by the national associations affiliated to the Union Cycliste Internationale, every amateur was to be provided with a certificate issued by the Union or by one of the said associations, the amateur regulation was as follows:

The competition is only open to amateurs provided with a license from the Union Cycliste Internationale or any Association affiliated to the above-mentioned Union. A certified copy of such license shall accompany each entry.

For *Football*, in consequence of the fact that the competition was to be held in accordance with the rules adopted by the Federation Internationale de Football Association, the amateur definition was as follows:

An amateur player is one who has never:

- a) competed for a money prize, or received any remuneration or consideration of any sort above his necessary hotel and travelling expenses, paid in actual connection with football matches ;
- b) engaged, assisted, or taught, in any branch of sport as a means of pecuniary gain ;
- c) been registered as a professional ;
- d) sold, pawned, hired out, or exhibited for payment, any prize won in a competition.

In *Fencing*, the amateur definition was:

Anyone who is an amateur according to the laws of his nation, will be recognized as such.

The qualification of Amateur must be confirmed by a certificate from the Amateur Fencing Association or, failing this organisation, by the Olympic Committee of his own country, who will then be responsible for its validity.

Any fencer who, within one year after these Games, shall be proved to the satisfaction of the Organisation Committee of the Olympic games at Stockholm 1912, to have infringed the rules for Amateurs previous to taking part in the competitions, shall be disqualified, and all the prizes that he has gained must be returned to the Committee, who may award them to another competitor. The disqualification of one member of a team disqualifies the whole team.

That for the *Gymnastic* Competitions was:

An amateur is one

- a) who has never, for pecuniary gain, taken part in a public competition or display;
- b) who has never taken part in a competition for money prizes;
- c) who, in all other respects, is an amateur according to the rules of his own country.

Gymnastic teachers and leaders, even though they receive payment as such, are regarded as amateurs.

For the *Horse Riding* Competitions the following special regulations were drawn up:

The Games are exclusively confined to gentlemen riders. Professionals are excluded.

The following will be considered the definition of a "gentleman rider":

For foreign competitors: the definition given in the regulations of the leading horse-riding, association of their country;

For Swedish competitors: the Racing Rules of the Swedish Jockey Club, art. 85.

Lawn Tennis did not require any great alteration in the common amateur definition, the regulation running as follows:

An amateur is one who has never:

- a) taken up any branch of sport as a profession;
- b) competed in Lawn Tennis competitions or exhibitions, or taught Lawn Tennis, for payment or for pecuniary consideration;
- c) sold, pawned, bartered, hired out or exhibited for payment any prize won in a competition;
- d) competed in an open competition with Or against a Lawn Tennis Player Who was not an Amateur according to these conditions.

For the *Rowing* Competitions the amateur definition was:

An amateur is one who has never:

- a) received payment as a trainer;
- b) competed for a money prize;
- c) competed or given a display for payment;
- d) competed, or given a display, against a professional;
- e) drawn any pecuniary gain from athletic exercises by selling, exchanging, pawning, or hiring out any prize won in a competition.

7 *Fifth Olympiad.*

Note. An amateur shall be allowed, when taking part in races or displays, to receive his travelling and hotel expenses from the club to which he belongs, or, with the consent of the said club, from the club arranging the competition or display, without forfeiting his amateur status. Payment for such a journey, however, may be made only through the club which he represents in the said competition. No competitor shall be allowed to make any pecuniary gain or profit from such payment.

A professional shall not be allowed to take part in any competitions or displays for amateurs, neither may he officiate therein as judge or in any other capacity.

A professional is one who as a seaman, fisherman, or in any other capacity, has in any way, in the exercise of his calling, engaged in rowing within two years previous to the date of competition.

The amateur definition for the *Shooting* Competitions was also a special one, running as follows:

An amateur is one who has never:—

- a) shot in public or been specially occupied with instruction in shooting, with the intention of thereby earning his living;
- b) taken part in an open competition for professional shooters;
- c) sold, pawned, hired out, or exhibited for payment any prize won in a competition;
- d) been engaged at a gunsmith's and there been specially occupied with sighting and adjusting weapons.

For *Swimming*, the regulations of the Fédération Internationale de Natation Amateur were in force, viz.:

An amateur is one who has never:

- a) competed for a money prize, declared wager, or staked bet, in swimming or in any other athletic Sport;
- b) taught, pursued, or assisted in the practice of swimming, or any other athletic exercise, as a means of pecuniary gain;
- c) knowingly and without protest taken part in any competition or exhibition with anyone who was not an Amateur — (except whilst in the Military or Naval Services, and then only in Military or Naval sports. A professional in any branch of sport shall be considered a professional in swimming.

The exceptions laid down by the Fédération Internationale de Natation Amateur shall apply.

Finally, the *Yacht Sailing* Matches, too, demanded quite a special amateur definition, which ran as follows:

The helmsman and every member of the crew of a yacht, competing in the Olympic yacht races, must be an amateur.

Every member of a recognized sailing club, who never has carried on yacht sailing as a profession, nor during the last five years has followed other sailing as a trade, is an amateur.

Yachts and crews, competing in the Olympic yacht races, must be selected and entered by such National Authority as is defined in the rules of the International Yacht Racing Union, or, where no such authority exists, by the Olympic Committee of that nation.

The amateur status of every competitor must be guaranteed by the National Authority, or, where no such authority exists, by the Olympic Committee of that nation.

THE JURIES AND OFFICIALS AT THE GAMES.

THE PRINCIPLES ADOPTED.

As early as at the beginning of 1910, the Swedish Olympic Committee discussed the principles to be adopted in the choice of juries and officials. It was self-evident, of course, that only actual amateurs should be permitted to act in these capacities, but opinions varied as to whether Swedes alone should be chosen as judges and officials, or whether foreigners also should be chosen. In May, 1910, the special committees for athletics, gymnastics and swimming expressed their decided opinion that Swedish judges alone ought to be allowed to act, but that when a question arose of the interpretation of any of the rules of the competitions, etc.—*but not as regards their application*—certain juries could be nominated, whose members belonged to different nationalities. Other special committees, such as that for wrestling, declared that, as far as their branches of sport were concerned, foreign judges could not be considered necessary, although desirable, while other committees, such as that for fencing, emphasized not only the suitability, but also the necessity, of having foreign judges.

On the 6 June 1910, the Technical Section expressed its own decided opinion that if, in general, it was possible to have foreign judges for the Games it would be a great advantage, as the adoption of such a measure would give the clear stamp of impartiality to the Swedish arrangers, in addition to which, the foreign judges, from their acquaintance with the conditions prevailing on the continent, as well as from their personal knowledge of athletics, would undoubtedly be of great assistance to the Swedish judges.

On the basis of the principle thus laid down, the Technical Section, in June, 1910, moved the adoption of the following draft regulations concerning the appointment of judges at the Games:

DRAFT REGULATION CONCERNING THE APPOINTMENT OF JUDGES AT THE OLYMPIC GAMES.

GENERAL REGULATIONS:

In each branch of athletics the judges shall be appointed by the special organization for the branch of sport in question in the country in which the Olympic Games are to be held but, if possible, the said special organization should also choose, as some of these judges, persons in other countries who are known by the organization to have acted in the capacity in question. The total number of such foreign judges in any one branch of athletic sport must not, however, exceed one third of the whole number of judges.

Each nation has the right to have an official representative present at those competitions in which any of its athletes are taking part. The name of this re-

List of members of the International Juries for the various branches of athletics.

U. S. A.	J. E. Sullivan					F. S. Foltz		G. T. Kirby		W. Libbey	B. S. Weeks	
South Africa										Sir L. Phillips, Bart.		
Russia			Vacant		Vacant	Vacant		G. Duperron		P. Moshoff		L. Tschaplin- sky
Norway					E. Berthelsen	Egeberg- Ottosen		O. T. Klingenberg	E. Wettre	A. Frisch		
Italy			C. de Bri- chanteaux		Vacant							
Hungary	S. Stankovits				C. von Iszer			D. Lauber			A. von Füzesséry	M. Csanádi
Holland			A. E. W. de Jong	C. A. W. Hirschmann								
Greece	A. Metaxas									J. Chryssafis		
Great Britain	W. A. Brommage		Lord Desborough	D. B. Woolfall	Vacant	Vacant		J. F. Noel- Birch	T. A. Cook	Vacant	F. Baxter	Vacant
Germany	C. Diem		H. Jürst		Vacant	von Giese			O. Ruperti		A. Witt	E. Kissling
France	R. Enderlin		Vacant		Lachaud	Destremau			M. Glandaz	M. Faure		
Finland	I. Wilskman										U. Westerholm	Vacant
Denmark								O. A. H. Moltke		H. H. Bondo	H. S. Køster	H. H. Bondo
Canada	J. G. Merrick								J. Wright			
Bohemia									J. Roessler- Orovsky			W. Rudl
Belgium			A. Feyerick	Baron de Laveleye		Joostens			L. Annoot		F. V. Heyden	
Austria			H. Tenner						O. Hersch- mann		Felix Graf	O. Hersch- mann
Australasia									Q. L. Deloitte		E. S. Marks	
Sweden's representative	C. Silfverstolpe		S. Drakenberg		E. Nerman	Count K. von Rosen		C. Silfverstolpe	U. Salchow	Fr. Björken- stam	E. Bergvall	A. W. Björkgren
President	J. S. Edström		C. G. Platen	C. L. Kornerup	V. G. Balck	G. Nyblaeus		Count C. E. Taube	F. Löwenadler	Count C. E. Taube	N. D. Edlund	C. Helgesson
Branch of Athletics												
Athletics Tug of War												
Cycling	No jury was nominated for this branch, as the rules of the Union Cycliste Internationale prescribe, instead, the appointment of 3 special foreign commissioners.											
Fencing												
Football												
Gymnastics												
Horse Riding												
Lawn Tennis	No jury was nominated for this branch as, according to the rules everywhere in force, the leader alone is the chief judge and his decisions are final.											
Modern Pentathlon												
Rowing												
Shooting												
Swimming												
Wrestling												

representative shall be communicated to the leader of the competition before the beginning of the event. Should any protest be made during the course, or at the end, of the competition, such protest can only be sent in by such a representative, who also has the task of speaking on the matter before the International Jury that is to decide the protest.

For the purpose of deciding any dispute that may arise, an international jury shall be appointed for each branch of athletics, consisting of one representative for every nation that has had at least five competitors in the branch of sport in question. In addition to these representatives, the country arranging the Games shall appoint a president for each jury.

SPECIAL REGULATIONS:

1. *Athletics.*

There shall be three judges for the competitions in each branch of athletics, one of whom, if possible, shall belong to a foreign nation.

2. *Wrestling.*

There shall be three judges for each bout. In these competitions it would be desirable for the judges to belong to other nationalities than those of the competitors in the bout to be judged.

3. *Swimming.*

The same regulation as for athletics.

4. *Fencing.*

The same regulation as for wrestling.

5. *Gymnastics.*

If any competition in gymnastics is arranged, it ought only to be an individual one. In such a case, the same regulations shall hold good here as for athletics.

During the further consideration of this question it became clearer and clearer, however, that it would be necessary to employ both principles, as it was unconditionally necessary in some branches of athletics that foreign judges, too, should be appointed, while, for other branches, it would, without doubt, be most suitable to have Swedish judges alone. Should these principles not be adopted, difficulties would be certain to arise in the management of a number of competitions; caused, in the first place, by the varying languages of the competitors and, in the second case, by the possibility that some of the officials in question, accustomed as they were to applying quite other rules for the competitions than those that were to be in force during the Fifth Olympiad, would misinterpret and misunderstand the instructions, while this confusion would be the greater, the larger the number of the nationalities represented by the judges. It was also clear that if the competitions were to go off smoothly, it was of the greatest importance for the various officials to know each other, and for each of them to be perfectly acquainted with, and well instructed beforehand in, the duties he had to perform. Finally, it was also a point of no little moment that, the greater the number of foreign officials appointed, the less would the responsibility for the carrying out of the competitions, and for the decisions of the judges, in each case, rest on the shoulders of the Swedish Olympic Committee and its special committees, and that this

could have no other result than to weaken the guarantee that the competitions would be carried out in the best and most impartial manner.

The Court of Appeal.

With regard to the establishment of a court of appeal to which a competitor could turn in the case of an incorrect decision, the Swedish Olympic Committee found itself obliged to unconditionally maintain the principle long held in the international athletic world, that decisions whereby facts are confirmed by an acting judge, must be without appeal and cannot be carried before any higher court. For it cannot be proper to leave the decision of questions concerning matters of fact to an international jury whose members perhaps, have not had the opportunity of seeing with their own eyes what has happened. In the opposite case, of course, it would be necessary for the jury as a whole to be present at each competition, but even if this step were taken, justifiable doubts could be entertained whether such a method of procedure would be a suitable one for the purpose of deciding the question of right or wrong in a technical matter.

On the other hand it must, of course, be considered necessary that, in addition to the judges, there should also be a court entitled to decide disputes which did not concern facts and, as a rule, in questions which could not be considered as belonging to athletic-technical spheres, such as, for example, the matter of the interpretation of the rules of the competitions, etc. For this reason, the Swedish Olympic Committee considered it suitable that an international jury should be established, consisting of a president nominated by the Swedish Olympic Committee, together with one representative for each of eight different nations taking part in the Games, in addition to the one from Sweden.

With the approval of the International Olympic Committee, the Swedish Olympic Committee consequently came to the following decision in these questions:

As a rule, Swedes only will be appointed judges and referees, etc. The Swedish Olympic Committee, however, reserves the right of appointing foreign judges for certain events if such a step be deemed necessary.

Decisions of judges concerning matters of fact cannot be appealed against.

For the different branches of sport, International Juries, consisting of, in all, from 5—9 representatives of "nations" taking part in the Games, will be formed by the Swedish Olympic Committee to act as a Court of Appeal in questions arising from the interpretation and application of the rules governing the Games.

Protests against the decisions of the judges in questions not connected with matters of fact shall be placed before the President of the Jury of the competition in question, by a specially appointed member of the Olympic Committee of the country concerned, or by a person empowered to act on his behalf.

No such protest shall be entertained after the lapse of one hour after the announcement of the decision of the Judges on the question to which the protest refers.

The Jury, having fully investigated the matter, shall decide the question, and its decision shall be final.

It was in agreement with these general principles that the officials at the competitions were afterwards chosen. The composition of the international juries is shewn by the Table on pp. 100—101.

FOREIGN OFFICIALS.

As regards the appointment of the other officials, the Olympic Committee was able to confine itself to Swedes alone for the following branches of athletics:

Athletics, Cycling, Lawn Tennis, Modern Pentathlon, Rowing, Shooting, Tug-of-War and Yacht Racing.

The following is a list of the foreign judges acting in the competitions mentioned below:

In the *Cycling* competition:

In accordance with the regulations of the Union Cycliste Internationale, there were appointed 3 “commissaires de course”, viz:

Comte D'ARNAUD	France.
TH. BOECKLING	Germany.
J. BLAIR	Great Britain.

In the *Fencing* competition:

H. TENNER	Austria.
M. BERRÉ	Belgium.
C. CNOOPS	”
A. FEYERICK	”
A. SARENS	”
K. GRUSS	Bohemia.
O. KOSTAR	”
L. SOUREK	”
A. CLOD-HANSEN	Denmark.
H. SANDER	”
Marquis DE CHASSELOUP-LAUBAT ..	France.
F. SÉE	”
J. ERCKRATH DE BARY	Germany.
H. MAYER	”
G. MESS	”
B. NATUSCH	”
A. PETRI	”
A. E. W. DE JONG	Holland.
H. DE JONGH	”
G. VAN ROSSEM	”
M. HAJDU	Hungary.
B. NAGY	”
D. DIANA	Italy.
UGO DI NOLA	”
F. PIETRASANTA	”
P. SPECIALE	”

L. TH. AAS	Norway.
S. W. MATHIESEN	”
G. M. HAMMOND	U. S. A.
A. VAN ZO POST	”
A. E. SAUER	”

In the *Football* competition:

As referees for the Football matches it was, quite naturally, found most suitable to appoint foreigners, and the Football Committee was fortunate enough to be able to calculate on the assistance of well-known men from abroad who, before the Games began, had intimated to the Committee their intention to be present at the competitions, and, at the same time, offered to assist the Football Committee in the capacity mentioned. The following persons officiated as referees in the football competition during the Games:

H. MEISL	Austria.
G. WAGSTAFFE-SIMMONS	Great Britain.
PHILIP	” ”
GROOTHOFF	Holland.
H. G. WILLING	”
HERCZOG	Hungary.
R. GELBORD	Sweden.
P. SJÖBLOM	”

The linesmen were exclusively Swedes.

In *Gymnastics*:

A. *Team Competition I. (Movements according to the Swedish System.)*

O. LEFEBURE	Belgium.
N. H. RASMUSSEN	Denmark.
A. E. SYSON	Great Britain.
L. BENTZEN	Norway.

B. *Team Competition II. (in accordance with special regulations), III. (with free choice of movements and apparatus), and the Individual Competition.*

JOSEPH ROESSLER-OROVSKY	Bohemia.
A. CLOD-HANSEN	Denmark.
IVAR WILSKMAN	Finland.
H. CAIN	Great Britain.
MICHEL BÉLY	Hungary.
CESARE TIFI	Italy.
J. F. ALLUM	Norway.
DEDEKAM	”
MARTUSCHEFF	Russia.
WICHRA	”

The following officiated as judges in the *Horse Riding* Competition (prize riding only):

CHODRON DE COURCEL	France.
SEIFFERT	Germany.
WIEL-GEDDE.....	Norway.
C. BERTRIN	Russia.

In *Swimming* the principle was adopted, that none but Swedish functionaries should be employed in all the competitions with the exception of water-polo, in which foreign judges were appointed only in those matches wherein Sweden played against a team belonging to some other nationality. This step was taken in order to obtain the greatest possible uniformity in the application of the rules of water-polo. In these matches the Swimming Committee had the advantage of obtaining the services of three well-known judges from abroad:

F. VAN DER HEYDEN	Belgium.
G. W. HEARN	Great Britain.
J. HURD	” ”

In the *Wrestling* competitions:

F. X. MARKONES	Austria.
R. SCHINDLER.....	Bohemia.
ARNOLD RICH. NIELSEN	Denmark.
J. K. LINDSTEDT	Finland.
RICHARD PREUSS	Germany.
PERCY LONGHURST	Great Britain
G. A. M. BRANDS	Holland.
PETER TATICS.....	Hungary.

In the various competitions of the Olympic Games of Stockholm, 1912, there were employed 617 Swedish and 133 foreign functionaries.

THE POSTS FILLED BY THE OFFICIALS.

In *Athletics*, the officials were divided into four groups, one embracing the “general direction”, as it was termed, and one for each of the groups, jumping, running, and throwing. The highest official was the principal leader or manager of the Games, who had two special assistants. Each of the other divisions had its “group-president”, who, at the same time, was the leader of the competition in which the group in question took part. In each group there were, in addition to these “group-presidents” or “group-leaders”, three or more judges, secretaries, orderlies, etc. In the “general direction” there were included all the functionaries that could not be grouped direct in any special division; such were, for example, the medical men, the heralds, stewards, interpreters, clerks of the course or “criers”, the officials at the result-boards, etc. Altogether, there were 122 functionaries for the Athletic Competitions.

Quite naturally, the *Cycle Race round Lake Mälär* called for quite a large number of officials, viz., 1 leader, 6 leader’s-adjutants, 2 starters,

5 starter's adjutants, 2 judges, 5 secretaries, 2 leaders of the timekeepers; 12 timekeepers, 3 secretaries to the timekeepers, 13 secretaries at the telephones, 3 orderlies, 7 functionaries at the result-boards, 5 controllers along the route, 3 medical men, 2 medical assistants, 1 chief clerk at the office, 1 manager of the refreshment department, 2 Press adjutants. There were, altogether, 80 functionaries at the various control stations, so that the grand total of officials needed for the Cycling Competition was 159.

The *Football* Competition required 28 judges and linesman.

The functionaries officiating at the *Fencing* Competitions were as follows: 6 forming the management of the competition; 12 Swedish judges, 31 foreign judges, and 12 secretaries, or, altogether, 61.

The officials at the *Gymnastic* Competitions were divided as follows: 1 chief leader, with 3 assistants; 2 leaders of the team competition; 2 leaders of the individual competition; 1 leader of the displays; 17 judges and deputy judges; 2 leaders of the Swedish competing- and display-teams; 1 chief-orderly, with 1 assistant chief orderly; 1 storekeeper and 1 assistant storekeeper; 3 secretaries, or, in all, 35 functionaries.

For the *Horse Riding* Competitions there was a special board of judges, with 1 president and 1 secretary, in addition to special groups of officials and judges for the three different competitions, with 1 doctor and 2 veterinary surgeons. In all, 46.

The functionaries for *Lawn Tennis* were: 1 leader and chief judge; 2 assistant leaders and 10 judges. No jury was appointed for this branch of the competitions as, according to the rules in force, the leader alone was the chief judge, his decision being final.

A "competition committee" elected from among the members of the Committee for the *Modern Pentathlon*, formed the chief management of the competition in question. It consisted of 3 members, but the technical direction lay in the hands of the special committees for the branches of athletics forming the competition, who acted through functionaries chosen to officiate at the various events.

The officials acting at the *Rowing* Competitions were as follows: 2 leaders; 3 leader's assistants; 1 chief judge; 4 referees; 4 referee's assistants; 1 secretary; 2 secretary's assistants; 4 judges at the post; 4 judge's assistants; 1 boat-house manager; 2 boat-house manager's assistants; 1 chief timekeeper; 7 timekeepers; 2 starters; 2 starter's assistants; 1 clerk of the course; 1 assistant to the clerk of the course; 1 steward of the course; 2 stewards at the stands; 1 signalling chief and 1 assistant; 1 Press representative and 1 assistant; 1 transport-manager; 2 interpreters; 1 doctor. Total, 53.

The *Shooting* Competitions were under the direction of the following officials: a chief leader or manager of all the competitions in general, and a special leader of the rifle-shooting, the miniature rifle-shooting, the pistol-shooting, and the clay-bird shooting competitions, with a leader, a captain of the team, a president and his assistant for each division, and judges. Altogether, there were 38 functionaries for these competitions.

The general management of the *Swimming* Competitions consisted

of: 1 chief leader; 3 assistant leaders; 3 chief leader's adjutants; 1 referee; 2 orderlies of the course; 2 stewards at the stands; 3 medical men; 2 Press adjutants; 2 interpreters and 1 storekeeper. The management of the special events was divided into three groups — for the swimming races, the diving, and water-polo — each event having a leader; there were also starters; judges at the finish and judges along the course; prize-judges; a leader for the counting of the lengths; start controller; turn-controller; timekeeper and secretary. In addition to these, there were special manageresses for the lady competitors. In all, there were 99 officials for the Swimming Competitions.

The 38 officials that assisted at the *Wrestling* Competitions were divided as follows: 1 leader or manager, 2 leader's-assistants, 6 chief judges, 15 judges, 7 secretaries, 1 medical man and 6 functionaries at the result-boards.

Finally, the functionaries at the *Yacht Racing* Competitions were: a First Squadron Chief and Hon. President; a squadron chief; a vice-squadron chief; an assistant to the squadron chief; a sailing committee; a prize-committee; officials at the start and finish; stewards; a medical man, etc. or, in all, 49.

THE QUALIFICATIONS OF THE OFFICIALS.

In choosing the officials, the first thing demanded was that they should be well versed in the rules of the competition in which they were to act, and also that they should possess great experience in the practical application of these regulations, gained at former competitions. The second point considered was, that there must be among the officials a sufficient number of persons well-versed in languages. There was a certain amount of difficulty experienced in obtaining the requisite number of persons possessing both these qualifications, and in some few cases it was found necessary to give greater prominence to the latter of the two.

In order to give the officials as good a training as possible for their various tasks, a notice was sent in 1910 to all the leaders or managers of athletic sports in Sweden, begging them to pay particular attention, during the course of future competitions, to the functionaries acting at them, and then, later on, to send in to the various special Olympic Committees the names of those persons that it was thought would make suitable officials for the Olympic Games. In this way the Olympic Committee obtained a very large number of candidates for the various posts, and as early as the spring of 1911 it was found possible to choose a certain number of officials for several branches of athletics, who were afterwards given the opportunity to show their ability and to make themselves well acquainted with their tasks, by officiating at the Swedish Championship- and other prominent athletic meetings. The final trial of these functionaries was made at the Swedish try outs for the various branches of the Games, held in the spring of 1912, at which meeting all the officials chosen were obliged to be present.

A uniform was chosen for all these officials, consisting of a blue jacket, white trousers and straw hat, but its use was not absolutely compulsory.

Special instructions were drawn up for the officials that were to act in the three groups, athletics, cycling, gymnastics, shooting and swimming, and these instructions, after having been tested in the Swedish try outs, were printed and distributed to all the functionaries and competitors in these branches of athletics who asked for a copy.

These instructions were as follows:

INSTRUCTIONS FOR THE OFFICIALS FOR THE COMPETITIONS IN ATHLETICS.

Regulations for the General Management.

The chief management of the athletic competitions shall be in the hands of a *leader* or *manager*, who shall have *two assistants*.

The *leader* shall have his station in the "leader's stand", which will be placed in the neighbourhood of the finish, and from which he can follow the course of the competitions. Communications that may be necessary between the leader and the other officials or the competitors, shall take place through the *leader's assistants* who, in conjunction with the leader, are to see that the rules are properly observed. In the event of there being any offence against the rules, etc., the assistants shall if time permit, apply to the leader in order to obtain his decision and orders in the matter; if the question is one of great urgency, however, the assistants shall have the right to intervene in the matter at once.

From among the officials in each of the three groups — *Running and Walking, Jumping and Throwing* — there shall be nominated a *president* and a deputy-president. The president shall be responsible to the leader for the proper carrying-out of the competitions; he shall, every day, divide his subordinates into three groups, — active; reserve; disengaged; he shall be responsible for the punctual attendance of those of his subordinates that have to be on duty.

The leader, his deputy and assistants, the three group-presidents and the orderlies of each group, shall meet at a fixed hour in the morning of each day on which a competition is to take place, in order to consult about the day's competitions.

The leader shall signal the number of each competition to the dressing rooms, not later than 10 minutes before each start, by means of an apparatus arranged on the leader's stand and so constructed that the programme-number of the competitions can be made known by means of a signal. In order, however, to provide against the eventuality of the apparatus getting out of order, the leader shall have at his disposal two *criers of the starts*. The leader shall also have the task of seeing that the number of the competition is announced to the public by being exhibited on a signalling-mast erected in the Stadium for the purpose.

The leader shall take care that the officials are in their proper places in good time, before the beginning of each competition.

The leader shall fix and publish the time when any tie is to be determined, by placing a notice of the same in the dressing-rooms of the competitors concerned, and by other suitable means.

The leader shall decide questions concerning the suitability of the dress worn by the competitors, and shall place the officials in different stations if this step prove necessary.

The leader has the right to take steps, either personally or through his adjutants, to ascertain from the officials whether a competition is being properly carried out or not.

A decision of the leader concerning matters of fact is final.

Should a disagreement arise amongst the officials, the question shall be submitted to the leader by the president of the group in question.

The leader shall receive the minutes from the secretary for the competition, after they have been signed by the judges and the secretary, and he shall see that the final results are made public, both by means of the heralds and by the figures being placed on the result board.

He shall also see that the standards of the winning nations, together with the number of the competition (to be placed above the flag of the first prizewinner), are hoisted on the flag-poles intended for this purpose.

The leader shall see that the positions of the runners during the course of the Marathon Race are announced to the public by means of the signal-mast erected for the purpose.

After the close of each event in the Pentathlon, and the Decathlon, the leader shall see that the total results hitherto reached are made known to the public.

The leader shall decide all doubtful points in connection with the competition, which are not mentioned in its regulations.

The *deputy-leader*, when acting in the absence of the leader, shall enjoy all the rights and perform all the duties of the leader.

The *medical man* who has the task of summoning the other doctors that have to be on duty each day, is responsible for their being in the places reserved for them, and at the disposal of the leader.

The *chief steward* shall see that no other persons are present in the arena than the officials *on duty*, the competitors *who are taking part* in the competition that is going on, and the photographers who have the permission to be there.

In order that the chief steward may be able to distinguish between the officials, the latter shall wear round the arm a ribbon of a special colour for each of the three following groups: for the throwing competitions, yellow; for the jumping competitions, blue, and for the running events, white.

The *interpreters*. These officials, who shall bear a distinctive badge, shall be placed by the leader in certain places for each special case.

The *Press-adjutant* shall be stationed in the arena, from which spot, by means of a telephone, or otherwise, he shall supply the representatives of the Press with the information they may desire. For this purpose he shall be allowed to consult the official minutes of the competitions and, in case of necessity, he has the right to consult with the functionaries.

The final results of the various competitions shall be announced by the *Heralds* (by means of megaphone, or otherwise), both in Swedish and in English.

In each of the corridors running outside the dressing-rooms at the Stadium, there shall be stationed a "*start-crier*" who — simultaneously with the start-signal given by the leader (see above), shall go into each dressing room along the corridor, there make known his presence by striking a gong, and call attention to the notice-board he carries, on which there shall be written the number of the competition for which the signal is being given. These criers shall also go through the dressing-rooms after the signal-bell has finished ringing, to see that all the numbers signalled are taken away, should a method of signalling by means of numbers be employed.

General Regulations for the Officials for the Track Events.

1 leader or manager, 1 starter, 6 judges at the finish, of whom one shall be the chief judge, 3 judges of the course, 3 or more timekeepers, 1 secretary, 1 orderly, 2 men at the result-board, 2 men at the start-board, 1 extra man at the finish.

The *Leader* or *Manager*, who is the president of the group of officials, shall give the order when a race is to be started. After the runners have taken their places for the start, he shall make sure that the judges at the finish have been properly informed of their tasks by their leader and have been given their right places; he shall see that the timekeepers are ready and that the tape at the finish is in order.

After the leader has made sure that everything is in proper order, he shall step on to the course and give a signal with a red flag to the starter that he may let the runners go.

The *Judges at the finish*. After the leader of the judges at the finish has given them their instructions with regard to the judging of the placing of the various

runners on passing the post, they shall take the positions assigned to them by their leader on a staircase-like terrace lying in a straight line with the tape. There shall be 3 judges at the finish to decide who passes the tape first; each of the other judges shall take one of the runners, but, in order to be able to make the judging of the placing a certainty, each of these last-mentioned judges shall also make a note of the runners who, when his man passes the post, immediately precede and follow him. Immediately after the conclusion of a race, the judges at the finish shall assemble under the presidency of their leader, no other person being allowed to be present. The decision of the judges will be dictated to the secretary, who will make a minute of it. The decision of the judges is final.

The *Starter*. This official must take care to see, immediately before each race, that his pistol is in perfect order; he shall also carry a reserve pistol, with a sufficient number of shots. After the orderly has shown the runners their places, and after the starter has been given the signal by the leader or manager of the competition that everything is clear at the winning post, he shall say to the runners in a quiet tone of voice "på Edra platser" ("To your places"); he shall then station himself a little to the rear and at the side of the runners and, when he sees that all the competitors are in their starting-positions and that everything is ready, he shall give the order "färdiga" ("Ready; Get Set"). Simultaneously, he shall lift the pistol above his head, but shall not fire until he has made sure that all the runners have perfect control over their movements, and are standing steadily in their starting-positions. Should he observe, before the pistol is fired, that one of the runners is on the point of falling forwards, he shall let the man do so and then give all the competitors the order to rise from their starting-positions. Then, after a minute or two, he shall repeat the above orders to the runners. If, unfortunately, the starter fires his pistol although he sees that one or more of the runners has started before the signal was given, he shall immediately blow his whistle to recall all the competitors to the scratch-line. On no account must he allow the field to continue if such a false start has taken place. Neither must the starter allow the competitors to run before he has made sure that the numbers of the competitors in the preceding race or heat have been taken down from the number-board and replaced by the numbers of those runners who are now about to start.

The *Judges along the course*, have the task of observing if any of the competitors obstruct another competitor or if he leaves his "lane". In the event of either of these offences against the rules being committed he shall immediately report the matter to the leader or manager of the competition. Two of these judges shall station themselves in suitable places somewhere along the course and one shall place himself in a line with, and directly facing, the track. If requested to do so, the judges of the course shall examine whether the "lanes" have been drawn properly.

The leader of the *Timekeepers* shall distribute the stop-watches amongst the acting timekeepers, and is responsible for the watches being set right every day. All the timekeepers shall place themselves in a straight line with the tape-line at the finish. Only for the first man shall the time be taken with 3 watches. Should only 2 of the 3 timekeepers' watches give the same time, that time shall be taken which is given by the 2 watches. If all the watches give different times, the mean shall be taken. If 1 of the watches does not act properly during the course of the race, the worst time shown by the two other watches shall be taken. At the conclusion of the race, the timekeepers, under the presidency of their leader, shall hold a meeting for the purpose of comparing the times shown by the watches, and of having the times officially fixed. At this meeting, only the said leader of the timekeepers and the other timekeepers shall be present. The times are then communicated to the secretary, who shall enter the report in the minutes in due course.

The *Secretary* shall station himself at the finish; he shall make a minute of the times of the different runners and of the placing of the competitors in each heat, and he shall immediately communicate the same to the proper functionary at the result-board. It shall also be the duty of the secretary to see that the figures from the foregoing race or heat have been taken down from the result-board in good time before the next start. When heats are run, the secretary shall make a note, at the close of each heat, of the runners who are entitled to continue the competition. Immediately after the competition is finished he shall have the minutes

signed by the leader of the judges at the finish, after which he shall sign them himself, and then deliver them at once to the chief leader or manager of the competition.

The *Orderly* is responsible for the track and lanes being properly marked with lane-, start-, and finish-lines. When, immediately before a competition, the runners gather at the start, he shall call over their names and then proceed to let them draw lots for the lanes; he shall also see that all the runners are wearing their correct numbers. It is also his duty to see that the numbers of each heat and of the runners in the heat are placed on the starting-board in the order in which the competitors are stationed, reckoning from left to right; he shall also see that these figures are taken down from the starting-board as soon as the runners have got away. In the 200 metres' flat, the orderly shall also take care that the starting-holes made by the runners in the 100 metres' race have been filled up; he shall also be answerable for the ropes marking the lanes in the curve being placed correctly, and in good time.

General Regulations for the Officials for the Marathon Race.

The officials here will be similar to those for the other long distance races, with the exception of there being no lap-counters, while there will be a number of control-officials along the course, together with a *Chief Steward* of the race.

There will also be a number of attendants along the course. Depots for bandages and medicine etc.; stations for the medical attendants, etc., will be made in readiness by the chief steward of the Marathon course.

The Marathon Race will be run along a country road, with the start and finish in the Stadium.

Each entry must be accompanied by a medical certificate respecting the health of the intending competitor, and just before the start, the competitors will also be obliged to submit to a medical examination made by the doctors officially appointed by the Swedish Olympic Committee, the doctors then recommending the grant or the refusal of a permit to the intending competitor.

Competitors must not, under penalty of disqualification, take drugs of any kind, either at the start, or during the progress of the race.

The *Control Officials along the Course* shall make a note of the numbers worn by the runners that pass them. The numbers shall be fastened on the breast.

General Regulations for the Officials for the Running High Jump, and the Standing High Jump.

At each jumping-pitch there shall officiate 3 judges, 1 secretary and 1 orderly, and, in addition to these, an assistant to place the cross-bar in position, and a man to attend to the result-board.

The *Judges* have the task of seeing that the rules of the competition are strictly observed; they are also entrusted with the technical management of the competition, and are responsible to the leader or manager for this being carried out properly. They shall check the height of the bar at its middle point, and must see that the bar lies at the same height on each support.

The judges shall dictate to the acting secretary the results obtained, and two of them shall themselves make notes of them, for the purpose of checking the written report of the results. Immediately after the close of the competition, the judges shall sign the report written by the secretary, which will then be the official one.

The *Secretary* shall register the minutes of the entire competition; he shall enter the time when the competition began and ended and any noteworthy circumstances occurring during the competition; he shall see that the height of the bar is properly and correctly announced; he shall inform the orderly and the judges when any competitor retires from the competition, and, immediately after the close of the competition, shall take steps to obtain the signatures of the judges to the minutes, which must then be given to the leader of the competition without any delay, after the secretary himself has signed them.

The *Orderly* shall see that only apparatus approved of by the Committee is supplied or employed; he shall have the said apparatus at hand, and have it removed, in good time, and shall call over the names of the competitors. He shall superintend the distribution of the numbers assigned to the competitors, and see that these are in agreement with the programme; during the course of the competition he shall be present amongst the competitors and see that, when the names or numbers of the latter are called out by the judges, the competitors are ready to start in the order given in the programme; he shall see that the competitors remain in the neighbourhood of the start and that they do not hinder each other, and that they obstruct the view of the public as little as possible.

General Regulations for the Officials for the Running Broad Jump, the Standing Broad Jump, and the Hop, Step and Jump.

There shall be 3 judges, 1 secretary, 1 orderly, 1 attendant for the apparatus for levelling the ground after the jumps, and 3 persons at the result-board, one of whom shall receive the secretary's orders, and be responsible for the correct figures being shown.

The *Judges* shall see that the rules of the competition are strictly observed. One of them shall place himself at the take-off board, and the other two at the pit. The first mentioned shall see that the competitor's foot does not pass the take-off line, or crease. The two latter judges shall measure the results of the jumps. The judge that stands at the take-off board shall call out the numbers of the competitors in the correct starting order. One of the judges stationed at the pit shall dictate the result to the secretary and both of the judges at the last-named place shall, in order to check the report, make a note of the results obtained by all the competitors in the 3 (or, for those taking part in the final, 6) different jumps.

The *Secretary* shall keep the minutes of the competition; shall note the time at which the competition began and ended, and shall also make a note of any remarkable circumstance attending it.

The Secretary also has the task of seeing that the results of the competition are made public by the functionaries at the result-board. *Immediately* after the finish of each competition, the Secretary shall obtain the signature of the judges to the minutes and then, after he himself has signed them, *at once* give the report to the leader of the competition.

The *Orderly* shall see that only apparatus approved of by the Committee is provided or employed; he shall have the said apparatus at hand, and have it removed, in good time, and shall call over the names of the competitors. He shall superintend the distribution of the competitors' numbers and see that these are in accordance with the programme; he shall be present amongst the competitors during the course of the competition and see that the competitors are ready to start in the order given in the programme, but not before they are summoned by the judges. He shall see that the competitors remain in the neighbourhood of the start and that they do not hinder each other, and that they obstruct the view of the public as little as possible.

General Regulations for the Officials for the Throwing Competitions.

There shall be 5 judges, 1 secretary, 2 orderlies, 3 persons to attend to the result-board, and 2 to carry the hammer or discus, etc., back to the competitors.

The *Judges* shall see that the rules for the competitions are strictly followed. Three of them shall be placed near the hoop or circle, or at the crease, and two in the field within the throwing-sector. The 3 judges at the hoop or the crease, shall place themselves on different sides of it, but not farther off than that they can quite clearly observe the action of the thrower, especially the placing of his feet, when he takes his start and makes the throw. All the 3 judges stationed at the hoop or the crease have, in common, the task of deciding whether a competitor oversteps the line; 2 of them must have seen the fault before the throw can be declared invalid.

One of the 3 judges just mentioned as standing at the crease or ring, shall call out the number or name of the competitors in the order in which they are to start according to the programme, after he has ascertained from the secretary that the throw made by the competitor immediately preceding the new man has been noted and made public. One of the judges at the crease shall, when the throw is to be measured, hold the measuring-tape at the place where the hammer, etc., pitched, while the other 2 judges shall read off the result at the take-off mark; he shall then make a note of the result of the throws made by each competitor (this in order to be able to check the report) and shall then dictate the result to the secretary.

The 2 judges in the field shall place themselves one in each half of the throwing-sector; the only task of these two judges will be to decide the nearest point from the pitch of the hammer, etc., to the centre of the ring or hoop, or, in the case of throwing the javelin, to decide the perpendicular distance from the crease, and to point out to the orderly in the field, who, if possible, shall always be in the immediate neighbourhood of one of these two judges, the spot where the marking-flag is to be placed. When the length of the throw is taken, the measuring-tape shall be placed at the spot where the marking-flag is fixed.

The *Secretary* shall keep the minutes of the competition; shall note the time when the competition began and ended; he shall make a minute of any remarkable circumstances attending the competition; he shall see that the result of every throw is communicated to the public by means of functionary at the result-board; and shall, immediately after the close of the competition, give the chief manager of the competition the minutes, when they have been signed by the judges and the Secretary himself.

The *Orderlies*, who are 2 in number, shall have the task in common of seeing that the lines which have to be marked on the ground are made in good time before the competition begins, and that the little streamers showing the previous Olympic records are in their proper places. They shall also see that no other apparatus is used than that supplied by the Swedish Olympic Committee for Athletics. One of these orderlies shall call over the names or numbers of the competitors, and shall stay amongst the competitors during the course of the competition. He shall see that all the competitors carry their start-numbers and that they start in the order in which they come in the programme, and not before they have been summoned by the judge. He shall also see that the competitors remain in the neighbourhood of the start, that they do not hinder each other, and that they obstruct the view of the public as little as possible. The other orderly shall be stationed in the field, within the throwing-sector. It shall be his task to assist in using the measuring-tape; he shall place the measuring-stakes and streamers in the right places, and shall allow no others than authorized persons to remain near the place where the competition is being held.

INSTRUCTIONS FOR THE OFFICIALS FOR THE CYCLING ROAD RACE ROUND LAKE MÅLAR.

The Leader.

The management of the Cycle Road Race round Lake Mälär shall be under the supreme control of the leader, or manager, who shall be assisted by leader's adjutants, and shall be responsible for the proper carrying-out of the competition.

The leader shall decide all doubtful questions. In the event of the leader being unable to decide the matter, he shall refer it to three "commissaires de course", who shall be the highest court of appeal for this competition.

All protests shall be sent in to the leader, who shall then place them in the hands of the commissaires of the competition.

The leader shall supply the nation leaders of the teams with any information they may ask for.

The leader shall see that the result is made public, and the standard of the winning nation shall not be hoisted until the leader has ordered it to be done.

The minutes of the race, or other information respecting the competition, shall not be supplied to the Press unless with the consent of the leader.

The Leader's Adjutants.

Communications between the officials, or the competitors, and the leader shall be carried on through the leader's adjutants, who are enjoined to carry out the orders of the leader in other respects as well.

The leader shall determine which of the adjutants shall be stationed at the start and which of them at the finish; those that have to be present at the starting place shall be there at 1 a. m., and those that are stationed at the finish shall be at the Stadium at 12, noon, unless other arrangements are made.

Unless the adjutants are carrying out any special commission, they shall remain in the company of the leader.

Those of the adjutants that, in accordance with the division of the work made between them with the consent of the leader, are to be stationed at the finish, shall be present at the Stadium from 12, noon.

The Judges.

The judges shall present themselves at the finish immediately after it has been reported that the competitors have passed Järfva.

The judges shall place themselves on an elevated stand at the finish, and in a line with the tape. If more than one competitor is expected to pass the post at about the same moment, several judges shall be present, so that each one may take his own man. If absolutely necessary, the leader's adjutants may act as judges.

In the event of several competitors arriving about the same time, the judges, after having taken the results, shall confer together, no one but the judges being allowed to be present at the meeting. The decision of the judges shall afterwards be dictated to the secretary for the competition, to be entered in the minutes.

The decision of the judges is final.

The Starters.

The starters shall be present at the starting place from 1 a. m., but they shall be allowed to act alternately in order to carry out their task properly, the arrangement come to respecting the division of the work having to be submitted to the approval of the leader.

The starters, with the assistance of their adjutants, shall see that the competitors are in their places in proper time, and, at the times fixed, they shall give the order for the competitors to start.

The words of command shall be:

- a) $\frac{1}{2}$ minute before the start "Sitt upp".
- b) 5 seconds » » » "Färdiga" (Ready)
- c) at the moment fixed for
the start: "Gå" (Go).

The starters shall see that the competitors are provided with their respective numbers, which must be attached in the right place.

If a competitor arrives too late for his proper start, the starter has the right to allow such competitor to start, but, in calculating his time, his original starting-time shall be reckoned, unless there be sufficiently good reason for the leader to decide otherwise.

From 1 p. m. the starters shall officiate in the Stadium as adjutants of the leader

The Starter's Adjutants.

The starter's adjutants shall present themselves at the starting place at the same time as the starters, viz., 1 a. m.

Theirs, in the first place, is the task of seeing that the competitors are ready at the start at the right time. They shall be subordinate in all respects to the starters. They shall also make sure, in good time, that the competitors have their correct numbers.

The work of the adjutants on duty shall, with the approval of the starters, be divided between them in such a way that no hitch will arise in the starting.

Of the adjutants, two shall be told off to receive the clothes of the competitors and to assist the latter to make their things into bundles, and, for this purpose, the two adjutants shall be provided with number-labels which they shall affix to the various bundles of clothing. These adjutants shall be responsible for the competitor's clothes, which they shall place in sacks provided for the purpose; these shall then be tied with string and labelled with the names and dressing-room numbers of the owners. After all the competitors have started, the sacks containing the clothes shall be conveyed by these two adjutants to the Stadium and there placed in the proper dressing rooms of the competing nations.

The starter's adjutants shall, if so ordered by the leader, act at the Stadium as orderlies.

The Secretaries.

The secretaries shall have the chief responsibility for the proper and orderly carrying-out of the clerical work of the competition at the Stadium and the office there.

They shall officiate at the start and at the finish and, in addition to this, in accordance with the scheme drawn up by the leader, act as heads of the telephone room and office, where one of them must always be present from 1 a. m.

The secretaries shall scrutinize all reports that are to be given to the manager of the result-boards for display there, or which are to be made public in any other way, and nothing may be given out from the office without their consent.

The final report shall be signed by all the secretaries, and shall then be delivered to the leader.

The Leaders of the Timekeepers.

These shall be responsible for all the watches used during the course of the competition, and for their showing the correct time. The said watches must be able to show $\frac{1}{5}$ of a second.

At the starting-place, one of the leaders of the timekeepers shall be present from 1 a. m., in order to control the two ship's chronometers which must be in readiness at the starting-place. The leader in question shall be responsible for the two ship's chronometers being properly conveyed to the Stadium as soon as the start is over.

The leader of the timekeepers who was present at the start shall afterwards see that the watches used by the timekeepers at the Stadium are right, and he shall perform this task several times during the course of the day.

The leaders of the timekeepers shall divide the work between themselves and the other timekeepers, in accordance with a scheme of work which must be approved of by the leader of the competition.

One of the leaders shall always be present when the times taken are being read off, no other persons being allowed to be present with the exception of the said leader and the timekeepers.

Three watches shall always be used for the purpose of taking the time made by each competitor (see below).

From 1 p. m., one of the leaders of the timekeepers shall always be stationed at the finish.

The Timekeepers.

Those timekeepers who, in accordance with the scheme of work drawn up, have to be in attendance at the finish from 1 p. m., shall be answerable for the watches placed in their charge.

When these timekeepers are about to take the time of any competitor, they shall place themselves in a straight line with the tape.

In taking the time, three watches shall be used for each of the competitors. If, when three watches are employed, two of these show the same time, and the third a different time, that time shall be reckoned which is shown by the two watches. Should all the watches show different times, the mean time of the three watches shall be reckoned. If one of the watches goes wrong, then the worst time shown by the two remaining watches shall be taken.

After the times have been taken, the timekeepers shall meet for the purpose of reading off the times of the various competitors. No one else but the timekeepers shall be allowed to be present at this meeting.

Some of the timekeepers shall be told off by their leaders to be present at the start.

The timekeepers shall be under the immediate control of the leaders of the timekeepers.

The Telephone Service.

(The Telephone Attendants.)

The telephone attendants shall share the work between them, in accordance with the scheme drawn up by the functionaries appointed by the leader of the competition to act as the chiefs of the office work, and they shall be in attendance in the office at the Stadium from 1 a. m.

The telephone attendants shall divide the work between them in such a way that some of them shall receive and send the telephone messages, while the others shall make minutes of the times sent in from the various stations along the course.

At the times fixed by the secretary, the telephone attendants shall also give information to the officials at the result-board.

When the report has arrived that any of the competitors have passed Järfva, written notices of the fact shall at once be given to the leader of the competition, to the judges and to the leaders of the timekeepers.

At the Result-Boards.

The officials acting here, shall present themselves at the Stadium at 2 a. m., for the purpose of publishing on the result-boards the times made by the competitors, which have been sent in by telephone from the various control stations along the route.

The officials in question shall stand under the immediate control of the secretaries in charge of the office.

The Orderlies.

It shall be the duty of the orderlies to assist, both at the start and at the finish, in the task of maintaining order, preventing all crowding, etc. They shall also endeavour to give such information as may be asked of them by the competitors or by other officials.

The orderlies, who shall be under the immediate control of the leader or manager of the competition, shall be present both at the starting-place and at the finish, in agreement with the scheme of work drawn up by the leader. Those orderlies that have to be present at the starting place, shall be there at 1 a. m., while those that are to be present at the finish, shall be at the Stadium not later than 12, noon.

The Control Officials along the Course.

The control officials, who shall be sent from Stockholm, are so-called secret control officials, who shall receive their special instructions from the leader of the competition.

When anything of importance happens, these officials shall report the same at once to the leader, or else to his adjutants, to be conveyed by them to the leader.

The Medical Attendants.

The doctors, at an hour to be determined later on, shall, before the start, examine all the competitors and, if necessary, advise against any competitor who is unfit being allowed to take part in the race. Certain items of information, serving to show the condition of the competitors and their fitness for the race, shall be entered on special printed forms.

The medical men shall also be present at the finish, to undertake the care of, and examine, the competitors, on their arrival at the Stadium.

The medical attendants themselves shall make up a scheme for the division of the work, and shall then send the plan to the leader of the competition.

The Medical Adjutants.

Their task shall be to assist the doctors, and to accompany them to all the places that may be desired. They shall stand under the immediate control of the doctors.

The Press Adjutants.

The Press adjutants shall be present at the start and at the finish, for the purpose of supplying the Press with all necessary information. They shall divide the work between them in accordance with a fixed plan.

They have the right to learn the contents of the minutes of the race, but, should they desire any further information, this can be had of the leader of the competition alone. If they obtain news from any other source, they, and they alone, shall be responsible for its correctness, etc.

The Press adjutants have not the right to act themselves as journalists.

Disengaged Officials.

Those functionaries that happen at any time not to be on duty are bound to perform other work than their ordinary duties if requested to do so, and shall, therefore, remain at the place appointed by the leader.

Attendants for keeping order.

These attendants are under the direct control of the leader of the competition, and will receive special instructions from him.

Attendants for keeping order shall be stationed at the starting place, and along the route, Järfva—Stockholm.

INSTRUCTIONS ISSUED TO THE OFFICIALS AT THE CONTROL STATIONS IN THE CYCLING ROAD RACE ROUND LAKE MÄLAR.

The Management.

The chief management of the Cycling Road Race round Lake Mälär shall be in the hands of the leader of the competition, who shall be assisted by officials in Stockholm (at the start and at the finish), and at the following control stations Södertälje, Mariefred, Strågnäs, Eskilstuna, Kungsör, Köping, Kolbäck, Västerås, Enköping, Bålsta and Järfva.

Instructions to the Officials.

Special instructions have been drawn up respecting the competition for the officials at the various stations, and shall be observed by each functionary in regard to those parts applying to him.

P. M. for the Competitors.

A special P. M. for the Competitors has been drawn up.

The composition of the Control Committees.

The Control Committee shall consist of a chairman and a secretary, and the number of members that may be found necessary for each station, and a scheme shall be drawn up for the proper division of the work between them.

The following points shall be observed with respect to the special functions represented in each of the committees, either by one of the ordinary members of the committee, or by an adjoined member:

a) there shall be a special person to superintend or undertake the cycle-repairs it may be necessary to carry out;

b) there shall be persons at hand able to speak foreign languages, the following languages being represented, if possible, in the order given here, viz., English, German, French, Russian, etc.;

c) a doctor shall be instructed to be at hand in the event of his assistance being necessary;

d) an attempt shall be made to interest the local Press in the race, so that the public of each locality may learn about the coming competition.

The arrangement of the Control Stations.

The control stations shall lie in the immediate neighbourhood of the road along which the competitors are to ride, and they shall be arranged in the best possible way.

A proper *room* or *rooms* shall be accessible (and, in the event of the weather being cold, shall be heated), for the reception of any of the competitors that may fall sick, be injured, or, for any other reason, be obliged to retire from the competition altogether, or for a short time.

Right across the road, immediately in front of the control station, there shall be stretched a piece of white canvas on which there shall be written in large, black letters the word "Kontroll". These signs will be supplied by the Stockholm (Cycling Race) Committee.

A special enclosure shall be arranged at the control stations, so that the competitors may be protected from all idle curiosity on the part of the public, etc.

The officials at the control stations are advised:

a) to prepare a special place to which the public can have access on payment of a charge for admission;

b) to give the whole a certain festive appearance by means of flags and other decorations;

c) to publish, on special result boards, the times of the competitors on passing all the control stations, in order to awaken or sustain the interest of the public in the race.

There shall be special preparations made for the competitors to be able to wash themselves at the stations, for which purpose the committees shall have water, soap, sponges and towels in readiness.

The committees are enjoined to most carefully watch over the reserve cycles left at the control stations, and to assist the competitors in every way with advice and other help.

Refreshments.

Suitable *food*, such as eggs, sandwiches, broth, oranges, etc., shall be provided for those of the competitors that may wish for it.

Such *liquid refreshments* as fresh water, cold tea, milk (not cold), and lemon squash, will probably be found the best. No beverages containing alcohol may, on any account, be offered the competitors.

Respecting those competitors that retire from the race.

The control committees shall at once telephone to the Cycling Committee when any competitor informs them that he has retired from the competition.

Information respecting accidents shall also be telephoned at once to the Stadium.

Stretch of course to be watched over.

Each control station is responsible in every way for its special stretch of the course i. e., each control station shall have under its superintendence, control, etc., that part of the course lying between the said station and the following station on the way *towards* the finish. For example, the station at Södertälje shall be responsible for the distance, Södertälje—Mariefred, while Mariefred shall be answerable for the stretch Mariefred—Strängnäs, etc.

Along its stretch of the course, each control committee shall:

- a) do its utmost to have the course clear and in order for the competitors;
- b) see that the bridges the competitors have to cross are practicable;
- c) appoint at least two control officials (timekeepers), at each place where there is a bridge across canals, for the purpose of calculating the time lost by the competitors in the event of a drawbridge being open;
- d) request the local police authorities to do their utmost to assist in the maintenance of order;
- e) Set up red arrows (which can be had of the Stockholm Committee) at all crossroads where it is possible for the competitors to take a wrong turning.

Secret Control Officials.

Along its special part of the course, each control committee shall place two secret controllers of the course for the purpose of seeing that no pacing takes place, and in order to assist in the maintenance of order, etc.

Canal and Railway Bridges.

The Cycling Committee has written to all the Canal Companies, Transport Companies and other Companies making use of the canals, and to the Directors of the Stockholm—Västerås—Bergslagen Rly. Co., begging the first-named to keep all canal-bridges closed to traffic, and the latter to have all bars at railway crossings raised, during the progress of the race.

This request has been granted, with the exceptions mentioned below respecting the canal-bridges.

As regards railway crossings, the S. V. B. Railway Co. has promised that the bars shall not be lowered until the very moment the trains pass, so as to make the possible loss of time as little as possible.

As, in any case, it is possible that a canal bridge may happen to be open, there shall be control officials stationed at every canal bridge along the course, during the whole of the competition, as mentioned above.

This step should be taken at the railway crossings, too.

Compensation for loss of time.

In consequence of what has been stated above, the Cycling Committee has determined that a time deduction will be made for those competitors that are compelled to stop to allow of a canal bridge being opened for the passage of a vessel, the deduction being equal to the length of the delay caused.

No such deduction shall be made, however, to compensate for the time lost at a railway crossing.

Telephone Arrangements,

At each control station there shall be at least one telephone, which shall be so close at hand that there will be no loss of time in using it.

Should there be both the Riks (State) Telephone and the Allmänna Telephone Co.'s Lines at hand, there shall be an apparatus of each sort at the control station.

The Stockholm Committee has applied to the Director of the State Telegraphs and to the Stockholm (Allmänna) Telephone Company, begging them to take every measure possible to facilitate matters in this respect, and this both Companies have most kindly promised to do.

All the telephone stations concerned will be open the whole of the time, for the purpose of forwarding our messages, as long as the competition lasts, and, consequently, will be open during the night too.

Your Control Committee is enjoined to immediately make all the necessary agreements with the Telephone Line Engineers, or with the Managers of the respective telephone offices, respecting the detailed arrangements that your Committee may consider it necessary to make, such as, the coupling-on of extra telephones or wires, etc., so that everything may be carried out to the general satisfaction.

Telephoning.

Each Control Station shall telephone to the Stockholm Committee at least once every half hour, respecting the time of arrival of the various competitors at the stations.

The control stations shall not unnecessarily ask the Stockholm Committee for information respecting the progress of the race, but shall apply for that purpose to that control station which has taken the times it is desired to learn.

When telephoning to the Stockholm Committee, these control stations that have both Riks and Allmänna telephones (i. e., those stations lying nearer to Stockholm), shall chiefly make use of the Allmänna telephone, so as to give the more distant stations an opportunity of communicating with the said Committee by means of the Riks telephone.

Control Lists.

Control lists, containing the name, nationality, starting-time, etc., of the competitors, shall be provided by the Stockholm Committee, and, immediately after the last competitor has passed any control station, or as soon as there is no reason for any further delay, the station in question shall send a copy of the list, properly filled in, by "*Express post*", to Captain G. Drake, 18, Grefnagnigatan, Stockholm.

Taking the Time.

The times of the competitors shall be taken at every control station, and notes respecting them shall be entered in the lists which will be specially provided for this purpose.

If chronometers cannot be obtained at the place by any control station, the fact must be reported to the Stockholm Committee.

The Sale of Programmes.

The sale of programmes shall be arranged suitably and cheaply, so that each control committee may be able to obtain the greatest possible profit.

If possible, the sale of programmes shall be arranged for at suitable places along that part of the course for which each control station is responsible.

That number of programmes each control committee supposes it can sell, shall be obtained from the Stockholm Committee.

Signing the Control Lists.

At the control station at Köping, each competitor shall substantiate his having passed that control station, by signing the control lists there.

The Press and the Public.

By means of notices in the local papers, etc., the respective control committees shall inform the public:

of the hours between which the competition will continue, and of the roads along which the race is to take place. The public will also be requested

a) to assist the competitors in every possible way (but not by means of pacing, however);

b) to keep the roads as free as possible and, consequently, not to meet or to follow the competitors on bicycles;

c) not to give the competitors any help by means of pacing, leading or pushing them or their machines.

Financial Arrangements.

Each control committee shall manage its own financial arrangements.

Its income is supposed to be gained by the sale of programmes and from the charge made for admission (see the § respecting arrangement of control stations).

It is desirable, of course, that the control committee shall limit its expenses as far as can be done, so that, if possible, it will be able to make ends meet. The competitors must not suffer, however, by the arrangements made for this purpose.

As soon as possible after the close of the competition, the accounts, properly entered in the books, and with the lists of expenses and receipts duly verified, shall be sent to the treasurer of the Stockholm Committee, O. Kræplin, Esq., Amerikansk Cykelimport, Stockholm.

Freedom of action of Control Committees.

If a Control Committee find it necessary, it shall apply direct to the proper authorities, directors, etc., respecting matters that can tend to the successful carrying-out of the competition, both as regards the control station in question, and also the stretch of the course for which the committee is responsible.

In all other matters, applications shall be addressed to the Cycling Committee.

Special Instructions.

For the *Södertälje Control Station*.

As the Canal Co. is not able to close the bridge to all traffic by water, but is obliged to open it to allow of the passage of four (4) boats that are expected to pass during the time the competition is going on, it will be necessary to make arrangements for proper timekeeping to the east of the canal bridge, for the purpose of being able to calculate the time to be allowed as compensation for delay.

Apart from this, the Canal Co. has promised to keep the canal bridge closed between the hours of 2.45 a. m. and 9.15 a. m. on the 7 July.

For the *Eskilstuna Control Station*.

Special attention shall be paid to the canal bridges wherever it is considered necessary.

For the *Kungsör Control Station*.

Special attention shall be paid to the road across the bridge to the west of the control station.

Application has been made to the authorities for permission to have the bridge closed for the passage of vessels between the hours of 6 a. m. and 2 p. m.

For the *Köping Control Station*.

Special care must be paid to the bridge across the river.

For the *Kolbäck Control Station*.

Special attention shall be paid to the canal bridge across the Kolbäck river.

The authorities have consented to close the bridge for boat traffic between the hours of 8 a. m. and 4 p. m.

For the *Enköping Control Station*.

Special attention must be exercised in the Ekolsund district. so that, if possible, all the competitors shall take the same way.

For the *Bälsta Control Station*.

The Control Committee shall be responsible for that part of the course lying between Bälsta—Kungsängen. The Stockholm Committee will be responsible for the bridges at Stäket.

For all the Control Stations north of Lake Mälär, from Köping to Stockholm.

The very greatest attention must be paid to all railway crossings, and at all such crossings lying in the same plane (i. e., with no bridges) there shall be stationed control officials (outposts) the whole of the time the race lasts, for the purpose of giving assistance to the officials guarding the line.

As may be seen from what has been stated above, the Stockholm Committee has applied to the Stockholm—Västerås—Bergslagens Rly. Co. for help in the matter referred to; this assistance has kindly been promised, and in collaboration with the Railway Co., the time of the race has been so calculated that the competitors can be expected to pass Köping between 7 a. m. and 3 p. m., and Kungsängen between 11.30 a. m. to 9.30 p. m.

As regards the control stations lying between these two points, the local committees themselves should be able to calculate the approximate hours between which the competitors may be expected to pass the various control stations and crossings.

For the Järfva Control Station.

When a competitor passes the control station, news must be telephoned at once to the finish at the Stadium.

INSTRUCTIONS FOR THE OFFICIALS AT THE COMPETITIONS IN GYMNASTICS.

List of Officials.

I. The leader or manager. II. The leader of the team competitions I—III. III. The leader of the individual competition. IV. The leader of the displays. V. The chief storekeeper. VI. The secretary of the competition (the head of the Gymnastic Office of the Games). VII. The chief steward (orderly). VIII. The adjutants. IX. The leaders of the groups in the individual competition.

The Chief Management.

The chief management of the competitions and displays in gymnastics shall be in the hands of the leader or manager, who shall be assisted by the other officials.

General Instructions.

1. The officials shall assemble daily before the commencement of the competitions and displays, at a fixed hour (usually 8.30 a. m.), at the Gymnastic Office of the Games at the Stadium, at which meeting each leader or chief shall state the scheme of work, etc., for the day, and detailed orders shall be given.

2. The leaders of the various divisions and the chiefs of the different groups shall each be responsible to the leader of the competition for his special division of the work.

3. All the officials shall devote all their energy and attention to their tasks during the course of the Games, and, if required, they shall assist in the performance of other work too.

4. The leaders or the chiefs of the various groups should, therefore, state at the morning meetings the number of extra assistants, adjutants, timekeepers, etc., they may require.

5. All gymnastic officials shall wear on the upper part of their left arm a light-blue ribbon, crossed in the middle by a narrow yellow one. To the ribbon worn by the chief leader of the competitions there shall also be attached a yellow St. Andrew's Cross, while, on that worn by the three assistant-leaders, there shall be a yellow vertical band, and on that worn by the judges, a yellow circle.

6. Officials are allowed to be present in the arena only when in the exercise of their office.

I. The Chief Leader or Manager.

The chief direction of everything connected with the gymnastic competitions shall be in the hands of the leader or manager; the other officials shall assist him.

The leader shall give the other officials their instructions; he shall assign each one his sphere of work and superintend the whole.

Together with the leader of the *team competitors I—III* he shall held a meeting of the judges for these various competitions and shall then:

- a) take steps for the election of a chairman of the judges, to be nominated by and from among themselves;
- b) in the presence of the judges, open the envelopes containing the programmes of the competitions, distribute 5 copies and then seal up the remaining programmes;
- c) request the judges to peruse the programmes and to come to an agreement respecting, 1) the method of judging the gymnastic movements occurring there, and, 2) the consideration to be paid to possibly varying conditions of the weather;
- d) remind the judges that, during the progress of the competitions, no debate shall be allowed respecting the judging, although questions may be raised respecting other matters, such as the position of the apparatus, or the calling attention to the fact that all the competitors are not executing all the movements, etc.;
- e) show and explain the minutes-form; remind the judges that they have to sign it, and point out the place where the names are to be written;
- f) inform the judges where the Gymnastic Office is situated, and of the hours when it is open;
- g) inform the judges that no judging may take place after the close of the time allowed, and that the leader of the competition will inform the chairman of the judges when the said time has elapsed;
- h) inform the judges that the rules of the competition, minute-forms and pens can be had at the scene of the competitions.

The chief leader, together with the leader of the *individual competition*, shall hold a meeting of the judges of this competition and shall then:

- a) take steps for the election of a chairman of the judges, to be nominated by, and from amongst, themselves;
- b) instruct this chairman to determine the positions of the judges at the various apparatus, and to give the chief leader a written statement of the divisions thus made;
- c) shew the judges the minutes-form and explain it, and remind them that the minutes have to be signed;
- d) inform the judges where the Gymnastic Office is situated, and of the hours when it is open;
- e) inform the judges that the leaders of the groups are also timekeepers, and that the latter will give a signal with the gong when the two minutes are ended;
- f) inform the judges that the rules of the competition, minute-forms and pens, are to be had at the scene of the competition.

The chief leader and his adjutants shall have their principal station in the arena, in the neighbourhood of the group competing. Should the leader leave his place while a competition is going on, the adjutant there must be able to inform inquirers where he is to be found.

The chief leader shall be informed by the various sub-leaders (leaders of the competitions) when everything is ready for a competition or display to begin.

Should anything arise to cause a delay in the execution of any exercise at the time fixed, the chief leader shall be informed of the reason of the delay.

Should there arise a difference of opinion which cannot be decided by the sub-leader, the matter shall be referred to the chief leader. If he is unable to settle the matter satisfactorily, it must be sent for decision to the International Jury for Gymnastics.

The chief leader shall see that only properly authorized gymnastic officials are present in the arena.

The chief leader shall receive the minutes from the secretary and shall sign them. After this has been done, the minutes are official, and may be placed at the disposal of the Press. The chief leader shall order the results to be announced

by means of a megaphone, in Swedish and in English, and shall see that the proper standards are hoisted.

The chief leader shall decide all questions that may arise during the progress of a competition, and for which arrangements have not been made by these instructions.

II. The Leader for the Team Competitions I—III.

The leader, who shall be assisted by an adjutant, shall, the day before the competitions begin, inform the chief storekeeper, in writing, of the apparatus that will be required and of the places where it has to be placed (if necessary, he shall show this by means of a sketch). In the event of there being several competitions to be held on the same day, a written list of the apparatus necessary for each competition shall be given to the storekeeper.

The leader shall inform the competing teams of the time when the event is to take place; of the places for their entrance and exit to and from the Stadium; of the position of the apparatus; of the stations of the chief leader, the doctors, etc.

The leader shall demand from the leader of each competing group a list of the names of the competitors.

This list shall be given to the secretary not later than 1 hour before the beginning of the competition.

The leader, together with his adjutant shall, before the beginning of the competition, make certain that everything is in readiness in the arena, and that all the judges are there too. If necessary, he shall have reserve judges called.

The leader shall have the minute-forms and pens fetched from the Gymnastic Office before the competition begins, and shall have them given to the judges.

The leader shall have envelopes for the minute-forms, rules of the competition (in all languages), and pens, at hand at the scene of the competition.

The leader shall remain in the vicinity of the place where the competition is being held, and shall make (or shall let his adjutant make) notes concerning the progress of the event. The adjutant of the secretary for the competition shall also make similar minutes.

The leader has only to follow the course of the competition, and must not interfere before something occurs conflicting with the rules, in which case information shall be sent by the leader to the chairman of the body of judges.

The leader shall see that the time allowed by the regulations is not exceeded, and, when necessary, he shall inform the judges when the time is up.

The leader shall see that resin, sand, towels and chalk are provided at the place.

After the close of the competition, the leader shall receive the minutes *which have been signed by the judges*; he shall place the said minutes, together with the account of the competition, in an envelope, which must then be sealed and given to the secretary of the competition.

When the last competition in one group is finished, the leader shall request the judges to sign the general protocol at the Gymnastic Office.

III. The Leader for the Individual Competition.

This leader, who shall be assisted by an adjutant and 3 or more group-leaders, shall, the day before the competition begins, inform the chief storekeeper, in writing, of the places where the apparatus has to be placed, and, if necessary, send a sketch of the positions.

The leader shall see that the competitors receive their numbers, marked on pieces of linen, etc., which have to be sewn to their clothes.

The leader, assisted by his adjutant, shall, before the beginning of the competition, see that everything is in readiness and that the judges are present, after which, the chief leader of the competition shall be informed of the fact. Before the competition, he shall have minutes-forms and pens fetched from the Gymnastic Office and shall have them given to the judges.

The leader shall have envelopes for the minute-forms, the rules of the competition in all languages, and pens, at hand at the place where the event is to be held.

The leader shall inform the competitors in good time of the hour and place for the competition, and of the entrance to, and the exit from the Stadium.

At the appointed hour, the gymnasts shall be arranged in groups, with not more than 12 men in each, and in numerical order, so that the first group shall begin with the lowest numbers.

The dress of the competitors shall be examined, to see if the numbers are sewn on. During the competition these numbers must be worn in such a way as to be visible, and may be fastened to the breast, back or leg of the competitor, at his choice.

The group-leaders shall, in good time, be given instructions and a written plan of the places at which the movements are to be executed, after which they shall take command of their respective groups and lead them to their proper places (or apparatus), in accordance with the plan previously drawn up by the leader. The group-leaders shall also act as timekeepers for their respective groups, and shall give a signal on the gong when each competitor's two minutes are ended.

The leader and his adjutant shall remain on the scene of the competition, and the former shall make notes of the progress of the competition, or shall cause his adjutant to do so.

The leader's task is to follow the course of the competition, and he has not the right to interfere with the judges unless something happens which is in conflict with the rules.

After one group has finished the exercises at one set of apparatus, the leader shall receive the minutes, *signed* by the judges and place them in an envelope, which shall then be sealed and sent to the Gymnastic Office.

When the last competing group has finished, the leader shall request the judges to sign the general protocol at the Gymnastic Office.

The leader shall see that resin, sand, chalk and towels are provided at the places where the competition is going on.

IV. The Leader for the Displays.

The direction of the displays shall be in the hands of a special leader, who shall be assisted by adjutants placed at his disposal on each occasion by the chief leader of the gymnastic competitions.

The leader shall, on the day before the displays, inform the chief storekeeper, in writing, of the places where the apparatus is to be placed (sending, if necessary, a sketch to elucidate matters), and for this purpose the leader shall communicate in good time with the nation-leader of the team.

The leader shall take steps to inform the display-team (its leader) of the time at which the display is to be given; of the places at which the team shall enter and leave the Stadium; of the position of the apparatus; of the spot where the doctor is stationed, etc. The nation-leader of the team shall be requested to give the leader a programme of the display before the event begins.

The leader shall make notes of the way in which the display is carried out.

Should the nation-leader of the team exceed the time allowed for the display, the leader shall call his attention to this fact by striking the gong. If no attention is paid to this signal, the leader has the right to request the team to leave the arena.

The leader shall inform the nation-leaders of the team of these points before the displays begin.

V. The Chief Storekeeper.

All the stores, apparatus, and the like, shall be in the charge of a special chief storekeeper, assisted by an adjutant. It shall be the task of the chief storekeeper

- a) to see that all materials, apparatus, etc., are in proper order, and that spare parts have also been provided;
- b) to see that everything is easily accessible, and that it is protected from the weather;
- c) to see that there are workmen at hand for conveying the materials or apparatus to and from the Stadium, and that everything is in its proper place at the appointed time.

For this purpose, the chief storekeeper shall, the day before such competitions or displays as those now in question take place, request the leaders for competitions I—IV and for the displays, to supply him with a written list of the materials or apparatus required, together with instructions as to the place where it is to be placed or erected, and the time when the competition is to be held.

Should any materials or apparatus be or become defective, the chief storekeeper shall take measures to remedy the defects, and shall inform the chief leader of the gymnastic competitions of the matter, and again, when everything is once more in order.

The chief storekeeper and his adjutant shall be present near the scene of the competitions or displays when these are going on.

Towels, resin, chalk and fine sand shall always be in readiness in the arena

VI. The Secretary of the Competitions (The Head of the Gymnastic Office).

The secretary of the competitions shall also be the head of the Gymnastic Office. This office shall be open between — a. m. and — p. m. when the secretary of the competitions, or his adjutant must be in attendance.

Besides being at the Office in order to supply the public with information, the secretary of the competitions (or his adjutant) shall write accounts of the competitions and displays; shall see that the results shown by the minutes of the competitions are calculated; shall draw up the general protocols, and have them ready for signing by the judges.

As soon as a competition is concluded, the proper leader shall have the minutes of the event sent to the Office in a sealed envelope; these minutes shall at once be calculated, entered in the general protocol and collated. When the judges have signed the general protocol, it shall be given to the chief leader of the gymnastic competitions, who shall then sign it. Not before this has been done is the protocol an official one.

The secretary of the competitions shall take charge of all the minutes sent in by the judges, and all the official descriptions of the competitions or displays.

The accounts of the competitions or displays shall state:

The name and dress of the nation-leader; the number and dress of the team, and its formation on marching into the Stadium, and if a flag was carried at its head; the formation of the troop during the exercises; the arrangement of the movements; the employment of the apparatus, and other details serving to give a picture of the whole (the programme stating the movements to be performed having been previously sent in, there will be no necessity to repeat the list). Among other details there should be given: the leader's manner of commanding; his tone of voice; his signals, and the like; accidents that may have occurred; the direction of the wind; the light; rain; temperature, etc.; the behaviour of the public; applause; indifference; the influence on the execution of the competition or display brought about by other competitions or circumstances, etc.

The secretary of the competitions has not the right to give the Press any information before he has obtained the permission of the chief leader in each several instance.

VII. The Chief Orderly (or Steward).

The chief orderly has the task of seeing that all the necessary notices are put up in the dressing-rooms; of informing the leaders of the various divisions of the time at which the competitions, etc., are to take place; of reminding the said leaders of the fact in good time; of showing the entrance through which the teams have to march into the Stadium; of seeing that the caretakers are stationed in the dressing-rooms, etc.

He shall also see that only such officials as are really on duty are present in the arena.

He is to convey messages between the leaders of the teams and the leaders in other parts of the arena.

VIII. The Adjutants.

The adjutants are appointed to assist the various leaders or chiefs, but the chief leader of the gymnastic competitions can transfer them from one post to another.

IX. Group-leaders in the Individual Competitions.

(Some of the gymnasts that have formed part of the Swedish display team shall be chosen to fill these positions).

When the individual competition is being executed, groups of gymnasts in this competition (not more than 12 in each group), shall be led from one set of apparatus to another in a certain order.

Before the beginning of the competition, the group-leaders shall obtain from the leader of the competition a written scheme showing the order in which these changes are to take place.

The group-leaders shall present themselves in the arena in good time before the beginning of the competition, and shall report themselves to the leader.

Each of them shall previously have procured 12 minute-forms, a list of the names, and numbers of his group, and a gong, and each group-leader shall be provided with a watch showing the seconds.

The judges shall now assume the direction of the competition.

The group-leaders have nothing else to do but to see that the gymnasts of whom they have charge go forward in proper numerical order; they shall then take each gymnast's time, from the moment the judges says "Börja" ('Begin') until 2 minutes have elapsed, the group-leaders shall strike the gong.

When a group has finished its exercises at one set of apparatus, it shall be conducted to the next.

The time of beginning and of finishing the exercises by each group at each set of apparatus, shall be marked on the list of names and numbers.

When the whole of the competition is ended, the lists and the gongs shall be returned to the Gymnastic Office.

INSTRUCTIONS FOR THE OFFICIALS AT THE SWIMMING COMPETITIONS.

The Management.

The direction of everything in connection with the swimming competitions shall be in the hands of the chief leader, or manager, whose task it shall be to instruct the officials, assign each one his task, and superintend the whole; to call meetings, when necessary, and, during the progress of the competitions, to decide all questions that are not specially dealt with in these rules and regulations.

The leader shall give all the officials that are to act at the competitions during the following day, the necessary instructions for carrying out the events; this shall be done at a meeting held each evening at 6:30

The distribution of the officials shall be determined by a chief management, consisting of the leader and three "group-leaders". All the officials must present themselves at the appointed place not later than half an hour before the beginning of their respective competitions; officials acting temporarily shall be in attendance down on the pontoon bridges. Orders shall be communicated either by the leader direct, or through the adjutants. No official has the right to break an order once given. Should there be reason to suppose that an adjutant has conveyed an order incorrectly, the leader should be at once applied to. The same step must be taken should any unforeseen occurrence happen which necessitates an alteration in the original plan.

No competition may be begun without a special order from the leader who, during the course of the competitions, shall be in attendance at his appointed place, where he is visible to all the officials on duty.

No one may make any alteration in a measure already determined on, without having first obtained the consent of the leader.

The three group-leaders who, during the course of the competitions, shall superintend them and the arrangements that have been made, are answerable for the perfect carrying-out of the programme, each of the said leaders for his own part thereof. The other officials must pay unconditional obedience to the orders given by these group-leaders.

Should any dispute arise which cannot be settled by the group-leader, the matter shall at once be referred to the leader. If, in spite of this, the question cannot be decided, the leader shall determine whether the question shall be submitted to the referee or not, or, if the matter concerns the interpretation of the rules of the competition, to the International Jury:

The Leader's Adjutants.

The leader's adjutants shall convey all the orders given by the leader to the respective officials. The work shall be divided between these adjutants in accordance with the needs of the leader. It shall be the task of one of the adjutants to announce in the dressing-rooms, in a way previously determined, the news of the approaching commencement of a competition. For this purpose, the number and name of the competition, and the sequence-number of the heat (when this latter step is necessary) shall be called out in each dressing-room loudly and distinctly, in Swedish, English and French, five minutes before the beginning of the competition in question. One of the adjutants shall be responsible for the proper appearance of the result of the competition on the result-board, and for its oral announcement to the public.

The Referee.

The referee shall decide all disputes that are submitted to his decision by the leader during the course of the competition, in such cases as are not specially dealt with by these regulations. If a competitor misbehaves, or speaks disrespectfully of the officials, competitors or spectators, the referee can order him to withdraw from the competition in question and from the place where the event is being held. The decision of the referee is final.

The Chief Orderly.

Every day, one of the orderlies shall be appointed to hold office for the day as chief orderly. The chief orderly shall be responsible for the maintenance of order at the scene of the competitions, both as concerns officials and competitors. For example, he shall see that no other persons are present at the place reserved for the active competitors, than the officials on duty, the competitors who are taking part in the competition that is going on, and specially authorized persons. The chief orderly shall see that all the officials on duty are at their proper stations before a competition begins. Should any of the officials whose names appear in the programme be absent, the fact must immediately be reported to the leader. The chief orderly shall also see that the necessary notices have been put up in the various dressing-rooms; that a watch is kept in the rooms just mentioned, etc.

The chief orderly shall see that the necessary number of boy-scouts has been asked for.

The Storekeeper.

The storekeeper is under the immediate command of the chief steward for the day. He shall be responsible for the procural and care of all the necessary movable materials, and shall see that a sufficient number of the prescribed balls, flags, caps, etc., are provided at the competing place, in good time before the beginning of the events for which they are wanted. He is also responsible for all the coloured caps, and the various marks for distinguishing the competitors being returned by the competitors immediately after the conclusion of each heat, and that they can be had in sufficient numbers at the starting place, before the beginning of the next occasion when they are to be used.

Should any materials be damaged, or have to be purchased, the storekeeper shall take all necessary steps to repair, or procure, the material in question.

The Chief Steward.

The chief steward shall answer for the maintenance of order in the stands, and shall see that there is a sufficient number of stewards, attendants and policemen present, for the purpose just mentioned, to examine the tickets, and to assign the spectators their proper places. The sale of the tickets at the turnstiles shall also be under the control of the chief steward.

The Secretariat of the Swimming Competition.

The secretariat of the swimming competition shall be divided into two sections, each with its own chief. The chiefs shall see that all the secretaries perform their duties, and that the minutes of the various competitions are given to the leader at the close of each event, so that the result may be announced in the way fixed by the regulations. All the minutes shall be written in duplicate; one for the purpose of being officially adjusted; the other to be shown to the representatives of the Press as a copy of the protocol. When possible, the protocol should be written and ready the day before a competition is held. The results shall be entered in accordance with the instructions of the judges and the leader of the timekeepers. The chief enterer of the minutes of the diving competitions shall see that the calculation of all the protocols of the various judges is begun immediately a competition is ended. There shall, therefore, be as many officials to calculate the protocols as there are judges, and each of the said officials shall take his protocol at once, in order to be able to make his calculations without the least delay. The chief calculator of the minutes shall enter the various results in the general protocol as soon as possible, and shall see that the latter protocol is calculated without any delay. The connumeration of the protocol of the diving competitions must not, on any account, be delayed.

One of the secretaries shall be chosen to collect the information necessary for drawing up the programme for the next day's competitions. He shall be answerable for the perfect correctness of the day's programme, which shall be printed each day.

In the protocol there shall be entered all details that can be of value, such as, the direction of the wind: the state of the weather; any accidents that may have occurred, and other circumstances that can be considered as having influenced the results of the competitions.

The Swimming Competition Office at the Stadium.

The Secretariat shall have the task of opening a special Swimming Competition Office at the Stadium, which shall be open at the hours when competitions are going on at that place. One of the secretaries possessing a knowledge of foreign languages shall be specially chosen to fill the post of chief of this office, and this secretary shall be in attendance during the hours mentioned, for the purpose of giving information to competitors, journalists and the general public. At this office there shall be kept all the protocols used for reference by members of the Press at the competitions at Djurgårdsbrunnsviken.

The division of the competitors into heats.

The division of the competitors into the preliminary heats shall be decided by lot. This will take place in the presence of impartial persons after the close of the entries.

The drawing of lots for the diving competitions will take place at any time, and the figure drawn for each competitor will be the one showing the order in which he shall start in the competition. The division into the preliminary heats will be made by eights or by tens, according to the results of the drawing of lots. If there should be fewer than five starting in any heat, the leader of the competition can join this heat to the nearest heat which has not a full complement of competitors. In the finals, there shall compete the winners in all the preliminary heats and also those who have reached the highest points, irrespective of the heat in which they may have taken part, until the number of those taking part in the final is eight.

In the drawing of lots for the races, the competitors shall be grouped according to the nations to which they belong. Lots are drawn between the nations in a certain order, after which, lots are drawn between the individual representatives of these nations, so that there shall be as few as possible of the same nation in the same trial heat. The drawing of lots for the intermediate heats, after the preliminary heats have been decided, will be entirely individual, i. e. irrespective of whether several competitors belonging to the same nation come in the same heat. The drawing of lots for stations in the various heats shall take place immediately before each start, in the manner described below for the racing. The competitors shall be placed from right to left. Not more than six competitors shall take part in each heat.

The drawing of lots for water polo will, at first, take place within two chief groups, or pools, on the elimination (Cup Tie) system; the teams that are left in each group meeting in the final.

Identification marks.

Competitors shall wear coloured caps, in accordance with the programme. The caps show the nations which the competitors represent. The following colours will be employed:

Australia	Green.
Austria	Yellow and black.
Belgium	Yellow.
Bohemia	Pink.
Canada	Blue.
Denmark	Red.
Finland	Yellow and red.
France	White and light-blue.
Germany	Black and white.
Great Britain	Blue and red.
Greece	Pink and brown.
Hungary	Green and white.
Italy	Red and black.
Norway	White.
Russia	Red and brown.
South Africa	Black.
Sweden	Blue and yellow.
U. S. A.	Red and white.

Besides this, at the starting-place of each competitor in the swimming races, there will be put up his number according to the programme. This number, which will be put on a separate board for each swimmer, shall be visible the whole time the competitor, whose number it is, is in the water.

In the diving competitions, the competitors' numbers will be shown on a board on the platform, visible to everybody, and the starter of the diving competitions will call out the numbers in accordance with those on the board.

Publication of the results.

The results of the heats will be made public in the following way. A special notice-board will be provided, visible everywhere, on which, immediately before each competition, there will be shown the number of the heat, each competitor's number and the order in which the competitors are to start. These figures will be put up as quickly as possible. The results will be given on another board, equally visible to everybody, and on this there will be shown the number of the heat, the order in which the competitors reached the winning-post, and the results obtained. In addition to this, the beginning of each competition, the number-order of the competitors and the result of each race, will be announced both in Swedish and in English by means of a megaphone. In the water polo matches, the goals made will be announced by means of special black or white flags, in accordance with the orders given by the referee.

The necessary number of boy scouts shall assist in the announcement of the result of the competitions.

The Press Adjutants.

Immediately after the minutes of any competition have been adjusted, the Press Adjutants shall carry a copy of the minutes to the Press Stand, and shall give the representatives of the Press any information they may desire. To be able to carry out this work properly, one of the adjutants in question shall attend on the Swedish journalists, and the other on the representatives of the foreign Press. The Press Adjutants shall be under the immediate superintendence of the leader of the competitions. Official information other than the results of the competitions can be communicated to the Press only with the express permission of the leader.

The Medical Attendants.

The doctors shall themselves arrange as to which of them is to be on duty each day. The medical man on duty shall be in his place in the stand, or at the competing place in the immediate neighbourhood of the leader, the whole of the time the competitions are going on. Should any of the officials consider that medical aid is needed, word shall at once be sent to one of the leader's adjutants, who will then call the doctor. Should any competitor find himself in need of medical assistance, he must inform the official nearest at hand of the fact, who will procure help in the way just described.

The Management of the Ladies' Displays.

The manageress of the ladies' displays shall be responsible for all those taking part being called and present in time, and that all the necessary preparations are made. The manageress shall consult the leader in all matters concerning the competitions.

The Care-takers for the Lady Competitors from abroad.

The care-takers for the lady competitors from abroad shall be responsible for the ladies' dressing-rooms being in perfect order, and for the respective competitors being called in good time for the various events.

The Leader of the Swimming Races.

The leader shall be responsible for all the competitions being held in agreement with the programme, and without any unnecessary delay or trouble. All the officials on duty at the swimming races are under the direct command of the leader. He shall see that the clerk of the course (the crier), who is one of the adjutants of the leader of all the swimming competitions, gives the necessary instructions concerning the races. The leader shall tell the competitors where they are to stand whilst awaiting their turn, and shall carry out the drawing of lots to determine the order in which the competitors are to take part in the various heats. He shall be in possession of his own copy (provided by the Swimming Secretariat) of the list of the names and numbers of the competitors entered for each competition; he shall see that the competitors are wearing the distinctive marks prescribed in the programme; that they have the prescribed swimming dress, and that no unnecessary delay is made at the starts. The Starter, however, shall be responsible for the swimmers' wearing the prescribed swimming costume.

The Starter.

The leader of the swimming competitions shall have the lots drawn for the heats in sufficiently good time before the beginning of each heat. The starter's adjutant shall call out the numbers of the competitors, and shall show them the places they have to occupy at the start. The competitors shall be arranged from right to left.

After the starter is quite sure that everybody (both at the start and the winning-post) is ready, he shall say quietly to the competitors "*På Edra platser*" (Go to your stations), place himself behind them and, after a suitable pause, give the word "*Färdiga*" (Ready). Then he shall lift his pistol above his head, wait a moment to see if any of the competitors has lost his balance and is falling into the water. Should this not be the case, he shall fire. The starter must not "hold" the competitors in the starting position, however, but shall give the signal to go as soon as he sees that they are all in the proper position. The proper interval between the words "Ready" and "Go", is 2 seconds. Under no circumstance should it be more than 3 seconds.

If the starter sees, before the pistol has been fired, that any of the competitors are falling into the water, he shall allow them to do so and does not fire, but orders a new start to be made. The competitors then have the right to go from the start-line to take breath, the start being made when everyone is ready. Should any of the competitors, however, have their feet (or in, the case of a back stroke competition, the hands), off the starting place immediately before the instant the starter actually gives the signal, the competitors shall not be called back, but the offender shall be excluded from the competition.

The starter shall decide all matters concerning the start. The time is reckoned from the smoke of the pistol; the weapon, therefore, shall be directed upwards when being fired. The starter shall see that the pistol is in perfect order.

N. B. Before the starter lets the swimmers go, he must ascertain if all the numbers of the swimmers that took part in the preceding heat have been removed from the start-board, and have been replaced by those of the new competitors.

The Starter's Adjutants.

The starter's adjutant calls over the names of the competitors, and assigns the swimmers their places, in agreement with the draw for places carried out by the leader of the swimming races. He has also to assist the starter whenever requested by the latter to do so.

The Secretaries.

One of the secretaries shall be on duty at the starting place and the other at the finish. Three protocols shall be written for every heat, one of which shall be made out by the secretary at the start, and the other two by the secretary at the finish. Immediately after each heat, the protocols shall be given to the leader of the swimming races, who shall keep that written by the secretary posted at the starting place and one of the two written by the secretary at the finish, and give the second protocol of the latter official to the adjutants of the Press.

The secretaries shall also have a sufficient supply of the necessary protocol-forms written out in good time, for the judges of the course, the turn control officials and the officials for counting the lengths.

The minutes or protocols, to be official, must be signed by the judge and the judges of the course.

The Timekeepers.

The timekeepers shall be responsible for the watches and their correctness. The timekeepers, who shall all be on duty at the same time, shall station themselves at the finish and shall there start their watches as soon as they see the smoke of the starter's pistol. The leader shall signal to these starters when the latter asks if the timekeepers are ready, and is responsible for these officials being ready when the signal in question is given. The time is taken at the cry of the judge at the finish. Three timekeepers shall take the time of the first man, and, in the preliminaries and intermediate heats, there shall be at least two timekeepers for the third man, as his time will be decisive of the right to take part in a following heat. When two timekeepers take the time of the same man, and their times do not agree, the longest time shall be reckoned, unless there is reason to suppose that there is something the matter with the watch, in which case the leader of the timekeepers shall decide the matter. If there are three timekeepers for the same swimmer, and only two watches agree, the time of these two watches shall be

accepted. Should all three watches disagree, the median time shall be reckoned. The leader of the time-keepers shall examine the results given by the watches, and shall inform the secretaries of the times, for insertion in the protocols. This should be done without any unnecessary loss of time.

The Judges at the Finish.

Each day, there shall be appointed a judge to act at the finish, and he alone shall be responsible for the proper carrying out of this office, and he alone shall decide everything concerning the judging at the finish. This judge shall be provided with a red flag, and by lowering this, and by calling loudly and clearly to the timekeepers, shall let the latter know when the competitors reach the finish. The decision of the judge with regard to the order in which the competitors arrive at the finish is final. For the purpose of assisting this chief judge, there are other judges at the finish, who shall be stationed on a little staircase-like platform in a line with the finish. These assistants, who shall receive their instructions from the chief judge at the finish, shall help him to decide the order in which the competitors reach the finish.

Immediately after the conclusion of each race, the judges at the finish shall meet, and the chief judge shall hear what his assistants have to say, but shall himself decide as to the order in which the competitors reached the finish. No other persons than those now mentioned shall be allowed to be present at this meeting, which shall be as short as possible. The acting judge at the finish shall dictate the result to the secretary of the competition, and shall sign the protocol.

The Judge of the Course.

The task of the judge of the course is to observe whether any of the competitors impede the other swimmers or cross their path. The judge of the course shall write a protocol of the race, which can be had at the secretariat. He shall decide whether a competitor can be considered as having wilfully impeded another man, and ought therefore to be excluded from further participation in the competition. He shall also decide whether a competitor has been so impeded that it can be considered as having influenced the result of the competition, and if the swimmer in question shall be allowed to start in the next round, or, in the event of the foul having occurred in the final, whether the race shall be re-swum. In the case of a breast stroke race, the judge of the course shall decide whether a swimmer maintains an absolutely correct position, as stated by the special rules for the breast stroke swim, article b). He shall also see that articles a) and c) of the same rules are observed. He shall attend to the observance of article b) of the rule governing the back stroke race, i. e., that the swimmer shall remain on his back throughout the whole of the race.

The Length Counters.

The counters of the lengths swum shall all be on duty at the same time and shall be placed at the end of the course opposite to the finish. In addition to the leader of the length counters, there shall be a special length counter for each of the competitors in a race. Each length counter shall show the swimmer on whom he attends, the number of lengths still remaining for him to swim. This is done by means of an apparatus placed on the bridge, which always shows an odd number. A bell is rung for each swimmer when he is about to swim his last length. The leader of the length counters, with the assistance of a timekeeper, keeps a count of the time of each swimmer at each turn he makes at that end of the course where the timekeeping is taking place; this is done in order to prevent any mistake being made respecting the number of lengths that have been swum. The leader of the length counters shall keep a special protocol of the number of lengths swum, which shall be given to the chief leader of the competition as soon as each event is finished.

The Turn Control Officials.

The officials whose duty it is to check the turning of the swimmers are stationed two and two at each end of the course. Should there be any reason to criticize any turning that has been made, a note shall be made in a special protocol for the turn control, of which there shall be one at each end of the course. Special attention must be made to the turnings in the breast stroke races, to see that they are made in accordance with the rule, with both hands stretched simultaneously and evenly towards the turning board.

As soon as a heat is finished, the protocol of the turning shall at once be given to the chief leader, to whom application shall also be made if it is considered that any competitor ought to be disqualified. In this eventuality, the turn control officials should at once discuss the matter together with the chief leader.

The Leader of the Diving Competitions.

The leader of the diving competitions shall place the various judges at their proper stations, and is responsible for the competitions taking place in accordance with the rules. All the officials acting during the progress of the diving events stand under his immediate command. The starter of the diving competitions has also to assist him, and stands under his immediate control. The leader in question must see that the starter gives the necessary information both to the competitors and to the public, respecting the order in which the diving events are to be held, and the kind of dive that is to be executed in each case. He must also see that the competitors are wearing the prescribed dress, together with the caps and the distinctive marks as given in the programme. He can also act as judge.

The Judges of the Diving Competitions.

The five judges acting for the day, shall station themselves at different places and during the progress of a competition, shall not discuss it, either with each other, or other persons. Immediately after the competition they shall sign their protocols and give them to the leader of the diving competitions, who, in his turn, shall give them without the least delay to the leader of the secretaries in order to have the results calculated at once. A judge cannot make an alteration in his protocol after he has once signed it and given it to the leader of the diving competitions. Each judge has in front of his place a flag, which he lowers immediately a dive has been executed, and before he enters the sum of the points for the dive. As soon as he has finished doing this, he shall lift the flag again, as a sign to the starter that the latter can call out the number of the next diver and of the dive to be executed. This arrangement has been made in order to avoid the giving of the signal for a new competitor, before all the judges have finished calculating the results for the foregoing competitor.

The same judges shall act throughout all the preliminary heats of the same competition.

The Starter of the Diving Competitions.

The starter of the diving competitions shall see that the competitors are dressed in accordance with the regulations. He shall announce through a megaphone, in both Swedish and English, the name of the competition that is about to take place, the number of the heat, the names of the competitors, and the dives that are about to be executed. He shall also have the numbers of the same competitors put up on a special notice board. The way in which this is done is as follows: After a competitor has performed his dive, the starter shall call out the name and dive of the next competitor, but not before he has been informed by means of the judges' flags, or in some other way, that the judging of the foregoing competitor's dive is completed, shall he give notice to the next competitor (by means of striking a gong, or in some other way) that everything is ready for his dive. The names and dives shall be called out in accordance with the protocol received from the leader of the secretaries, and the starter has no right to make any alternation in this order without the consent of the leader of the diving competitions. The starter

shall have the necessary number of boy scouts to assist him in putting up the numbers spoken of above.

The Starter's Adjutant.

The starter's adjutant shall place the competitors in their right order near the diving board, and shall be careful to see that the competitor whose name has been called out by the starter is standing on the diving board, dressed in accordance with the regulations, and wearing his distinctive mark, and ready to begin when the starter gives the signal. He shall also see that on the platform from which the dives are, for the moment, being made, there shall be no other persons but those that are to compete in the event going on at the time. He shall also assist the starter for the diving competitions in any other way he is requested to do so by that official.

The Secretaries of the Diving Competitions.

The leader of the secretaries of the diving competitions shall be responsible for the calculation of the diving protocols as soon as the said protocols have been received from the leader of the diving competitions. When these calculations are to be made, each secretary shall take a protocol, and, when the calculation of the protocols of the individual judges has been concluded, the leader, assisted by that one of the other secretaries he desires, shall carry out the calculation of the general protocol. As soon as the calculation of all the protocols of a competition is finished, the general protocol and the protocols of the individual judges are given to the chief leader. The calculations shall be collated and adjusted by other persons than those that made the first calculations.

The secretaries shall take care to have the necessary protocol forms ready in good time for the starter and the judges. A duplicate copy shall be made of the general protocol, and the leader of the diving competitions shall sign both the original copy and the duplicate.

In judging the diving

the judges shall observe the following rules:

GENERAL RULES.

Points shall always be deducted for the following faults:

1) A crooked, twisted or laterally bent position of the body in the take-off; during the passage through the air, and on the entry into the water.

Faults on the entry into the water:

The body passes beyond the vertical position.

The body does not sufficiently reach vertical position.

The upper part of the body bent in towards the legs.

Bent knees.

Bent head.

2) The arms not sufficiently held together, in the case of a plain header, or, in the case of a dive feet first, with the arms not quite close to the sides.

Plain header.

In order to attain the highest possible points the following things must be observed:

Starting position in the standing dive: The body straight, the head well up, the feet well together, the arms stretched along the sides, the fingers well together.

The take-off must be bold and confident, with the body thrown upwards and outwards.

The bearing in the air: the head shall be held well up, but not bent backwards; the chin must not be drawn in.

The body shall be straight, with the back slightly hollowed but not bent backwards; the legs shall be straight and kept together, with the ankles stretched downwards and the inner sides of the feet together.

The arms shall be stretched out in a line with the shoulders and kept well up, so that the chest is expanded; they must not, therefore, hang below the body; neither must they be drawn too far backwards. The arms shall be kept still until just before the entry into the water, when they shall be rapidly brought together and extended beyond the head in a line with the body.

The entry into the water: The bearing of the body shall be retained unaltered. Bending the body together during the drop into the water, and bending the joints of the feet or legs will result in a loss of points. When the body meets the water, the whole of the falling movement must then take place in the longitudinal direction of the body; a forward backward or downward bending of the legs will entail a loss of points. The arms must be kept extended and well together until the whole of the body is in the water, so that the entry into the water is accompanied with as little splash as possible. There must be a good bearing, with the arms and legs extended in a line with the body; the fingers not spread apart; the ankles well stretched downwards.

The run shall be easy, with the body in an even line; without a jump or change of foot; the arms shall hang easily by the sides and shall not be carried out laterally before the spring is made.

Table A.

In order to attain the highest possible number of points, the following things must be observed.

I. Dives with face towards the platform.

1. *Backward header.* During the dive, the arms shall be held extended above the head; the body shall be kept bent slightly backwards, with the legs straight and together, and with the ankles stretched downwards; the head in a natural position. In the entry into the water the arms shall be held well together.

2. *Backward somersault.* During the dive, the arms shall be kept stretched outwards; the body kept bent backwards, with the legs and the ankles straight and held together; bending at the hips and knees during the passage through the air will result in a loss of points. In the entry into the water the arms shall be held stretched along the sides; the ankles stretched well downwards; head well up.

3. *Backward spring outwards, turn inwards with header:* During the dive the arms shall be kept stretched outwards; the body is cast outwards and upwards, is bent at the hips and then rapidly straightened; bending of the knees during the passage through the air will result in a loss of points. The entry into the water, which must take place with the back turned towards the platform and the face from it, shall be as in a plain header.

4. *The same dive, with somersault.* The bearing of the arms and body as in the preceding dive. In the entry into the water, the body shall be kept erect with the head well up and the arms stretched along the sides; the soles of the feet must not strike the surface of the water; bending of the knees will result in a loss of points.

5. *The same dive, with one and a half somersault.* The bearing of the arms and body as in the preceding dive. The entry into the water similar to N:o 3.

Rule common to dives 3—5. The straightening of the body must be concluded before any part of it has touched the surface of the water.

II. Armstand Dives.

6. *Armstand with header.* Starting point the body, with the back slightly hollowed, and with the upstretched legs and feet above the head, is supported on the straightened arms. When the body is perfectly balanced, the legs are carried slightly backwards, and the body is pushed outwards by the help of the arms. After the take-off, the arms must be kept stretched outwards. The bearing of the body, and the entry into the water are the same as in plain header.

7. *Armstand with overback.* The starting position as in the preceding dive. The legs are carried backwards and over and, when the body has taken a suitable position, the take-off is given by a push with the arms, which are afterwards kept extended above the head until, just before the drop into the water, they are stretched

along the sides. The body shall be held straight, with the back slightly hollowed; the legs straight and together; the ankles stretched downwards; the head in a natural position

8. *Armstand with somersault.* The starting position and the take-off as in the preceding dive. When the somersault is made, the hips are bent slightly. Bending the knees during the passage through the air will result in a loss of points. After the take-off, the arms shall be kept extended outwards. The drop into the water is the same as in plain header.

Rules common to all the armstanding dives. The manner in which the starting position is taken up will not be judged, but, if the body is not balanced at the first attempt, there will be a loss of points. If the dive is made without the body having been properly balanced in the starting position, the dive must be marked *below 6 points* (or good dive).

III. Running Dives.

9. *One somersault forwards.* During the dive, the arms shall be kept extended outwards. The body shall be held straight and the bending be made at the hips; bending the knees during the passage through the air will result in a loss of points. In the entry into the water, the arms shall be kept stretched along the sides.

10. *Flying somersault forwards (first well defined header, then somersault).* During the dive, the arms shall be kept extended above the head, which must be kept well up; the somersault shall be made halfway between the highest point of the dive and the surface of the water and it must be executed rapidly, by means of the arms being quickly drawn close into the body, the hips and the knees being bent as much as possible. The hands ought not to clasp the knees. Then, the body is rapidly straightened, with the arms stretched close to the sides in the entry into the water; the ankles stretched downwards and the head well up.

In order to attain the highest points in this dive there must be: a well defined header before the somersault; a somersault made as rapidly as possible, while the straightening of the body after the somersault and before the drop into the water, must be so easily distinguishable that the diver can be plainly seen with his arms along his sides.

11. *One and a half somersault forwards.* The body shall be held straight with the legs together and with the ankles stretched downwards. At the highest point of the dive, the bending is carried out at the hips; bending the knees will result in a loss of points. The arms shall be kept stretched outwards until the somersaults have been concluded and the body straightened again. The entry into the water as in plain header.

12. *Isander's dive.* Immediately after the take-off, the arms are carried rapidly above the head and remain there until the diver has completely entered the water; the legs are thrown forwards and upwards, whereupon the body is rapidly bent slightly backwards until a perpendicular position has been attained, so that the entry into the water becomes the same as in a plain header.

13. *Mollberg's dive.* The legs are thrown forwards and upwards, and a backward somersault is made. During the dive, the arms are kept stretched outwards and then, in the entry into the water, stretched along the sides. Bending at the hips or knees will result in a loss of points.

Spring-board Diving.

The run shall be performed evenly, without jumping, or change of foot. With an even run, the last step shall be so powerful that a good spring can be had. The body shall be kept upright, and must not be bent forward in the run; the arms shall be carried easily by the side of the body.

By the expression "with the arms *stretched* along the sides" is meant, that from the moment the take-off is made, and during the passage through the air, until the entry into the water is completed, the arms shall be kept close to the sides, with the palms of the hands pressed close to the thighs. The arms need not be kept close to the sides during the run, but only during the take-off from the spring-board, during the flight through the air and the entry into the water.

By the expression "Arms *along* the sides" is meant, that, during the entry into

the water, the arms shall be held close to, but not pressed against, the sides; they shall be slightly bent and with the palms of the hands pressed against the thighs. The arms must remain unchanged in this position along the sides, until the swimmer has disappeared beneath the surface.

Compulsory dive from a height of 1 metre.

1. *Running plain dive.* See rules for plain header.
2. *Running forward somersault.* The body shall be held straight, with the legs together and the ankles stretched downwards. The bending is made at the hips; bending the knees will result in a loss of points. The arms shall be kept stretched outwards during the somersault, and are stretched along the sides in the entry into the water. In the entry into the water, the ankles shall be stretched downwards in such a way that the soles do not strike against the surface; the legs shall be straight and held together; the head well up.

Compulsory dive from a height of 3 metres.

3. *Standing plain dive.* (See dives from the high platform).
4. *Standing plain dive.* (See dives from the high platform).

Table B.

I. Dives with face towards the water.

1. *Falling dives forwards* (arms stretched by the sides). The body shall be kept quite straight, with the legs and feet close together; the head in a natural position; the arms well stretched along the sides. No run may be taken. The position must be retained until the swimmer has disappeared beneath the surface.
2. *Ordinary header forwards* (arms by the sides), with and without a run. The position of the arms with the hands close to the thighs must be taken before the entry into the water, and must be retained until the whole of the body is beneath the surface. The other rules for plain header hold good here.
3. *Screw dive forwards, with half turn.* A run as for a plain header, with the arms stretched above the head, after which a half turn is rapidly made round the longitudinal axis of the body. The position of the arms is retained until the swimmer is completely in the water. The legs must be kept straight and together. In the entry into the water, the back shall be turned to the spring-board, and the breast turned from it.
4. *Screw dive forwards, with one turn.* Is executed in the same way as the preceding dive, with the exceptions, that a whole turn is made round the longitudinal axis of the body, and, in the entry into the water, the breast of the swimmer shall be turned towards the spring-board, and the back away from it.
5. *Pike dive forwards.* The take-off as for a plain header, as high as possible. When the highest point is reached, the body is curved rapidly upwards (is bent double), with the arms stretched in the direction of the line of the body, and with the legs stretched out and together; the body is then straightened rapidly, so that the entry into the water is the same as in a plain header.
6. *Pike dive forward* (arms by the sides). The position of the arms, with the hands close to the thighs, is taken before the entry into the water, and is retained until the swimmer has disappeared beneath the surface.
7. *Forward somersault* (arms stretched by the sides). The starting position, with the hands to the thighs, must be taken when the run is made, and must be retained until the swimmer is entirely beneath the water. During the dive, the body shall be held straight, with the legs together and the ankles stretched downwards; the bend is made at the hips; bending the knees will result in a loss of points. In the entry into the water the ankles must be kept stretched downwards, so that the soles do not strike the surface; the head well up.
8. *Flying somersault forwards* (first well defined header, then somersault). The take-off as for plain header. The arms shall be extended in a line with the body; the head well up; the somersault shall be made half-way between the highest point of the dive and the surface of the water; it shall be performed rapidly by

the arms being drawn quickly in towards the body, while the hips and the knees are bent as much as possible; the hands may not clasp the legs; then the body is straightened rapidly, with the arms stretched along the sides in the entry into the water. The ankles shall be stretched downwards, and the head kept well up.

9. *One and a half somersault.* The body shall be kept straight, with the legs together and the ankles stretched downwards. The somersaults are made by bending at the hips on reaching the highest point of the dive; bending the knees will entail a loss of points. The arms shall be held outwards until the somersaults are finished and the body is straightened again. The entry into the water the same as in a plain header.

10. *One and a half somersault* (arms stretched by the sides). The starting position with the hands close to the thighs, shall be retained until the whole body is beneath the surface.

11. *Isander's dive.* Immediately after the take-off, the arms are carried rapidly above the head and are retained there until the swimmer has entirely disappeared beneath the surface. The legs are thrown forwards and upwards, whereupon the body is rapidly bent backwards until a perpendicular position is reached, so that the entry into the water becomes the same as in a plain header.

12. *Mollberg's dive* (arms by the sides). The legs are thrown forwards and upwards, and a complete somersault backwards is made. The position of the arms along the sides is taken before the entry into the water. Bending at the hips and knees during the passage through the air will entail a loss of points.

Dives with face towards the spring = board.

13. *Falling dive backwards* (arms stretched by the sides). The same as N:o 1, but backwards.

14. *Ordinary header backwards.* After the take-off, the arms shall be stretched above the head and, then, in the entry into the water, be brought together. The body shall be bent somewhat backwards.

15. *Pike dive, with backward spring and turning inwards.* The same rules for the position of the body and the movements of the arms as in pike dive forwards.

16. *Backward somersault* (arms by the sides). The body shall be kept straight and bent backwards; the position of the arms along the sides is taken before the entry into the water. Bending at the hips and knees will entail a loss of points. The head must be kept well up in the entry into the water.

17. *Pike dive with backward spring, turning inwards and somersault.* (Arms stretched by the sides.) The position with the arms along the sides shall be taken before the entry into the water. Bending at the knees will result in a loss of points.

18. *Pike dive with backward spring, turning inwards, and one and a half somersault.* During the dive, the arms shall be kept stretched outwards, and then, during the entry into the water, extended over the head. Bending at the knees will result in a loss of points.

General Rules.

As a note to Table B, (that dives 7—10 and 16—18 can be executed either with the body straight, or with bending at the hips and the knees on the condition that a clearly defined straightening of the body takes place before the entry into the water) it is meant, that the judge has not the right to regard a dive as unsuccessful if it is executed in the manner described in the remark. The highest points are given, however, to the execution when the body is kept as straight as possible, with the exception of dive 8, however (Flying somersault forwards), where the body must be bent together as forcibly as possible if the dive is to be regarded as having been executed in the best possible way.

There are no special rules applying to the rising to the surface and quitting the water.

Preference is given to the straight position during the passage through the air. The head should be held straight between the shoulders. Bending the head backwards or forwards will entail a loss of points.

WATER POLO.

Rules for Drawing.

The competition will be arranged on the elimination (Cup Tie) system. The teams entered will be drawn in couples for the first round, after which the order of play for the following rounds will be determined in such a way that the sequence of the matches up to the final is decided before the commencement of the competition. The necessary number of matches will take place between the teams qualifying for the competitions for the second and third prizes.

The drawing of the lots for water polo takes place first within two pools or groups, from each of which certain teams are eliminated, so that a team from each group will meet in the final. For the first round, team is drawn against team, and the matches are marked a, b, c, d, etc., being so distinguished in accordance with the draw. The order in which the teams shall meet each other within each group is fixed from the start. In order that each team shall be treated with full justice when determining the award of the second and third prizes, qualifying rounds will be played after the ordinary ones, the rule being observed that, as far as possible, teams from the different groups meet each other. The principle applied is, that a team that has beaten another, is considered to have also defeated all the teams that have been already beaten by the defeated team in question, so that, when a team has been beaten twice, it is out of the running altogether.

The order in which the matches are to be played will be determined in the following manner. If, for example, nine teams have entered for the competition, 4 of them are drawn in pool (or group) I and the the other 5 in pool II. Then lots are drawn in each pool, so that in pool I there will be two couples, and in pool II, two couples and one bye. The couples in pool I draw lots for the matches marked a) and b), and those in pool II draw for those marked c) and d). The winner of match a) meets the winner of match b) in the second round, and the winner of match d) meets in the second round the team in the same pool that had a bye in the first round. This match is marked as e). The winner of match c) stays in for the semi-finals.

But before the ordinary matches in the second round are played, a qualifying round will be played between the loser in a) and the loser in c), and between the loser in b) and the loser in d). These matches are designated f) and g).

The second round proper is then played, the match in pool I being marked h) and the match in pool II as j). The winner of h) meets in the semi-final the winner in c). This semi-final is marked k). The winner of k) meets the winner of j) in the final.

Before the semi-finals are taken, the second qualifying round is played, the loser in f) meeting the loser in h), the match being marked as 1). The loser in g) meets the loser in j), the match being marked n). The loser in 1) meets the loser in n), the match being marked o).

After the ordinary semi-finals have been played, the loser in k) meets the winner in o). If the o) team wins, it has the right to compete for the second prize — unless the team that has lost the ordinary final has already beaten o) direct, or indirectly; this possible match is marked p). Should the winner in o) also win in match p), the loser in o) has the right to play the loser in p) for the third prize.

If a team does not make its appearance in any one of its matches, it forfeits the right to take any further part in the competition.

The order of the matches will, therefore, be as follows (1 = winner; 2 = loser in the respective matches):

1:st Round:

- a 1—a 2.
- b 1—b 2.
- c 1—c 2.
- d 1—d 2.
- e 1—
- a 2—c 2 = f, f 2 eliminated.
- b 2—d 2 = g, g 2 eliminated.

2:nd Round

- a 1— b 1=h.
- d 1— e 1=j.
- c 1—
- f 1—b 1= l
- g 1—d 2=n, n 2 eliminated.
- l 1—n 1=o, o 2 eliminated.

Semi-finals:

- a 1—c 1=k.
- o 1—k 2=p, p 2 eliminated, or eventually, p 2—l 2.

Final:

a 1—j 1. The winner gains the first prize.

If j 1 wins the final, a 1 is certain of the second prize, and p 1 (=a 2), certain of the third prize, or, p 1 (=c 1) plays l 2 (=b 1) for the third prize.

If a 1 wins the final, j 1 (=d 1) must play p 1 (= a 2) for the second prize.

If j 1 wins this match, then p 1 is certain of the third prize, but if p 1 should win, then j 1 must play b 2 for the third prize. Thus:

eventually:

- p 1—j 1. The winner gains the second prize.
- j 1—b 1. The winner gains the third prize.
- or, if p 1 = c 1 eventually:
- p 1—j 1. p 1 gains the second prize.
- j 1—p 2. The winner gains the third prize.
- At most, therefore, there would be 17 matches.

Example of the way in which the teams are eliminated:

9 teams have entered, called here A, B, C, D, E, F, G, H, I. The result of the draw has been that the following pairs meet in the first round: A—B, C—D, E—F, G—H. I has a bye.

A, C, E, and G win in the first round. B, D, F and H meet in the qualifying round, B playing F, and D meeting H. The winners are to take part in the second qualifying round.

In the second ordinary round the following teams meet each other, in accordance with the draw: A plays C and G plays I, while E has a bye. A beats C and G beats I, so that A, E and G remain for the semi-finals.

If B and D won in the first qualifying round, then, in the second round, B plays C and D plays I. If F and H had won in the first round in question, then F would play C, and H play I.

In the semi-finals, A and E meet, while G remains for the final; this in accordance with the draw previously made. In the qualifying semi-final, B meets D, according to the first case, and, if B wins, then B has to meet E. Should D beat B, then D and E meet. According to the second case, F and I meet. If I wins, it has the right to play for the third prize.

A and G meet in the final, in accordance with the draw previously made. The winner takes the first prize.

If A wins the final, then B plays G for the second prize, and, if B wins this match, G and C must play for the third prize. According to case I, A has gained the first prize, and E and B play for the second. If G wins the game for the second prize, then G gains the second prize, and B at once takes the third prize, as B has previously beaten both C and D. According to case II, A has the first prize, and E and G meet for the second prize. If G wins this match, G gains the second prize and E has to meet I for the third prize. Should E meet G in the match for the second prize, and win, then G gets the third prize at once, as G has already beaten I.

EXAMPLE:

Ordinary Rounds:

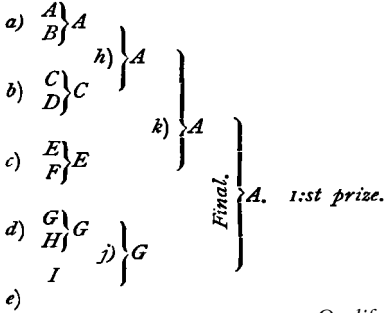

Qualifying Rounds.

Case I:

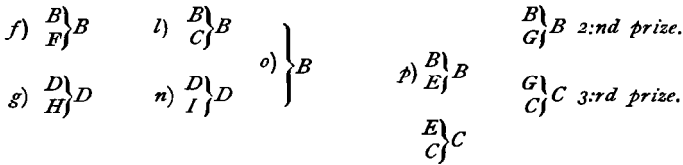

or:

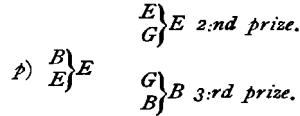

Case II:

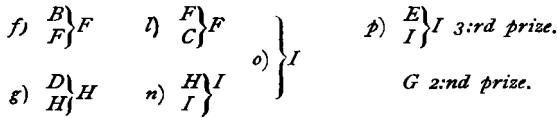

Thus, at most, 17 matches.

In the case of the scores being level at the expiration of time, extra time periods shall be played, each extra period being of 6 minutes' duration, 3 minutes each way, with a pause of one minute at change of sides, until the game is decided. A team that refuses to play extra time shall be considered as having withdrawn from the competition, and shall be excluded from further participation in it.

Advice to the Water Polo Referee.

Rules 1—4. See that the ball is of the right size, as stated in rule 4. See that the dimensions of the goals are correct, and that the goals are made fast not less than 30 centimetres from the ends of the field of play, or other obstacle. See that the half-distance- and the 2-, and 4-metre lines at the extremities of the field of play, are clearly marked on both sides of the bath. See that the goal-nets are placed in accordance with rule 3.

Rule 5. Black, dark-blue and white caps, as prescribed in rule 3, are obligatory, and the goal-keeper shall always wear a cap with red stripes.

Rule 7. The referee has the full control of the game in his hands.

The decision of the referee in all technical question is final, and a referee ought never to enter into a discussion with the players respecting the correctness of the de-

cisions he has already given. The referee can alter his ruling only in the event of play not having recommenced after the decision has been given. Thus, the referee cannot annul his decision as to whether a goal has been made or not, after the ball is in play again; neither can he disallow a free throw once granted, if the throw has already been made.

Rule 8. See that the goal scorers are in their proper places, and inform them that it is their duty to give a signal with their flags to show when the whole of the ball has passed between the goal posts and beneath the bar, irrespective of the manner in which this has been done, and that they must also keep the score of the goals made by each team at each end of the field of play. Read rule 8 to the goal scorers.

Rule 9. N. B. According to the new rules in force, the timekeeper alone shall decide when half-time, or time, is ended. His signal, given by means of a whistle, shall be immediately operative, and after the whistle has sounded, no goal can be reckoned, nor can the game be continued in any way. Cfr. Rule 14, where it is stated that, when the signal is given for half-time, or time, at the moment the ball is passing between the posts, unless the whole of the ball has passed between the side posts and beneath the cross-bar, no goal shall be counted.

Rule 10. See that the interval at half-time does not exceed three minutes. The referee must see that the time taken up by free throws, throws-out and comer throws, disputes and other stoppages, is not reckoned in the time of play.

Rule 11. Make certain that the players are dressed in accordance with the regulations, and that no grease or oil has been rubbed on the body of any player.

Rule 12. The referee shall see in good time that the captains have tossed up for ends and are agreed as to the preparations, and, in the event of their not being able to agree, shall decide between them.

Rule 13. The referee shall not delay throwing the ball into play, after the word "Go" has been given. The referee shall not pay any heed if the wind or waves carry the ball away from the middle line after he has thrown it out. Special attention must be paid to the regulation that, if the ball, after the start or a re-start, has been handled only by two players belonging to the same team before a goal is made, the player that makes the goal must be within that half of the field of play in which the goal attacked is situated, or else the goal shall not be reckoned. *Note* that, according to the new rules, no goal shall be counted if the goal-keeper, when the ball has been handled only by two opponents and the player that made the goal was within his own half of the field, tries, *unsuccessfully*, to prevent the ball passing between the side posts and under the bar. A throw out from goal shall, instead, be adjudged to the goal-keeper.

Rule 14. The signals made by the goal scorers are intended to serve to guide the referee in his decisions, but it is the referee himself who has to decide whether a goal has been scored or not. *Note* the regulation in the new rules that, when the whistle is blown for half-time or time, and the whole of the ball has not passed between the posts and beneath the bar, no goal shall be reckoned; the goal scorers shall pay special attention to this matter. A goal can be scored off the head or the foot, but in either case the rule holds good that the ball must previously have been handled by at least two players. Thus, a goal cannot be made if, directly after a throw out from goal, the ball is put back into the net off the head or foot of only one other player.

Rule 15. Be very careful to see that no player, with the exception of the goal-keeper, touches the ball with both hands at once, and see that the resting which is permitted (article d), is not misused. The rule allows of a player standing on the bottom only for the purpose of resting, and such players must not be allowed to walk about, to stand with outstretched arms and prevent an opponent from seeing the ball, or otherwise hinder him; neither may a player who has been thus resting, push off from the bottom. Articles d) and g) treat of the fouls which are committed oftenest. Do not allow the player to be disturbed or hindered in any way when he is not holding the ball with his hand. (Respecting the definition of "holding the ball", see rule 15.) It is considered a foul to swim across, or at the side of, a competitor in such a manner as to obstruct him in the free use of his legs or the free movement of his arms.

See that no player holds the rails or sides of the bath during the course of the

play. Should this rule be broken, a free throw shall be given, to be taken at the where the foul was made, wherever this may be.

Article f) in rule 15 holds good only when the player in possession of the ball is attacked by an opponent. It is, therefore, permitted to put the ball beneath the water when a throw is being made.

In the new rules it is prescribed that it shall be counted a foul to catch hold of the goal posts during the progress of the game, this rule applying to the goal-keeper too. Walking about on the bottom is also mentioned in a special, new article c) as being a foul. If the goal-keeper makes a throw-out from goal incorrectly (see Rule 20), a free throw shall be awarded to the other side. Another new rule makes it a foul to throw the ball to one of the same side who happens to be attacking and is within the two metres' line. If such a player is within the two metres' goal-line and, thus, has not taken up his position within it (in which case, Rule 16 is applied), but one of his own side passes the ball to him, a free throw shall be awarded to the other side, to be taken from the spot whence the ball was thrown, and neither of the players shall be ordered out of the water. No player that is attacking may, under any circumstances, receive the ball within the two metres line, but he may take the ball with him into that part of the field of play. According to the new rules, a free throw shall also be given to the other side if, when the referee throws the ball into play, one of the players touches the ball before it has reached the surface. The one that makes the free throw shall not be hindered in any way when doing so. If, however, this is done, the throw shall be made over again, and should the offence be repeated, the matter shall be considered a wilful foul.

Rule 16. When a player commits any of the wilful fouls mentioned in rule 16, the offender shall always be ordered out of the water. If the referee considers that any of the fouls mentioned in rule 15 have been committed purposely, the same penalty shall be awarded. Deliberately splashing water in the face of an opponent also comes under rule 16, and it is always the task of the referee to decide whether the foul was a wilful one or not. Taking up a position within two metres of an opponent's goal-line shall always be punished according to rule 16, whether the offender has the ball passed to him or not. If the ball is within two yards of an opponent's goal-line, a player has the right, however, to swim for it. *Note:* in the new rules it is enacted that if a player is ordered out of the water for a wilful foul, he shall not re-enter the water until a goal has been scored, notwithstanding that half-time may intervene, or extra time be played, and then only with the consent of the referee.

Rule 17. See that all free throws are made from the place where the foul occurred. The referee shall declare the foul by blowing a whistle, but he should not give the signal for the throw to be made, the player of the side to which the throw has been awarded, and who is nearest to the place where the foul was made, having to take the throw without any delay. It is of the greatest importance for the referee to have his attention well fixed on the other players, to see that none of them leaves the place he occupied when the whistle sounded. Many offences are committed against this rule, and it is necessary for the referee to be careful to enforce it. The first time a player offends against it, the referee can warn him, but if the foul is repeated, rule 16, article d) must be applied. A goal cannot be made from a free throw before the ball has been handled by at least one player in addition to the one that took the throw. If the one that takes the throw, casts the ball against the goal-keeper of the opposite party so that it rebounds into the net, this shall not be reckoned as if the ball had been handled by the goal-keeper, but a throw-out from goal shall be awarded. The one that takes the throw may swim with the ball before he throws it, but he cannot make a goal.

Another alteration in the rules is the regulation that a free throw shall be taken in such a way, that all the players can see the ball when it leaves the hand of the thrower; the referee shall see that this is done.

Rule 18. In the case of a penalty throw, the player that has committed the offence must be ordered out of the water until a goal has been scored. This rule has been enacted in order to prevent a foul from being committed for the purpose of hindering an opponent from making a goal at a favourable opportunity. Unless this severe rule existed, the foul in question would be committed all too frequently,

and the game would lose in character. A penalty throw can be awarded only for such fouls as are committed within the four metres' line, and shall be taken from the line in question. A novelty in the rule is, that the player that takes the throw, must await the whistle of the referee before the throw can be made. The player, therefore places himself at that part of the four metres' line that he himself considers the most suitable, and there waits for the referee's signal. Should he throw before this is given, a throw-out from goal shall be awarded to the opponent's goal-keeper. The penalty throw shall be taken by the player against whom the foul has been committed. A penalty throw is awarded for wilful fouls against rule 15, and it is the duty of the referee to decide whether the foul was a wilful one or not. A goal may be made direct from a penalty throw, but any player within the four metres' line may intercept a penalty throw, although he may not interfere with the players when taking the throw. The referee must be very careful to see that all the players, with the exception of the one taking the throw, keep their places. The player that committed the offence must be ordered from the water before the throw is made. If a goal is made from the penalty throw, the offender may at once return to the water.

Rule 19. The goal-keeper must not throw the ball beyond half distance. Should he do so, it must be considered as a foul, even if the ball has touched the water within half distance.

The goal-keeper has not the right to take the ball when it lies beyond the four metres' line from the goal line. Should he do so, his nearest opponent shall be awarded a free throw, and rule 16, concerning the duty of the players to remain in their respective positions, shall then apply to the goal-keeper.

The goal-keeper is subject to articles b), e), f), h), i), j), k), m), and n), in rule 15, and articles a), b), c), d) and e), of rule 16. The regulation that the goal-keeper, when he is in possession of the ball, is to be treated like any other player, is to be interpreted so, that the goal-keeper is bound to get rid of the ball at once, or else to swim with it, the same as any other player. He must not walk about, or stand and hold the ball. The goal-keeper may be changed at half-time, but in such a case, the referee must be informed of the fact. The goal-keeper can be replaced only by another player of the same side, the former goal-keeper being then treated as any other player. If the goal-keeper is compelled by an accident or illness to leave the water, another of the same side can occupy his post and shall enjoy the limitations and privileges attached to the ordinary goal-keeper. The new goal-keeper must wear the special cap distinguishing his position, and rule 22 shall be applied in other respects. In the event of the goal-keeper being ordered out of the water for a wilful foul, his side cannot appoint another goal-keeper except at half-time, but one of the side can occupy his post without enjoying any of the special privileges attached to it. See the remark made in rule 20.

Rules 20 and 21. If a ball is sent out of the field of play, the player that last touched the ball, whether voluntarily or not, shall be considered as the one that threw out the ball, and the free throw shall be given to one of the opposite side. *Note* that, in accordance with the new rules, a corner throw shall be taken from the place where the two metres' line intersects the side-line, and the corner throw shall be taken by the player who was nearest the point where the ball went over the goal-line. The ball must not, however, be thrown by the player mentioned, to anyone of his own side who, when the attack was being made, happened to come within the two metres' line. Another new rule is, that when a throw out is taken from goal, the goal-keeper must throw the ball either to a player within the two metres' line, or else past the same line. Observe the *Note* to rule 20, according to which, the goal-keeper may take the ball again from a free throw if it has not been handled by any other player, and so, by carrying it in within his own goal, save his goal from an attacking opponent. In such a case, however, a corner throw shall be awarded to the opposite side. The rule holds good, of course, even if the goal-keeper is not attacked. Should the ball strike or lodge in an obstruction above the field of play, the game shall be stopped, and the referee shall throw the ball into the water beneath the said obstruction.

Rule 22 should be most carefully acted on by the referee.

During the progress of a game, the referee should never enter into a discussion with

the players or spectators with regard to his decisions, neither should he answer questions respecting them.

The ball shall be considered dead from the instant the referee's whistle has sounded for a free throw or a throw in, until the moment the ball leaves the hand of the player that takes the free throw, the throw in, or the throw out from goal, or until the moment that the ball touches the surface of the water after it has been thrown into play by the referee; during this period none of the players may leave their places.

The referee must unconditionally interrupt the game if the behaviour of the players or the spectators, or any other circumstance prevents the progress of the game and its being brought to a close in full accordance with the rules. Should such a step be taken, a full report shall immediately be sent to the Swedish Swimming Association.

The Water Polo Timekeeper.

The timekeeper, who shall be nominated by the Committee that arranges the games, must be perfectly at home with the rules of the game. A timekeeper's watch, with a stop-device, is the only kind of watch that is of any use. Remember to stop the watch the instant the referee's whistle is blown for a foul, or when the ball goes outside the field of play, and let the hands stand still until the ball is once more put in play, this moment being reckoned from the instant it leaves the hand of the player that takes the throw in, free throw, etc. Time that is taken up by the settlement of disputes, or by bringing the ball into the field of play again (as mentioned above) must not be reckoned in the time assigned to the game.

The timekeeper shall be provided with a whistle, by means of which a signal shall be given at half-time and at time.

Note. Rule 9. According to the new rules, the timekeeper alone has the right to decide when it is half-time or time. His signal with the whistle stops play immediately, and after it has been given, no goal may be reckoned, nor may the game be continued in any way. Cfr. rule 14, in which it is stated that, if when the signal is given for half-time or time, the whole of the ball has not passed between the goal-posts and beneath the cross-bar, a goal shall not be reckoned.

The Goal Scorers.

Note. Rule 14. The signals given by the goal scorers are to serve to guide the referee, who, however, shall be the sole judge as to whether a goal has been made or not. *Note* the regulation in the new rules that if, when the whistle has been blown for half-time or time, the whole of the ball has not passed between the goal-posts and beneath the cross-bar, no goal shall be reckoned. The goal scorers shall pay particular attention to this point. A goal can be made with the head or the foot, but in such cases the rule always holds good, that, before a goal can be made after a free throw or a throw out, the ball must always have been handled by at least two players. Thus, a goal shall not be reckoned if, after a throw-out from goal, the ball is at once played back into the net with the head or the foot.

The Secretary.

The secretary shall make notes concerning the play, the number of goals made by each side, etc., all in accordance with the directions given by the referee. In accordance with these instructions, too, he shall take measures to announce, in the way prescribed by the regulations, the goals that are made and the state of the game at half-time and time, etc.

INSTRUCTIONS FOR THE OFFICIALS AND COMPETITORS AT THE SHOOTING COMPETITIONS.

General Memorandum.

Rules for the Army Rifle Shooting Competitions.

In addition to the rules and regulations already issued, and with which each competitor must be acquainted before the shooting begins, the following rules shall also be in force.

1. The competitor must not be credited with any point at all (= 0) for a shot that hits a target belonging to another nation or to any other competitor.

2. If on the target of a competitor there is found, on marking, one hit more than he has fired shots, the said competitor shall reckon the best hit, but only on the supposition that the competitor himself has not fired more than one shot; should he have fired more than one shot, he may only reckon the lowest hits.

3. If on the target or figure of a competitor there is found, on marking, two or more hits than he has fired shots, the competitor must fire the series again.

4. Sights which are movable laterally may be moved during the shooting, but may not be exchanged.

5. Change of sights at the same distance may not take place.

A Sketch

is enclosed of the situation and numbers of the balance target-holders during the army rifle shooting competitions at Kaknäs. (See page 159.)

Special Regulations.

A) TEAM COMPETITION

(200, 400, 500, 600 metres).

1. Assembly at Kaknäs, June 29th, 10 a. m.

2. The captain of the team of each nation shall attend at the Office, where lots will be drawn to decide the order in which the various teams shall fire at the various ranges.

3. The captain of the team of each nation shall enter the names of the competitors in writing at the Office for the purpose of registration, and determine the order in which the members of the teams shall fire.

4. Immediately after this, assembly at the 200 metre station, at the southern shooting range.

5. *Regulations for the arrangement and the assignment of the targets.*

a) Each competitor shall be assigned his own target, which will become his property after the result has been registered at the office.

b) Each team will have at its disposal three numbered balance target-holders, each with two targets. One of these targets will be marked at the upper right-hand corner with light-red paper, while the other target will be marked at the top left-hand corner with light-blue paper. On each target there will be the number of the competitor.

c) The competitors will be drawn up in order at the firing-stations by the captain of the nation-team, assisted by the team-officer, in the places which have already been assigned to them.

d) The team-officer shall ascertain by means of the telephone, if the members of the targets and the corresponding competitors agree.

6. Regulations for marking. See fig. 1 (page 149.)

The value of the hit will be shown by the position of the pointer on the target; see fig. 1.

The position of the hit on the target will be shown immediately after the value has been given, by the sharp end of the pointer being placed in the middle of the hole made.

A miss will be marked by the pointer being swung several times in front of the target.

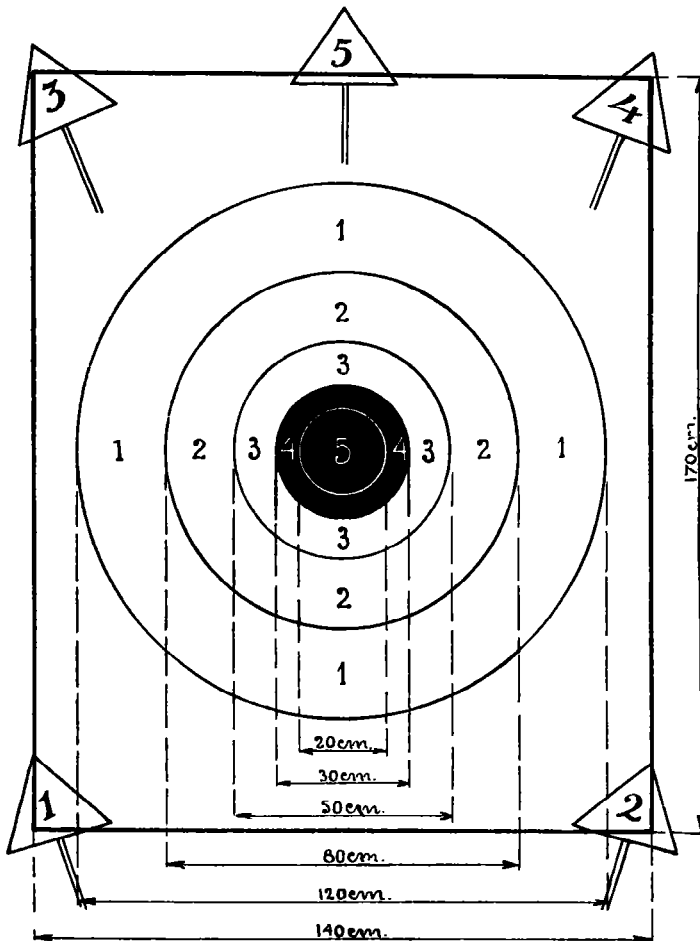

Any challenge of the marking must be made before the next shot is fired by the competitor.

7. Inspection of rifles (fore- and back-sights); see regulations already issued.

8. Regulations for shooting.

a) Any position, but without artificial rest.

b) Competitors with odd numbers shall fire two sighters, with marking between each shot, at targets marked with light-red paper at the upper right-hand corner. The sighters shall be marked on the target with red rings and shall be covered over.

c) Competitors with even numbers shall fire two sighters, with marking between each shot, at targets marked with light-blue paper at the upper left-hand corner. The sighters shall be marked on the target with a red ring and covered over.

d) Competitors with odd numbers shall fire 5 shots, with marking between each shot, at targets marked with light-red paper at the upper right-hand corner. The shot-holes shall be marked with a red cross and covered over.

e) Competitors with even numbers shall fire 5 shots, with marking between each shot, at targets marked with light-blue paper at the upper left-hand corner. The shot-holes shall be marked with a red cross and covered over.

f) The shooting shall continue in the same way, alternating between the odd and even numbers, until 15 shots have been fired by each competitor.

9. The team-officer shall inform the leader of the shooting-competition that the team is ready to begin, and *that the team has no protest to make against shooting.*

10. The leader of the shooting-competition shall give permission for the firing of the sighters to begin.

11. The team-officer shall direct the shooting, and shall inform the leader of the competition when the sighters have been fired.

12. The leader of the shooting-competition shall give permission for the series of 15 shots to begin.

13. The team-officer shall direct the firing to begin, and shall inform the leader of the competition when the firing is ended.

14. Change of target. Removal to the 400 metres range, where *the rifles will be inspected.*

15. *Regulations for the arrangement and assignment of the targets.*

a) *Each competitor will be assigned his own target, which will then be used for the firings at 400, 500 and 600 metres.*

b) The team will have the same balance target-holders as for the 200 metres' competition. One of the targets is marked at the upper right-hand corner with black paper, while the other target has no mark at all. On each target there is the number of the competitor who shall use it.

c) The targets will be assigned to the competitors at the shooting-station by the nation-captain of the team, assisted by the team-officer.

d) *The team-officer will ascertain, by means of the telephone, if the numbers of the targets and corresponding competitors are alike.*

16. *The regulations for marking are the same as for the preceding range.*

17. *The regulations for the shooting are the same as at the foregoing range, but with this difference, that the odd numbers shall fire at targets marked with black paper at the upper right-hand corner, and that the even numbers shall fire at targets which have not a such mark.*

18. *The firing at the 400 metres' range shall then be carried out in the same way as at the 200 metres' distance.* The sighters shall be marked with a red ring round them and covered over. The other shot-holes shall be crossed out with red and covered over.

19. Assembly at 3,30 p. m. at the 500 metres' range for inspection of rifles.

The firing of the 500 metres range shall begin at 4 p. m., and shall be carried out in the same ways as the preceding competitions were. The shot-holes made in the target shall be marked with a green ring or cross, and then covered over.

20. *The firing at the 600 metres' range will take place immediately after the shooting at the 500 metres' distance, and shall be carried out in the same way as in the last-mentioned competition. The shot-holes in the target shall be marked with a blue ring or cross, and then covered over.*

21. *The results of the shooting will be made public by the Office, which will give the competitors their shooting cards and targets after the results have been checked.*

B) INDIVIDUAL COMPETITION.

Distance 600 metres.

1. Assembly at Kaknäs, July 1st, 1.30 p. m.

2. The captain of the nation-team shall attend at the Office, where lots will be drawn for the firing-stations. The lots will be drawn in accordance with the number of competitors entered and in two divisions, viz. for nations with not more than 12 competitors, and nations with not more than 8.

3. The captain of the nation-team shall give in at the Office, for the purpose of registration there, a written list of the names of the competitors and of the order-number of the men.

4. Immediately afterwards, the competitors shall assemble at the 600 metres' firing-station at the south range.

5. *Regulations for the arrangement and assignment of the targets.*

a) *Each competitor shall be assigned a target for himself, which will become his property after the result has been registered at the office.*

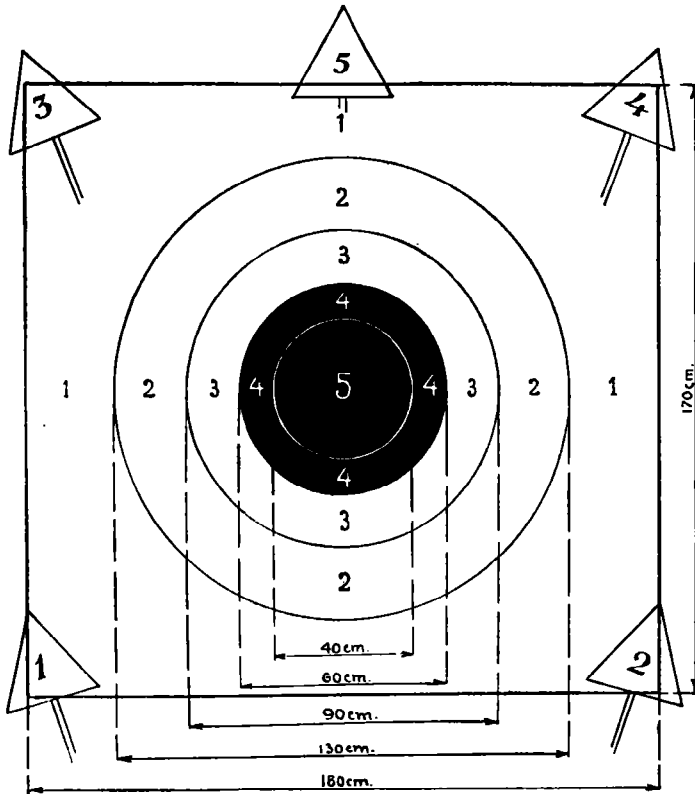

Fig. 2.

b) Each nation shall form one team, and, as a rule, shall have at its disposal 3 balance target-holders.

c) Greece and South Africa shall each have at its disposal two balance target-holders.

d) Denmark and Austria together shall have two balance target-holders at their disposal.

e) Chili shall have one balance target-holder at its disposal.

f) The competitors in each team shall be divided into four divisions, A, B, C, and D, and shall be numbered according to the numbers on the balance target-holders, thus: 1A, 1B, 1C, 1D; 2A, 2B, 2C, 2D; 3A, 3B, 3C, 3D; etc.

g) The competitors will be drawn up in order at the firing-stations by the captain of the nation-team assisted by the team-officer, in the places which have already been assigned to them.

h) The team-officer shall ascertain, by means of the telephone, if the numbers of the targets and the respective competitors are alike.

6. Regulations for the marking. See fig. 2.

a) The value of the hit will be shown by the position of the pointer on the target; see fig. 2.

b) The position of the hit on the target will be shown, immediately after the value of the shot has been given, by the sharp end of the pointer being placed in the centre of the hit.

c) A miss will be shown by the pointer being swung several times in front of the target.

d) *If a challenge is made, it must be done before the competitor has fired another shot.*

7. Inspection of rifles and pull of trigger.

8. *Instructions for the shooting.*

a) Any position, but without artificial support.

b) A-competitors shall fire 5 sighters, with marking between each shot, at numbered *a*-targets (only one target on each balance target-holder).

The sighters shall be marked with a red ring round them and covered over.

c) A-competitors shall fire 20 shots in succession, with marking between each shot. Hits shall be marked with a red cross and covered over.

d) Change of target and control of targets, and in section 5 h, above.

e) B-competitors shall fire 5 sighters, with marking between each shot, at numbered *b*-targets. The sighters shall be marked with a red ring around them and covered over.

f) B-competitors shall fire 20 shots in succession, with marking between each shot. The hits shall be marked with a red cross and covered over.

g) Change of target, and control of target, as above.

h) C- and D-competitors shall fire their series in the same way.

9. *The team-officer shall inform the leader of the shooting competition that the team is ready to begin, and that the team has no protest to make against the shooting.*

10. The leader of the shooting competition shall give permission for the firing of the sighters to begin.

11. The team-officer shall inform the leader of the competition when the sighters have been fired.

12. The leader of the shooting competition shall give permission for the series (20 shots) to be begun.

13. The team officer shall inform the leader of the competition when the firing is ended.

14. *The result of the shooting will be made public by the Office, which will also give the competitors their shooting cards and targets as soon as the results have been examined and registered.*

C) INDIVIDUAL COMPETITION.

Distance 300 metres.

1. Assembly at Kaknäs, July 1st, 8 a. m.

2. The captain of the nation-team shall attend at the Office, where lots will be drawn for the firing-stations.

3. The captain of the nation-team shall give in at the Office, for the purpose of registration there, a written list of the names and the order-numbers of the competitors.

4. Immediately afterwards, the competitors shall assemble at the 300 metres' firing-station at the south range.

5. *Regulations for the arrangement and the assignment of the targets.*

a) *Each competitor shall be assigned a target and a figure for himself, which shall become his own property after the result has been registered at the office.*

b) Each nation shall be assigned as many balance target-holders as there are competitors entered for the nation.

c) The competitors shall be divided into four divisions, a, b, c, and d, and shall be numbered according to the numbers on the balance target-holders, in addition to the letter distinguishing each division.

d) For each division the targets are divided into five groups, viz:

Group	I targets	1—6
»	II »	9—14
»	III »	17—22
»	IV »	25—30
»	V »	33—38

e) The competitors will be drawn up in order at the firing-stations by the captain of the nation-team assisted by the team-officer, in the places which have already been assigned to them.

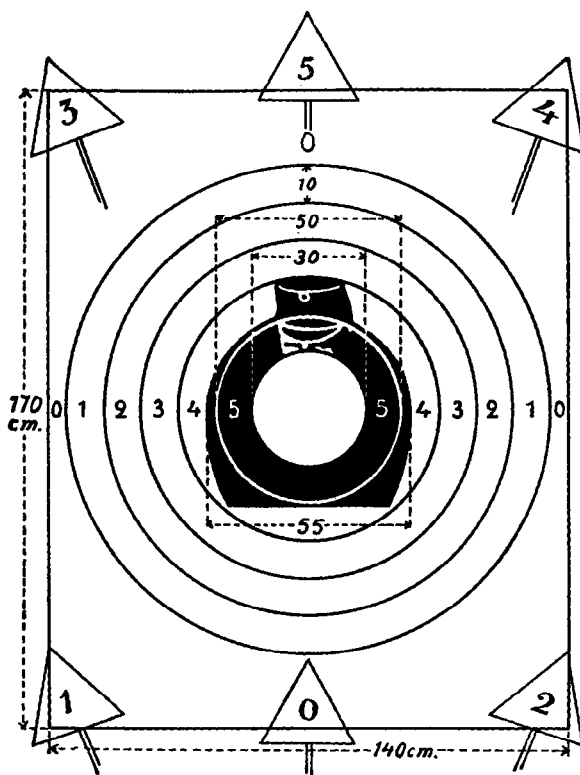

Fig. 3.

f) The team-officer shall ascertain by means of the telephone if the numbers of the targets and the respective competitors are alike.

6. Regulations for the marking. See fig. 3.

a) The value of the hit will be shown by the position of the pointer on the target. See fig. 3.

b) The position of the hit on the target will be shown immediately after the value of the shot has been given, by the sharp end of the pointer being placed in the centre of the hit.

c) A hit on the figure will be marked by the pointer being held right over the figure.

d) A miss will be shown by the pointer being swung several times in front of the target.

e) If a challenge is made, it must be done before the competitor has fired another shot.

7. Inspection of the rifle and pull of the trigger.

8. Regulations for the shooting.

a) Each competitor shall fire 2 sighters in any position, with marking between each shot, at the stationary target. The sighters shall be marked with a red ring around them and covered over.

b) Then 10 shots shall be fired in succession; 4 in a lying position, 4 in a kneeling position, and 2 in standing position, within a total period of not more than 3 minutes, inclusive of the time occupied by loading and taking up the firing positions. Before beginning the series, the competitor shall be in standing position, at "Ground arms!", and with the mechanism open.

c) After the marking has taken place, and after the hits have been marked with a red cross, 10 shots shall be fired at a half-figure, 5 of which shots shall be fired in a lying position, and 5 in a kneeling position, during a total period of not more than 3 minutes, inclusive of the time occupied by the loading and taking up firing positions. Before beginning the series, the competitor shall be in standing position, at "Ground arms!" and with the mechanism open.

The marking shall then take place, and the hits be marked with a red cross.

9. The team-officer shall inform the leader of the shooting competitions that the groups of division 1 are ready to begin firing, and *that the groups have no protest to make against the shooting.*

10. The leader of the shooting competition shall give the order "2 profskott — Eld!" (2 sighters — Fire!).

11. The team-officer shall inform the leader of the competition when the sighters have been fired.

12. The team-officer shall ascertain that each competitor has the correct number of cartridges (10).

13. The leader of the competition shall give the order "Färdiga — 10 skott — Eld!" (Ready — 10 shots — Fire!).

14. After 3 minutes have elapsed, the leader of the competition and the team-officers shall stop the firing by a signal whistle.

15. The marking takes place.

16. The team-officer shall inform the leader of the competition that the shooting at the half-figure can begin.

17. The leader of the competition gives the order "Färdiga — 10 skott — Eld!" (Ready — 10 shots — Fire!).

18. The leader of the competition and the team-officers shall stop the firing by a signal whistle.

19. Marking of the hits on the half-figure.

20. The targets are changed for the competitors of division 2. *The team-officer shall ascertain by means of the telephone that the numbers of the targets and the respective competitors are alike.*

21. Division 2 shall shoot.

22. Divisions 3 and 4 shall carry out their shooting in the same way.

23. *The result of the shooting will be published by the Officer, which will also give the competitors their shooting cards, targets and figures, as soon as the results have been examined and registered.*

D) TEAM COMPETITION

Distance 300 metres.

1. Assembly at Kaknäs, July 4th, 9 a. m.

2. The captain of the team shall attend at the Office, where lots will be drawn to determine the number order which the team as a whole shall have at the ranges.

3. The captain of the team shall, for the purpose of registration at the Office, there enter in writing the names of the members of the team, and then fix the number-order of the competitors.

4. Immediately after this, assembly at the 300 metres' firing-station at the southern range.

5. *Regulations for the arrangement and assignment of the targets.*

a) *Each competitor shall receive three targets for himself; one for each firing-position, and these targets shall be handed over to the competitor after the result of the shooting has been registered at the Office.*

b) The team shall have at its disposal three numbered balance target-holders with two targets on each holder. One of these targets is marked in the upper right-hand corner with light-red paper, and the other target is marked in the upper left-hand corner with light-blue paper. On each target there is the number of the competitor to whom it has been assigned.

The competitors shall be drawn up in order at the firing-stations by the captain of the nation-team assisted by the team-officer, in the places which have already been assigned to them.

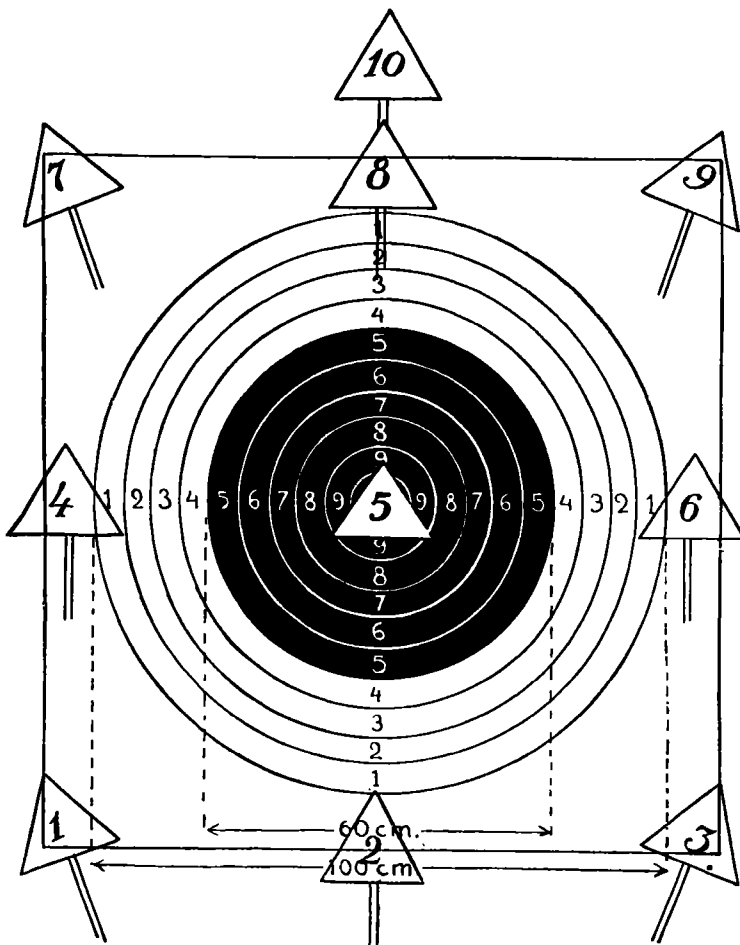

Fig. 4.

e) The team-officer shall ascertain by means of the telephone whether the numbers of the respective targets and the competitors using them are alike.

6. Regulations for marking. See fig. 4.

a) The value of the hit is shown by the position of the pointer on the target; see fig. 4.

b) The position of the hit on the target will be shown immediately after the value has been given, by the sharp end of the pointer being placed on the centre of the hit.

c) A miss, or a hit which is outside ring 1 on the target, will be shown by the pointer being swung several times in front of the target. If the shot has hit the target outside ring 1, the sharp end of the pointer, after the latter has been swung in front of the target, will be laid on the centre of the shot-hole in the target.

d) If a challenge is made, this must be done before the competitor fires again.

7. Inspection of rifle and pull of the trigger.

8. Regulations for the firing.

a) Competitors with odd numbers may fire 5 sighters, with marking between each shot, in any firing position, at targets, marked with light-red paper in the upper

right-hand corner. The sighters shall be marked on the target with a red ring and shall then be covered over.

b) Competitors with even numbers *may* shoot 5 sighters in any position, with marking between each shot, at targets marked with light-blue paper in the upper left-hand corner. The sighters shall be marked on the target with a red ring and covered over.

c) Competitors with odd numbers *may* fire 5 additional sighters, in accordance with regulation 8 a, above.

d) Competitors with even numbers *may* fire 5 additional sighters, in accordance with regulation 8 b, above.

e) Competitors with odd numbers shall fire 5 shots in standing position, with marking between each shot, at targets, marked with light-red paper in the upper right-hand corner. The shot-holes shall be marked with a red cross and covered over.

f) Competitors with even numbers shall fire 5 shots in standing position, with marking between each shot, at targets, marked with light-blue paper in the upper left-hand corner. The shot-holes shall be marked with a red cross and covered over.

g) The firing shall be continued in the same way, by the odd and even numbers alternately, until each competitor has fired 40 shots in standing position.

h) After the targets have been changed, each competitor shall fire not more than 10 sighters, and then 40 shots in a kneeling position, in the same way as described above for the firing in standing position. The shot-holes shall be marked with a *green ring* for the sighters and a *green cross* for other hits, and covered over:

i) After the targets have been changed, each competitor shall fire not more than 10 sighters, and then 40 shots in lying position, in the same way as described above for the firing in standing position. The shot-holes shall be marked with *blue rings* for sighters and *blue crosses* for other hits, and then covered over.

9. The team-officer shall inform the leader of the shooting competitions that the team is ready to begin firing and *that the team has no protest to make against the shooting.*

10. The leader of the shooting competitions shall give permission for the firing of the sighting-shots to begin.

11. The team-officer shall order this firing to begin, and shall inform the leader of the shooting competition when the sighting-shots have been fired.

12. The leader of the competition shall give permission for the firing of the series of 40 shots in standing position to begin.

13. The team-officer shall order this firing to begin, and shall inform the leader of the competition when it is ended.

14. Change of targets; after which the firing shall be immediately continued in kneeling position, in the same way as described for the shooting in standing position.

15. Change of targets. Rest. Re-assembly at Kaknäs the same day at 3.30 p. m., at the 300 metres' range for inspection of rifles.

16. At 4 p. m. the team shall begin firing in lying position, the shooting being carried out in the same way as with the firing in standing and kneeling positions.

17. The team-officer shall inform the leader of the competitions when the firing is finished.

18. *The result of the shooting will be published by the Office, which shall give the competitors their shooting-cards and targets after the results have been examined and registered.*

E) INDIVIDUAL COMPETITION

Distance 300 metres.

1. Assembly at Kaknäs, July 2nd, 9 a. m.

2. The captain of the nation team shall attend at the Office, where lots shall be drawn for firing-stations.

3. The captain of the team shall, for the purpose of registration at the Office, there enter in writing the names of the competitors and fix the number order of the competitors.

4. Immediately after this, assembly at the 300 metres' range at the northern and southern firing ranges.

5. *Regulations for the arrangement and assignment of the targets.*

a) Each competitor shall receive three targets for himself, one for each firing-position, and these targets shall be handed over to the competitor after the result of the shooting has been registered at the Office.

b) As a rule each nation shall have 6 balance target-holders, with two targets on each holder.

c) Competitors from Austria shall have target-holder N:o 37 at the southern range.

d) Competitors from Greece shall have target-holder N:o 38, at the southern range.

e) Competitors from Africa shall have target-holders N:os 21—24, at the northern range.

f) Competitors from Chili shall have target-holders N:os 19—20 at the northern range.

g) The competitors will be drawn up in order at the firing-stations by the captain of the nation-team assisted by the team-officer, in the places which have already been assigned to them.

h) *The team-officer shall ascertain by means of the telephone that the numbers of the respective targets and the competitors using them are alike.*

6. *Regulations for marking.* See fig. 4.

a) The value of the hit is shown by the position of the pointer on the target. See fig. 4.

b) The position of the hit on the target will be shown immediately after the value has been given, by the sharp end of the pointer being placed on the centre of the hit.

c) A miss, or a hit which is outside ring 1 on the target, will be shown by the pointer being swung several times in front of the target. If the shot has hit the target outside ring 1, the sharp end of the pointer, after the latter has been swung in front of the target will be laid on the centre of the shot-hole in the target.

d) *If a challenge is made, this must be done before the competitor fires again.*

7. Inspection of rifle and pull of trigger.

8. *Regulations for the firing.*

The firing shall take place in the manner described in § 8 Team Competition d).

9. The team-officer shall inform the leader of the shooting competitions that the team is ready to begin firing, and *that the team has no protest to make against the shooting.*

10. The leader of the shooting competitions shall give permission for the sighting-shots to be begun.

11. The team-officer shall order this firing to begin, and shall inform the leader of the competition when the sighting-shots have been fired.

12. The leader of the competition shall give permission for the firing of the series of 40 shots in standing position to begin.

13. The team-officer shall order this firing to begin, and shall inform the leader of the competition when it is ended.

14. Change of targets; after which the firing shall be immediately continued in kneeling position, in the same way as described for the shooting in standing position.

15. Change of targets. Rest. Re-assembly at Kaknäs the same day at 3.30 p. m., for inspection of rifles.

16. *At 4 p. m.* the firing shall begin in lying position, the shooting being carried out in the same way as with the firing in standing and kneeling positions.

17. The team-officer shall inform the leader of the competitions when the firing is ended.

18. *The result of the shooting will be published by the Office, which shall give the competitors their shooting-cards and targets after the results have been examined and registered.*

Miniature Rifle and Revolver and Pistol Shooting.

GENERAL REGULATIONS.

1. On Saturday, 29th June, 1912, 9.30 a. m., all the competitors in Duel Shooting (team- and individual competitions) shall assemble at the shooting range at Kaknäs, and the captains of the different teams shall be then present for the purpose of learning the hours when the representatives of the respective countries are to compete.
2. The competitor has the right to examine the result of the hits himself by means of a field-glass, but, during the progress of the shooting, all other persons are forbidden to give information respecting the position of the hits.
3. Hours for the various competitions. See the Daily Programme.
4. Those desirous of practising at the ranges can do so on June 27 and 28 between 10 a. m. and 6 p. m.

SPECIAL REGULATIONS.

MINIATURE RIFLES.

f) and g) *Team- and Individual Competitions. Distance 50 metres.*

1. The series embraces 5 shots, after which the marking and the change of target will take place.
2. In order that the shooting may be concluded within the time stated in the programme, the period allowed for the series of 5 shots will be restricted to about 10 minutes.
3. Calculations of points: In the event of a tie between two or more competitors the result shall be decided by the greatest number of "fives". Should these, again, be equal, then the "fours" shall decide the matter, a black four counting before a white four. If this, however, is not sufficient to decide the question, the tie shall be decided by 20 more shots.

h) and i) *Team- and Individual Competitions. Distance 25 metres.*

1. No allowance will be made for mis-fires or for shots with, in other respects, defective ammunition.
2. A shot not fired shall be counted as a miss.
3. Only one shot may be fired each time the figure is shown.
4. In the event of a tie in the number of hits and points between two or more competitors, the matter shall be decided by the greatest number of "tens", and then by the greatest number of "nines", and so on.
If, in spite of this, it is not possible to decide the tie, it shall be shot off by 15 more shots.

REVOLVER AND PISTOL SHOOTING.

j) and k) *Team- and Individual Competitions. Distance 50 metres.*

1. In the case of a tie, the question shall be decided, first of all by the greatest number of "tens", then by the greatest number of "nines", and so on.
If, in spite of this, it is not possible to decide the tie, it shall be shot off by 30 more shots.

l) and m) *Team- and Individual Competition in Duel Shooting. Distance 30 metres.*

1. No allowance will be made for mis-fires or for shots with, in other respects, defective ammunition.
2. A shot not fired shall be counted as a miss.
3. Only one shot may be fired each time the word "Eld" (fire!) is given.
4. It is forbidden to take aim with the weapon before the word "Eld" (fire!) is given.

A SKETCH

of the

numbers and places of the balance target=holders for the teams at the shooting=ranges at Kaknäs.

a) Team competition, distance 200, 400 500 and 600 metres

South range.

N:o.....	38, 37, 36	34, 33, 32	31, 30, 29	27, 26, 25	24, 23, 22	20, 19, 18	17, 16, 15	13, 12, 11	10, 9, 8	6, 5, 4	3, 2, 1
Team	XI	X	IX	VIII	VII	VI	V	IV	III	II	I

b) Individual competition, distance 600 metres.

South range.

N:o.....	38, 37	36, 35	33, 32	30, 29	27, 26, 25	24, 23, 22	20, 19, 18	17, 16, 15	13, 12, 11	10, 9, 8	6, 5, 4	3, 2, 1
Team	XII	XI	X	IX	VIII	VII	VI	V	IV	III	II	I

c) Individual competition, distance 300 metres.

South range

N:o.....	38, 37, 36, 35, 34, 33	30, 29, 28, 27, 26, 25	22, 21, 20, 19, 18, 17	14, 13, 12, 11, 10, 9	6, 5, 4, 3, 2, 1
Team	V	IV	III	II	I

d) Team competition, distance 300 metres.

N:o.....	38, 37, 36	35, 34, 33	32, 31, 30	27, 26, 25	24, 23, 22	19, 18, 17	16, 15, 14	11, 10, 9	8, 7, 6	3, 2, 1
Team	X	IX	VIII	VII	VI	V	IV	III	II	I

e) Individual competition, distance 300 metres.

South range.

N:o	38, 37	36, 35, 34, 33, 32, 31	30, 29, 28, 27, 26, 25	24, 23, 22, 21, 20, 19	18, 17, 16, 15, 14, 13	12, 11, 10, 9, 8, 7	6, 5, 4, 3, 2, 1
Team	VI	V	IV	III	II	I	I

N:o.....	24, 23, 22, 21	20, 19	18, 17, 16, 15, 14, 13	12, 11, 10, 9, 8, 7	6, 5, 4, 3, 2, 1
Team	S. Africa	Chili	IX	VIII	VII

THE MEDALS, BADGES AND DIPLOMAS OF THE FIFTH OLYMPIAD.

At a meeting of the Swedish Olympic Committee, held on the 17 May, 1910, it was resolved to refer the question of the medals and badges for the Olympic Games of Stockholm, 1912, to the newly elected Advertisement- and Reception Committee. In October 1910, this sub-committee was further divided into four special committees, to one of which (as may be seen by its title) was entrusted the entire management of all matters concerning the planning and execution of the medals, badges and diplomas for the Games.

Doctor Astley Levin was the sole member of this special committee.

The Prize Medals.

In accordance with the General Programme of the Games, as determined by the International Olympic Committee, the first prize in individual events was to consist of a gold medal, but, in team events, of a silver-gilt medal for each member of the team; the second prize, for all competitions, was a silver medal, or medals, and, for the third prize, a bronze medal, or medals. The Swedish Olympic Committee resolved, however, to make the following exceptions from this rule: A gold medal was to be presented to each member of the winning teams in the Horse Riding Competitions; the first prize in the Lawn Tennis Doubles was to be a gold medal for each member of the winning pairs, and, in the Yacht Racing, as first prize in the 12-metres Class, a gold medal was to be awarded both to the successful helmsman and to his mate or leading hand.

The Fencing Committee asked that 8 prize medals should be awarded for the individual fencing competitions, but the Swedish Olympic Committee could not accede to the request.

After the Swedish Olympic Committee had come to the resolution, in May, 1910, that the prize medals should bear the same obverse as that adopted for the London Games, and that Mr. Erik Lindberg should be asked to make a design for the reverse of the medal, a sketch by the above-mentioned engraver was laid before the said Committee at a meeting held on the 14 November, 1910, and was approved of after a short discussion. The prize medal, according to this design, was to have the following appearance:

The *Obverse side*; permanent or two female figures crowning a young victor in the Olympic Games with a laurel wreath;

The *Reverse*; the figure of a herald, proclaiming the Olympic Games, and standing close to a bust of Ling, the founder of the Swedish system of gymnastics.

The diameter of the prize medal was fixed at 33 millimetres (circa $1\frac{1}{3}$ inches), or the same as that of the London Olympic medal.



OLYMPIC PRIZE- AND COMMEMORATION MEDALS, 1912.



BADGES WORN BY THE MEMBERS OF THE INTERNATIONAL OLYMPIC COMMITTEE, THE NATIONAL OLYMPIC COMMITTEES AND THE SWEDISH OLYMPIC COMMITTEE, 1912.



BADGES FOR OFFICIALS, COMPETITORS AND PRESSMEN, 1912.



H. M. KING GUSTAF V's MEDAL IN MEMORY OF THE OLYMPIC GAMES OF STOCKHOLM, 1912.

At the same meeting it was also determined, after an examination of tenders procured from abroad by the Medal and Badge Committee, that the medals and badges in question should be made in Sweden and, later on, an agreement was made with Messrs. C. C. Sporrang & C:o, Stockholm, whereby the said firm undertook the manufacture of the prize medals, commemoration medals and badges for the competitors.

The following numbers of the prize medal were struck:

90	gold medals
200	silver-gilt medals
285	silver medals
270	bronze medals.

or, in all, 845.

A contract was made with Messrs. Ernström & Medberg, Stockholm, for the delivery of boxes for the medals, the Committee ordering

blue boxes for the.....	gold medals
gold » » »	silver-gilt medals
red » » »	silver medals
green » » »	bronze medals.

The Commemoration Medal.

In May, 1910, the Swedish Olympic Committee determined to issue a commemoration medal to be presented to the functionaries and competitors taking part in the Games, and resolved that the obverse of this medal should be the same as that of the Commemoration Medal of the London Games. After the Medal and Badge Committee had sent in several designs for the reverse, drawn by Mr. E. Lindberg, the Swedish Olympic Committee, at a meeting on the 20 February, 1911, settled the definite appearance of the medal in question.

The Obverse, the *permanent* side, represents an classic Greek chariot drawn by four horses, in which stands two male figures, one the charioteer and the other the judge, ready to present the triumphant athlete with the palm of victory; the *Reverse* shows, on the capital of an Ionian column, Zeus, sitting in a chair of ancient form, and holding a figure of the Goddess of Victory in his hand. In the background can be seen the outlines of the Royal Palace of Stockholm, together with those of Helgeandsholmen Island and of the façade of the Riksdag House.

Regarding the distribution of the Commemoration Medal, of which 2 copies were made in gold, 50 in silver, 100 in bronze, and about 6,000 in oxidized and ordinary pewter, the Swedish Olympic Committee determined that the Commemoration Medal in *gold* should be presented to H. M. King Gustavus and to H. R. H. the Crown Prince of Sweden; in *silver*, to the members of the Swedish Olympic Committee and the International Olympic Committee; in *bronze*, to the Presidents of the Special Committees and to the Chairmen of the International Juries; in *oxidized* and *ordinary pewter*, to the other functionaries; to all the competitors that started in any event; to the

staffs of all the offices of the Swedish Olympic Committee, and, finally, to all those persons, both at home and abroad, who had laboured for, and helped to further, the success of the Games.

The Badges for the Officials and Competitors.

On the 14 November, 1910, the Swedish Olympic Committee accepted for the badge to be given to the officials and competitors present at the Games, a design by Erik Lindberg, representing the head of Pallas Athene, as the principal figure, resting on a four-sided plinth adorned with the Three Crowns of Sweden. The plinth bore the following inscription in Swedish: "The Olympic Games of Stockholm, 1912". About 5,000 examples of the badge were struck in oxidized silver-plated metal, in addition to which, some 50 were struck, made of silver-gilt, the last-mentioned being for the members of the Swedish and the International Olympic Committees.

As the badge for the officials and the competitors was to entitle the wearer to admission to all the places where competitions were to be held, and as places had been reserved in various sections of the Stadium for the different groups of functionaries, the Swedish Olympic Committee determined on the following system of mounting and distributing the badge in question:

The badge, in silver-gilt and attached to a blue and yellow ribbon, was to be worn by the members of the Swedish Olympic Committee, and was to entitle the wearers to admission to the box in the Stadium north of, and next to the Royal box; to a reserved seat at all the other places where the Olympic competitions were being held; to the seats on the northern slope of the Stadium and to all the evening entertainments at the Stadium during the period July 6—July 15.

The same badge, unmounted, was distributed to the members of the International Olympic Committee, and conferred the same privileges as were attached to that worn by the Swedish Olympic Committee.

The same badge unmounted and in silver-gilt, was presented to the ladies of the members of the Swedish and the International Olympic Committees, and entitled the bearers to the same privileges as those possessed by the said members.

The presidents of the special committees, and the leaders of the teams of the various nations, were presented with the badge mounted on a blue-and-yellow cockade. This badge, together with a blue identification-card, entitled the wearer to admission to the Committee-box at the Stadium; to a reserved seat at all the other places where Olympic Competitions were being carried on, and to the northern slope of the Stadium.

The competitor's badge, attached to a small yellow cockade, and accompanied by a yellow identification-card, admitted the higher officials and the assistant leaders of the various nations to the Committee-box at the Stadium, and to the northern slope of the Stadium.

The other functionaries of the various nations received a competitor's badge mounted on a blue-and-yellow bow and riband, this

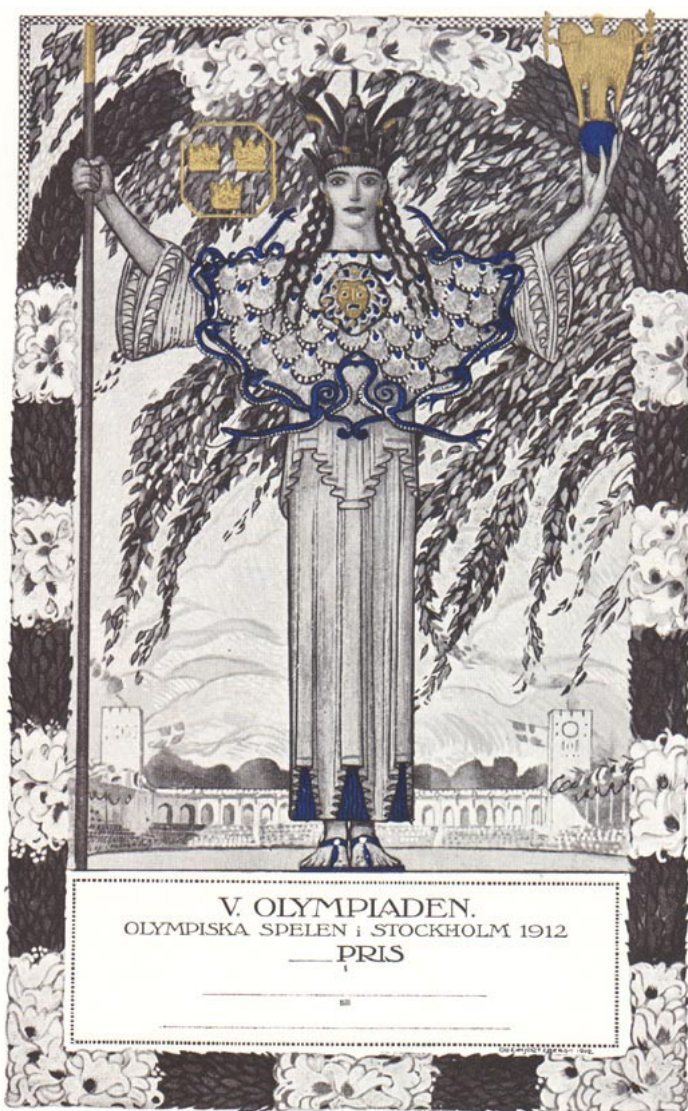

PRIZE DIPLOMA. OLYMPIC GAMES, 1912.

entitling them to admission to the northern slope of the Stadium, but not to the competing places other than the Stadium, unless the wearer also possessed an official's card for the branch of athletics that might be going on at any of the said places.

Those persons acting as "hosts" of the various nations, were given the competitor's badge attached to a bow in the colours of the respective nations. Together with a blue identification-card, these badges admitted the bearer to all the competitions.

The competitor's badge, which was presented to all the active competitors, gave admission to the northern slope of the Stadium, but not to any other competing ground, unless the bearer of the badge also possessed a competitor's card for one or other of the competitions carried on at these places.

The journalists present officially at the Games were presented with a special badge in the form of a metal button, with the inscription "Stadion. Pressen", in gold letters on a blue enamel ground. This badge entitled the wearer to free admission to the Press-box at the Stadium and, if he also possessed a special correspondent's-card, to the other competing grounds.

Diploma.

In accordance with the general regulations of the Olympic Games, every prize-medal had to be accompanied by a diploma. In addition to this, it had also been determined that every competitor, other than a winner, whose performance was of pre-eminent merit, should be presented with a special Diploma of Merit. Such diplomas were also promised to every non-winner in the Marathon Race and in the Cycling Race round Lake Mälär, who passed the winning-post within the winner's time plus 25 %.

In August, 1911, Professor Olle Hjortzberg, of the Royal Academy, was requested to make a design for the Olympic Diploma, and in the middle of March, 1912, a number of different designs were laid before the Swedish Olympic Committee, of which the Committee approved and accepted, one representing the goddess Pallas Athene, with, in the background, the Stadium, in which a gymnastic display is being given. In her right hand the goddess holds a staff and, in her uplifted left hand, the Greek symbol of victory. Above, to the right, hangs a shield with the three crowns of Sweden, with a drooping birch-tree at the back. This diploma was used both for the prize-diploma and the diploma of merit. Its size was fixed at 47,5 cm. × 65 cm.

About 1,000 prize-diplomas and 450 diplomas of merit were awarded.

After the conclusion of the Games, the Swedish Olympic Committee determined to issue the following additional diplomas: *The Commemoration Diploma*: presented to all the principal Associations represented at the Games, to the members of the International Olympic Committee, and to the leading personages in the various national Olympic Committee. — *The Diploma for Meritorious Work*: presented to the members of the Swedish Olympic Committee and to the presidents and secretaries of the special committees. — *The Contractors' Diploma*: presented

to the firms, etc., that had meritoriously carried out the contracts made with the Swedish Olympic Committee and the Stadium.

Altogether, some 2,000 diplomas have been awarded.

Other Badges. Winners' Decorations.

As a common mark for the sporting costume to be worn by the Swedish representatives at the Games, the Swedish Olympic Committee, on the 21 May, 1912, fixed on a shield-shaped badge bearing the three crowns of Sweden on a light-blue ground, but as it proved impossible to obtain a sufficient number of these badges in time for the Games, the Committee, at a later meeting, determined to adopt, as the common mark for the Swedish competitors, a Swedish flag, 12 cm. × 7 cm.

At the beginning of 1911, the Swedish Olympic Committee determined that, immediately after the conclusion of each individual competition, the winner should be crowned with an oak-wreath but this resolution was altered later on, it being settled that, at the solemn distribution of prizes, all the winners of first prizes should receive oak-wreaths bound with ribands in the Swedish colours.

As regards the Marathon Race, however, it was settled that the winner, on arriving at the goal, should be presented with a large oak-wreath.

The Gustaf V. Olympic Medal.

H. M. King Gustaf V ordered a medal to be struck in memory of the Olympic Games of Stockholm, 1912, to be worn on the left breast, like the insignia of the Swedish Orders of Knighthood.

H. M. the King has been graciously pleased to present this medal to the members of the Swedish and foreign Royal families; to the members of the International and the Swedish Olympic Committee; to the official representatives of the various nations; to the members of the special committees; to the leading officials, and to the Swedish prize-winners at the Games.

THE CHALLENGE PRIZES OF THE OLYMPIC GAMES.

At the Olympic Games of London, 1908, there were 12 challenge prizes awarded, Viz., that presented by

H. M. the King of Greece	for the Marathon Race
M:me G. DE MONTGOMERY	» Throwing the Discus, best hand
The GOLD & SILVERSMITHS C:o ...	» Wrestling, Heavy Weight
H. R. H., the Prince of Wales ...	» 100 kilometres Cycle Race
English Football Association	» Football
» Fencers	» Fencing; Team competition with épée



GROUP OF OLYMPIC CHALLENGE PRIZES.



Challenge Prize for Marathon Race.
Presented by H. M. the King of Greece.



Challenge Prize for Throwing the Discus.
Presented by Mme. G. de Montgomery.



The Challenge Prize for the Pentathlon.
Presented by H. M. the King of Sweden.

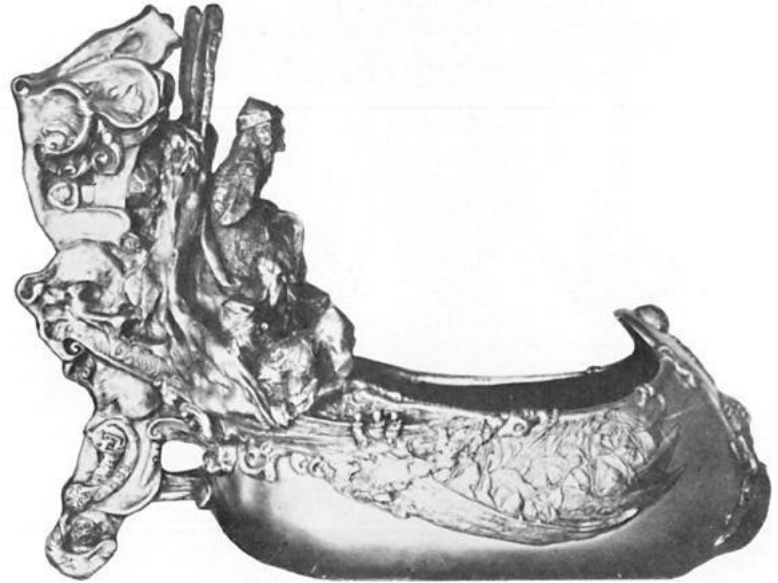

Challenge Prize for the Decathlon.
Presented by H. I. M. the Emperor of Russia.



The Challenge Cup for Wrestling, Heavy Weight.
Presented by the Gold & Silversmiths' Co.



Challenge Prize for Football.
Presented by the English Football Association.



The Challenge Cup (the "Pourtalès Vase") for the Épée Team Competition. Presented by the British Fencers.



The Challenge Prize for the Sabre Team Competition. Presented by the City of Buda-Pesth.



The Challenge Prize for Ind. Gymnastics.
Presented by the City of Prague.



The Challenge Prize for the Military.
Presented by H. I. M. the Emperor of Germany.



The Challenge Prize for Prize Riding.
Presented by H. I. M. the Emperor of Austria.



The Challenge Prize for Prize Jumping, Ind. Comp.
Presented by Count Geza Andrassy.



The Challenge Prize for Prize Jumping, Team Comp.
Presented by H. M. the King of Italy.



The Challenge Prize for the Horse Riding Comp.
Presented by the Swedish Cavalry.



The Challenge Cup for Modern Pentathlon.
Presented by Baron P. de Coubertin.



The Challenge Prize for Rowing: Eights.
Presented by Count Brunetta d'Usseaux.



The Challenge Prize for Yacht Racing, 6 m. class.
Presented by the French Government.



The Challenge Cup for Swimming Race, 1,500 m.
Presented by Count Brunetta d'Usseaux.



The Challenge Cup for High (Plain) Diving, for Ladies.
Presented by Countess de Casa Miranda.



The Challenge Cup for Clay Bird Shooting, Ind. Comp.
Presented by Lord Westbury.

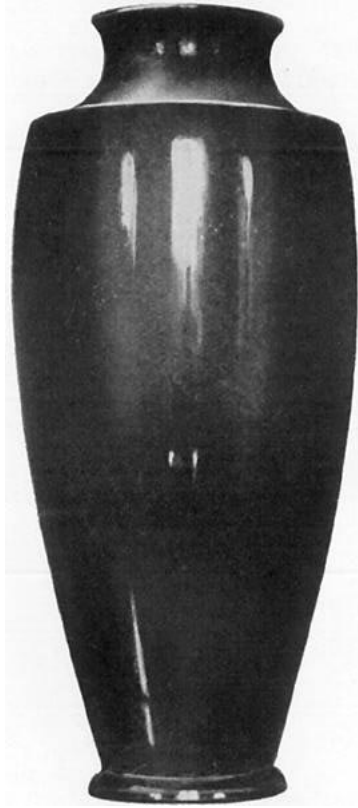

Sèvres Vase.
Presented by the President of the French Republic.



Sèvres Dish.
Presented by the President of the French Republic.

The City of Prague	for Gymnastics, Individual competition
HURLINGHAM CLUB.....	Polo
Count BRUNETTA D'USSEAUX	Rowing, Eights
» » »	Swimming, 1,500 metres, free style
Lord WESTBURY	Clay Bird Shooting, Individual competition
The French Government.....	Yacht Racing, 6 metres' class.

Of these prizes, those for the 100 kilometres' cycle race and the polo competition could not be awarded at the Olympic Games of Stockholm, the events in question not forming part of the programme of the Fifth Olympiad. For this Olympiad, however, there were instituted 10 new prizes, so that, at the Games of Stockholm, there were awarded no less than 20 challenge prizes.

The newly presented prizes were those given by

H. M. the King of Sweden	for the Pentathlon competition.
H. M. the Emperor of Russia.....	» » Decathlon »
The City of Buda-Pesth	» Fencing ; Team competition with sabre
H. M. the Emperor of Germany »	the Military
H. M. the Emperor of Austria ...	» Prize Riding
Count GEZA ANDRASSY	» Prize Jumping, Individual competition
H. M. the King of Italy	» Prize Jumping, Team competition
The Swedish Cavalry	to that nation whose representatives obtained the best total result in all the Horse Riding competitions
Baron P. DE COUBERTIN	for the Modern Pentathlon
The Countess DE CASA MIRANDA »	» High Plain Dive for Ladies.

In addition to this, two Sévres vases were presented by the President of the French Republic, and they were afterwards given to the National Association of the Swedish Gymnastic and Athletic Clubs, and the Swedish Central Association for the Promotion of Athletics.

The following regulations respecting the handing over of the challenge prizes were included in the General Rules of the Games:

“Challenge prizes will not be handed over unless the winner and at least two members of the Olympic Committee concerned give a written obligation — signed on a form provided by the Swedish Olympic Committee — to deliver the prize before January 1st, 1916, in an undamaged condition to the Organisation Committee for the next Olympic Games, and to make good any damage to the prize in question.”

The wording of the Guarantee in question was as follows:

Guarantee.

Mr.....having won a Challenge Cup for.....at the Olympic Games of Stockholm, 1912, and the said Challenge Cup having been delivered to us through the Swedish Olympic

Committee, we hereby engage, jointly and separately, and in agreement with the regulations of the International Olympic Committee, to deliver the prize in uninjured condition into the hands of the International Olympic Committee or the Organizing Committee for the next Olympiad before the first (1st) of January, 1916, and to make good any damage to the said prize that may happen to it during the period, 15th July, 1912, and 1st January, 1916.

.....
Name Of Winner.

.....
Representatives of the..... Olympic Committee,

A full list of all the challenge prizes, of their donors and of their present holders, will be found among the lists of prizes given at the end of this book.

Of the 20 challenge prizes offered for competition at the Fifth Olympiad there were won by

Sweden	7
Finland.....	2
France	2
Great Britain	2
Belgium.....	1
Canada	1
Hungary	1
Italy	1
Norway	1
South Africa	1
U. S. A.	1



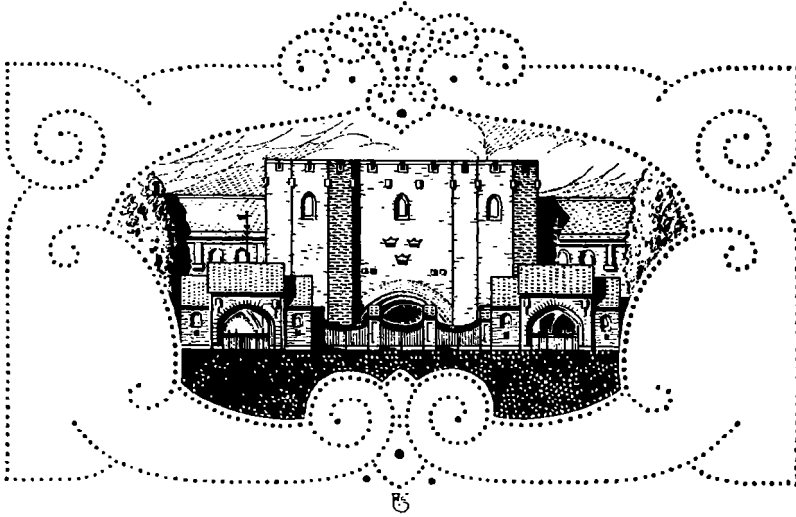

PREPARING THE SITES OF THE COMPETITIONS.

The competitions forming the Olympic Games were so numerous that special measures had to be taken for arranging the various sites where the competitions were to take place. The already existing grounds for track and field events were hardly large enough for, or equal to, all requirements, and very many alterations were necessary, so that it was quite evident from the very first that a Stadium answering all modern requirements would have to be erected for the competitions of the Fifth Olympiad in Stockholm.

The same state of things existed as regards the sites for other branches of athletic sports, especially in consideration of the great number of competitors expected to take part in the Games — a number whose reality far exceeded every expectation. For example, a Swimming Stadium had to be formed in Djurgårdsbrunnsviken Channel, and extensive arrangements made for the rowing matches on the same piece of water; for the shooting competitions, the ranges at Kaknäs had to undergo a number of improvements and alterations, and new ranges were made at Råsunda. Extensive arrangements for the football competitions had to be made at the Råsunda and Traneberg Athletic Grounds; the old Tennis Pavilion from the former Athletic Park was re-erected at the Östermalm Athletic Grounds for the Lawn Tennis- and Fencing Competitions, and improvements and suitable arrangements were made at the Athletic Grounds mentioned, so that the athletes from at home and abroad could make use of the place for training purposes. The Gymnastic-, Horse Riding-, Tug-of-

War-, and Wrestling competitions could, it is true, take place in the Stadium, but a number of special arrangements had to be made there for them, while other special measures had to be taken for the Cross Country and Steeple-Chase events in the Horse Riding and Modern Pentathlon competitions.

THE STADIUM.

THE ORIGIN OF THE BUILDING.

Originally, the Swedish Olympic Committee for the Olympic Games of Stockholm, 1912, had intended to erect a provisional Stadium on the Östermalm Athletic Grounds, to be removed on the conclusion of the Games. This plan had to be rejected for many reasons, one of which was the uncertainty prevailing as to the possibility of being able to retain the grounds in question undisturbed by railway construction, and after Torben Grut, Esq., (the architect engaged by the Committee), and other experts, had examined five different places in addition to the Östermalm Grounds, the Swedish Olympic Committee determined to employ the site of the then existing Athletic Park, just north of Stockholm, as being the most suitable and centrally situated spot, close to the finest residential quarter of Stockholm and possessing good tramway communications. In the immediate neighbourhood of the Athletic Park lay the Tennis Covered Courts, the Östermalm Athletic Grounds, the course of the Field Riding Club, the Golf Greens, Ladugårdsgärdet, and other open spaces where games were played, and several barracks and schools. The new buildings of the Royal Technical High School and the Gymnastic High School, too, were to be erected close to the place where the Stadium was to rise.

The grounds of the Athletic Park were threatened at the time by a proposal to erect the Gymnastic Central Institute there, but it was agreed that the very best solution of the problem of the placing of the proposed buildings for physical education would be, the retention of the Östermalm Athletic Grounds, the building of the Stadium on the site of the Athletic Park, and the erection of the Central Institute on the hill north-east of the Stadium. The first two items of this proposal are now happily a reality.

At first, however, the difficulties in the way seemed insuperable. To begin with, only a couple of hundred thousand Kronor (£11,000: \$55,000) was promised as the proceeds of a lottery, to assist the building of the Stadium. When the architect altered his first plans (which were for a building to be placed on the Östermalm Athletic Grounds), so as to suit the new site at the Athletic Park, the rocky heights to the north, while the southern perspective of Sturegatan inspired the peculiar placing of the two towers of the now existing Stadium. The proposed timber Stadium and the necessary tracks would, it was estimated, cost about 400,000 Kr. (£22,000 \$110,000) and the building would be liable to destruction by fire and could hope for no long existence. But as only one drawing of the athletic lottery had been asked for, and as the Government

would not grant another, it seemed impossible to find the money for the erection of a more substantial edifice. The architect drew up an alternative plan for a stone building, however. The timber-Stadium project was laid before the member of the Government in charge of the matter, who was advised by the architect to confer with the Surveyor-General of Public Buildings. Mr. Möller, the Chief Intendant there, advised the erection of the stone construction, and said that the building of the Stadium in stone ought to be the condition for obtaining the grant of money from the State lottery. The Chief Surveyor's Office, at the same time, advised the Government to allow some additional lottery drawings, in order to obtain money for the proposed building. Architect Grut elaborated his plans for a Stadium of stone, while the Office, with the aid of the plans in question, drew up the details of the Government conditions for the grant of public money in aid of the project.

Meanwhile, negotiations went on between the Swedish Olympic Committee and the Athletic Park Company, and an agreement was at last come to, after several proposals for taking over the site had been made and rejected. The agreement, however, was only conditionally approved of by the directors of the Athletic Park, while the Swedish Olympic Committee was compelled to make the agreement in question in consequence of the limited means at its disposal obtained from the additional lottery-drawings granted by the Government. The Swedish Olympic Committee considered, therefore, that it ought to apply to the King-in-Council for permission to have another lottery-drawing in aid of the Games; the receipts from the said drawing would enable the Committee to construct first class athletic grounds, and thereby obtain some permanent results from the coming Olympic Games that were to be held in Stockholm, and, on these presuppositions, it was thought that a new agreement could be made with the Athletic Park Company.

The Swedish Olympic Committee having thus expressed its need of more money and having communicated with the Central Association, begging that its Committee would petition the King-in-Council to grant the lottery-drawing mentioned above, the Swedish Central Association for the Promotion of Athletics applied to the King-in-Council on the 14 February, 1910. The King-in-Council was pleased to permit an extra drawing, but thought it necessary to ask for guarantees, that the funds obtained by this additional drawing would prove sufficient for the purpose in question, and also demanded a second guarantee, to be given by the Central Association, providing against the failure of the first-named guarantee. This demand led to a guarantee being sent to the Minister for Public Worship and Education. It was dated the 20 April, 1910, and was signed by fourteen members of the Committee of the Central Association, all these persons, jointly and separately, giving a guarantee for the carrying out of the resolution of the Committee that "The assets (Kr. 98,000: £5,380:\$26,900) of the Central Association, placed as a guarantee in connection with a second, additional drawing in the Athletic Lottery, shall be available in their entirety when the accounts of the Olympic Games are closed".

The King-in-Council and the Surveyor General's Office also demanded that the greatest economy should be exercised, conformable with the claims made on the proposed Stadium building (not least on the part of the Surveyor General of Public Buildings), all of which necessitated very thorough investigations respecting building and other expenses, the number of seats to be provided in the building, etc.

The erection of the Stadium could now be begun, in accordance with a plan calculated to satisfy the wishes hitherto expressed for such a building as the one in question.

The plan of the Stockholm Stadium, as proposed by the athletic authorities, was the carefully chosen final result of most extensive preliminary investigations, and had been drafted with a special view to obtaining the best absolute and relative economical results possible, both for, and, more especially, *after*, the Fifth Olympiad. Careful attention was paid to the matter of the future cost of up-keep, while the dimensions of length, breadth and height of the permanent part of the building were carefully calculated, so as to get the most suitable use of the interior of the building for the purpose of rooms, offices, etc. The interests of the athletes, of the management and attendants, of the public, and of the necessary mess-arrangements, had all been considered. The composition as a whole was complete, yet simple, this unity and simplicity giving grandeur of effect with relatively simple means. It was made to accommodate itself to the natural features of the site, and was placed in proper accord with the points of the compass. The closed arena, towards the sun-illuminated hill to the north was bounded by two massive signal-towers, of which the east- or clock-tower now forms the background of Sturegatan. The many rows of grand stands forming a double horseshoe-shaped block, with the chief entrance in the middle of the south curve, rise proudly above the arena; the roof (rendered necessary by our northern climate), lends, at a slight cost, shade-effects and a majesty to the whole, which the low walls of the Stadium could not have conferred.

While the plans were being drawn up, a proposal had been made to reduce the expenses by the non-inclusion of the curves of the permanent Stadium; that is to say, of those parts containing the open arcade towards the gardens and which form the most decorative part of the whole building. This measure would have been synonymous with the ruin of the plan and the destruction of the artistic idea embodied in the building, for, after the close of the Games, there would have remained nothing but two ordinary, solitary, narrow stands and an enormous naked curve, from whence the beautiful trees once standing there would have been taken away for the sake of the temporary seats. It would then have been necessary to round off the rows of stands with costly pavilions at both ends, the expense of which would, to certain degree, neutralize the saving made, while the arcade towards the garden would have been lost. This proposed alteration, and some others, were rejected by the Committee of the Central Association, after consultation with the architect.

Estimates sent in by various firms, some making offers for parts of

the work and others for the work as a whole, showed that the cost of building would still be too great, and so a number of alterations and simplifications of the plan were made. Estimates were once more asked for, and, on the 2 November, 1910, the Committee of the Central Association determined to sign a preliminary agreement made with the chief contractor. The agreement of the 16 April, 1910, with the Athletic Park Company, which had opened the way to the procural of the Athletic Park for the Stadium buildings, was annulled during the process of the negotiations with the Government, and, on the 18 March, 1911, a fresh agreement was entered into between the Central Association and the Athletic Park Company, by which the Company made over to the Association all its rights to the site situated at Valhallavägen and Sturevägen, with all the buildings and appurtenances, all of which the Central Association, by the above-mentioned, cancelled agreement had taken over and utilized on the 1 October, 1910, when it began the erection of the Stadium in the Athletic Park.

The letting of the Stadium to the Swedish Olympic Committee for the purpose of being used for its first great purpose, the holding of the Olympic Games of Stockholm, was settled by an agreement made with the Central Association on the 27 March, 1911, where, among other things, the Association engaged to transfer the Stadium to the Swedish Olympic Committee, ready for use by the 25 May, 1912, if possible (this date was afterwards altered to the 1 June), while the Swedish Olympic Committee was to have the disposal of the Stadium, in order to hold the Olympic Games there and for other purposes in connection with the Games, until the 1 August, 1912 (this date being afterwards altered to the 10 August), all without the payment of any rent. The Swedish Olympic Committee was also granted permission to use the Stadium for a week, later on in the autumn, for the purpose of Football competitions in connection with the Games if this arrangement should prove necessary.

During the period when the Swedish Olympic Committee had the disposal of the Stadium, it was to be entitled to all the money received from the sale of tickets, programmes, picture-postcards and photographs, etc., and to all photographing-, cinema-photographing-, restaurant-, and other similar rights, and to the money obtained by means of advertisements, the letting of premises, etc. The Swedish Olympic Committee had, on the other hand, to pay all the expenses of the up-keep of the Stadium during the said period, such as those for the costs of management, telephones, telegraphs and the wages of the attendants.

The question of the care of the Stadium after the close of the Olympic Games has also been settled and the King-in-Council has graciously approved the proposal made by the Committee of the Central Association in a document dated the 20 December, 1910, of which we here give the principal paragraph:

“As regards the care of the Stadium after the close of the Olympic Games of 1912, it is proposed that the building, placed in the hands

of the Central Association, shall be so managed as to be accessible to the public at as low a figure as possible and, to a certain extent, free of charge for school-children; in addition to which, the Central Association engages to keep the building and grounds in the best order, the Association agreeing to see that what has been said above with regard to the employment of the building and its up-keep, shall also be observed even if the Stadium should be let for a time to the Athletic Park Company."

THE BUILDING COMMITTEE.

Several persons, of whom Mr. Grut, the architect, and Colonel V. G. Balck were not the least active, had, for about a year, been making preparations for the proposed Stadium, and they afterwards entered the Committee chosen by the Committee of the Central Association from amongst its own members. This Building Committee was as follows:

Captain K. AMUNDSON,
Colonel V. G. BALCK,
Captain, Count CARL BONDE,
B. BURMAN, Esq.,
S. EDSTRÖM, Esq.,
Captain, Baron C. SILFVERSPARRE,
T. GRUT, Esq., architect; adjoined member.

The Committee was formed on the 19 July, 1910 with with the title of "the Stadium Building Committee", Colonel Balck being President, B. Burman, Esq., Vice-President, and Alex. Lindman, Esq., Secretary-Treasurer. On the same occasion an Executive Committee was nominated, consisting of Messrs. Burman, (President), Amundson and Grut. On the 22 November, Mr. Edström entered the Executive Committee, while the Building Committee, on the 20 July, 1911, added Colonel, Baron S. Hermelin to its numbers (this gentleman soon afterwards became a member of the Executive Committee) and, on the 3 June, 1912, Charles Dickson, Esq., was asked to join its ranks. After the close of the Games, Dr. A. Levin was also elected a member of the Building Committee.

Mr. Burman was empowered (on the 16 January, 1911) to take over the funds for the building of the Stadium, and to disburse them in accordance with the contracts, and (on the 21 August, 1911), when the work began to be hurried on, to make agreements for current business, but was to report the same at the following meeting. Baron Hermelin was also empowered (23 January, 1912), together with Mr. Grut, the architect, to superintend the outdoor work on the gardens of the Stadium.

On the 10, June, 1912, an application was made to the Building Committee by the Swedish Olympic Committee, asking the former to continue to act as a sub-committee, a wish which the Building Committee had no difficulty in complying with, for even now, at the date of writing, it has not yet been dissolved although, on the 17 October, 1912, the Building Committee informed the Swedish Olympic Committee that its labours were so near completion, that it could be dissolved

in the near future. It was determined, however, that the Committee should not be dissolved, in consequence of the supplementary work that would still remain after the Games, and for the completion of which it would be necessary to engage contractors.

The Control Officials and Experts.

Torben Grut, Esq., was the chief architect and leader of the works.

Henrik Kreuger, Esq., C. E., was engaged on the 2 November, 1910, as control-official of the materials. Amongst other things, he was responsible for the concrete and foundation constructions.

Emil Lindkvist, Esq., was engaged on the 6 February, 1911, as control official, and on the 5 February, 1912, his engagement was extended for a time, in connection with the work on the entrances and lavatories.

A. Lindegren, Esq., acted as the control official representing the Office of the Surveyor General, his fees being paid by the Central Association.

O. Björilin, Esq., was engaged specially for the arrangement of the turf-laid arena and the running tracks, and continued his labours for some time after the close of the Games. In addition to Mr. Björilin's assistance, the help was obtained of Mr. Charles Perry, from the Stamford Bridge Grounds, London, as expert in the construction of running tracks. He was engaged at the Stadium for a month during the autumn of 1911, to attend to the laying of the surface composition on the track. Just before the Games began, Mr. Perry came again to inspect the tracks once more.

Mr. E. Cederpalm was specially appointed to superintend the work of laying out the gardens, the planning of which was in the hands of Mr. Grut, the architect.

The other principal control officials were: Mr. Wm. Andersson, C. E. (for the piping) and Mr. W. Dahlgren, C. E., (for the heating arrangements), and in addition, help was obtained from the Electric Testing Institute, and from Messrs Nilson and Svensson, Engineers.

In addition to those mentioned above, one or two other experts were employed for special purposes, and will be mentioned in the sections dealing with the various parts of the work.

*

The labours of the Building Committee have been multifarious, the details being given in the 73 minutes of the same number of meetings, the greater number of which have been held at the offices of the Central Association, although some took place at the Stadium, when detailed inspection of the works took place in connection with a meeting, or when technical questions were to be discussed which had to be decided at the Stadium itself.

The Building Site.

The site of the Stadium is, by nature, ancient bog-land, bounded to the north-east by a rocky height and, to the south, by a grove of silver birches and oaks growing on a moraine formation of sand and clay. On the north-west it runs up to Sofiavägen and has exactly

the length and breadth suitable for its purpose. The size of the Stadium was determined by the length and breadth of the football-ground, plus the breadth of the running track around the latter, that of the amphitheatre of strands, and of the walk outside. It was found possible to pre-

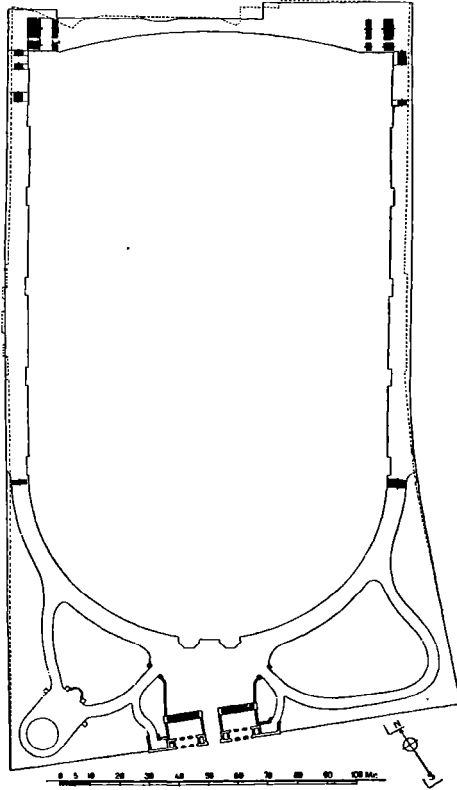

Plan of the Stadium boundaries (continuous line) and those of the old Athletic Park (dotted line).
Scale in metres.

serve and embellish the natural garden at the southern end, while, at the north, the rocky height has been employed in the composition of the building so as to form a series of terraces, affording standing room for spectators. The site covered by the Stadium is, with a few unimportant differences as regards the line of the fence, that of the old Athletic Park.

Some of the buildings formerly existing on the site of the Athletic Park were sold, but the largest of them, the Tennis Pavilion, was moved to the Östermalm Athletic Grounds, where it afterwards proved very serviceable during the Olympic Lawn Tennis out-of-door competitions and the Fencing Competitions.

The Contractors' Work.

Mr. Grut's, the architect's, plans for the main building were accepted by the Building Committee on the 2 November, 1910, and by the Office of the Surveyor General on

the 28 November of the same year. Tenders were advertised for, one for the construction of the main building, to be sent in not later than the 1 October, 1910, and one for the foundations, to be sent in not later than the 7 October of the same year. On the 4 November, 1910, a contract was signed between the Committee and Messrs. Kreuger and Toll, for the construction of the Stadium, the estimated cost being Kronor 508,450 (£28,000:\$140,000) and embracing, not only the foundation work and the superstructure but also the supply of granite and hand-made facade-bricks — originally omitted from the contract — for the delivery of which a special agreement had been made by the Building Committee with Mr. E. Hebbel (representing Carl J. Schylander's Granite Co., of Oscarshamn) for the granite, and with the Helsingborg Steam Brickmaking Co., for bricks. This latter part

of the agreement was for 400,000 hand-made bricks, at a cost of Kr. 40,000 (£2,200:\$11,000), a very reasonable price, indeed. It may be mentioned here that, as far as is known, every bit of the Stadium is constructed of materials procured in Sweden.

An addition to the contract was signed on the 11 October 1911, when the Building Committee accepted Messrs. Kreuger & Toll's offer to put in order the not inconsiderable space of ground lying between the south, chief entry and Valhallavägen, at a total cost of Kr. 10,000 (£550 : \$2,750). The question of the manner in which this entrance should be arranged was a very delicate one, partly on account of its position, and also because it was quite uncertain whether the Committee would ever have at its disposal the funds necessary for the construction of the entry, in a line with the roadway, for which the architect had repeatedly made plans.



One of the gates at Sofrivägen Road.

As a matter of fact, the work embraced by the erection of the main building finally cost more than the original estimate of Kronor 508,450, as the granite and its placing in position came to Kr. 9,546: 88 (£524 : \$2,620) more than the original plans showed, in addition to which, extra facade-bricks came to Kr. 22,542 : (£1,235 : \$6,175) more than the estimates.

The basements beneath the flanking buildings also caused a lot of extra expense, in consequence of the present boggy condition of nearly the whole subsoil of the Stadium, a state which will continue to exist until the drains and sewers of Sturevägen are in better order.

The work of erection began on the 23 November 1910, when the first spade was turned. The following list may be given of the dates when the principal sections of the work were begun:

The digging of the foundations began on the 23 November, 1910

» casting » » concrete founda-	»	»	»	3 December,	»
» setting of the socles	»	»	»	9 January,	1911
» bricklaying	»	»	»	6 April,	»
» casting of the concrete girders	»	»	»	11 May,	»

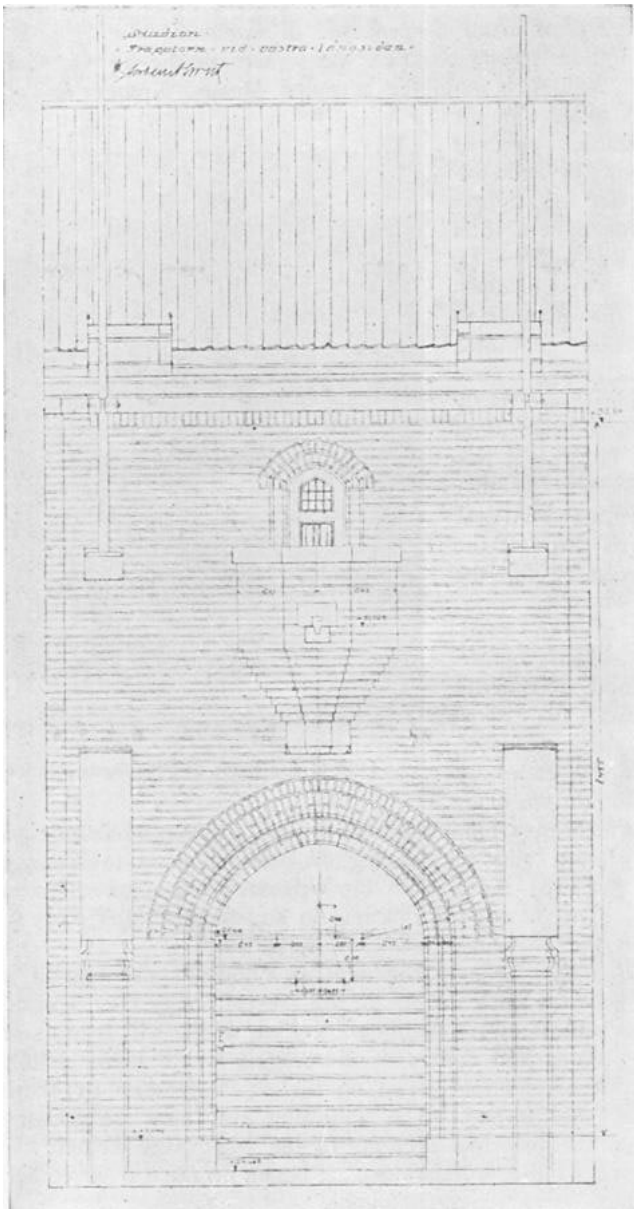

Elevation of one of the side entrances.

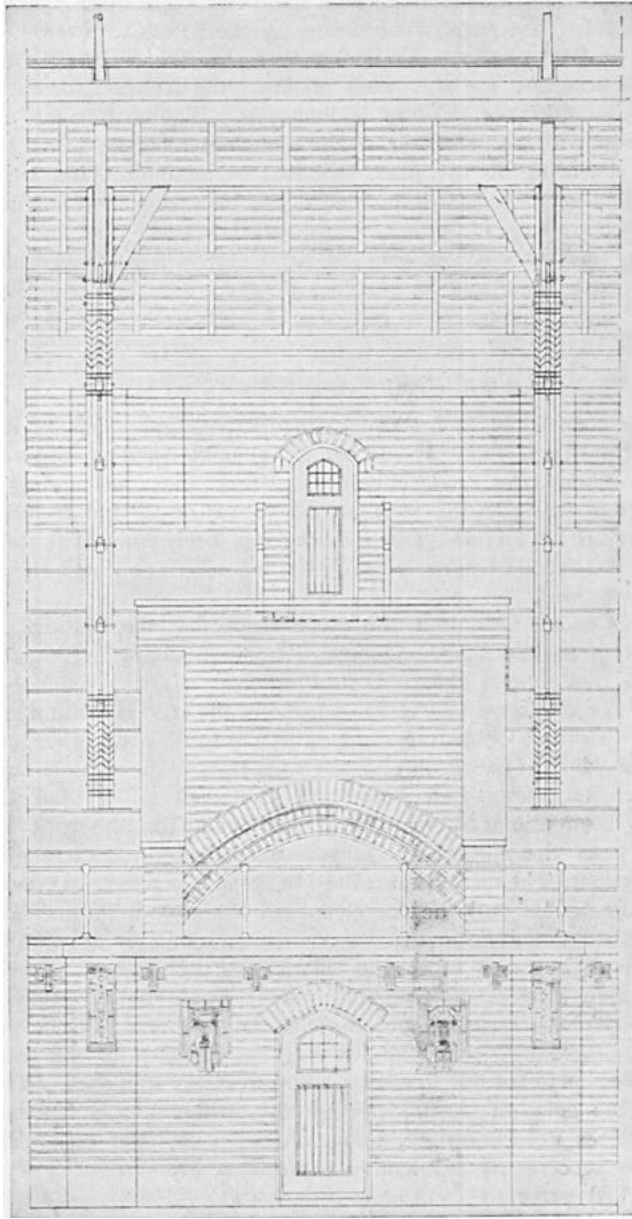

A side entrance, seen from within.

The raising of the couples began on the 5 July, 1911
» tiling..... » » » 20 August, »

The City of Stockholm advanced a sum of Kr. 50,000 (£2,750:\$13,750) as a loan for the purpose of arranging the entrance towards Valhallavägen, and thus, at the beginning of 1912, the Building Committee was able to carry out the plans made by the architect for the erection of a grand entrance of durable materials. The matter was taken in connection with the erection at the same time of the other buildings which, according to the plan, still had to be built there, so that, in its entirety, it embraced the entrances towards Valhallavägen Road, another entrance, of timber, at the north-western side and a corresponding building of wood on the north-east. On the 5 February, four tenders had been sent in, varying between Kr. 33,250 (£ 1,820: \$ 9,100) and Kr. 19,800 (£ 1,085 : \$ 5,425), the last of which (E. Lindqvist's), was accepted.

THE ARCHITECTURE OF THE STADIUM.

The Stadium is a modern, constructive application of mediæval brick-architecture, such as occurs in ancient Swedish city-walls, fortresses, monasteries and churches. Every part has sprung organically from its intended use; no extraneous *motif*-architecture being anywhere to be found. The building has been composed simply and plainly, just as a boat or a bridge is, but with nobility in the material and proportions.

The following notes may be given respecting the material and construction of the Stadium buildings. The foundations are of concrete; in parts, reinforced. The rock subsoil forms a considerable basin-like depression right across the median portion of the grounds, with a maximum depth of 11 met. below the surface. At the south-east corner and along nearly the whole of the north end, the rock rises to the surface. Originally, the architect intended to construct the shell of the building with concrete foundation-columns resting everywhere on the rock and connected near the surface by means of reinforced concrete girders in two directions. The sections measured between 4—5 met. In consequence of the short time and the limited means available it became necessary, however, to obtain estimates for the construction of a beton-sole beneath the lighter part of the building along the sides. It proved that a considerable amount of time and money would be saved by a combination of both systems, and the foundations were laid in this manner, in accordance with the varying depth down to the rock. All the higher parts of the building rest direct on the rock. The pressure of the sole on the underlying clay, where a sole has been employed, does not exceed $\frac{1}{2}$ kilogr. (circa 1 lb.) per cm.². The clay has been successively test-loaded to resist a pressure of 4—7 kilogr. (9—16 lbs) per cm.²

The socle consists of rough-hewn red granite. That of the south gateway is of rubble stone.

The wall everywhere consists of large-sized, ordinary Swedish (lake Mälars) brick with 1,2 cm. joints. Large Halsingborg, grey-violet hand-

made bricks have been employed for the facades. In consequence of the longer burning to which it is exposed, this brick is somewhat smaller than the other, so that, in accordance with the wish of the architect, the joints in the facades are circa 2 cm. The joints were scraped with wooden pins about half an hour after the bricks were laid. When the outer mortar had hardened it was washed off with a weak solution of hydro-chloric acid (1 : 4), without brushing. The architect has taken special pains to prevent any loose-burned or

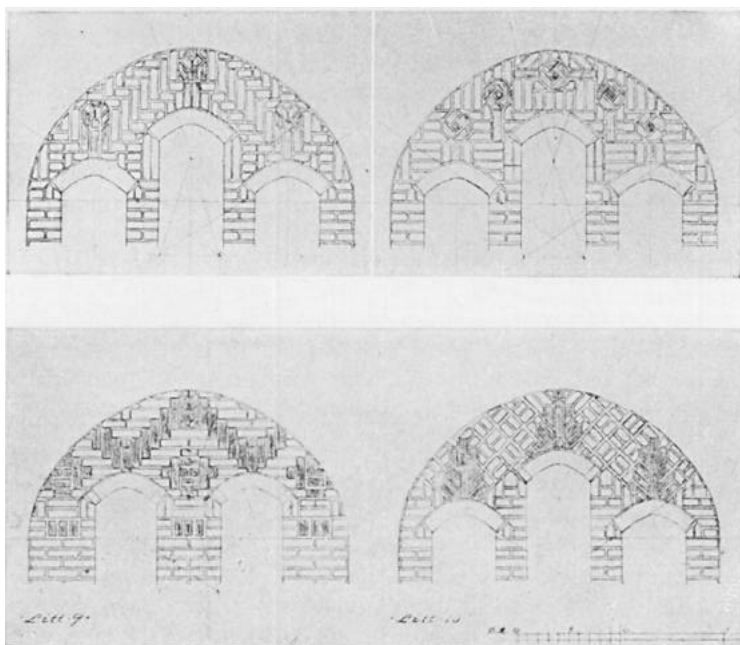

Some of the brickwork patterns.

yellow brick coming amongst the material used. The hardest-burned bricks were chosen for the pattern-work, occurring here and there, and which is of suitably varying designs.

The inner wall-surfaces of the building have, for the most part, only been rough-plastered. It is surprising what an amount of money has been saved by this process and how the general appearance of the interior was improved by the process. The same method has been adopted with the Roman vaults of the arcades. All the vaulting has been constructed in the good, old-fashioned manner by free hand. Vitriol has been mixed with the plaster so as to make the mixture stronger, while it afterwards creates decorative green patches on the surface.

The under-flooring of the amphitheatre is constructed of reinforced concrete. Where the span is 5 met. or more, girders of reinforced concrete have been used, with cells of reinforced concrete between. Where the span is about 4 met. or less, reinforced hollow-brick vaults, with-

out any concrete girders, have proved to be cheaper, and have, therefore, been employed. On being test-loaded, the under-flooring proved to be considerably stronger than was necessary. No casting was allowed when frosty weather prevailed.

The under-floorings have been insulated by means of asphalt. All mural crowns have been covered with granite with good dripstones.

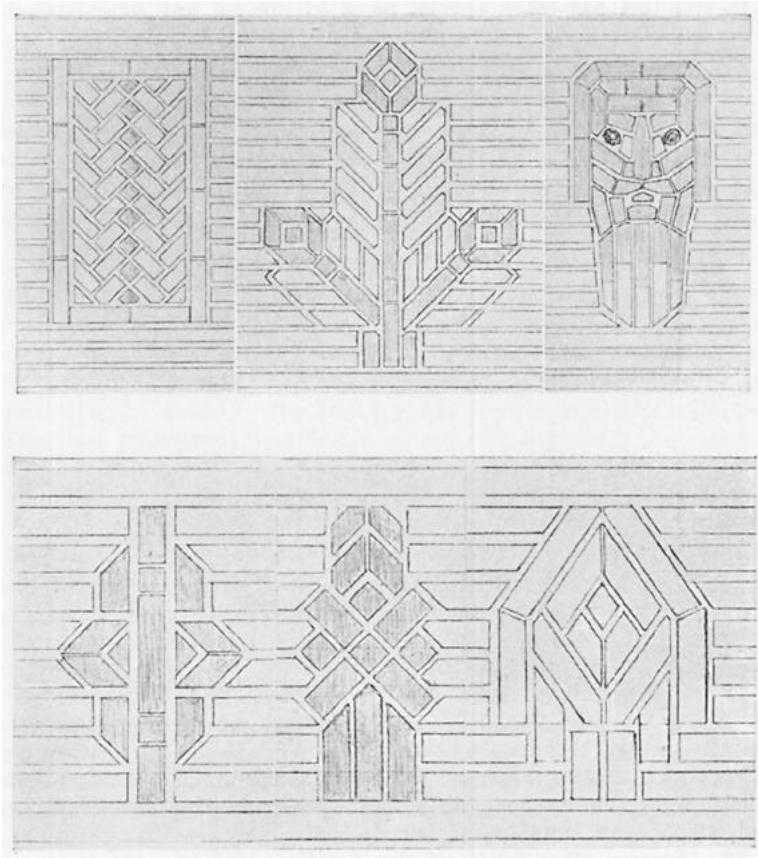

Some of the brickwork patterns.

All terrace- and balcony-constructions have been provided with socles of thick asphalt reinforced with wire-net 30—40 cm. high. All detached brick-work parapets have been dressed on the inner side and it is the intention to treat the dressing with Kessler's fluat. This will make the back of the parapet waterproof, and the parapet, consequently, equal to an ordinary one of twice the thickness. All the naked flooring of the balconies slope very steeply, so as to allow water to run off quickly.

All the timber work visible has been coated with transparent colour; the masts supporting the roof with vandyke-brown; the doors and

other woodwork with vandyke-brown and black. Where the panel work of the exterior has to harmonize with the brickwork, as was the case on the north temporary stand, it received a coating of *caput mortuum*. All window-posts have been painted with grey oil-colour of the same tint as that of the brickwork joint.

Large blocks of granite are sunk into the wall along the facades; it is the intention to transform these, later on, into sculptured figures. There are 30 such blocks along the south arcade; 2 at the south gateway; 8 on each side of the main building; 2 on the central arch of the north arcade and 2 on the east tower beneath the clock. In accordance with the architect's designs, these last-named blocks have been sculptured into figures representing Ask and Embla (the first pair of human beings mentioned in Northern mythology). In the socles of the great towers there are fountains, in the form of walrus-heads, designed by the architect.

The granite blocks of the facades have binding-stones and dripstones. The cloven surface harmonizes very well with the brick. Tore Strindberg has made fine sketches for the blocks of the south gateway. Of the gateway-blocks on each side of the building, Mr. Eldh proposed to make figures representative of the various nations of the world, in athletic attire, several of the sketches being already completed. Eldh and Christian Eriksson have made excellent sketches for the nude human figures for the south arcade. Another series of 15 blocks is reserved, at present, for Milles. The cubical blocks, of 40 cm. edge, crowning the lisener along the sides of the building, are intended to be hewn into grotesque heads. Gunnar Hallström has made fine sketches for the two big blocks of stone on the middle arch of the north arcade. On each side of the south gateway there are granite-surfaces for relief sculpture.

Granite monoliths, 4 met. high, symbolizing the four winds, are to be placed in the arena at the corners of the football ground.

A granite column stands in every second arch of the southern arcade, intended for a figure in bronze, three-quarter life-size. It is the intention that the 16 statues required shall be the future work of Swedish sculptors, thus offering a field of labour for young Swedish artists. 8 large granite plinths, now overgrown with roses, stand in the park near the entrance to the building. They are also intended to support groups of sculpture. — The Stadium will thus afford great and monumental tasks for our sculptors. It may seem bold of the architect to leave so much to coming years, but he considers the future mission of the Stadium to be such that public interest will always be attached to it. He has desired to avoid cheap sculptural decorations on the walls of the Stadium, for which only the best is good enough. Each adornment must be a perfect work of art, and so it is better to wait, than to take at once mediocre productions. The worst thing that could happen to the Stadium, in the opinion of the architect, would be if a committee for the sculptural decoration of the building were appointed, and plenty of money suddenly became available for the purpose. He has fixed the lines on which it

is to grow, and has merely set limits to the sculptural style of its adornment by the form given to each granite block. The rest should be natural development.

Mr. Grut writes as follows in "*Konst*" ("Art") with respect to the sculptural decoration of the Stadium:

"I shall here try to express to the interested reader the intention of the architect respecting the 30 blocks of granite on the south arcade.

I wish to emphasize that this arcade, together with the little park of oaks and birches, is to be the favourite resting place of the public. I therefore wish to have it *richly* adorned with monumental sculpture. This is a *tranquil interior* — not a cold exterior. Here shall be an open air temple of Swedish granite sculpture, the very finest that we can produce. Severe and warlike rises the remainder of the northern Stadium. But in this little park, the sunshine playing through the crowns of oaks in mystic clare-obscure, a vision shall be given of *Man* — of strength and beauty, carried monumentally on the lisener of the sturdy walls. Fifteen are the blocks of granite on the eastern half of the arcade, and equally many those on the western. I have imagined every second block, or eight on each side, to be hewn into titanic, naked figures of men, and every second one, or seven on each side, into naked figures of women. I imagine the titans, eyes closed, every muscle alert, contemplative, the unceasing, searching quest of human soul embodied. I imagine the women lightsome, with clear, sun-filled eyes; the redeeming affirmatives of life's deep secret. The dew of creation's first rejoicing morning shall glisten in their hair, and every line, every curve of their bodies shall sing of life's sweet blessings. All these figures shall, by the limitations of the granite blocks, be forced into a monumental style. But the ever-changing movements of their limbs — as in a dance suddenly arrested, suddenly eternized in stone — the sunlight reflected from lithe forms, from mighty shoulders and loins, from each tender, maiden bosom, each strained muscle of the titans — shall give to this temple gallery of the grove, perfect expression of the microcosmos of the human body. Silent and calm lie the brooding horizontals of the Stadium. No unnecessary "architecture" disturbs the feeling as of moaning pine forests. But here, in the hallowed grove of oak and birch, in Sweden's temple to Man, there shall dwell the full and entire expression of our worship of strength and beauty. Here is, artistically, the *interior* of the Stadium. Here is the home of *peace*. Inside the building, in the arena, live noble rivalry, song, the stage, jousting, warlike *strife*. Little space is there for contemplation, for sculpture in any form. There the arena itself is the central figure; flags and horn-signals its array. Within the Stadium, our growing generations shall be fostered to feats of strength and manly courage. In the roof-free temple of the grove, they shall be fostered to purity and worship of beauty.

TORBEN GRUT."

There is a wrought-iron fence running all round the Stadium grounds. This is a necessity, as the public walks in the gardens have been placed outside the walls in order to gain concentration of the interior. The clock-dial on the east tower and the metal work of the beacons on the summits of both towers are also of wrought-iron. These beacons are intended for use occasionally during the year, when great festivals

are celebrated at the Stadium. Liquid fuel may be employed, but iron cressets of mediæval form are to be placed in the fire-pans. In some years, it is to be hoped, the new buildings of the Gymnastic High School will complete the perspective from the interior. There will then exist behind the north arcade an avenue of pyramidal elms, and behind this, again, the central court-yard of the High School.

The public entrances to the Stadium are arranged in 5 groups as follows. At the south end, at Valhallavägen, we have the principal entrance to the gardens and to the south entrance of the Stadium, consisting of two arched buildings, with four turnstiles in each and with three exits wide enough for carriage traffic. On the east and west sides there are four entrances with gates and turnstiles, while, finally, there are entrances at the north-east and north-west corners, each with four turnstiles, and one exit. The different sections thus formed of the outer promenade are separated from each other by means of iron fences provided with gates, so as to prevent visitors from passing improperly from one section to the other. Admittance to the amphitheatre stands can be had only from the outer promenade, up arched staircases opening into the centres of the various sections. There are 12 such staircases.

The staircase openings along the sides of the building are marked by tower-shaped masses, between which the outer facade is articulated by means of the weight-carrying pillars of the wall which are marked by pilasters. Between these are shown the constructive blind arches which carry the pressure to the weight-carrying pillars. The windows are arranged in the wall spaces within the blind arches; the non-supporting parts of the walls have decorative designs in brickwork. The traverses have a span of about 5 metres, a distance which is retained uniformly round the whole building. The copings of the entrances are marked by balconies for standards and by flag-poles, the latter of which are of two kinds, the vertical ones for the flags of the nations, and the horizontal ones for flags showing the numbers of the various sections.

THE GRAND STANDS AND STANDING PLACES.

The "permanent Stadium" — the outer, monumental, oval building, really contains no more than about 7,500 seats, in addition to which there is room for a larger or smaller number of spectators on the slope below the north arcade, while spectators can be accommodated on the turf slope and walk which, in the *plan proper* of the Stadium, exist between the amphitheatrical building and the central arena. By providing the greatest possible space for standing-room, it was calculated that the Stadium would contain about 32,000 spectators. This figure, however, was considered by the Building Committee as unnecessarily high, and the Committee also preferred to have as much sitting-room in the Stadium as possible.

The number of seats in the amphitheatre was increased by the direct continuation of the permanent stands down to the ground by means of temporary stands of timber, where the seats, and other arrangements were the same as those in the ordinary stands, and

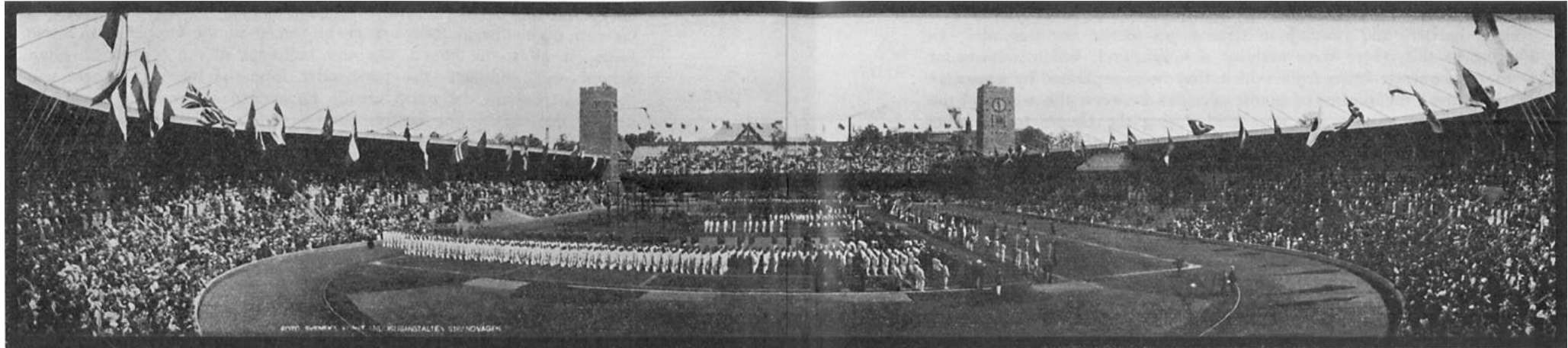

View of the interior of the Stadium. Scene at the Solemn Opening of the Games.

accommodated as many spectators as these upper places. This caused an expenditure of c:a Kr. 42,000 (£ 2,300: \$ 11,500), of which the painting came to c:a Kr. 7,000 (£ 380: \$ 1,900).

A large space in the centre of the grand stand, just below the Royal box, was turned into boxes seating 4, 6, 8 or 10 persons, the seats here and in the Royal box being made somewhat ampler than the ordinary ones. All the seats in the Stadium are larger, however, than those in other, similar buildings, as is proved by the appended comparative list, where the measures are given in centimetres:

Ordinary seats:	Stockholm	Stamford Bridge London	Syracuse U. S. A.
Gangways	71	64	69
seat (width)	25—27	23	
» (breadth)	45—50	42	
Boxes:			
Gangways	90	64	69
Seat, with back (width) ..	35	27	
» (breadth)	60	50 ¹ / ₂	

Special arrangements were made for the representatives of the Press in a large section of the east stand nearest to the tower, and in a section of the upper temporary north stand, close to the same building. The seats, to a total of 500, were all provided with writing desks.

The entire upper, permanent part of the amphitheatre was protected against rain by a tiled roof which also afforded some shelter from the sun, but a proposal to protect the eastern side of the building — which was that most, and somewhat unpleasantly, exposed to the rays of the midday- and afternoon sun — by means of an awning, could not be adopted on account of the expense it would have involved.

As it was considered that space had to be provided for at least 20,000, or, preferably, 25,000 spectators — there was much specu-

lation in the daily papers as to the number really necessary — the idea arose of erecting an additional, temporary stand above the north arcade, and alternative plans were laid before the Building Committee, as early as the 4 Sept. 1911 providing a) for 6,000 persons at a cost of Kr. 24,500 (£ 1,350 : \$ 6,750), b) 4,000 persons, at a cost of Kr. 15,000 (£ 824 : \$ 4,120), and c) for 2,000 persons. All this was for standing room only, but this proposal awakened much opposition, especially on the part of the police authorities, who insisted on seats, on account of the great height of the stand. Alternative a) showed, on re-calculation, that the 6,000 standing places would not allow of more than 3,500 seats for spectators. The stand was built later on and seated 3,050 spectators. It was inspected and passed on the 22 May 1912.

The contract cost of the erection of this provisional timber stand, was Kr= 37,457: 50 (£ 2,065 : \$ 10,325), of which the painting cost Kr. 3,650 (£ 200 : \$ 1,000), but these figures were afterwards increased. This stand paid very well, however, for it afforded a very good view of the arena and was much favoured by the public, and when full, presented quite a decorative appearance. Entrance was obtained from the east and west gates in the north grounds behind the Stadium.

The seats on the stands were divided into groups by means of painted lines and cross-bars, and were numbered; the rows of benches, too, were numbered, and this, together with the large lettered flags hanging above the entrances to the staircases, made it easy for visitors to find their sections and their places. The various sections in the permanent building were separated from each other by barriers of iron, and of wood in the temporary stands; this was done by order of the police authorities, who also required hand-rails to be erected by the sides of, and between, the staircases in the amphitheatre.

Places for spectators were arranged on the north slope. Some

of these afforded standing room only, on terraces provided with wooden barriers and running in terraces up to the north arcade. In addition to this, there were seats at a lower level, which went as far as to the concrete-fence, from which they were separated by a passage which formed the means of communication between the west and the east entrances. No tickets were sold during the Games to the seats on this, north slope, as only athletes, gymnasts and officials were allowed entrance there and to the connecting passage. On going to or from the rooms below the amphitheatre or in the flank-buildings, the gates in the west and east entrances had to be passed, and attendants were

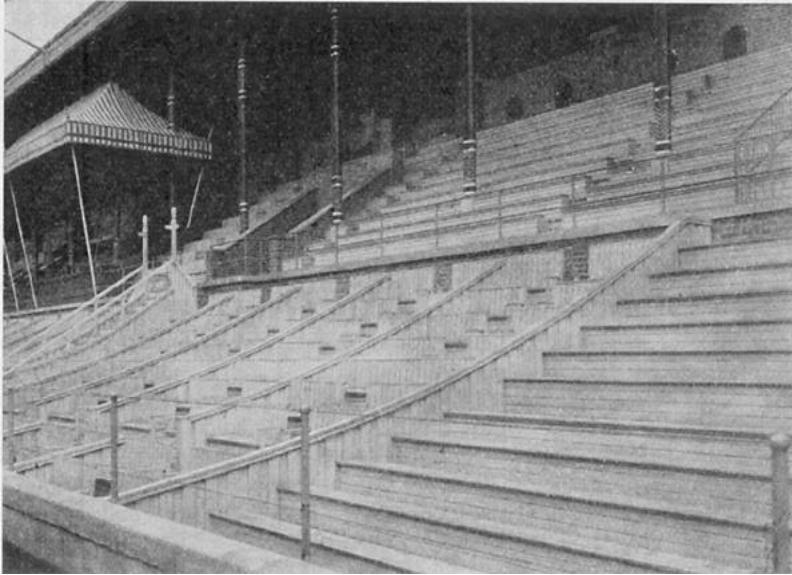

Benches in the east amphitheatre, in front-of, and next to, the Royal box, arranged as private boxes.

constantly stationed there. The total number of seats for the athletes and officials was 2,000 which, it was calculated, ought to be sufficient for the number of competitor-spectators present at one and the same time. About 3,000 persons could be admitted to the standing-room places. This space for the spectators remains, on the whole, as it was during the Games.

Altogether, the Stadium accommodated 22,000 spectators, but 3,050 places disappeared when the temporary north stand was removed after the Games.

The Royal box was placed in the centre of the east side, with a fine view of the entire Stadium, and in the immediate neighbourhood of the finish of the races, this spot being between the Royal box and the north-eastern archway forming the chief entry for the athletes, with entrances to all their corridors, offices and other rooms.

In that part of the stands assigned to the Royal box, and behind the first row of seats (in the middle of which there are cushioned chairs), there are box-seats for, altogether, 80 persons. The blue cloth-covering of the barrier and the yellow-striped canopy, make the Royal box easily distinguishable in the centre of the east grand stand. Heavy draperies, hung across the staircase, protect the occupants from drafts.

The Royal foyer, which lies to the right on entering the building from Sturevägen, is comfortably, rather than luxuriously, furnished and decorated. Varnished black oak doors, with yellow-metal mounts, lead to the promenade between the walls and the fence, which is decorated with beds of flowers lying close to the walls.

THE INTERIOR PREMISES.

The competitors' dressing-rooms.

Beneath the stands forming the amphitheatre-buildings, there are a number of large rooms running along the outer side, with a long passage on the side nearest to the arena. The rooms open on to the passage. The dressing-rooms are provided with a varying number of shower-baths, and two of them have two large baths. There is also a lavatory attached to each room. The dressing rooms also contain at least two wash-hand stands, with a warm-water supply. The larger rooms are furnished with tables, stools, looking glasses, a number of clothes-brushes, and massage-benches of a special construction. There are 26 of these massage-benches, each costing about Kr. 30 (33/— : \$ 8). The iron wardrobes were ordered from Swedish contractors at a price of Kr. 19 (21/6 : \$ 5.25) each; but, later on, this price was considerably reduced. Each wardrobe is intended to hold two suits of clothes, and measures 30 cm. in depth, 45 cm. in width and 190 cm. greatest height, and has a sloping top, this last measure being adopted to prevent the accumulation there of all manner of odds and ends. No less than 650 such wardrobes were bought and distributed among the dressing-rooms, according to the number of athletes for whom the various room were intended. After being placed in position, the cupboards were numbered and provided with locks, no two of which were alike.

These 12 rooms were divided between the teams of the different nations, the names of these nations being placed on notice-boards, not only in the passage close to each room, but also at the entrances to the east and west corridors. This division was made in accordance with the plan shown on page 192.

The rooms are provided with central-heating apparatus, with large numbers of heating units in each room. This provision was not made until long after the Games, but the measure had been discussed by the Building Committee in March, 1912 and it was thoroughly gone into before being carried out.

All the dressing-rooms were provided with alarm-bells connected with the leaders' tribune in the arena, and the Stockholm Telephone Company put up a large number of telephones in the passages outside. Every room was provided with clocks in electric communi-

cation with the Normal-Time Company's Office. Electric lighting was employed on a large scale.

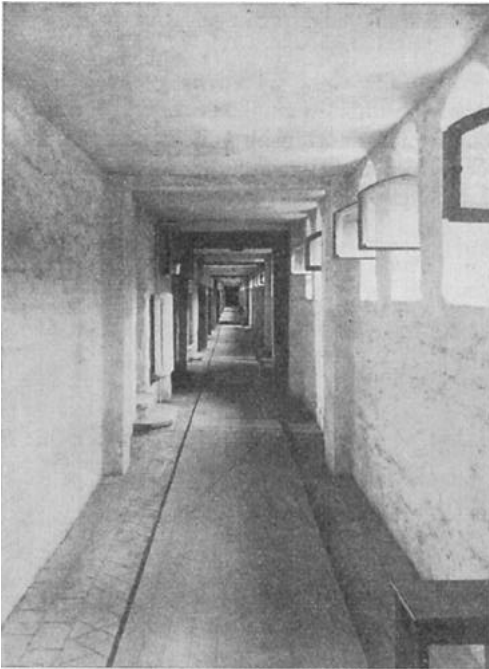

The corridor in the east amphitheatre, seen from the entrance-archway.

OFFICES OF VARIOUS KINDS.

As was already mentioned, one of the rooms beneath the amphitheatre was set aside as the Press-foyer and another for the medical attendants; this apartment, which was near the north west entrance, being very fully equipped under the superintendence of an expert. — The rooms nearest the south entrance were employed that to the east, as store-rooms for athletic apparatus, and that to the west as a cashier's office. The smaller rooms on the floor above these were

turned into dark-rooms for photographers and cinema-officials. Another room in the south tower was reserved for the attendants.

The corner buildings in the north were used for various purposes. In the east building, the first room entered to the right was the Olympic Committee's Office, with the President's room beyond; the rooms on the first floor were used, some as telegraph offices, and one, especially, as a kind of ante-room for the Press, leading to the Press-stand on the east stand; the second floor was reserved for the finance-officials and the international juries; on the third floor there were rooms provided with telephones in closed boxes, and intended for the Press (a staircase led from these rooms to the Press division of the provisional north stand). The tower-rooms on the fourth and fifth floors were committee rooms; the rooms on the sixth and seventh floors and the balcony room on the seventh floor were reserved for divers purposes. On the first and second floors of the western tower there was a mess room and a kitchen for the athletes, and an ante-room to that part of the west stand reserved for the officials. The third and fourth floors were reserved for the many competitors in wrestling; the orderlies had the tower room on the fourth floor,

the boy-scouts had the rooms on the fifth and sixth floors, while the room on the seventh floor was kept in reserve.

The Refreshment Department.

Flat red tiles were used to cover the floor of the open colonnade of the south arcade. The kitchens, etc., were fitted up by the refreshment contractor with bars and cupboards (which were afterwards purchased by the Central Association), and were provided with gas cooking ranges.

In the lower part of the gardens at the entrance, the taverner erected a temporary refreshment-stall, a soda-bar, the design of which was drawn by Mr. Grut, the architect.

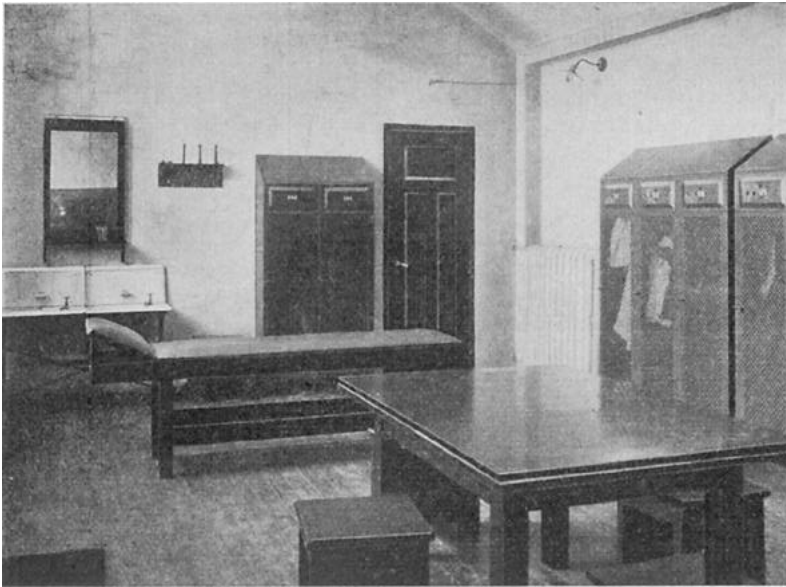

A dressing-room and its furniture.

THE ARENA, TRACKS AND GARDENS.

In order to prevent the competitors and officials crossing the track on their way to the arena and thus hindering the runners, a tunnel was constructed, beginning on the north-east outer side of the concrete wall and leading into the arena a few metres from the edge of the turf. The entrance to the tunnel on this side was protected by an iron fence. When the horse riding competitions were being held, the fence was removed and the opening covered temporarily with wooden boards; after the conclusion of the Games it was filled up, and the opening in the wall closed with concrete, but this has been done in such a way that the tunnel can easily be opened and used

again. The cost of the tunnel was three times as great as that first calculated, the original sum amounting to Kr. 2,380 (£ 130 : \$ 650).

Quite a network of electric wires for telephoning- and time-taking purposes, lies beneath the surface of the arena.

The circumference of the track is now 384.10 met.; its breadth on the east side of the arena is 10.5 met. and, on the west, 7.5 metres. The finish of most of the races is at the north end of the east side of the track.

The plan of the Stadium arena was approved of by the King-in-Council, but before being sent in to His Majesty it was submitted to the inspection and approval of the technical representatives of the Swedish Olympic Committee, and was exhibited in the Committee's rooms. It also received the approval of the English track expert, who had himself fixed the varying breadth of the track as being that most suitable for the Stadium.

The space within the running-track was laid with turf, the expense of which was at first estimated as being no greater than the cost of a sand-covered ground, but the final cost gradually came to far exceed the estimates, in proportion as the work of laying down the turf proceeded. The same was the case with the cost of the running track, one reason of the increased expense here being the blasting operations that had to be carried out in the rocky subsoil at the south-east corner. A far greater source of extra expense, however, was the frost, which hindered building operations in no slight degree. The earliest estimates for the turf-laid arena and the running track are entered in the minutes of the 20 November, 1911 as amounting to Kr. 30,565.56 (£ 1,680 : \$ 8,400), the running track alone costing Kr. 7,800 (£ 425 : \$ 2,125), this last figure, it was estimated, would finally reach Kr. 15,000—20,000 (£ 825—1,100 : \$ 492—5,500). On January 23, 1912, the minutes state that the running track, together with the jumping pitches and the like, had cost Kr. 36,000 (£ 1,980 : \$ 9,900) and were calculated to come to Kr. 40,000—41,000 (£ 2,200—2,255 : \$ 11,000—11,275). It is impossible to state exactly what the tracks and the arena really did cost, as the same workmen, and part of the same materials, were also employed for work in the gardens, the constructions of paths, etc., and in the Östermalm Athletic Grounds too.

Mr. Charles Perry, who is employed as track-expert at Stamford Bridge, London, was engaged in the same capacity for the Stockholm Stadium. He arrived on the 23 Oct., 1911 and remained till December, and made a final visit of inspection immediately before the Games began. The tracks, etc. were inspected by the Swedish Olympic Committee, whose technical sub-committee was represented by N. Thisell, Esq., and Lieutenant G. Uggla, who were appointed for the purpose in September, 1911.

The work on the arena was directed by Colonel, Baron S. Hermelin, who, on the 20 July, 1911 was appointed by the Building Committee to superintend the turfing of the central parts of the grounds. The task was a difficult one, but Baron Hermelin proved equal to it, and did yeoman service for the Stadium in this matter, His chief assistant during the whole of the time was Otto Bjorlin, Esq.

The Stadium was first used by our athletes as early as the 23 April, 1912, in consequence of the wish they expressed to be allowed to practise on the running track. As the Building Committee considered it desirable that the track should be put to a practical test, and considered that the path would probably benefit by being used, and as Kreuger & Toll & Co., the contractors, declared that this would not interfere with the work in hand, nor necessitate any alteration in

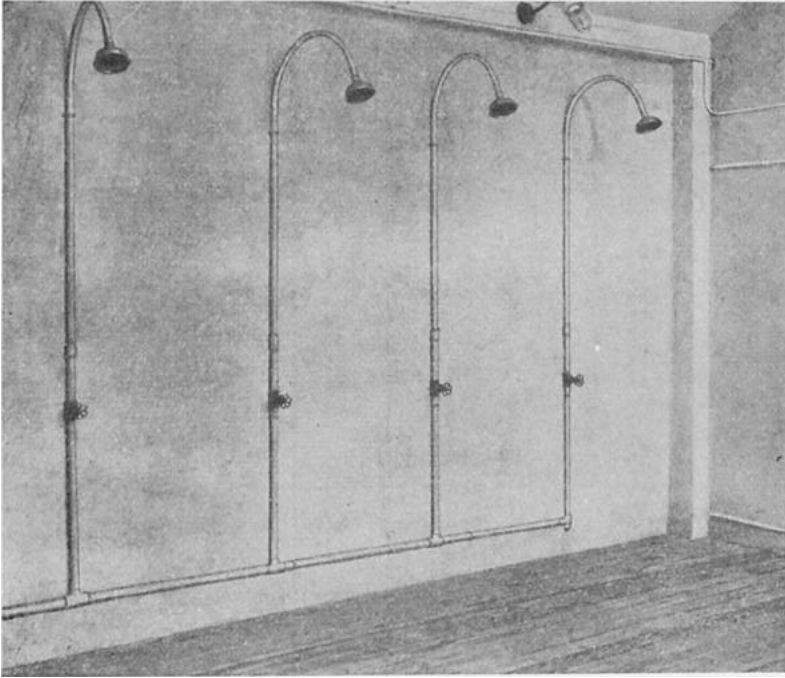

The Shower-baths.

their agreement with the Building Committee, the desired permission was granted.

In the following pages some additional technical information will be given of these parts of the Stadium, as it may prove of essential service for the construction of other, similar athletic grounds.

An account of the construction of the tracks and pitches at the Stadium.

It was a vast amount of work, demanding no little expenditure of time, that, on the 1 Aug., 1911, still remained to be done in the interior of the Stadium, in order to have the tracks and pitches, etc., ready at the time fixed, and, when reading a description of what was carried out in the grounds, consideration must be paid to the relatively short amount of time that was left for the execu-

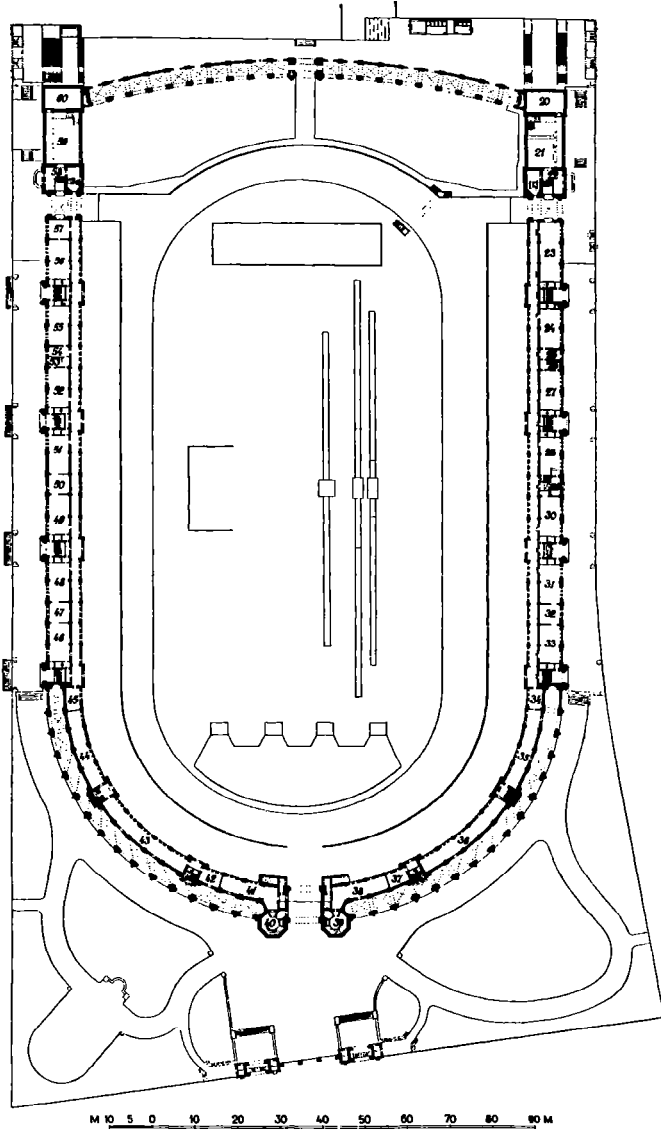

The premises beneath the amphitheatre as used during the Games:

N:o. 23, the Press foyer; 24, Great Britain (25, 26, bath and shower-bath); 27, Australasia, Canada, South Africa, Finland (28 is the Royal Foyer; 29, the entrance to Royal box); 30 Denmark; Norway; 31 Russia, Bohemia (32 a large shower-bath room); 33 Italy, Germany, Austria; (34—37, kitchen, etc., 38, store-room for athletic apparatus; 39, 40, attendants); 41, cashier's room (store-room); (42—44, kitchen, etc.; 45, workshop); 46, Hungary, (47, a large shower-bath room); 48, France; 49 & 51, U. S. A.; (50, a large shower-bath room); 52 & 55, Sweden (53, 54, bath-room and shower-bath room); 56, Japan, Serbia, etc.; 57, medical men. — N:os. 20, 21 in the wing-buildings are reserve-rooms with a large hall; 59, mess-room; 60, kitchen. — On the plan there can be seen between the arena and the amphitheatre buildings, the space occupied by temporary stands; on the top of the plan the seats for the athlete-spectators, with the standing places for the public against the north arcade; the concrete barrier marks the inner boundary of these spaces. Between this barrier and the unbroken oval line lies the running-track, within which, again, is the turf-laid arena with — to the north — the tug-of-war sand-track, while to the right can be seen the pitches for the jumping, hop, step and jump, and pole jump competitions and, to the left the site of the fixed gymnastic apparatus. At the top right-hand curve of the arena can be seen the tunnel by which the competitors entered the arena.



SOUTH GATE OF THE STADIUM.



A CORNER OF THE SOUTH GARDENS OF THE STADIUM.



THE GARDENS AND SOUTH ARCADE OF THE STADIUM.

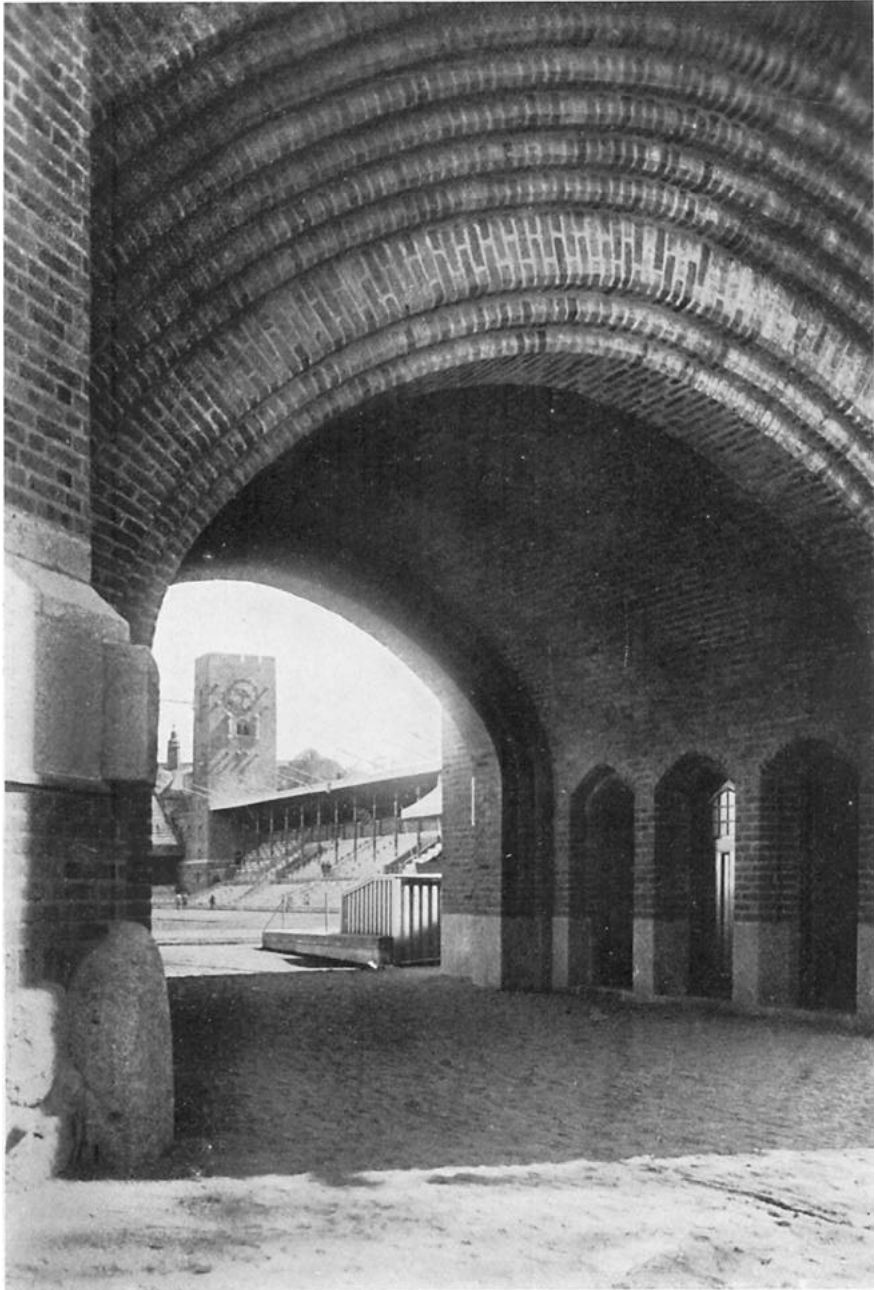

THE SOUTH GATEWAY.

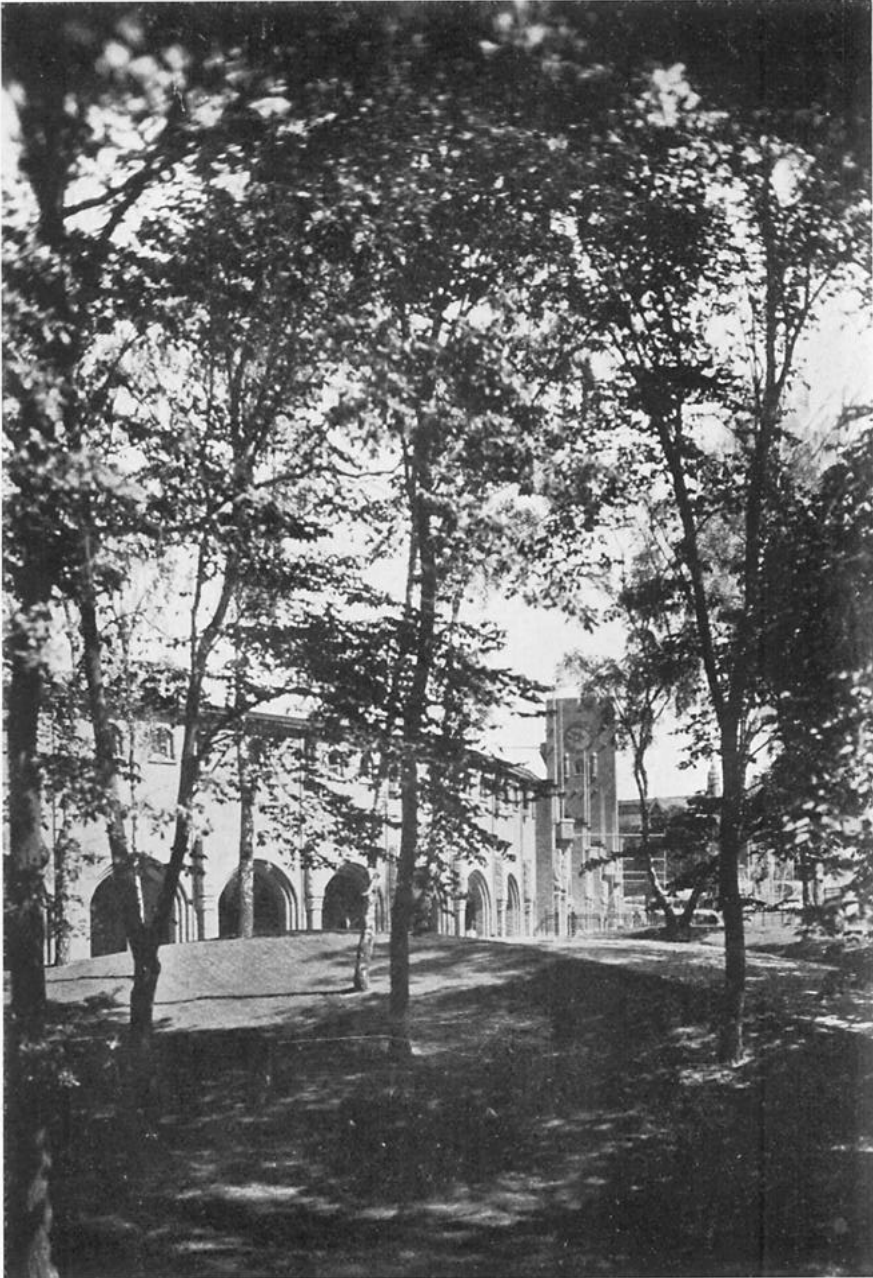

V I E W O F T H E G A R D E N S A N D E A S T F R O N T O F T H E S T A D I U M .

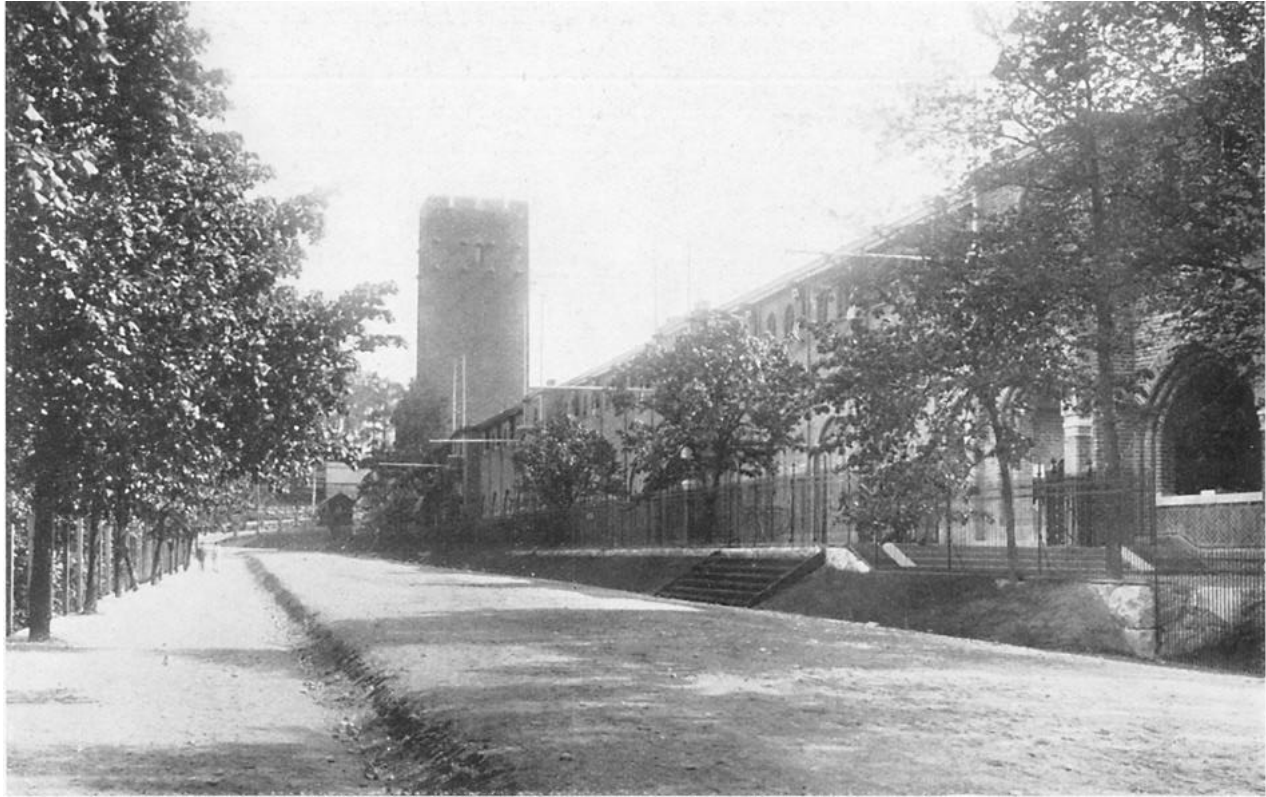

WEST FRONT OF THE STADIUM.

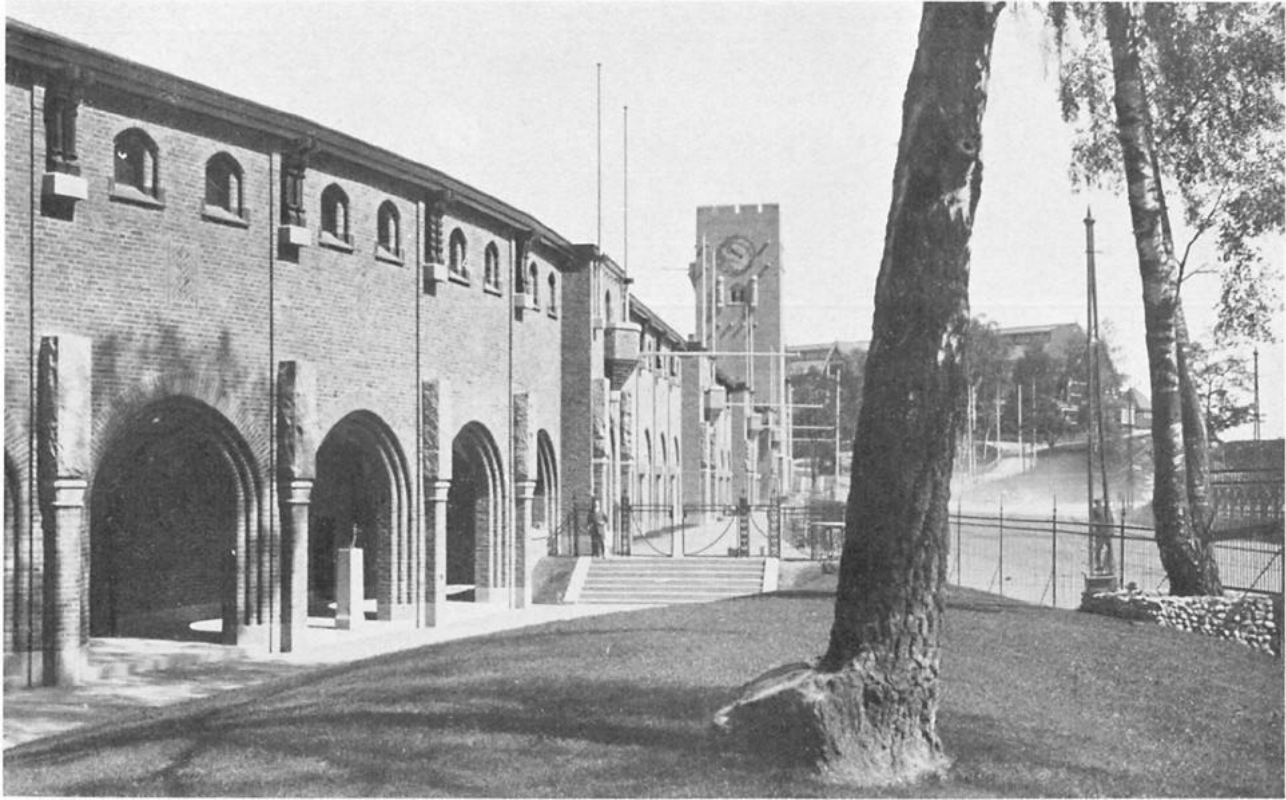

EAST FRONT OF THE STADIUM.



EAST BEACON- OR CLOCK-TOWER; ASK AND EMBLA.



THE SOUTH ARCADE.

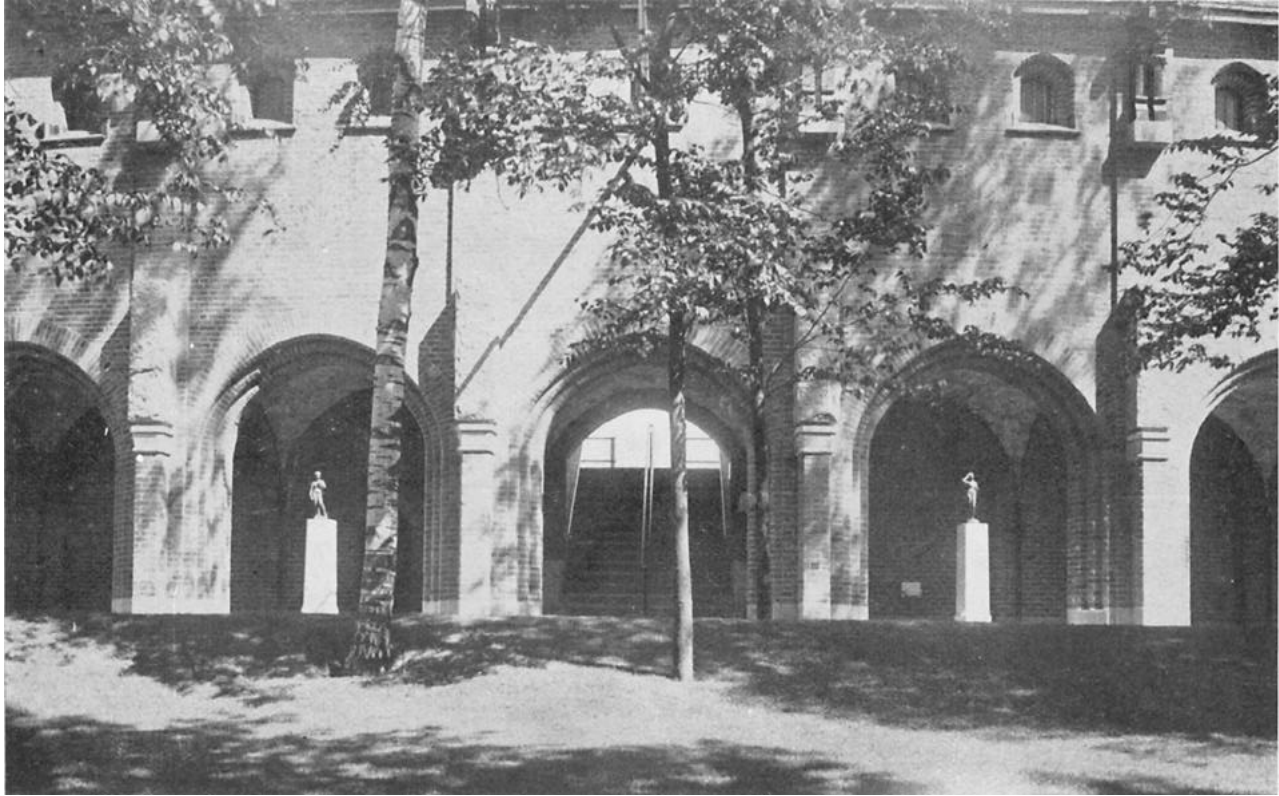

A PART OF THE SOUTH ARCADE.



THE NORTH ARCADE.



DRINKING FOUNTAIN AT THE WEST BEACON-TOWER.



VIEW FROM ONE OF THE EAST AMPHITHEATRE BALCONIES, SHOWING PROMENADE, FENCE AND TURNSTILES, WITH THE STEPS LEADING TO THE EAST ENTRANCE (shown here) OF THE NORTH ARCADE.

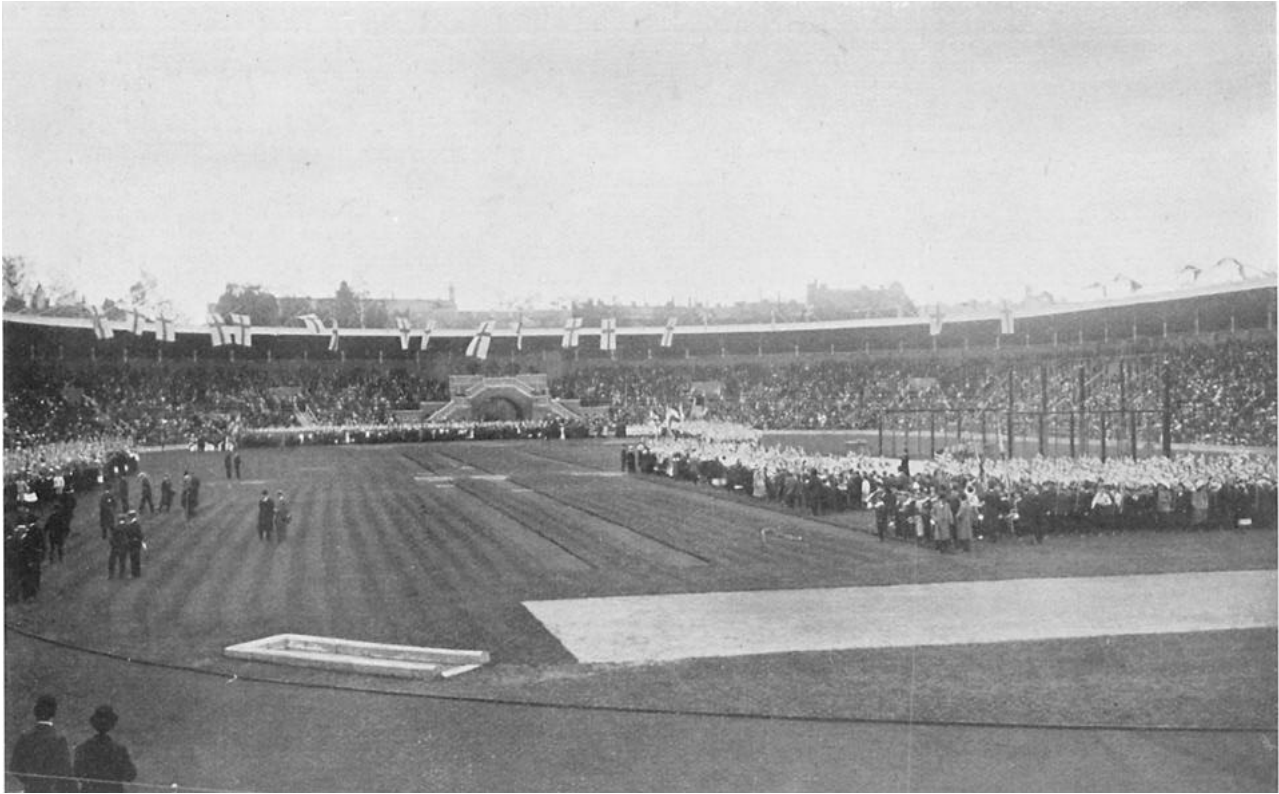

SCENE FROM THE OPENING OF THE STADIUM.



FROM THE OPENING OF THE STADIUM.



FROM THE OPENING OF THE STADIUM.

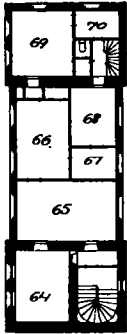

2nd floor.



Top of tower.

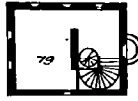

7th floor.

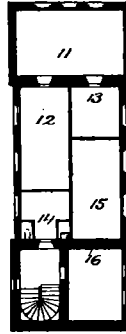

2nd floor.

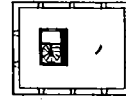

Top of tower.



7th floor.

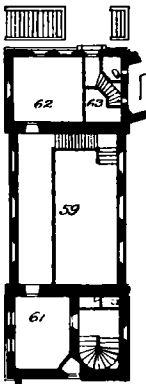

1st floor.



6th floor.



5th floor.

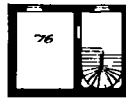

4th floor.

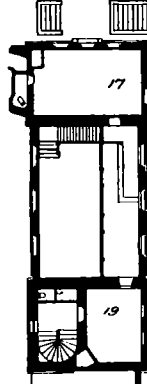

1st floor.



6th floor.



5th floor.



4th floor.

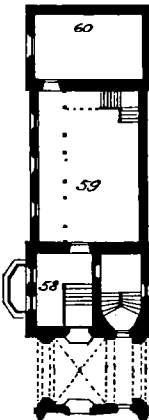

Ground floor.

West tower.

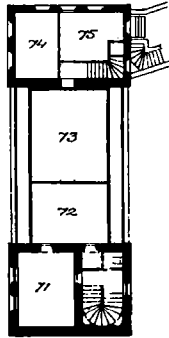

3rd floor.

Plan of tower rooms.

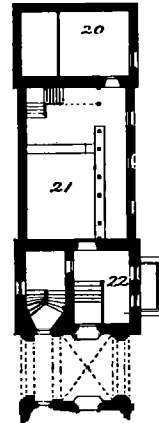

Ground floor.

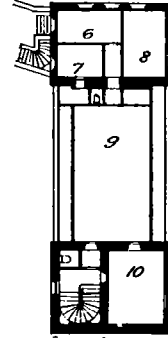

3rd floor.

East tower.

tion of the task, viz. from August 1911 to May 1912 — a period of 9 months, inclusive of the winter months, when the weather was unsuitable for carrying out the work.

Difficulties were caused, too, by the fact that the whole of the space was not available at one time. It was only possible to get the arena into order a little piece at a time. The laying down of pipes, which had been delayed, also formed a hindrance to carrying out the work in question in consequence of the open trenches, while the uncertainty as to the wishes of the English expert as regards the method of preparing the foundations of the running track, delayed blasting operations for the curves of the track.

However, the work was begun on the 16 August 1911, on the little part of the north end of the arena that was available, and Messrs. Kreuger & Toll, the contractors, carried out the work of clearing and levelling the ground with praiseworthy speed and goodwill.

During the first half of the month of August, turf for covering the centre of the arena had been procured after a great deal of trouble, from widely distant places.

But before the turf could be laid down, the ground had to be prepared and covered with mould, and a short description of this work will probably not be without its interest.

The greater part of the arena occupied the same place as the arena and cycling-track of the old athletic grounds, which rested on a deep layer of stones, in some places more than 4 metres in thickness, so that there was a good subsoil for the drainage of the new arena.

That part of the arena within the running track had to provide space for the football-, tug of war-, throwing-, jumping- and gymnastic competitions, while it had to be capable of being changed into a riding course within the short space of one night. In planning the work therefore, there had to be taken into consideration all these various branches of athletics, and in such a way that nothing done would be a hindrance to any of them.

On top of the above-mentioned stone-filling there was a layer of stone, coarse gravel, brickbats and gravel, and, here and here, the arena of the former athletic grounds covered with macadamized brick and sand.

As soon as the contractors had cleared and levelled one part of the place, in readiness for further operations, the ground was gone over by a 12-ton steam-roller.

The roller began its work on the 17 August and as soon as it had finished in one place, mould was spread there to a thickness of about 10 cm. When this layer had also been gone over by the roller, the bed was ready to receive its covering of turf, and the work of laying this down was begun on the 21 August.

On top of the mould after it had been gone over by the steam-roller, there was spread a thin layer of screened, rich mould, on top of which the lengths of turf were placed in perfectly straight strips. On cutting the ends of the turf-strips, care was taken to make the cuts at the joining places obliquely inwards and downwards, so that

when turf was laid to turf, a wedge-shaped opening was formed beneath, which was filled with mould before bedding and ramming with the beetle, so as to get close joinings, and to facilitate the growing together of the lengths of turf.

When a strip of turf had been laid down, screened mould was put in underneath wherever necessary, and great care was taken to see that there were no hollows between the turf and the mould, after which the whole was rammed tight, and a straight-edge and level were used to determine the correct height of the turf.

This work took up a great deal of time, for it was often found necessary to take up a strip of turf that had been laid down, in order to put more mould underneath, and it was not before this strip, after having been well rammed down, kept its desired height and felt firm to the foot over the whole of its area, that a new strip of turf could be joined on.

The work was carried out by groups of two men each, one of whom carried the turf and mould, while the other man cut the strip of turf even, laid it down and bedded it. Sometimes there were as many as 15 such gangs at work, but on such occasions extra help was needed for bringing in the material and taking away the rubbish.

When about 2,000 square metres of the arena had been covered with turf, it was raked free from the greater part of the moss growing here and there, the holes being afterwards filled with small pieces of turf.

As the surface was got ready, it was manured and sown with grass-seed in rich, screened mould. The seed-mixture consisted of 50 % timothy, 30 % white clover and 20 % poa pratense.

When the first frosts of winter came, the whole of the arena, with some few exceptions, was covered with turf and in perfect readiness.

Round the arena lies a draining-trench 80 cm. deep, and, after the contractor had laid down the piping, all the 5 pipe-trenches were filled with macadamized stone almost to the surface. The jumping pits have a 0.5 m. bedding of macadamized stone, and so have the running pitches used during the Olympic Games for the pole jump-, the broad jump- and the hop, step and jump competitions, and, as these pitches went almost as far as to the end of the football ground and were 1.6 met. broad, they must be considered as three very effective draining-trenches. In addition to this, the water-tank for the ditches in the horse-riding competitions, and the sockets for the gymnastic apparatus were also surrounded by macadamized stone.

The bedding of the tug-of-war pitch was connected with the bedding of the arena itself, while, here and there in the arena, there were constructed well-like holes filled with macadamized stone, so that the arena may be considered as being well perforated and adapted to the carrying-off of surface-water.

Mr Charles Perry, the track-building expert, arrived from London on the 24 October, and the excavation work for the running-track was at once begun. Mr Perry decided that the foundations of the track

should lie 45 cm. below the level of the surface and that the interspace should be filled with 3 separate layers — an 18 cm. bed of macadamized brick and granite, a 12 cm. layer of coarse boiler-slag, and 15 cm. of surface composition.

The work of excavation was hurried on, but the lateness of the season hindered the work very considerably, first in consequence of an incessant rain which turned the foundations and roads into a quagmire and, later on, from the cold, which froze this mass of mud and macadamized stones into a mass as hard as granite.

In addition to this, there were extensive patches of ground at the two end-curves, where blasting had to be carried out for levelling purposes; this blasting took a long time, as no depressions were to exist in the rock where water could collect, but draining-trenches had to be blasted for the carrying off of the water from such hollows. Nothing was allowed to hinder the work, however, and on the 28 October the laying down of the macadamized stone and coarse slag was commenced.

While this preparatory work was going on, Mr Perry had begun to make the surface-composition, the chief ingredients being gas-works'-slag mixed with earth and sand, which had been obtained from the site of the old gas-works when foundations were being dug there. If there had been a sufficient supply of this material everything would have been right, but, after laying a length of about 60 metres along the west side of the track, the supply came to an end, and there seemed little possibility of obtaining any suitable substance in its stead. Mr. Perry making many fruitless journeys in his search for the proper material. Finally, however, a composition was produced that satisfied him, and with which the track could be finished. The substance, consisting of locomotive-slag, slag from the Stockholm Electricity Works, mould, marl, building-sand and fine building (stucco) sand, was composed in agreement with a wash-sample of the earthy gas-works'-slag first employed, and was approved of by Mr. Perry.

All the materials in the composition had to be very carefully screened, but the result of this operation was, that only a small part of the composition could be used for the surface. The slag had to be used in the middle layer, while the coarser earth that remained after screening, was employed for levelling purposes.

The screens were constructed in agreement with Mr. Perry's directions. Iron wire, 3 millimetres in thickness, was stretched vertically on firmly-constructed wooden frames, and then interwoven with soft, fine wire at suitable distances, so that the vertical wires were always at a distance of 5 millim. from each other.

During the process of the work, care was taken that the screens did not slope too much, the incline given being a very slight one, and the mass was thrown against them from below, upwards. The sand and marl were sifted direct into the mixing-trough.

During the cold weather of December and January, it was necessary to warm the sand, marl and mould by means of an oven, before being mixed. During the same period it was impossible to employ

wire screens for sifting the mould; riddles with 8 millim. wire-cloth having to be used instead.

The composition, as originally made, consisted of:

Slag from locomotives	50	%
Slag from the Electricity Works.....	10	»
Mould, and mould mixed with sand...	30	»
Marl ("Mosand")	5	»
Mortar-sand and fine d:o	5	»

but, in consequence of the variations in the character of the marl and mould, these proportions had frequently to be altered, and it was necessary to follow the mixing process with the greatest attention.

Among the fine building-sand mentioned above, there were found little balls of clay from which, on being squeezed, there exuded a sticky substance that was very injurious to the mixture, so that all the balls in question had to be carefully removed, even if only as big as a pea.

The process of mixing took place in a mixing-trough, as in the preparation of concrete. First of all, the locomotive-slag was spread out; then came the mould, followed by the boiler-slag with the marl and building-sands, riddled direct on to the other constituents. As a rule, the composition was ready after two throwings, but now and then it was necessary to repeat the operation several times before the perfectly uniform mixture required was obtained.

The various ingredients of the composition had to be of a fixed type. The locomotive-slag had to be free from ashes and cakes of slag. The mould was a black, vegetable mould, mixed with sand but free from clay. The boiler-slag had to be well burned and finely broken; slag-cakes had to be rejected. The marl had not to have too large a percentage of clay, while the building-sands had to be uniform and large-grained, and perfectly clean.

When the composition was ready it was taken to the "laying-gang" who spread it out and raked it level, taking care, at the same time, to pour out, on each occasion, such an amount of the mass as would obviate all necessity for re-laying in consequence of depressions arising. The surface was then trampled down, foot by foot, and rammed down with beetles.

The surface of each section of the track was scraped smooth by means of the iron edge of the rake, and the level examined, after which it was rammed down with the beetles, until the whole was quite solid.

In this manner, metre after metre was laid, until on the 25 January, the whole of the track was in readiness, and was allowed to remain undisturbed until the frost had gone out of the mass.

The running track is level in the straights and on the inner side next to the central arena, but, in the curves, the middle point on the outer side lies 30 centimetres higher than the level of the inner side.

Macadamized stone was laid on these parts of the foundations on the curves where the rock had been blasted away, but, in a number of places, mostly on the eastern side, it was found necessary to excavate the foundations to a greater depth, and to strengthen the bottom with a layer of the loose stone thus obtained, before the macadamized stone could be laid down.

When the running track was constructed, there was built a wooden ledge round the edge, on the side nearest the arena. This ledge consisted of 7" planks fastened to 2" poles driven into the ground, and determined the edge of the inner side of the track. The woodwork was coated with tar, the top edge being painted white, however. The surface of the running track at the wooden ledge lay 4.5 centimetres below the level of the turf-covered arena.

Just before the running track was ready, work was begun on the jumping-pits with their start-pitches. Four jumping-pits for the high jump and the standing broad jump were constructed in the southern part of the arena, the start-pitches for these occupying the whole of the arena between the pits and the running track.

The pits were excavated to a depth of 1 met., and the bottoms were then filled with macadamized stone to a depth of 0.5 met., after which, coarse boiler-slag was laid down and rammed with a beetle, the whole being covered with a 30 cm.-thick layer of "jumping-sand". It was a matter of much difficulty to procure this sand, and many samples had to be rejected, but at last suitable material was procured from a gravel-pit at Hagalund, near Stockholm, where the sand wanted was found in a thin layer between beds of a coarser quality.

The start-pitches were excavated to a depth of 0.8 met., and after macadamized stone had been laid down to a depth of 0.5 m., the pitch was completed in the same way as the running track.

The start-pitches and jumping pits for the pole jump, the running broad jump, and the hop, step and jump competitions, were constructed in the arena in the eastern part of the football field.

The pits and the start-pitches, which were 35 met. long and 1.6 met. broad, were constructed in accordance with the plan adopted for those for the high jump. Everywhere in these pits and pitches the bed of macadamized stone was always placed in connection with the foundation-filling of the arena. The surface of the start-pitches lay 8—9 cm. below the level of the turf, and in order to make it possible for the football matches and the coming horse riding competitions to take place in the arena, it would be necessary, on the occasions just mentioned, to have the pitches etc. covered with turf. As such an alteration of the ground would have to be carried out within the shortest possible time, it was necessary to have every thing in readiness, and to fasten the strips of turf upon thin planks fastened together by means of cross pieces or ledges. The boards were $\frac{3}{4}$ " in thickness, while their length was adapted to those of the pits and start-pitches. Roof paste-board was fastened between these ledges, and over the whole was spread a thin layer of sifted mould, above which were laid the clean-cut pieces of turf. While this work was being carried out, the

ledged boards in question were laid across a couple of trestles, 1 met. in height, and, when the turf had been put into position, holes were bored through both turf and planks, and the strips of turf were sewn fast with strong, tarred yarn.

When this was done, the ledged boards were lifted down and the turf rammed with a beetle, the sides of the turf being then so cut that the edges of the turf projected a couple of cm. past the sides of the planks. As each one was made ready, these ledged boards were placed side by side, and the turf was sown with grass-seed and watered, so that, when they were at last employed, the turf was in excellent condition and the arrangement proved to be perfectly satisfactory in every respect.

On the eastern side of the centre of the arena there were laid down the iron rings or hoops for putting the weight, throwing the discus and throwing the hammer competitions. The rings were constructed of 5 cm. angle-iron with the flat side upwards, and with the ring divided into 4 parts, with an eye at each end. Through these eyes, which lay exactly over each other, iron bolts were driven into the ground for the purpose of holding the sections of the rings together and fastening the whole to the ground. Inside the rings, the bedding of the arena was dug up to a depth of 30 cm., the excavation being afterwards filled with a mixture of mould, gravel, slag and marl, well mixed together. This composition was, at the same time, well sprinkled and rammed hard with the beetle so that, when it was dry, it had the desired firmness and solidity.

For the purpose of protecting the spectators from injury by the hammer in case of anything breaking, or by the hammer being thrown backwards, there was erected at a suitable distance behind the ring, four 5" poles to which was firmly attached a so-called "Jumbo-net", quite strong enough to prevent any accident of the kind in question. It was an easy matter to erect and remove the poles and net in question. On the occasion of the football- and horse riding competitions, the rings were taken up and the surface inside them covered with fresh mown grass, which gave these circles the same appearance as the rest of the arena.

At the north end of the arena there was constructed the pitch for the tug-of-war competition. It was excavated to a depth of 30 — 40 cm., the bottom having a slope towards the south side where a draining-trench was arranged, connected with the bottom-filling of the arena. On the bottom, after excavation, there was placed a layer of macadamized stone and slag, covered with a 15 cm.-thick layer of sandy clay, gravel and marl, the composition, after being spread over the surface, being rammed hard with beetles, after which the surface was tom up by means of iron rakes, and a second similar layer was laid down and rammed firm. The surface having been levelled, it was once more lightly torn up, and clean coarse gravel was then laid down and rolled in. Care was taken, during the entire process of the work, to keep the pitch damp, but not wet. A part of the final processes of this work was carried out in the spring of 1912, in con-

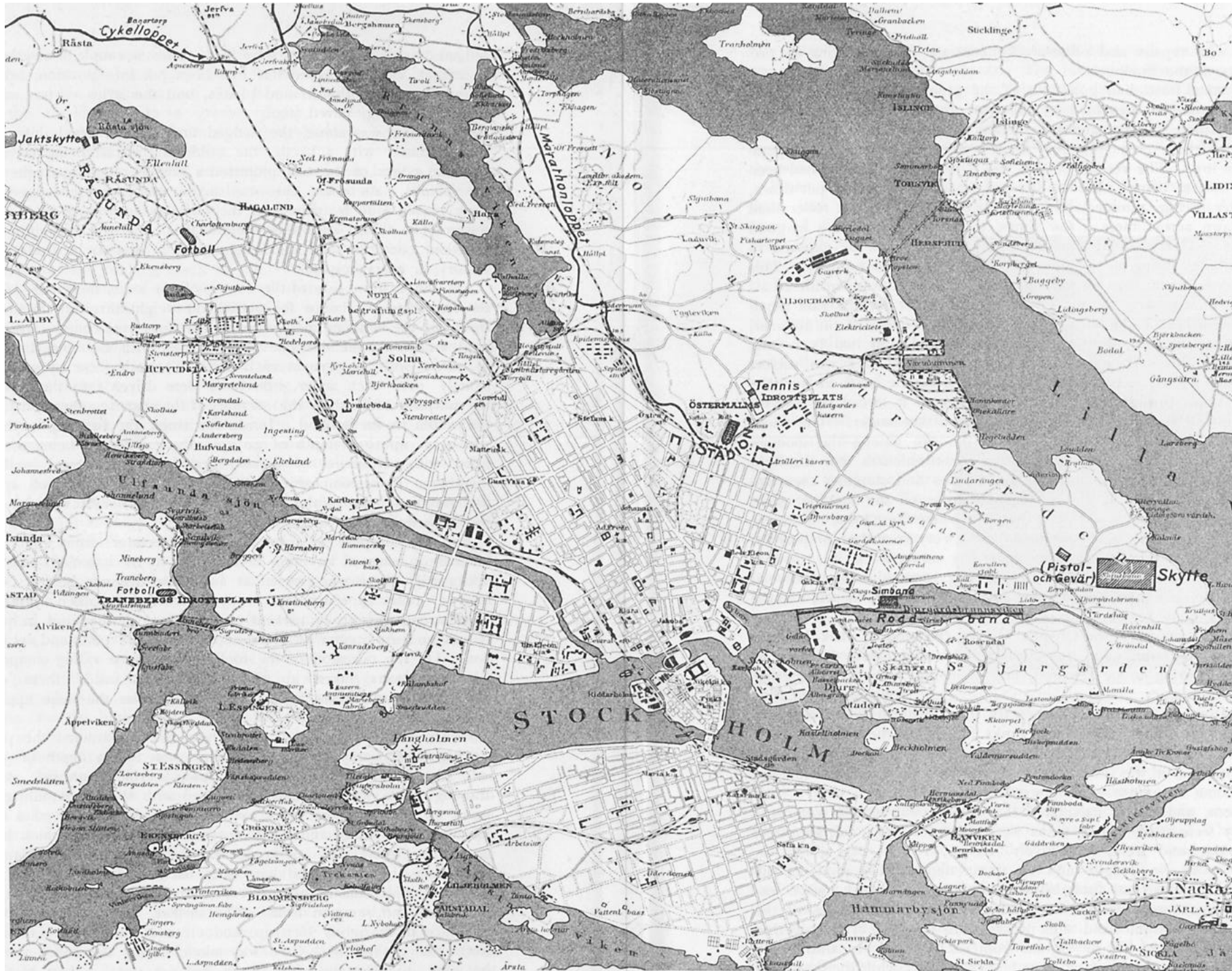

Map of the environs of Stockholm, showing the situation of the scenes of the Olympic competitions.

Cykelloppet = Cycle Road Race.
Fotboll = Football Ground.

Idrottsplats = Athletic Grounds.
Jaktskytte = Clay Bird, etc., Shooting.

Marathonloppet = Marathon Race.
Pistol och Gevär = Pistol and Rifle.

Rodd = Rowing Course.
Sjöräddningsbåtar = Swimming Stadium.

Skytte = Shooting Ranges.
Stadion = The Stadium.

nection with repairs and other work necessary for completing the preparations at the Stadium.

After the frost had gone out of the ground, it seemed as if the turf-laid arena had benefited by the frost and ice; it appeared to be drier and more porous, and the running track was firm, with the exception of those parts that had been constructed when the temperature was low. The reason of this was, that the composition had been warmed when being mixed and had frozen after being put down, but, after being rammed with the beetle, and after a roller had been drawn across them a few times, these parts, too, were in good condition. This showed that the composition could be exposed to frost without losing its qualities of cohesiveness and porosity. This latter characteristic was so strongly marked that it was considered altogether unnecessary to make any special outlet for the rain along the timber-ledge of the arena, but, during the course of the summer, it was observed that such outlets were wanted. It had been long noticed that the surface-composition of the running-track was subject to alteration, i. e., a part of it oozed out from the mass as a whole, and ran down towards the plank edging, where it forced its way in, filling up all the openings for the escape of the water. The cause of this was the presence of little pieces of coke among the locomotive-slag, this substance causing other inconveniences too, the light fragments of coke getting into the drain-pipes and stopping them up. The greatest difficulty in this connection arose on the running track, as this path was most used just at the place where these loose substances had gathered and so were trampled hard. Very soon the composition lost much of its porosity and rain-water lay on the track; it is true that the path was torn up, and fresh, clean slag rammed in, but the small fragments of coke had forced their way in to a great depth, and the track never quite regained its original porosity.

During the course of the Olympic Games, the running track demanded much labour and care, the starting holes and other damages to the surface having to be repaired, and sweeping, rolling and watering were also necessary.

Preparatory work was also necessary for the horse riding competitions; amongst other things, the tanks for the ditches in this event had to be sunk into position and, as only one night was available for the excavations, it was necessary that the tanks in question should at once become watertight. They were constructed with a view to this requirement, and it was calculated that they would remain watertight until they were used. Three tanks were constructed of good, knot-free, deal planks, and were, respectively, 1.0 m., 1.20 m. and 4.0 m. in breadth, 7 m. in length and 1.0 m. in depth. The joints of the bottom and sides had lists driven into the wood which, when exposed to moisture, swelled and pressed against the edges of the planks. The bottom- and side planks were fastened firmly together by means of bolts, 0.8 m. distant from each other. In addition to this, the bottom of each tank rested on 5" beams, while the sides were supported by similar beams to which they were screwed fast. Interi-

only, the tanks were painted with green oil-colour, and the outside was carefully covered with tar. The bottom of the excavation was filled with macadamized stone, on which the bottom beams rested, and macadamized stone was carefully rammed down with the beetle all round the tank. The necessary number of 2" holes were bored in the bottom of each tank for the purpose of letting out the water.

When the tanks had been lowered and all the filling round about them was ready, they were filled with slag which, after it had been rammed firm, was covered with turf in the usual way, and the tanks were then allowed to lie undisturbed until, the night before the horse riding competitions, they were cleared out and filled with water.

The fixed gymnastic apparatus was to be erected on the left side of the arena, directly opposite the Royal box, forming three sides of a square open towards it. The apparatus in question consisted of posts supporting ropes for climbing, and bars, and side-posts for the wall-bars. In order to get a firm hold in the ground for these posts and side-



Entrance to the Royal Box.

posts, cast-iron sockets were cast in blocks of reinforced concrete, into which the base of the posts could be lowered and adjusted by means of two wedges. The block of concrete rested on, and was surrounded by, macadamized stone, well rammed down, and in this way large drain-wells were formed which were connected with the bottom-filling of the arena. The sockets were made with holes in the bottom, so that they could not be filled with water, and, when they were not in use, each of them was covered with a large "stopper" of wood, to which turf was sewn fast. For the gymnastic competitions and displays there was also prepared a movable floor of planed planks, 15 m. × 25 m., which was both easy to lay down and to remove. It was painted green, and so did not contrast too sharply with the colour of the rest of the arena.

The same kind of sockets as those cast for the posts before-men-

tioned, were also employed for the posts of the goals used for the football matches.

Close to the innermost jumping-pits for the high jump competitions, there was laid down and fastened with iron bolts, a 5" plank, painted white, to serve as the crease or throw-off mark or scratch for the javelin-throwing competition.

Nothing more remains to be said respecting the work on the arena, but a great many other arrangements were necessary there for the Games, such as the erection of moveable and fixed triangular notice-boards; the judges'-stands; the electric time-taker and photographic apparatus; the stand for the leaders, and its telephone-communication with the Press gallery; the staffs for the standards of the winning nations, etc.; a number of benches for the competitors and officials and, along the start-pitches, laths, marked off in metres and English feet.

The wire of the electric time-taker was placed in an iron pipe running round the arena, close to the plank-ledge, electric buttons being arranged at all the various starting places. It acted in a perfectly satisfactory manner.

In marking out the various lanes on the running track, it was decided not to use chalked lines, and a specially constructed "notcher" was drawn round the track, all the lines being thus drawn at once on the surface of the running path. In the grooves thus made, there were afterwards laid down, and fastened by means of iron cramps, thin manilla-hemp ropes which clearly marked each runner's path. The ropes were rolled up on a cylinder between a couple of light wheels and when they had to be laid down it was merely necessary to draw the machine quickly along the track, and then fasten the lines in the grooves made by the notcher.

The old oak-park of the former athletic grounds along the wall towards Valhallavägen, had been quite cut in two by the main entrance of the Stadium and made a very sorry figure, but this part of the Stadium, too, received a full share of attention. New paths were constructed, lawns were re-fashioned or new ones were made; the wall towards the street was repaired and wild vines were planted. A new wall was erected towards Sofiavägen, and the former ugly corner of the same road disappeared, while the stone plinths, with their wealth of blooming roses and climbing ivy, gave the park in its new state quite a festive appearance. The new park was designed by the architect, Mr. T. Grut.

The road round the outside of the Stadium was put in order and laid with gravel, the path to the manege near the eastern entrance of the building was levelled, and farther up the slope, the filling up of the hollows and the laying down of turf, etc., was carried out.

The slopes below the path leading to the tennis pavilion close to Sturevägen were now filled up with screened, coarse mould which was then raked and sown with grass seed, so that it soon presented quite a beautiful appearance. Fences and gates were erected near this path and, at the western ticket-office, there was constructed a

stone terrace connected with Sofiavägen which had also been relaid.

During the Games themselves, there was work continually in hand, the nights being devoted to the carrying out of repairs, the alterations necessary for the next day's competitions, and the removal of apparatus no longer needed. However, everything was in good order by the time the Games began, and during the progress of the competitions everything went as if by clockwork. It is to Baron Hermelin, the Director of the Stadium, that the chief credit is due of all this multifarious work being successfully completed by the date fixed.

The accompanying plans and sketches will serve to illustrate some of the descriptions given above respecting the running track, pitches, implements and methods of work employed.

TECHNICAL BUILDING ARRANGEMENTS.

The fence and gates. The turnstiles.

The site on which the Stadium has been erected is entirely surrounded by an iron fence, 140 m. high and consisting of pointed bars 10 cm. distant from each other, passing through two horizontal rails above, and attached below to an iron rail running close to the ground; at distances of 2.75 met. from each other there are stouter iron pillars fastened in granite plinths fixed in the ground, and supported against the latter by means of a stay; at the entrance to the Royal box these two gate-posts have been given a more decorative appearance, being topped with a crown. The fence, which is 700 met. long, is provided with 14 gates for the public, while, at Sturevägen, there is a special gate for purveyors, etc. The fence is not broken by anything else than the buildings standing on the very boundary of the Stadium grounds, viz., the grand entry at Valhallavägen, with its large archways and turnstiles, and by the wooden erections in the north-east and north-west corners, serving as the entrance to the north arcade.

This line of fence and gates was completed by similar structures running transversely from the outer fence to the Stadium walls across the outer promenade, in order to separate the various entrances for the amphitheatre (to which admittance is gained through the turnstiles in the principal south entrance) from the entrances along the sides of the building.

The entire line of fence and gates was very carefully designed by the architect, and the system adopted worked, during the Games, and still continues to work, in a fully satisfactory manner.

To enable competitors to reach the arena direct from the dressing rooms without having to traverse the path running outside the northern curve of the arena and tunnel, gates were erected separating the arena from the east and west gateways, and as the third grand entrance to the arena — the southern gateway — is used on many occasions when competitors are on their way in and out during a race, etc., a great folding gate, with four divisions, has been

erected here, so that the whole can be laid in two parts against opposite walls of the gateway; a smaller gate in the middle affords entrance under ordinary conditions.

Gas-, water- and waste-piping installations.

The basis for the sanitary technical installations was the plan that Mr. William Andersson, C. E., drew up by order in February, 1911, the work then being estimated to come to Kr. 42,000 (£ 2,300 : \$ 11,500). After the plan had received the approval of the Building Committee and the State authorities, tenders were advertised for, one for the piping and a separate one for the necessary digging operations. The

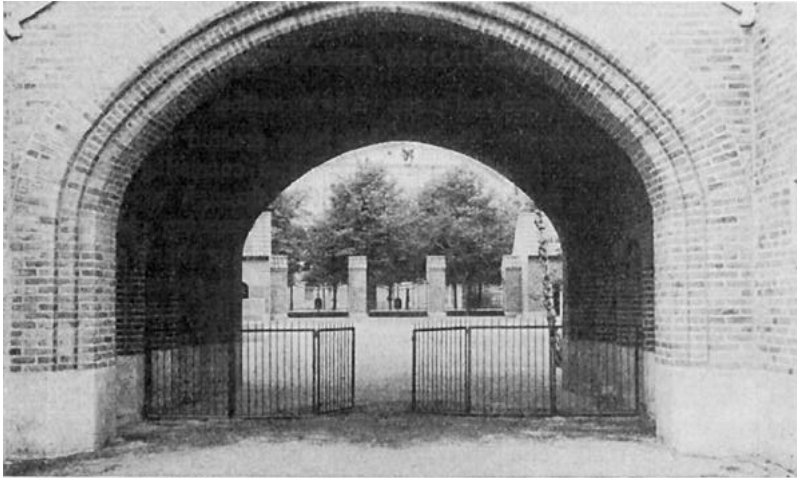

Folding gate with smaller middle gate, in the south entry (seen from the running track). In the back-ground can be seen the entrance porch at Valhallavägen.

draining of the arena proved a work of very great difficulty, special "canals" having to be blasted in the underlying rock for the purpose, and other technical means having to be employed.

There are lavatories at the foot of each staircase leading to the amphitheatre. Drinking water for the public can be had at the same places and at the fountains in the southern arcade. Fire-cocks are placed at the four comers of the arena with an extra cock in the east stand, used for flooding the arena in winter to form a skating rink there.

The gas-piping serves to heat two shower-bath heating-apparatus (one on each side of the amphitheatre), the gas ranges in the kitchens in the wings and in the restaurant buildings of the south arcade, where there are special gas-stoves for heating purposes, too. There are two large gas-cocks in the arena, one, 15.2 cm. in diameter, for the purpose of filling balloons. Hardly any gas is used for illuminating purposes. The gas-meter, which is built into the wall of a room on the east side of the amphitheatre, is for 300 jets.

Of the 6 tenders received for the gas-, water- and waste-pipes, and which varied between Kr. 67,600 (£ 3,710 : \$ 18,550) and Kr. 44,750 (£ 2,460 : \$ 12,300), the Building Committee accepted the latter.

Heating arrangements, etc.

In the original plan of the Stadium, in accordance with which the Building Committee had to work, all heating arrangements had been excluded on account of the expense. It was afterwards found necessary, however, on account of the woodwork and the socles, etc., (which would have been injured by continued exposure in unwarmed premises) to provide heating apparatus for the building. This cost Kr. 17,190 : 55 (£ 940 : \$ 4,700), inclusive of contractor's charges and controller's fees, automatic pumps in the boiler-room, and insulating protective devices against under ground water.

It was not before the Games were over that the amphitheatre of the Stadium was provided with heating apparatus; a most regrettable delay, as, in the minutes of the meeting of the Building Committee held on the 10 June, 1912, i. e. several weeks after the Swedish athletes had begun to use the dressing-rooms, the entry was made that "the athletes have complained that they are not able to stay in the unwarmed dressing-rooms with any degree of comfort, on account of the rawness of the air there. A similar complaint has been made by Mr. Hjertberg, who fears that the health of the men will suffer in consequence of the coldness of the rooms".

The steps taken for the *electric lighting* of the Stadium have resulted in current being now supplied both from Sturevägen and Sofiavägen.

BUNTING.

The Stadium is provided with a large number of permanent flag-staffs mounted in various ways and intended to serve different purposes. Over each of the six entrances on each side of the amphitheatre, the flag-staff lies horizontally, this group being intended for flags provided with letters showing the numbers of the sections of seats to which the entrances give access. At each of eight of the entrances there are also two staffs standing perpendicularly; these are intended to carry the Swedish colours. A similar flag-staff is erected on each side of the chief entrance, close to which stand two additional staffs fixed in the ground. Inside the building, the eye is attracted by the immense flag-staffs projecting horizontally from the seventh story of each tower. Round the roof of the amphitheatre, and at the same angle as the upward slope of the roof, are seen fifty poles; the Swedish flag is hoisted on those above the Royal box and those at the south entrance; on the other forty-six staffs, the flags of competing, foreign nations can be placed, as was the case during the Games, and as is done when it is wished to show honour to any country whose representatives may happen to be competing in the Stadium. On the day when the new-built Stadium (N. B. *not* the Olympic

Games) was solemnly opened, the only colours hoisted were those of Sweden.

In the centre of the north arcade rise the three important "prize flag" staffs, — the middle one — that for the national flag of the first prize-winner — being considerably higher than the other two.

During the Games, these staffs rose through the temporary north stand, along the back of which there were twenty staffs flying the Swedish colours — the whole forming a most charming background.

When the flags were ordered, the Swedish flag-makers would not be responsible for the correctness of colour and design of the standards of foreign nations, and so the Swedish Olympic Committee was requested to ask the Olympic Committees of the other countries to send the necessary number of their respective national flags. Some countries sent models in reply, but the problem was solved by the Stockholm Flag-making Co., which was given the entire order for foreign flags, undertaking the responsibility of seeing that the flags provided were absolutely correct. This was a matter of some difficulty, although the Ministers and Consuls of foreign powers at Stockholm kindly gave much help, and the special literature on the subject was consulted,

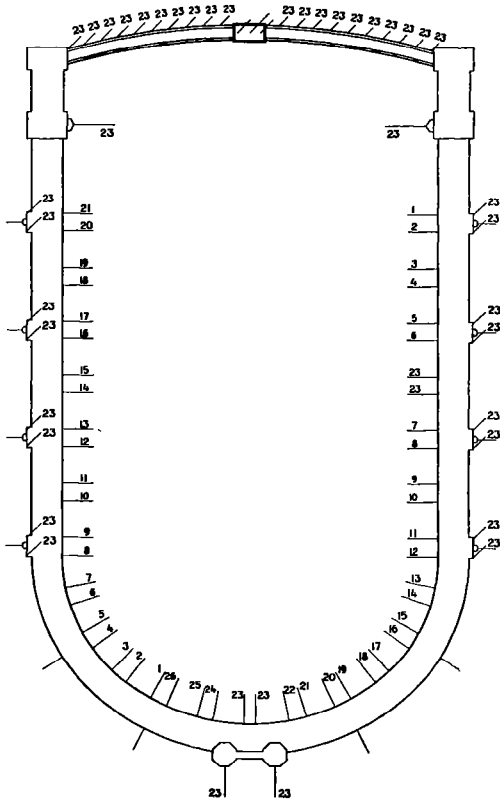

Plan of the Flag decoration of the Stadium.

N:r 23, always the Swedish flag. The flags of other nations can be hoisted on the other staffs — as was the case during the Games, when the following plan was adopted: Australia, Austria, Belgium, Canada, Chili, Denmark, France, Germany, Great Britain, Greece, Holland, Hungary, Italy, Japan, Luxemburg, New Zealand, Norway, Portugal, Roumania, Russia, Servia, South Africa, Switzerland, Turkey, and the U. S. A. each had two flags hoisted as a rule, one on each side of the amphitheatre. The three unnumbered staffs at the north are for the prize-flags. The unnumbered staffs lying outwards are for the seat-section letters, and the staff farthest to the north on each side, is for standards carrying the three crowns of Sweden, which hang above the entrances there.

but not a single criticism was directed against the flags employed at the Stadium during the Games. Each nation represented at the Games had two flags in the ring of colour in the amphitheatre; the Swedish flag was seen at the places mentioned above, and elsewhere round the exterior.

THE STADIUM ARENA DURING THE OLYMPIC GAMES.

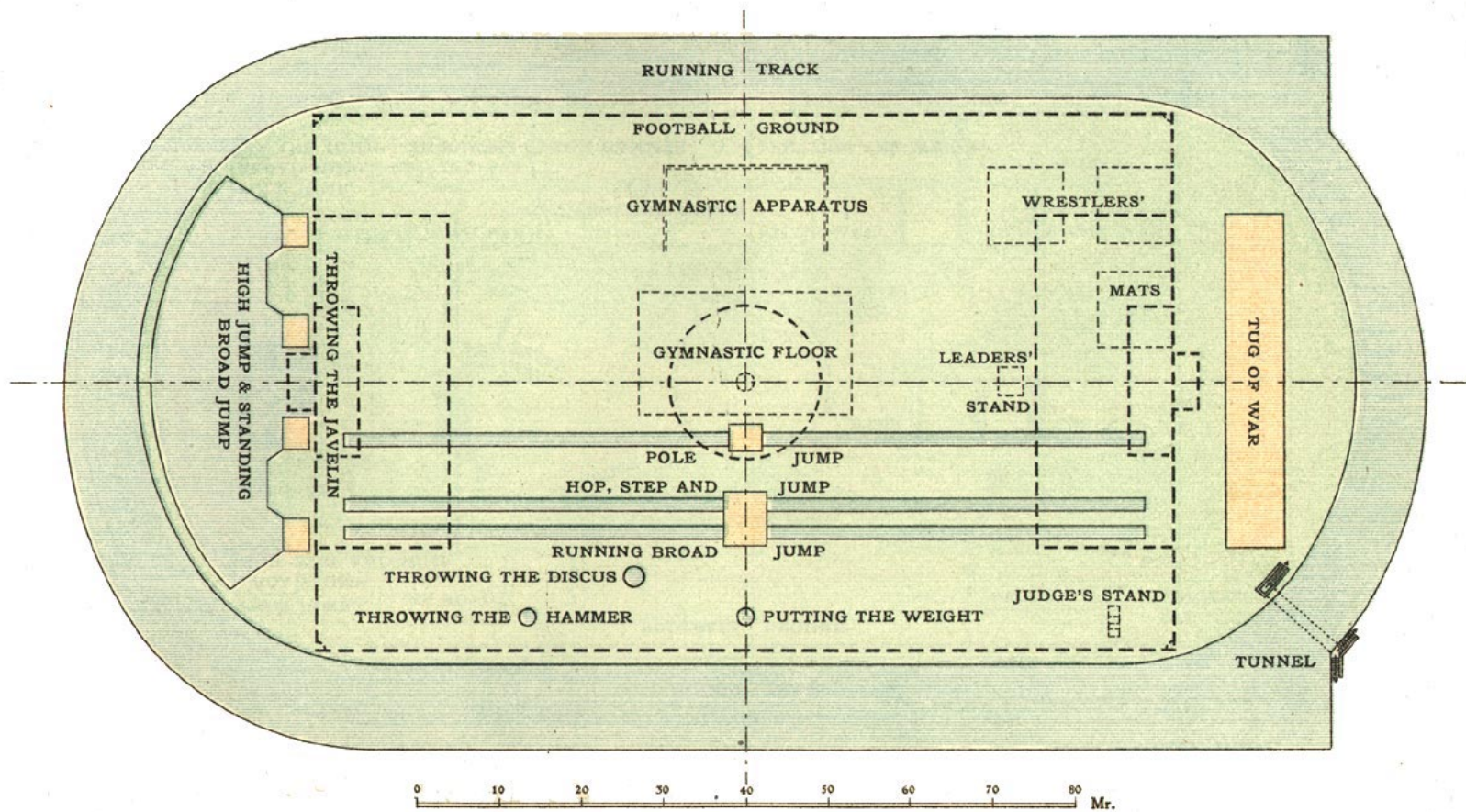

THE STADIUM ARENA AFTER THE GAMES.

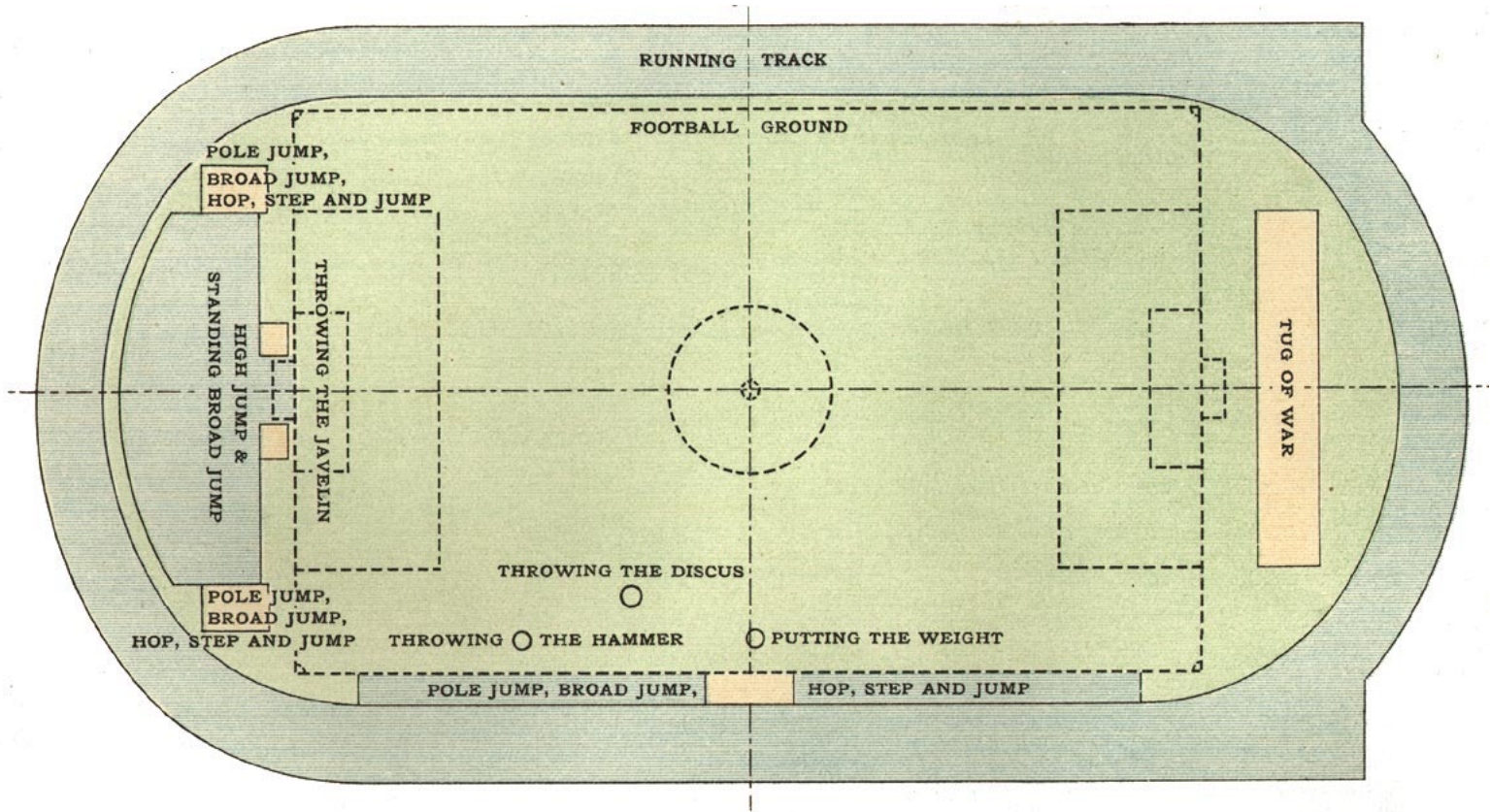

THE STADIUM ARENA AS A RIDING GROUND
IN HORSE-RIDING COMPETITIONS.

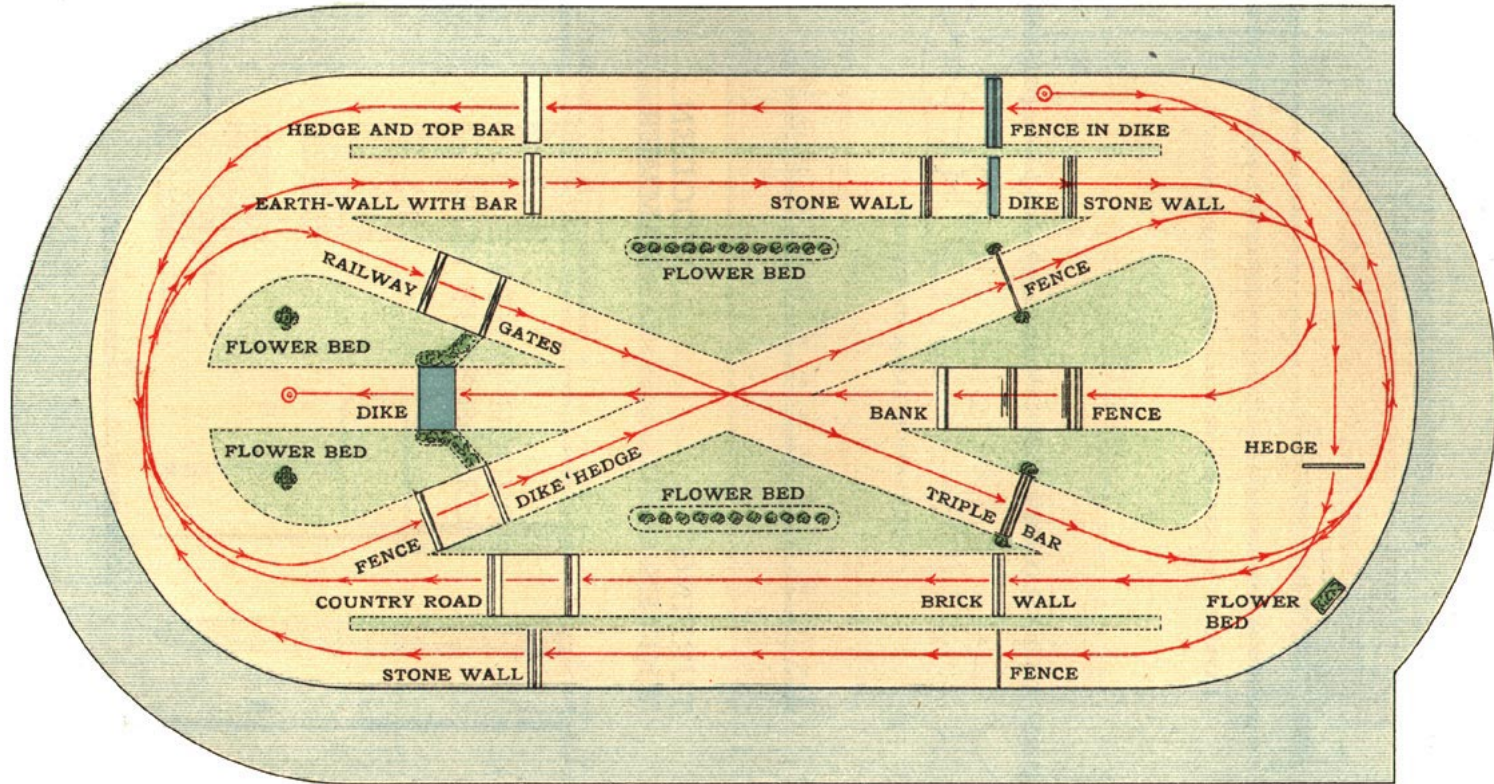

TURFING OF THE STADIUM.

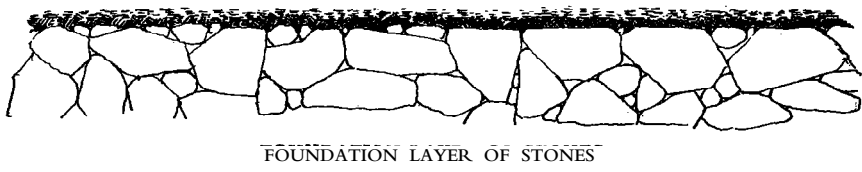
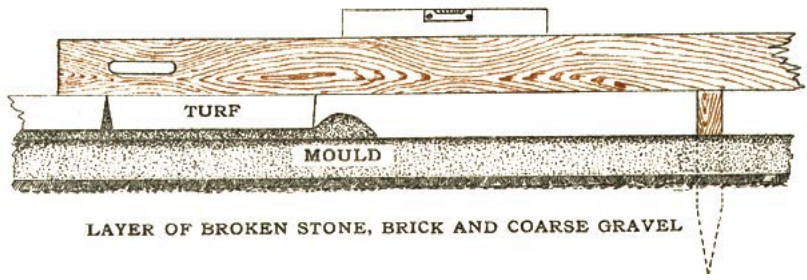

TURFING KNIVES.

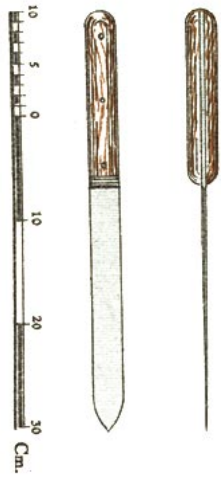

WOODEN RAMMER.

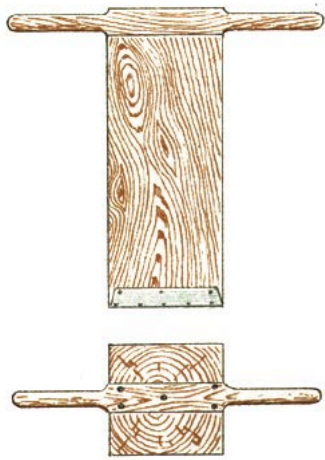

TURF-COVERED BOARDS FOR COVERING THE DIKES.

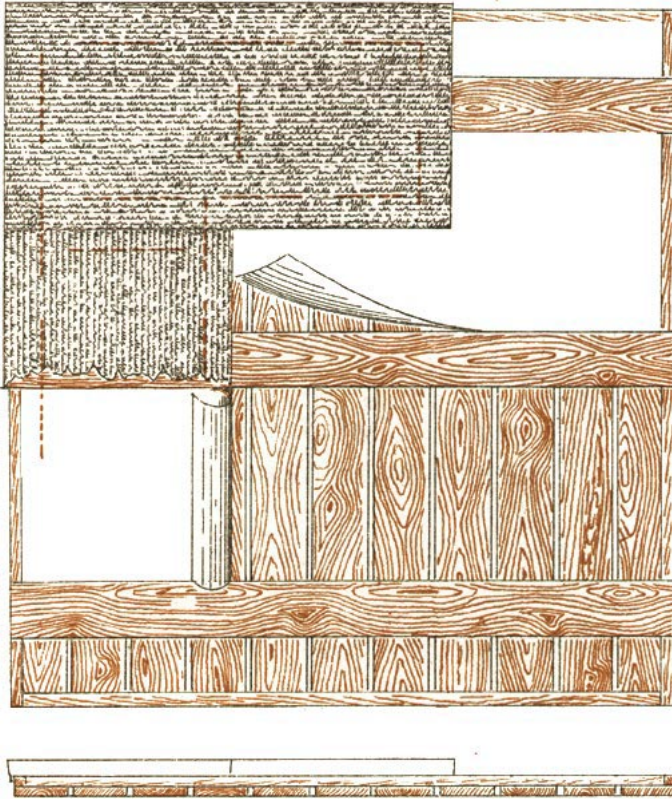

LIFTING HOOKS FOR TURF-BOARDS.

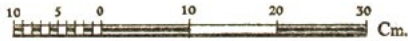
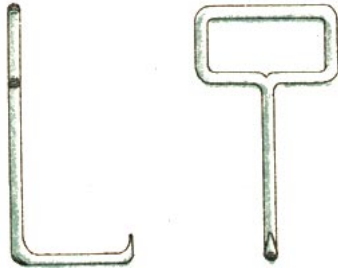

RUNNING TRACK.

FOOTBALL GROUND.

DRAINING WELLS.

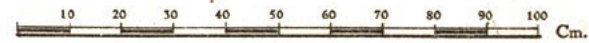
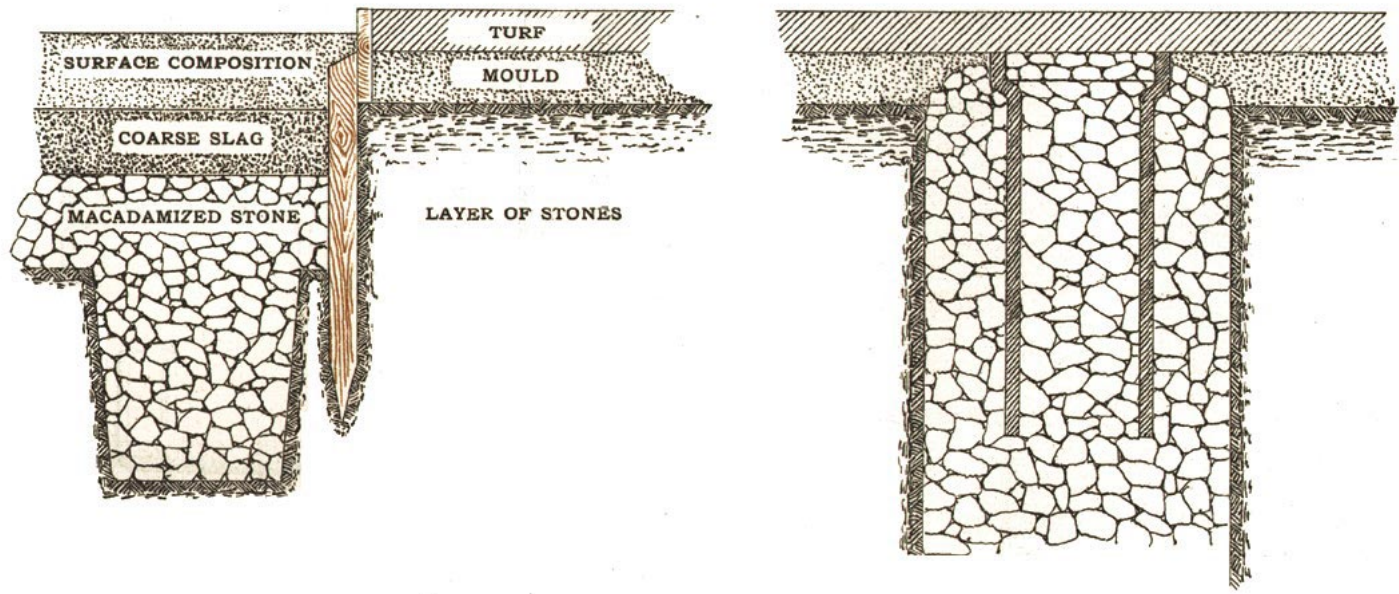

SUNK SOCKETS FOR GYMNASTIC =POSTS.

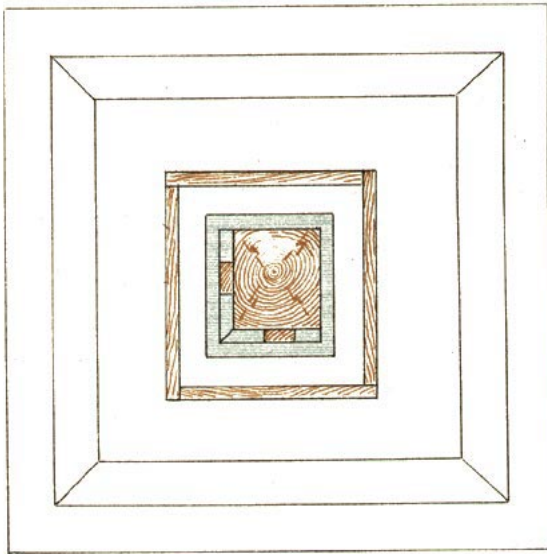
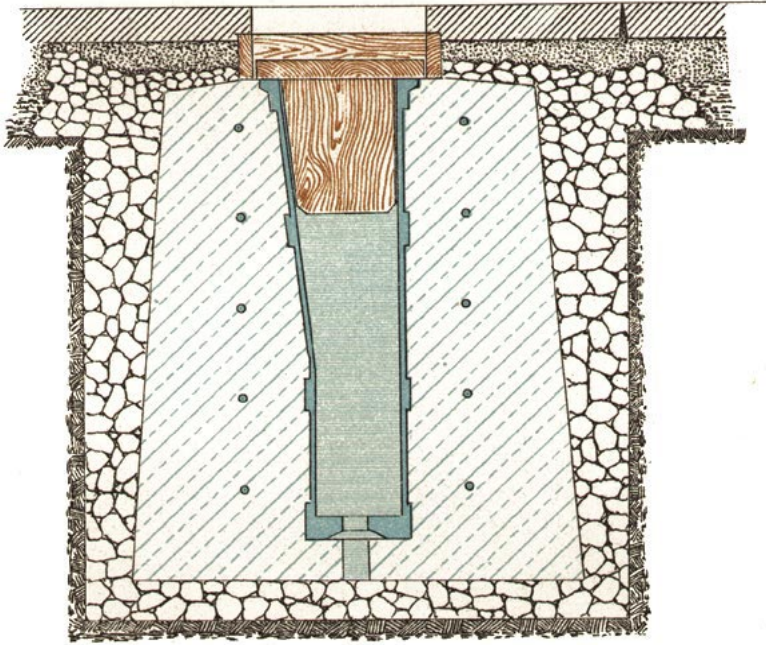

The flags used for the interior or exterior decoration of the Stadium are 4.8 metres long ; the prize flags are as nearly 4 metres long as circumstances will permit — the Swiss flag, and one or two others, necessitate this restrictive phrase — and the Swedish flags along the north arcade are 3.2 metres in length. In addition to this, the flags used when only Swedish colours decorate the interior of the Stadium, are 3.6 metres in length ; those waving from the towers are 7 metres long.

During the Games the necessary number of flags was lent to the "Swimming Stadium", to the "Rowing Stadium" and to the Yacht Racing Committee, for use on the days when decorations were required.

THE BAZAAR BUILDINGS AND THE KIOSKS IN VALHALLAVÄGEN.

At the beginning of 1912, the Building Committee received a communication from the Swedish Olympic Committee, respecting the erection of two buildings

which were to extend from Sturegatan all the way to Brahegatan, and intended to be c:a 25 metres in length, but which could be added to in case of need. The buildings were intended for telegraph and telephone offices, an office for the disposal of tickets remaining unsold; a money-changing office; a post office where picture post-cards could be obtained; a booth

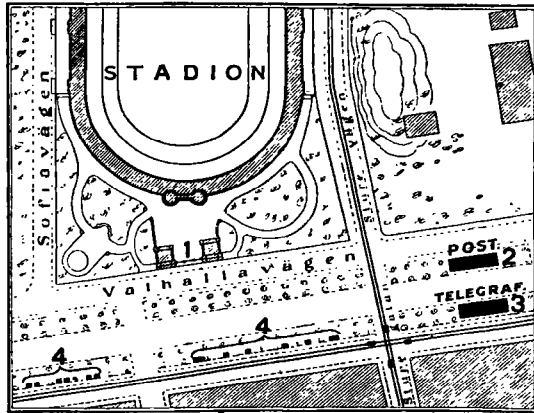

Plan of the Postal-, Telegraph- and Selling-booth buildings in Valhallavägen outside the Stadium.

for the sale of photographic articles, etc.; a cigar-shop, etc. Mr. Grut, the architect of the Stadium, having drawn the necessary plans, the permission of the authorities was obtained, and a contract was made with Mr. E. Lindkvist for the erection of the two pavilions, at an estimated cost of Kr. 4,000 (£ 220 : \$ 1,100) each. One was built on the north side of the avenue, at the expense of Granberg's Industrial Art Co., and contained the post-office, as mentioned above and a bank-office; the southern pavilion was occupied by the telegraph- and Rikstelephone offices. The cost of erection was defrayed by the rent paid by the State Telegraph Department.

In addition to these buildings, six small and two large kiosks were built by Mr. Lindkvist for the account of the Swedish Olympic Committee, in Valhallavägen, just west of Sturegatan, at a cost of Kr. 230 and Kr. 480 (£ 12,15 s. — £ 21 : \$ 64 — 105) respectively. Only a few of them found tenants, however. They were taken for

the sale of picture post-cards, the hire of field-glasses, etc., and though the rent just paid the cost of erection, the income received by the Committee by no means came up to expectations.

BUILDING- AND OTHER EXPENSES.

Mention was made in the first chapter of this section, that, in order to provide funds for the building of the Stadium, there was assigned the guaranteed profits of two extra lottery-drawings. After the deduction of Kr. 50,000 (£ 2,750 : \$ 13,750) for the Swedish Sport Exhibition in Berlin, and of Kr. 130,000 (£ 7,220 : \$ 36,100), given to the Swedish Olympic Committee out of the guaranteed profits, the sum remaining for the erection of the

Stadium amounted to	Kr. 220,000:—	(£ 12,210 : \$ 61,050)
To this was added the whole surplus of the same drawings	» 186,491: 68	(£ 10,257 : \$ 51,285)
And of the surplus from the ordinary drawings of the Athletic Lottery, fixed at...	» 315,000:—	(£ 17,325 : \$ 86,625)
Together with the interest on these sums, which, on a financial review being made on the 15 Jan. 1913 (taken, in this report, as the basis of all the figures given) amounted to	» 17,355: 42	(£ 951 : \$ 4,755)
	<u>Kr. 738,847: 10</u>	<u>(£ 40,550 : \$ 202,750)</u>

It soon became clear that this sum would not suffice, for extensive, costly details of work *forced* themselves to the fore, which were not included in the estimates, although the greater part of them had been part of the original plan. These items, which were additional to the operations on which the Royal Ordinance had based its grant of the lottery drawings before mentioned, consisted of supplementary work absolutely necessary if the Stadium was to answer the purpose which had originally occasioned its erection — the celebration there of the Olympic Games. The Swedish Olympic Committee, therefore, had to undertake the task of advancing funds for the additions in question, after the Building Committee had expended, on the work it had engaged to complete, the means intended for the purpose. This was only in accordance with the agreement which had been already drawn up on the 13 November, 1910, between the Swedish Olympic Committee and the Building Committee, according to which the first-named body then agreed to pay the Building Committee the sum of Kr. 60,000 (£ 3,300 : \$ 16,500) for such work on the Stadium as was necessitated by the Games.

Up to the 15 January, 1913, the following sums had been expended on the work at the Stadium:

Preparatory work; expenses of pulling down the old building	11,919: 51	(£ 655 : \$ 3,275)
Foundations; permanent buildings and stands ; tunnel to arena.....	626,744: 68	(£ 34,470 : \$ 172,350)

Provisional stands around the arena	43,169: 70 (£	2,374 : \$	11,870)
Provisional stand (now removed)	41,918: 80 (£	2,305 : \$	11,525)
Arena and running track	121,858: 81 (£	6,702 : \$	33,510)
Railings	29,284: 68 (£	1,610 : \$	8,050)
Turnstiles	9,260: 35 (£	509 : \$	2,545)
Wardrobes	8,977: 50 (£	493 : \$	2,405)
Entries and lavatories	43,159: 35 (£	2,373 : \$	11,865)
Gardens and roads	44,743: 49 (£	2,460 : \$	12,300)
Gas-, water-, and heating-installations	100,755: 06 (£	5,541 : \$	27,705)
Electric lighting	15,745: 82 (£	866 : \$	4,330)
Tower clock	2,292: 59 (£	126 : \$	630)
Flags (ordinary set of Swedish flags) with flag-staffs and ropes	2,485: 05 (£	136 : \$	680)
Inventories and furniture	12,787: 62 (£	703 : \$	3,515)
Experts	37,212: 50 (£	2,047 : \$	10,235)
Office- and administration expenses; taxes; interest and insurances	16,619: 84 (£	914 : \$	4,570)
Sundries	8,151: 27 (£	448 : \$	2,240)

This report shows a total expenditure of Kr. 1,177,086: 62, (£ 64,740 : \$ 323,700) to which must be added sundry payments amounting to Kr. 10,793: 35 (£ 592 : \$ 2,960) which have not passed the accounts of the Central Association, these two sums, amounting to Kr. 1,187,879: 97 (£ 65,333 : \$ 326,665). Additional supplementary work has, up to the present, caused the expenditure of another Kr. 21,000, (£ 1,150 : \$ 5,750), but, as the Stadium is a creation subject to a process of constant development, other perfecting work, more necessary additions and improvements, must be expected, bringing in their train — further expenses.

THE SWIMMING STADIUM.

One of the first tasks undertaken by the Swimming Committee for the Olympic Games, was the drafting of a plan for a swimming Stadium. It was clear that none of the open air swimming baths of Stockholm could be used for the purpose, the largest not measuring more than $33\frac{1}{3}$ metres in length, while the International Rules for Swimming Competitions prescribe a minimum length of 100 metres for races above 500 metres.

It was, then, necessary to choose some suitable place in one of the many stretches of water in or around Stockholm. Many sites were proposed and examined. Among them may be mentioned Saltsjöbaden, the inlet at Lindarängen, Lake Mälär above Marieberg, and Lake Råsunda, all of which offered various advantages, but had to be rejected in consequence of the question of communications — a most important matter.

A sub-section of the Swimming Committee for the Olympic Games, specially appointed for the purpose, finally fixed on the waters of Djurgårdsbrunnsviken, (at the foot of the hill called Laboratoriebacken) which offered the greatest advantages, both as regards communications, and also as regards natural facilities for the building of stands along the shores, the erection of the diving platforms, etc., and for the arrangement of the swimming course. In addition, the waters in ques-

tion offered that protection against currents which is required by the rules. On the other hand, there was the objection that the site would not permit the permanent retention of the intended Swimming Stadium, as the town authorities had already begun the laying out of new streets and quays in the neighbourhood, and it was only the great kindness of the Commissioners for D'urgården Park that enabled the

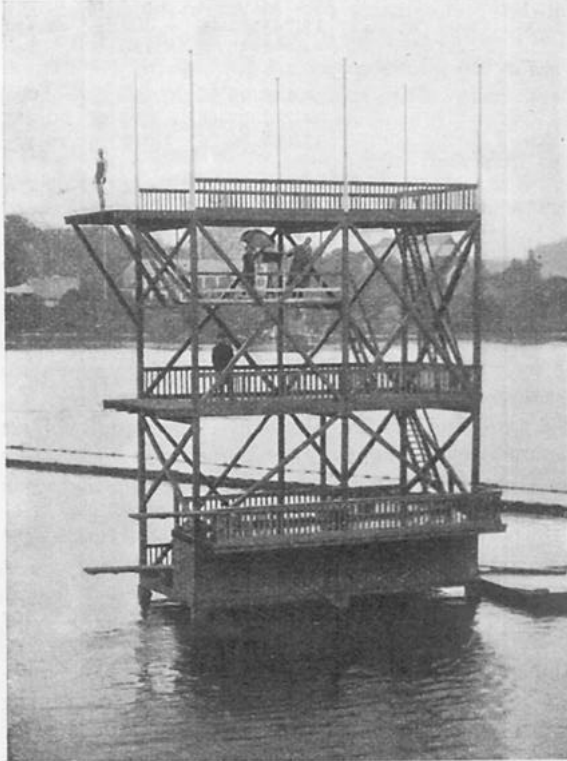

Diving Platforms at the Swimming Stadium.

Committee to make use of the spot for the Swimming and Diving competitions.

By choosing this place, it was found possible to arrange the swimming course in the little bay of Djurgårdsbrunnsviken that runs into Laboratoriebacken Hill, and is thus protected from any currents that may come from Nybroviken. The far end and one side of the future Swimming Stadium were bounded by the land, and the opposite end by a steamboat pier, while, towards the channel, the course was enclosed by a line of pontoons.

The water, it is true, was not quite so clear as that of the Baltic out at Saltsjöbaden, but it was good enough, and had been the scene of former swimming competitions.

In November, 1910, Mr. S. D. Larsson drew up, as requested, a plan of the projected course and stands at this place. The plan, as a whole, was approved by the Swimming Committee, and a special Building Section was nominated, consisting of Mr. E. Bergvall, President, and control-official of the swimming-technical arrangements, Mr. S. Larsson, the constructor and chief of the building operations, and Mr. T. Kumfeldt.

When the financial agreement was made between the Swimming Committee and the Finance Section of the Swedish Olympic Committee, opinions varied as to the size of the intended Stadium, the Finance Com-

mittee considering that it could only advance funds for the erection of a stand seating c:a 1,500 people, while the Building Section of the Swimming Committee wished to have room for about 4,000 spectators. On the same occasion, the Building Section had asked the Finance Committee for a second, considerably increased grant, in consequence of the great interest shown abroad in the competitions.

The wishes of the Building Section were at length complied with, but the Finance Committee laid down the condition that the members of the Section and two other 'good' persons, should give a personal guarantee for the completion of the work in accordance with the plan then shown, and for a sum not exceeding Kr. 31,340 (£ 1,723 : \$ 8,615), and that the members of the Building Section of the Swimming Committee should personally engage to cover any deficit that might arise in the event of the money received from the sale of tickets not being sufficient to cover the building expenses. The amount thus guaranteed is shown by the following list:

Contributed by the Swedish Olympic Committee	Kr. 6,600: —	(£ 363 : \$ 1,815)
Advanced by d.o. and to be repaid from the first receipts.....	» 10,000: —	(£ 550 : \$ 2,750)
Advanced by the members of the Building Section.....	» 14,740: —	(£ 810 : \$ 4,050)
	<u>Total Kr. 31,340: —</u>	<u>(£ 1,723 : \$ 8,615)</u>

Of the eventual profits arising from the Swimming Competitions, after the payment of all building- and other expenses, and after the Swedish Olympic Committee had been repaid Kr. 10,000: — 550 : \$ 2,750) of the building-fund of Kr. 16,600 it had advanced, half was to fall to the share of the Swedish Olympic Committee, and the other half was to be retained by the Swimming Committee. The surplus came to Kr. 23,212: 88 (£ 1,277 : \$ 6,385), so that the Swimming Association received a sum of Kr. 11,606: 44 (£ 638 : \$ 3,190). The following extract may be given of the agreement drawn up between the Finance Section of the Swedish Olympic Committee and the Building Section of the Swimming Committee:

After the direct expenses (the accounts for which must be passed by the Finance Committee) for attendants and similar daily cash-expenditure in connection with the competitions, have been covered, then, of the income arising from the sale of tickets, programmes, etc., first the Swedish Olympic Committee shall receive the sum of Kr. 10,000, after which the Swimming Committee shall be entitled to a sum not exceeding Kr. 14,740, or the smaller sum that may have been expended, under the supposition that the amount has been employed for the said arrangements at Djurgårdsbrunnsviken, in accordance with the estimates given in the report made by Messrs. Kumfeldt, Larsson and Bergvall on the 2 October, 1911. Should there be any surplus after the payment of these sums, it shall be divided equally between the Swedish Olympic Committee and the Swimming Committee. After the conclusion of the competitions, and when the accounts have been closed and passed, that part of the surplus given to the Swimming Committee shall be made over to the Swedish Swimming Association, to be used for the promotion of swimming in accordance with plans approved of by the Committee of the said Association and under the control of the auditors of the Swedish National Association for the Promotion of Athletics.

The Swedish Olympic Committee shall receive not more than 450 complimentary

tickets for presentation to those persons — including the members of the Press — the said Committee considers entitled to be present at the Swimming Competitions.

All the material bought for the competitions shall afterwards become the property of the Swedish Olympic Committee, provided that the Swimming Committee does not lose by the competitions, in which latter case, the Swimming Committee is entitled to receive so much of the net proceeds of the sale of the material as will

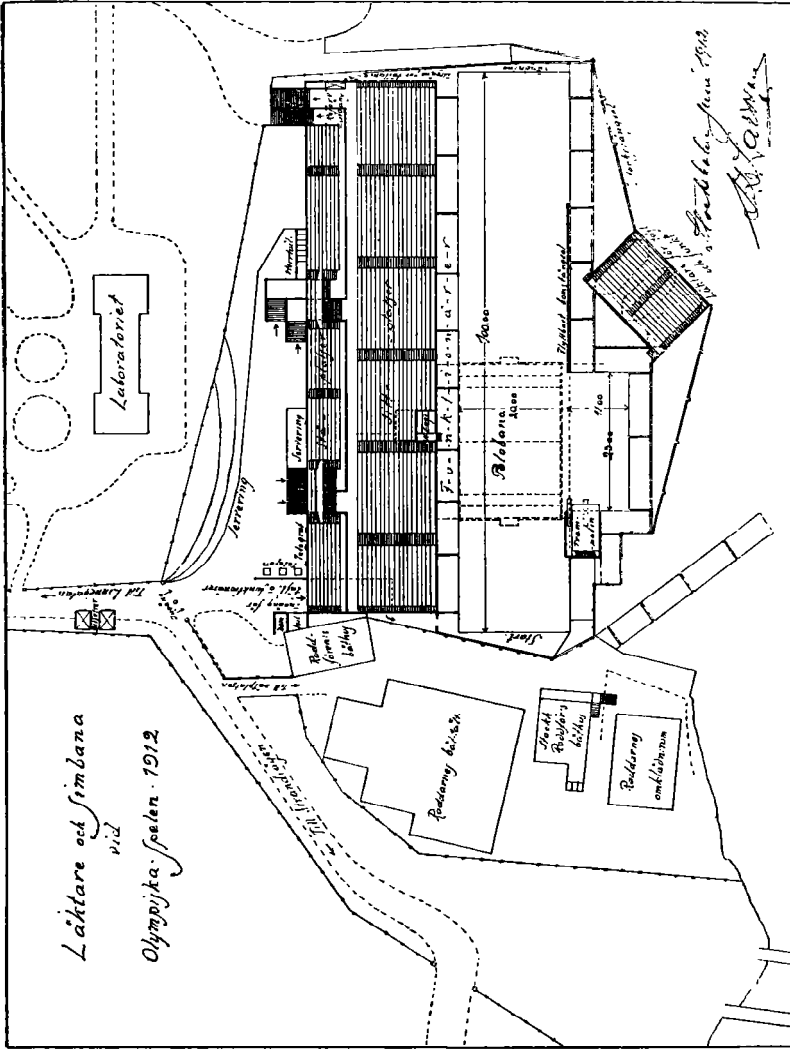

Plan of Swimming Stadium.
 (The shaded portions are the stands. The diving platform is marked "Trampolin").

cover the deficit. The Swimming Committee, therefore, as soon as the competitions are over, shall take steps for the sale of the materials in question, and shall account for, and make over, the sum received, to the Swedish Olympic Committee.

Before any money is paid out by the Swedish Olympic Committee for the building operations, the Swimming Committee shall show a guarantee given jointly and separately by Mr. Johan Olsson (of Olsson & Rosenlund) and Viktor Gustafsson (of Gustafsson, Brothers), for the completion and payment of building-expenses before the

1 July, 1912, of the erections at Djurgårdsbrunnsviken, in accordance with the accompanying drawings and description.

Messrs. E. Bergvall, T. Kumfeldt and S. Larsson hereby engage that the additional amount that may possibly be required for the carrying out of the swimming competitions in accordance with this contract, shall be obtainable at the right time ; that the conditions laid down by the Commissioners for Djurgården for the employment of the site in question for the purpose now intended shall be carried out in every respect, and that all the other stipulations of this contract shall be observed.

It was only a firm belief that the competitions could be carried to a successful issue, and a hope that it would be found possible to obtain a considerable economic surplus, that induced the members of

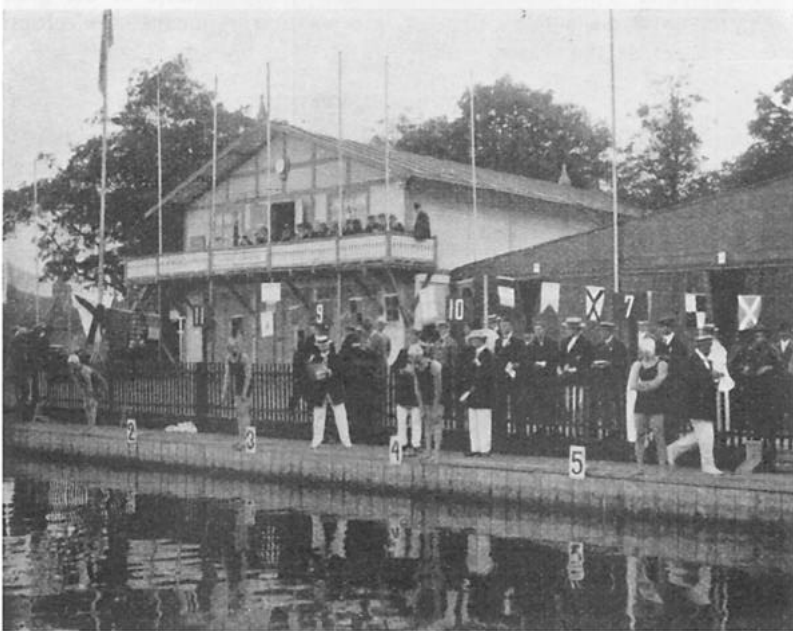

The starting place at the Swimming Stadium, with the Stockholm Rowing Club's boat-house in the background.

the Building Section of the Swimming Committee to undertake the risk incurred by the signing of the above contract. The contract was carried out by both parties, and six weeks after the agreement was signed, the Swimming Stadium was in readiness.

THE SWIMMING COURSE.

When the dimensions of the Swimming Course, 100 met. (the distance for the shortest race) was fixed as the length, 20 met. was taken as the breadth, while the depth was everywhere greater than would cover a man, although in the western part of the basin this depth had to be made artificially, some 400 cub. met. of clay being dredged up. The bottom in this section was afterwards covered with a thick layer of sand, in order to keep the water as clear as possible.

Pontoon bridges were anchored along the sides of the course, the material being kindly supplied by the Municipal Building Office. On the other side an extension was made, enclosed by floating booms, and forming a special bath for the diving competitions.

The starting place for the races at the west end of the course, and the turning pier opposite, consisted of planks, driven into the bottom in a vertical position, and covered by a flooring at a height of circa 30 cm. (about 1 ft.) above the water. In this way, a broad walk was formed around the entire course, which allowed of the unimpeded movements both of officials and competitors.

The Water Polo course was arranged in the middle of the great bath, the goal posts being hauled into position by means of wireropes stretched across the water.

THE DIVING PLATFORM.

The diving platform was arranged parallel with the outer side of the swimming bath, and in front of the bath, (11 met. broad and 23 met. long), intended for the diving competitions. This allowed the diving to be seen from the side, thus giving the very best point of view of all the movements of the competitors in the diving competitions.

The diving platform was built upon 6 poles, about 14 met. long, which had been driven down to a firm bottom and steadied by strong, double cables fastened beneath the surface by divers. The platforms, 5 and 10 met. above the surface, were 4 met. broad and 8 met. long, in addition to which, the lower spring-board, arranged in such a way as to be easily removed, lay 1 met. above the surface of the water below the middle of the platform, while the higher spring-board, 3 met. above the surface, was arranged on a special projecting erection on the inner side.

Between the two fixed platforms a station was prepared for the crier of the starts and for the result-boards.

On the lower platform there was also erected a small cabin, to serve as a shelter for the divers, in the event of the weather being cold or windy.

Access to the different platforms was gained by stairs from the back, which could be completely shut off from the runs by means of barriers.

THE STANDS.

The grand stand was erected along the whole inner side of the bath; its front rested on a row of stout poles, 2 met. from each other, and driven down till they touched the underlying rock. The placing of the front row of pontoons permitted the spectators to have an excellent view of the competitions. The lower part of the stand consisted of 2,700 seats, in 17 rows, 35 cm. (15 inches) above each other, the lowest row of benches lying 1,5 met. above the water. The stand was divided into 6 almost equal sections, separated from each other by stairs, 3 met. broad. Behind the seats ran a passage, 2 met. broad, to allow of the public passing between



TELEGRAPH- AND TELEPHONE-PAVILION, VALHALLAVÄGEN ROAD, OUTSIDE THE STADIUM.

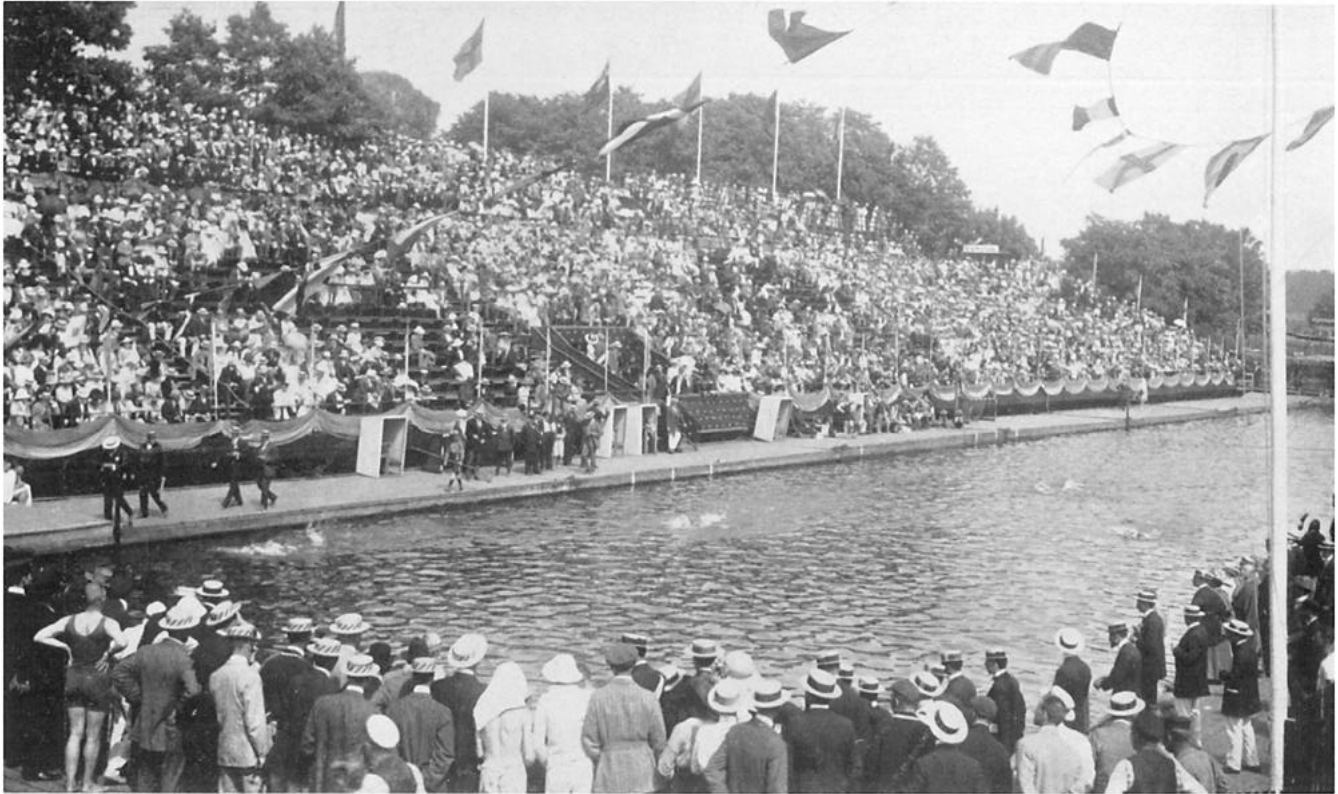

THE SWIMMING STADIUM DURING THE OLYMPIC GAMES OF 1912.



THE ROYAL BOX AT THE SWIMMING STADIUM.

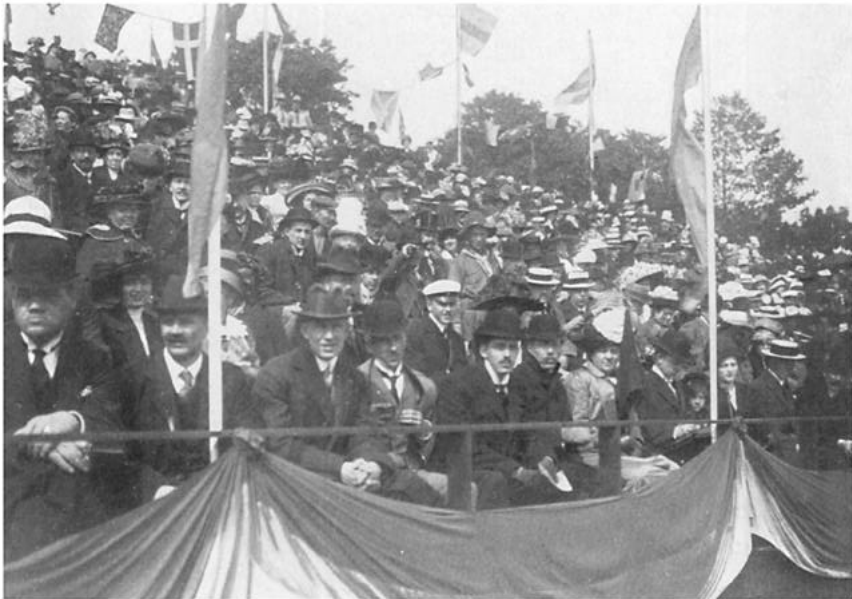

THE PRESS STAND AT THE SWIMMING STADIUM.



THE ÖSTERMALM ATHLETIC GROUNDS.

TO THE LEFT, THE PLAYER'S DRESSING-ROOMS; TO THE RIGHT, IN THE BACKGROUND, THE ÖSTERMALM TENNIS PAVILION.



GENERAL VIEW OF THE RÅSUNDA ATHLETIC GROUNDS.



GENERAL VIEW OF THE TRANEBERG ATHLETIC GROUNDS.



THE ROYAL TENNIS PAVILION: SCENE OF COVERED COURTS COMPETITIONS.

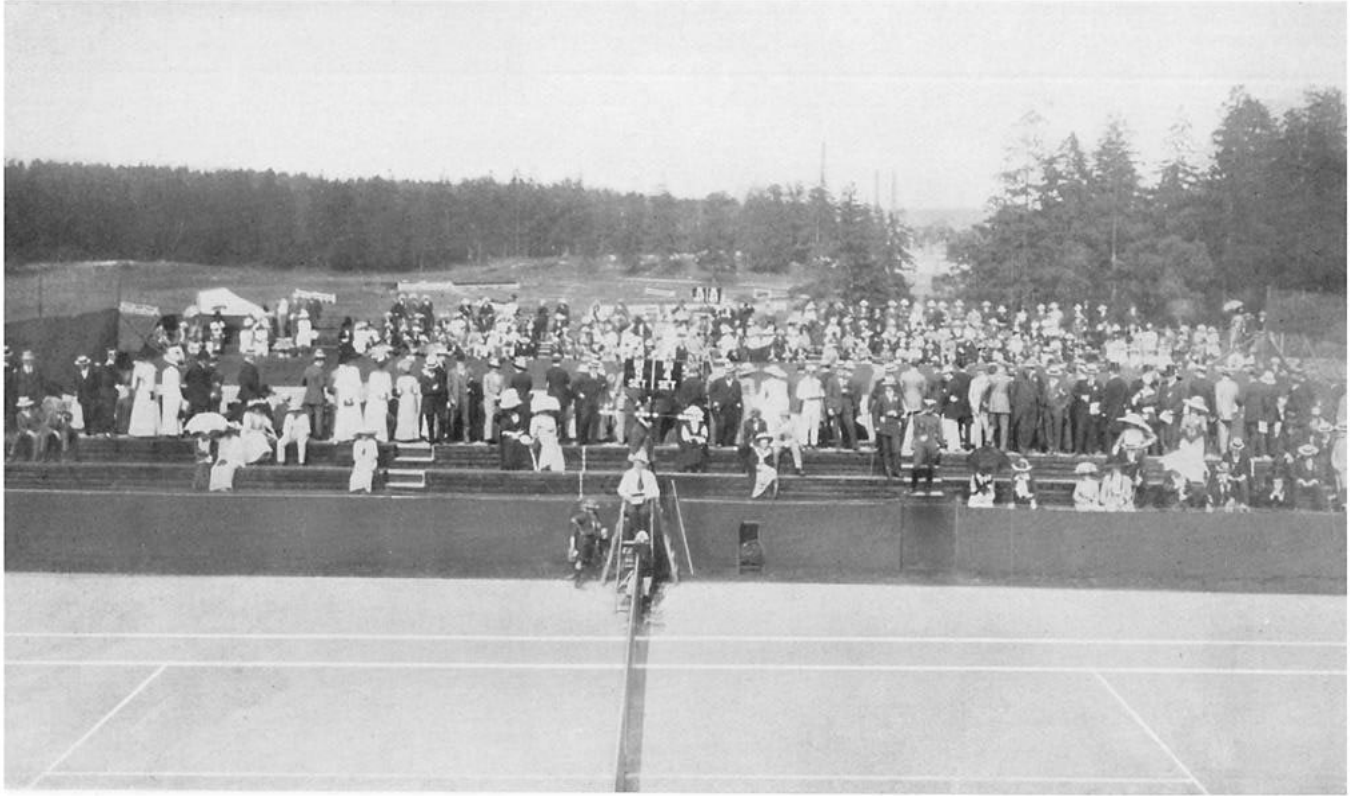

PRINCIPAL COURTS FOR THE LAWN TENNIS OUT-OF-DOOR COMPETITIONS.

the various sections, and then came that part of the erection intended for standing room, the rows being 50 cm. above each other and accommodating c:a 1,000 spectators, the stairs and passages being arranged like those for the seats, and being provided with rails between each row. Access to the spectators' places was gained by means of broad staircases leading from behind the stands and with special entrances to the seats and the standing room accommodation. The staircase was reached from the shore by means of a large spacious platform, on which were arranged telephone kiosks, refreshment booths, etc. Under the stand there were 20 light dressing rooms, one for each nation and supplied with benches and clothes-racks. In addition to this, two club-rooms were erected and furnished, one for ladies and one for gentlemen, besides which there were refreshment rooms, with a kitchen, etc. ; a Press-room ; 3 committee offices, a store room, a telegraph office and lavatories. In the front part of the third section there was arranged the Royal box, with a small foyer, both of which were tastefully decorated with hangings, etc. The Royal box had a private entrance, together with a special staircase to the platform surrounding the course.

On the outer side of the Swimming Stadium there was erected a special stand for the competitors and officials, the building of which was necessitated by the unexpectedly large number of competitors in the swimming events. The stand in question lay almost opposite the diving platform and the swimming course, thereby giving those seated on it a good view of the whole Stadium. It was erected on 3 barges joined together by stout beams, and cost quite a large sum on account of the solidity with which it was built and of the large amount paid for the hire of the barges.

In consequence of the erection of this latter stand, together with a number of other additional building arrangements that it was found necessary to carry out, the cost of the erection of the Swimming Stadium came to Kr. 39,157: 39 (£ 2,153 : \$ 10,765), the extra expense being approved of by the Swedish Olympic Committee, however, and this so much the more as the additional erections made it possible to sell a considerably larger number of tickets, while the cost of erecting the stand and the course according to the first estimates was reduced to a sum considerably below the maximum figure of Kr. 31,340 (£ 1,723 : \$ 8,615), fixed in the agreement before mentioned.

The public was admitted to the Stadium through gates on Laboratoriebacken and also, by kind permission of A. N. H. Wahlgren, Esq., Director of the School of Forestry, through the Park belonging to this institution, direct from Strandvägen.

The entire Swimming Stadium was surrounded by a high fence, and by a boom placed on the open side of the baths.

A short time after the last stroke of the swimmers and the final plunge of the divers, this Swimming Stadium fell before the axes of the carpenters and was levelled to the ground, but, although it had been built for the moment only, it has left pleasant, happy memories in the hearts of all Swedish friends of the art of swimming.

OTHER COMPETING PLACES.

ÖSTERMALM ATHLETIC GROUNDS.

A number of improvements and alterations were made at the Östermalm Athletic Grounds, especially, as regards the jumping- and running tracks, so that, before and during the Games, the foreign and Swedish athletes had a first-class training ground at their disposal. The cost of the special improvements of the tracks amounted to Kr. 10,359: 10 (£ 569 : \$ 2,845), other supplementary work coming to Kr. 7,272 : 45 (£ 400 : \$ 2,000).

The place was in great need of repairs; the tracks were worn out and uneven, while, here and there, stones could be seen sticking up

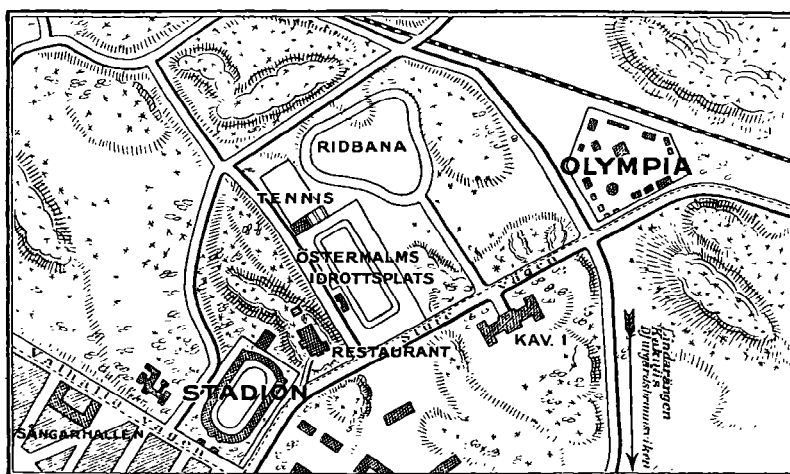

Map of the immediate neighbourhood of the Stadium, showing the Choir-Hall, the Östermalm Athletic Grounds, the Riding Grounds and the Olympia Pleasure Gardens.

above the surface. As early as in the autumn of 1911, both the lower football fields were levelled and reconstructed; the slopes and lawns were re-arranged, while trees and bushes were planted along the paths leading to the gasworks and the "Planterhagen" (tree-nursery). The running track, etc., after having been reconstructed, was damaged by being covered with water during the winter of 1911-12.

The real work of altering the grounds did not begin before the spring of 1912, as soon as it was possible to do anything with the saturated ground. The old jumping pits and start-pitches were levelled and new ones were constructed, and the running track, which consisted of a crust formed of fine stone-waste, was reconstructed of slag, with a surface-composition of screened slag from the Electric Works, mould and marl. For economical reasons, it was not possible to make the slag-bed more than 5 cm. thick, and the surface-coating

only 3 cm. deep. The proportions of the various ingredients of the surface-composition were as follows : fine-screened slag 50 % ; fine-screened rich mould 30 % , and good, sand-mixed marl 20 %.

After the slag had been spread out, it was gone over with a horse-roller, 5 tons in weight. On top of this layer there was then spread the surface-composition, and after the latter had been levelled by means of a rake, the roller was drawn round the track until the surface was sufficiently firm and even. In spite of the thinness of the outer coating, and of the little care that could be devoted to this track, it kept in good condition, both during the training period and for the remainder of the athletic season of 1912.

At the same time that the running track here was relaid, the large central arena was provided with a timber ledge, similar to that at the Stadium. The paths and the upper football ground were also repaired. During the winter, a provisional running-track of wood, 200 m. long, had lain on this football ground, and after this was taken away the place was levelled and covered with gravel, while a rocky projection in the north-eastern corner was turned into a grass-covered stand for spectators.

On the slope below the tennis courts there was erected a high stone wall, more than 4 met. high, and close against this a store-house 40 met. long. At the eastern end of the wall there was built a flight of steps, leading up to the higher tennis-plateau and affording a means of communication between the upper and the lower tennis-courts.

The pavilion of the Östermalm Athletic Grounds was also in need of repairs, which were carried out thoroughly, and the building was repainted, both inside and out.

The beautiful, principal entrance to the old Athletic Grounds and its two ticket-offices were now conveyed to the Planterhagsvägen, and were repaired and repainted. Two other ticket-offices, also from the old Athletic Grounds, were repaired and re-erected, one of them at the entrance to the tennis pavilion, and the other at the Sturevägen entrance to the grounds.

Dressing Rooms elsewhere than at the Stadium.

As stated previously, a large number of dressing-rooms for competitors were provided at the Stadium but, owing to the great number of gymnasts coming to the Games, it was found necessary to take the riding-hall near the Stadium and turn it into dressing-rooms.

In this connection may be mentioned the erection of the Choir Hall at the Primary School, Valhallavägen, quite near the Stadium, and the forming of the Olympic Pleasure Gardens, at Sturevägen.

LAWN TENNIS.

The old tennis pavilion from the former Athletic Park, which had been moved to the Östermalm Athletic Grounds, was made use of during the lawn-tennis out-of-door court competitions, its dressing rooms doing good service during these events.

The Tennis Pavilion at the Östermalm Athletic Grounds was completed during the winter of 1911, and then let by the Swedish Central Association for the Promotion of Athletics to a member of the Swedish Olympic Committee, which body determined to make two out-of-door courts just outside the Pavilion, thus assuring the holding of Olympic Lawn Tennis out-of-door court competitions. Two stands, seating 1,500 persons, were erected round the courts in question, but at the end of May there was only one court ready, and when entries closed, on the 29:th, it was found that two courts would not suffice for the great number of competitors. Such an event had been foreseen, however, and sites for two additional courts were already provided. Three of the courts were intended for the matches and the fourth for training. The courts were laid with "Adekvat", a mixture of coal-tar and limestone-tailings, with a thin layer of sand on top.

A number of alterations in the Royal Tennis Pavilion near the Stadium had to be carried out, to prepare the place for the Olympic Covered Court Competitions held here in May.

FENCING.

The Tennis Pavilion at the Östermalm Athletic Grounds was chosen as the scene of the fencing competitions, and it proved to be an ideal one. The two tennis courts, which lie there side by side, gave the four pistes, each of which measured 2 metres by 33 metres, together with a sufficient intermediate space where the jurymen could move about without hindrance. The pavilion also allowed of the erection of stands, each of two rows, along the middle and the sides of the hall, and seating altogether 400 spectators. The pistes were bounded by low posts, supporting ropes which separate them from each other and from the spectators. The interior of the hall was decorated wherever possible, the whole offering a very inviting appearance with its simple, yet richly coloured decorations.

The épée competition of the Modern Pentathlon was fought out on the new out-of-doors tennis courts, which, without any very special preparations, satisfied all the demands made on first class fencing-grounds.

As far as regards the arrangements necessary for the personal convenience of the competitors, such as dressing-rooms, lavatories etc. those already existing in the tennis pavilion proved quite sufficient and satisfactory.

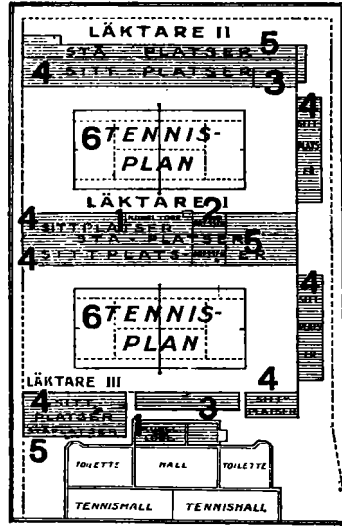

Plan of principal lawn tennis courts for out of door competitions. Two other courts were constructed by the side of these, but were without stands for the spectators.

1. The Royal Box. 2. The Press. 3. Seats for the Competitors and the Officials.
4. Seats. 5. Standing-room.

FOOTBALL.

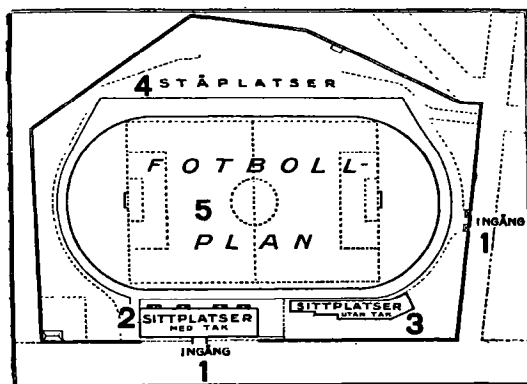

Plan of the Råsunda Athletic Grounds.

1. Entrance. 2. Covered Seats. 3. Open Seats. 4. Standing-room. 5. Football Ground.

ced a sum of Kronor 33,600 (£ 1,840 : \$ 9,240) for the purpose, the Football Committee thereby being able to carry out the work mentioned above, and to make the grounds first-class ones.

For the football competitions it proved necessary to make use of three grounds, viz., that at the Stadium, and the Råsunda and Traneberg Athletic Grounds. It was absolutely necessary to make a number of changes and improvements, and to erect extra stands, before the two latter grounds could be considered as being in really good order, and the Swedish Olympic Committee advanced

HORSE RIDING COMPETITIONS.

For these competitions, special measures had to be taken to put the course of the Field Riding Club in proper order, and stables for the horses of the competitors had to be made ready in the vicinity of the place where the events were to be held. For this purpose, permission was obtained from the Fortification Department to turn the so-called "summer stables" of the Svea Artillery Regiment into stables for the horses from abroad, the place being supplied with boxes, accommodation for the grooms, etc.

THE BOAT HOUSE AND STANDS FOR THE ROWING COMPETITIONS.

In the spring of 1912, the Rowing Committee devoted its attention to the solution of the problems of the erection of a boat-house, and of providing training-quarters for the competitors. The Committee had nothing at its disposal but the boat-house of the Stockholm Rowing Club and the very small plot of ground attached, while the fact that the Swimming Stadium was erected in the immediate vicinity of the boat-house, and that a part of the grand stand there crossed the path running down to the boat-house, did not tend to make the problem a lighter one.

The Rowing Committee entrusted Mr. Walfrid Clemens with the task of making the arrangements for the boat-house, and, in accordance with his plans, a marquee was put up, lying in a direct north and south direction from the already existing boat-house, and with the east side open, and the west side closed. This tent was 30 metres long

and of sufficient depth to house the big eights and the numerous fours and sculls expected to the Regatta. Altogether, there was space available for 16 eights, 23 fours and 14 single sculls. The boats were taken out by the crews through the open, east side and carried down to the pontoons, five in number, which lay in a row, in a south-easterly direction from the quay in front of the boat-house.

For the crews, there was erected in the boat-house grounds, south of the boat-house, a large tent with a passage down the middle, to the left and right of which were the entrances to the dressing rooms, each of which was intended for 14 men and was marked with the flag of the nation for whom it was intended. Each dressing room was provided with wash-hand basins, while other toilet necessities, soap, brushes and combs and towels, could be had gratis from the attendants. A shower-bath was put up at the far end of the tent,



View of Djurgårdsbrunnsviken and the Rowing Course.

with a pump for obtaining water from the Djurgårdsbrunnsviken, the piping being carried far out into the inlet, so that fresh, clean water could always be had.

The Djurgård Park Commissioners kindly allowed the Rowing Committee to use a plot of ground outside the limits of the boat-house property, for the purpose of storing there the vast amount of packing-cases, etc., for the boats and other rowing material brought to the Regatta by the foreign crews.

The Rowing Committee's difficult task of providing dressing rooms and boat-houses for the many competitors from abroad, was thus solved satisfactorily, but stands for the many thousands of spectators that were expected to view the races had also to be provided. Permission was, therefore, obtained from the civic authorities, to erect a large timber stand, stretching along the Strandvägen Quay, from Djurgårdsbro (bridge) to Torstensongatan, and seating some 5,500 persons.

SHOOTING.

Divers arrangements and repairs, etc., were carried out at the ranges at Kaknäs, where the shooting competitions with rifles of any type, and at distances varying between 200 and 600 metres, were to take

place. Suitable ranges had to be prepared for the miniature rifle- and the pistol- and revolver competitions, as there existed no range for the events in question. After a spot which was very suitable for the purpose had been chosen at Brunsgägen, in the northern part of the Kaknäs district, and permission had been obtained to hold the competitions in question there, the place had to be fenced in, and other arrangements made, such as the erection of butts, target-holders, marker's huts etc. The same remarks apply to the preparations for the miniature rifle- and pistol shooting, and for the Running Deer shooting competition.

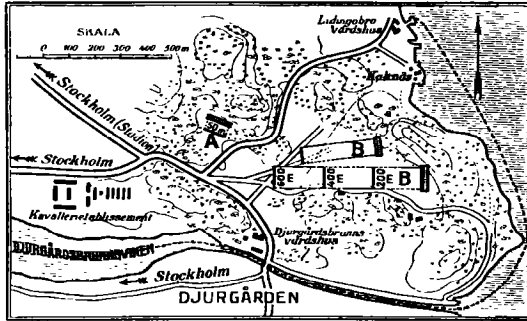

Plan of the ranges for the rifle- and pistol shooting competitions.

- A. Range for Miniature Rifle- and Pistol shooting.
- B. Range for Rifle shooting,

An entirely new range, with all the necessary details, for the Clay Bird and Running Deer shooting, had to be made at Ellenhill, Råsunda, where ground for the purpose was kindly offered by the Råsunda Residential Estate Co.

Before the competitions began, the ranges at Stora Skuggan were placed at the disposal of the marksmen in training, and the Kaknäs



View from Nynäs, the scene of the Olympic Yacht Racing.

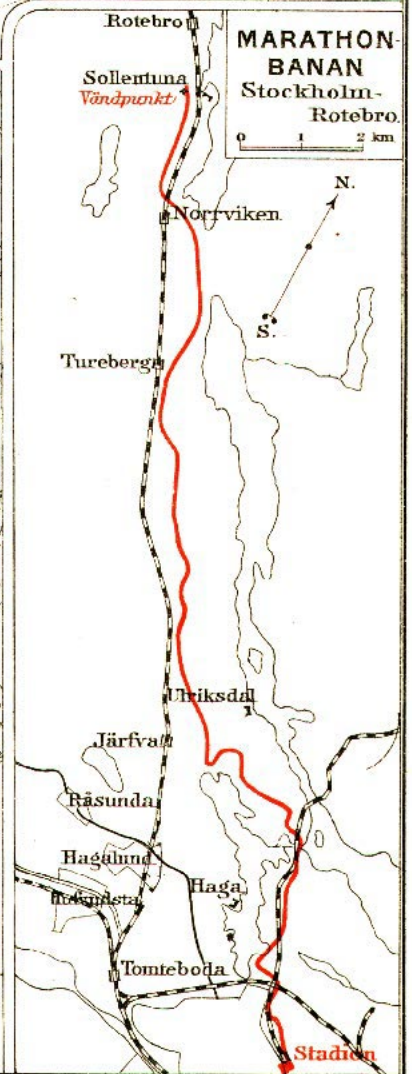
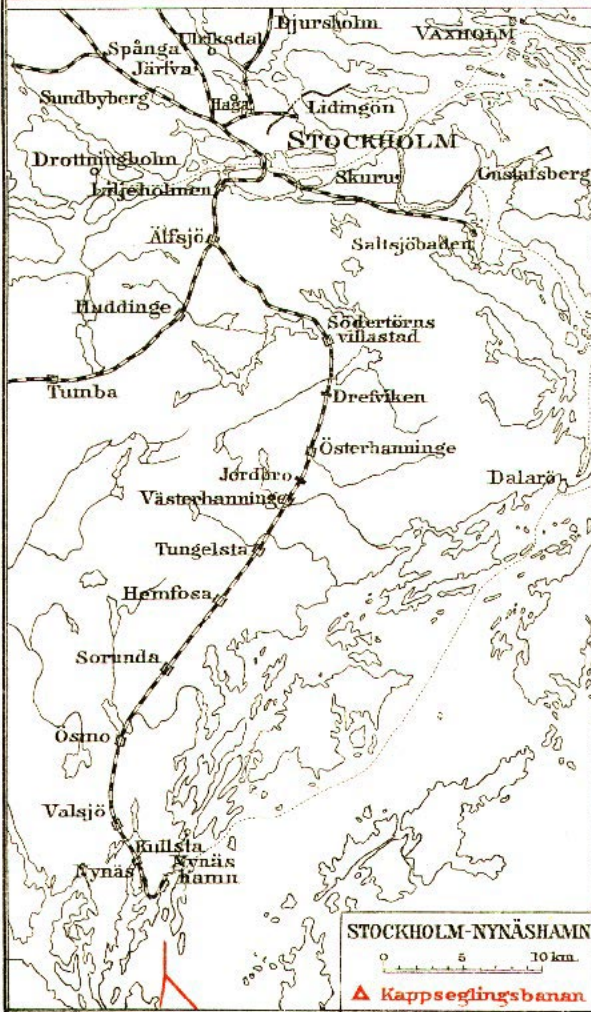
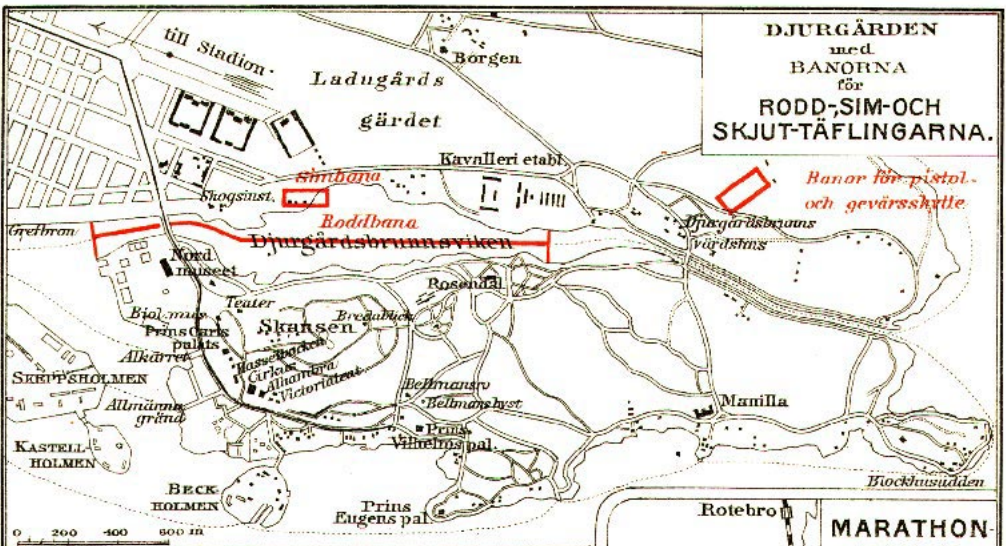

PLANS of: The Rowing Course; the Swimming Course; the Shooting Ranges.

MAPS of: 1) Railway route, Stockholm—Nynäs hamn, and of the Yacht Racing Course.

2) The Route for the Marathon Race.

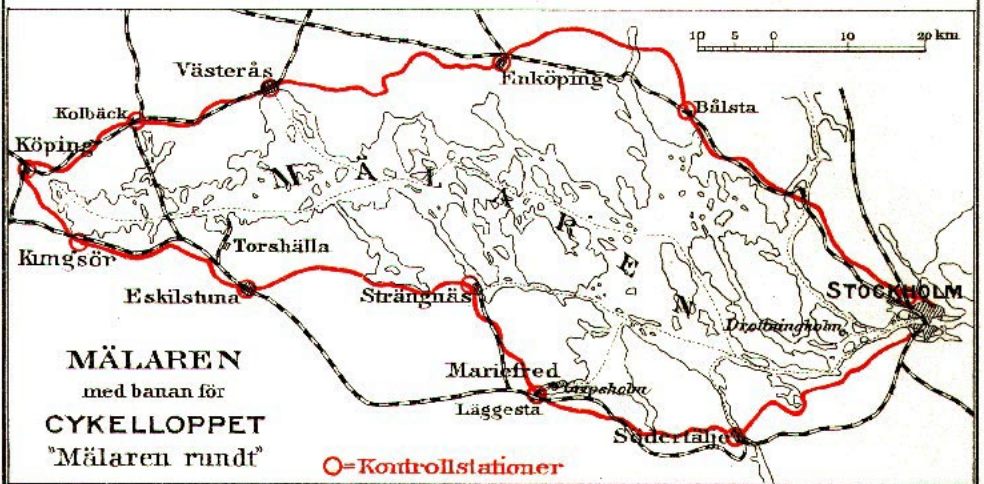
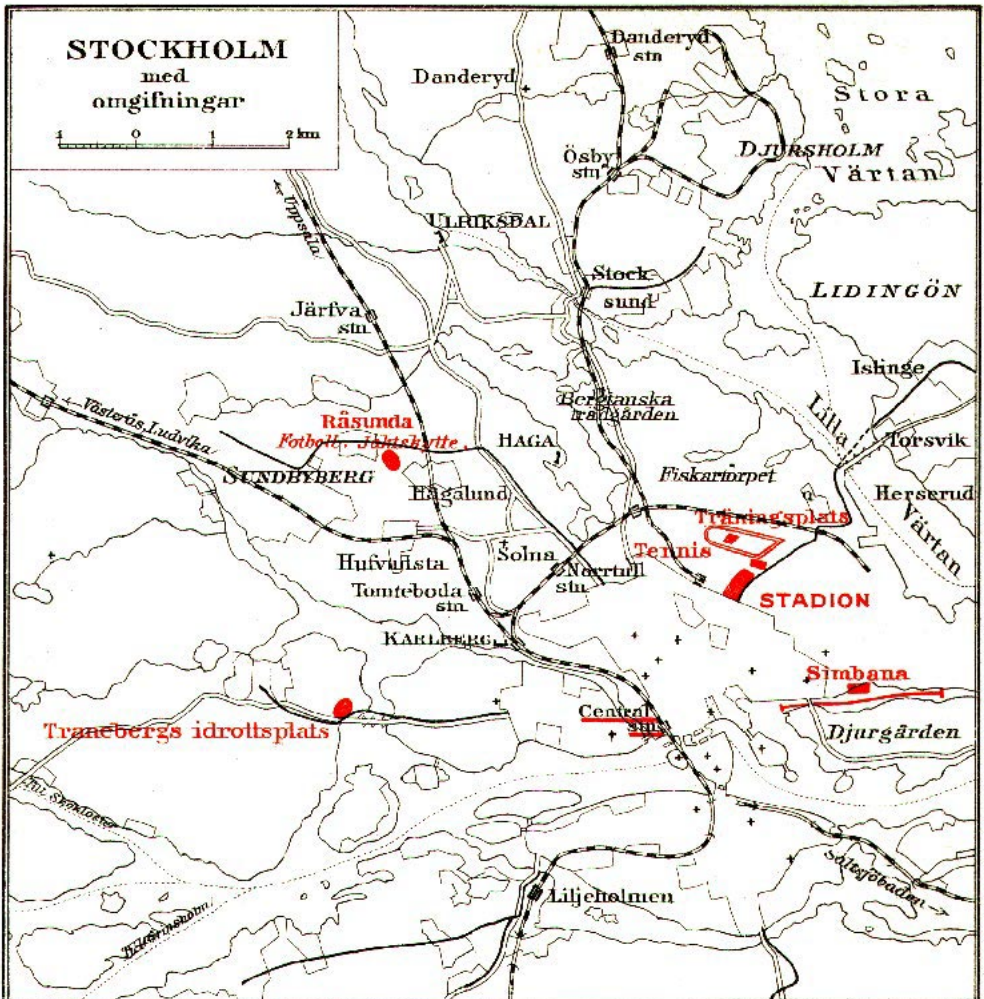

MAPS of: 1) The environs of Stockholm, showing the places where the Olympic Competitions took place. 2) The Cycle Course Round Lake Mälaren, showing the Control-Stations.

pier, so as to berth the smaller yachts taking part in the regatta. The Yacht Racing Committee also succeeded in obtaining improved telephone and telegraphic communications between Stockholm and Nyhåshamn and Sandhamn, this step remedying an inconvenience which had previously been felt very severely.

* * *

All this mass of building and repairing, etc., caused the Swedish Olympic Committee no little expense, the erection of the Stadium and the improvements at the Råsunda, Östermalm and Traneberg Athletic Grounds, together with the moving of the tennis pavilion from the old Athletic Park, coming to a total of Kr. 1,359,239:69 (£74,758: \$ 373,790), while the income derived from funds and contributions amounted to no more than Kr. 1,339,019:97 (£73,646 : \$ 368,230) so that a sum of Kr. 20,219:72 (£1,112 : \$ 5,560) had to be taken from the money received from the sale of tickets, to cover the deficit. To counterbalance this, however, the Swedish Athletic movement has gained most considerably by these various grounds in, or near, Stockholm, having been put in first-class order.

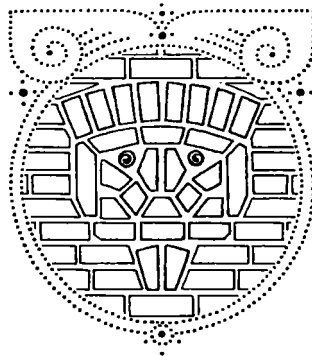

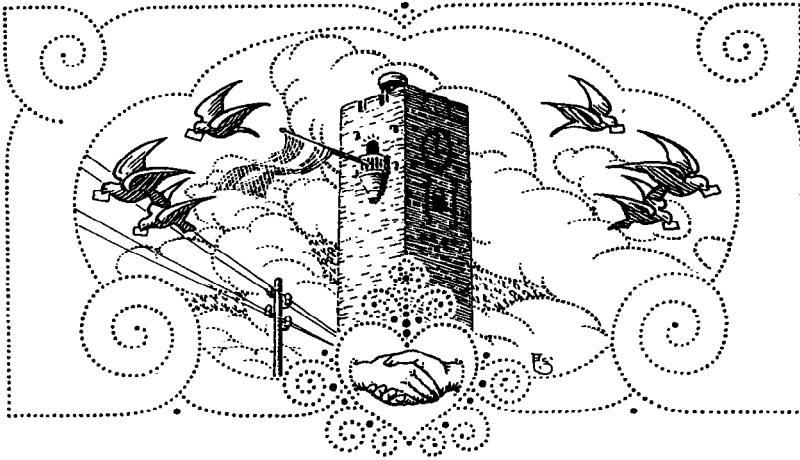

THE ARRANGEMENTS MADE FOR THE RECEPTION AND ACCOMMODATION OF COMPETITORS, ETC.

Report issued by the Reception Committee.

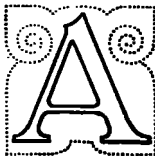

fter Captain Erik Frestadius had been appointed President of the Reception Committee by the Swedish Olympic Committee, a scheme of work was drawn up by him during the summer of 1911, in conjunction with the future secretary, Director Nils Lundgren. The Committee was afterwards augmented so as, finally, to include the following members :

- | | |
|-----------------------|--|
| <i>President:</i> | Captain ERIK FRESTADIUS. |
| <i>Secretary :</i> | NILS LUNDGREN, Esq. |
| <i>Other Members:</i> | BERNHARD BURMAN, Esq.
GUNNAR FRESTADIUS, Esq.
Colonel, Baron S. D. A. HERMELIN.
Baron C. O. A. KOSKULL.
Lieut.-Colonel A. MURRAY.
Baron F. RAMEL, Cabinet Secretary.
Captain CARL SILPVERSTOLPE. |

The Committee had its first meeting on September 29, 1911, and met, altogether, on 32 occasions.

The offices of the Committee were at 4 Norrmalmstorg, Mrs. Dagmar Waldner being the chief of the clerical staff there.

During the first week of the Games, 15 persons were kept extremely

busy at the offices the whole of the day. The labours of the Committee and the staff were greatly lessened by the Committee managing to obtain 38 persons, 3 of them ladies, who disinterestedly officiated during the Games as hosts and hostesses for the foreign athletes present in Stockholm.

The 38 hosts and hostesses were:

Consul N. F. Östberg	Australasia.
Captain Axel Kindberg	Austria.
Captain, Count Thure Bielke	»
Thor Thörsleff, Esq.	Belgium.
Axel Rosin, Esq.	Bohemia.
G. Poppius, Esq.	Canada.
Captain Arne Winroth	Chili.
Captain Gösta Drake	Denmark.
H. Hennichs, Esq.	»
Miss I. Fick	»
Hampus Huldt, Esq. ..	Finland.
Miss M. Janse	»
C. A. Heijl, Esq.	France.
Sven Blom, Esq. B. A.	»
C. J. A. Isaksson, Esq. C. E.	Germany.
Lieut. af Ekström	»
John Hammar, Esq.	Great Britain.
Eric Brolin, Esq.	»
F. Lagercrantz, Esq, B. A.	»
Dr. Michel E. Chryssafis	Greece.
Captain Victor Unander	»
Jac. Bosman, Esq.	Holland.
Captain Fale Burman	Hungary.
Eric Nyqvist, Esq.	»
Captain, Count Harald Spens	Italy.
Thorsten Scholander, Esq. C. E.	Japan.
Lieut. Balzar Knafve	Luxemburg.
Axel Hultman, Esq.	Norway.
Miss E. Bruun	»
Lieut. Adolf Lindroth	Portugal.
Lieut. P. O. Silfverskiöld	Russia.
Lieut. Hugo Hedendahl	»
Captain V. Landegren	Servia.
Captain Nore Sköld	South Africa.
Gustaf Ternström, Esq.	Switzerland.
Svante af Klinteberg, Esq. C. E.	U. S. A.
M. Liewen Stiemgranat, Esq, C. E.	»
Karl Holmsten, Esq.	»

The Directors of the Royal State Railway were kind enough to grant free railway passes to those "nation hosts" who were able to meet their respective nations at Malmö, Trelleborg or Gothenburg.

In order to supply the information that was not actually in the

province of the Reception Committee, an Information Office was opened, also at 4 Norrmalmstorg, of which Mr. Lundström, C. E. was the head, he being assisted by two ladies.

In order to still further oblige visitors from abroad, the Committee took such steps as made it always possible to obtain at the office the addresses of guides and interpreters who gave their services free of charge. An agreement was made with the Nya Aktiebolaget Tjänders Byrå, by which this Company undertook to procure guides and interpreters who wished to be paid for their services. Mr. Sidenbladh very kindly induced 120 undergraduates to act as stewards at the Stadium during the progress of the Games. Thanks to these stewards, who, on every occasion, most willingly gave every possible information or advice, visitors had probably not the least difficulty in obtaining the help they desired. In addition to these stewards there was a number of boy scouts and Varingian guards under the command of Messrs. B. E. Lithorin and E. Wemström, for the purpose of giving necessary aid to the public.

The Committee also took steps to assist visitors from abroad by procuring badges in the colours of the various nations. These badges, which were of enamel, were fastened to the lapel of the coat and showed that the bearer could speak the language of the country whose colours he wore, and was ready to be of assistance if any information was required. Such flags were issued to persons knowing English, French, German or Russian, and about 1,000 were bought by policemen, railway- and tramway officials, and other persons.

The City Club, the "Stora Sällskapet" Club, the Military Club and the Swedish Clerks' Association, were kind enough to comply with the request made by the Committee to issue a number of member's cards, entitling the holder to enjoy all the privileges of membership.

The most important work carried out by the office was that of registering all the information and communications received by, not only the Swedish Olympic Committee, but also by the sub-committees, respecting the honorees, officials and competitors expected here from abroad. The first thing that had to be done was to calculate the *number* of visitors expected, then to learn the *names* and *titles* of these persons, their *addresses at home* and *in Stockholm*, etc. All this was entered in such a way that it was always possible to give reliable information respecting the persons taking part in the Games.

After the register had been compiled, the Committee drew up proposals for the invitations to the entertainments that were to be given by His Majesty the King, Their R. H. the Crown Prince and Princess, Prince Wilhelm and Prince Carl, the Minister for Foreign Affairs, the Swedish Olympic Committee, etc. The reader is referred to the section respecting "Festivities" for a report of the Reception Festivities at the Grand Hotel, on July 7 ; of the Athletic Festival at Skansen on July 9, and of the Farewell Festivities at the Stadium on July 14.

Report of the Accommodation Committee.

When the Swedish Olympic Committee saw that the question of accommodation, originally intended to be solved by the Reception Committee, began to demand such a length of time for its solution that it was absolutely necessary to have a special committee for the purpose, a special Accommodation Committee was appointed in the autumn of 1910, consisting of the following persons:

President : Captain OTTO BERGSTROM.
Secretary : CARL FRIES, Esq., B. A.,
Other Members : KRISTIAN HELLSTROM, Esq.,
NORE THISELL, Esq.,
Colonel, Baron SVEN HERMELIN,
O. W. WAHLQVIST, Esq.,
W. EKSTRÖM, Esq.

The Committee held its first meeting on the 11 May, 1911, the wide scope of its labours necessitating its opening a special office at 4 Norrmalmstorg, Stockholm, in February 1912.

Preparatory Work.

The purpose for which the Accommodation Committee had first been appointed was to obtain rooms for Olympic competitors, members of committees, officials, and the like. This work was carried out chiefly on two principal lines; the obtaining of accommodation at a low figure in barracks and schools, and of higher-priced rooms at hotels, pensions, etc.

In order to be able to make the necessary arrangements as quickly and as extensively as possible, the Committee, by means of a circular sent through the Swedish Olympic Committee to the various nations taking part in the Games, inquired whether the various national Olympic Committees wished to take advantage of the services of the Accommodation Committee for the purpose of obtaining rooms and desiring the said Committees to state, as nearly as possible, the exact number of competitors for whom accommodation was required, their classification in of various branches of athletics; the period of their stay in Stockholm, and the kind of accommodation wanted. These points had to be carefully filled in on the form accompanying the circular, and it was specially pointed out that the low-priced accommodation embraced lodging only. An answer was requested by the 1 October 1911, at the latest.

The Committee then began the most laborious task of classifying all the hotels that could be made use of in Stockholm, at the same time obtaining information as to the number of guests these houses could receive, the probable prices that would be demanded during the Games, the possibility of obtaining board, etc.

The cheaper forms of accommodation.

In order to obtain cheaper forms of accommodation, it was found necessary to carry through the measures already begun for obtaining permission to use the South Barracks and a number of schools. The result was that the State Finance Department gave the Committee permission to employ the barracks in question and the following schools — the Norra Latinläroverket; the Norra Realläroverket and the Östermalm Högre Allmänna Läroverk — for billeting purposes.

The use of the *South Barracks* was granted for the period June 29–July 5, for 415 competitors, and between July 6—July 15 for 575 competitors, on the payment of 2 kr. (2 s. $2\frac{1}{2}$ d.: 54 cents) per person, irrespective of the number of nights spent by each at the Barracks, in addition to which, 25 öre ($3\frac{1}{4}$ d.: 6–7 cents) was to be paid for every bed supplied but not used.

Billeting in the *Norra Latinläroverket* was granted for 105 persons during the period July 6—July 15, the only payment asked for being the cost of cleaning.

Accommodation was obtained at the *Norra Realläroverket* for 200 persons during the period July 6—July 15, the on following conditions : suitable remuneration to the doorkeeper (janitor) of the school; payment of the cost of cleaning; no smoking indoors to be allowed.

Respecting the *Östermalms Högre Allmänna Läroverk*, the reply was that if, in the old buildings, the rooms required were not already let for the period July 6—July 15, there would be no objection to billeting 200 persons there. If this could not be done, accommodation, if absolutely necessary, would then be provided in the new school-house.

The Directors of the *Royal Gymnastic Central Institute* granted permission for some 80 gymnasts (preferably women-gymnasts) to be accommodated in the building during the Games, on condition that the necessary steps were taken to prevent damage to the building and materials of the Institute; that all expenses should be paid by the Committee, and that, after the departure of the guests, the premises should be placed in their original condition.

The negotiations with the *School Board of Stockholm* which has the disposal of the Primary Schools of the city, led to the Committee being granted permission, on certain conditions, to employ the schools 54 Linnégatan, 34 Mariebergsgatan and 44 Tegnérsgatan. An agreement to this purpose was made between the School Board and the Swedish Olympic Committee.

No beds, etc., had to be obtained for the South Barracks where, of course, everything has to be in constant readiness for the reception of soldiers. The first measures the Accommodation Committee took to put the school premises in order were to obtain permission to borrow a quantity of bedding, etc., from the Royal Military Commissariat Department. A Royal Ordinance, dated the 22 December, 1911, gave the Committee leave to borrow from the Crown-stores, for a period not exceeding two months, reckoned from the 1 June 1912,

1,500 beds, 1,500 blankets, 1,500 pillow-cases, 1,500 mattresses, 3,000 towels and 500 washhand-basins.

In addition to this, the *Red Cross Society* kindly granted the Accommodation Committee permission to use 500 pair of sheets from its stores, free of charge. Immediately before the beginning of the Games, the Society placed the Committee still further in its debt by granting it the free loan of some 80 excellent, new mattresses.

Correspondence with the foreign delegates.

Replies came in very slowly indeed to the above mentioned circular respecting accommodation, which had been sent both to the various Swedish sub-committees and to the Olympic Committees of the nations taking part in the Games, and when at last they were received they were found to be written in very vague terms, and so were of little use. In the answers, the great difficulty was pointed out of being able to give exact figures at such a length of time beforehand, as the try outs which were to determine the strength of the various Olympic teams were, of course, to take place at a much later date and, in addition to this, the question of money had to be settled before a decided answer could be given. In some case there was but little hope of being able to obtain State-aid, and even in those instances where there were hopes of obtaining such support, some time would certainly elapse of longer or shorter duration — before the money in question would be finally granted. For example, the French Chambers granted the money only a couple of days before the French team started for Sweden. All this, of course, delayed the work of the Accommodation Committee, and greatly increased the difficulties under which it laboured, and it sometimes happened that what were considered definite agreements had to be broken, and new steps taken to provide for the accommodation asked for.

The greater number of the arrangements with abroad were made by correspondence, but some of the foreign committees sent representatives here, who, in addition to a number of other questions, had also been entrusted with the task of obtaining rooms, etc. for their teams, this latter matter, therefore, being settled in principle during the presence of the above-mentioned delegates here in Stockholm, the details being completed later on by correspondence. The first foreigner that came for the purpose mentioned was the Reverend de Courcy Laffan, Hon. Secretary of the British Olympic Association. He was followed by Herr Julius von Musza, representing Hungary; Professor Jiri Guth and Herr Rössler-Orovsky, Bohemia; Drs. Herschmann and Abeles, Austria; Captain Johan Sverre and Lieutenant Frölich-Hanssen, Norway; Dr. Martin, Germany; Herr Karl von Reisner, Russia, and Mr. Pierre Roy, France, who were given all the assistance and information that lay in the Committee's power. For the contingents from the nations represented by these gentlemen, accommodation was obtained principally in hotels and pensions, but, at the same time, it was pointed out by the representatives that, for a number of the men,

it would be necessary to make use of the lower-priced accommodation arranged by the Committee.

At the request of France, however, special arrangements were made for its team, differing a little from those made for the other nations. Some of the French competitors wished, it is true, to stay at a hotel or a pension, but what may be called a modification of the cheap accommodation was to be provided for the greater number of the French competitors, who obtained permission of the Committee to have the use of the necessary number of rooms in the Adolf Fredrik Primary School, 44 Tegnérgratan, on condition that the team itself paid for the necessary furniture and its carriage to the place, and for the cleaning, etc., of the premises. Unavoidable alterations, etc., necessitated a lively correspondence with the other Olympic Committees, both those that had sent representatives, as above mentioned, and with the others, with whom the question of accommodation had to be arranged exclusively by correspondence.

Respecting hotel and pension accommodation, it was necessary to obtain such as could be considered the most suitable, and to have the disposal of the rooms in question, so that there would be possibility of obtaining quarters for all those expected to ask for such accommodation. All possible regard had to be paid to the special wishes of the various nations, this not least as regards prices. Then there was the difficulty, already mentioned, that the various nations were not able to state in good time, the exact number of those for whom accommodation would be required, nor the precise period for which it was wanted. All these arrangements demanded personal visits and a vast amount of telephoning and letter-writing. As there was every reason to expect a large number of visitors, it was necessary to make, if possible, early preparations for the competitors and officials coming to the Games, before prices were raised, and the Committee, which, as time went on, sent several reminders to the parties concerned, endeavoured, during the winter and spring of 1912 to make the final arrangements in the matter of the hotels and pensions, before taking in hand the question of the lower-priced accommodation in the barracks and the schools.

One contingent — not, it is true, relatively large but, still, a very important one — for which accommodation had to be provided, was the International Olympic Committee, and a circular was sent to the various members asking whether they wished to have the assistance of the Committee in order to obtain rooms, etc., for the Games. Only a few replies were received at an early date, however, and the Committee made satisfactory arrangements later on. As, however, requests for rooms were expected at a late date from many members of the International Olympic Committee, some 10 rooms at moderate prices were booked at the Grand Hotel in the autumn of 1911, to have as a reserve at a reasonably low figure.

Accommodation provided for the various nations.

Australasia. The immense distance between Sidney, the seat of the Australasian Olympic Committee, and Stockholm, necessitated negotiations with the Committee in question being carried on chiefly by cable, so that the task of making arrangements for the accommodation of the Australasian team was a somewhat difficult one. Agreements had to be made with the "pensions" where the competitors intended staying, to provide the visitors, as far as possible, with the food to which they were accustomed. Part of the team came to Stockholm at a very early date, arriving in May, and obtained board and lodging for 41 swimmers, rowers and runners at the pensions at 32, Skepparegatan, and 18, Sibyllegatan.

The *Austrian* contingent found accommodation at Dehn's Pension, Strandvägen, and at the pension Cosmopolite.

As was before mentioned, Herr Karl von Reisner, Secretary of the *Baltic Committee*, paid a visit to Stockholm and arranged for 35 competitors from the Russian Baltic Provinces to have the lower-priced accommodation. This agreement was altered later on, the competitors in question being invited by the *Russian Committee* to stay on board the vessel which, like that employed by the U. S. A. team, had been chartered by Russia for its competitors, committee members, etc. This vessel was the large S/S Birma which lay at anchor at Värtan harbour from June 27—July 20. All the Accommodation Committee did for the Russian party was to obtain rooms for a few members of the committees and some journalists, these persons for the most part taking up their residence with Russian-speaking families that wished to let out rooms.

In spite of repeated reminders, the *Belgians* made very late application to the Committee and then only for a very limited number of persons. Board and lodging was found for the rowers and swimmers of this nation at the pension at 24 B, GrefTUREGATAN.

The result of the negotiations with the *Bohemian* representatives who had been sent in advance to Stockholm, and of all the subsequent exchange of letters was, that rooms were taken for the Bohemian competitors and some members of their committee at a private hotel in Birger Jarlsgatan, at a pension in GrefTUREGATAN and at a pension in Biblioteksgatan. 6 Bohemian athletes made use of the lower-priced accommodation, and were lodged in the Norra Realläroverket.

Distance caused some difficulty as regards the *Canadians*, as it had done with the Australasians, but at last everything was arranged, and agreements signed by the leader of the team, came in sufficient time to the pensions and hotels where rooms had been taken for them, viz., the above mentioned pension at GrefTUREGATAN, the Hotel Pallas, Klarabergsgatan, and the pension at 1, Arsenalsgatan, where Mr. Crow, the leader of the team, stopped.

The *Chilian* representatives stayed at the pension at 9, Biblioteksgatan.

The result of the negotiations with the *Danes*, which was carried

on entirely by letter, was that rooms were taken at the Hotel Germania, Gustaf Adolfstorg, for a great number of their team, including those taking part in the shooting-, rowing-, fencing-, gymnastic-, and modern pentathlon competitions. The Danish Olympic Committee stayed at the Hotel Clara Larsson, in Birger Jarlsgatan. The competitors in the wrestling-, swimming-, cycling- and some other events were lodged, by agreement, in the school premises of the Norra Realläroverket.

Rooms only were taken for the Bohemians, Canadians, Chilians and Danes. They arranged the question of board themselves, the Danes, however, apparently making use of a number of addresses which they had asked for and obtained from the Committee.

All the *Finlanders*, with the exception of some few members of their Olympic Committee, took advantage of the school-and barrack-accommodation. Some of the men-gymnasts stayed at the South Barracks; the women-gymnasts stopped at the Gymnastic Central Institute; some of the rowers were lodged at the Primary school at Linnégatan, and the rest of the team at the Norra Realläroverket. The *Finlanders* attended to the question of board themselves.

The *Frenchmen* taking part in the lawn tennis competitions, and in the modern pentathlon together with some others of their countrymen, amongst whom was M. Roy, General Secretary, stayed at the Pension Ålander, Birger Jarlsgatan, with which the Committee had drawn up an agreement and where the members of the team took an early breakfast, too. The other members of the team stayed at the Primary school at Linnégatan, as we have already mentioned.

The accommodation arrangements for the *Germans* were made partly by Dr. Martin, on his above-mentioned visit to Stockholm, and after some lively correspondence in addition, all the negotiations resulting in agreements being made with the Hotel Savoy, Hotel Kronprinsen, the Pension Ålander and the Stockholm Gymnastic and Fencing Club, the latter body, having put some beds in its large Gymnasium. The German Olympic Committee stayed at the Hotel Rydberg.

As regards the competitors, etc., from *Great Britain*, the Committee had to make arrangements, not only for their rooms, but, at most of the hotels and pensions where the men intended stopping, for the details of breakfast and dinner too. They took rooms at the Hotel Excelsior, the Hotel Clara Larsson, Carleson's Pension, the Pension Birger Jarl, and the Hotel Sylvia (all in Birger Jarlsgatan), and at Zander's Pension in Artillerigatan. The rowing team obtained rooms themselves (through the Committee, however) at the Pension Cosmopolite, Skepparegatan, while the fencing team stayed at the Hotel Continental.

The competitors from *Greece*, with their leader, Professor Chryssafis, all stopped at the pension Skärlén, Drottninggatan.

Holland, like Belgium, had not availed itself to any great extent of the help proffered by the Accommodation Committee, which found rooms for some of the Dutch competitors, however, in a pension in Arsenalsgatan. The Committee also ordered rooms at the Hotel Ryd-

berg for Baron de Tuyll, President of the Dutch Olympic Committee, and for some other prominent representatives of the same nation.

The *Hungarians* stopped at the Hotel Continental, the Hotel Regina, and the Hotel Kronprinsen; a few were lodged at the Norra Realläroverket.

The contingent of *Icelanders* stayed at the school in Linnégatan.

Marquis Ferrante, Secretary of the Italian Legation in Stockholm, acting on behalf of the *Italian* competitors, requested the Committee to obtain rooms for the greater part of the team at the Betel Seminary, 18, Engelbrektsgatan, where they were also provided with an early breakfast. As, during the last few days of their stay here, they could not remain in these rooms, which had, at an earlier date, been promised to other persons, these Italians went to stay at the school premises in Linnégatan.

The *Japanese* competitors stopped at the pension at 5, Birger Jarls-gatan, while the men from *Luxemburg*, nearly all members of the Gymnastic team, stayed at the Norra Reallätiroverket.

The negotiations with the *Norwegians*, which were carried on through the representative already mentioned and also by letter, resulted in an agreement being made whereby the women gymnasts from Norway stayed at the Pension Fagerström, Birger Jarls-gatan; their leaders and the fencing team at the Hotel Bellevue, Brunkebergstorg, and the remainder at the Hotel Reisen, Skeppsbron, and the Restaurant National Regeringsgatan, part of this latter house having been turned into a hotel for the summer. In the two hotels last mentioned the visitors took an early breakfast, too.

The *Roumanians* had requested school-lodgings for their gymnasts, and accomodation was provided for the team at the Norra Realläro-verket. The team never came, however.

The *Semians* stayed at the pension, 35 Döbelnsgatan.

After a great deal of writing and cabling — the great distance causing considerable trouble — the *South Africans* were found rooms at the pension Collin, Strandvägen.

The *Swiss* team made no use of the Committee's proffered assistance.

The *Turks* stayed at the Primary School in Linnégatan.

The accommodation our guests found at the hotels, pensions or with private families differed, of course, very much in kind, from plain, though irreproachably clean rooms, to the very comfortable. In general, it can be said that the prices were by no means unreasonable, considering that the occasion was that of the Olympic Games. Rooms, for example, cost from Kr. 2.50 up to Kr. 15—20 (2 sh. 9 d.: 67¹/₂ cents, up to 16 sh. 5 d. : \$ 4, and 22/-: \$ 5.36) per person, per day, and, on an average, about Kr. 4—5 (4 sh. 4 d.: \$ 1.08—5 sh. 5 d.: \$ 1.34) per person and day, for double-bedded rooms. These figures, of course, did not include board. But the nearer the Games came, the *lower* grew the price of rooms, so that those who ordered rooms beforehand, in order to avoid an extortionate rise in prices, actually paid most.

The sleeping accommodation in the schools.

Steps were taken to make the school-rooms as comfortable lodging-places as possible and, at the same time, to satisfy the demands for order, and security against fire, made by the Stockholm School Board. The Committee had printed a billeting-card, consisting of a triple leaflet which, when folded, could conveniently be carried in a pocket book. On the face of this ticket, there was a small-scale map of Stockholm, with so much of the outskirts of the town that all the schools and barracks employed as sleeping-quarters could be found there. In spite of the small scale on which these maps were drawn it can be said that they were very clear indeed and quite fulfilled their purpose — that of being a good guide for our guests should they experience any difficulty in finding the way to their quarters. On the back of the leaflet there were the names, addresses and telephone-numbers of the Accommodation Committee, its President and Secretary, so that the holder could easily communicate with the officials mentioned. A red asterisk and the address of the Committee was printed on the card, at the spot where the Committee had its office, thus facilitating a search for the place in question. On the face of the middle page, the holder had to write his title, name, dwelling-place and branch of sport, in the column printed for the purpose. The name and address of the sleeping-quarters was, in each case, printed in the line assigned for it. In front of the name of the place there was printed a number in red, a corresponding number being given on the map, thus showing the position of the place. These tickets also served as identification cards for the holder, without which, admission to the school or barracks could be refused. They were printed in Swedish, English, French and German editions and, as soon as the accommodation arrangements were definitely made, they were sent in good time to the various contingents of competitors, etc., to serve as a guide for those persons, too, for whom we had obtained rooms at hotels and pensions.

In the schools, five beds, on an average, were placed along each side of the class-rooms used; close to each bed there was put a school-desk which was to serve as a kind of night stand, together with a little chest of drawers; these arrangements were much appreciated by the guests. The other school benches, maps and other school-material were removed to those class-rooms that were not wanted as sleeping quarters. Each bedroom was carefully put in order every day, and the beds made, etc., by the char-women employed by the school, who were paid for their services by the Committee.

It can with good reason be said that the beds and the other arrangements were such as fully deserved the praises given by the guests with regard to their convenience and comfort. On our side it is a pleasant duty to state that the visitors deserve every acknowledgement for the gentlemanly way in which they behaved while in these quarters; with one or two unimportant exceptions there was absolutely no complaint made against our guests. The charges for repairs which the Committee had to pay after the premises had been inspected at the

close of the Games (in agreement with the contract made with the School-Board of Stockholm), by the School-Board's building-engineer, a representative for the School-Board and one for the Swedish Olympic Committee, amounted to no more than a few shillings, a result which must be considered as most satisfactory.

Some 30 Finnish women-gymnasts were lodged in the Gymnastic Central Institute, where one of the large gymnasium-halls was put in order for their reception. The arrangements, on the whole, were the same as those adopted in the schools just mentioned.

The number of competitors lodged in the schools was not at all as great as the Committee had expected and from the stores that the Crown had placed at our disposal there were taken altogether not more than 434 beds, the same number of pillow-cases and blankets, 81 mattresses, circa 600 towels and some 30 wash-hand basins.

The Committee having resolved to procure rooms for such competitors, too, as took part in displays only, it had the task of obtaining sleeping-quarters for the gigantic gymnastic-display team sent by Denmark, and numbering circa 400 men and 140 women. Accommodation was found for them in the South Barracks, Tjärhofsgatan, in the same building with the Danish men-gymnasts who were going to take part in the competition ; a number of the Finnish gymnasts were also quartered here.

Boarding arrangements for the competitors.

When the Accommodation Committee discussed the question of the fee that ought to be fixed for the so-called school- and barrack-accommodation it was argued that the athletes ought, and would be willing, to pay more for their stay in Stockholm if only they obtained good quarters and a sufficiency of well-cooked food. The Committee was of the same opinion, too, and it settled the first part of the question in accordance with this idea. But at the Stadium the only refreshments that were to be obtainable were cooling drinks, sandwiches, etc., but no meals, while it was highly probable that the competitors, would be very glad to have a restaurant in the immediate vicinity of the Stadium, where they could take their meals in parties belonging to the same nation, or the like, and the Committee at once began to make inquiries as to the possibility of taking the Pavilion of the Lawn Tennis Company, situated just behind the Stadium and where no tennis is played during the summer. In consequence of its convenient position, and for other reasons, the Committee thought that the Pavilion would be a very suitable place for a restaurant, intended chiefly for the competitors, where they could get good meals at a moderate figure with the dishes as far as possible in accordance with the tastes and customs of their various nations. The immense, airy tennis-courts would make excellent dining-halls ; a little building at one end where the heating-boiler of the establishment stood, could easily be changed to a kitchen whence the food could be carried through a provisional corridor into the main building. The grounds in front of the pavilion appeared adapted for the arrangement of dining-tables in the open

air. In addition to this there were commodious cloak-rooms and a number of other advantages, all of which spoke in favour of this Tennis Pavilion, and the Committee began negotiations with a number of restaurant keepers for the purpose of making some arrangement whereby one of them would either superintend the restaurant in question, or else manage it at his own risk and profit. Amongst those that were asked and who inspected the premises together with the members of the Committee, was Mr. Löfvander of the Hotel Kronprinsen. The Swedish Olympic Committee having accepted the proposal of the Accommodation Committee, made an agreement with Mr. Löfvander, whereby the latter undertook to run the restaurant during the Games, in the first place to provide for the needs of the competitors and then for those of the general public. Mr. Löfvander turned these tennis courts into exceedingly comfortable and tastefully decorated dining-rooms in which the athletes and their guests met, especially at lunch time, at tables decorated with the flags of the competing countries. Lunch cost Kr. 1.50 (i. s. $7\frac{1}{2}$ d: 40.4 cents), and dinner with four courses Kr. 3. — (3 s. $3\frac{1}{2}$ d.: 81 cents); the latter meal was also served *à la carte* at prices which had to be submitted for the approval of the Olympic Committee. Those competitors, etc., staying at hotels and pensions had not, as a rule, taken advantage of the Committee's offer to make arrangements for their board during the Games. This remark applies especially to the question of dinners.

As regards the competitors quartered in the schools and the barracks, the Committee had made the arrangement on behalf of the French contingent that the school doorkeepers would be willing to assist the guests in purchasing the necessary food for plain breakfasts and suppers, some of the visitors took advantage of this stipulation, although, as a rule, no cooking was allowed in the schoolrooms but the meals had to be prepared in the doorkeeper's home.

Procural of rooms for tourists.

The Accommodation Committee soon had to solve the question of the steps to be taken so that the large number of visitors expected to the Games might be able to obtain rooms, and that at a reasonable figure, thus making the festival a success in this respect, too. Some members were of opinion that the Committee ought to obtain rooms for all these tourists *in spe*, whose numbers private enterprise only too willingly began to reckon by tens of thousands.

But the opinion was soon adopted by the Committee that this important question would be best solved by two leading house-agencies being appointed the official representatives of the Committee in this matter, as the rush of tourists was expected to be very great during a comparatively short space of time, when one office would probably prove quite insufficient. Negotiations were therefore begun with the Nya A. B. Tjäder's Bureau and the Stockholm House Agency, which resulted in their being appointed by the Swedish Olympic Committee — which engaged to have nothing to do with the procural of rooms

for private visitors to the Games — to be its special representatives for the procural of rooms for the tourists in question. This work the two agencies were to carry out in the best possible manner and at their own expense. They were, of course, to engage the necessary number of assistants with linguistic acquirements and to open suitable, centrally situated offices in addition to their already existing establishments. They agreed to have these new offices and staffs in readiness by the first week of June, 1912 at latest and, should the Committee so desire, to keep them open until the 31 July of the same year. Among the various stipulations in the agreement there was one that, as a rule, the price should be Kr. 3—5. (3 s. 3 d.—5. s. 5 d. : 81 cents—\$ 1.34), and only in exceptional cases as much as 10 Kr. (11/—: \$ 2.68) per room per day, while the charges for the rooms should include everything going to make up good and comfortable lodgings. For double-bedded rooms not more than 2 Kr. (2 sh. 2 1/2 d.: 54 cents), per room, was to be added to the price. Should the Agencies occasionally wish to let rooms at a higher figure than 10 Kr. (ca 11/— : \$ 2.68) each per day, this could be done only with the consent of the Accommodation Committee, and at a figure which it approved of, the Committee having been entrusted by the Swedish Olympic Committee with the full control of the work of the Agencies. This task which took much time and work, was performed by Mr. Ekström, of the Accommodation Committee. He had to inspect as many as possible of the beds and rooms on the books of the Agencies, in order to see that they satisfied the demands that could reasonably be made on them for the price asked. Mr. Ekström had also to exercise control over the Agencies, in the event of their showing any inclination to charge too much for the rooms for the purpose of obtaining a larger commission.

The number of rooms available.

Such an event as the Olympic Games might, naturally, be supposed to attract quite a number of tourists, and the expected demand for rooms gave many persons hopes of making money by letting out rooms, either with or without board. The result was a repetition of the old story of great expectations and, in many cases, complete disappointment. Tens of thousands of tourists were expected, and this perspective gave hopes of vast sums of money being gained. These dreams found expression in the Press and were entertained by many classes of the population of Stockholm.

Unfortunately, however, notices began to appear late in the autumn of 1911 in the foreign Press with many exaggerated and inaccurate representations respecting the probable cost of rooms and board in Stockholm during the Games. The Accommodation Committee wished to do its best to ward off this threatening danger and, as soon as it learned of these unfavourable reports it at once wrote to the Advertising Committee of the Olympic Games mentioning the statement made that the price of rooms and board was, even then, very high and would

probably rise to an unconscionable degree. As the report in question was not only absolutely false, but would also greatly contribute to prevent people from visiting Stockholm during the Games, the Advertising Committee was requested to publish an energetic denial, at the same time stating that a great number of rooms were to be had at prices varying between Kr. 3—10 each (3 s. 3 d.: 81 cents—11/-: \$ 2.68). The Advertising Committee at once published the denial.

This step, did not seem to have been of much use, however, for, early in February, 1912, the Committee received a communication from the Swedish Tourist Traffic Association in London mentioning a number of notices which had been published in the London Press according to which it was already a matter of difficulty to engage rooms in Stockholm for the Games, while it was also said that passable board and lodging could hardly be obtained for less than £ 1 (\$5) per day, i. e. £ 7 (\$ 35) per week. Such notices, wrote the Association, would prevent even well-to-do persons from visiting Stockholm, and it asked for information as to the approximate number of hotel-rooms that could be had, and the prices demanded for them. In addition to this, the Committee was asked to state the number of private rooms that could be had, and the average charge, both with and without board, and the Association stated that, with the help of this information, a denial of the above-mentioned statements could be published. The Committee requested the two Agencies to send in the report asked for, and this was forwarded as soon as possible to the Association in London. The answer stated that some hotels would not take any advance-bookings of rooms for the Games, while, as far as the Committee could see, most of them would not book more than about half of their rooms, so that there was still a large number of hotel-rooms to be had. Quite naturally, the hotels wished to make some little profit, as is the case everywhere on such occasions as the one in question, but the Committee thought that it could state that the prices charged were, on the whole, quite moderate, especially those asked by the numerous pensions in Stockholm and the environs.

The Committee also stated that more than 12,000 beds were on the books of the two official Agencies, and that the average daily charge per bed was about Kr. 4.50 (5/-: \$ 1.25). As an example it was stated that one Agency had 350 beds at Kr. 2.50 (2 s. 9 d.: 67 cents), 900 beds at Kr. 3. (3 s. 3 d.: 81 cents), 750 at Kr. 3.50; (3 s. 9¹/₂ d=: 95 cents), 300 at Kr. 4. (4 s. 5 d.: \$ 1.08) and 525 at Kr. 4.50 (5/-: \$ 1.25), besides a number at higher prices. In most cases it would be possible to obtain an early breakfast at a moderate charge and, in some instances, full board was offered at a comparatively low figure. If necessary, a large number of rooms could be had in the immediate vicinity of Stockholm, while, in the city itself, a great number of additional rooms would probably be placed on the lists of the two agencies, so that, as far as it was possible to judge beforehand, there would be a perfectly satisfactory number of rooms at moderate prices for the accommodation of visitors to the Games.

At the beginning of May, only a couple of months before the beginning of the Games, it came to the knowledge of the Accommodation Committee that a Norwegian paper, the "Aftenposten", had lately published an alarmist article on the matter of board and lodging in Stockholm during the Games. The article had undoubtedly been written under misapprehension of the real facts, and expressed the optimistic feelings of speculators in rooms, rather than the actual condition of things, but as a large stream of tourists was expected from the northern countries of Europe especially, it was necessary to make an emphatic and effective denial of the article in question and, through the agency of the Swedish Telegrambureau, the Committee published an energetic denial of the statements in all the Swedish papers, and in as many foreign journals as possible, based on reports asked for, and received, from the two Agencies, respecting the then existing possibilities of obtaining rooms at moderate charges. These reports stated that some 20,000 beds were then on the books at an *average* price of about Kr. 4.50 (5/-: \$ 1.25 per day), while a very large number could be had at far lower figures.

In future Olympic Games, in order to prevent disappointment caused by the stream of visitors not being on the scale expected, it will be necessary for those officials that have the charge of the advertisement of the Games to take immediate notice of, and energetically deny, untrue and misleading rumours such as those now described. The Press, too, should use the power it possesses — not least in consequence of its omnipresence — and as far as possible, suppress alarmist notices which, as a rule, have no real grounds, but merely give expression to the general desire of making some little profit, and which certainly do a great deal of damage. The Press should, on the contrary, publish authentic notices of the real condition of things, and thus quiet any existing fears of the charges for board and lodging being prohibitive.

Report of the Press Committee.

At a meeting held on the 16th Oct. 1911, the Swedish Olympic committee determined to appoint a special Press Committee for the purpose of arranging all such questions as appertained to the Press. Colonel Baron S. D. A. Hermelin was chosen President, and 10 other members were also elected; 5 from the Swedish Association of Journalists, and 5 representatives of the sporting Press of Stockholm. The number of the Committee was afterwards increased, so that its final composition was as follows :

- President:* Colonel, Baron S. D. A. HERMELIN.
Secretary : Mr. ERIK PALLIN; "Stockholms Dagblad",
Other Members: » A. ANDERSSON-EDENBERG, Correspondent for the
 Provincial Press of Sweden,
 » ERIK BERGVALL; "Nordiskt Idrottslif",
 » STEN GRANLUND; "Stockholms Dagblad"; repre-
 » senting the Swedish Association of Journalists

- Mr. K. A. HAGBERG; "Aftonbladet"; President of the Swedish Association of Journalists,
- » O. HEMBERG; "Dagens Nyheter",
 - » O. HELLKVIST ; "Aftonbladet",
 - » F. KOCK; The Swedish Telegram Agency,
 - » H. LEANDER; Swedish News Agency,
 - A. LINDMAN ; "Ny Tidning för Idrott",
 - » J. LÖWENTHAL; "Göteborgs Handels- och Sjöfartstidning",
 - » E. PETERSON ; "Svenska Dagbladet", Club-master of the Swedish Association of Journalists,
 - » G. UGGLA; "Svenska Dagbladet",
 - » ULRICH SALCHOW ; "Dagens Nyheter",
 - » HERMAN SELDENER; "Nya Dagligt Allehanda",
 - » J. TÖRNEQUIST ; "Stockholms-Tidningen",
 - » D. WAHLBERG; "Stockholms Dagblad".

The Committee held its first meeting on 3 Nov. 1911, at the offices of the Central Association for Athletics, when Mr. Erik Pallin was chosen secretary. The Committee held 25 meetings altogether.

When the Committee began its labours, it was greatly assisted by a general survey of the work and wishes of the Press for the approaching Games, together with a detailed investigation of a number of questions in this connection, which had been made by members of the staffs of the sporting Press of Stockholm. These journalists held a meeting early in the summer of 1911 and, after drawing up the above - mentioned memorial, sent it to the Swedish Olympic Committee, at the same time pointing out the desirability of a Press Committee being appointed at the earliest possible date, for the purpose of attending to all such questions as came within its province. The memorial contained a fully detailed scheme for the seating of the Press at the Stadium, and for the journalistic-technical preparations that should be made there, and at the other places where competitions were to be held.

The work of the Press Committee, to begin with, aimed chiefly at the solution of the following important questions: the procuring of good seats for the representatives of the Press at the Olympic Games and, in this connection, the distribution of the tickets to the various places where the competitions were held; the communication of news intended by the various Olympic sub-committees for the Press; the question of the right of the press to take photographs during the Games; that of the special arrangements for facilitating the work of the correspondents of the Press, and, finally, the question of the appointment of a special Press-Commissioner during the Games, this matter being a corollary of the former matter.

In order to solve the somewhat troublesome question of tickets, the Press Committee was, to begin with, obliged to get the Swedish Olympic Committee to increase the calculated number of 225 Press seats in the Stadium to 500. The question of entrance-tickets for newspaper correspondents to other places than the Stadium where competitions were to be held, had to be adjourned for the time.

In order to find out how many seats would be required for the Press during the course of the Games, a circular was sent out to the daily papers in Stockholm and to the other journals in Sweden, in which it was stated that the number of tickets available, could not, even now, be estimated as in any way equal to the demand, but that the Stockholm papers would each receive 4 tickets, while the representatives of the Swedish provincial Press would be divided into two categories, the one being entitled to series-tickets available for a certain time, and the other to daily tickets.

For the purpose of seeing what demands for Press tickets might be expected from abroad, the Committee addressed itself to the representatives of the Swedish press abroad, Messrs. H. Valentin (England), E. Blomqvist (Germany) and E. Sjöstedt (France), asking them for advice, and these gentlemen rendered most willing and valuable assistance. In addition to this, by means of the telegram agencies, direct inquiries were sent by circular to all the important papers in Europe, asking whether they intended to send representatives here, and stating that, should this be the case, the Press Committee would be happy to place seats at their disposal and to assist them in every possible way.

Applications from the Press abroad began to flow in as early as February, 1912; these were discussed and decided on in committee, while a new circular was sent to the provincial Press of Sweden asking if series- or daily tickets were expected. This matter, too, was discussed and settled at the meetings of the Committee, official minutes being kept of the meeting.

As regards the neighbouring countries of Finland, Denmark and Norway, from which a large contingent of journalists was to be expected, it was determined to reserve 15 seats for each of them, and to inform the Olympic Committees of these countries of the fact, with a desire that they would divide these tickets among the Press of the countries in question. This system proved to be a most satisfactory one.

In order to facilitate the communication of information sent by the various Olympic Sub-committees to the Press, the Press-Committee proposed the organization of a special Olympic Information Bureau with a specially qualified journalist at the head. As the Swedish Telegram Agency, however, declared itself willing to undertake this work free of charge, nothing more was done in the question, although such an arrangement would, without any doubt, have been of great service, both as a means of advertising the Games and, still more, for the Press.

A question very difficult of solution was that of the right of the Press to take photographs during the Games; it came under discussion at the very first meeting of the Press Committee and occupied its attention until the Games were about to begin. The thought was soon rejected of granting a monopoly for the right in question, according to which, only a couple of photographers should be granted admission to the arena of the Stadium, all the papers then being referred to them for the illustrative matter they desired — this method of solving the problem being considered an unjustifiable restriction

of the work of the Press for the Games. In journalistic work today, the photographer's share is quite as important as that of the correspondent's, and, on such an occasion as that of the Olympic Games, it was of the very greatest importance to allow all the papers an opportunity of giving first-class pictorial representations of the competitions. On the other hand, the presence of a great number of photographers in the arena would, without doubt, not only be a serious hindrance to the competitions but would also render it a matter of great difficulty to take such measures as would make it possible for the whole of the spectators to get a good view of the various events.

It was finally determined to establish a special photographic office, for the Olympic Committee's account, from which, at certain hours during and after the Games, copies of photographs of the competitions could be had by anyone. This photographic office should, itself, employ 3 photographers. In addition to this, 5 photographers representing the Stockholm newspapers should be admitted to the various arenas, on condition that they gave their plates to the office in question for the purpose of copies being taken and sold to the public, and to other newspapers after the journals in question had first attended to their own requirements. The cost of copies obtainable from the photographic office in question was fixed at 3 kronor (3 sh. 4 d.: 8 I cents) including the right of reproduction, and 50 öre (6 d.: 13.4 cents) without such right. In addition to the photographers in question, three photographic agents for the foreign Press were to receive permission to work at the places in question. The photographic office was taken by the firm of Hasselblad & Scholander of Stockholm.

Spectators of the Games were allowed to take photographic apparatuses with them to their seats inside the Stadium, but not such as were intended for the production of moving pictures, while those visitors that desired to take photographs from the seats had previously to give the Agency a signed declaration, stating that the photographs in question would not be exposed for sale, or used for the purpose of advertisement.

A number of special measures were taken for the convenience of the representatives of the foreign Press. For example, the Directors of the Royal State Railways issued free passes on their lines for all journalists from abroad who were to represent newspapers at the Games. In addition to this, special press telegraphic communication with America was obtained, a step much appreciated by the very great number of journalist from the United States, as they were thereby enabled to cable their long and expensive messages at half the usual fees. Similar telegraphic-communication was also opened with Japan. During the winter in the early part of 1912, Stockholm was visited by a number of journalists from abroad, who, on behalf of their respective Unions or other fellow journalists, came here to see how matters stood; these visitors were given every information respecting the steps intended to be taken for the convenience of the Press which could be of assistance to them in their investigations.

The arrangements for the convenience of the Press which were made daily at the Stadium were followed by the Committee with all possible attention and, at a meeting of the Committee it was determined to provide the benches with writing-desks; the seats were then distributed amongst the various countries and the newspapers represented; a dozen telephones were ordered for the press-stands, and the rooms close to the stand were put in order. Altogether, the Press had 5 rooms at its disposal at the Stadium, with 30 telephones, in addition to a fully equipped telegraph-station. Under the Press-stand there was arranged a large, light and cool club-room, with comfortable furniture and a large number of writing-desks.

Among other things that occupied the attention of the Press-Committee during the months just before the Games began, may also be mentioned its co-operation with the Advertisement Committee with regard to the work of the latter for the Games; its negotiations in Gothenburg respecting the wishes of the journals there; the drawing up of a classified list of the whole of the Swedish provincial Press as an aid to the distribution of press-tickets, and the procural of apartments for those journalists from abroad who had written to the Committee on the matter.

It was not the preparations at the Stadium alone, however, that the Committee had to think about, but there were arrangements for the Press to be made at the many other places where various competitions in the series of the Games were to be held; first and foremost the Swimming-Stadium, the Rowing-Course, the Råsunda-Football Ground, the Tennis-Courts, the various places for the shooting-competitions, and for the yacht racing out at Nynäs. Conferences were held with the leaders of the competitions at these places; proposals were made respecting the measures to be taken; visits were paid to the spots in question, and everything was done to obtain the greatest possible number of Press-tickets. For the purpose of making arrangements for the yacht racing out at Nynäs, the Royal Swedish Yacht Club requested the Secretary of the Press Committee to sit on its Regatta Committee, in which there was already one representative of the Press, Mr. Thore Blanche.

At one of the very first meetings of the Press Committee, a proposal was made to appoint a *Press-Commissioner*, and a sub-committee drew up special instructions for a Director of the press-office of the Games, with all its many and various functions. The Press-Committee considered it necessary to appoint such a salaried official for the period 20 June—20 July, and recommended that Dr. D. Wahlberg, of the Stockholms Dagblad, should fill the post. The Swedish Olympic Committee approved of the proposal, and Dr. Wahlberg was elected a member of the Press Committee, and at once began to take part in its labours, especially by assisting the chairman in the very extensive correspondence with abroad.

Dr. Wahlberg began his work as Press-Commissioner on the 17 June, while the bureau at the Stadium was opened on the 20 June, a few days before the Games began, and from that date until the

17 July, Dr. Wahlberg was engaged at this office almost day and night.

Two special assistants were placed at Dr. Wahlberg's disposal; in addition to which, the club-attendant of the Swedish Association of Journalists was also sent to help at the office, where his experience in attending to the wants of journalists was of great service.

The Press-Commissioner did not begin his work a day too soon. In the middle of July there was sent to all the journalists from abroad who had notified the Press-Committee of their intended arrival, a circular and other printed matter respecting the journey in Sweden and their work here, the circular beginning with a hearty welcome to the Games. In addition to this, there was a free railway-pass within Sweden, to and from Stockholm, and a personal press-telegram card, together with a detailed P. M. from the Director of the Telegraph Department, containing all necessary information regarding the despatch of telegrams from Sweden; the situation of telegraph-offices within and outside the Stadium; information as to the rates of payment, and the exchange-values of the foreign money that would be accepted in payment of telegrams, together with a list of the countries with which Sweden had telegraphic communication. There was also a map of Stockholm and a plan of the Stadium. Various telegraphic orders for railway-tickets were sent at this time by the Committee.

The Press-office was made ready a few days before the great stream of Press-representatives was expected to arrive, and papers and other printed matter were procured for the assistance and convenience of the journalists. Two copies of each of the Stockholm papers were placed on the tables, and the Press-office subscribed to a score of leading foreign papers for use in the club-room. Many foreign and Swedish papers were sent gratis, so that the supply of journalistic literature at the office was a very rich one. In addition to this, the Press-Commissioner hired half a dozen type-writing machines which were placed on the tables, and there was a good supply of all necessary writing material.

Just before the Games began, and after the Press-Committee had perfected its plan for the distribution of the seats among the Press-representatives, the Press-Commissioner and the secretary of the Committee undertook the detailed issue of the Press-tickets, and on each press-seat in the Stadium there was placed a card, with the name of the holder and the paper he represented.

In order to facilitate the entrance of the representatives of the Press to the places reserved for them, there was issued a special press-badge, to be placed in the coat-lapel. A P. M. was also distributed, showing the arrangements in the Stadium, the times and places for which the tickets were available, and the various premises open to members of the press.

The tickets to the Press-stands in the Stadium were of 3 kinds, viz.; 1:0, a passepartout card, of which only some 20 were issued and which admitted the bearer everywhere, both to the seats for spectators and to those reserved for the Press: 2:0, series-tickets, which

were given at the beginning of the Games to the journalists entitled to them: 3:0, day-tickets which had to be asked for daily at the office of the Press-Commissioner. Only the third class of ticket could be provided for the Press for competing-places other than the Stadium.

The distribution of the Stadium press-stand seats was a very delicate matter. It is true that the 500 places reserved for the representatives of the Press were sufficient in number, but various, unexpected difficulties arose, as when, for example, the representatives of a certain country refused to sit behind those of another land, etc.

The giving of tickets for the scenes of competitions held elsewhere than at the Stadium, gave the Commissioner much trouble and, occasioned perhaps, the greatest part of his work, especially as quite a number of journalists entertained the belief that the tickets to the Stadium admitted the possessors to the other competing places too.

The first of the tickets in question, viz., those to the football grounds at Råsunda and Traneberg, at once proved insufficient in number, especially as the mistake had been made of printing them as series-tickets, admitting to both these places during all the competitions.

The space at the disposal of the Press at the Tennis-courts was of course, still more restricted, but, in this case, the leaders of the competitions lent a kindly ear to the wishes of the Press and ordered that *all* the Stadium press-tickets should entitle the bearer to entrance here too, a step which was to the great satisfaction of the journalists, especially as the number present was not greater than space allowed.

No tickets were issued for the shooting competitions, it being merely necessary for the Press-office to state where the teams of the respective nations were competing.

At a very early date, fears were expressed that the 150 places reserved for the Press at the Swimming-Stadium would not be sufficient, but these fears proved baseless, in consequence of the tickets being daily ones, and not series-tickets which could be kept for the whole time even by such representatives of the Press as were there only once or twice. It is true that this arrangement caused a considerable amount of extra trouble, both to the Press-office and to a number of journalists, and that it was viewed very differently by various press-men. All the journalists who were provided with Stadium-tickets or Press-badges and who came as reporters to the Swimming-Stadium were, generously enough, admitted to the seats reserved there for the Press and honoratories.

Free admission was also granted to the Press-stand on the rowing-course, to all authorized journalists who wished for a seat.

Another very difficult matter, the burden of which fell for the most part on the Press-Commissioner, was the distribution of tickets to the festivities.

For H. M. the King's garden party, the Press-Commissioner, at the request of the Royal Chamberlain's office, sent in a list of 160 journalists who, in his opinion, ought to be invited, and the Royal Chamb-

erlain's office then issued invitations to these persons. About 20 foreign journalists were invited to the dinner given by His Majesty at the palace, and 10 to the gala-entertainment at the Royal Opera. A certain number of tickets or cards of invitation to some 15 other entertainments were placed at the disposal of the Press-office, and were distributed by the Commissioner according to the best of his judgment and, on the principle, that no one should remain uninvited.

Not the least weighty detail of the work of the Press-Commissioner's office was one belonging to a sphere for which it had not, from the first, been intended, viz. the supplying members of the Press with information. The chief reason of this probably was, that, for reasons which have already been given, the information-office of the Olympic Games, the establishment of which had been proposed by the Press-Committee, had not become a reality. As matters now stood, the office of the Press-Commissioner became, from the very first moment, a Central News Agency, from which the journalists from abroad, those from the Swedish provincial towns and, in certain cases, the Stockholm papers, too, obtained news and learned the results of the competitions. The Commissioner's office at once undertook this work, however, and made arrangements to carry it out. An agreement was made with the Swedish News Agency that it should supply the Commissioner with a number of duplicates of its notices respecting all the competitions, and these were at once placed on the notice-board in Swedish, English and German, both in the Press-room and on the notice-board in the press-stand. A journalist could thus sit in the Press club-room and learn all the principle details of the competitions. The lists of points made by the competitors were also placed on the notice-boards, and were altered every now and then as the results came in.

In addition to this, the journalists received the general programme for each day and the programmes of the special competitions. The lists of entries for the various branches of athletics, the results of the drawing of lots by, and the division into heats of, the competitors, matters which, of course, were all of the greatest interest for the correspondents from abroad but which, for very natural reasons, could not be ready before the very last moment, were procured by the commissioner's office by means of borrowing the manuscript of the programme from the leaders of the competitions, the said manuscript being then duplicated by a dozen clever lady-typewriters specially procured for the purpose, after which the copies were given to the foreign journalists interested.

Special measures were taken for the Marathon Race. For instance, a P. M. in English had been posted up in the office, with all available information as to the route, regulations, medical attendance, etc., while, close to the Stadium Official who received the telephone-messages from the stations along the route stating the times at which these were passed by the various competitors, the Press-Commissioner had been allowed to place one of his assistants, who immediately made a note of these times and the other news received from the stations

in question. This assistant at once posted all this information on the notice-board in the Press-stand, so that telegrams to the Press of the outside world, respecting the various phases of the race, were on their way from Stockholm at the same moment that they were being made known to the spectators at the Stadium.

It will be seen from this survey of the work of the Press-Commissioner's Office, that its labours during the Games were divided into 8 important groups, viz. arrangements for rooms, the distribution of seats, the distribution of tickets, the issue of invitations to entertainments, the procural of newspapers, etc., the supplying general information and news, and the procural of railway-tickets. But the Commissioner's office had many other tasks to perform in addition to all this. For example, there was much work in connection with the correspondence of 200 journalists, which was addressed to the Stadium and; to give another example, the death of Lazaro, the Portuguese Marathon runner, caused the Press-Commissioner's office a great deal of labour, too.

An agreeable interlude amid the strenuous work that fell to the lot of the representatives of the Press during the Games, was the excursion to Saltsjöbaden and the banquet there, which the Swedish Association of Journalists arranged on the 5 July by a committee, the soul of which was Mr. Zethraeus. The trip was made by water on board the *Gustafsberg III*, in glorious weather, and the dinner that followed was most successful. Mr. K. A. Hagberg, President of the Association, who presided, welcomed the guests in short speeches in French, German and English, and proposed the health of the chiefs of the States represented by the guests there present. Mr. Robinson, of the Times, responded.

After dinner, coffee was taken on the terrace, and the return journey was not begun before the sun had risen.

The last Olympic event was the regatta at Nynäs-Sandhamn, at which about 30 journalists were present, of whom a dozen were from abroad. The Royal Swedish Yacht Club had made every arrangement for their comfort, placing the pleasure-yacht *Saga* at their disposal every day and making them their guests during the whole of the time the Regatta was going on. A special Press-room was fitted up on shore, and the local telegraph- and telephone services were increased, so as to satisfy all demands that could be made on them. The obtaining of night-quarters for the visitors was a matter of greater difficulty, but this problem, too, was quite successfully solved.

Telegraph and Telephone arrangements.

The authorities were fully aware that the Swedish Telegraph Department would be put to a severe test during the Olympic Games, for they knew that the many foreign correspondents — the representatives of the English and American papers in particular — would most certainly demand a rapid and reliable telegram service. It was, therefore, felt necessary to take such measures as would enable the Department to await its coming task with perfect confidence.

As a far greater number of competitors, Press-representatives, etc. was expected from abroad than had been present at the Olympic Games of 1908, the Swedish Telegraph Department was prepared to make the preparations necessary to meet all the demands that could be made upon it, and, at an early date, it applied to the Swedish Olympic Committee, asking for suitable premises at the Stadium, and other places where Olympic Competitions were to be held. In order to be prepared for all eventualities, agreements were come to with a number of foreign Telegraph Companies regarding the arrangements that it would be necessary to make; amongst these was the adoption of the Wheatstone system on the line Stockholm—Berlin, and between Stockholm—Newcastle, and Stockholm—Fredericia. Several new Wheatstone apparatus were procured for the Stockholm Telegraph offices.

After negotiations with the Swedish Olympic Committee, etc., it was determined to open a telegraph office at the Stadium for the sole use of the Press and the Management of the competitions.

Arrangements were made so that it would be possible to send telegrams direct from this office to Gothenburg (the Swedish centre for cable communication with France, England and America) and Newcastle, and, eventually, with other offices such as Copenhagen, Christiania, etc. A telegraph station, intended for the general public, was opened at a special pavilion in Valhallavägen, and it was also determined to open offices at the Swimming Stadium, at the Råsunda Athletic Grounds, at Kaknäs Shooting Range, at the Rowing Stadium, and also at Nynäs-hamn where the Olympic Yacht Racing was to take place. All these offices, with the exception of that at Kaknäs, which was connected with the office at the Swimming Stadium, were in direct communication with the Central Telegraph Office at Stockholm.

The telegraph office at the Stadium was located in the east tower. The dispatching room was on the first floor, together with the public office intended for the members of the Press who had seats in the large Press-stand, and also for the Management of the competitions. On the third floor there was a sub-office in connection with the seats for the Press in the north stand. This sub-office was connected with the dispatching-room by means of a tube. On both floors there were writing-rooms provided with telephones and type-writing machines. There were direct entrances from the two Press-stands to the telegraph-offices just mentioned.

Although the premises placed at the disposal of the Telegraph Department were exceedingly small, the practical arrangements made sufficed to satisfy all the demands made by the Press and the Olympic officials.

The despatching-room in the Stadium was furnished with four Morse and two Wheatstone apparatus. Besides having direct communication with the Central Telegraph Office in Stockholm, the Stadium was also connected with Gothenburg and Newcastle, and it was also possible to communicate with other offices as well, direct telegrams being now and then sent to Copenhagen and Christiania.

Every measure was taken to facilitate the receipt and dispatch of

messages, and a sufficient number of clerks with linguistic acquirements were on duty in the receiving office. Those newspapers wishing to do so, were allowed to send telegrams on account, and this privilege was taken advantage of most extensively.

As regards the telephone service, the very greatest demands were fully satisfied. The switch put up in the apparatus-room stood in connection with 20 telephones inside the Stadium, while, in addition to this, there were four telephone-kiosks and 17 automatic telephones, all for the local telephone lines within the building. For the interurban traffic, there were 16 telephone-boxes on the same floor as that for the Swedish lines, 2 of the 16 being intended for long distance service with reinforced currents. Both the office for the local telephone service and the interurban office connected with the telephone-boxes just mentioned, were served by a chosen group of telephone attendants from the Central Telephone Station.

The Central Telegraph Office for the general public was in the pavilion erected just outside the Stadium in Valhallavägen, by the city of Stockholm, for the Telegraph Department, and embraced a spacious apparatus hall and two large rooms for the public. It was not used so much as had been expected, however, for when the spectators came streaming out from the Stadium, every one tried to get to the more central parts of the town as soon as possible, and telegrams were delivered at sub-offices, or at the Central Office, later on in the day. A large number of Press-telegrams, too, were sent to the Central Office in the evening, after the office at the Stadium was closed for the day.

The telegraph offices opened at the other places where the competitions were held, were situated in more provisional premises, which satisfied all requirements, however. That at the Swimming Stadium was fairly much used, especially in the evening between 7—10 p. m. Those at the Swimming Stadium, the Rowing Stadium, at Kaknäs and Råsunda, could also be used by the general public, but with the exception of the office at Nynäshamn, where quite a number of private telegrams were sent in, the messages sent were almost exclusively Press telegrams :

The Olympic Telegraph Offices were open for the following periods:

The Stadium	Office	26 June—23 July
» Råsunda	»	28 » — 16 »
» Swimming Stadium	»	28 » — 16 »
» Kaknäs	»	28 » — 5 »
» Rowing Stadium	»	16 July—20 »
» Nynäshamn	»	19 » — 23 »

As a rule, the offices were open the whole day from 9 a. m. to 9 p. m., or even later, as long as the competitions were going on or any telegraphic messages could be expected. The office at Valhallavägen was open between 9 a. m. and 11 p. m. Certain sub-offices in Stockholm were open during the Olympic-Games until 11 p. m.

The number of telegraph-officials on duty at the Olympic Offices

varied according to requirements. On the day of the Marathon race, the number on duty at one time at the Stadium office was 21. A total of 16 boy scouts was employed for the conveyance of telegrams, and for attendance at the Olympic Offices.

A considerable addition to the staff of the Central Telegraph Office was necessitated by the Olympic Games, as 29 officials were called in from other places, and some of the usual staff had to do double watches. The following telegraph apparatus were placed in the various offices :

Stadium	2	Wheatstone	and	4	Morse	apparatus.
Valhallavägen.....	2	»		»		»
Råsunda	2	»		»		»
Swimming Stadium	3	»		»		»
Rowing Stadium	3	»		»		»
Nynäshamn	2	»		»		»

The number of messages sent in consequence of the Games was a very large one. The greater part were telegrams for abroad, as the Swedish Press received its messages by telephone, just as on ordinary occasions.

During the period July 6—July 15, the number of words in the foreign Press telegrams forwarded every day from Stockholm in connection with the Games, was, on an average, 24,400. On Marathon Day, the number of words in such telegrams amounted more than 29,000, of which 20,000 were despatched from the Stadium office between 2—6 p. m.

The receipts from the special Olympic Telegraph Offices amounted to Kr. 44,823.25 (£ 2,465: \$ 12,325).

Altogether, the Olympic Games brought an increase in receipts, in all the telegraph stations of Stockholm, amounting to circa Kr. 75,000 (£ 4,125: \$ 20,625).

All the Olympic Telegraph Offices were under the control of N. R. Curman, Director of Telegraphs for Stockholm. Mr Anton Johanson was appointed to superintend the work.

The period of the Olympic Games was a very trying time for the telegraph officials, especially for those on duty at the Stadium and at the Central Telegraph Office.

The arrangements made by the Central Stockholm Telegraph Office on account of the Games satisfied the greatest demands made on it, and the messages were despatched in a perfectly satisfactory manner, even on the busiest occasions. The representatives of the Press seem to have fully appreciated the good will shown by the Swedish Telegraph Department, witness being borne to this fact by the oral and written acknowledgements made by prominent representatives of the foreign Press, some of which we beg leave to append.

The Sporting Life

148 Fleet Street

London E. C. July 31 1912.

To The Director of Swedish Telgs.

Stockholm.

Dear Sir,

Will you accept our best thanks for the extremely satisfactory arrangements you made for the transmission of cable messages to the "Sporting Life" and "Promulgation" during the Olympic Games.

We also desire to most cordially thank you for the consideration you showed in permitting our Mr. G. Wagstaffe-Simmons to transmit cables without prepayment.

Again thanking you for the expeditious and highly satisfactory manner in which, so far as we are concerned, your staff carried out their difficult duties, we remain.

Yours faithfully,
Victor E. Cope
for the EDITOR.

Reuter's Telegram Company, Limited.

July 27 th 1912.

Mr Director of Telegraphs.

Dear Sir,

As Reuter's Special Correspondent at the Olympic Games and therefore a very frequent employer of the telegraph office at the Stadium, I desire before leaving Stockholm to pay a cordial tribute to the zeal, intelligence and real kindness displayed by the ladies and gentlemen of the telegraphic staff at the Press Office of the Stadium during the Games.

Y:rs sincerely,
G. Adam.

To The Swedish Board of Telegraphs.

Stockholm.

Gentlemen,

We, the undersigned representatives of the American Press, assembled in Stockholm to report the Olympic Games, desire to place on record with you our appreciation of the extreme efficiency and courtesy of your staff of telegraph operators at the Stadium.

Stockholm, July 15th 1912.

Yours very truly,

Robert M. Collins.
The Associated Press of America.

Charles Wilbur Williams.
The New York American.

P. M. Whelan.
The New York Sun.

Orton Tewson.
The New York Times.

W:m Shepherd.
The United Press Association.

J. S. Mitchell.
New York Herald.

Traffic- and Customs=Arrangements.

The Railway Traffic.

The Swedish Olympic Committee was asked by several foreign Olympic Committees whether competitors and officials going to the Olympic Games of Stockholm could expect any reduction in fares when travelling by the Swedish Railways, and it therefore determined on the 20:th July 1911 to petition the Government for a reduction of fares for actual competitors and officials going to the Games, and in the charges for carriage for luggage and gymnastic and athletic apparatus, etc., intended for use in the Games.

In consequence of this petition the King-in-Council resolved to issue the following ordinance, subject to the restrictions that the Directors of the State Railways might find it necessary to make.

- 1) Actual competitors and officials at the Olympic Games of Stockholm, 1912, are to be granted a *reduction of 50 %* in the price of ordinary passenger tickets when travelling by the State Railways to and from the Games.
- 2) All necessary gymnastic and athletic apparatus, and other material intended for the Games, shall be carried as freight, free of charge, on the State Railways to and from Stockholm.

The Board of the State Railways afterwards issued the following regulations for those who desired to obtain the above-mentioned reductions :

"The passenger shall present an identification card — signed personally by an official appointed by the Swedish Olympic Committee — at the station where the journey commences on the Swedish State Railways, or, on his return journey, at the ticket office at the Hotel Terminus, 20, Vasagatan, Stockholm. This card shall read as follows:

"This is to certify that is ^{a competitor}_{an official} at the Olympic Games of Stockholm, 1912, and that, in consequence, he is entitled, by a Royal Ordinance dated 19 October 1911, to a reduction of 50 % on the ordinary passenger fares on his journey ^{to}_{from} the Games at Stockholm, when travelling on the Swedish State Railways."

Each traveller had, thus, to be given two identification cards printed on differently coloured paper, one for the journey to Stockholm and the other for the return journey.

For the convenience of foreign competitors or officials, the Board of the State Railways made arrangements enabling the persons in question to obtain, at certain Tourist Offices abroad, through return tickets to Stockholm, with a deduction of 50 % on that part of the fare for the distance covered on Swedish lines. The Tourist Offices in question were:

Cook's Office in London and in other important towns in Europe.
Schwedisches Reisebureau, Berlin.
Reisebureau für Norwegen, Berlin.
Verkehrsbureau Norden, Berlin.

Reisebureau der Hamburg—Amerika Linie, Berlin.

American Express Company, Paris.

Beyer's Tourist-Bureau, Christiania.

Bennet's Tourist-Office, Christiania.

Dansk Rejsebureau, Copenhagen.

Nordisk Reisebureau's Filial, St Petersburg, and

for railway tickets, Gothenburg—Stockholm: the British Northern Shipping Co., London.

The foreign competitors were permitted to leave Sweden by a different route than that taken for the journey to Stockholm. The reduction in the fares was for ordinary passenger tickets only, and thus did not effect the extra fares for express-trains, or sleeping berths.

The following regulation was made respecting the free carriage of gymnastic- and athletic apparatus, and other material for the Games:

“The goods in question shall be sent in good time.

The goods shall be addressed: ‘Olympiska Spelen, Stockholm’”.

In order to avoid unnecessary trouble when re-loading, etc., the freight from the place of consignment to Stockholm had to be paid in advance, and then that part of the freight-charges due to the Swedish State Railways was afterwards refunded to the senders.

4,000 copies were printed of the blue identification-card for the journey *to* Stockholm, and a similar number were printed on yellow-brown paper for the journey *from* Stockholm, and then posted to the various Olympic Committees abroad, in accordance with the number asked for by each Committee.

The Swedish Olympic Committee sent a circular to the foreign Olympic Committees, bringing to their notice the regulations issued by the Board of the Swedish State Railways.

Customs Arrangements.

In consequence of letters received from abroad, inquiring whether the athletic apparatus, brought into the country by foreign competitors and which was necessary for the Games, would have to pay any duty, the Swedish Olympic Committee petitioned the Custom House Authorities, begging that the material in question might be imported duty-free. In consequence of this application, the Custom House Authorities issued the following ordinance.

All bulky materials which cannot be conveyed as passenger's luggage, shall, in every case, be addressed direct to “Olympiska Spelen, Stockholm.”

Athletic apparatus, etc., brought into Sweden by the foreign competitors in the Games — such as gymnastic apparatus, athletic materials (poles, putting-shot, discus) fire-arms and ammunition (each competitor in the shooting competitions was allowed to import free of duty, and as personal luggage, two fire-arms and the requisite ammunition), cycles, rowing-boats, footballs, sabres, épées, foils, tennis-rackets, standards and flags, etc., — was allowed to be brought in duty-free, on condition that it was taken from the country again before the end of October, 1912 ; the same regulation was made for articles for the competition in the

"Concours d'Art", such as pictures, sculpture, architecture etc. The goods imported were, however, to be sent either to Stockholm, direct or via Trelleborg, Malmö, Helsingborg, Gothenburg, Mon, Charlottenberg, Storlien or the Riksgränsen station to Stockholm, where the final customs examination was to take place. Horses intended for the competitions in the Games and coming from foreign countries were allowed to be imported on the following conditions: The horses were to be sent to Stockholm direct, or via one of the following places: Trelleborg, Malmö, Gothenburg or Charlottenberg. If the last-named course was adopted, the horses, after a veterinary examination, were to be immediately forwarded from the frontier station to Stockholm, where they were to submit to the final customs examination. The horses had to be taken from the country before the end of October, 1912. The equipments necessary for the horse riding competitions, and the materials intended to be re-exported and which were brought to the country together with the horses, could, even in those cases when the customs regulations in force did not permit of their free import, be employed duty-free by the owners during the time above-mentioned, on condition of a surety being given, and in accordance with the conditions of import mentioned above.

All re-export was to take place under the superintendence of the Customs authorities, after notice had been sent to the Customs warehouse in Stockholm.

Flag Labels.

The Swedish Olympic Committee procured a large number of gummed labels for the luggage of the competitors and officials, in order to mark the luggage of the foreign athletes coming to the Games, so as to avoid confusion and to facilitate the procural of the luggage from the luggage office, and the examination at the customs office. These labels were made in the shape, and with the colours, of the flags of Sweden and the other nations ; on these latter labels, space was reserved for the name and address of the owner. The labels were printed in 27 different editions and in the following numbers:

Labels with the flag of Sweden	10,000
» » » » Australia	50
» » » » Austria	500
» » » » Belgium	200
» » » » Bohemia	200
» » » » Canada	150
» » » » Chili	20
» » » » Denmark	1,000
» » » » Finland	300
» » » » France	500
» » » » Germany	500
» » » » Great Britain	750
» » » » Greece	100
» » » » Holland	200
» » » » Hungary	500
» » » » Italy	300

Labels with the flag of Japan	25
» » » » » Luxemburg	100
» » » » » New Zealand	50
» » » » » Norway	500
» » » » » Portugal	25
» » » » » Russia	600
» » » » » Servia	50
» » » » » South Africa	75
» » » » » Switzerland	50
» » » » » Turkey	25
» » » » » U. S. A.	300

Tramway Traffic.

As it was thought that there would be a large number of visitors to the Olympic Games, and that, in consequence, the tramway traffic would be considerably increased, the Swedish Olympic Committee resolved to write to the Stockholm Tramway Company, pointing out the desirability of special measures adopted being for the convenience of the expected visitors.

In consequence of this communication, the Tramway Company made arrangements to have direct connection during the Games, with trams running every five minutes, between all parts of Stockholm and the Stadium. But to be able to do this, certain arrangements had to be made on the tramway lines, especially in Valhallavägen, where it proved necessary to make a return-curve at the place last mentioned, so that the trams, as soon as they had left their passengers at the Stadium, could return at once to the other parts of the town. This return-curve was made by continuing the siding, already in existence in front of the stables of the General Staff, so as to meet the Vallhallavägen tramway line at Grefturegatan.



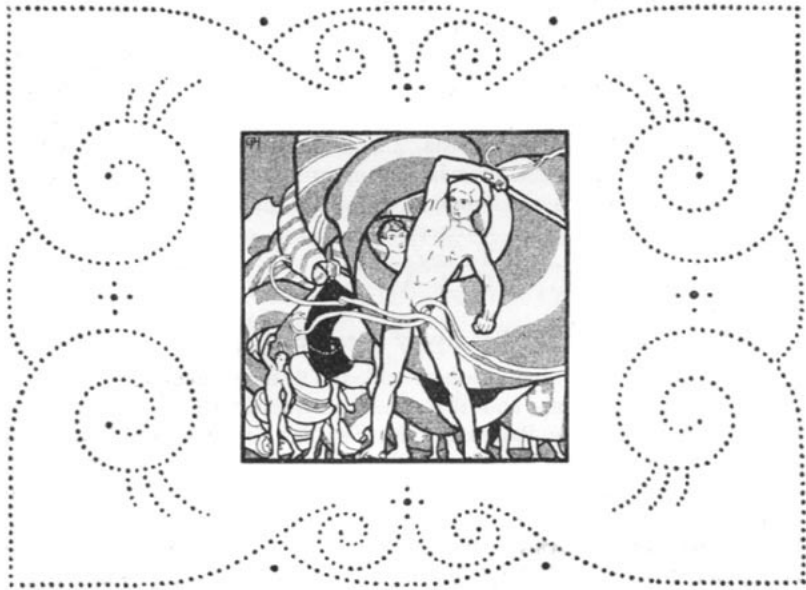

HOW THE OLYMPIC GAMES OF STOCKHOLM 1912 WERE ADVERTISED.

The work of spreading abroad the news of the Olympic Games of Stockholm, 1912, may be said to have begun with the despatch of the first *preliminary invitations* to the Games. These were sent to the Olympic Committees in November, 1910, as soon as the programme in rough had been drawn up, and were mentioned and commented on in the foreign Press.

But before this was done, a number of preparatory measures had been taken for the effective advertisement of the Games by sending to the Swedish Ministers, Consuls and prominent Swedes, etc., abroad, lists of telegram-, news-, and newspaper- cuttings agencies, daily and illustrated newspapers, sporting journals, athletic organizations, Swedish clubs, etc., abroad, — as far as they were known to the General Secretariat in Stockholm — with a request to have these lists supplemented and returned to Stockholm.

Aided by the answers received during the next few months, lists of the above mentioned categories were drawn up in order to serve as guides in the distribution of the advertising printed matter. These lists, after having gradually been completed by supplementary lists, now form an extensive section of the archives of the Olympic Games of Stockholm, and one that may be of great use on future occasions.

Newspaper Cuttings.

To be able to remain *à jour* with the attitude taken by the Press abroad with regard to the Games, and to observe the amount of interest these excited abroad, and thus obtain a means of gauging the results of the work of advertisement as a whole, agreements were made at the close of 1910 and the beginning of 1911 for subscriptions to newspaper-cuttings agencies in the following countries :

Austria	Holland
Belgium	Hungary
Canada	Italy
Denmark	Norway
Finland	Russia
France	Sweden
Germany	Switzerland
Great Britain	U. S. A.

This arrangement proved to answer all expectations, as a vast number of cuttings from every quarter began to stream in to the General Secretariat, while other private and official quarters exhibited their interest by keeping the Committee in this way au courant with the remarks of the Press. These cuttings now fill no less than 325 volumes of 100 pages each.

The General Programme.

At the close of April, 1911, after a series of thorough discussions by the Swedish Olympic Committee and the various sub-committees, the preliminary *General Programme* of the Games, as a whole, lay ready printed in four different editions (English, French, German and Swedish), and were then sent to the Olympic Committees abroad for criticism, preparatory to its being laid before the International Olympic Committee, at the meeting to be held at Buda-Pesth in the May of the same year. In consequence of the expressions of opinion made at the said meeting, it was necessary to make some small modifications and alterations of the programme, so that it was not definitely ready before the close of August, 1911, when the General Secretariat immediately took steps to have it sent all over the world, not only to the leading athletic organizations, but also to the daily- and sporting press, telegram- and news-agencies, the Swedish Ministers and Consuls, Swedish Clubs, tourist-offices, prominent Swedes and various correspondents, abroad.

The programme was issued to a grand total of 193,000 copies as follows :

English	68,100
French	31,500
German	48,200
Swedish	45,200

The official invitation to participation in the Games, accompanied by the above mentioned programme, was sent at the same time by the Swedish Foreign Office to the Foreign Offices abroad.

Circular.

In September, 1911, the permission of the Swedish Foreign Office having first been obtained, the following circular, in English and in Swedish, was sent to 354 of our consuls abroad who were not able to speak Swedish, and to 240 consuls who could do so:

To the Swedish Consuls abroad.

Dear Sir,

In view of the great importance of energetic and systematic advertising, we feel compelled to take every opportunity of drawing the attention of the foreign public to the Olympic Games of Stockholm 1912. We therefore take the liberty of requesting your assistance and advice as to the best possible manner of achieving our object.

At the present moment we are busy collecting a quantity of advertising material, such as *Photographs* (sporting pictures, as well as views of a number of celebrated places in Sweden, and especially of the capital and surroundings), and *Tourist Literature* of various kinds. The books, "Tours in Sweden" and "Holidays in Sweden" — the former in English, French and German, the latter in English only — are now ready for distribution in large quantities at the Secretary's Office, besides which, similar printed matter is being prepared by Companies connected with the tourist traffic), etc.

Picture Post Cards for advertising purposes (with views of Stockholm and surroundings) have already been sent for distribution to a number of the great international exhibitions recently held, and we intend to print a large quantity of such picture-cards, some of which represent the Stadium, with explanatory text in various languages. Such cards may be distributed at exhibitions, or used in correspondence, etc., and we shall have much pleasure in supplying them for that purpose.

The large *Poster*, specially designed for the Games, will be ready at the latter end of the Autumn, together with a reduced facsimile of same (size $4\frac{1}{2} \times 6$ cm.) in the form of a stamp suitable for attachment to letters, cards, packets, etc.

A *Special Brochure* (pocket size, about 14×22 cm.) is in course of preparation, containing photos of celebrated places in Sweden, especially Stockholm and its environs, various maps and detailed information concerning the different routes to and in Sweden, hotels and housing arrangements in general, maps of Stockholm and its environs, summary of the Programme, illustrated articles and artistic vignettes of the different branches of sport represented at the Games, etc.

In our opinion, the most suitable way of advertising would be by distributing the above-mentioned printed matter among the Hotels, Railway Stations, Tourist Offices, Banks, Commercial Firms, Doctors, Solicitors, and other professional men in your town, and by publishing notices and articles in the local press, etc. We, therefore, hope to receive your kind assistance, and should be glad to know which language would be most suitable for your purpose.

The chief object of such co-operation between ourselves and the Swedish Consuls abroad is to *concentrate* the work of distributing the advertising material, so that all such matter can be sent to, and circulated from, *one and the same address in each town*.

As we have reason to believe that the stream of tourists to Sweden from abroad next summer will be very large, we should like to be informed whether the various steamboat- and railway-companies would not be willing to arrange special trips to the Olympic Games, and to have your kind advice, suggestions and proposals in this respect.

Our Committee, however, should not be put to other expense in these matters than such as will naturally arise from the *transmission* of the necessary advertising matter *from Stockholm*.

On enquiry at the Foreign Office it has been elicited that there would be no objection to invoking the kind assistance of the Swedish Consuls in the way indicated above.

A few copies of the General Programme, which has been printed in Swedish, English, French and German, are being forwarded to-day to your address, and we shall be happy to place a further supply at your disposal.

Hoping to have your kind support in this matter, which is of great importance for the success of the Games, we remain, etc.

A month later the following appeal was made in connection with the above circular :

To *Swedes abroad*,

The Olympic Games of Stockholm, 1912 are close at hand, and it is a point of honour for Sweden to make worthy preparations for this great international event. An effective and well organized plan of advertising the Games has already begun, but the co-operation of all Swedes resident abroad and who are interested in the matter, is required to carry this scheme to a successful issue.

We therefore venture to appeal to you for your kind help in this matter and beg specially to call your attention to the enclosed circular, which we sent a few weeks ago to all the Swedish Consuls abroad, and which gives you all further details of the plan we are going to employ for advertising the Games in foreign countries. In our opinion, the most suitable way would be by means of *co-operation with the Consul in your city*, as this means *concentration of the work* and lower postal and other charges, as all the printed matter, etc., necessary for distribution in each town, would then need to be sent to one address only — the Consul's — after a local Committee had informed us of the amount of such matter required.

We need hardly point out the necessity of making use of this opportunity — which is one the like of which will hardly occur again before the lapse of many years — of spreading abroad a better knowledge of Sweden, and we therefore hope to be able to rely on your kind assistance for the realisation of our plans.

We have the pleasure of enclosing a copy of the General Programme of the Games.

This appeal was sent to 69 Swedish newspapers in 6 foreign countries 251 Swedish clubs in 18 countries; 86 representatives of the Swedish Tourist Association in 21 countries, and also to a large number of Swedes abroad interested in the work, besides which, it was printed as an advertisement in the "Svenska Utlandstidningen".

All the Swedish Legations abroad received the circular mentioned above, as well as a little parcel of general programmes, posters, advertisement stamps and special programmes.

The object of these circulars was to obtain as much help as possible from Swedish Consulates and Swedes settled abroad, in the distribution of the various advertisements, so as thereby to concentrate the work and diminish the cost of distribution as much as possible. By this appeal to Swedes in other countries, the General Secretariat managed to obtain quite a number of assistants who were greatly interested in the success of the Games, each of whom did much valuable work by spreading a knowledge of the coming athletic festival in Stockholm.

Great help was obtained in this matter from the Swedish public in general and, more especially, from the large business firms in Sweden, which sent large quantities of advertising matter to their business friends abroad. Special mention may be made of the Nordiska Kompaniet; the Separator Co.; the Lux Lighting Co. and Emil R. Boman, Shipping Agent, all of whom rendered most valuable assistance in this way.

Great help was also obtained from "Sveriges Allmänna Exportför-ening" which kept supplies of various advertising matter at its offices,

and distributed it to its correspondents abroad, among whom may be mentioned the holders of Swedish commercial scholarships who are studying in 9 different countries.

The following appeal was published in February, 1912 in the journal "Svensk Export", the organ of the above mentioned Association

To *Swedish Business Men*,

We take the liberty of calling your attention to the extraordinary importance of an effective and systematically organized advertisement abroad of the approaching Olympic Games, and hereby appeal to Swedish business men travelling abroad, to support us in this matter by carrying with them on their journeys and — eventually, in co-operation with the various Swedish Consulates which have undertaken the chief distribution for their respective cities — to distribute in some suitable way, not only the programme and the little descriptive pamphlet of the Games, which are published in English, French, German and Swedish, but also the *advertising stamp* and, most especially, the large *poster of the Games*, both of which have been printed with text in 16 different languages.

This printed matter can be obtained on written application to "Olympiska Spelen, Stockholm," or on personal application to the General Secretariat, 1 A, Hamngatan.

In addition to this, the General Secretariat was in communication with the most prominent correspondents abroad of the principal Swedish newspapers, who, in several special cases, gave useful advice and assistance.

Communication with Swedes abroad was also kept up by other circulars which were sent to the representatives of the Swedish Tourist Association, to Swedish Clubs and newspapers, and to many private Swedes abroad. These circulars — in addition to the one given on page 261 — were issued on the following dates:

In January, 1912, together with a number of posters and advertising stamps, with the text in the language of the country to which they were sent;

In February and March, 1912, together with a number of copies of the advertising pamphlet in various languages, with a request to the addressees "to assist the work of advertisement in every possible way, especially by co-operation with the Swedish Consulate in your city", and with further instructions as to the best method of effectively advertising the Games.

Besides this, Swedes abroad, who applied for advertising matter, were sent larger or smaller parcels of the various printed articles, accompanied by the appeals with instructions and the request to co-operate with the respective Swedish Consulates.

The Advertisement Committee.

On the 31 October, 1910, the Swedish Olympic Committee determined to nominate a special Advertisement Committee, which, finally, was constituted as follows :

President:..... C. L. KORNERUP, Esq.,
Secretary:..... KRISTIAN HELLSTRÖM, Esq.,
Other Members: CARL HELLBERG, Esq.,
EDVIN MOLIN, Esq.,
GUSTAF ÅSBRINK, Esq.,

The work of advertising the Games growing by leaps and bounds, it proved necessary to organize special expert-committees at the most important centres, under the guidance of the Consuls General or Consuls at the places in question. Their task was to undertake and direct the work of advertising the Games in their respective countries, with the support of, and in the closest co-operation with, the General Secretariat of the Swedish Olympic Committee.

The composition of these committees thus formed on the initiative of the General Secretariat was as follows:

London.

President: Daniel Danielson, Esq., Consul General.
Secretary: Louis Zettersten, Esq., Secretary to the Swedish Chamber of Commerce, London.
Members: Messrs. D. von Braun, John Eberstein. F. Henrikson, Fred. Kreuger, Hugo Vallentin.

Berlin.

President: Axel Moberg, Esq., Consul.
Secretary: John Lönnegren, Esq.
Members: Messrs. G. Blomquist, G. Forssling, O. Thomas.

Paris.

President: G. Nordling, Esq., Consul General.
Secretary: Edv. Berg, Esq.
Members: Messrs. B. Amundson, C. F. Bennet, Edv. Björkman, Sigge Ljunggren, Raoul Nordling, Erik Sjöstedt.

Marseilles.

President: F. A. Westrup, Esq., Consul.
Members: Messrs. V. Cronholm, G. Cruse, C. B. Lilja, A. Lydrikson, O. Sylvander.

Helsingfors.

President: J. Lilliehöök, Esq., Consul General.
Members: Messrs. J. N. Carlander, G. von Bergmansson, Allan Johnson, Ernst Jonsson, Knut Wiborg, Rich. Tegnér.

Holland.

The advertising work was directed by the Consuls in Amsterdam and Rotterdam, and by Mrs. Thérèse Boon, née Clemens, then Secretary of the Swedish-Netherland Association at the Hague.

An Advertisement Committee was also formed, consisting of 14 prominent Dutchmen.

In all the other countries where special advertisement committees were not formed, the work was carried on by the Consuls, with the assistance of persons interested in the matter, who, as a rule, were Swedes.

In January, 1912, another circular (printed in different languages) was sent to the Swedish Consulates abroad. It ran as follows:

To *H. S. M. Consulates abroad.*

Dear Sir,

With further reference to your esteemed letter in reply to our Circular Letter of September last, we have pleasure in sending you to-day, under separate cover, a number of our General Programme, Official Posters and Advertising Stamps.

Being particularly desirous of organizing energetic and systematic advertising

work abroad for the forthcoming Olympic Games, we should be extremely obliged if you would kindly assist us in achieving our object, by distributing the material in the best possible manner, for instance, among:

railway-stations, hotels, boarding houses, restaurants, clubs, tourist-offices, steamship agents and forwarding agencies (for the purpose of being placed in the saloons, etc., of steamers), banks, companies and commercial firms, athletic outfitters, bath- and tennis establishments, booksellers and stationers, doctors, solicitors and other professional men, schools, private persons, etc.

and by publishing notices and articles in the local press, etc.

We beg to point out that — at the initiative and under the guidance of the Swedish Consuls, and with the co-operation of Swedes who are interested in the Games — special Committees have already been formed in various places abroad for the purpose of taking over this advertising work, and we would most strongly recommend such a course being taken in your case.

The Special Brochure will be ready for distribution during the course of February, and we shall then have pleasure in forwarding you a number of copies.

With regard to the pecuniary side of the matter, we beg to refer to our Circular Letter of September last, according to which

the Swedish Olympic Committee should not be put to other expenses for the advertising work abroad than such as will naturally arise from the transmission of the necessary material *from here*, that is to say, freight and duty, etc., incurred on receipt of the package.

In accordance with an arrangement we have come to with the Swedish Foreign Office, we beg you to be so good as to defray these last-named expenses whenever they happen to be incurred, the sums so disbursed by you to be refunded by us in due course.

For the purpose of obtaining a further supply of this or other advertising matter referred to in our Circular Letter, kindly communicate direct with the Swedish Consulate in who will receive a large parcel direct from here.

Thanking you in anticipation for your kind co-operation, we are, etc.

In a third circular, issued in March, 1912, which was accompanied by a number of copies of the advertising pamphlets, the Consulates that wished to obtain further supplies of printed matter were requested to apply to the Advertisement Committees or Consulates in the *various foreign capitals*.

Official Poster and Advertising Stamp.

One of the most important measures taken in connection with the work of advertising, was the adoption of an official Poster. After a thorough examination of several sketches sent in, and after having conferred with prominent Swedish artists in the matter, the Swedish Olympic Committee, at a meeting held on the 27 June, 1911, determined to accept the poster by Olle Hjortzberg, of the Royal Academy, which had been sent in to the Committee in 1910, but had afterwards been slightly altered, representing the march of the nations — each athlete with a waving flag — to the common goal of the Olympic Games. Thorsten Schonberg's poster was placed second, this design representing the entrance of a Marathon runner into the festively decorated Stadium, while, as number three, came Axel Törneman's poster, a javelin-thrower, with the Stadium in the background.



THE POSTER OF THE OLYMPIC GAMES 1912.



Torsten Schonberg's design for poster

The poster, the execution of which was confided to A. Börtzell's Printing Co., Stockholm, was in seven colours, the size being $74\frac{1}{2}$ cm. \times 107 cm. A proof was sent by the firm in the middle of October, 1911, after which the chief part of the order was completed during the course of the next three months, but it was found necessary to order additional copies, to satisfy the large demand for the placard received from various quarters. The same step had to be taken with

regard to the advertising stamp, the advertising pamphlet and the general programme.

It is to be regretted that, in consequence of various circumstances, the poster was not in readiness earlier than 6 months before the Games as, for advertising purposes, it would have been of advantage to have had a greater amount of time available for its distribution, a task that now had to be performed in a very great hurry.

The text was as follows:

OLYMPIC GAMES
STOCKHOLM 1912
 JUNE 29th - JULY 22nd

At first, the poster was printed in 8 different editions, each in a different language, but in consequence of the repeated demands made from several other countries, this number had to be doubled, so that it finally appeared with the text in no less than 16 languages, several of which caused no little difficulty to the printers. The total number of copies of each edition, as determined by the orders received from the various countries, were as follows:

	Brought forward	79,950		
English	26,800	Portuguese	1,850	
German	16,300	Finnish	1,500	
French	13,000	Hungarian	1,400	
Swedish	13,300	Japanese	1,000	
Russian	3,000	Turkish	800	
Spanish	3,000	Greek	750	
Dutch	2,550	Bohemian	750	
Italian	2,000	Chinese	350	
	<u>Carried forward</u>	<u>79,950</u>	<u>Total</u>	<u>88,350</u>

Various opinions have been expressed regarding the value of the poster from an advertising point of view, but it may be said that its artistic merits have been universally acknowledged, and that in a special degree from the most competent quarters.

The *motif* of the poster was criticized, however; many, and influential voices being raised in favour of the adoption of a placard of a purely athletic character — the one proposed being Schonberg's drawing, as this, it was thought, would be far more effective as an advertisement.

Remarks were made from diplomatic quarters, too, fears being expressed that the order in which the various standards were shown on the poster — though their placing was determined by coloristic, and not political, reasons — might perhaps awaken discontent, and give rise to unnecessary disputes; these fears were probably exaggerated, but in several cases proved to be well grounded, the result being that the poster somewhat failed in its object in certain districts, as in some cases a disinclination was shown to exhibit it, this adding very considerably to the difficulty of properly and thoroughly advertising the Games. Another, but more unexpected circumstance contributed to hinder the spread of the poster, this being that, in several

places abroad, especially in hotels and similar public localities, it was categorically forbidden to exhibit it — from moral considerations. This step was taken officially in two special cases, viz., in China, where the Postmaster General forbade the exhibition of the placard as “being offensive to Chinese ideas of decency,” and in Holland, where a poster, which happened to be hanging in a railway station at a little town, was confiscated as being “in the highest degree immoral”. This decision was afterwards rescinded.

The flags of the following nations were seen on the Poster:

Austria	Japan
Belgium	Luxemburg
China	Norway
Denmark	Portugal
France	Russia
Germany	Spain
Great Britain	Sweden
Greece	Switzerland
Holland	Turkey
Hungary	U. S. A.
Italy	

A reproduction of the poster on a greatly diminished scale, or $4\frac{1}{2}$ cm. \times 6 cm., executed in 6 colours, and supplied in perforated sheets, each containing 81 stamps, was employed as an advertising stamp, intended to be placed on postal communications. The first specimen copies of these stamps, which were supplied by the A.-B. Centraltryckeriet, Stockholm, were received in the middle of October, 1911, the edition being printed during the course of the next two months, but a large number of extra copies had afterwards to be printed to supply the further demand. They were issued with the text in the following languages:

		Brought forward	4,539,900
English	2,337,000	Finnish	43,500
German	712,800	Italian	40,900
French	651,300	Bohemian	40,000
Swedish	554,600	Japanese	27,500
Spanish	100,300	Turkish	27,400
Russian	89,000	Greek	25,400
Portuguese	47,700	Hungarian	20,300
Dutch	47,200	Chinese	17,300
Carried forward	4,539,900	Total	4,782,200

The above figures speak very clearly of the immense use that was made of the advertising stamp on postal communications at home and abroad, and of the vastness of the demands that literally flowed in, both from private persons, firms and institutions, in Sweden and abroad. As a example it may be mentioned that, during the course of 8 months, the General Secretariat received about 1,500 *direct* written requests from private persons in Germany to be supplied with the stamp.

For the purpose of being able to issue instructions to the public with regard to the use of this advertising stamp on postal communications in Sweden and elsewhere, the General Secretariat sent a circular to the Swedish Legations and General Consulates abroad, asking for

information respecting the regulations in force in foreign countries with regard to the use of such advertising stamps on postal communications. The answers received, of which a summary is given below, were all in the hands of the General Secretariat by the close of December, 1911.

Countries where the Olympic advertising stamp was allowed to be used on postal communications:

The Argentine,	India,
Austria (not on letters containing valuables),	Italy,
Belgium (with the exception of inland newspaper wrappers),	Japan,
Brazil,	Mexico,
Cuba,	Norway (not on postcards),
Denmark (excepting on postcards and letters containing valuables),	Portugal,
Egypt,	Russia (not on letters containing valuables),
France,	Servia,
Germany (only on the back),	South Africa,
Great Britain (» » » »)	Spain (not on letters containing valuables),
Holland (not on printed matter),	Switzerland (not on postcards),
Hungary,	Turkey (only on the back),
	U. S. A. (» » » »)

The Postal Authorities of all these countries expressed the wish, however, that the stamp should be placed only on the back.

Countries where the use of the advertising stamp was forbidden:

Canada (use of advertising stamps always forbidden),
 China ("because the Olympic Advertising Stamp, although very artistically executed, is offensive to Chinese ideas of decency"),
 Finland (the prohibition of the use of advertising stamps on postal communications is, it is true, still in force, the delivery of letters, etc., with such stamps attached is, however, generally not hindered).

Distribution of the advertising material.

In order to be able to obtain early information as to the most suitable and the cheapest method of distributing the advertising matter to the various foreign countries, the Foreign Office was requested, on the 4 November, 1911, to make inquiries through the Legations and the General Consulates in Europe, and through the Legations in Washington and Tokio, as to the regulations in force in the countries in question with respect to the introduction of printed matter, and also (and in what degree) if there was any prospect of an application for the import, duty-free, of such advertising matter in the said countries — or on the payment of a lower duty in such instances where printed matter was subject to customs-charges — gaining the assent of the respective Governments.

The following table shows the result of this inquiry:

Countries into which printed matter could be imported free of duty:

Austria,	India,
Canada,	New Zealand,
Denmark, (with exception of the poster),	Norway (see below),
Germany (» » » »)	Roumania (see below),
Great Britain and most of its Crown Colonies,	Spain (see below),
Greece (see below),	Turkey,
Holland,	U. S. A. (see below).

The Advertising Stamp, and the text in various languages



English.

HRV OLYMPIJSKÉ
STOCKHOLM 1912
29 ČERVNA - 22 ČERVENCE

Bohemian.

OLYMPIALAISET KISAT
TUKHOLMASSA 1912
KESÄK. 29 P. - HEINÄK 22 P

Finnish.

奥林匹克运动会
斯德哥尔摩 1912
六月二十九日 - 七月二十二日

Chinese.

JEUX OLYMPIQUES
STOCKHOLM 1912
LE 29 JUIN - 22 JUILLET

French.

OLYMPISCHE SPELEN
STOCKHOLM 1912
29 JUNI - 22 JULI
Dutch.

OLYMPISCHE SPIELE
STOCKHOLM 1912
29 JUNI - 22 JULI
German.

ΟΛΥΜΠΙΑΚΟΙ ΑΓΩΝΕΣ
↳ ΣΤΟΚΧΟΛΜΗ, 1912 ↳
16 ΙΟΥΝΙΟΥ 9 ΙΟΥΛΙΟΥ

Greek.

JOGOS OLYMPICOS
↳ STOCKHOLMO 1912 ↳
29 DE JUNHO - 22 DE JULHO

Portuguese.

ΟΛΙΜΠΙΑΙ ΙΑΤΕΚΟΚ
↳ STOCKHOLMBAN 1912 ↳
JUNIUS 29 - JULIUS 22

Hungarian.

ОЛИМПІЙСКІЯ ИГРЫ.
↳ СТОКГОЛЬМЪ 1912 ГОДЪ ↳
СЪ 16/29 ІЮНЯ ПО 9/22 ІЮЛЯ.

Russian.

GIUOCHI OLIMPICI
↳ STOCOLMA 1912 ↳
29. GIUGNO - 22 LUGLIO

Italian.

JUEGOS OLÍMPICOS
↳ STOCKHOLMO 1912 ↳
29 JUNIO - 22 JULIO

Spanish.

全日本選手権
夏季オリンピック
競技會
1912年
ストックホルム

Japanese.

OLYMPISKA SPELEN
↳ STOCKHOLM 1912 ↳
29 JUNI - 22 JULI

Swedish.

OLYMPISKA SPELEN

STOCKHOLM 1912

Turkish.

Countries where import duty had to be paid:

Australia,	Portugal (with exception of advertising pamphlet),
Belgium (with the exception of the advertising pamphlet),	Russia,
Bulgaria,	Servia (with exception of advertising pamphlet),
France,	South Africa,
Italy (with exception of programme and pamphlet),	Switzerland.
Japan (with exception of programme and advertising pamphlet),	

Through the kind offices of the Foreign Office the following concessions were obtained from the countries mentioned below:

GERMANY:

Freedom from duty for advertising pamphlet, as coming under the category "Literarische Erzeugnisse".

GREECE:

The Poster to be admitted duty free, if addressed to the Greek Olympic Committee.

NORWAY:

A Royal ordinance allowed all printed matter in connection with the Olympic Games to be imported duty free.

ROUMANIA.

All advertising matter, addressed to the Swedish Consul General in Bucharest, to be admitted duty free.

SPAIN:

All printed matter (up to a weight of 400 kg.) to be admitted duty free, if sent by the Swedish Foreign Office to the Swedish Legation in Madrid.

U. S. A.:

All printed matter to be admitted duty free, on condition that it was sent by the Swedish Foreign Office to the Swedish Consulate in New York, by which it was to be distributed.

In order to obtain the remission of duty in Greece, Roumania, Spain and the U. S. A., all the advertising material intended for these countries was sent there in accordance with the regulations prescribed in each case.

It may be mentioned, in this connection, that the exhibition of the poster in Belgium and France necessitated the payment of special stamp duty, which was calculated to hinder in no slight degree its spread in these two countries. And according to what was stated by the representative of the Swedish Tourist Association, a certain fee had to be paid to the "Gastwirtschaftsverein" of Dresden for permission to hang up the poster in the hotels, restaurants and cafés of that city.

The poster, of which, as mentioned above, no less than 88,350 copies were printed, was spread very widely throughout the world, in spite of its being boycotted in certain places. It was distributed in the first instance — either direct from the General Secretariat, or through local committees — to

hotels, boarding-houses, restaurants and cafés, theatres, circuses, moving-picture shows and other places of amusement; clubs and business premises, post-offices, chemist-shops, booksellers, and cigar-dealers, barbers, and other shops, libraries, and reading-libraries, newspaper agencies, tourist- and athletic associations, schools, consulates, tourist- and shipping-offices; doctors, lawyers, steamboats, railway stations, sporting-, bathing- and tennis-establishments, gymnastic institutes, athletic grounds, riding-houses, officers' messes, barracks, official institutions, etc.

Posters, among other things, were sent direct from the General Secretariat to more than 2,200 hotels in 636 towns, representing 30 countries.

In agreement with the fixed determination come to by the Swedish Olympic Committee, according to which the Committee was not to be saddled with other expenses for advertisement in foreign countries than those necessitated by the cost of distribution, there was, as a rule, no payment made for the setting up of the said posters on kiosks and public advertising places, as this would have occasioned a very great expenditure. The following exceptions were made however:

London: in collaboration with the Swedish Tourist Association, placards were posted up in the stations of the underground lines, two posters being placed in every station, one advertising Sweden as a land for tourists; the other being the Olympic poster.

Paris: About 100 posters were put up in central places, such as the neighbourhood of railway stations, etc., this being done by an advertising bureau in the city. In addition to this, an agreement was made, by which some 30 posters were exhibited for a month in some of the most prominent places along the great Boulevards.

S:t Petersburg: The Consulate undertook the posting up of the placards in the restaurants at the more important railway stations of S:t Petersburg and the surrounding district.

Belgium: A favourable agreement was made, by which 400 posters were put up in specially reserved, prominent places in Brussels and other cities of Belgium.

Through the kind offices of the Swedish Legation in Berlin, permission was obtained to have the placard posted up in all the larger railway stations in Germany, not less than 3,000 copies on rollers being used for this purpose. The Legation in Brussels, after the Swedish State Railways had agreed to permit the exhibition of an equal number of Belgian placards, obtained permission to have 225 copies of the poster put up in the stations of the Belgian State Railways, and in the railway stations of the two principal private railway lines in Holland.

After direct negotiations by the General Secretariat, an agreement was made with the Nordbrabant-Deutsche Eisenbahn-Gesellschaft (representing the Flushing-Queenborough-London route) respecting the posting up of some 200 posters in the more important railway stations of the Company, in addition to which the Swedish Consulate in Amsterdam succeeded in having a large additional number of posters put up in a great many large railway stations in Holland.

With respect to France, the Advertising Committee formed in Paris obtained permission of the Directors of the State Railways and of the Chemin de Fer du Nord-, Lyon-, L'Ouest- and Orleans Railway Co:s, to post up a total of 600 placards in the stations of the different Companies, which were also given, for gratis distribution, circa 1,000 copies of the advertising pamphlet. The poster was also exhibited in all the large railway stations along the Riviera.

The Great Eastern Railway Co. in England, received 100 placards for its Continental Department, and for exhibition in its booking offices. The North Eastern Railway also made use of the poster.

In addition to the placards posted up in the above-mentioned railway stations, our Consuls and other interested persons obtained permission for copies to be placed in a number of railway stations along lines in other countries, when this step did not occasion any special expense.

As a supplement to the official advertising poster, the General Secretariat had a miniature poster printed, of dimensions varying between 14 cm. × 21 cm., and 26 cm. × 16 cm., these placards being mounted on stiff cardboard and provided with a string.

This dwarf poster, which was executed in three colours, was printed in the following editions:

German	20,800	copies
Swedish	7,100	»
English	1,500	»
Russian	1,000	»
French.....	500	»

Through the kind offices of Herr Herrmann Stilke, Bookseller, Berlin, 5,000 copies were hung up gratis in his newspaper-kiosks and book-stalls, at the railway stations and principal hotels of 92 large German cities, besides which the "Hotel-Säulen-Gesellschaft" in Berlin had a considerable number put up on the advertisement-pillars in the principal hotels of the German capital. (In parentheses it may be mentioned that Herr Stilke ordered no less than 25,000 advertising-pamphlets and 5,000 general programmes, for free distribution at the above mentioned kiosks and stalls. Some few hundred copies of the Russian edition were hung up in shops and similar premises in S:t Petersburg.

Through the Swedish Legation in Berlin, an agreement was also made with the Königl. Eisenbahn-Direktion, by which 7,500 copies of the smaller-sized poster were hung up in the German corridor railway carriages.

The Board of the Swedish State Railways acceded to the request made by the General Secretariat, to be allowed to place advertising material such as posters, advertising stamps, programmes and advertising pamphlets, on the steam ferry-boats of the Sassnitz—Trälleborg-route to Sweden.

Similar permission was granted with respect to the ferry boats running between Helsingör—Helsingborg, and on the steamers of the Öresund Steamboat Comp. (obtained through the Swedish Consulate in

Copenhagen) and the vessels on the following lines: the English and Dutch channel steamers; the steamers of the Norddeutscher Lloyd's and the Hamburg—America C:o.'s Lines (no less than 1,000 advertising-pamphlets were asked for by the Company last mentioned); and of the Allan-, American-, Anchor-, Cunard-, Dominion-, Scandinavian-American-, White- and Red Star Lines.

In January, 1912, there were sent direct from the General Secretariat to 812 tourist offices in 38 countries, a number of general programmes and posters (the text, as far as possible, being in the language of the respective countries) as well as a number of circulars with a list of contents of the advertising pamphlet then in course of preparation, which letter was afterwards sent in the February and March of the same year; the parcel was accompanied by a notice to the effect that additional printed matter could be had on application to the nearest Swedish Consulate.

The request made by the Swedish Olympic Committee for the display and distribution of the printed matter in the tourist offices in question was, as a rule, granted, especially by Thos. Cook & Son who sent an order for several thousand copies of the advertising-pamphlet, for distribution by their offices in various parts of the world, while, in many places, the firm displayed the advertising-posters, etc., in their windows.

Through the mediation of the Legation in Berlin, the "Königl. Eisenbahn-Direktion" in that city expressed its willingness to distribute 800 copies of the above-mentioned pamphlet and of the programme of the Horse Riding competitions, by means of their tourist offices.

In consequence of the fact that the pamphlet, as a matter of principle, mentioned only a few of the most important travelling routes and tourist offices, a number of these latter establishments, those in Paris especially, could not be persuaded to display any great zeal for the spread of the pamphlet in question.

The Steamboat Co.'s mentioned above, received masses of posters, general programmes and pamphlets, not only for the purpose of displaying them on board their vessels, but also for the purpose of distribution by thousands of sub-agents. Some of the Companies printed special advertisement circulars themselves, while others, such as the Scandinavian—American Line, advertized the times of sailing most suitable for those intending to visit Stockholm during the Games, of which the date was given.

Advertising Pamphlet.

Another means employed for the advertisement of the Games was the publication of an advertising pamphlet intended to arouse the attention of such persons abroad as were not directly interested in athletics, by giving a short account of the organization of Swedish athletics, together with all necessary information respecting travelling routes to Sweden, and the advantages possessed by the country as a field for tourists.

The pamphlet, which was illustrated with photographs and vignettes the latter by Thorsten Schonberg, contained the following articles:

The work of the International Olympic Committee.

An account of the Stadium.

The organization of Swedish Athletics.

Travelling routes to Sweden, with a list of the direct routes from all the countries of Europe to Stockholm, together with a list of fares, etc., and illustrated by clear maps showing the lines possessing through communication with Sweden.

A description of Stockholm, with a map showing the position of the Stadium and other places for the Olympic competitions, together with a review of Sweden from a tourist's point of view, the whole illustrated by a series of choice illustrations showing various places in Sweden. A rough sketch of the programme of the Games ; information respecting the sale of tickets and accommodation for visitors, together with lists of the members of the International Olympic Committee and the Swedish Olympic Committee.

The pamphlet in question, which was printed by the close of January, 1912, and immediately sent to every part of the world, was everywhere received with the very greatest interest, as is shown not least by the many favourable press-notices. The following figures prove that it performed its mission very well, and that there existed a very lively demand for the little book, of which no less than 245,600 copies were printed, viz.:

English	104,500	copies
German	65,800	»
French	44,800	»
Swedish	30,500	»

An abbreviated, revised edition of the pamphlet was published in Finnish, in April, 1912, through the Advertisement Committee in Finland. 15,000 copies were printed and then distributed as a supplement to the country edition of one of the largest of the Finland daily newspapers. Another important Finnish newspaper distributed, gratis, 1,000 copies of the original Swedish book.

About the same date, and at the initiative of the Berlin Advertisement Committee, there were issued some 15,000 copies of an abbreviated edition of the pamphlet in German, which was spread throughout the whole of Germany.

Literary and Journalistic Advertising.

Both in the Swedish and the foreign Press, the preparations for the Games were followed with a never-failing interest, the best proof of which is shown by the collection of newspaper-cuttings already mentioned, as now being in the archives of the Swedish Olympic Committee. There was probably no paper of any importance anywhere in the world that did not mention the Games in one form or another. The final General Programme was sent at the beginning of September, 1911, to a total of

1,608	daily and illustrated papers	in 41	countries
402	sporting journals	» 37	»
145	Telegram- and News Agencies	» 32	»
37	Press Illustrations Agencies	» 17	»
69	Swedish journals abroad	» 6	»

while, in February, 1912, each of the papers, etc., mentioned above, was sent a copy of the advertising pamphlet.

Every now and then, the telegram agencies, the sporting Press, and the Swedish journals abroad, received communications intended for publication, concerning the work of organization and training, in addition to a mass of printed matter, such as special rules, posters, advertising-stamps, etc., in addition to which, leading journals and the sporting Press all over the world, as well as the Swedish papers, were sent views of Stockholm and its environs (taken by Oscar Hall-din, Photographer to H. M. the King); a specially chosen collection of photographs illustrating various branches of athletics; views of the Stadium (with a description of the building) and the other places chosen as the scenes of the coming competitions (Nynäshamn, Råsunda, the Östermalm Athletic Grounds, and the Tennis Pavilion at the same place); views along the route of the Cycling Race round Lake Mälär; photographs of the poster, the prize diploma, the prize- and commemoration medals, the badges for the competitors and the officials, the challenge prizes, etc. These illustrations were published in hundreds of foreign journals, especially in the papers of the capitals, which, in many cases, filled several sides with the views placed at their disposal.

The various advertisement committees spoken of above, and the Swedish Consulates, also kept the sporting- and tourist organs, the daily and illustrated journals, etc., well supplied with communications and illustrated articles, sent from the General Secretariat. Great importance can probably be ascribed to this literary and journalistic advertising of the Games.

In the spring of 1912, "Le Temps" of Paris, issued a special "Sweden number" (of which 60,000 copies were printed), containing, among other things, portraits of the members of the Royal Family of Sweden, short illustrated articles respecting the political, financial and industrial life of the country, together with an illustrated notice of the coming Olympic Games. The paper was edited by Mr. Erik Sjöstedt, of the Advertisement Committee in Paris.

At the request of the Swedish Tourist Traffic Association, a "Sweden number" of the German Tourist journal "Welt auf Reisen" was also issued, containing a detailed account of the preparations being made for the Games.

Mention must specially be made of the valuable assistance the Committee received from the Swedish Press abroad, that of the U. S. A. in particular, which most kindly did everything in its power to answer the appeal made by the General Secretariat in its circular of the 20 October, 1911: "to make the Games the subject of as many articles as possible in the columns of your paper".

In March, 1912, another appeal was sent to the Swedish journals in the U. S. A., addressed to Swedish American athletes, and begging them to prepare themselves, by means of a rational system of training, to represent Sweden in the approaching Games.

Other measures employed for advertizing the Games.

In addition to the General Programme of the Games, so often mentioned, there were also issued *special programmes*, containing rules

and regulations for the various branches of athletics. No less than 121,500 copies of these special programmes were published, in accordance with the table shown on page 22.

The General Secretariat, as regards its advertizing labours, worked in the closest collaboration with the Swedish Tourist Association and the Swedish Tourist Traffic Association. A great amount of advertizing material was sent on various occasions to the representatives of the first Association in Sweden and abroad, for distribution in various places, and, in many instances, the assistance thus rendered by the Association proved of the greatest value.

Most advantageous and prominent advertisements, with photographs of the Stadium and information respecting the various competitions at the Games, were published gratis in the little guide-books published by the Tourist Traffic Association and entitled "Tours in Sweden", "Excursions en Suède" and "Reisen in Schweden" of which, during 1911 and 1912, no less than 506,000 copies were issued (German 256,000; English 142,000; French 88,000 and Russian 20,000). Similar advertisements also appeared in the Association's pamphlets "Winter in Sweden" and "Winter in Schweden" of each of which little books 20,000 copies were published. Considerable numbers of these guide-books were placed at the disposal of the General Secretariat, for distribution by means of the Advertisement Committees abroad, etc.

Valuable assistance was also given by the representatives abroad of the Tourist Traffic Association, the Swedish Tourist Office ("Svenska Resebyrån") in Berlin especially, which, under the guidance of the Advertisement Committee in Berlin, was exceedingly active in distributing large masses of advertising material over the whole of Germany and the surrounding countries. In the windows of the Tourist Office mentioned, and which has a very central situation in the German capital, there was exhibited a fine collection of views of attractive scenery in Sweden, a choice selection of photographs of Swedish athletic events, the official poster, the programmes and the pamphlets, etc., in addition to which, the printed matter, and picture post-cards with views of Stockholm, etc., were distributed gratis by the office. The Paris representative of the Association, the American Express Co., undertook the distribution to its branch-offices and correspondents in France and America of no less than 5,000 advertising-pamphlets and 10,000 "Excursions en Suède", and Nielsen & Lundbeck, the New York representatives of the Association, distributed 20,000 copies of "Tours in Sweden".

For economical reasons, the General Secretariat did not advertise in any foreign papers. An exception was made however, in the case of the important organ, the "Daily Mail", in whose Continental Edition a small advertisement ($17 \frac{1}{2}$ cm. \times 6 cm.) was published on Saturdays on the first page, twice during 1911, and 13 times during the spring of 1912. This advertisement was as shown on p. 278:

In addition to this, an agreement was come to respecting the insertion, 13 times during the summer of 1911, of a mention of the Games

OLYMPIC GAMES of STOCKHOLM 1912

JUNE 29th—JULY 22nd.

Postal Address: OLYMPISKA SPELEN, STOCKHOLM.

in the space reserved on the first side of the same newspaper for the artistic advertisement inserted by the Swedish Tourist Traffic Association, with a heading "Sweden".

In both these agreements, the paper undertook to publish frequent notices and articles respecting the Games.

Finally, the Committee succeeded, as we have already mentioned,

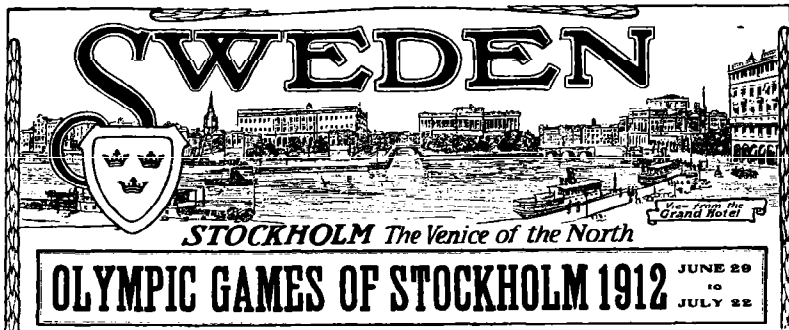

in obtaining gratis-advertisements in the little guides published by the Swedish Tourist Traffic Association ("Tours in Sweden", "Excursions en Suède", "Reisen in Schweden"), besides which, a similar whole-page advertisement (with a view of the Stadium, the dates of the competitions, etc.), was obtained gratis in the Tourist Hand-book "Holidays in Sweden", published by the Thule S/S Co.; 7,000 copies of the pamphlet were placed at the disposal of the General Secretariat for distribution in England. Short advertisements were also obtained, gratis, in the printed matter published by various S/S and Private Railway Cos.

Thos. Cook & Son in London, the world-renowned Tourist Agents, and the Great Eastern Railway (England), as well as the Emigration Agents "Bröderna Larsson & Co.", Stockholm, and other, similar firms, published special illustrated pamphlets concerning the Games.

A great number of picture post-cards with views of Stockholm, and with the heading (in English, French and German):

THE OLYMPIC GAMES OF STOCKHOLM, 1912

29 June—22 July

was printed for gratis distribution among hotels, steamboats, clubs, exhibitions, large foreign vessels arriving at Stockholm etc. Of these

cards, 7,500 copies were sent in May, 1911 to "the Exhibition of Modern Swedish Art" at Brighton, and, during the course of the summer of the same year, to the Tourist Exhibition in Berlin (10,000 copies); 5,000 copies were sent to the exhibition at Turin, and 5,000 copies to the International Exhibition of Hygiene in Dresden, 1911.

Other advertising measures were also taken at these exhibitions. At that in Berlin, for example, there was erected a large poster, visible in all directions, with the inscription in German:

OLYMPISCHE SPIELE IN STOCKHOLM 1912

29. Juni—22. Juli.

A similar display-sign advertisement (of glass), with the text in black and white in English, was procured for the Brighton Exhibition.

In the moving-picture show in connection with the Berlin Exhibition a special advertisement for the Games was also inserted.

A very welcome and effective extra advertisement was obtained through the kind offices of the Swedish General Postal Department which, in response to an appeal made by the Swedish Olympic Committee on the 22 March, 1912, issued an advertisement-stamp, as shown below, which was to be placed on all the letters issuing from, and stamped by, the electric stamping-apparatus of the Post Office, Stockholm 1.

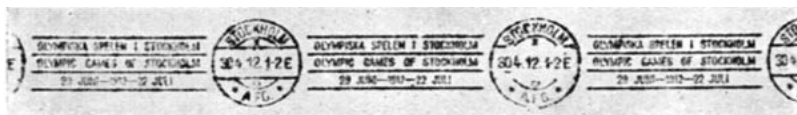

Postal Advertisement-Stamp.

Mention may also be made of advertisement given to the Games by the official New Year's Card, reproduced on the next page, which the staff of the Stockholm Telegraph Office sent at the beginning of 1912 to about 300 of the most important telegraph centres in Europe and other parts of the world.

The illustration and text, printed in a beautiful brown tone, were surrounded by a delicate, light-green frame, above which was printed the Royal Arms of Sweden, in relief.

The Stockholm Statistical Office, in consequence of the request made to the Corporation of Stockholm by the Swedish Olympic Committee, issued an elegant, illustrated statistical handbook to Stockholm in French, entitled

"Stockholm, quelques données statistiques publiées à l'occasion des Jeux Olympiques le 29 Juin—22 Juillet 1912 par le Service municipal de statistique".

Of this book, 300 copies were placed at the disposal of the Swedish Olympic Committee for distribution to Swedish and foreign hono-riaires, etc.

A lively correspondence was kept up the whole time with the athletic world abroad. At the beginning of September, 1911, the General Programme was sent to no less than 657 leading athletic organizations in 43 countries ; in December, the same year, these organizations received two posters, with the text in the language of their respective



New Year's Card issued by the Swedish Telegraph Officials, 1912.

countries, and in March, 1912, they were sent a number of copies of the advertising pamphlets.

During the organization of the Games the General Secretariat was also in regular correspondence with the members of the International Olympic Committee and with the Olympic Committees abroad, and also with a very large number of private persons, firms, institutions and organizations in Sweden and abroad.

Distribution Office.

As the General Secretariat of the Swedish Olympic Committee soon proved quite insufficient for the ever-increasing work of the distribu-

tion of the advertising printed matter, there was arranged, at the close of 1911, in the spacious premises of the Frey Express Co., in Stockholm, a special office for warehousing and forwarding the matter in question, great assistance being received from the experienced staff of the Company.

As an illustration of the work entailed by this distribution of printed matter by the General Secretariat, it may be mentioned that no less than 30,957 parcels of printed matter were sent by book-post between September, 1911 and June 1912.

The work of distribution carried on by the Committee was facilitated, in no slight degree, by the great help afforded by several Steamship Co's. Agents, through whose kind offices permission was obtained to send parcels of advertising-material free of charge by boats running to foreign ports. Mention may be made of the following Companies, etc.

<i>Steamship Cos.:</i>	<i>Parcels despatched to:</i>	
A. B. Svenska Ostasiatiska C:o. Svenska Levant-Line.	China and Japan. Mediterranean harbours.	{ pr. Dan. Bro- ström.
Thos. Wilson, Sons & CO, Ltd.	London—Hull and Hull—North America.	{ pr. Emil R. Boman.
Stockholm's Rederi A. B. Svea. Rederi A. B. Nordstjerman.	Germany, Holland, and Russia. South America.	
Finska Angfartygs A. B.	Finland and Russia.	{ pr. Nyman & Schultz A. B.
Ångfartygs A. B. Bore.	Finland (via Åbo).	{ pr. Aug. Lindholm.
Scandinavian—American Line.	Copenhagen—New York.	
A. B. Sandström, Stranne & Co.	Gothenburg—Cuba—Mexico.	

Advertising the Games in Sweden.

As regards the *advertising of the Games in Sweden*, it may be mentioned that the various supplies of printed matter, as soon as they were printed, were distributed both to private persons and to institutions, organizations, corporations and business-firms all over the country.

Direct distribution was carried out in Stockholm and its environs to the following places:

Hotels, boarding-houses, restaurants and cafés, etc.

(These, immediately before the Games began, were also given the detailed, daily programmes for the various branches of sport, showing the time and place for each of the competitions);

social-, political-, technical- and youths' Clubs ;

reading-rooms, people's libraries, school libraries ;

newspaper- and advertising agencies ;

banks, insurance companies, business-firms, shops etc.;

high schools, commercial schools, popular educational establishments ;

athletic stores, swimming establishments, tennis courts, athletic grounds etc.

In addition to this, parcels were sent direct to

some 600 hotels, etc., at 181 places in the country,

large booksellers at 123 different places;

more than 500 athletic organizations at 272 places, as well as to private members of the committees and to the officials ;
tourist-offices, railway-, and steamship co.'s. ;
all the regiments and shooting-, riding-, and military schools in Stockholm and the country, as well as to the Royal Naval stations in Stockholm and Karlskrona ;
150 newspapers in Stockholm and 64 other towns ;
the Legations and 313 Consulates of Foreign Powers, representing altogether 42 countries.

By means of advertisements and notices, the business-firms of Stockholm and the country were instructed to ask for the advertising poster, or the dwarf placard, for exhibition in shop-windows, from the Placard Distribution Office of the Olympic Games.

As, however, the charges for carriage would have been too heavy had the printed matter been sent direct to the various places in the country, as mentioned above, a circular, accompanied by a number of posters and advertising stamps, was addressed, in December, 1911, to the representatives of the Swedish Tourist Association in 63 places in Sweden, with a request to distribute the Posters and stamps at the spots in question, or at the following places in the surrounding districts:

railway stations, hotels, boarding-houses and restaurants, tourist offices, banks, insurance Co.s. and business-firms, athletic stores, booksellers, stationers, private persons, etc.

the circular pointing out, at the same time, that additional copies could be had on application.

For purely economical reasons, no posters were placed in the advertising spaces on the Swedish State Railways, as this space is let to a special advertising agency; but a number of private Swedish Railways allowed the poster to be exhibited gratis at the stations along their lines.

The Board of the State Railways, however, permitted the dwarf poster to be hung up in the carriages of the Swedish State Railways (one copy in each corridor carriage), during the period April—July, 1912, a total of 3,300 copies being distributed for this purpose amongst the various railway traffic districts.

Local Advertising.

In addition to this, agreements were made respecting the display on the advertisement pillars and kiosks in Stockholm, of the daily poster with the detailed programme of the day's competitions, this poster also being exhibited on boards put up by the town authorities, on application by the General Secretariat, in the central quarters of the town. These posters — which, in the afternoon, were supplemented by short notices of the chief events of the following day — were spread by the General Secretariat over the whole city, both by means of "sandwich-men", and also by a large advertising van, specially arranged for the purpose.

The Swimming competitions were also advertised by means of a poster, with the accompanying illustration :

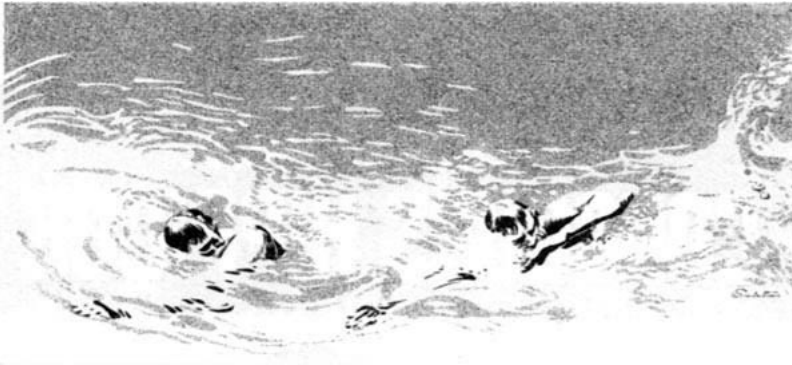

Heading of Poster for Swimming Competitions.

and, finally, the Horse Riding competitions published a large, imposing poster as shown on the following page.

The above account is intended to be a brief summary of the general measures taken to advertise the Olympic Games of 1912, but space does not permit any lengthy mention of the details of the work in every country.

On the whole it may be said, without any exaggeration, that never before has any Swedish enterprise been the object of such comprehensive and effective advertising as the Olympic Games. For this the Swedish Olympic Committee owes a deep debt of gratitude, first and foremost to the Swedish Legations and Consulates and to the Advertisement Committees abroad — all of which performed the work with singular interest, ability and clear sightedness — and then to all the institutions and private persons that have assisted the Committee in its labours.

The advertising measures were not undertaken merely with a view to the Games alone, but, in every quarter, an attempt was made to employ the opportunity thus given — an opportunity the like of which will probably not occur again before the lapse of many years — of making Sweden known to the world as a place to which the tourist could profitably turn his steps. It is, we think, undeniable that the Olympic Games and the advertising of this grand athletic festival has directed attention in a very high degree to Sweden as a tourist resort, and that in circles which, before, had perhaps not once bestowed a thought on the matter.

Unfortunately, however, the stream of visitors to the Games was not of the dimensions that Press communications and expressions of opinion from competent quarters had given us reason to expect. This can be ascribed, in very great measure, however, to the wholly unfounded and misleading rumours which appeared, now and then, in the foreign Press, and which stated that there was little accommodation in Stockholm, and that fabulous prices were demanded for such rooms as were to be had.

As early as the close of January, 1912, the Swedish General Consulate in London called the attention of the Swedish Olympic Committee



Poster for Horse Riding Competitions.

to these rumours, which had been visible in the English Press in paragraphs with the heading, "Scarcity of Accommodation". These altogether erroneous notices stated that the measures taken by the German Olympic Committee for the quartering of the German athletes

had been attended with the greatest difficulties, and that the representatives of the Committee in question had only succeeded in reserving a very few rooms, and that at exorbitant prices. The Advertisement Committee in London at once published an authoritative denial in the daily press in England.

Some weeks later the Secretary of the Swedish-Netherland Association reported that "Press notices are frightening people here by stating that no rooms are to be had, or that the charges are almost prohibitive".

In April, a notice went the round of the American press entitled "Big Purses needed for Olympic Games. Boarding House Trust at Stockholm", according to which all the rooms at the large Stockholm hotels were already taken, and high prices were being charged for rooms in pensions and in private houses.

In the month of May, similar articles appeared in the Norwegian and Danish press, appearing in the latter under the title of "Extortion: 18/- a day for a furnished room, without board, during the Olympic Games in Stockholm."

It is much to be regretted that such rumours arose to diminish the number of visitors to the Games. The reports may possibly be ascribed to the disinclination shown by Stockholm hotels and pensions to definitely let their rooms 6 months in advance, when representatives from some Olympic Committees abroad made inquiries respecting accommodation for the various contingents of athletes.

The Committee — which, at an early period, endeavoured by every means in its power to give accurate and quieting information through the various Consulates and Advertisement Committees abroad, with respect to the actual state of things concerning rooms and board in Stockholm, — now attempted to have a final denial spread throughout the world by means of the Swedish Telegram Agency. This attempt was only partially successful, as one of the largest foreign telegram agencies would not publish the statement, stating it to be "a puff which could only be published on payment of a correspondingly high tariff."

In spite of the comparatively small number of visitors from abroad, the enormous amount of advertising work cannot be said to have been thrown away, as the tourist offices consider that its results will not be seen before the lapse of a few years, experience showing that the real and best class of tourists always avoids countries and places where exhibitions, etc., are going on, which is calculated to make prices dearer, and this, not only on account of the extra expense, but also because such visitors wish to see and study countries and peoples as they exist under ordinary conditions.



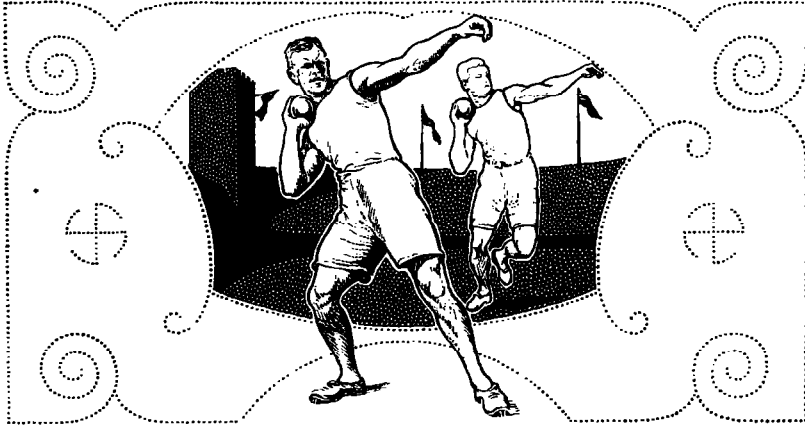

THE TRAINING OF THE SWEDISH ATHLETES FOR THE OLYMPIC GAMES.

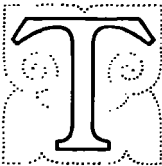

The task of the Swedish Olympic Committee and the Special committees was, as we have already mentioned, not only that of organizing the competitions of the Fifth Olympiad but also of making the best possible arrangements for the participation of Swedish athletes in the Games. One necessary step, of course, was the stimulation of the work which is always being carried on by, and within, the various Associations, for the purpose of raising the general level of the athletes of Sweden, and another that, as soon as it was determined that the Olympic Games of 1912 should be held in Stockholm, every effort should be made along the whole line to bring forward the ablest and best-trained representatives possible. This work was greatly facilitated by the enthusiasm and appreciation with which these efforts were everywhere received in Sweden, and by the fact that the individual athletes fully understood the importance of each man knowing and doing his duty.

It lies outside the limits of this report to give a detailed description of the work which was carried out by the Swedish Athletic Associations in this respect, and only a brief account will here be given of the training which was begun direct by the Olympic Sub-committees.

ATHLETICS.

Some preparations for carrying out a rational system of training were made in 1909, but the measures taken then were only a spontaneous expression of the general interest prevailing in athletics, so that one of the first questions which the Olympic Committee for Athletics discussed after its formation in January, 1910, was that of the most suitable method of organizing the training of our athletes.

The very first time this question was raised, it was decided to unite in the request made by the Swedish Central Athletic Association to the Swedish Olympic Committee, for the appointment of a special trainer. Advertisements were inserted in English and American sporting journals for a trainer for the Swedish athletes, and a number of answers were received from Swedish-American, American, and English trainers. Mr. Ernie Hjertberg, a Swede by birth, but who had been some 40 years in America, was amongst the applicants, and was considered to be the best qualified, for he had been engaged for many years in succession, and with the greatest success, as a trainer at one of the Universities and at many private athletic clubs in the States.

Training work during 1910—1911.

Mr. Hjertberg arrived in Stockholm on the 25 July, 1910, and at once began work at the Östermalm Athletic Grounds, where, every day, a great number of athletes assembled for the purpose of training beneath his experienced eye.

According to the plan drawn up for Mr. Hjertberg's work during the summer of 1910, he was to be in Stockholm from July 28—August 14; in Gothenburg, August 15—August 26; in Falun, August 27—August 28, during the championship competitions held there then, and, from the 29 August, in Stockholm once more. During the first year of Mr. Hjertberg's stay in Sweden he was thus chiefly employed in Stockholm, where, of course, the incomparably greatest number of athletes lived. But in order to have effective and well-organized training, the Athletic Committee determined in August 1910 to appoint a special Training Committee for the Stockholm athletes, the members of which were as follows: F. Bille, Esq., President, and Messrs. A. Ahlquist, F. Dahlström, Sune Smedmark, and Emil Ekberg, the latter of whom acted as Secretary.

A large number of athletes wished to avail themselves of Mr. Hjertberg's services, and so the Committee determined to start training-courses, under Mr. Hjertberg's direction, for those who wished to learn the proper methods of training, and the training technics of the various branches of athletics. By means of these courses, the Committee hoped to obtain a large staff of unsalaried, capable assistants for Mr. Hjertberg. Some 40 persons sent in their names as assistant-trainers, and the training of ordinary athletes and the courses for the assistant-trainers went on for the greater number of the autumn evenings of 1910 and the winter of 1910—1911, in the Riding School of the Svea Artillery Regiment, which was kindly lent by the Colonel of the Regiment. At first the assistant-trainers displayed much interest in their work but, unfortunately, only a few of them completed the course, which, consequently, was not of the use it ought to have been. The training of the competitors *in spe* went on, however, with the greatest zeal, and a very large number of athletes assembled every training-evening in the riding school. This continued during the whole of the winter 1910—1911, with a short interval at the close of December and the beginning of January. At the close of February, the first

cross-country runners made their appearance in the neighbourhood of Stockholm, this being the commencement of the period of severe training that was to continue during the summer.

The Swedish Olympic Committee having granted the necessary means, Mr. Hjertberg was engaged for another year, or until the 16 November, 1911, but measures were already (October 1910) being taken by the Committee to have the agreement with the trainer prolonged from the 16 November, 1911 to the close of the Olympic Games, and the necessary funds were granted later on by the Swedish Olympic Committee.

As was mentioned above, Hjertberg, during the winter of 1910—1911 was stationed principally in Stockholm, but visits were paid during this period to a number of other Swedish towns such as Uppsala, Eskilstuna, Norrköping, Malmö, Gothenburg, Helsingborg, Jönköping, Gäfle and Sundsvall. The detailed arrangements for this tour were drawn up by the Swedish Central Athletic Association, and at all the above-mentioned places the Committee had obtained permission to employ the Regimental Gymnasiums, and the Gymnasiums at the Secondary Schools, for the training of the athletes.

But during the winter and early in the spring of 1911 it proved very difficult for Mr. Hjertberg to give all the instruction and advice to athletes in every part of Sweden, alone and unaided, and so, in the middle of March, the Committee determined to appoint an assistant-trainer. Mr. A. E. Ahlquist was chosen, this gentleman having been specially interested in his work, and having shown himself a very capable man during the whole of the course for assistant-trainers, and even at an earlier date.

The Training Committee summoned the athletes to meet at Stockholm on the first of May, for the first out-of-doors training to be held in the capital. But the greater number of those in training had already been out a few times, and the long distance runners had for a long time enjoyed a severe course of out-of-door training, as they had taken part in quite a number of cross-country races since the end of March.

Although training operations were now centered at Stockholm it was also necessary to have a severe course of training everywhere in the country, and so the Committee nominated a special sub-committee, which was entrusted with the care of everything necessary for the preparatory training of the Swedish athletes who were to take part in the field and track events of the Games. The members of this sub-committee were Messrs. K. Hellström, S. Låftman and G. Uggla, and they took steps to have special training committees formed at all the more important athletic centres in the country districts. The task of these committees was to procure suitable training premises and apparatus for the athletes, to assist those training with advice and instruction and, last but not least, to see that the work was carried out with sufficient thoroughness and care. During the year 1911, Messrs. Hjertberg and Ahlquist, alternately, paid longer or shorter visits to all the places where such training committees existed.

As mentioned above, the out-of-door training in Stockholm commenced

in earnest on the 9 May at the Östermalm Athletic Grounds, but in many parts of the country such training had been going on a long time previous to this date. This was the case, for instance, at Malmö, Helsingborg and other towns in the south of Sweden. Stockholm, however, was the centre, of the work, and the best athletes from other parts of the country stayed there for longer or shorter periods in order to train under Mr. Hjertberg's personal superintendence during the time that could be spared from their ordinary work.

In the summer, Messrs. Hjertberg and Ahlquist visited a number of places in the country, by which means all athletes of any value had an opportunity of being trained direct by one of these two men for longer or shorter periods. This plan proved to be a very useful one, and when the flower of the Swedish athletes assembled for the first great rehearsal for the Olympic Games — the Swedish championships held at Jönköping in August 1911 — the improved technics and, on the whole, a better understanding of the demands made on a first-class athlete when opposed to clever competitors, was clearly visible. The bad weather prevailing during the meeting prevented any very remarkable results being obtained, but the averages showed a very considerable improvement since the previous championship meeting.

During the latter part of the summer of 1911, our best athletes were given the opportunity of taking part in several important international meetings, where they met very formidable opponents. Travelling and hotel-expenses were paid by the Committee from a fund obtained by public contributions. International meetings were held in Stockholm, Gothenburg and Norrköping, and by taking part in these events our athletes acquired greater familiarity with competitions, greater reliance on their own powers, and a better knowledge of future opponents, all of which proved to be of the greatest importance for the continued work of training.

Preparations for training during 1912.

Training was stopped in December, and the athletes were given a rest until the 1 February, 1912, but, during this period, the Committee worked energetically at the preparations for the final training for the Olympic Games.

In November, 1911, the Committee requested the Swedish Olympic Committee to take steps to have the various athletic grounds in Stockholm put in order for training work. After negotiations with the owners of the Östermalm, Råsunda och Traneberg athletic grounds, the Swedish Committee voted sufficient means to make first class jumping and running tracks at the Östermalm and the Råsunda Athletic Grounds, the Traneberg Grounds being reserved exclusively for football teams. The work on these grounds began at the close of 1911. The original intention was to reserve the Råsunda Grounds for the training of the Swedish athletes during the months immediately preceding the Games, so that the Swedish Olympic men could work in peace and quiet,

without being disturbed by foreign athletes. This plan was never realised, however; the Swedish representatives finishing their training at the Stadium and at the Östermalm Athletic Grounds.

On training being resumed in February, it was determined that work should at once be begun in the open, although snow still covered the ground, and the Committee therefore determined to build a running track of wood, with a 200 metres' lap, which was laid on the upper level of the Östermalm Athletic Grounds.

During 1910—1911, Mr. Hjertberg had specially directed his efforts to giving as many Swedish athletes as possible some technical insight into their various branches of sport. But to enable Sweden to have its best possible body of athletes for the Games, concentrated training was now required, and it was determined that, during 1912, Mr. Hjertberg should devote himself exclusively to those athletes for whom there were prospects of being among the Olympic men. The Committee also determined that, from the 1 April, the best athletes should be gathered in Stockholm at one common training headquarters and so, in December, 1911, the Committee sent a circular to all the best athletes, asking them if they could obtain leave of absence from the 1 April till the close of the Games. The leading military authorities kindly granted leave of absence to all the officers who had been chosen to take part in the last stages of the training, and those athletes who, during 1912, were performing their year of military service in country districts, were moved to garrison regiments in Stockholm where, during April and May they were relieved from certain military duties so as to have opportunities for training, while during June and a part of July they were relieved from all military service, the time thus deducted from their year with the colours being served later on. Firms, too, and private persons, in whose service many of the athletes were, also granted leave of absence to their employees, and, thanks to all this kindness, it was found possible to have an elite body gathered in Stockholm in good time under the immediate supervision of the trainers. The first intention of the Committee was that, during the months of April and May, the athletes should be lodged in suitable quarters in Stockholm and that then they should stay during June and July, at a common centre at Råsunda, and train at the athletics grounds there. But the finest possible quarters for housing the athletes were discovered in the newly-erected, but not yet opened, lying-in hospital close to the Östermalm Athletic Grounds, and, thanks to the complaisance of the Hospital Board and the contractors, the Committee succeeded in making an ideal home for athletes at this place, so that nothing came of the proposed moving to Råsunda for the month of June.

It was necessary, however, to use every means to get our best Swedish athletes to the Games, and so the Swedish Olympic Committee determined to write to the Swedish-American Athletic Federation on the question of a possible participation of Swedish-American athletes in the Games as representatives of Sweden. The result was, that a special Committee was appointed in New York, of which William Borg-

ström, Esq., was the President. This Committee communicated with various Swedish American athletic clubs, and exhorted them to see that their members began training in good time for the Olympic Games. A try out was afterwards arranged in America, and in consequence of the results obtained at this meeting and at some important national gatherings in which Swedish-Americans took part, the Committee — which had also collected funds in the States to pay the travelling expenses of the Swedish-American athletes chosen — determined to select Alex. Ahlgren, E. Almlöf and J. Eke as Swedish representatives in field and track events.

Final training during 1912.

As before mentioned, training was recommenced on the 1 February. A wooden running track had been laid at the Östermalm Athletic Grounds, and the dressing rooms were provided with a number of massage-benches, while two masseurs were engaged on the 1 February for the service of the athletes, but the number of the Swedish representatives increasing, additional masseurs had to be taken. On Sundays, in addition to the Stockholm athletes, many of the best men from other parts of the country came to Stockholm to obtain advice and instruction from Hjertberg and his assistant. Mr. Hjertberg drew up special plans of training for the various branches of athletics, and each athlete trained under his immediate supervision. During February and March it was, with very few exceptions, only athletes from Stockholm and its immediate surroundings who trained on the wooden track at the Östermalm Athletic Grounds, but, from the 1 April, the men from the other towns gradually assembled in Stockholm for their final work, and common training quarters were found for the men in the so-called Athletes' Home (already spoken of) for which special managers were chosen, viz., Messrs. Hjertberg, Läftman and Ugglå.

On Monday, April 22, the Swedish athletes were allowed to begin training in the grounds of the Stadium.

The Training Committee formerly appointed, and which had followed the course of training, and the development, of the individual athletes with the greatest attention, determined to entrust the various athletic associations with the organization of training competitions during the spring and the early part of the summer. This proved to be an excellent idea, for it gave the men who took part in these competitions (which were held every Sunday) very necessary acquaintance with match technics, and equally necessary self-reliance. These competitions, all of which were arranged in the best possible way, increased public interest, too, as an opportunity was given each week of observing the progress made by our Swedish athletes. The matches also served another end, too, as they made good practice for the officials chosen to act at the Games; these men, by officiating at the training competitions, becoming acquainted with each other, and learning to act together in a practical and suitable manner. The last

of these competitions held before the final try out gave the best hopes of some very fine performances when the latter events took place. Some of the try outs were fixed for the day on which the new Stadium was opened, June 1, and the two following days; those for the Decathlon and the cross-country race taking place on the 5 and 6 June. The week that remained before these try outs, was employed most conscientiously by our athletes, so that they might be well prepared to struggle for the honour of representing Sweden at the coming Olympic Games.

We shall now give some details of the training carried out in the following branches of athletics.

TUG-OF-WAR.

Tug-of-war competitions have long been favourite events in Swedish athletics. Important matches have been held on many occasions, and Swedish teams have repeatedly competed with success abroad against the representatives of foreign nations. It is a form of sport which is found in nearly every country, and one that seems especially suited to the natural bent of the Swede, and so it was quite a matter of course that the greatest interest would be shown in the tug-of-war competition when it was found to be on the programme of the Olympic Games. When the Olympic Committee for the tug-of-war competition was appointed, its first measure was to commence the systematic training of our own representatives, and to issue invitations with a list of rules as complete as they could be at the time. The training in question was most thorough and lengthy, and was carried on most energetically. All the police forces in the country, the Stockholm firemen, the various regimental and naval corps, gymnastic- and athletic associations and other bodies, were all asked to co-operate. Sergeant Wollgarth was appointed leader of the work of training, with Sergeant Almqvist as his assistant and deputy. A special Committee was chosen to organize training competitions, etc., including, besides the two sergeants just named, Lieutenant Ekström, Police-Inspector A. Fäldt, and Chief Constable Lindmark. A "P. M. for training for the tug-of-war"; with "Advice and instructions for individual training for the tug-of-war", etc., were drawn up and sent to all the bodies mentioned above. Training competitions were arranged, and 4 preparatory and 3 final trials were held, the last of these in connection with the solemn opening of the Stadium on the 2 June. The first team of the Stockholm Police Corps was the victor in all these competitions.

CYCLING.

The last try out of the Swedish Cyclists was arranged by the Swedish Cycling Association on June 2, the event being the annual long distance road race round Lake Mälaren which forms the Swedish championship competition. The Selection Committee which, during 1910 and 1911, watched the doings of our long-distance riders

with unabated interest, probably had its draft list of representatives ready at an early date, as the result of the many competitions which took place, during 1911 and the spring of 1912 especially, but it was thought that a last trial over the course which, five weeks later, was to be traversed by the most prominent representatives of the amateur cycling world, could only have good results. Immediately after the close of this try out, the Training Committee sent in its draft list of Swedish representatives for the road race round Mälars to the Cycling Committee, which approved of the names at a meeting held on the 4 June. Under the experienced superintendence of Mr. Severin Åkerstedt, the 12 representatives and the first reserve went into training-quarters at Mariefred for the last month before the Games. The fine position gained by the Swedish team in the race is a proof of the severity of the training carried on during these last 4 weeks.

FENCING.

The preparatory training for the fencing competitions was carried on privately in the fencing-club rooms.

The final try outs were held at Hasselbacken, Stockholm, on the 12, 13, 14 May, 1912, that on the 12:th being for the individual competition with foils ; that on the 13:th for the épée individual competition, and on the 14:th, for the sabre individual competition. These try outs, in the first place, were for such fencers who had been chosen in previous meetings and, in the second place, for such as had not as yet taken part in any try outs, but who were thought to be of sufficient class to strengthen Sweden's prospects in the fencing competition.

The result of these final try outs was the first thing that determined the selection of Sweden's 12 representatives, but the choice of these competitors — besides resting on the place-figures obtained at these competitions — depended also on the skill previously shown by the fencers in question.

The men chosen to represent Sweden were obliged to go through a special course of training, so as to be in their best form at the fencing competitions of the Olympic Games.

FOOTBALL.

Before the Swedish Football team was chosen, a series of try outs was played to test the skill of players from different parts of the country chosen by the Selection Committees of the various football districts. Members of the Try Out Committee (which consisted of Messrs. John Ohlson, Edvin Sandborg och Erland Hjärne), were present at these try outs, and the opinion was asked of Mr. Chas. Bunyan (formerly professional at the Örgryte Athletic Club, Gothenburg) respecting the merits of the players. The original intention of the Committee was to bring all the players chosen to Stockholm about a month before the Football Competitions began, in order to let them undergo a thorough course of proper training under the care of Mr. Bunyan, but

various circumstances occurred to prevent this being done until a few days before the matches began, and the team was not picked until the day before Sweden met Holland in the first round of the football competition, a fact that may have had no slight influence on the result of the game.

GYMNASTICS.

After it had been definitely decided that competitions in Gymnastics were to form part of the Olympic Games, it was determined that Sweden should be represented by one team of men gymnasts and one team of women gymnasts, both of them for the display, and by one team of men for competition I.

Committees were formed in 19 different places in Sweden for the purpose of choosing the men gymnasts and, on a fixed day in December, 1911, they tested the gymnasts who had sent in their names. The gymnasts thus chosen received instructions as to what would be required of them for the final try outs, which were to take place at the close of March and the beginning of April, 1912.

The last of these try outs — the definitely final one — was carried out by three persons: Captain E. Lieberath, and Lieutenants I. Aminoff and O. Holmberg. The choice of candidates was made at various places, and a protocol was entered of the merits of each gymnast in accordance with the following formula:

PROTOCOL,

for the try outs in gymnastics for the Olympic Games.

Name:
 Title:
 Address:
 Club:
 Age:
 On examination, placed in class:
 Height:
 Bearing:
 Physical development:
 Certificate: Free Movements:
 Heaving Movements:
 Movements with other apparatus:
 Vaulting:
 Suitable for.....team.
 Information *re* quartering:
 Information *re* military service and assistance necessary to
 obtain leave of absence.....
 Judges' signatures

95 gymnasts were chosen in Stockholm,
 16 » » » » Gothenburg,
 14 » » » » Gäfle,

46 gymnasts were chosen at Hesselholm,
45 » » » » Linköping.

The gymnasts thus chosen received orders to continue their training, but received no definite programme with a few chosen movements.

On the 18 June, 1912, the entire team was gathered in Stockholm under the leadership of Captain E. Lieberath, with Lieutenant C. Holmberg as assistant leader. The training was carried on at the Östermalm Athletic grounds and at the gymnasium of the Royal Horse Guards, while the competition team exercised at the Gymnastic Central Institute. The team for the competition was chosen from among the men gymnasts who were to take part in the display.

The testing of the women gymnasts for the display team took place at Stockholm, Lund and Gothenburg, and, on the 5 June, 1912, all those chosen assembled at Stockholm to take part in the rehearsals. These took place at the Gymnastic Central Institute under the leadership of Miss Marrit Hallström, Gymnastic Director, who was assisted by Miss Karin Neudendorff, Gymnastic Director.

HORSE RIDING COMPETITIONS.

The Committee for the Horse Riding Competitions took early measures for the work of training for the Horse Riding Competitions of the Olympic Games.

Later on, in the spring of 1912, preliminary prize riding and prize jumping competitions and try outs were organized in the various regiments, and preliminary competitions were held in connection with the Horse Shows and competitions at Stockholm, Gothenburg, Malmö and Norrköping, whilst try outs were held at the Horse Show in Stockholm during the last few days of May.

In order to increase the interest in these competitions, the Committee determined to spend Kr. 1,000 (£ 55 : \$ 275) in the purchase of a prize of honour, to be awarded to the regiment that did the most successful work in connection with the preliminary competitions and try outs for the Olympic Games. This prize of honour, which consisted of an equestrian figure, was afterwards presented by F. Löwenadler, Esq., to the Committee as a gift, and it was won by the Royal Horse Guards.

After the try outs at Norrköping on the 25 May, 1912, the Committee considered it necessary to increase the severity of the the training operations, and to have, if possible, an "inspection-competition". It therefore determined to assemble a number of horses and riders at the State Riding School of Strömsholm, to continue training there, and also to have an "inspection competition" on the 30 June, the day before the entries closed, when all the members of the Committee had to be present and the final try outs were to take place. This was rendered possible by the munificence of a private individual, who gave a sum of Kr. 6,000 (£ 330 : \$ 1,650) in order to cover the travelling- and boarding expenses of the officers, etc.

LAWN TENNIS.

The question of the programme having being satisfactorily settled, the next thing the Lawn Tennis Committee did was to arrange a system of training for the competitions, and a plan was drawn up for the purpose.

Mr. Chas. E. Hagget, the English Lawn Tennis professional then in Stockholm, was engaged by the Committee, first for the covered court competitions, and afterwards, during the month of June, for the out of door court events.

The training on covered courts began on the 1 October, 1911.

No try outs were held for the Olympic Lawn Tennis Competitors, but the Swedish representatives were chosen on the form shown during the winter training and at some of the competitions held in the spring of 1912.

MODERN PENTATHLON.

Nearly all the training work for the Modern Pentathlon was placed in the hands of the Stockholm section of the Committee for Military Athletics. On the initiative of the Olympic Committee for the Modern Pentathlon, the said section or "District" arranged a first preliminary competition in the month of November, 1911, in accordance with the regulations just issued for the Olympic regulations. This was the first competition of the kind held in Sweden.

During the winter, 1911—1912, and in the spring of 1912, training was carried on by certain officers in various parts of Sweden, and at Easter, the District Committee held try outs for the Modern Pentathlon Competition of the Olympic Games. A large number of aspirants appeared, who, after the preliminary try out in April, were subjected to a last test at the final try outs held between May 27—31.

The Committee in charge of these try outs consisted of: Colonel C. Ankarcrona, Captain C. Silfverstolpe, Lieutenant S. Granfelt and Mr. Kristian Hellström.

ROWING.

When the question arose of Sweden being represented at the Rowing Competitions of the Olympic Games, the Rowing Committee felt that a prominent English expert should be engaged as trainer and instructor of the Swedish contingent, and, by the advice of F. Löwenadler, of London, and on the recommendation of the London Rowing Club, the Committee, in the spring of 1912, entered into negotiations with Mr. J. Farrel, who, for a couple of years had been acting in the capacity mentioned, both in England and in Germany, and who was considered to be a very competent man indeed.

After signing the agreement, Mr. Farrel arrived in Malmö at the beginning of June, and, in accordance with the plan drawn up by the Rowing Committee, began a tour of inspection which included the testing of the capabilities of such of the crews of rowing clubs, at Malmö, Landskrona, Hälsingborg, Gothenburg, Jönköping and Stock-

holm, as could be considered possible representatives of Sweden at the Games.

Mr. Farrel kept the Rowing Committee *à jour* with his observations, but he soon came to the decision that, if Sweden wished to take part in the rowing competitions, it would have to be with a composite crew consisting of the best and strongest men among the various clubs. Mr. Farrel laid this proposal before the Committee when he arrived in Stockholm at the beginning of July, 1911, during the course of his tour. According to his plan, the members of the eight were to be taken from Malmö, Hälsingborg and Gothenburg, and Mr. Farrel gave the names of the men he thought best fitted to form the crew. Three were from Malmö, two from Hälsingborg and three from Gothenburg.

This plan for obtaining the best possible Swedish eight came to nothing, however, on account of the opposition offered by Gothenburg clubs. In consequence, men had to be taken who had, at first, only been thought of as good reserves, and work began at Malmö, during July and August, 1911, where a provisional training course, 800 metres long, was found on the canal there. The boat used was lent by the Stockholm Rowing Club.

Mr. Farrel kept the crew under strict training for some weeks, after which he returned to England.

During the winter, the men chosen had a lot of passive training (by means of gymnastics, massage, etc.), and they were all very fit when Mr. Farrel returned in April, 1912, to resume his labours.

The work was performed with the utmost thoroughness, the men being taken in pairs, both on fixed- and on sliding seats; then in irriged fours and, finally, in their old clincher-built eight.

As all the men possessed excellent physique, noticeable progress was made, and they could be considered as really forming a crew when they arrived in Stockholm on the 28 May, 1912, in order to continue work on Djurgårdsbrunnsviken Channel.

While this was taking place, the eight formed by the Gothenburg Rowing Club was at work under the leadership of Mr. Sven Hellström. They began practice very early indeed, commencing in March, 1912, and in May the crew began work in a boat bought in England, which was built to take to pieces when required. On the 27 May, Gothenburg was visited by the delegates of the Rowing Committee who had been sent to examine the work that was being done. At this time, the Gothenburg eight seemed to be at the height of training, while much remained to be acquired in style, and the Committee was of opinion that it would have been better if the reverse state of things had existed.

The crew of the irriged four, trained at Gothenburg, seemed to row in good style, and to be very fit.

Training was thus going on all along the line. In the race for outrigged fours, Sweden was to be represented by the Vaxholm Rowing Club, the winner of the championship in 1911, and for the irriged fours, our second crew was to consist of the last four men of

the eight. This was a desperate resolve, but the Committee found itself compelled to adopt this course, in consequence of the impossibility of finding a special crew N:o 2, for the irrigated four.

SHOOTING.

After the King in Council had graciously granted a sum of Kr. 3,000 (£ 165 : \$ 825) towards the expenses of the try outs for the Swedish marksmen, the Executive Committee of the Chief Committee of the Shooting Association, on the 5 May, 1911, issued regulations for the try outs for the Swedish riflemen.

In accordance with these regulations, the try outs were three in number, and were held on three different occasions.

The first two took place during 1911; one in the summer, before the month of August, at the private ranges of the Association, and the second before the close of November.

640 riflemen were entered for the first try out and of this number 442 were chosen to compete. Of these, the 200 that obtained the best results were picked for the second try out. This was done at the ranges common to the respective Shooting Clubs.

Of the men that had taken part in the second try out, the best 100 were chosen for the third trial, which took place in Stockholm on the 4 and 5 of May, 1912.

All the try outs were held in full agreement with the regulations that were to be in force at the Olympic Shooting Competitions.

Participation in these three try outs demanded a considerable sacrifice of time and money. Each competitor, for instance, fired 1000 shots at these try outs alone, in addition to those required for practice shooting.

The Swedish representatives in the Shooting competitions were selected by the Executive Committee of the Chief Committee of the Shooting Association, on the results of the third try out.

The ranges at Stora Skuggan, near Stockholm, were available for practice, before the beginning of the competitions, as were those at Kaknäs from 25—28 June.

The competitors took full advantage of this circumstance, especially during the days last mentioned, when, from morning till evening, the ranges at Kaknäs were occupied by competitors practising there, both Swedes and foreigners.

It has already been said that the competitions in revolver-, pistol-, and miniature-rifle shooting were, on the whole, something new to the Swedish marksmen. This part of the shooting programme was adopted principally so as to satisfy, in the best way the wishes of competitors from abroad, for we ourselves could have but very slight hopes of success in such events as those in question. Characteristic of the situation, too, is the fact that, for the try outs, which took place about a month before the Olympic Games began, there were only about 20 competitors who entered, of which number it was evident that many really had no very clear idea as to the nature of

the competitions. For example, in the try outs for the shooting with miniature-rifles at 50 metres, a great many of the marksmen used ordinary saloon-rifles, with open sights.

The more surprising, therefore, was the result of these competitions, which were so very favourable for Sweden. The marksmen that so successfully defended the Swedish colours, were, with but one or two exceptions, members of the Stockholm Pistol-shooting Club. This club was founded in January 1909, for the purpose of promoting interest in revolver- and pistol-shooting, and also, but not least, in order to be able to form a Swedish team for pistol-shooting at the Olympic Games of 1912.

SWIMMING.

When drawing up the training-scheme for the representatives in the swimming competitions, it was considered that the work would be best done by means of the voluntary co-operation of skilful Swedish leaders. The idea was, that swimmers of ability should be sent round during the summer from the head-quarters in Stockholm, to the country- and other districts of Sweden, for the purpose of giving instruction in swimming and diving, the instructors receiving nothing but their travelling expenses. In the country districts, it was thought that the instruction given, should, quite naturally, be almost entirely restricted to diving, as, outside of Stockholm, there exist no swimming baths of a size that allow of training for races or for water polo, and as the shortness of the Swedish summer would not allow of Swedish swimmers living elsewhere than in Stockholm being transformed into men of really international class.

Training operations for the swimming races and for the water polo matches, were thus, practically speaking, restricted altogether to Stockholm.

On the 15 April, 1910, the Olympic Committee for Swimming wrote to the Swedish Olympic Committee to the above effect, stating that, for the moment, it did not consider it suitable to engage a trainer from abroad, but that the training would take place under Swedish guidance, Swedish masseurs being engaged, if necessary.

The Swedish Olympic Committee considered, however, that, for the swimming races, at least, a foreign trainer should be engaged for some length of time. The Swimming Committee having agreed to this arrangement, advertisements for a swimming-trainer were published in English athletic journals. Of the applicants for the post the Committee selected Mr. Charles Hurley, of Leicester, who, during the greater part of 1910—1911 was given the charge of the training for the swimming races. His headquarters were in Stockholm, but he made visits of varying length to Gothenburg, Malmö, Örebro, Eskilstuna and Västerås. During the summer of 1911 some of our best swimmers from the country were brought to Stockholm, in order to receive the benefit of Mr. Hurley's instruction there.

A special committee, however, consisting of Messrs. E. Bergwall, T. Kumfeldt and John G. Andersson, had charge of the training for

the swimming races during the autumn of 1911, the ensuing winter, and the spring of 1912, the work being carried out chiefly by arranging series of races. The training for water polo was entrusted to the same committee, and was under the special guidance of Mr. E. Bergwall.

The training in diving was directed by Mr. E. Lundberg, who, during 1911 and 1912, gave regular instruction, gratis, both to men and women swimmers in Stockholm. The month before the Games, all the competitors from country districts were assembled in Stockholm, in order to go through the last, severe course of training under the eye of Mr. Lundberg.

Regular series of competitions for women swimmers, too, were arranged in Stockholm during 1911 and 1912.

In addition to this, training was carried on by the swimming clubs at several places in the country, and the improved results obtained, both in the diving and in the swimming races, prove that the work had chiefly aimed at preparation for the Olympic Games of 1912.

WRESTLING.

The first step taken by the Wrestling Committee was to appoint a trainer, and the Committee succeeded in engaging such a prominent and skilful wrestler as the Finlander, Ivari Tuomisto. This trainer visited various parts of Sweden, and gave advice and instruction to such wrestlers as were thought to have some chance of success in the Olympic Games.

A series of try outs was held, and it was chiefly in accordance with the results of these that the Committee, on the advice of the trainer, selected the wrestlers who were to represent Sweden at the Games.

About a month before the beginning of the Olympic Games and immediately before the close of entries a series of try outs was held in various branches of athletics, as shown by the following table.

Time	Place	Competition
FIELD AND TRACK ATHLETICS		
Arranged by : <i>Swedish Athletic Association.</i>		
1 June (Saturday) p. m.	Stadium	Hurdle Race 110 met., final Pole Jump Putting the Weight, right and left hand, final
2 June (Sunday) p. m.		10,000 metres Flat, final 100)) trials 200))) 1,500)) final Marathon Race Running High Jump, final

Time	Place	Competition
2 June (Sunday) p. m.	Stadium	Standing High Jump, final Running Broad Jump, » Throwing the Discus, right and left hand, final
3 June (Monday) p. m.		100 metres flat, final 200 » » » 800 » » » 5,000 » » » Standing Broad Jump, final Hop, step and jump, » Throwing the Javelin, right and left hand, final
5 June (Wednesday) p. m.	Stadium	Throwing the Hammer, final 3,000 metres Flat, final 400 » » trials Decathlon (1:st day): 100 metres Flat Running Broad Jump Putting the weight, best hand Running High Jump 400 metres Flat
6 June (Thursday) p. m.		Cross-Country Race, c:a 8,000 metres, final 400 metres Flat, final Decathlon (2:nd day): Hurdle Race 110 metres Throwing the discus, best hand Pole Jump Throwing the javelin, best hand 1,500 metres Flat

TUG-OF-WAR

Arranged by: *Committee for Tug-of-War.*

26 May (Whit Sunday) 1.30 p. m.	Traneberg Athl. Grounds	1:st Try out
2-3 June (Sunday & Monday) p. m.	Stadium	Deciding Try out

CYCLING ROAD RACE ROUND LAKE MÄLAR

Arranged by: *Swedish Cycling Association.*

2 June (Sunday) 2 a. m.	Liljeholm Bridge	Start at intervals of 3 min.
2 June (Sunday) afternoon.	Stadium	Arrival

FENCING

Arranged by: *Fencing Committee.*

12 May	Hasselbacken	Individual competition, foils
13 May		» » épée
14 May		» » sabre

FOOTBALL

Arranged by: *Football Committe.*

Every Sunday	At different places	—
--------------	---------------------	---

Time	Place	Competition
GYMNASTICS		
Arranged by: <i>Committee for Gymnastics.</i>		
24 March	Sollefteå	Try outs for competition & display teams
25 March	Gefle	d:o
31 March	Stockholm	d:o
6 April	Gothenburg	d:o
7 April	Hessleholm	d:o
8 April	Linköping	d:o
HORSE RIDING COMPETITIONS		
Arranged by: <i>Horse Riding Committee.</i>		
27—28 April	Gothenburg	Prize Jumping and Prize Riding
4—5 May	Stockholm	d:o
16 May	Malmö	d:o
26—27 May (Whit-Sunday & Whit Monday)	Norrköping	d:o
13 June (Thursday)	Stockholm	Distance Riding and Cross-country Riding
14 June (Friday)	d:o	Individual Riding over Steeple-chase course
15 June (Saturday)	d:o	Prize Jumping & Prize Riding
MODERN PENTATHLON.		
Arranged by: <i>Military Athletics Comm. Stockholm District.</i>		
8—12 April	Stockholm	1:st Try out.
28 May (Tuesday) 9 a. m.	Assoc. for Prom. of Fencing, 2 Stureplan	Fencing : épée
29 May (Wednesday) 8 p. m.	Mälardal	300 metres Swimming free style
30 May (Thursday) 4 p. m.	Exercise-ground at Spånga	Riding singly over cross-country course (marked) not exceeding 5,000 metres
31 May (Friday) 9 a. m.	Kaknäs	Duel Shooting at 25 metres
31 May (Friday) 3 p. m.	Start and finish at Östermalm Ath. Grounds	Cross-country race c:a 4,000 metres.
ROWING		
—	—	The Swedish crews already selected: consequently no try outs held
SHOOTING		
Arranged by: <i>Shooting Committee.</i>		
3—5 May	Kaknäs	Rifle-, Miniature- rifle-, Revolver and Pistol Shooting
<i>Stockholm division of Swedish Sportsmen's Assoc.</i>		
6—7 May	Råsunda	Clay Bird and Running Deer Shooting

Time	Place	Competition
SWIMMING		
Arranged by: <i>Swedish Swimming Association.</i>		
29 May (Wednesday) 8 p. m.	Mälarbadet	100 m. free style, trial 200 » breast stroke, » 100 » free style, Ladies, » 200 » free style, final 200 » breast stroke, » Water polo
30 May (Thursday) 8 p. m.	d:o	100 m. free style, Ladies, final 400 m. breast stroke, trial Diving and figure floating display, Ladies.. 100 m. back stroke, trial m. free style Water Polo
31 May (Friday) 8 p. m.	d:o	400 m. free style, final 400 » breast stroke, » Diving display 100 m. back stroke, final Water polo
4 June (Tuesday) 2 p. m.	Djurgårdsbrunnsviken	High diving for men Spring-board diving for men
5 June (Wednesday) 2 p. m.	d:o	High diving for ladies Variety » » men
WRESTLING		
Arranged by: <i>Swedish Wrestling Association.</i>		
2 June (Sunday) p. m.	Stadium	5 Weight classes



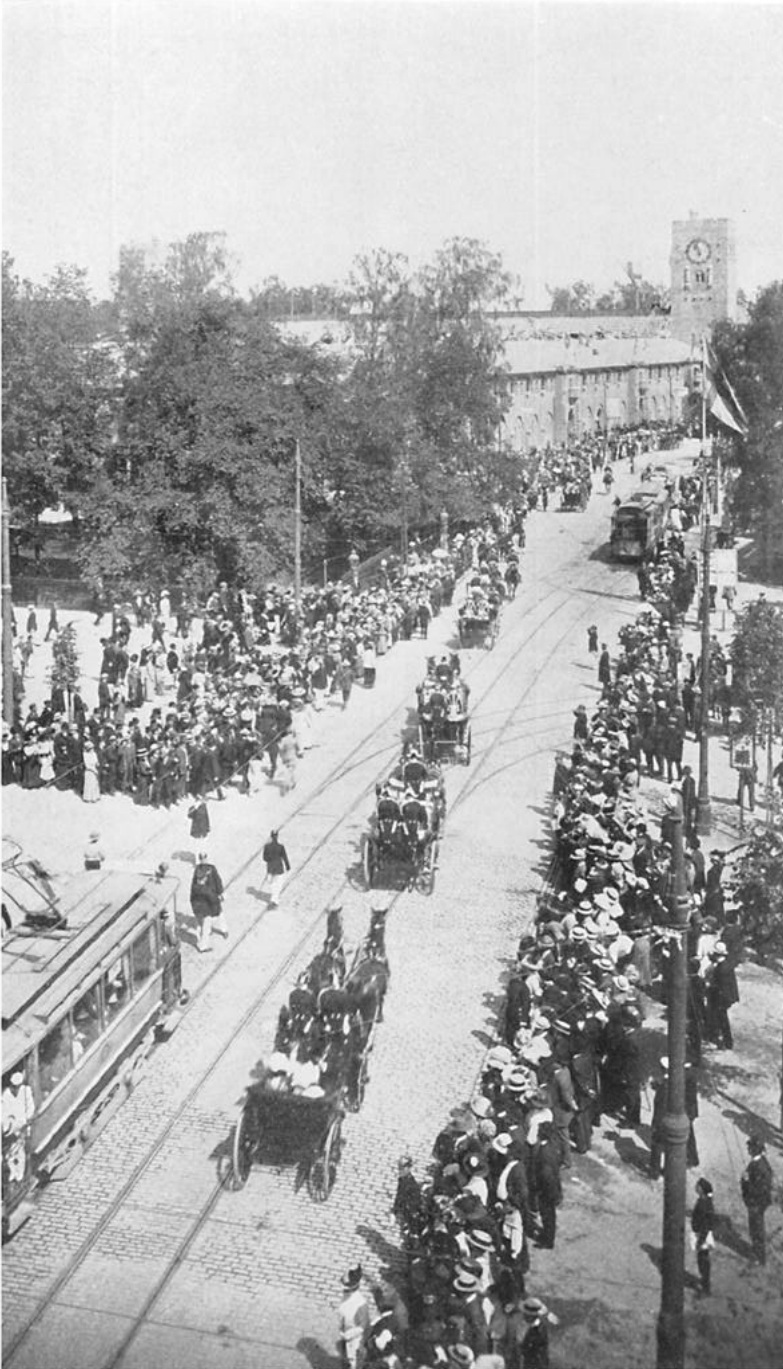

THE ROYAL PROCESSION AT THE SOLEMN OPENING OF THE OLYMPIC GAMES, 6 JULY, 1912.

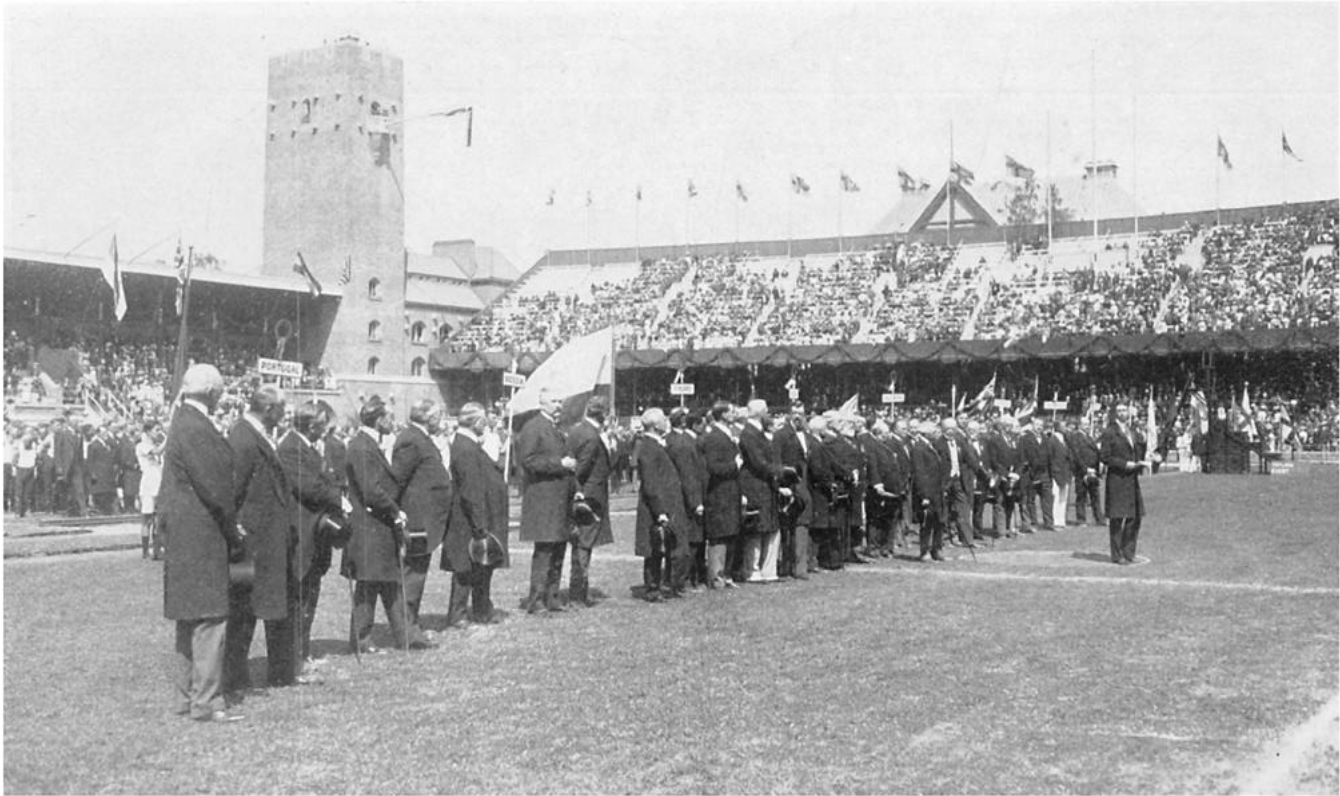

H. R. H. CROW PRINCE GUSTAF ADOLF SPEAKING AT THE SOLEMN OPENING OF THE OLYMPIC GAMES.
A group of members of the International Olympic Committee and of the Swedish Olympic Committee.

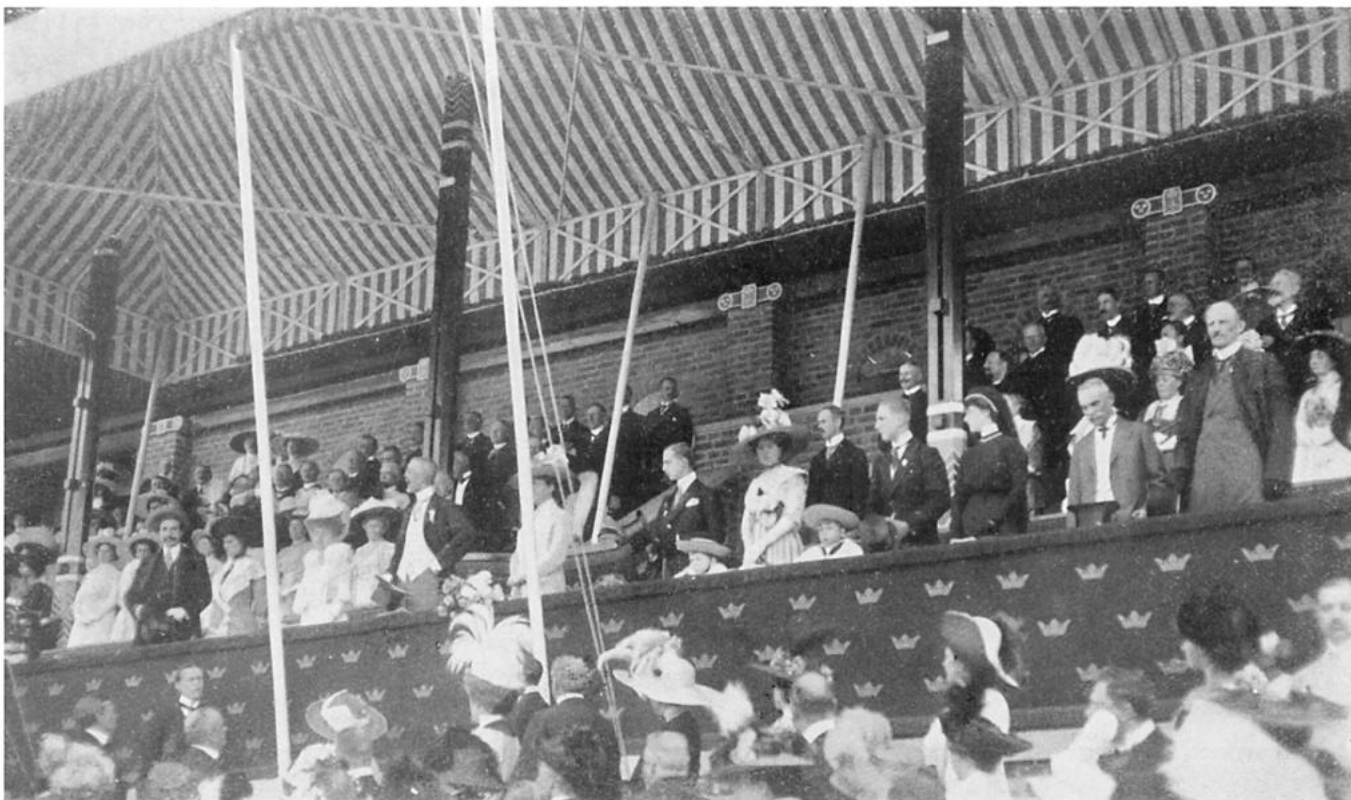

H. M. THE KING DECLARES THE OLYMPIC GAMES OPENED.

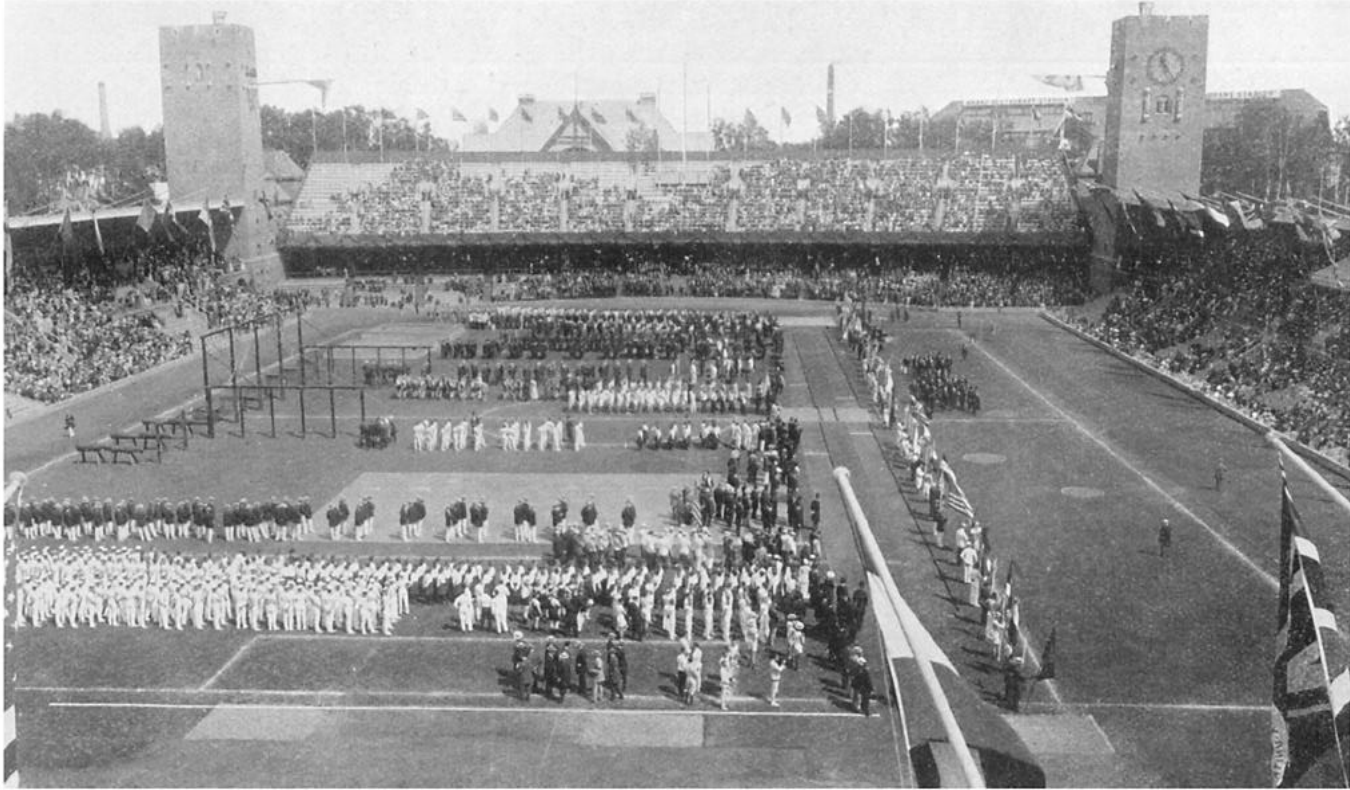

THE NATIONS TAKING PART IN THE GAMES OF 1912 DRAWN UP IN THE ARENA OF THE STADIUM AT THE SOLEMN OPENING OF THE OLYMPIC GAMES.

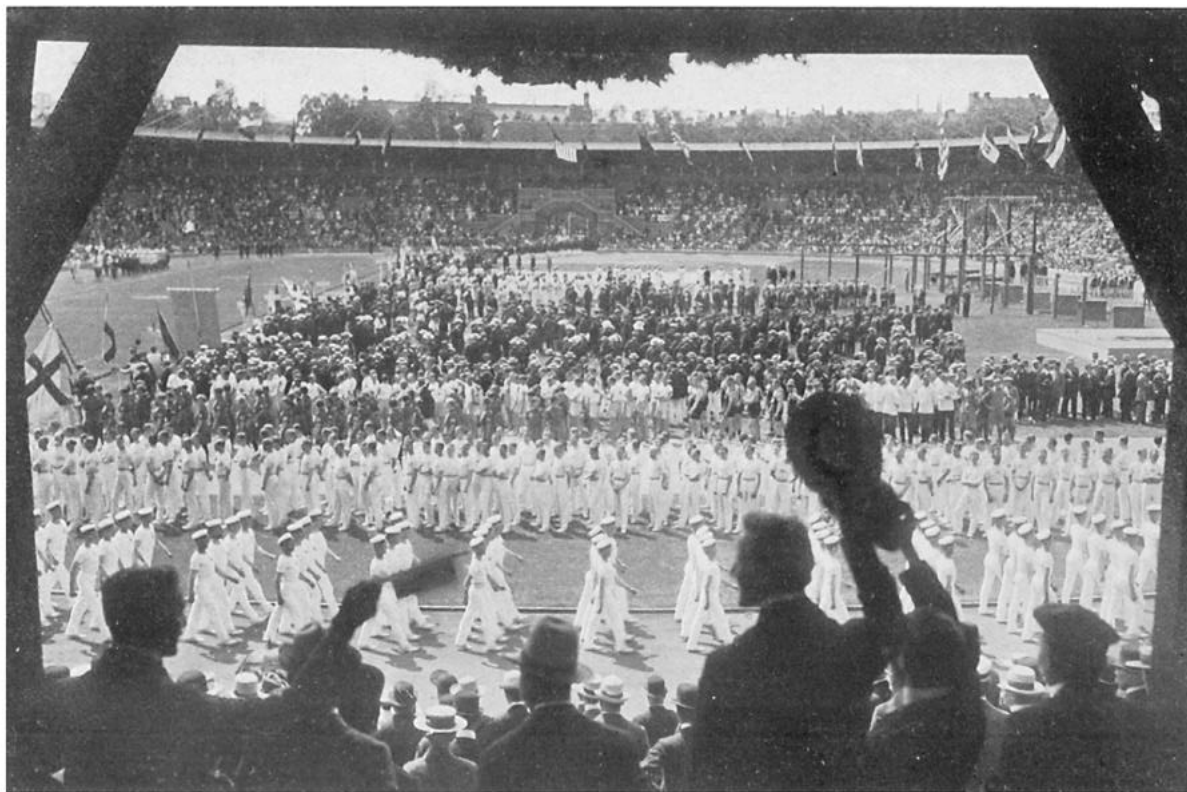

THE GRAND MARCH PAST OF THE ATHLETES AT THE SOLEMN OPENING OF THE GAMES.
Seen from the North Arcade.



THE GRAND MARCH PAST OF THE NATIONS. BELGIUM.

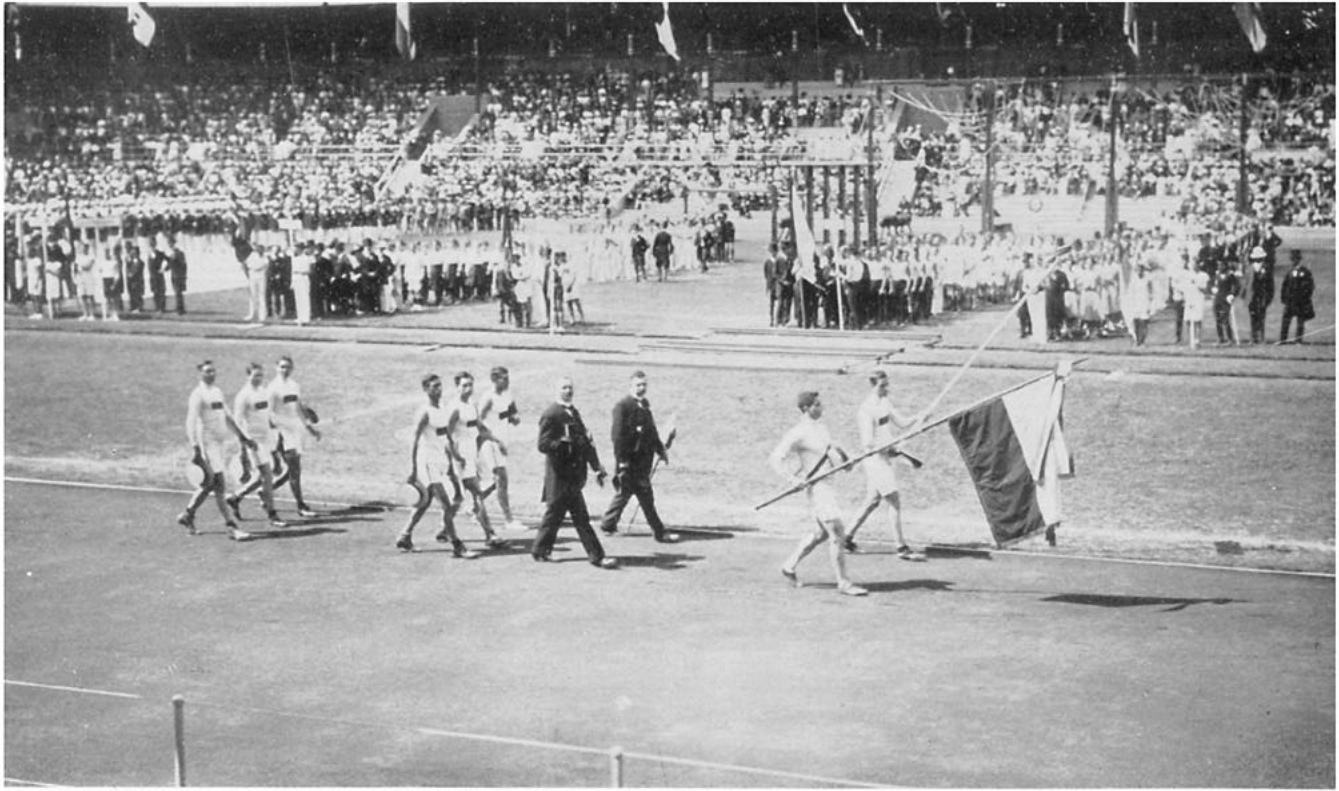

THE GRAND MARCH PAST OF THE NATIONS. CHILI.

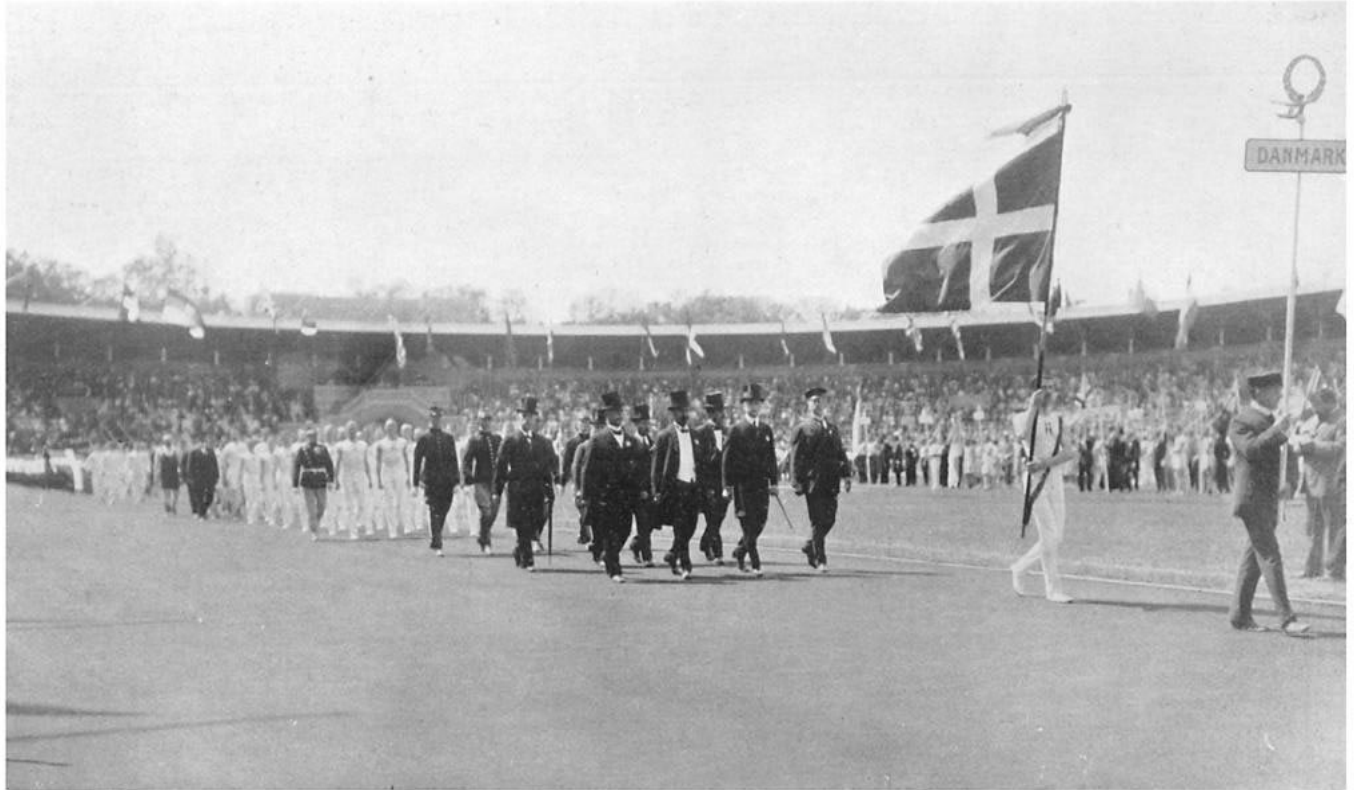

THE GRAND MARCH PAST OF THE NATIONS. DENMARK.



THE GRAND MARCH PAST OF THE NATIONS. FRANCE.



THE GRAND MARCH PAST OF THE NATIONS. THE UNITED STATES OF AMERICA.

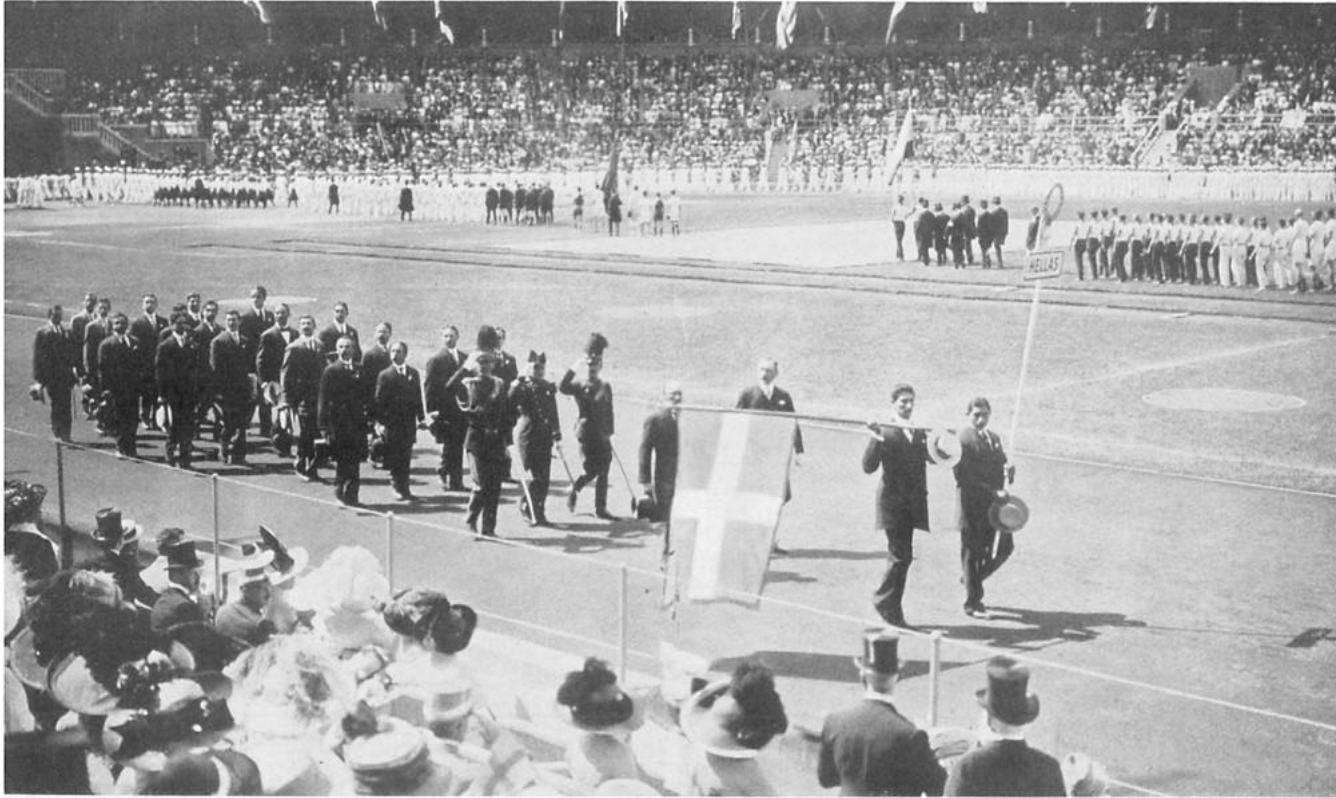

THE GRAND MARCH PAST OF THE NATIONS. GREECE.



THE GRAND MARCH PAST OF THE NATIONS. HOLLAND, ITALY.



THE GRAND MARCH PAST OF THE NATIONS. JAPAN, LUXEMBOURG, NORWAY.

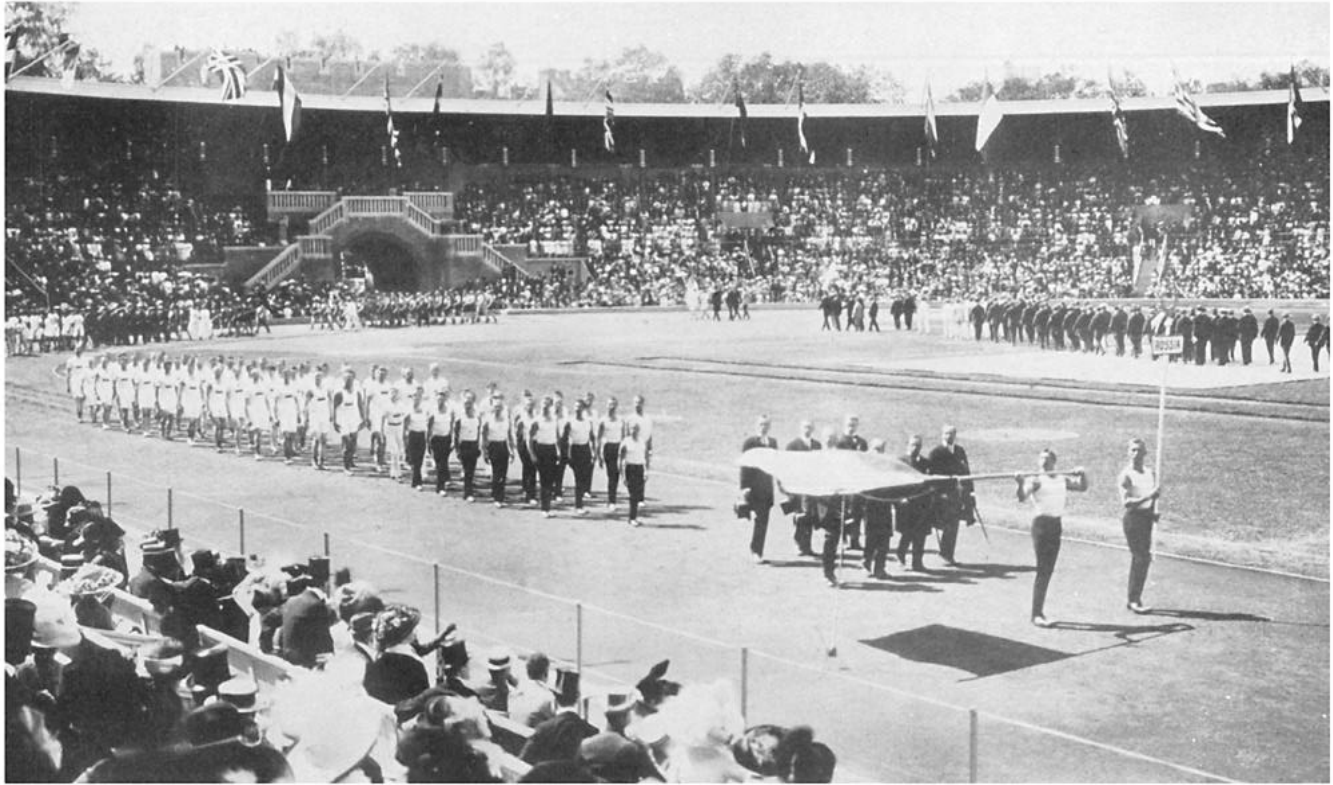

THE GRAND MARCH PAST OF THE NATIONS. RUSSIA.

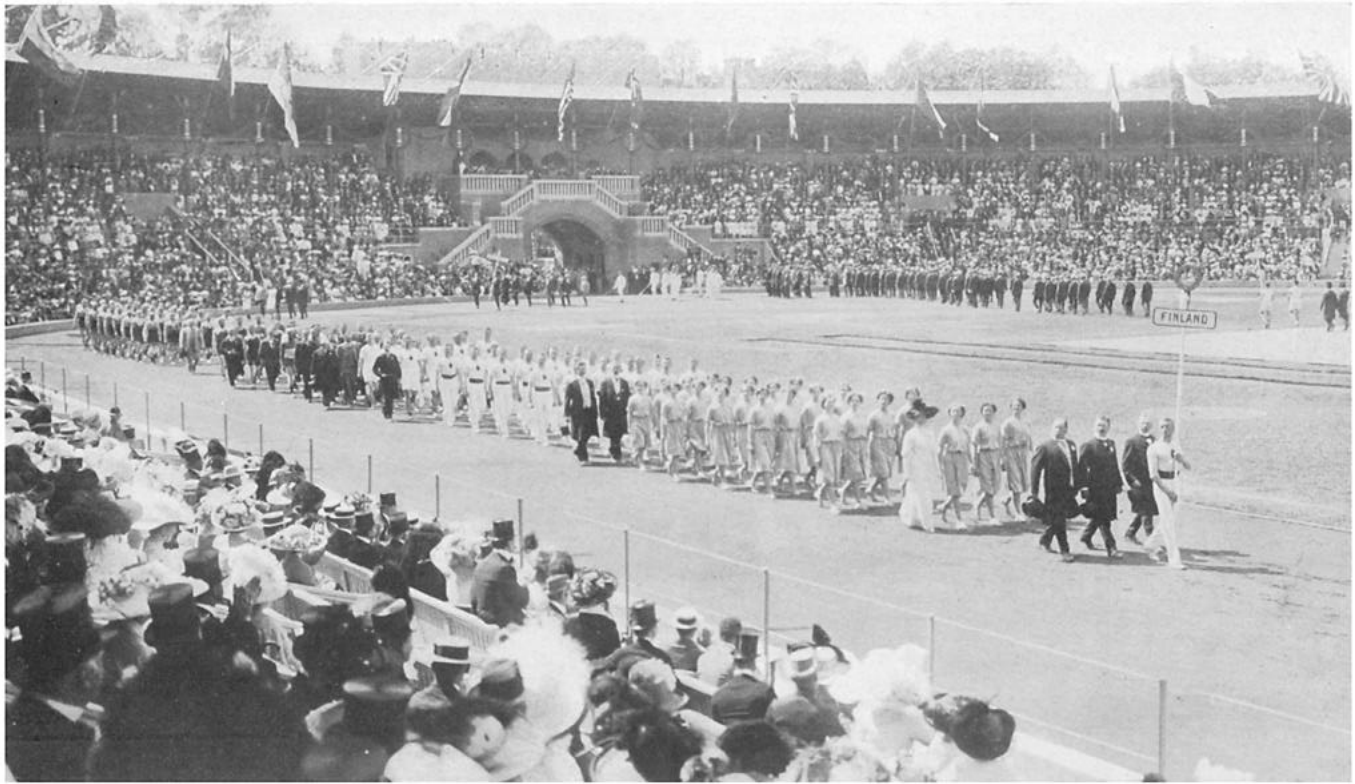

THE GRAND MARCH PAST OF THE NATIONS. FINLAND.

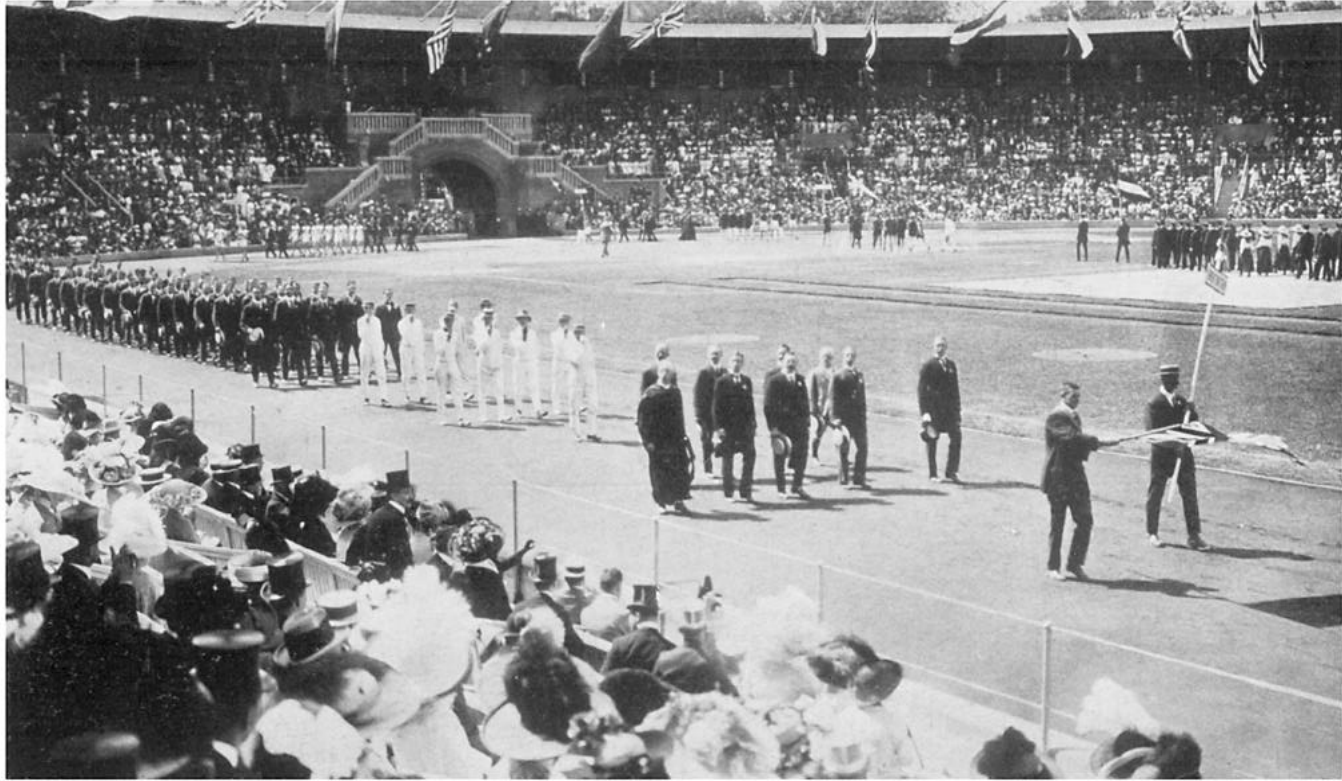

THE GRAND MARCH PAST OF THE NATIONS. GREAT BRITAIN.



THE GRAND MARCH PAST OF THE NATIONS. CANADA, AUSTRALASIA, SOUTH AFRICA.

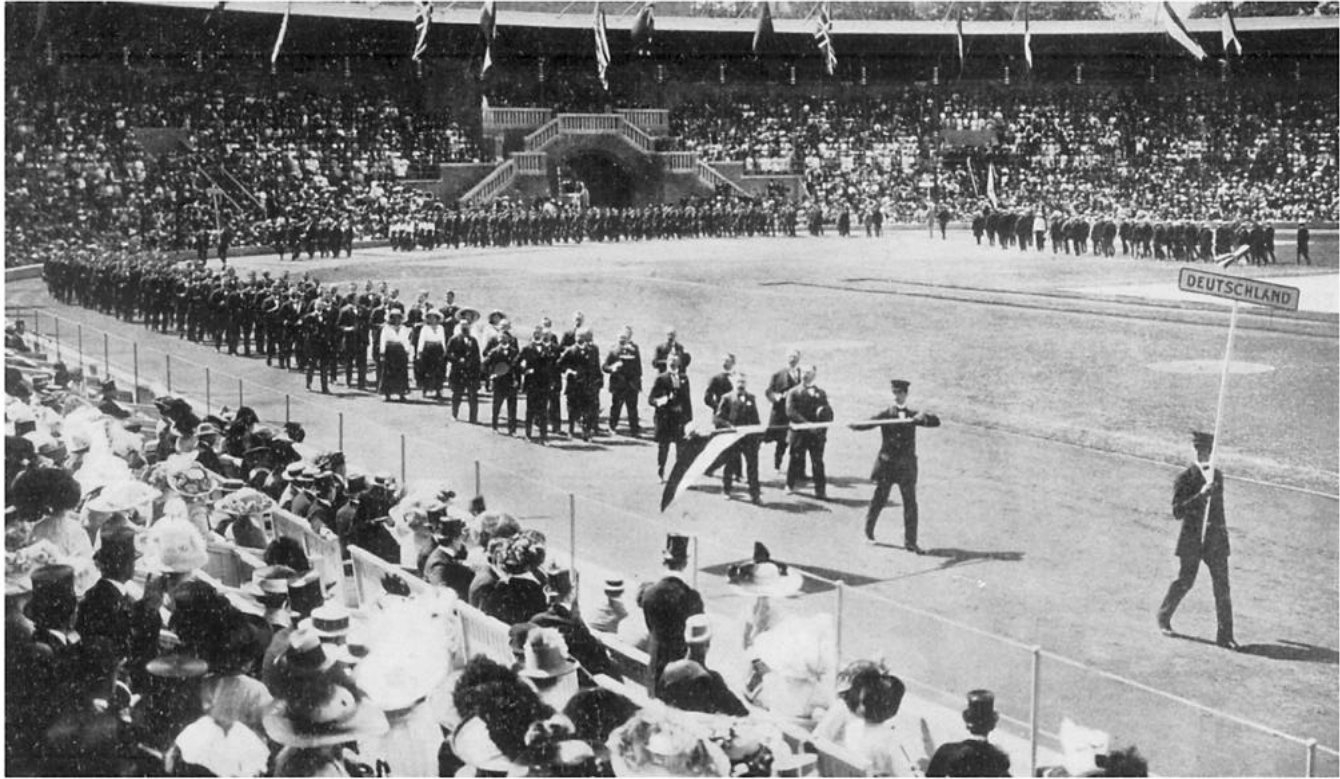

THE GRAND MARCH PAST OF THE NATIONS. GERMANY.

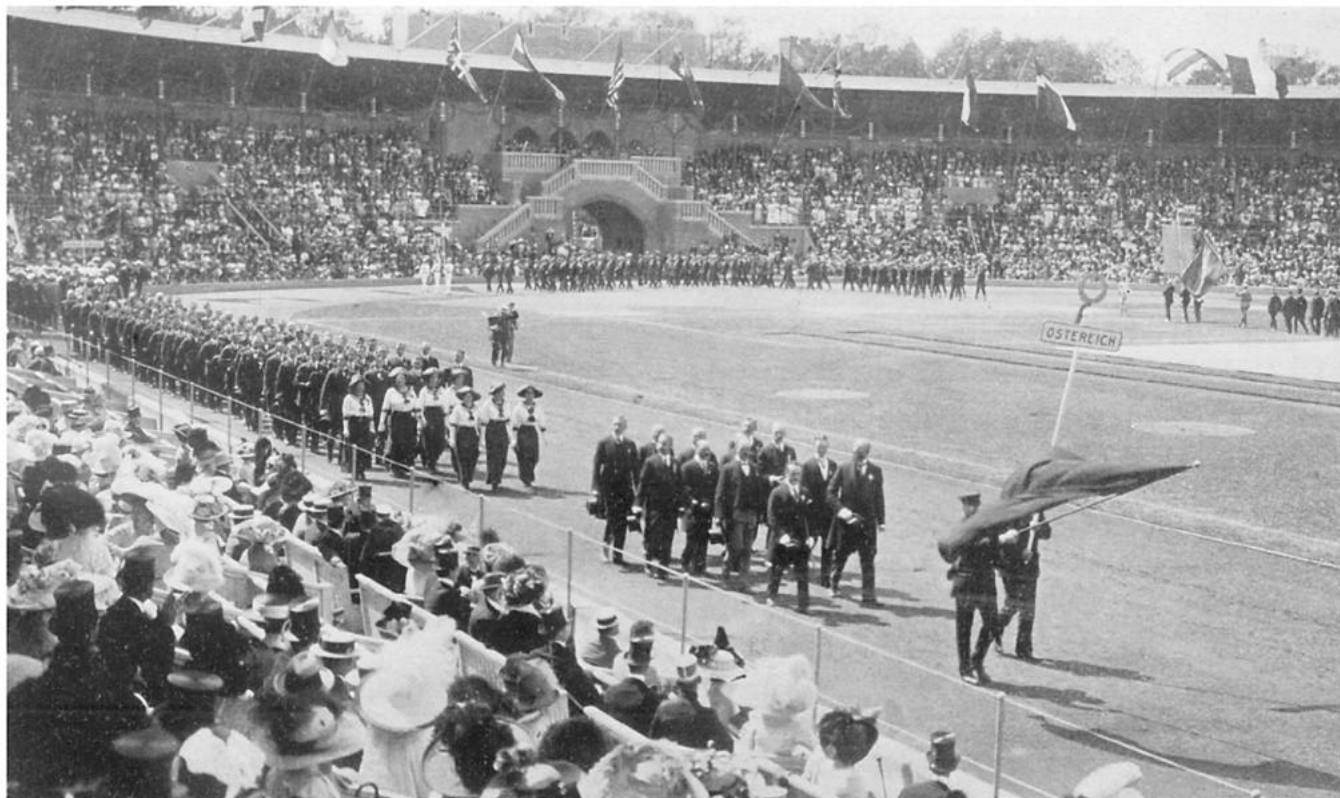

THE GRAND MARCH PAST OF THE NATIONS. AUSTRIA: BOHEMIA.

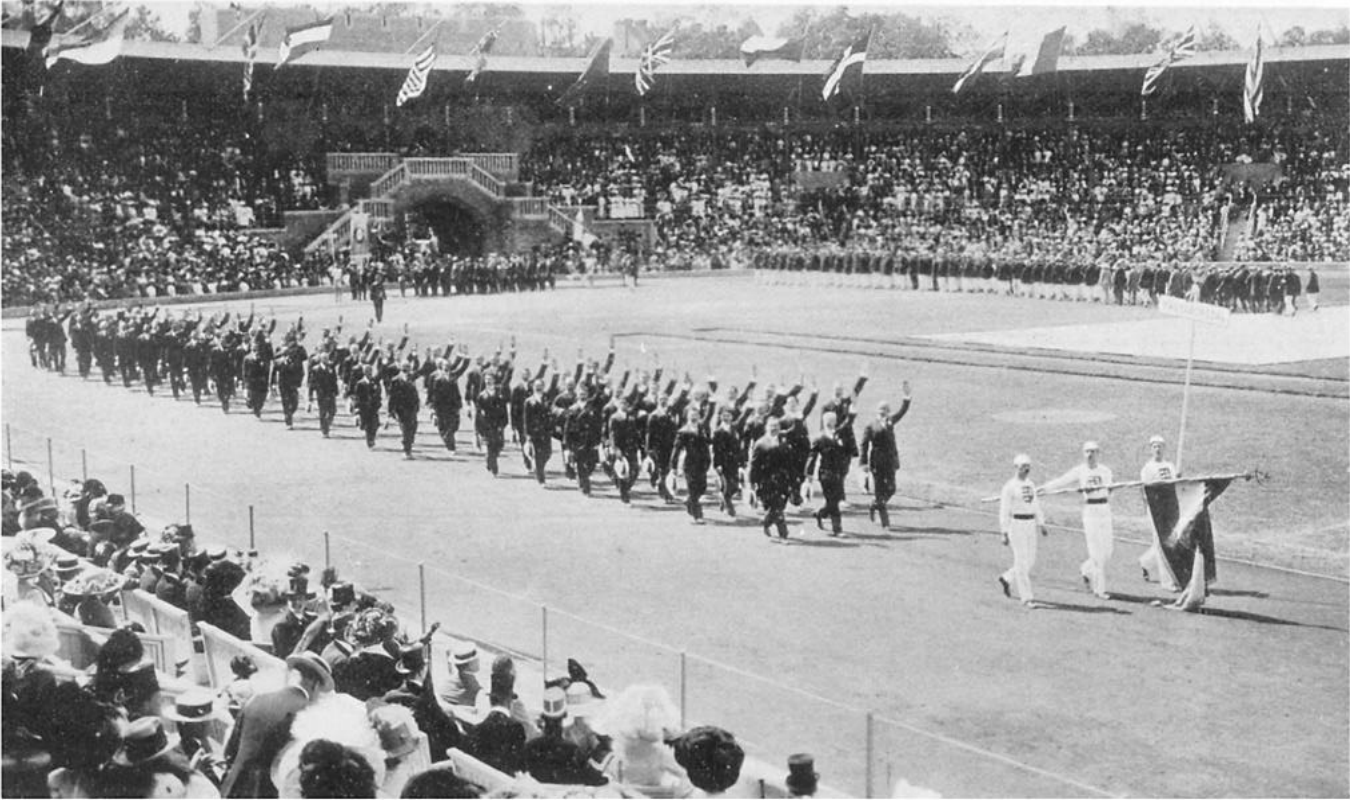

THE GRAND MARCH PAST OF THE NATIONS. HUNGARY.

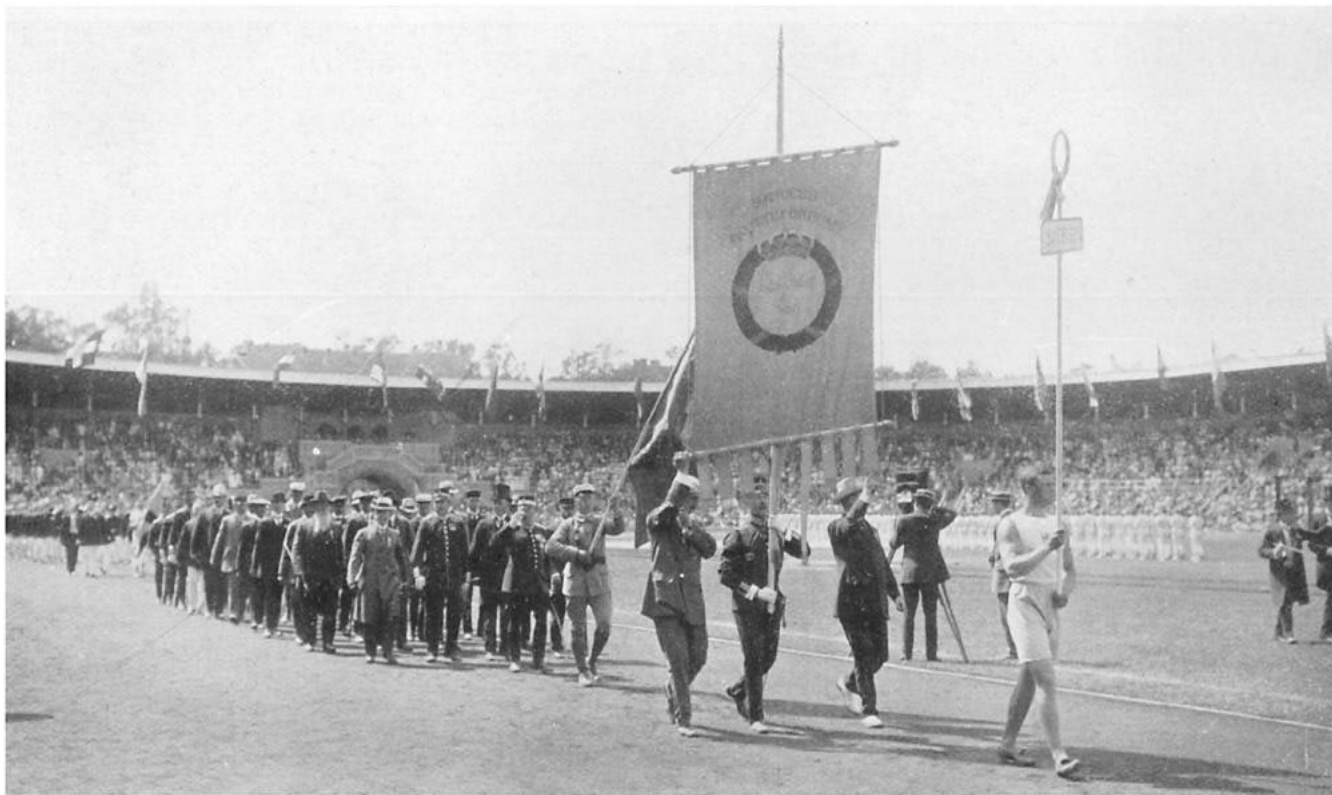

THE GRAND MARCH PAST OF THE NATIONS. SWEDEN.

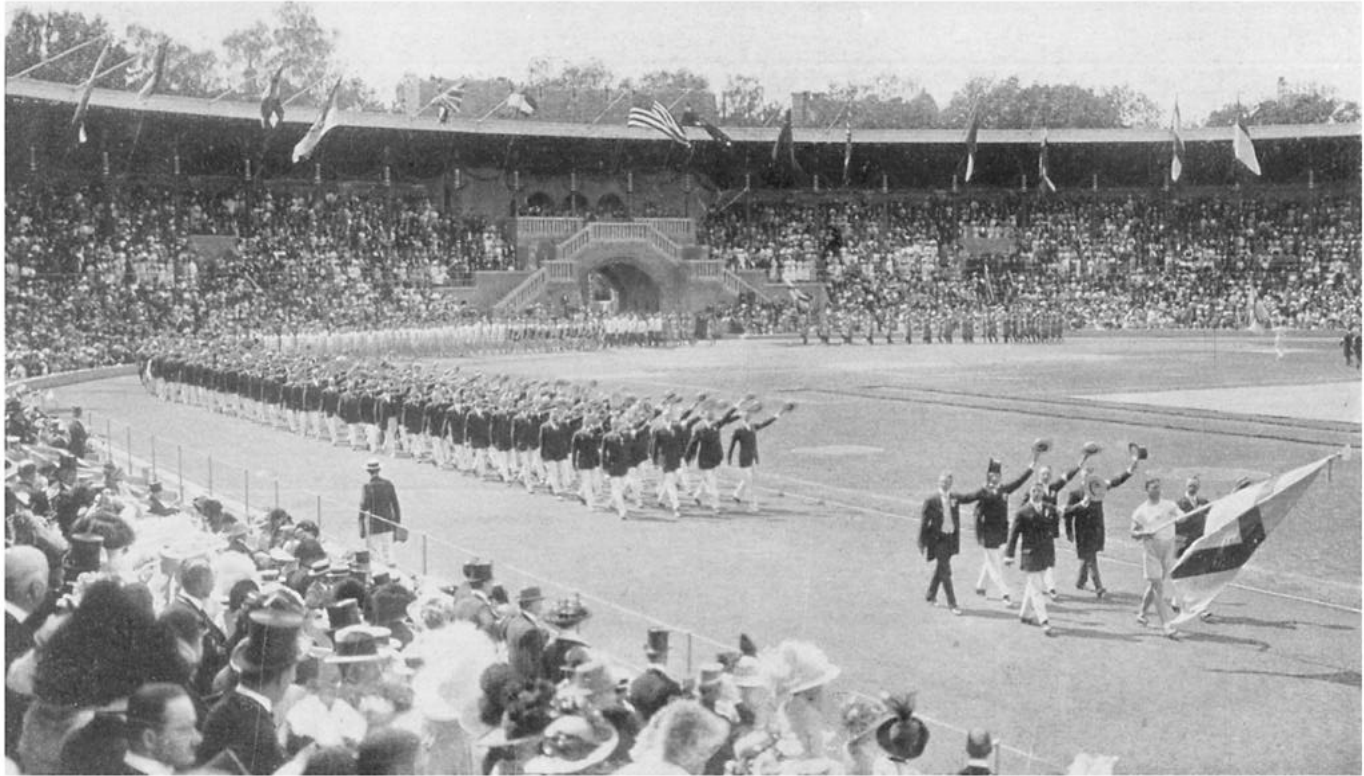

THE GRAND MARCH PAST OF THE NATIONS, The Swedish Officials.



THE GRAND MARCH PAST OF THE NATIONS. The Swedish team of Women Gymnasts.

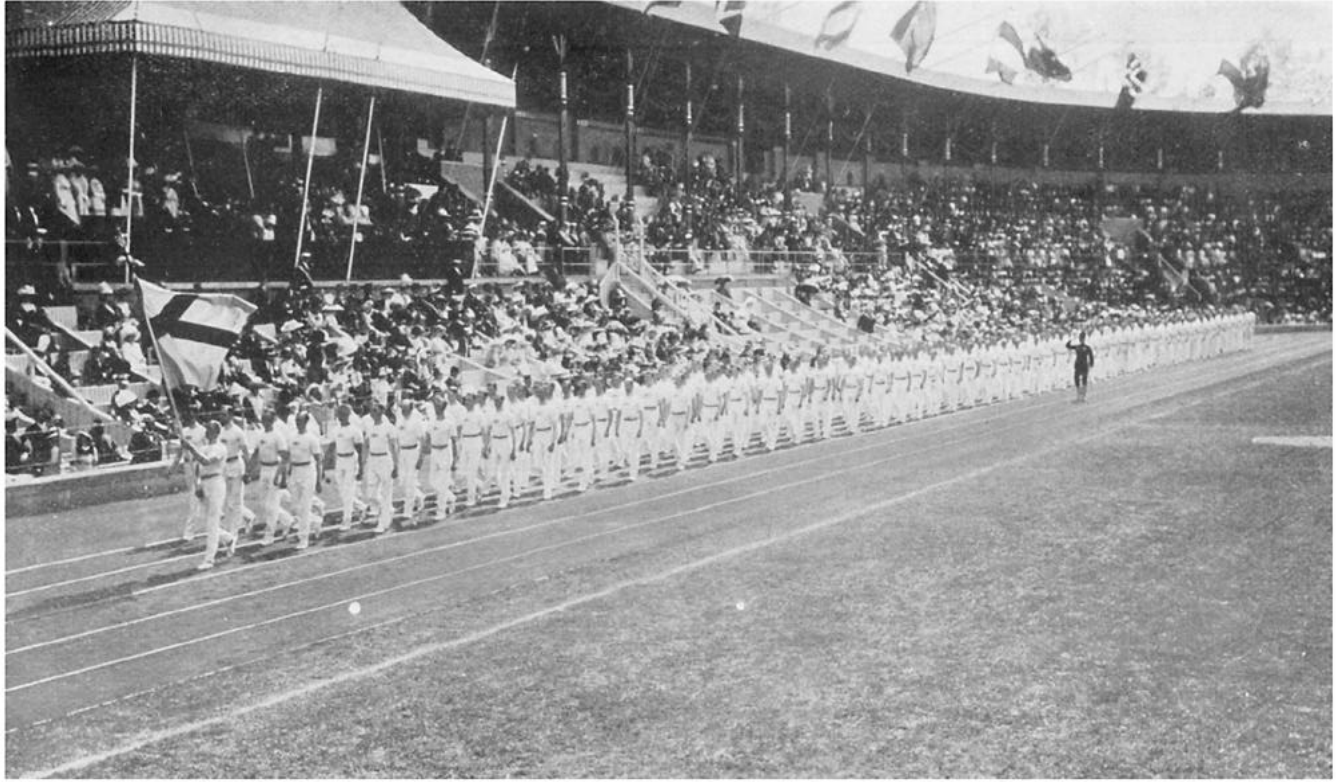

THE GRAND MARCH PAST OF THE NATIONS. The Swedish team of Men Gymnasts.

COMPETITIONS AND FESTIVITIES

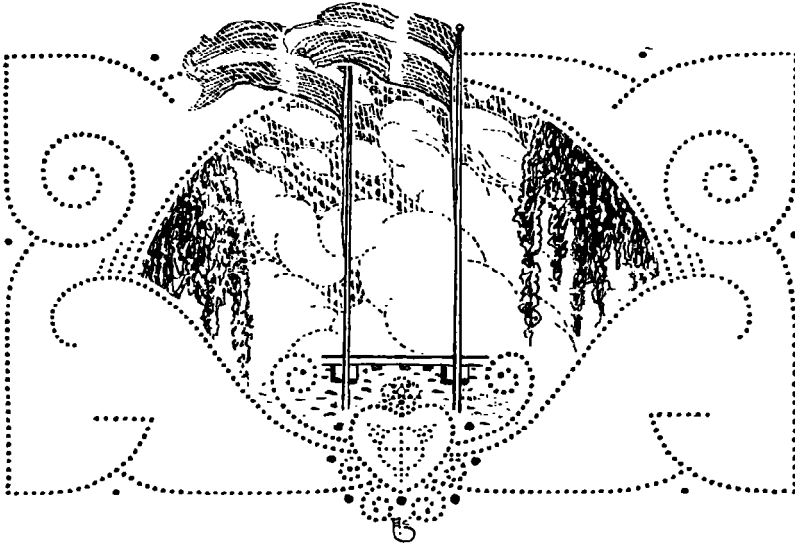

THE SOLEMN OPENING OF THE GAMES.

The solemn inauguration of the Olympic Games of Stockholm, 1912, took place on Saturday, July 6. The festival marked the beginning of the Olympic Week proper. Stockholm was in its most festive dress; the sun shone from a cloudless sky and lent its radiance to the thousand flags of the competing nations, as the colours, fraternally mingled, swayed and flaunted over the crowded streets.

The programme of the opening festival was as follows :

The Royal cortege.

10.46 a. m. The Choral Association enters the Stadium.

11.00 a. m. Entrance of the competitors from abroad and Sweden, who, with their leaders, will then take up their appointed positions in the arena. Entrance of the members of the Swedish Olympic Committee and the International Olympic Committee.

Prayers and a hymn.

Speech by the President of the Swedish Olympic Committee, H. R. H. the Crown Prince of Sweden.

H. M. The King declares the Olympic Games opened.

Songs by the Choir.

Grand march past of the competitors and the Olympic Committees.

The Royal cortege left the Palace at 10.40 a. m. and drove slowly through the billowing masses that filled the streets. On reaching the Stadium, the Royal party, consisting of Their Majesties the King and Queen, H. R. H. the Crown Prince and Princess and the other

members of the Royal Family, was received by the members of the International Olympic Committee and the Swedish Olympic Committee. The Stadium was filled to the very last inch, and a most festive air lay over the scene.

The spectators first enjoyed the sight of the entrance of the teams of competitors. The more than 3,000 participators in the Games of Stockholm had, earlier in the day, assembled at the Östermalm Athletic Grounds, and now entered the Stadium by nations and took up their positions in the arena next to each other, in columns four men wide, facing the Royal box. The members of the Committees of the nations stood first, with the teams behind them. The nations were placed in alphabetical order, in accordance with the Swedish spelling of their names. The Swedish team, however, came last. In front of each column stood standard-bearers, carrying the colours of their nations, while other scutcheons in front of the standard-bearers bore the names of the various nations. The competitors marched in through the north-west gateway, followed the west side of the running track, and then swung on to the centre of the arena.

The order in which the teams were drawn up and marched was as follows :

Belgium	Switzerland
Chili	Servia
Denmark	Great Britain
France	Canada
U. S. A.	Australasia
Greece	New Zealand
Holland	South Africa
Italy	Germany
Japan	Austria
Luxemburg	Bohemia
Norway	Hungary
Portugal	Sweden
Russia	
Finland	

After the nations had taken up their positions, with the members of the Swedish Olympic Committee and the International Olympic Committee in front, everything was in readiness for the solemnities to begin.

In accordance with an ancient Swedish custom, the ceremony began with a hymn, followed by prayer. First of all, there were sung by all the assembled thousands of Swedish competitors and spectators, the lines that, for hundreds of years, have been chanted by Swedish troops before going into action:

Our God, He is a castle strong,
Our trusty shield and sword.
When foes and sorrows round us throng
Our hope is in the Lord.

Prayers were then read, in Swedish by the Rev. Clemens Åhfeldt, Court Chaplain, and in English by the Rev. R. S. de Courcy Laffan.

Prayer read by the Rev. *Clemens Ahfeldt*, Chaplain to His Majesty, at the solemn opening of the Olympic Games at the Stadium, 6 July, 1912:

Father in Heaven; O Thou, the God of our souls! At this great moment of joy, when we are assembled here in the glorious beauty of high summer, in this spot dedicated to noble competition, we turn our eyes to Thee, and thank Thee that Thou art our Father, a Father that lovest us, that watchest over us, protectest us, both body and soul.

Gathered before Thy face stand here to-day youths from many nations and peoples and races, and speaking many tongues. But in Thee are they all *one*. Thou art the never-failing source of their youthful strength, their manly courage. Be Thou the hope of their lives! Be Thou the inmost, highest object of their endeavours, of their peaceful combats! O, Lord God! Thou art enthroned above us; far above the highest firmament! But Thou, in Thy mercy, desirest also to dwell in the depths of our human souls. Happy that youth, happy all people, happy those nations that, both in the gleam of the sunlit days of joy and also in hours of sadness, in days of victory and days of defeat, never forget to look to Thee.

Do Thou bless us! O, Father, hear Thou our prayer!

Then followed a prayer by the Rev. *R. S. de Courcy Lafin*:

O Lord, God of all the nations of the earth, in Whom we live and move and have our being. Our Father!

Thou hast called Thy children hither from all quarters of the Earth, from the East and from the West, from the North and from the South, to show forth in frank and chivalrous contests Thy sacred gifts of manly prowess, and to teach and learn by turns the secrets of manly strength and manly endurance.

Pour out, O Lord, the fullness of Thy Holy Spirit on all who take part in these Olympic Games!

Fill them with the spirit of friendship, the spirit of brotherhood, the spirit of international unity and concord.

Set far from us all misunderstanding, all bitterness, all jealousy, all ill-will.

Give to those who conquer, the temper of generous sympathy; give to those who are conquered, the temper of generous admiration.

And so bless this gathering of the chosen youth of all nations that our Olympiad may be an instrument in Thy hand for the peace of the world, for the goodwill of all peoples, for the building of Thy kingdom on Earth as it is in Heaven.

For Thine, O Father, is the Kingdom, the Power and the Glory, for ever and ever. Amen.

H. R. H. Crown Prince Gustaf Adolf, President of the Swedish Olympic Committee, then stepped forward and spoke as follows:

Your Majesty,

In every country, in these days, the physical development of the human race goes hand in hand with its intellectual progress. Physical culture, which, in classical times, was so highly esteemed, once more begins to occupy a prominent position in the life of nations. Athletics in its modern form has risen as a powerful counterpoise to the often greatly specialized, one-sided work of our days. But,

if athletics is to be of use to a nation, it must be embraced with real and general interest. The greater the number of athletes, the better. But here we must mark, that an all-round system of athletics is, of course, what should be strongly recommended, and the importance of such a system has always been powerfully advocated here in Sweden. It is in this way that athletics can best fulfil its important, its great mission in the service of the physical well-being of a nation.

But if, thus, the aim of athletics is the bodily development of the *whole* nation, we must not neglect the importance of the fact that there exists a comparatively small number of pioneers, of leaders, in the various branches of athletics. Their success contributes powerfully to attract many new adherents to the athletic movement, and to increase interest in athletic exercises in general.

It is quite natural that these chosen athletes from various nations should meet in order to vie with each other in friendly contest. This is done, it is true, every year at numberless athletic gatherings of greater or lesser importance, but the principal international trial of strength in the province of athletics consists of the Olympic Games, which are held only every fourth year, when there are gathered in friendly, fair competition, the foremost representatives of physical strength and skill the world can boast of. To judge from all appearances, the Fifth Olympic Games will not yield in interest to their predecessors, but, on the contrary, will prove to be the greatest international trial of strength in the athletic field that our times can show. We, therefore, owe our thanks to the International Olympic Committee for the great confidence it reposed in us, Swedes, when it entrusted us with the task of arranging the Fifth Olympic Games.

We venture to believe that we have done our best to show that this confidence was not misplaced, and we hope that the thousands of competitors will mark that our aim always has been and will be: *May the best win.*

Your Majesty! In the name of the Swedish Olympic Committee I now humbly beg that Your Majesty will declare the Olympic Games of Stockholm opened.

H. M. King Gustaf V thereupon declared the Olympic Games opened, speaking as follows:

It is with legitimate joy and pride that we Swedes see athletes from every part of the world gathered here with us.

It is a great honour for Sweden that Stockholm has been chosen as the scene of the Fifth Olympiad, and I bid all of you, athletes and friends of athletics, a most hearty welcome to this friendly contest of the nations.

May the grand thought that found expression in the Olympic Games in classic times be so held in honour by our age too, that these competitions may become a powerful means to promote the physical health and development of every people.

With these words, I herewith declare the Olympic Games of Stockholm opened.

Immediately after the close of the King's speech, a Swedish fanfare was blown from the summit of the lofty towers by trumpeters dressed in mediaeval attire, while the teams of the nations saluted by lowering their standards, after which, H. R. H. the Crown Prince called for cheers for His Majesty the King. After these were given, the great choir of the Swedish Choral Association sang a national air.

This ended the opening ceremonies, and the grand march past of

the nations began. The various groups of competitors, in the same order in which they had entered the Stadium, now swung past the Royal Box, to the tones of the Olympic Games Triumphant March (composed by H. Alexandersson, Mus. D., and awarded the first prize in a competition arranged by the Swedish Olympic Committee), and saluted the Swedish monarch as they passed. Each national group had its own special way of saluting and it was a stately sight to see these thousands of well set up, athletically developed young men and women, from all parts of the world, march down the arena.

Last of all came the Swedish team, with a large number of Stadium officials in front of the group of competitors in field and track events.

The Stadium competitions began immediately after the close of the march past, the first event being a gymnastic display by teams of Swedish men gymnasts and women gymnasts.

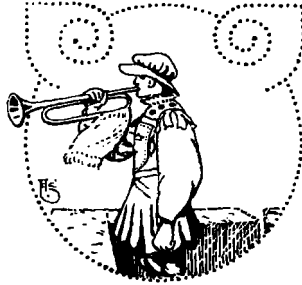

OLYMPIC GAMES TRIUMPHAL MARCH.

(Arranged for the piano by the composer.)

(Awarded the 1:st prize in the competition, arranged by the Swedish Olympic Committee, for an Olympic Triumphal March. It is not to be confounded with the composition awarded the Gold Medal in the "Concours d'Art.")

Maestoso.

f *fz* *8va* *Ped.* ***

First system of musical notation, consisting of a grand staff with a treble clef on the upper staff and a bass clef on the lower staff. The key signature is two flats (B-flat and E-flat). The music features a complex texture with many beamed notes and chords, particularly in the bass line.

Second system of musical notation, continuing the piece. It features a grand staff with a treble clef on the upper staff and a bass clef on the lower staff. The key signature remains two flats. The music is characterized by dense chordal textures and intricate melodic lines in both staves.

Third system of musical notation, continuing the piece. It features a grand staff with a treble clef on the upper staff and a bass clef on the lower staff. The key signature remains two flats. This system includes dynamic markings such as accents (>) and a fermata over a final chord in the treble staff.

Fourth system of musical notation, continuing the piece. It features a grand staff with a treble clef on the upper staff and a bass clef on the lower staff. The key signature remains two flats. The music concludes with a final cadence, featuring a fermata over the final chord in the treble staff.

8va

8va

fz *cresc.* — — — —

This system features a grand staff with a wavy line above the treble clef staff labeled "8va". The music consists of dense chords and arpeggiated patterns in both hands. The bass line has a melodic contour. Dynamic markings include *fz* and *cresc.* with a dashed line indicating a crescendo.

ff

fz *Ped.* * *Ped.* *

This system continues the musical texture. The treble clef staff has a *ff* dynamic marking. The bass clef staff includes *fz* and *Ped.* markings, with asterisks marking specific points in the bass line.

Ped. *

This system shows further development of the musical ideas. The bass clef staff begins with a *Ped.* marking and an asterisk.

I

8va

I

8va

This system starts with a first ending bracket labeled "I" above the treble clef staff, which is also marked "8va". The music continues with similar textures to the previous systems.

The first system of music consists of two staves. The upper staff is in treble clef and the lower staff is in bass clef. Both staves are in a key signature of two flats (B-flat and E-flat). The upper staff contains a melodic line with eighth and sixteenth notes, including accents (>) and a repeat sign at the end. The lower staff provides harmonic support with chords and a few moving lines, ending with a dynamic marking of *f* and accents (>).

The second system of music consists of two staves. The upper staff begins with a first ending bracket labeled "11" above it. The lower staff features a piano (*p*) dynamic marking. The music continues with various chordal textures and melodic fragments in both staves, maintaining the two-flat key signature.

The third system of music consists of two staves. The upper staff has a complex melodic line with many beamed notes and slurs. The lower staff is filled with dense chordal textures, including some double flats (bb) in the bass line. The key signature remains two flats.

The fourth system of music consists of two staves. The upper staff continues with a melodic line that includes a sharp sign (#) in the final measure. The lower staff continues with complex chordal textures and moving bass lines. The key signature remains two flats.

First system of a musical score in G minor. The right hand features a melodic line with grace notes and a crescendo. The left hand provides a bass line with dotted rhythms. A dashed line indicates a measure rest in the right hand.

cresc.

Second system of the musical score. The right hand has a melodic line with accents and a forte dynamic. The left hand continues the bass line. A dashed line indicates a measure rest in the right hand.

fz f

Third system of the musical score. The right hand has a melodic line with accents and forte dynamics. The left hand continues the bass line. A dashed line indicates a measure rest in the right hand.

fz fz fz

Fourth system of the musical score, divided into two parts labeled I and II. The right hand has a melodic line with accents and dynamics. The left hand continues the bass line. A dashed line indicates a measure rest in the right hand.

I fz fz p II fz fz

First system of a musical score. The upper staff (treble clef) begins with a whole rest, followed by a series of chords and melodic fragments, including a prominent F# note. The lower staff (bass clef) features a rhythmic accompaniment of eighth and sixteenth notes. Both staves include dynamic markings such as accents (>) and breath marks (v).

Second system of the musical score. The upper staff continues with chords and melodic lines, while the lower staff maintains the rhythmic accompaniment. The notation includes various note values and rests, with dynamic markings like accents (>) and breath marks (v) present.

Third system of the musical score. The upper staff shows a continuation of the melodic and harmonic material, with some complex chordal structures. The lower staff provides a steady accompaniment. Dynamic markings such as accents (>) and breath marks (v) are used throughout.

Fourth system of the musical score. The upper staff concludes with a series of chords and a final melodic phrase. The lower staff ends with a rhythmic accompaniment. The system includes dynamic markings like accents (>) and breath marks (v).

First system of a musical score, consisting of a grand staff with a treble clef on the upper staff and a bass clef on the lower staff. The key signature has two flats (B-flat and E-flat). The music features complex chordal textures and melodic lines in both hands, with various articulation marks such as accents and slurs.

Second system of the musical score, marked with an 8va (octave) line above the treble staff. It includes a *cresc.* (crescendo) marking. The music continues with dense harmonic structures and melodic development in both staves.

Third system of the musical score, featuring a *ff* (fortissimo) dynamic marking. It includes several *Ped.* (pedal) markings, some with asterisks, indicating sustained bass notes. The texture is highly complex and dense.

Fourth system of the musical score, concluding the page. It features a final cadence with a double bar line and repeat signs at the end of both staves. The music maintains the complex harmonic language established in the previous systems.

8va

p

This system shows the first two staves of a musical score. The upper staff is in treble clef with a key signature of three flats (B-flat, E-flat, A-flat) and a common time signature. It begins with a piano (*p*) dynamic and features a series of chords and melodic fragments. The lower staff is in bass clef with the same key signature and time signature, providing a harmonic accompaniment with chords and single notes. A wavy line above the upper staff indicates an octave transposition of 8va.

8va

cresc. ... *f*

This system continues the musical score. The upper staff (treble clef, 3 flats, common time) features a melodic line with a crescendo (*cresc.*) leading to a fortissimo (*f*) dynamic. The lower staff (bass clef, 3 flats, common time) provides accompaniment with chords and moving lines. A wavy line above the upper staff indicates an octave transposition of 8va.

This system shows the third system of the musical score. The upper staff (treble clef, 3 flats, common time) continues the melodic development with various chords and intervals. The lower staff (bass clef, 3 flats, common time) provides a steady accompaniment with chords and moving lines.

p

I

This system shows the final system of the musical score. The upper staff (treble clef, 3 flats, common time) begins with a piano (*p*) dynamic and features a melodic line that concludes with a fermata. The lower staff (bass clef, 3 flats, common time) provides accompaniment with chords and moving lines. A first ending bracket labeled 'I' is present above the upper staff.

II

f

5

This system features a grand staff with two staves. The upper staff begins with a fermata over a whole note chord, followed by a melodic line with a slur and a fingering '5' above the final note. The lower staff contains a bass line with a slur and a fingering '5' below the final note. A dynamic marking of *f* is placed between the staves.

This system continues the piece with a grand staff. The upper staff has a series of chords with accents (>) above them. The lower staff features a complex bass line with many accidentals and a change in clef from bass to treble.

This system continues the piece with a grand staff. The upper staff has a series of chords with accents (>) above them. The lower staff features a complex bass line with many accidentals.

This system continues the piece with a grand staff. The upper staff has a series of chords with accents (>) above them. The lower staff features a complex bass line with many accidentals.

First system of a musical score in G-flat major (three flats). The right hand features a series of chords and a melodic line, while the left hand plays a rhythmic accompaniment of chords and eighth notes.

Second system of the musical score. The right hand has a melodic line with an *8va* (octave) marking. The left hand includes a *cresc.* (crescendo) marking and a *ff* (fortissimo) dynamic marking.

Third system of the musical score. The right hand features a melodic line with an *8va* marking. The left hand continues with a rhythmic accompaniment.

Fourth system of the musical score. The right hand has a melodic line with an *8va* marking. The left hand continues with a rhythmic accompaniment.

*1:st time Da Capo
to ⊕, then Coda.*

The first system of music consists of two staves. The upper staff is in treble clef and the lower staff is in bass clef. Both staves are in a key signature of three flats (B-flat, E-flat, A-flat). The music features a complex rhythmic pattern with many beamed eighth and sixteenth notes. A repeat sign is placed at the end of the system, with a circled cross symbol (⊕) indicating the start of the first time through.

Coda.

The second system of music is labeled "Coda." and consists of two staves. The upper staff is in treble clef and the lower staff is in bass clef. Both staves are in a key signature of three flats. The music features a steady eighth-note accompaniment in the bass staff, with a final melodic phrase in the treble staff. The piece concludes with a double bar line.

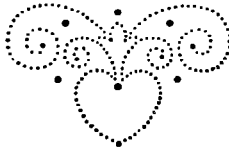



FIELD AND TRACK ATHLETICS.

GENERAL ORGANIZATION OF PREPARATORY WORK



As early as in October, 1909, the Swedish Olympic Committee instructed the Swedish Athletic Association, as being the section for Athletics of the Swedish National Gymnastic and Sporting Association, to make all the technical preparations and other arrangements for the Field and Track events of the Olympic Games, through a Committee appointed by the Board of the Athletic Association. The Board of the Swedish Amateur Athletic Association met at the close of 1909, and an Olympic Committee for Athletics was elected, the members of which, as it was finally constituted, were:

<i>President</i>	COLONEL V. G. BALCK,
<i>Vice-President and Chairman of Executive Committee</i>	LIEUT. G. G:SON UGGLA,
<i>Secretary</i>	LEOPOLD ENGLUND, ESQ.,
<i>Asst. Secretary of the Committee and Secretary of the Executive Committee</i>	KRISTIAN HELLSTRÖM, ESQ.,
<i>Other Members</i>	CAPTAIN OTTO AHNSTRÖM,
	S. CARLSON, ESQ., C. E.,
	CAPTAIN P. HEDENBLAD,
	E. JUHLIN, ESQ., J:R,
	HUGO LEVIN, ESQ,
	S. LÄFTMAN, ESQ.,
	C. O. LÖWENADLER, ESQ.,
	E. SANDBORG, ESQ.,

SUNE SMEDMARK, ESQ.,
 BRUNO SÖDERSTRÖM, ESQ.,
 NORE THISSELL, ESQ.,
Adjoined Members F. BILLE, ESQ.,
 COLONEL, BARON S. HERMELIN.

A special executive committee was nominated, the task of which was to deliberate on and decide all current business and other matters of a pressing nature, and of which the following gentlemen were chosen members :

Lieut. G. UGGLA, *President*, KRISTIAN HELLSTRÖM, *Secretary*, Messrs. F. BILLE, L. ENGLUND, Baron S. HERMELIN, Messrs. E. JUHLIN, J:R., SVEN LÅFTMAN, E. SANDBORG, SUNE SMEDMARK, B. SÖDERSTRÖM and NORE THISSELL.

As the work progressed, and new and wider questions came before the Committee, temporary sub-committees were appointed, the principal of which were:

- That for drawing up the rules and regulations for the competitions,
- » » drawing up the rules and regulations for the Decathlon (or ten-event competition),
 - » » superintending the technical arrangements for the athletic competitions in the Stadium,
 - » » the purchase of athletic apparatus,
 - » » supervising the training of the Swedish competitors,
 - » » deciding the programme of the athletic competitions,
 - » » choosing officials,
 - » » arranging the Swedish try outs.

These sub-committees were in existence for periods of longer or shorter duration, according to the tasks they had to carry out. A detailed account of their work will be found under their special headings below.

The Olympic Athletic Committee having been appointed by the Swedish Amateur Athletic Association, and after a meeting on Thursday, 27 January, 1910, for the purpose of electing a chairman, etc., its first task was to draw up a preliminary proposal respecting a) the branches of athletics that were to form part of the programme of the Olympic Games, and b) the general regulations for the competitions in these events.

CHOOSING THE BRANCHES OF ATHLETICS TO BE REPRESENTED AT THE GAMES. DRAWING UP THE GENERAL REGULATIONS.

The question as to which branches of athletics should form part of the programme of the Olympic Games was a burning one, early

in 1910 even, and, in January of the year mentioned the Committee discussed for the first time the general principles to be followed in determining which track and field events ought to form part of the competitions at the Fifth Olympiad. At this first meeting, when this question came to the fore, the Committee was of the opinion that no more athletic competitions should be placed on the programme than could be got through in eight days. The necessity was also emphasized of adopting only such branches as were exercised by all nations that went in for athletics, at the same time excluding such forms of sport for which it was almost impossible to draw up rules that could be observed in practice and be enforced by the judges. This was the reason that throwing the discus "classic style", for example, never came under discussion when the programme was being drawn up. The Committee was also unanimous in considering that the programme ought to be such, that a place of honour was there given to such events as demanded, in a most special degree, the all-round physical development of the athlete. Thus, it was determined to include in the programme various kinds of all-round events, team-competitions, and throwing competitions, the latter with the right hand alone, as well as with both right and left hand. A proposal to have on the programme, in addition to the ordinary events, jumping and throwing competitions in which form should be one of the most important factors in awarding the prize, was at once rejected. The real reason of this rejection was, that it was at once perceived how difficult it would be to draw up the rules by which such competitions ought to be decided.

After having thus laid down the general lines for determining the various kinds of athletic competitions that ought to form part of the Olympic Games, the following programme was adopted at the meeting of the Committee held on Wednesday, 9 March, 1910:

Running:

A. Individual events:

100, 200, 400, 800, 1,500, 5,000, 10,000 metres Flat;
Marathon Race (40,200 metres); Hurdle Race, 110 metres.

B. Team Competitions:

Relay race, 400 metres (4 men, each to run 100 metres);
relay race, 1,600 metres (4 men, each to run 400 metres);
team race, 3,000 metres (5 competitors from each country,
the best three to count).

Jumping:

Running high jump; standing high jump; running broad jump;
standing broad jump; hop, step and jump; pole jump.

Throwing competitions:

Throwing the discus (free style), best hand, and right and left hand; throwing the javelin (with the javelin held in the middle — Swedish style) best hand, and right and left hand; putting the weight, best hand, and right and left hand; throwing the hammer.

Multiple events:

Pentathlon and Decathlon.

As early as in April of the same year it was decided to add straddle jumping (vaulting horse) to the programme, but this resolution was rescinded later on, it being considered that this form of athletics was altogether too specifically North European to be entitled to a place on the programme of the Olympic Games. At the same time that the decision first mentioned was made, it was also agreed, in accordance with a wish expressed by the International Olympic Committee, to include a walking competition in the programme, this event, however, being restricted to one distance — 10,000 metres, as walking competitions for shorter distances were considered valueless, and not worthy of a place in the Olympic Games. In a very short time, too, the original programme was increased by yet another branch of athletics—cross-country running. A proposal to this effect was made in the Swedish Olympic Committee, and, at the meeting of the sub-committee for Athletics, in June, 1910, it was decided to include this competition, too, especially as it is one of the most popular forms of athletics all over the world.

The branches of athletics that were to be included in the programme having thus been definitely fixed, the next step was to draw up the general regulations for the competitions. As there existed no such general rules that could be taken as a guide, it was a task entailing much labour that the sub-committee for drafting regulations for the competitions had thrown upon its shoulders.

In drawing up the proposed regulations in question, the sub-committee started from the principle that as much regard as possible should be paid to the rules for athletic meetings that obtained in the various countries competing, and then endeavour to make them coalesce, as far as this could be done. Consequently, the Swedish, English, American and German rules and regulations for the different athletic competitions were obtained and compared, and from them were taken all the rules that were considered suitable for the competitions in the Olympic Games, while, in addition to this, entirely fresh paragraphs were added to the proposed list.

Originally, the sub-committee had the idea of drawing up all the rules for the competitions at once and in detail, but it was soon found that such a step would take a very considerable amount of time, and, as repeated inquiries were received from abroad respecting

the rules and regulations for the competitions, it was determined merely to fix such rules at first for the competitions as could be of importance for those training for the Games.

Rough drafts of the general rules for the competitions, as well as for the detailed regulations for the various branches of athletic events, were also drawn up.

These rules for the competitions were at once translated into English, German and French, and forwarded in the autumn of 1911 to all the countries where there was an active Olympic Committee. The rules were very incomplete in many respects, however, and the heavy task still remained of perfecting the detailed regulations for the events.

Towards the close of 1911 this work was begun in full earnest, but, in spite of this, the regulations were not quite ready and printed before the first days of June, 1912. These detailed regulations for the competitions were issued in book form, the little volume, which was a pocket edition, also including all necessary information for the athletes respecting the arrangements for the competitions, etc.

THE QUESTION OF PENALIZING FALSE STARTS.

Several of the regulations for the competitions were very thoroughly discussed by the select committee before a final result was reached. The question that gave rise to most debate was, whether a false start should be penalized or not. The matter was discussed at four or five different meetings without any decision being reached. On the one hand it was pointed out that, if there was no regulation penalizing such starts, the result would be that a great amount of injustice would be committed in the races by one or other of the competitors taking advantage of the omission, by purposely trying to start before the pistol was fired. On the other hand it was emphasized that, with a practised and reliable starter, there would be no question of false starts, especially if the starter received instructions to make a pause between the word "Ready" and the shot, of sufficient length to allow him to feel sure that all the competitors were under perfect control. A further reason against the adoption of any penalizing regulation was the opinion that, at such athletic meetings as the Olympic Games, the best man ought to win, and that, therefore, it was most undesirable to place the competitors on different scratch-lines, as would happen should any false start be made. In most cases it is merely the result of nervousness when a runner happens to start before the pistol is fired, and consequently it would be too severe a punishment, if, at meetings like the Olympic competitions, such a penalty as the one proposed should be in force, which would rob the offender of the possibility of winning a prize he might otherwise deserve. It is true that, at the London Olympic Games, there existed the regulation that a competitor who crossed the line too soon should be penalized for the offence, but the rule was never put in force by the starter in 1908, and still all the starts were quite fair ones.

After a very thorough discussion it was finally decided, but by a very slight majority, that a competitor who crossed the line too soon should not be penalized. The competitions in the Olympic Games proved, too, and most strikingly, that those who had voted against the adoption of any penalty for the offence in question, had held the correct view of the matter. It is true that there were many re-starts for the shorter distances, in consequence of one or other of the competitors getting away too soon, but there was not a single instance of an unfair start.

CALCULATION OF POINTS FOR THE PENTATHLON.

Another detail in the regulations for the competitions that was discussed very thoroughly, was the method in which the points should be calculated for the Pentathlon, or five event competition. It is true that the principle for the calculation in question was clear, i.e., that the competitors ought to be given points in agreement with the figures for the places obtained in the various branches of athletics concerned, and that the sum of these place-figures should be decisive of the relative order of the competitors at the close of the whole event. It was necessary, however, to determine how points should be calculated in the case of two or more competitors, in the 200 metres' flat, for example, covering the distance in the same time, but one of them, in the opinion of the judges, passing the tape the least possible distance behind the other. The last-mentioned as a matter of fact, had shown better form than the one that came in the least bit after the leader, and this better work, in the opinion of the committee, ought to be rewarded. After a number of arguments for and against, it was at last determined that if two or more competitors in different heats in the 200 metres' flat race in the Pentathlon did the distance in exactly the same time they should be given the same points. If, again, two or more competitors in the same heat had the same time, but one man came in the least distance in front of the other, the one that came in behind the first should receive half a point more* than the one that had the same time, but was an inch or so in front. If there happened to be a third man in the same heat whose time was the same as the first man's, but who was such a little distance behind him that there could be no question of difference in time, then this third man, like the second, should have half a point added to the figure obtained by the winner. Should, however, the final result, on all the place-figures being added together, show that the second and third men in such a heat had the same figures, then the "second" man should be entitled to be placed before the "third" man.

DRAWING UP THE RULES FOR THE DECATHLON.

One of the most difficult questions that the sub-committee for Athletics had to decide during the course of its labours was

* N. B. The first man in this competition always has the *lowest* points.

the determination of the principle for calculating points in the Decathlon, or ten-event competition. From the beginning it was fully understood, of course, that each competitor would be given points for the result gained in the various events, irrespective of the place-figure, but it was exceedingly difficult to fix a norm for the proper evaluation of the results reached. It must be remembered that the Decathlon was quite a new competition on the programme of the Olympic Games, and that there was nothing to go by. It is true that the Swedish Amateur Athletic Association had its own method of calculating points which was used at Swedish championship meetings for the Decathlon, but, for many reasons, it was impossible to make use of this system for the Olympic Games. The method of calculating points employed by the A. A. U. in America, at all-round championship meetings in that country, was also studied.

After the matter had been discussed at several meetings of the committee, without any acceptable principle for deciding the method of calculating points having been found, a select committee was nominated in February, 1911, with instructions to draw up a complete scheme for the settlement of the question.

The first thing was to discover the fixed points that were to decide the graduation of the scale of points. According to the Swedish Decathlon table, 1,000 points were given for results equal to recognized Swedish records, and as, in the matter under discussion, it was a question of a World's Championship, it was thought best to take as a basis, the award of 1,000 points for results equal to world's records, this figure to be a kind of maximum in the table. Then arose the question, however: 'What is a world's record?' At this time there did not exist, as the reader knows, any International Amateur Athletic Federation that registered world's records, as is the case in many other branches of modern sport. A proposal was made to write to the athletic associations of every country, with a request for information respecting the records for each one, and then to take the best figures thus obtained as the norm for a 1,000 points result. It was impossible to carry out this proposition, however, time not allowing of the arrangement of such an extensive scheme as this would be for the solution of the problem in question, besides which, it would, of course, be really impossible to compare the records thus obtained with each other, they having been made under widely varying conditions and, in many cases, in accordance with rules differing greatly from each other and varying in severity. One possibility remained — that of accepting the Olympic records as the 1,000-point norm. The Olympic records set had been made under fully satisfactory control, and as nearly as possible under the same conditions as those that would obtain now. It was determined, therefore, to take as a basis the Olympic records already made, and to fix them as the 1,000-points results. Then, in order to obtain an acceptable descending scale of points, it was proposed to take the average results in each of the ten different events and give them 500 points. The minimum result in the scale of points for the different

branches of athletics in the competition thus became altogether an arbitrary one. An evident weakness in this proposal was, of course, the fact that it was an arbitrary personal point of view that determined the 500-points result. But in order to find the most suitable norm for this, the members of the select committee had recourse to very prominent experts in the sphere of athletics, both active and passive, and it was not before the question had been thoroughly discussed, and after many alterations had been made, that the committee succeeded in obtaining fully comparable and equivalent figures for the ten different events, and it was only after the scale of points thus arranged had been proved by experiment to be a fully satisfactory one, that the complete table of points was drawn up.

As was to be expected, however, the proposal of the select committee met with opposition when it was presented to the sub-committee for athletics. The principal objection to the scheme was, that there was no mathematical basis underlying the whole, but that the table had been, in part, drawn up arbitrarily, even if behind the personal opinions there existed a great deal of practical experience which, of course, rendered it probable that, in practice, the table would be a perfectly fair one, but which, none the less, might give rise to unpleasantness of one kind or another, there being no fixed principle to which one could point as the basis of the table of points now drawn up. As it was impossible to come to a unanimous opinion with regard to the proposal, the sub-committee nominated a new select committee for the purpose of sending in another scheme. A proposal was, consequently, drawn up, based on entirely new principles. As in the former scheme, however, the starting-point of the new plan was the proposal that results equal to Olympic records should be estimated at 1,000 points. But, in distinction from the proposal first put forward, the minimum result or zero point was also determined, this being done by simply giving 0 point for 0 centimetres in the jumping and throwing competitions, while, for the races, the time for the Olympic records was doubled, the result obtained being taken as equal to 0 in the scale of points. A more palpable and stricter principle was thus gained, but, on the other hand, the point-table obtained gave, in certain cases, points that varied very considerably in value for results obtained in different branches of athletics, which, by experts, were considered as being of absolutely equal worth.

This scheme, too, met with great opposition. It was pointed out that it was incorrect to give a 0-value to a broad jump, for example, that was 0 centimetres long. It would have been better, said the critics, to fix 0-point for a result that could be obtained by an average person without any kind of training, but then, again, if this latter plan were to be adopted, this scheme, too, would become an arbitrary one. The proposal that, in order to obtain a fixed 0-point for the calculation of the races, the time for the Olympic record should merely be doubled, also met with sharp criticism. Thus, for example, according to this proposal, a competitor would receive points for

time less than 21,6 seconds for 100 metres. This is a time that, of course, anyone in normal condition ought to be able to run the distance in, but still, there is no risk in saying that it is a greater feat to run 100 metres in 21 seconds, for example, than to clear 10 centimetres in a high jump. After the scheme last put forward had been discussed at several meetings, the sub-committee, at a meeting held on 20 April, 1912, decided to add to its number a mathematician, who, together with some athletic experts, should endeavour to solve the question.

For this purpose, the sub-committee applied to Mr. Frithiof Schäring, Mathematical Assistant to the Thule Insurance Co., who sent the committee the following detailed and interesting contribution to the solution of this very difficult problem:

A Mathematical Investigation of the Methods proposed for the Calculation of Points for the Decathlon Competition.

To The Swedish Olympic Committee, Stockholm.

At the request of the Committee for drawing up the rules for the Decathlon, I have examined two schemes originating from that body, dealing with the calculation of points in the competition in question. My task embraced an investigation of the possibility of obtaining a fully adequate mathematical expression of some principle for calculating points, which could be unanimously adopted by the committee. The first part of my task, therefore, was to criticize the principles that had found expression in the two proposals already made, and then, if neither of these could be fully approved of, to discover a new principle more closely corresponding with the real state of things. The second problem I had to solve was the mathematical determination of this principle. Having now completed the commission entrusted to me, I beg, herewith, to give the following account of the investigations in question.

If a comparison be made between the three competitions, the 100, 400 and 1,500 metres' flat, it is at once seen by the times that form the Olympic records for these races, that, in the case of the greater amount of work done (the 1,500 metres' race is a greater amount of work than the 400 metres', and the latter greater, again, than the 100 metres'), a phenomenon becomes visible that can be termed "sensation of fatigue". This sensation of fatigue becomes evident 'when any kind of work is done, and in a greater degree in the case of the relatively untrained, or the physically inferior individual. A physically superior, but not rationally trained body may have, and has, in all kinds of competitions, opposed itself to one, physically inferior, but trained in accordance with rational methods. The same result is, perhaps, reached by both, and so both should then be awarded the same number of points, for it is a question, in this case, of evaluating the results shown, i.e. the degree in which the above mentioned "sensation of fatigue" has been overcome. *It is, by no means, the manner in which the sensation in question has been overcome, but only the degree in which this has been done, that ought to be taken into consideration.* And if this holds good as a general rule, it does so in a far higher degree for the Decathlon, with its different branches, which, on the whole, all demand different physical characteristics and distinct methods of training.

The Olympic record in each branch of athletics can be regarded as the maximum of work performed in that branch and has, therefore, been given the point-value of 1,000 by the Olympic Committee. So far I am in agreement with the Committee. But, as regards the gradation of the scale of points downwards, I consider that neither of the two proposals made by sections of the Committee has paid any consideration at all to the sensation I have pointed out. For both of the

schemes in question, although otherwise starting from different premises, allow the downward gradation of the points to be made with intervals of equal magnitude in the amount of work performed; i.e., the curve that is represented by the point-figure as ordinate, and the amount of work performed as absciss, is a right line. But this is clearly incorrect, as, by the deduction that may be made from the argument above, it is seen that a relatively small increase in the amount of work performed, demands greater physical possibilities (i.e. greater strength, or the like) or more rational training, or both in conjunction, the higher up in the scale of work done the competitor comes, and that, therefore, it should be accompanied by a comparatively great increase in the scale of points. Or, expressed in other words:

The curve defined above — the point-curve — ought not to be a right line but a line with degrees of higher value.

Having come so far, the question remains: What is the appearance of this curve? This question cannot be answered directly, of course, as it necessitates a number of preliminary investigations. A result of the kind that is wished here must, at the end, be based on experience, for which, again, much material, in the way of results, must be available. Without any doubt, the most rational method of solving the problem would be by ascertaining *the probability of attaining to* (performing) *a certain amount of work*. This probability could be ascertained by examining the reports of the results of competitions held within some period near the present one, and the number of the competitors that attained the various results. The period should be one very close to the present time, as, otherwise, too low results may be presupposed. With the aid of these probabilities it would be possible to construct a table of the probable number of those who might be expected to reach a certain result in the competitions. These figures, graphically registered and eventually graduated, would then give a curve, whose curvature it ought to be a comparatively easy task to draw, and which, in accordance with its construction ought to be conform to the point-curve. As, however, this construction necessitates the existence of a great amount of material, and as, again, the material available is not altogether in such a state that full use can be made of it, and time not permitting of the collection and examination of fresh figures and reports, there exists no possibility, for the present, of arriving at any conclusion by the means now discussed. I wish, however, to call attention to a method that may be of service on a future occasion.

Is there, then no other way of obtaining this curve of difficulty in reaching greater results of work, a curve which, in accordance with what has been said above, is conform to the point-curve? The answer is "Yes", for, as a result of my introductory reasoning, I was thrown into a way leading to the solution of the problem, which, although not such a rational one as that described above, promised to prove quite effective; I was struck by the following idea. If the "fatigue-factor" was non-existent, then, when the Olympic record for the 100 metres' flat is 10.8 seconds, the Olympic record for the 400 metres' ought to be 43.2 seconds instead of 48.4 seconds, and that for the 1,500 metres', 2 min. 42 secs., instead of 4 min. 3.4 secs. These amounts of work performed are fully comparable with each other, and thus the deterioration in respect to time, forms a good measure of the difficulty in the way of attaining to higher amounts of work, so that the Olympic records for these three competitions offer a possibility of determining the form of the curve desired. But, as all the ten branches of athletics embraced by the Decathlon ought, quite naturally, to awaken just the same attention, on the part of the competitors, to the care and training of the natural conditions possessed by each runner, and as, thus, all subsidiary considerations should be neglected, one is quite naturally driven to make the conclusion that, in fixing the point-values of the results of the competitions in the seven other branches of athletics in the Decathlon not yet treated of, respect should be paid to nothing else but the degree of difficulty attending the amount of work performed, and that this difficulty, dependent, as it is, on exactly the same causes in all the events of the competition, ought to be represented in *all* the branches by the same curve that has already been discovered for the three events already discussed.

* * *

When I say above that the curve has already been discovered, I mean that there now remains nothing to be done but the purely mechanical calculations necessary for determining the form. With the three points in the plane, that are represented by the work done (100 metres, 400 m. and 1,500 m.), as abscissæ, and the corresponding expressions for the difficulty attending the work-result (the Olympic records 10.8 seconds, 48.4 secs., and 243.4 secs.) as the ordinates, the co-efficients for a function $f(x)$ of one variable can now be determined. From all appearances, the curve represented by this function accommodates itself far better to the actual condition of things than the right lines of the preceding proposals made in the sub-committee. The function has the form

$$f(x) = Ax^2 + Bx + C$$

and the equation of the curve will be

$$y = f(x).$$

The constants A , B and C are determined by means of the system:

$$\left. \begin{aligned} f(100) &= 10.8 \\ f(400) &= 48.4 \\ f(1,500) &= 243.4 \end{aligned} \right\} \text{and become}$$

$$\left\{ \begin{aligned} A &= + 0.0000370 \\ B &= + 0.10683 \\ C &= - 0.253 \end{aligned} \right.$$

The curve of the equation will thus be

$$y = 0.000037 x^2 + 0.10683 x - 0.253.$$

As the arithmetical calculations should be facilitated as far as possible, the pole, or origin, is moved from the point $x = 0$; $y = 0$, to the point $x = 1,443.6$; $y = 76.859$, and then assumes the simpler form

$$x^2 = 27,027.027 y.$$

From this form of the function it is evident that the curve is a parabola. One of the characteristics of the parabola is, that it possesses no asymptote. The advantage is hereby gained that there exists no limit to the evaluation of the degree of difficulty of work done, i.e. to the fixing of the point-value. *Even if future results should beat the present Olympic records in ever so high a degree, still, they could always be evaluated in accordance with the same norm as before.* There could be no question of doubt; no question of favoritism or its equally deplorable opposite. The curve can be continued to infinity past the 1,000-points line in the scale of values.

The curve gives the following couples of the values of x and y :

Difficulty of result-work (Points).	Results.
$y = 1,000$	$x = 5,198.8$
$y = 900$	$x = 4,932.0$
$y = 700$	$x = 4,349.6$
$y = 500$	$x = 3,676.1$
$y = 400$	$x = 3,288.0$
$y = 300$	$x = 2,847.5$
$y = 200$	$x = 2,325.0$
$y = 100$	$x = 1,644.0$
$y = 0$	$x = 0$

The next thing, thus, that remains to be determined is, what is "difficulty of result-work" in the various branches of the Decathlon? The measure of the difficulty of result-work must be of such a character as to give a smaller figure for a lesser degree of difficulty overcome than will be awarded to a greater degree of difficulty. This being determined, the following measures may be agreed on:

- For the running: the inverted value of the seconds-figure of the time taken;
- For the jump: the centimetre-figure of the high- or broad jump;
- For the throw: the metre-figure of the throw or put.

In this connection I beg to point out, however, that it is by no means hereby asserted that a certain number of seconds in a race is equivalent to a certain number of centimetres in a broad jump, or to a certain number of metres in a throw. The equivalency that exists, and which varies according to the place on the curve where the examination is made, depends only on

- 1) my determination of the form of the curve,
- 2) the determination, by the Olympic sub-committee, of the position of the 1,000 point.

It is, thus, no new assumption that is made here; it is merely the fixing of the form of the x -co-ordinate for $y = 1,000$ points.

Employed in this manner, the point-curve gives the appended Point Table I.

If we compare the point-figures in this table with the point-figures (corresponding to the times and lengths of the figures first named) in the two proposals made in the committee, the agreement will be found to be a pretty close one. If for the point-figures of the two proposals in question we substitute the average figures lying between those of the two schemes in question, the agreement will be still closer, a state of things that seems a very natural one, as the truth, it may safely be supposed, lies "in medias res".

The striking peculiarity of my table is, that a value is given to results which, in the two committee-proposals, are marked 0. This is a result of the assumption that a result should be evaluated to the degree of difficulty that there is in reaching it. As long as any result at all is reached, there is a certain degree of difficulty to be overcome, there, thus, being a degree of difficulty and a point. Not before there is a total absence of any result can I put the mark 0.

Perhaps, however, this theoretical reasoning will be found to be altogether too fine to suit the practical athlete. The plan can then be adopted of cutting off the various point-curves at the place where the results are practically no results at all. But this brings us at once to arbitrary methods, and it is by no means advisable to adopt these.

I should, instead, propose that all the curves should be cut off at the same places, at points which, in accordance with what has been said above, are of equal values, the point of abscission being taken at such a distance far down the scale that all athletes, to whatever nationality or branch of sport they may belong, would be able to agree that, below the point in question, no time made, or length covered, could be considered as a result. As I have privately ascertained, it would not be necessary to go lower down the scale than the 400-point mark in order to find the place desired. The vertex of the curve ought, then, to be placed at this spot, and the curvature of the curve should be applied to establish the increase in the results from the 0-point thus chosen.

When the pole, or origin, and the vertex are moved to what was before the 400-points mark, the point curve will obtain the form

$$(x + \sqrt{10,810,810.8})^2 \cong 61,213.813 y + 10,810,810.8.$$

By using this form, I have obtained Point-Table II. Only the work demanded for points 1,000, 900, 700, 10 and 0 have been included; the first three ought to be quite sufficient to enable the practical athlete to judge of the working of the table. The work demanded in order to reach 10 points has been included only in order to be able to illustrate the difference in the amount of work demanded at various places along the scale. In order to obtain 10 additional points, the results ought to be improved by the following amounts:

Between the points.

<i>Event in the Decathlon</i>	<i>900—1,000</i>	<i>700—900</i>	<i>0—10</i>
100 metres flat	0.04	0.050	0.1 sec.
Hurdle race.....	0.06	0.065	0.2 sec.
400 metres flat	0.20	0.215	0.5 sec.
1,500 metres flat	1.00	1.070	2.5 sec.
High jump	0.49	0.535	1.2 cm.
Broad jump.....	1.95	2.095	4.9 cm.

Between the points.

<i>Event in the Decathlon</i>	<i>900—1,000</i>	<i>700—900</i>	<i>0-10</i>
Pole jump	0.97	1.040	2.4 cm.
Putting the weight.....	0.039	0.0415	0.10 met.
Throwing the discus	0.108	0.116	0.27 met.
Throwing the javelin.....	0.143	0.1535	0.36 met.

* * *

Should the Olympic Committee determine to employ any form of the point-tables given by me above, I shall, of course, be willing to draw up the scheme in question in full detail.

Finally, I wish to remark that if, in any future criticism of my point-tables, some values should be found to be not perfectly equivalent, this will not be the result of the principle that has been chosen in order to obtain it, but will rather depend on the starting-point taken the 1,000 points mark, fixed by the Committee. A relatively high Olympic record in any one event in the Decathlon necessitates, unconditionally, a relatively high work-demand for the lower points obtained too, but, still, the work performed in order to gain the points in question will be quite as comparable with each other as the Olympic records are. If the Olympic Committee has accepted the latter, with all the inaccuracies that may attend them with respect to the comparison that can be made by their means, it follows, as a necessary consequence, that the former should also be accepted, as the inaccuracies that may attend them are neither greater nor less than those attached to the records taken as the starting point of the calculation.

Stockholm, 13 May, 1912.

Frithiof Schäring, B. A.
Thule Life Insurance Co.

POINT TABLE I.

<i>Event</i>	<i>Points</i>	<i>1,000</i>	<i>900</i>	<i>700</i>	<i>500</i>	<i>400</i>	<i>300</i>	<i>200</i>	<i>100</i>	<i>0</i>
100 metres flat	10.8	11.4	12.9	15.3	17.2	19.7	24.1	34.1	∞	secs.
Hurdle race	15.0	15.8	17.9	21.2	23.7	27.4	33.5	47.4	∞	secs.
400 metres flat	48.4	51.0	57.8	68.4	76.5	88.4	108.2	153.1	∞	secs.
1,500 metres flat ...	4/3.4	4/16	4/51	5/44	6/24	7/24	9/4	12/49	∞	m/secs.
High jump.....	190	180.2	159.0	134.4	120.2	104.1	85.0	60.1	0	cm.
Broad jump	748	709.6	625.8	528.9	473.1	409.7	334.5	236.5	0	cm.
Pole jump	371	352.0	310.4	262.3	234.6	203.2	165.9	117.3	0	cm.
Putting the weight..	14.80	14.04	12.38	10.47	9.36	8.11	6.62	4.68	0	m.
Throwing the discus	41.46	39.33	34.69	29.32	26.22	22.71	18.54	13.11	0	m.
Throwing the javelin	54.83	52.02	45.87	38.77	34.68	30.03	24.52	17.34	0	m.

POINT TABLE II.

<i>Points</i> <i>Event in the Decathlon</i>	<i>1,000</i>	<i>900</i>	<i>700</i>	<i>10</i>	<i>0</i>
100 metres flat	10.8	11.2	12.2	17.0	17.1 secs.
Hurdle race.....	15.0	15.6	16.9	23.5	23.7 secs.
400 metres flat	48.4	50.4	54.7	76.0	76.5 secs.
1,500 metres flat	4/3.4	4/13.4	4/34.8	6/21.5	6/24 m/secs.
High jump	190	185.1	174.4	119.0	120.2 cm.
Broad jump	748	728.5	686.6	478.0	473.1 cm.
Pole jump	371	361.3	340.5	237.0	234.6 cm.
Putting the weight.....	14.80	14.41	13.58	9.46	9.36 met.
Throwing the discus	41.46	40.38	38.06	26.49	26.22 met.
Throwing the javelin.....	54.83	53.40	50.33	35.04	34.68 met.

The sub-committee for athletics considered that the scheme just described was a most excellent one, but that it was impossible to adopt it in the form in which it had been laid before them. It was thought, however, that for future Olympic Games, an attempt should be made to gather the necessary material, and to use it in accordance with Mr. Schäring's proposal. In this way it would be possible to draw up a Decathlon table, based on mathematical principles, and which would be a perfectly fair one in every respect.

The Games were close at hand, however, and it was necessary to come to an immediate decision. The select committee first nominated now made some alterations in its original scheme, the revised plan receiving the approval of the sub-committee at a meeting held on the 5 June, 1912.

The method of calculating points thus adopted was briefly as follows: For results equal to the Olympic record, 1,000 points were given.

For the 100 metres flat, 23.8 points were deducted for each $\frac{1}{10}$ sec. worse than the Olympic record, $10\frac{4}{5}$ secs. The zero point was fixed at 15.1 secs.

For the broad jump, 2.45 points were deducted for each centimetre below the Olympic record, 7.48 metres. The zero point was fixed at 3.39 metres.

For putting the weight, 1 point was deducted for each cm. below the Olympic record, 14.80 metres. The zero point was fixed at 4.80 metres.

For running high jump, 14 points were deducted for each cm. below the Olympic record, 1.90 metres. The zero point was fixed at 1.18 metres.

For the 400 metres flat, 3.76 points were deducted for each $\frac{1}{10}$ second worse than the Olympic record, $48\frac{2}{5}$ secs. The zero point was fixed at 1 m. 15 secs.

For throwing the discus, 0.38 points were deducted for each cm. below the Olympic record, 41.46 metres. The zero point was fixed at 15.14 metres.

For the hurdle race, 110 metres, 9.5 points were deducted for each $\frac{1}{10}$ second worse than the Olympic record, 15 secs. The zero point was fixed at 25.6 secs.

For the pole jump, 5.4 points were deducted for each cm. below the Olympic record, 3.71 metres. The zero point was fixed at 1.85 metres.

For throwing the javelin, 0.275 point were deducted for each cm. below the Olympic record, 54.83 metres. The zero point was fixed at 18.46 metres.

For the 1,500 metres flat, 0.60 points were deducted for each $\frac{1}{10}$ sec. worse than the Olympic record, 4 min. $3\frac{2}{5}$ secs. The zero point was fixed at 6 min. $50\frac{1}{10}$ secs.

The Decathlon table was thereupon drawn up in detail and printed separately, the table showing the number of points given for each centimetre in the jumping and throwing competitions, and for each

$\frac{1}{10}$ second in the racing. In spite of the fact that it was very late before a decision was come to respecting the method of calculating points to be employed, the Decathlon table was printed and in readiness for distribution in good time before the beginning of the Games.

THE ATHLETIC=TECHNICAL DETAILS IN THE STADIUM.

As early as the beginning of 1911 the sub-committee for athletics nominated a select committee entrusted with the care and responsibility of all the purely athletic-technical details in the building of the Stadium.

Originally it had been the intention to arrange a straight track, 200 metres long, in the middle of the arena. Gradually, as the details of the building plan took form, it proved, however, that it was impossible to obtain a straight 200 metres track, the more so that the slope of the curve of the principal running track had to be graded, and so there remained nothing else to be done but relinquish the idea of a straight track of the length mentioned. The running track, which it was originally intended to make 400 metres long, was finally made c:a 18 met. shorter, in consequence of the fact that it was not until after the building operations had been begun that the curves were altered from elliptical to semicircular. At first the running track had been planned with one curve semicircular and the other elliptical. The select committee for the athletic-technical details altered this, however, making both curves semicircular, the curves, at the same time, being made arcs of circles 3 metres smaller in diameter than the original ones. The various distances marked on the track can be found on page 345.

One detail that gave rise to a great deal of discussion was, whether the hurdle race should be held on a grass track or on the cinder path. In England, hurdles are run almost exclusively on grass, while, in America, custom varies. From many points of views, however, the grass track for hurdles is the more attractive one. The committee in general was inclined to have the race in question run on a grass track in the inner part of the arena, but it afterwards proved impossible to get the turf sufficiently hard and level, and, consequently, there remained nothing else to be done than to have the hurdle race on the cinder running track, on the same side as that for the 100 metres flat.

The throwing competitions, too, were originally intended to take place on turf, but the ground proved altogether too loose for the purpose. In consequence it was found necessary to have a special cinder-laid run made for the javelin-throwing competition, within the curve near the principal entrance, while, for the discus throwing, putting the weight and throwing the hammer, the turf was removed from inside the iron hoops, the space being afterwards filled with a substance of the same composition as that used for the running track, with a further addition of earth and clay.

For the jumping competitions, special cinder-tracks were sunk in the central arena, in the longitudinal direction of the Stadium, with the jumping pit opposite the Royal box. The pitches or runs on each side of the jumping pit measured 38 metres in length and 1.65 m. in breadth, with the exception of that for the pole jump, which was made 1.90 m. broad. The tracks for the high jump were arranged in the curve near the principal entrance. These, too, were cinder tracks, and of such dimensions that four competitors could jump simultaneously over separate bars.

THE ARRANGEMENTS FOR THE COMPETITIONS IN THE STADIUM, ETC.

At the beginning of 1911, preliminary proposals had already been made concerning the arrangement of the competitions in the Stadium. Careful preparations in this respect, and great care in the choice of officials were of absolute necessity if the Games were to be carried out successfully, and the instructions for officials, which were drawn up with the most careful attention paid to every detail, were calculated to prevent any failure in this respect. It was also seen that first-class apparatus and material in general would also contribute to making the Games the success it was hoped they would be. The running- and jumping tracks were in the best condition, too, after Mr. Charles Perry, the English expert running-path constructor had undertaken the direction of this part of the work.

Special arrangements for the various branches of athletics.

For the leaders of the competitions there was erected a special stand in the middle of the Stadium, from which telephone wires were laid to the band-stand, the Press stand, and to the offices of the Secretary of the Committee, in the clock-tower of the Stadium. The leader-stand was also in communication with all the dressing rooms, in which, ten minutes before each start, a signal was given by ringing an electric bell, while, at the same time the criers of the starts informed the competitors in the dressing rooms of the names of the events that were to be taken. This was done by the criers of the starts striking gongs, while in the rooms there was shown a large notice-board, on which were written the numbers corresponding to those of the various events in the daily programme. In this way all the competitors received notice in good time before the beginning of an event, and the leaders could be sure of all the competitors being in their places when the competition was about to begin. These arrangements with electric bells in all the dressing rooms and the giving notice by means of the crier, probably formed one of the chief reasons that it was found possible to begin the competitions exactly at the time given in the programme.

Regarding the drawing of lots, the arrangement was made that, immediately after the preliminary heats were finished, the official re-

representative of every country that had one or more competitors in the second heat was summoned to a meeting held in the clock-tower, for the purpose of drawing lots for the heat in question. Before the drawing of lots each country was allowed to name its best man (to the extent the number of heats permitted) so as to avoid, as far as possible, having two men in the same heat who had been given as the best from two different countries. This having been done, lots were drawn in the usual way by the other competitors. This arrangement proved to be a very successful one, as it did away with every feeling of dissatisfaction that might have been caused by two or more of the best runners of the same nation coming in the same heat, and there could be no reason for any of that want of confidence which so easily arises on such occasions as the one in question, every country having the opportunity of being present, in the person of its representative, at the drawing of lots.

In the daily programme of the competitions in athletics there were given the name, number and nation of each competitor, together with the time at which the different events were to begin. The Olympic and Swedish records, and extracts from the regulations for the competitions were also given, with the result that the members of the public, too, even if they had no direct interest as experts, could follow the competitions with interest and, to a certain degree, judge the value of the results. The preliminary preparations for every special competition were made with the greatest detail. For the broad jump, hop, step and jump and the pole jump, there were laid down wooden laths, 35 metres long, marked off in *metres* and *feet*. In this way it became unnecessary for the competitors to go before the beginning of an event to measure their run with a tape, a process that always takes a long time, of course, and which contributes in some degree to delaying the commencement of a competition. Now all that the competitors had to do was to read off from the laths laid by the side of the tracks the length of the run they wished to have, and at these places stick in the ground the white laths on which their competing numbers were marked. The jumping-pit was filled with fine white sand which had, first of all, been thoroughly drenched, and then rolled, so that its surface was on a level with the take-off-plank. All the measurements, both in the jumping- and the throwing-competitions, were made with a steel yard, which was examined both before and after each competition. On account of the great number of competitors, the latter were divided into groups for the jumping and throwing competitions, each group numbering from 10—15 competitors, of whom, in the broad jump, hop, step and jump and the pole jump, only the three that got the best results irrespective of the group in which they had competed, had the right to take part in the final. The hop, step and jump event was carried out on a cinder path. It was the intention at first to keep turf on that part of the track lying between the take-off-plank and the jumping-pit, but as it proved difficult to get the turf sufficiently hard, and as it was also feared that it would be impossible to use such a track

in wet weather, the first-named plan was abandoned and the whole of the track for the hop, step and jump competition was cinder-laid.

As there were no fewer than 4 tracks for the high-jump, it was found possible to arrange the competition in this branch of athletics in such a way, that all the competitors could jump at the same hour, all those clearing 183 centimetres being entitled to take part in the final, which was held the next day and which, of course, took place on a single track.

The great difficulty in arranging the throwing competitions was to discover the most suitable material to fill the hoop with. It was not suitable to employ merely turf, this not being firm enough. It also proved impossible to use the same material as that of which the running path was made, as it was necessary for the place for the swing to be of harder material than the path. After a number of experiments made during the training competitions in the spring, a good mixture of cinder, earth and clay was discovered, which proved to be an excellent one for the purpose. The hoops for the competitions, putting the weight, throwing the hammer and throwing the discus, were filled with this material in such a way that, on the side towards which the throw was made, the iron hoop lay 2 cm. above the level of the ground while, at the other side, the ring was level with the turf. In throwing the hammer, the additional step was taken of pressing down the turf all round the outside of the hoop, so that the competitors might be able to avoid striking the hammer-head on the ground while swinging the hammer. Another extra precaution taken with regard to the competition last mentioned was, that there was erected behind the ring, on the side nearest the stands, at a distance of about 3 metres from the hoop, a high and firm wire-fence, for the purpose of preventing any accident occurring in the event of a competitor letting the hammer slip from his hand, or throwing it in the wrong direction. For the throwing competitions, the ground was marked with arcs drawn within the 90° sector fixed by the rules, beginning at a distance of 30 m. and continued until the Olympic record was reached. The distance between these arcs was one metre. The arc showing the Olympic record was marked by a miniature flag of that country whose representative possessed the record in question. For example, the Olympic record in throwing the javelin was marked with the Swedish flag; those for putting the weight and throwing the discus, with the U. S. A. flag, and so on. Of course, no arcs were used in the javelin-throwing competition, but lines were marked parallel to the crease, in order to show the length of the throw. Each throw was marked by a miniature flag, of the same colour as the scarf round each competitor's waist, being fixed in the ground, at the place where the discus, hammer, etc., pitched. In this way it was possible for the public to follow the course of the competitions, and see which thrower had come farthest and, as the distance of the above-mentioned arcs and parallel lines from the crease or scratch-line was clearly marked, the public could judge pretty closely the length of each throw made.

In order to mark the different tracks in the short distance flat-racing, the chalked lines usually employed were not made use of, but long ropes had been dipped into a mixture of chalk and water, then dried, and wound round a roller running on an axle which, in its turn, was attached to wheels. When a short distance race was to be run it was, of course, a very simple matter to mark the limits of each track by simply drawing the wheeled apparatus along the course and letting the lines run out. After the race was over, the ropes were wound up again by means of a crank-handle attached to the axle, and were thus in readiness for use on the next occasion.

For the judges at the finish there was erected a special stand, on which 8 or more judges could place themselves, and get a good view of the tape without coming in each other's way. The numbers of the tracks were placed in special celluloid cylinders, so that all irregularities in the draws for "lanes" were entirely prevented.

All times in the competitions were taken by means of an electric register. A special account of the way in which this part of the arrangements was carried out will be found on another page.

The arrangements for the Marathon race.

One of the competitions that necessitated a vast amount of preparatory work was the Marathon race. It was no easy task for those members of the sub-committee for athletics who had been delegated to make the arrangements in question, to find out a course running in a semicircle outside the Stadium, and with the start and finish inside the Stadium itself, and when the problem finally proved impossible of solution, it was agreed to employ the country road leading to Sollentuna, with the turn close to Sollentuna Church, exactly 20,100 metres from the starting point in the Stadium.

The arrangements along the course.

The start of the race was on the running path in the Stadium, just opposite the Royal box. After covering three quarters of a lap to the left along the track, the competitors left through the principal gateway leading to Valhallavägen. This road was followed until the course branched off to the right behind the East (Östra) Station and went on to Stocksund, 5 kilometres (3 miles) from the start, where the first control-station was situated. From Stocksund the road ran past Ulriksdal and Järfva to Silvverdal and Tureberg, the second control-station, 15 kilometres (9 miles) from the Stadium. Then the course went on to Sollentuna Church, the point where the runners had to turn. All the large, loose stones that could be seen on the road were taken away, and, where necessary, the course was watered so as to lay the dust, which, here and there, was pretty deep. Along Valhallavägen, and the whole way to Söderbrunn, the course was guarded by a close line of police, the remainder of the road being kept

free from intruders by military, who also had the task of showing the runners the way, should such help be needed. Altogether, there were 100 policemen and 300 soldiers stationed along the route, in addition to a very large number of control-officials and boy-scouts.

Every five kilometres (3 miles), placards were put up, showing the distance from the Stadium, so that the competitors might know what proportion of the course had been run and what still remained to be covered.

As was previously mentioned, the control-stations proper were at Stocksund and Tureberg. At these places, every imaginable measure had been taken to have medical help at hand in case of any accident. There was a fully equipped sick-room at each station, with an ambulance carriage and additional motor-cars, together with all the kinds of refreshments that the regulations permitted. Dr. Arnold Josefsson was the medical man in charge at Stocksund, the station at Tureberg being in the hands of Dr. Gustaf Nicklasson. Special medical patrols were stationed at the turn near Sollentuna Church. Medical aid could be had at Söderbrunn and Silfverdal, too, in addition to the places already mentioned, Dr. Gösta Åman being in attendance at the first-named station and Dr. Georg Liljenroth at the second. Fully equipped sick-rooms were opened there, too. In addition to all this, arrangements were made at almost every 500 metres to have a supply of various kinds of refreshments for the competitors, such as oranges, lemons, water, tea, etc.; everything, in fact, that could be thought of in this way, with the exception of such as could be regarded as drugs. The task of the boy-scouts mentioned above, was to signal at once to each other along the course to the nearest medical-aid station, in the event of any competitor asking for assistance or appearing to be in need of a doctor.

The road along which the course lay was closed to traffic for one hour before the beginning of the race, and for the same length of time after its close. During the intervening period no persons or vehicles were allowed on the course, with the exception of the competitors, the motor-cars belonging to the medical attendants, that of the leaders of the competition, Messrs. Djurberg and Dr. Fries, and the ambulance carriages.

The arrangements inside the Stadium.

Inside the Stadium there was a medical-aid station in charge of Doctors Axel Wahlstedt, Ernst Levin and Gunnar Nyström, who had a whole company of sick-nurses from the Volunteer Medical Aid Column as their assistants, while a little hospital was arranged below the west grand stand.

One matter of great consequence was to have some satisfactory means of keeping the spectators inside the Stadium acquainted with the progress of the race. In the printed programme the control-station at Stocksund, for the outward run, was marked A, and for the home run F. The control-station at Tureberg was marked B and E

respectively, and the turn at Sollentuna C and D. All these stations along the course were connected by telephone with the stand for the leader of the competitions in the Stadium arena. Near this stand there was erected a signal-mast, on which was shown the relative positions of the various nations competing. For example, when the station at Stocksund was passed by the first man on the outward run, the letter A was hoisted on the mast and then, beneath this letter, the flag of the nation to which the competitor belonged. If, for example, the first man to pass the station in question was a Finlander, the second man a Swede, the third an Italian, the fourth a Frenchman, and so on, then the Russian flag was hoisted immediately beneath the letter A, the Swedish, Italian and French flags following in the order mentioned. The same thing took place when Tureberg was passed, when the letter B was, of course, hoisted. At the same time, the public inside the Stadium was informed by megaphone of the name, number, nation and time of each competitor as he passed the stations.

MAKING KNOWN THE RESULTS TO THE PUBLIC AND THE PRESS.

The committee for Athletics, quite seeing the great importance of the public and the press being able to follow the details of the various competitions easily and clearly, drew up very detailed regulations, and tried a number of experiments, in order to find out the best way of arranging this part of the preparations for the competitions at the Stadium. For this purpose, the Committee procured some 3-sided notice-boards with a hoisting device, so that when the upper part of the 3-sided board was on top, the figures giving the numbers and results of the competitors were being placed on the lower halves. The result of employing this device was that, after a race or a throw, etc., the public at once could learn the result of the competition. Officials were appointed to attend to manage each of these notice-boards, a number of boy-scouts being told off to act as assistants. For the races there was a notice-board erected at the finish, and one at the start. Before each start there was shown on the board just mentioned, the heat that was to be run and the numbers worn by the competitors who were to run in each heat. As soon as the pistol was fired, the figures were at once removed from the board, and after the timetaker had dictated to the secretary the result- of a competition and this had been submitted to the scrutiny of the leader of the competition, the figures were immediately sent to the notice-board erected at the finish, where, in addition to the number of the heat, the competing-numbers of the first three men were shown, together with the, times made. In all the finals in the running, the results were also made public by means of heralds calling out the names of the winners, and their times, in Swedish and in English.

A 3-sided notice-board was erected close to the place where the throwing-competitions were being held, but on this board there was

not given the result of every throw of a competitor, but only of the best of his 3 attempts, in addition to which, on a special little notice-board on top, there was shown the result which, for the moment, happened to be the best. When the 3 competitors that survived after the close of the preliminary competitions made their last 3 throws, the result was not placed on the notice-board but was made known by the heralds, who used megaphones for the purpose.

The same plan was employed for the broad jump, hop, step and jump, and standing broad jump, while, for the pole jump, running high jump and the standing high jump, special notice-boards were employed to show the height at which the bar stood during the various phases of the competitions.

As soon as a competition was ended, the results were scrutinized by the judges on duty, the register being signed by them and countersigned by the secretary. After this, the document was at once handed to the leader of the competition, who signed the report and then took steps to have the names and results of the first 3 men made known to the public, after which the flags of the winning nations were hoisted.

The reader is referred to the special section dealing with the Marathon race, for an account of the arrangements made to keep the public acquainted with the progress of the competitors taking part in the event in question.

A special Press-assistant was placed at the service of the members of the Press, whose office it was to attend to the communications between the Press-stand and the stand for the leaders of the competitions, at which place the official in question had a telephone, by means of which the newspaper correspondents could at once obtain all the information they desired.

On the stand for the members of the Press there were placed every morning before the competitions began, copies of the competition-lists, on which were printed the names of all the competitors, and the correspondents had afterwards only to write the results in the various columns of these lists, when they were shown on the notice-boards or announced by the heralds. Immediately after the result of a competition had been made public, the original record was copied by the press-official mentioned above, after which the copy was sent to the Press-stand, where it was put on a special notice-board. After the finals, too, all the original lists of results were available in the Secretary's Office of the Olympic Committee, in the clock-tower of the Stadium, where the Secretary was ready to answer the inquiries of correspondents regarding matters of which more detailed information was desired.

THE ATHLETE'S POCKET-BOOK WITH DETAILED REGULATIONS OF THE COMPETITONS AND P. M.

In addition to the general rules issued by the Committee during the early part of 1911 and which chiefly comprised such regulations



GROUP OF OFFICIALS IN FIELD AND TRACK ATHLETICS.

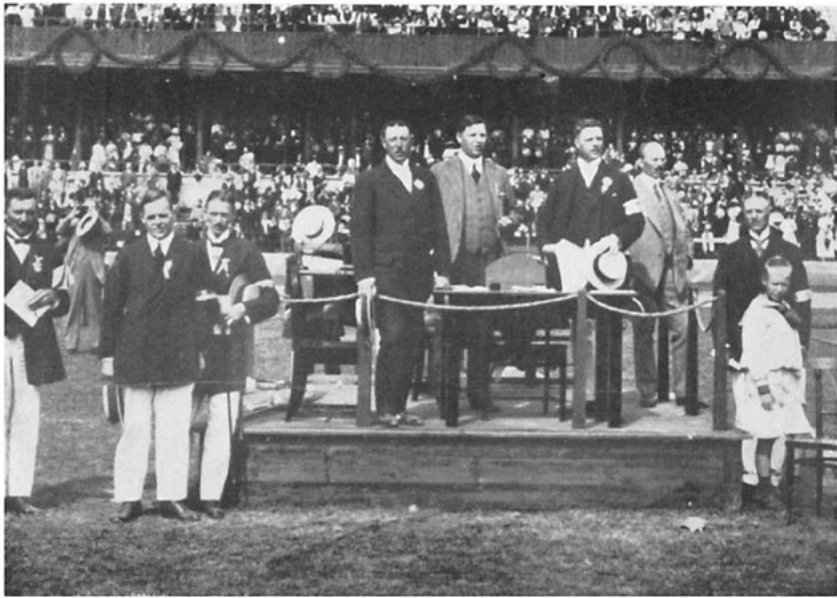

LEADERS PLATFORM.



Lieutenant G. UGGLA, Starter in Flat Racing, Olympic Games.



STAND FOR JUDGES AT FINISH.



GROUP OF TIMEKEEPERS, AND THE ELECTRIC APPARATUS FOR TIMETAKING.

as were necessary for training-work no other preliminary instructions concerning the competitions had been published. In consequence of this, the Committee issued a special P. M. for athletes, containing the detailed regulations mentioned on a former page, together with all other information respecting the carrying out of the competitions which could be of importance for the competitors to know.

This P. M. was printed as a pocket edition and was published in English, German, French and Swedish. The Swedish edition numbered only 500 copies and was bound in dark-blue imitation leather with gold edges. The English edition came to 600 copies and had brown covers; there were 600 copies of the German edition too, which had dark red brown binding, while there were only 200 copies of the French edition, which was bound in yellow. The books were distributed to the competitors in athletics on the day the Games were opened, copies being also presented to representatives of the various countries and to the members of the home and foreign Press present at the Games.

Besides the above-mentioned detailed regulations for the competitions and P. M. for the athletes, the book also contained a plan of the Stadium showing the starts and winning posts for the different races, etc. This plan and its description are shown here.

After this description of the arena, which made it possible for every athlete to find his way about inside the Stadium, came the general instructions, which were as follows:

Plan of the Arena of the Stadium.

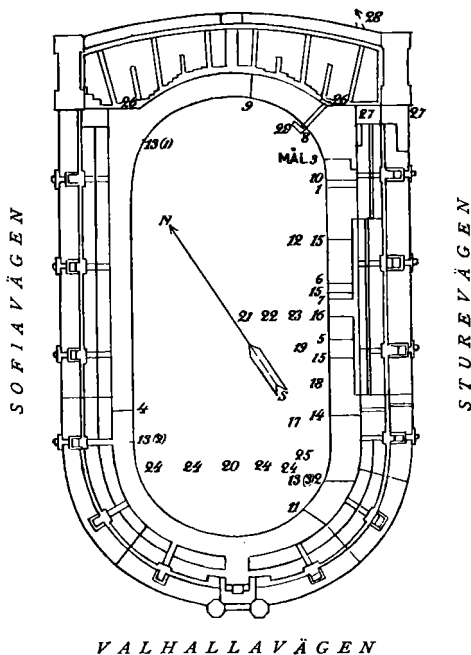

The arena measures 380,33 m. in circumference.

1. Finish for all running competitions except the 400 m. flat, 110 m. hurdles and the Marathon race.
2. Start for the 100 m. flat and the 110 m. hurdle race.
3. Finish for the 110 m. hurdle race.
4. Start for the 200 m. flat.
5. " " " 400 m. "
6. Finish for the 400 m. flat.
7. Start for the 800 m. flat (2 laps + 36.34 m.)
8. " " " 1,500 " " (3 " + 359.34 ")
9. " " " 3,000 " " (7 " + 337.69 ")
10. " " " 5,000 " " (13 " + 55.71 ")
11. " " " 10,000 " " (26 " + 111.42 ")
12. " " " relay race 400 m.
13. Passing-on stations in the relay race (400 m.)
14. Start for relay race, 1,600 m. (4 laps + 88.68 m.)
15. Passing-on stations for the relay race 1,600 m.
16. Start and finish for the Marathon race.
17. Position of the ring (hoop) for the discus throwing.
18. " " " " " hammer "
19. " " " " " putting the weight.
20. The run for the javelin throwing.
21. " " " " pole-jump.
22. " " " " hop, step and jump.
23. " " " " broad jump.
24. " " " " high " The standing high jump.
25. " place " standing broad jump.
26. Competitors' seats when viewing the games.
27. " entrance to Stadium.
28. Refreshment Rooms.
29. Tunnel.

1) The competitor is bound to follow the rules and regulations given by the Committee for Athletics, the leader of the competition or any other authorized official.

2) The competitor should make himself carefully acquainted with all the general regulations concerning the Games, and especially with such as bear upon the competition in which he himself is going to take part.

3) Each competitor will receive from his team-leader a ticket of admission to the Stadium, which will entitle him to admission between 9 a. m. and 5.30 p. m. on those days when there are competitions in athletics, either to the dressing-rooms, or to that section of the seats at the Stadium reserved for active competitors. Competitors will be admitted to the Stadium only through the door nearest the clock-tower (Sturevägen).

4) The competitor shall be in his dressing-room 30 min. before the beginning of his competition, in order that he may be ready to go at once to the starting place when the signal for the competition is given.

5) The competitor shall wear a jersey with short arms, and drawers reaching to the knees.

6) The competitor may not enter the arena by any other way than through the tunnel, and must show his ticket to the tunnel-attendant so that the latter may see that the competitor is entitled to be in the arena.

7) The competitor is not entitled to enter the arena unless he has the right number (which can be had in the dressing-room) properly attached to the dress he is going to wear in the competition.

8) The competitor must carefully keep his number, so as always to have it ready in the event of his taking part in several competitions.

9) The competitor, unless taking part in the Marathon or Cross-Country Races, shall wear his number on his back. Competitors in the races just mentioned shall have their number on the breast.

10) The competitor must leave the arena immediately after he has finished taking part in his competition(s).

11) Special places are reserved in the Stadium for those competitors who wish to see the competitions. (See plan, p. 345.)

12) 10 min. before the beginning of each competition, a signal-bell will be rung in all the dressing-rooms, in addition to which, an official will come to the rooms immediately after the bell has been rung. He will inform the competitors that the competition is about to begin, by ringing a gong and by showing a board on which is marked the number of the competition in question in the day's programme.

13) In the day's programme, each event is numbered, and the competitors can make themselves acquainted with the numbers by consulting the programmes which are posted up every morning on the notice-board in the various dressing-rooms.

14) In the throwing, jumping and running competitions for distances exceeding 1,500 met., the competitors in Group I shall present themselves at the start immediately after the first signal is given, 10 min. before the beginning of the competition. Then, 10 min. before Group II has to start, another signal will ring in the dressing-room, in addition to which, the officials will show in each room a large notice-board on which will be posted the number of the competition according to the daily programme, and the number of the heat.

15) The competitor who does not appear at the starting place, or who does not answer when the orderly (ordningsman) calls out the names of the competitors the first time, will be called upon by name a second time immediately after the first roll-call. If he is not present when his name is thus called for the second time, he loses the right to take part in the competition, if the event in which he is to compete is a race. If, on the other hand, it is a competition in throwing, the broad jump, hop, step and jump, or standing broad jump, he has the right to make his trial in ordinary numerical order in the try to which he at length presents himself, and afterwards to continue in the order which has been prescribed by the rules of the competition. For example, if a competitor makes his appearance during the progress of the second try in a broad jump, he may take part in that try, provided that he has made his presence known to the leader

of the group in such good time that he can make his jump without breaking the order in which the competitors have to jump, and then he may afterwards take part in the third try in his proper order. As regards the competitions in the running high jump, pole jump and standing high jump, the competitor who is absent when the official calls out his name the second time, shall have the right to enter the competition at the height at which the other competitors are jumping when he reports himself to the group-leader, or, if he has come too late to make this try at this height without disturbing the order in which the competitors are to jump, he can make his jump at the next greater height.

16) If, during the progress of a competition, there should arise a difference of opinion between the competitors and an official, then, after referring the matter to the chief leader of the competition, the nation-leader shall be called; these leaders ought always to be at hand in the places reserved for them.

17) A competitor may not be accompanied on the competing ground by any person who is not a competitor in the event or an official, neither may the competitor, without the permission of the judge, receive any help or refreshments from any other person.

18) As soon as a competitor retires from a competition, the proper official, the orderly (ordningsman — the same that called over the names) shall be informed of the fact at once.

19) In the event of an alteration being made in the daily programme, the competitors will be informed of the fact by a notice placed on the notice-board in the dressing-room put there for this purpose. All the nation-leaders will also be at once informed of such alteration(s).

20) The officials conducting the competitions can be distinguished by their badges, which are of the following colours:

Leader of the competition	<i>Blue and yellow (broad).</i>
Leader's Assistants.....	<i>Blue and yellow (narrow).</i>
Steward	<i>Violet.</i>
Doctors	<i>White.</i>
Interpreters	<i>White-blue.</i>
Official for jumping comps.	<i>Yellow.</i>
President of officials for do.	<i>Yellow, with long ends.</i>
Officials for throwing comps.....	<i>Blue.</i>
President of officials for do.	<i>Blue, with long ends.</i>
Leader of running comps.	<i>Red, with long ends.</i>
Judge at finish.....	<i>Red and blue.</i>
Judge of the course	<i>Red and green.</i>
Judge for walking comps.	<i>Rose.</i>
Timetaker	<i>Red and yellow.</i>
Lap-counter	<i>Red and violet.</i>
Starter	<i>Red and white.</i>
Orderly and Secretary during the running comps.	<i>Red.</i>
Officials at the result-board	<i>White and green.</i>
Press-Assistant	<i>Brown.</i>
Heralds	<i>Green.</i>
Crier of the starts	<i>Yellow and violet.</i>
Secretary for the Pentathlon and Decathlon comps.	<i>Light green.</i>

21) A protest against a decision of the judge, in questions which do not concern matters of fact, shall be placed before the president of the jury by a member of the Olympic Committee of the country concerned, who has been specially chosen for the purpose, or by another person who has been given this commission by the Committee mentioned.

For the protest to be considered it must be sent in within an hour after the giving of the judge's decision against which the protest is made.

22) Objections against the amateurship of any competitor must be made in writing, and shall be forwarded without delay to the Swedish Olympic Committee.

No such objection can be entertained unless accompanied by a deposit of Swedish Kronor, and unless it is received by the Swedish Olympic Committee before the lapse of 30 days from the distribution of the prizes.

The Swedish Olympic Committee shall decide on such objections after having obtained all necessary information, and its decision shall be final.

The deposit shall be forfeited if the objection shall appear to have been made on unreasonable grounds. If, on the other hand, the objection is upheld, or appears to have been made on reasonable grounds, the deposit will be returned.

23) The competitor, when not taking part for the moment in the event in which he is a competitor, shall sit on one of the benches which are intended for the purpose, so that the view of the public may not be impeded.

24) With the exception of poles for the pole jump, the competitor has not the right to take any kind of athletic apparatus into the arena, while only that apparatus which has been approved and marked by the Committee for Athletics, may be employed at the competitions. Should, in spite of this regulation, the competitor convey into the arena any private apparatus for the purpose of employing it in the competitions, he shall be at once excluded from further participation in the competition(s).

25) All further information desired can be had on application to the chief leader or his assistant, or by applying at the "Idrottssekretariatet" in the Stadium Clock Tower, second floor.

DESCRIPTION OF THE AUTOMATIC TIMING- AND JUDGING APPARATUS USED AT THE OLYMPIC GAMES OF STOCKHOLM 1912.

At all the races where it was possible to do so, there was employed an automatic timing apparatus invented by Mr. R. Carlstedt, C. E., which acted in the following way:

To each of the chronometers employed there was attached a little electro-magnet, the rotor of which acted on the face-contact of the watch.

All these electro-magnets were arranged in series in one circuit which also passed through the revolver used for the starts. A contact-device attached to the revolver closed the circuit at the instant the pistol was fired. By this means, the rotors of the electro-magnets were attracted, and the watches were started automatically.

The apparatus was completed by a little control-lamp attached to the revolver, and by a control-switch on the stand where the judge at the finish was stationed. When the pistol was cocked, the circuit was closed through the control-lamp and the switch cut in, but this without being able to affect the rotors of the electro-magnets. When the leader of the judging had seen that, at the finish, everything was in order for the race to begin, he cut in the switch. Then, when the pistol was cocked, the starter could see by the glowing of the lamp that everything was in order for the start.

When the pistol was fired, a perfectly reliable contact was obtained. The circuit now went through the switch and the electro-magnet, but short-circuited the control-lamp; the rotors of the electro-magnets were attracted, and the watches were started. The judge at the finish instantaneously reversed the switch, thereby retaining in his hands full control over the next race.

At the finish, there were arranged individual timing-apparatuses, each of which was provided with a contact connecting-wire corresponding with its own watch. The contact-wires belonged to separate circuits for the electro-magnets, and when the contacts were pressed the circuits were closed, and the watches stopped.

In series with the separate contact wire for the chief judge's watch, there was coupled-in a little relay, arranged on a photographic apparatus placed on the winning line.

The closing of the circuit released a pawl or ratchet connected with the shutter of the photographic apparatus, an instantaneous photograph being thus obtained of the runner at the exact moment given by the principal judge's watch. By pressing the contacts, the principal judge was consequently able to determine the exact time and obtain a corresponding instantaneous photograph of the first man, and of the second and third men, too, in the event of the result promising to be so close that such precautionary measures were needed.

In order to permit of a practical and reliable method for all the couplings-in of the revolver, etc., double wires, enclosed in protective piping, were arranged all the way round the Stadium, close to the running track, with connections for the contacts at all the starting places and at all the finishes.

The arrangement described above was employed at all the races that took place on the running-track and gave perfect satisfaction.

The photographs obtained, gave perfectly distinct pictures of the finish. In one instance, at least, the help of the photographic plate had to be called in, in order to see who were second and third in the 1,500 metres Flat. The order in which the runners passed the post can be clearly distinguished on the plate.

ARRANGEMENTS FOR THE TRAINING OF THE ATHLETES FROM ABROAD.

As previously mentioned, the Östermalm Athletic grounds had been put in order early in the spring, and when the athletes from abroad began to arrive about the beginning of June, the tracks were in the best condition, so that the training of the visitors was carried on at the ground in question. At first, the American athletes intended training at the Råsunda athletic grounds, in order to do their work in greater quiet, but the distance to the place seemed to be too far for them and they, too, determined to go to the Östermalm Grounds. These grounds were supplied with a large number of shower-baths, and there was plenty of accommodation and a sufficient number of masseurs, for those desiring to take massage. In spite of the fact that the Östermalm athletic grounds are very large, they were almost crowded during the first week of July, when athletes from all parts of the world were gathered in Stockholm.

For the competitors in the Marathon race the Committee had placed persons at their disposal who took the representatives of the various nations over the course in motor-cars, and the competitors from abroad accompanied our own men several times when they were training on the roads that were to be the scene of the Olympic Marathon Race.

THE COMPETITIONS.

Scarcely had the last tones of the trumpets that proclaimed the solemn opening of the Olympic Games of 1912 rung out over the gaily decorated, sunshine-flooded streets of Stockholm, and the Swedish gymnasts ended their display, than the line-cars rolled down the running track, paying out metre after metre of white hemp rope to mark the lanes for the trial heats of the 100 metres flat race. The competitors gathered round the starter, drew lots for the lanes, and, in a minute or two, everything was ready for the first start. The pistol was fired and — the Olympic Stadium Competitions had begun.

Running.

100 METRES FLAT.

First Round.

Saturday, 6 July.

First heat. C. LUTHER, Sweden, walk-over. Time $12\frac{4}{6}$ secs.

Second heat. 1. I. MÖLLER, Sweden; 2. P. SZALAI, Hungary; Time: $11\frac{5}{10}$ secs. Not placed: F. Rauch, Austria. — After a good start there was a hard tussle between the Swede and the Hungarian from the 70 metres' mark. Möller was stronger in the finish, however, and won by something more than half a metre.

Third heat. 1. J. I. COURTNEY, U. S. A.; 2. I. JANKOVITCH, Hungary. Time: $11\frac{1}{6}$ secs. Not placed: H. E. H. Blakeney, Great Britain; P. Failliot, France; L. Jiranek, Bohemia; P. Eithel, Chili. — Although Jankovitch is reckoned as one of Hungary's best sprinters, the American, to all appearance, won without being extended. Jankovitch was a very easy second, thus qualifying for the second round.

Fourth heat. 1. R. G. RICE, Great Britain; 2. R. SMEDMARK, Sweden. Time: $11\frac{2}{6}$ secs. Only these two started. Both ran the course very quietly, the British representative breaking the tape easily ahead of his rival.

Fifth heat. 1. V. H. A. D'ARCY, Great Britain; 2. R. POVEY, South Africa. Time: $11\frac{1}{5}$ secs. Also ran: A. Stomp, Portugal. — A hard struggle for first place between the leaders; d'Arcy was the better man, but it was not before the last few metres of the finish that he could shake off the South African, winning by a metre.

Sixth heat. 1. R. RAU, Germany; 2. V. RACZ, Hungary. Time: 11 $\frac{5}{10}$ secs. Also ran : T. Persson, Sweden; R. Schurrer, France; D. Triantaphillacos, Greece ; L. Löwenstein, Russia. Rau was the quickest away, and he safely kept to the end the start he had gained after the first 25 metres of the race.

Seventh heat. 1. W. A. S STEWART, Australasia; 2. J: AELTER, Belgium. Time: 11 secs. Not placed : C. L. Lelong, France ; J. Grijseels, J:nr, Holland ; H. Schwarz, Russia. — Stewart ran with great coolness and elegance and, at the tape, was well in front of the Belgian, who also ran very well. The time, which was the best hitherto made in the trial heats, showed that the pace was a hot one.

Eighth heat. 1. K. LINDBERG, Sweden; 2. B. VYGODA, Bohemia. Time: 11 $\frac{3}{5}$ secs. Also ran: D. Miloschevitch, Servia; J. Haldorsson, Iceland. — The old Swedish champion beat the Bohemian, Vygodá, easily.

Ninth heat. 1. A. MEYER, U. S. A.; 2. F. GIONGO, Italy. Time: 11 $\frac{3}{10}$ secs. Not placed: R. C. Duncan, Great Britain ; G. J. B. Rolot, France. — Meyer had an easy task in this heat, which he won without any apparent effort. The Italian representative ran well, although he was not the same class as the American.

Tenth heat. 1. D. H. JACOBS, Great Britain; 2. C. P. WILSON, U. S. A. Time: 10 $\frac{4}{5}$ secs. Also ran: M. F. L. Delaby, France; H. Sotaaen, Norway, V. Labik, Bohemia. — This was the first real struggle in the trial heats. The start was a fine one, and Jacobs and Wilson ran abreast of each other almost till the tape was reached. There, however, the Englishman's breast crept just in front of Wilson's, and Jacobs broke the tape a hand's-breadth in front of his rival.

Eleventh heat. 1. F. V. BELOTE, U. S. A.; 2. R. MOURLON, France. Time: 11 secs. Not placed : H. M. Macintosh, Great Britain ; H. B. Beasley, Canada. — Unexpectedly enough, the real struggle took place between Belote and Mourlon, Macintosh having to be contented with third place. The heat was run evenly, the pace being a sharp one. Belote broke the tape a safe winner, after a very quick finish.

Twelfth heat. 1. P. C. GERHARDT, U. S. A.; 2. F. L. LUKEMAN, Canada. Time: 11 $\frac{1}{10}$ sec. Also ran: F. Weinzinger, Austria: A. Pedersen, Norway. — Gerhardt was clearly the best man, although Weinzinger led at the 25 meters' mark, after having got a good start. The American then went ahead, followed by Lukeman, who was satisfied with getting second place, and so qualifying for the semi-final.

Thirteenth heat. 1. J. A. HOWARD, Canada; 2. G. H. PATCHING, South Africa, Time : 11 secs. Not placed: H. W. Heiland, U. S. A.; P. de Stieglitz, Russia ; E. Ketterer, Germany. — A very sharp heat. After a false start by Patching, the field got away well together. There was a hard struggle between Howard, Patching and Heiland. Patching led at 85 metres, but, in the last 10 metres, Howard came on with a fine spurt and broke the tape first, Patching being the least bit behind the winner.

Fourteenth heat. 1. A. E. D. ANDERSON, Great Britain; 2. R. B. THOMAS, U. S. A. Time: 11 secs. Also ran : F. D. Mc Connel, Canada; S. Jacobsson, Sweden. — Mc Connel soon went ahead, after a good, level start. The Canadian, however, was too weak in the final 'spurt, when he was passed, first by Anderson and then, just before reaching the post, by Thomas.

Fifteenth heat. 1. H. P. DREW, U. S. A.; 2. E. KERN, Germany. Time: 11 secs. Not placed: J. Boullery, France, and J. Barker, Great Britain. — After a false start, the runners got away well together. Drew soon began to lead,

making the pace a very quick one, and the little American won easily, with Kern, the second man a pretty good distance behind.

Sixteenth heat. 1. D. F. LIPPINCOTT, U. S. A.; 2. W. R. APPLGARTH, Great Britain. Time : $10\frac{3}{5}$ secs. (Olympic record). Also ran : Herrmann, Germany; E. Szerelemhegyi, Hungary; Y. Mishima, Japan. — The quickest heat in the trials. There were two false starts before the field succeeded in getting away without being called back by the starter's whistle. Lippincott led from start to finish, and gave the impression that he would be an easy winner, but Applegarth came on very quickly in the last 20 metres, and Lippincott had to do his very best in order to keep the lead. In this he succeeded, however, and his time — $10\frac{3}{5}$ secs. — is a new Olympic record.

Seventeenth heat. 1. R. C. CRAIG, U. S. A.; 2. F. SZOBOTA, Hungary. Time: $11\frac{1}{5}$ secs. Not placed : O. R. Ekberg, Sweden; F. Fleischer, Austria. — The Swede was the quickest off, but after having kept the lead for the first 50 metres, he began to be hard pressed by Craig and Szobota, who both passed him at the 60 metres mark. Towards the finish, Craig left the Hungarian and won easily.

The trial heats in the first round were now concluded, and of the 33 runners who had qualified for the second round, the U. S. A. were represented by 9 men, Great Britain by 5, Sweden and Hungary by 4 each, Germany, Canada and South Africa by 2 each, and Australasia, Belgium, Bohemia, France and Italy by 1 each.

Second Round.

Saturday, 6 July.

The second round was run in 6 heats, only the winner in each heat being qualified for the final. After an interval of a few hours, the first heat in the semi-final was run about 4 p. m. As was to be expected, the pace set in these heats was considerably faster than that in the trials, and the U. S. A. runners had now a better opportunity of showing their superiority. There were many false starts, in consequence of the nervousness of the competitors, but there was no unfair start on any occasion when the field was at length sent off.

First heat. 1. P. DREW, U. S. A. Time : 11 secs. Also ran: Courtney and Gerhardt, U. S. A.; Luther, Sweden; Kern, Germany and Racz, Hungary. — All the field got away very well, with the exception of Luther who was left a metre behind and so was quite out of the running. Drew ran magnificently, Courtney being his most dangerous competitor. After a powerful, concentrated finish, Drew passed the tape a safe winner.

Second heat. 1. G. H. PATCHING, South Africa. Time: $10\frac{9}{10}$ secs. Not placed: K. Lindberg, Sweden ; R. Rice, Great Britain ; F. Giongo, Italy, and J. Aelter, Belgium. — Patching once more crossed the scratch too soon and was called back; at the second attempt, however, the runners got away together. Lindberg was considerably behind at the start and at the 50 metres mark, he had Patching, Rice and Giongo in front of him. In the finish, however, the Swede made a hard spurt, but he was too late to be able to dispute Patching's victory.

Third heat. 1. A. MEYER, U. S. A. Time: $10\frac{1}{10}$ secs. Also ran: Jacobs, Great Britain ; Lukeman, Canada; Szalai, Hungary; Smedmark, Sweden. — Smedmark was the first away but he apparently thought that he had made a false start and stopped, the other men then passing him and so he was out of the race.

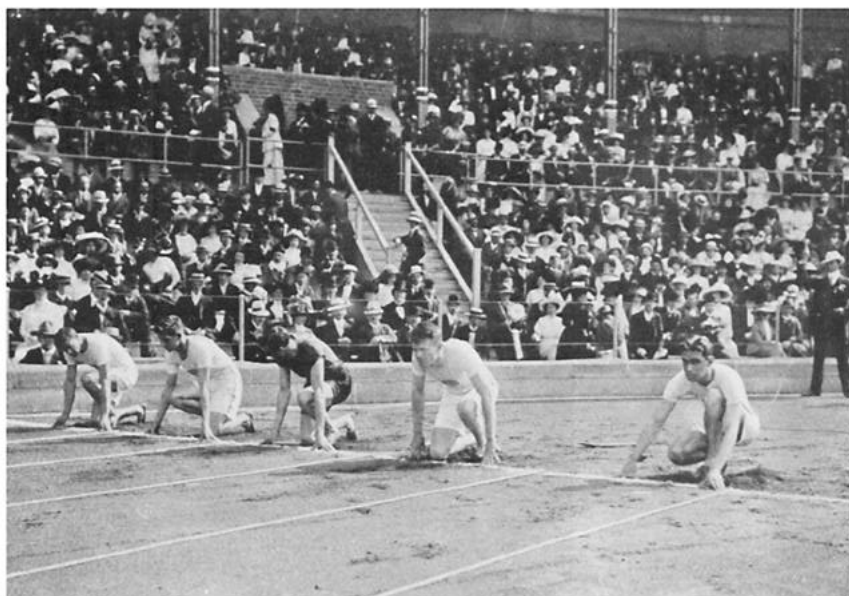

100 M. FLAT, FINAL. The Start.

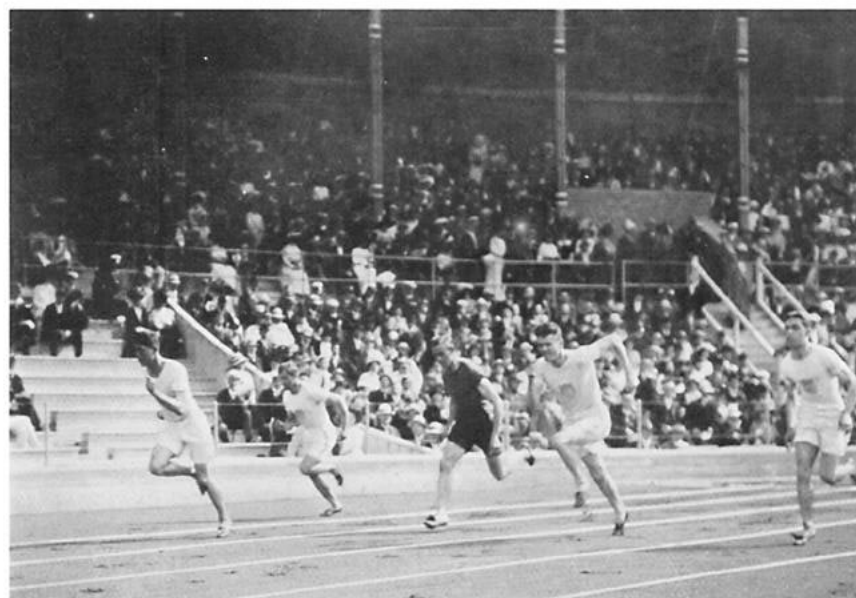

100 M. FLAT, FINAL. Immediately after the Start.



100 M. FLAT, FINAL. The Finish.



START FOR 200 M. FLAT.

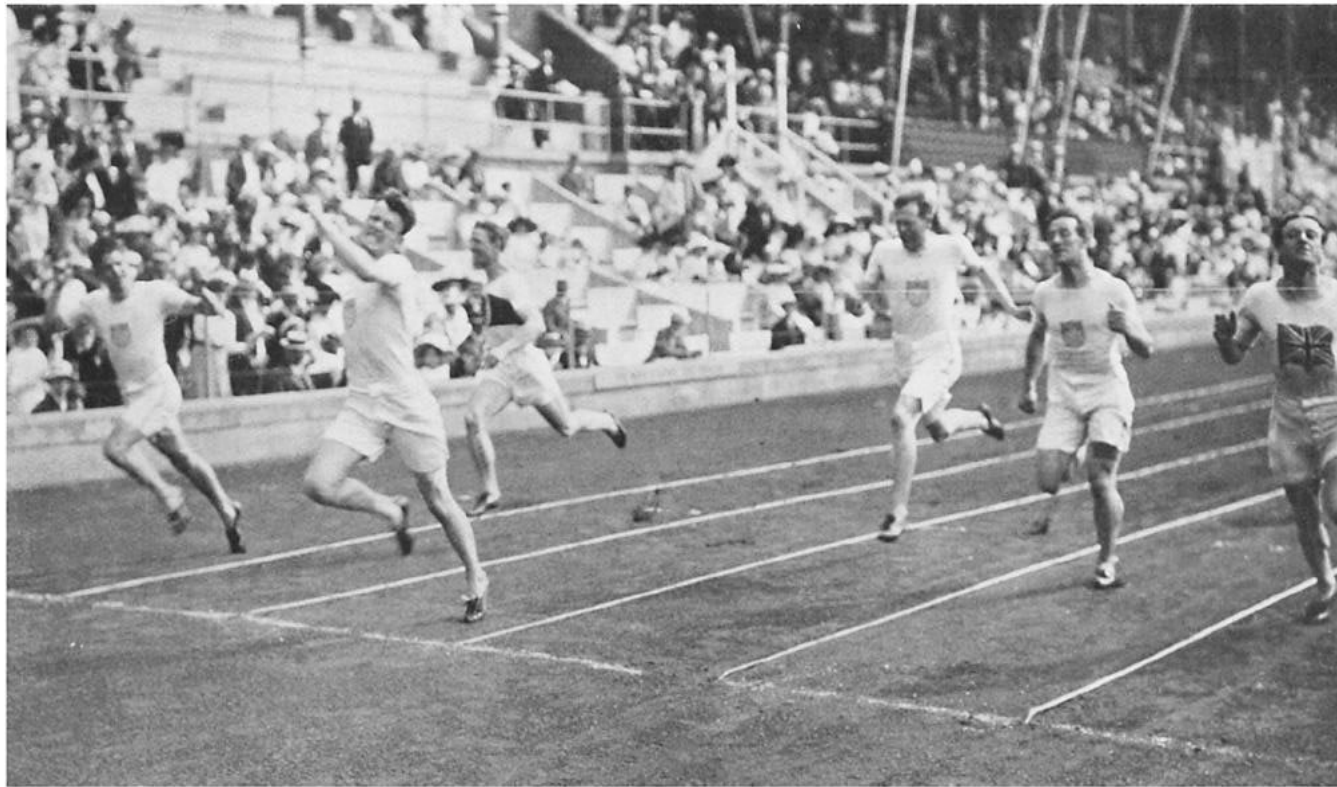

200 M. FLAT, FINAL. The Finish.

There was a hard struggle between Meyer and Jacobs, but the American was the strongest in the last 10 metres and he won the heat after a well-judged race.

Fourth heat. 1. R. CRAIG, U. S. A. Time: $10\frac{7}{10}$ secs. Also ran: Rau, Germany; Jankovitch, Hungary; Stewart, Australasia; Mourlon, France, and Szobota, Hungary.— In this heat, 6 first-class runners had met, and the struggle for victory was exceedingly hard. There were no less than 9 false starts before the competitors could restrain themselves until the pistol was fired. Craig then set a tremendous pace and at the 70 metres mark had caught up Rau, who had gained a metre or so by his good start. From the 70 metres mark, Craig's victory was practically assured and he finished magnificently. By Rau's defeat every hope was lost of continental Europe having any man in the final. Craig won by more than a metre.

Fifth heat. 1. D. F. LIPPINCOTT, U. S. A. Time: $10\frac{7}{10}$ secs. Not placed: Wilson, U. S. A.; Applegarth, Great Britain; d'Arcy, Great Britain; Howard, Canada and Vygoda, Bohemia. — This heat, too, was a very hot one, and there was a sharp struggle for the lead during the whole of the race. Applegarth threatened Lippincott on this occasion too, and Wilson was another hard nut to crack for the new record-breaker. Lippincott gained his heat however, thus getting into the final.

Sixth heat. 1. F. V. BELOTE, U. S. A. Time: $11\frac{1}{10}$ secs. Also ran: Povey, South Africa; Thomas, U. S. A.; Möller, Sweden, and Anderson, Great Britain. — The American took the lead, which he kept to the post, Povey being a good number two.

5 Americans and 1 South African were thus left in for the final, Europe not being represented.

Final.

Sunday, 7 July.

- | | | |
|-------------------------|----------|------------------------|
| 1. R. C. CRAIG | U. S. A. | $10\frac{4}{5}$ secs. |
| 2. A. MEYER | U. S. A. | 60 cms. behind winner. |
| 3. D. F. LIPPINCOTT ... | U. S. A. | 15 » » second man. |

Also ran:

- | | |
|----------------------|--------------|
| G. H. Patching | South Africa |
| F. V. Belote | U. S. A. |

Drew did not start.

The 5 runners took their places at the line amid the greatest excitement. Drew did not start, having strained a sinew in one of his legs in the second round. The competitors were excessively nervous, and broke away again and again when only the word "Ready" was called.

Finally, when the field had placed itself in starting position for the eighth time, the starter managed to get them fully in hand, and when the pistol was fired they rose like one man. It was an absolutely fair start. Patching managed to press to the front after the first 10

metres and at the 40 metres' mark he led by a clear half metre, with Craig, Lippincott and Meyer behind him, Belote being a short distance in the rear of the group of Americans. After 50 metres Craig had quite found his stride, however, and caught up the South African at the 60 metres' mark. When three-quarters of the distance had been covered, Craig was a hand's-breadth in front of Patching, who had Meyer as good as alongside of him, while Lippincott and Belote still had another half metre to gain before they could get level with Patching. Then came the finish! Craig ran brilliantly and with enormous power, leaving his rivals behind him, Meyer being the nearest of these. Craig broke the tape 60 centimetres in front of Meyer. Until the last few strides Patching was still number three, but almost on the very line Lippincott came up with a rush and beat him by a hand's-breadth, Lippincott himself being 15 centimetres behind Meyer. Belote was fifth.

200 METRES FLAT.

First Round.

Wednesday, 10 July.

First heat. 1. C. D. REIDPATH, U. S. A., $22\frac{3}{5}$ secs.; 2. G. J. B. ROLOT, France, $22\frac{7}{10}$ secs. Also ran: K. Stenborg, Sweden, and V. Labik, Bohemia. — Reidpath at once got a short lead which he kept to the end, although Rolot ran energetically and well. Stenborg made a good show in the finish, but too late to get a place in the semi-final.

Second heat. 1. R. C. CRAIG, U. S. A., $22\frac{4}{5}$ secs.; 2. R. C. RICE, Great Britain, 23 secs. Not placed: C. A. C. Poulenard, France; K. Lindblom, Sweden. — Craig won pretty much as he liked, in spite of having such a good man as Rice in the heat.

Third heat. 1. J. I. COURTNEY, U. S. A., $22\frac{7}{10}$ secs.; 2. D. MACMILLAN, Great Britain. Also ran: J. Aelter, Belgium; H. Baumann and H. Hahne, Russia. — Courtney beat Macmillan, who seemed to have recovered from a strain which he had got while training a few days before the Games began.

Fourth heat. 1. C. LUTHER, Sweden, $23\frac{3}{5}$ secs.; 2. J. GRIJSELS J:NR, Holland. — Only these two started and the Swede won as he liked.

Fifth heat. 1. W. R. APPLGARTH, Great Britain, $24\frac{7}{10}$ secs.; 2. A. W. HEILAND, U. S. A. — There were only two starters in this heat, too, and they did the distance almost at a walking pace, as both, of course, would get into the semi-final.

Sixth heat. 1. R. RAU, Germany, $22\frac{5}{10}$ secs.; 2. A. E. ANDERSON, Great Britain. Also ran: R. Rauch, Austria. — Rau ran finely and, after a hard race beat Anderson in a good time.

Seventh heat. 1. C. C. COOKE, U. S. A., $22\frac{1}{5}$ secs.; 2. R. POVEY, South Africa. Also ran: H. B. Beasley, Canada; C. O. Malfait, France, and J. A. Wells, Great Britain. — Cooke beat the South African, after a hard struggle during the first part of the distance. The winner's time was the best in the trial heats.

Eighth heat. 1. J. HOWARD, Canada, 25 secs.; 2. F. GIONGO, Italy. — Only these two started, and the Canadian won the heat at almost a walking pace.

Ninth heat. 1. K. LINDBERG, Sweden, $23\frac{1}{10}$ secs.; 2. F. MEZEI, Hungary. Also ran: C. L. Lelong, France. — Lindberg was not at all extended in winning this heat, in spite of the fact that he did not start well.

Tenth heat. 1. P. C. GERHARDT, U. S. A., $22\frac{9}{10}$ secs.; 2. V. H. A. D'ARCY, Great Britain, $22\frac{9}{10}$ secs. Also ran: G. Möller, Sweden. — The pace in this heat was a pretty good one, and both the American and the Englishman ran a very hard finish, which resulted in Gerhardt breaking the tape first, although no distinction in time could be made between first and second man.

Eleventh heat. 1. D. F. LIPPINCOTT, U. S. A., $22\frac{4}{5}$ secs.; 2. I. MÖLLER, Sweden. Not placed: P. Failliot, France; E. Haley, Great Britain, and P. Eitel, Chili. — Lippincott and Möller kept very close together the whole of the way, although the American, apparently, could easily have made better time.

Twelfth heat. 1. A. I. MEYER, U. S. A., $24\frac{1}{10}$ secs.; 2. R. C. DUNCAN, Great Britain. — This was another heat in which only two men started, the pace, in consequence, being a very quiet one.

Thirteenth heat. 1. D. B. YOUNG, U. S. A., $22\frac{4}{6}$ secs.; 2. C. N. SEEDHOUSE, Great Britain. Also ran: F. Fleischer, Austria, and Y. Mishima, Japan. — Young and Seedhouse confined their attention entirely to each other, and the Englishman did not try to prevent the American taking first place. The Japanese was fourth, a considerable distance in the rear.

Fourteenth heat. 1. C. H. PATCHING, South Africa, $22\frac{8}{10}$ secs.; 2. C. P. WILSON, U. S. A. Not placed: F. D. MC Connell, Canada; F. T. Browne, Great Britain; E. Grandell, Sweden. — A hard struggle between Patching and Wilson. The South African ran grandly, and beat the American in the finish.

Fifteenth heat. 1. M. HERRMANN, Germany, $22\frac{9}{10}$ secs. 2. I. DÉVAN, Hungary. Also ran: H. Sotaen, Norway, and L. E. Palmas, Chili. — The German won after an energetic race, with Déván a good second.

Sixteenth heat. 1. W. A. STEWART, Australasia, 26 secs.; 2. H. M. MACINTOSH, Great Britain. — These two, who were the only men in the heat, walked the distance rather than ran it, and passed the winning-post simultaneously.

Seventeenth heat. 1. D. H. JACOBS, Great Britain, $23\frac{1}{6}$ secs.; 2. S. JACOBS-SON, Sweden. — In this heat, too, there were only two men, and under these circumstances both ran somewhat quietly, although for the latter part of the distance the pace was fairly good.

Eighteenth heat. 1. T. PERSSON, Sweden, $23\frac{1}{5}$ secs.; 2. R. SCHURRER, France. Also ran: A. Stromp, Portugal. — The Swede won after a nice race, but without being too seriously threatened by the Frenchman.

Second Round.

Wednesday, 10 July.

First heat. 1. R. C. CRAIG, U. S. A., $21\frac{9}{10}$ secs. Also ran: Jacobs, Great Britain; Courtney, U. S. A.; Persson, Sweden; Mezei, Hungary; Anderson, Great Britain. — It was now that Craig first showed his real mettle. A rapid start and a hard pace for the whole of the distance was too much for the other competitors, of whom only Jacobs could come anywhere near the leader, although, compared with the American, he was not on the track.

Second heat. 1. W. R. APPLGARTH, Great Britain, $21\frac{9}{10}$ secs. Not placed: Wilson, U. S. A.; Stewart, Australasia; Seedhouse, Great Britain; Heiland, U. S. A.,

and Jacobsson, Sweden. — A hard struggle from start to finish. This was especially the case with the first two men, who fought out a desperate finish side by side. In the last few metres, however, the Englishman was the better man and won the heat.

Third heat. 1. D. B. YOUNG, U. S. A., $21\frac{9}{10}$ secs. Also ran: Cooke, U. S. A.; Rolot, France, and M. Herrmann, Germany. — This heat resolved itself into a peaceful civil strife between the two representatives of the United States. In the finish, however, Young had more pace, and was a safe winner, with his countryman second and the Frenchman third.

Fourth heat. 1. D. F. LIPPINCOTT, U. S. A., $21\frac{4}{5}$ secs. Not placed: Meyer, U. S. A.; Howard, Canada; Möller, Sweden; Macmillan, Great Britain, and Grijseels, Holland. — The two U. S. A. men, with Howard and Möller, at first lay well together, but on coming into the straight, Lippincott increased the pace, closely pressed by Meyer, while Howard fell behind. After a good finish, Lippincott won in the best time noted during the day.

Fifth heat. 1. R. RAU, Germany, $22\frac{1}{10}$ sec. Not placed: Gerhardt, U. S. A.; Luther, Sweden; Rice, Great Britain; Povey, South Africa and Giongo, Italy. — This was one of the nicest heats of the day. Rau and Gerhardt got away very finely, while Luther was a little bit late in starting. He had made up lost ground, however, after passing the 100 met. mark, and at 120 met. the three runners mentioned lay almost abreast of each other, Rau being the least bit in front. Towards the close, Rau increased the pace and managed to break the tape an inch or so in front of Gerhardt who, in his turn, was only a very short distance in advance of Luther.

Sixth heat. 1. C. D. REIDPATH, U. S. A., $22\frac{1}{10}$ sec. Also ran: d'Arcy, Great Britain; Lindberg, Sweden; Duncan, Great Britain and Schurrer, France. — Reidpath at once took the lead, the next men being d'Arcy and Lindberg, the other competitors falling to the rear after the first 50 met. The three kept very well together until 25 metres from the post, when the American began a spurt that put him ahead. There was little to choose between d'Arcy and Lindberg at the end of the race.

Final.

Thursday, 11 July.

1. R. C: CRAIG U. S. A. $21\frac{7}{10}$ sec
2. D. F. LIPPINCOTT U. S. A. $21\frac{8}{10}$ sec.
3. W. R. APPLGARTH Great Britain.

Also ran:

- R. Rau Germany.
 C. D. Reidpath..... U. S. A.
 D. B. Young »

Rau, the German representative, had the last lane but one towards the outside of the track, and was thus very badly placed. Craig had the middle lane, while the fourth lane, counting from the inside of the track, was Lippincott's.

The start was a very pretty one, with the Americans a hair's-breadth in front of Rau, perhaps, the latter not getting his first step with

the speed one is accustomed to in the case of this sprinter. On coming out of the curve, Applegarth had won a few decimeters, but the Americans, with Craig at their head, then came abreast of the Englishman and after running 20 metres along the straight, Craig had taken the lead with Lippincott a decimeter or so behind him. Craig was a safe winner 40 met. from the finish, and he broke the tape as No 1, although for the last few meters he was hard pressed by Lippincott. The struggle between Applegarth and Rau for third place was a hot one at the close, but the last-named had not strength left to finish fast enough, and the English representative succeeded in beating the German for third place on the very post. As in the 100 metres, Craig's running was magnificent, his victory being the result of extraordinarily fine technics combined with good judgment during the whole race.

400 METRES FLAT.

First Round.

Friday, 12 July.

First heat. 1. J. M. ROSENBERGER, U. S. A., $50\frac{3}{16}$ sec.; 2. C. A. C. POULENARD, France, $50\frac{7}{10}$ sec. Not placed: W. Ponurski, Austria; C. M. Ross, Australasia. — As soon as the pistol was fired, Rosenberger at once took the lead and at the first curve was already ahead. He kept his place for the whole of the race, although he was pretty closely pressed towards the finish by the French representative, who was a good second. It was evident, however, that Rosenberger was not doing all he could.

Second heat. 1. E. W. HALEY, Great Britain, $66\frac{3}{8}$ sec.; 2. M. W. SHEPARD, U. S. A. — Only the two men mentioned started, and so the heat was rather a walk than a race. The Englishman passed the winning post first. Practically speaking, the heat was a walk-over.

Third heat. 1. H. BRAUN, Germany, $50\frac{3}{8}$ sec.; 2. J. E. MEREDITH, U. S. A. Also ran: A. Z. Cortesao, Portugal. — There was a special interest in this third heat, the German representative, Braun, and Meredith, the American runner, meeting here in a short distance event. Meredith took the lead, putting on a pretty good pace, but slowing down a little towards the end, however. In the straight, Braun went forward and beat the American by a metre; Meredith, however, was clearly satisfied with being certain of a place in the semi-final.

Fourth heat. 1. P. G. ZERLING, Sweden, $55\frac{3}{8}$ sec. 2. Y. MISHIMA, Japan. — The Japanese led at the beginning, with the Swedish representative close behind him, but after half the course had been run, the latter went ahead and won the heat as he liked, the energetic Japanese having to be satisfied with second place.

Fifth heat. 1. C. L. LELONG, France, $50\frac{1}{8}$ sec.; 2. D. B. YOUNG, U. S. A., $50\frac{2}{8}$ sec. Also ran: I. Dévan, Hungary, and G. Möller, Sweden. — The speedy Frenchman; Lelong, led the whole of the way, with the American as second man. Young, who ran with an uncommonly long stride, was clearly keeping the position he did on purpose, and made no effort to pass his rival, a feat that he could most certainly have performed very easily.

Sixth heat. 1. K. STENBORG, Sweden; walk over, $61\frac{3}{5}$ sec. — Stenborg was the only man in the heat.

Seventh heat. 1. C. B. HAFF, U. S. A., $50\frac{3}{5}$ sec., 2. E. LUNGHI, Italy, $50\frac{3}{10}$. Not placed: M. Herrmann, Germany. — This heat gave rise to a sharp struggle between Haff and Lunghi. Haff took the lead after leaving the first curve and kept his place, although, towards the finish, he was hotly pressed by the Italian.

Eighth heat. 1. F. MEZEI, Hungary, $50\frac{4}{5}$ sec. 2. J. DAHLIN, Sweden, 51 sec. Not placed: G. Malfait, France. — Malfait led in the first curve but, in the straight, Dahlin went ahead and put on a pretty sharp pace. It looked as if the Swede was going to win, but the Hungarian came up in the last few metres and beat him by one fifth of a second.

Ninth heat. 1. E. LINDHOLM, Sweden, $51\frac{2}{5}$ sec.; 2. J. PEDERSEN, Norway, $51\frac{3}{5}$ sec. Also ran: H. Burkowitz, Germany and V. Labik, Bohemia. — Lindholm, who lay last for the first 100 met., went forward in the straight and passed his competitors in the last curve. He had plenty of strength left for the finish, and won the heat as he liked, with the Norwegian second.

Tenth heat. 1. F. J. LINDBERG, U. S. A., $50\frac{3}{5}$ sec.; 2. J. T. SOUTTER, Great Britain. Not placed: Giongo, Italy. — Lindberg at once began to make the pace with the evident intention of getting a good place in the first curve. He was hard pressed by Soutter the whole of the way, however, but the American was the stronger in the finish and won, although narrowly.

Eleventh heat. 1. C. S. EDMUNDSON, U. S. A. $50\frac{1}{5}$ sec.; 2. E. J. HENLEY, Great Britain. Not placed: G. M. Brock, Canada and P. Gajeffsky, Russia. — In this heat, too, it was an American that first passed the winning post, although both Henley and Brock made Edmundson do his utmost. The last few metres, however, decided the race in favour of the latter runner.

Twelfth heat. 1. G. NICOL, Great Britain, 50 sec.; 2. I. N. DAVENPORT, U. S. A. Not placed: T. H. Gallon, Canada; E. Lehman, Germany; G. J. B. Rolot, France and Ö. Bodor, Hungary. — A safe win had been expected for Davenport, but it became clear that the American intended merely to qualify for the semi-final and he let Nicol lead without a struggle. The Englishman ran prettily, showing good form.

Thirteenth heat. 1. J. PERSON, Germany, $55\frac{2}{5}$ sec.; 2. J. A. WELLS, Great Britain. — Only the two above-mentioned runners started in this heat, and as the Englishman ran only at a slow trot, the German had no difficulty in coming in first.

Fourteenth heat. 1. G. M. SEEDHOUSE, Great Britain, $51\frac{9}{10}$ sec.; 2. K. SZEREMHEGYI, Hungary. Not placed: A. Pedersen, Norway (disqualified). — In this heat Seedhouse made the pace, well supported by Pedersen from Norway. The latter, however, fouled one of the other runners during the course of the race, and so was disqualified, although he passed the post an easy second after the Englishman.

Fifteenth heat. 1. G. H. PATCHING, South Africa, $51\frac{1}{10}$ sec.; 2. C. D. REIDPATH, U. S. A., $51\frac{1}{5}$ sec. Also ran: H. Wenseler, Germany; A. Patterson, Great Britain and R. Schurrer, France. — Reidpath made the pace for three quarters of the course, closely followed by the South African. On leaving the last curve, the latter pressed past his opponent but, although Reidpath could most certainly have beaten him, the American let his rival keep the lead, satisfying himself with coming in second and so qualifying for the intermediate heat.

Second Round.

Friday 12 July.

First heat. C. D. REIDPATH, U. S. A., $48\frac{7}{10}$ sec. Also ran: C. S. Edmundson, U. S. A.; G. Nicol, Great Britain; F. Mezei, Hungary, and C. A. C. Poulenard, France. — Reidpath, who went at a terrific pace, took the lead of his four rivals immediately the pistol was fired, but there was a struggle for first place at the first curve, this being necessary in order to have a chance in the finish. To begin with, Poulenard retained his position as second man, but he was soon passed by Nicol. Reidpath kept his rivals at a proper distance, however, and won the heat in excellent time.

Second heat. I. F. LINDBERG, U. S. A., $48\frac{9}{10}$ sec. Not placed: E. Lindholm, Sweden, $50\frac{1}{5}$ sec.; C. L. Lelong, France; G. M. Seedhouse, Great Britain. The last three did not finish. — As was expected, it was an American that won this heat, too, Lindberg passing the post as first man after a beautiful run, without being threatened by any of the other competitors. Lindholm was a good second during the whole of the race, and although he could not dispute the victory with the American, he ran finely, however, making the good time — for Swedish records — of $50\frac{1}{5}$ sec., the best hitherto reached by a Swedish runner.

Third heat. I. J. E. MEREDITH, U. S. A., $48\frac{1}{8}$ sec. Also ran: M. W. Sheppard, U. S. A.; C. H. Patching, South Africa; K. Stenborg, Sweden; A. Pedersen, Norway, and E. J. Henley, Great Britain, who did not finish. — This was the most hotly disputed of all the heats, Meredith, Sheppard and Stenborg being the best of the group. Sheppard led for the first part of the race but, on leaving the last curve, Meredith came on with a hard spurt, and though his fellow-countryman and the Swede tried desperately to keep abreast of the muscular American, all their efforts were unsuccessful.

Fourth heat. I. C. B. HAFF, U. S. A., $49\frac{7}{10}$ sec. Not placed: E. Lunghi, Italy; E. Szerlemhegyi, Hungary; E. W. Haley, Great Britain; J. M. Rosenberger, U. S. A. The last two did not finish. — Haff at once put on a tremendous pace, with the result that, on leaving the last curve, the rest of the field were quite pumped out, even Lunghi being obliged to leave the American in the middle of this bend. Haff won without any difficulty.

Fifth heat. I. H. BRAUN, Germany, $49\frac{1}{6}$ sec. Also ran: I. N. Davenport, U. S. A.; J. T. Soutter, Great Britain; P. Zerling, Sweden; D. B. Young, U. S. A. (disqualified). — At the sound of the pistol, the five competitors threw themselves forward, each of them striving his utmost to get the lead before entering the first curve. The consequence was, that the field was badly crowded together just before the curve began. Young who was in front 10 met. before the curve, grew irritated on seeing Braun coming up very rapidly on his right and threw himself out to the right. In this manner Braun got Young's arm in his left side, with the result that the German was bored a long way out on to the outside path, thus losing his placing. The judges of the course who were stationed at the curve, at once signalled to the leader of the competition, and the matter was decided while the runners were still in the first curve, Young being disqualified in accordance with the regulations. In spite of a signal to that effect, however, all the competitors, Young included, ran on to a finish, the American keeping the lead, although, during the last part of the course, Braun came on more and more, but without being able to catch his rival, who passed the win-

ning-post as first man. In consequence of the report which was immediately made by the judges of the course, Young was disqualified, Braun thus being awarded the victory in this heat.

Final.

Saturday, 13 July.

- | | | |
|----------------------------|----------|-----------------------|
| 1. C. D. REIDPATH | U. S. A. | $48\frac{1}{5}$ sec. |
| (Olympic record). | | |
| 2. H. BRAUN | Germany | $48\frac{3}{10}$ sec. |
| 3. E. F. J. LINDBERG | U. S. A. | $48\frac{2}{5}$ sec. |

Also ran:

- | | | |
|----------------------|----------|-----------------------|
| J. E. Meredith | U. S. A. | $49\frac{1}{5}$ sec. |
| C. B. Haff | | $49\frac{5}{10}$ sec. |

After three false starts, the field at last got away, with Braun in the second lane, counting from the inside, and Reidpath in the third. In order to prevent collisions, special lanes had been marked out for each runner and, in consequence, the competitors did not stand in a straight line at the start, the event thereby possibly losing in interest. It was the only method, however, of avoiding mishaps, as the competitors had only a very short distance in which to obtain a place before the first curve was reached. Meredith made the pace a very warm one from the start, and in the first straight he had a decided lead, he here being abreast of Braun, although, on account of the different scratch-lines made necessary by the shape of the track, he had been some metres behind him at the beginning of the race. When half the distance had been run, however, Braun increased the pace and soon took the lead. In the middle of the last curve the German was clearly ahead, but at this point Reidpath began his hard spurt and, in the last 15 metres, managed to press past Braun, who had not sufficient strength left to hold out in this grand finish. Lindberg, who had the ill-luck to get the outside lane, ran magnificently the whole of the way, but could not prevent Braun passing the post half a metre in front of him for second place. Meredith had evidently run himself out at the beginning, and was nowhere in the finish. He passed the post about 5 metres behind Lindberg.

800 METRES FLAT.

First Round.

Saturday 6 July.

There were 9 heats in the first round of the 800 metres Flat, the first two men in each heat being qualified for the semi-final. In general, the trials did not occasion any hard struggles, and so the times were not at all remarkable. It was noticeable, however, in more than one heat, that many of the runners could have done far

better times if it had been at all necessary. The U. S. A. runners showed their superiority at this distance too, winning 5 of the 9 heats.

First heat. 1. D. CALDWELL, U. S. A.; 2. E. LUNGHI, Italy. Also ran: Lindholm, Sweden; MC Clure, U. S. A.; Cauille, France. Time: $1.58\frac{2}{5}$ ($804\frac{1}{2}$ met. half-mile: 1.59). — When the pistol was fired, Lindholm at once went forward and led to the end of the first curve, where Lunghi came on and made the pace, The Italian did not seem to be in his accustomed good form, however. Cauille and MC Clure now increased their pace, and then Lunghi fell behind. In the last curve but one, Caldwell came on with a spurt which carried him to the front, where he took the lead, accompanied in the final spurt by Lungi, who, finally, had to be satisfied with second place, being about 7 metres behind the winner.

Second heat. 1. P. E. MANN, Great Britain; 2. H. N. PUTNAM, U. S. A. Not placed: Pedersen, Norway and Palma, Chili. Time 1.56 sec. ($804\frac{1}{2}$ met. half-mile $1.56\frac{3}{5}$ sec.) — The Englishman at once took the lead, which he retained to the finish, running the distance entirely alone. Putnam kept the second place but, at the close, was strongly pressed by Pedersen who ran exceedingly well. Mann had the best time in the trial heats, but he need not have run so hard to win.

Third heat. 1. J. P. JONES, U. S. A.; 2. A. Z. CORTESAO, Portugal. Also ran: Larsen, Norway; Savniki, Hungary and Calvi, Italy. Time $2.01\frac{4}{5}$. — The Portuguese led for the first lap, which was taken at a very moderate pace. It was not before leaving the last curve that Jones began to lengthen his stride and leave Cortesao behind him. The latter succeeded in coming in as No. 2.

Fourth heat. 1. C. S. EDMUNDSON, U. S. A.; 2. J. L. TAIT, Canada. Not placed: Poulenard, France; Jahn, Germany; Burton, Great Britain (did not finish). Time: $1.56\frac{1}{10}$ (half-mile; $1.57\frac{1}{5}$) — Edmundson at once took the lead, which he did not lose at any time during the race, although Poulenard made several vain attempts to pass the U. S. A. runner, who won easily; the Canadian representative, Tait, who also ran without exerting himself much, passing the post as No 2.

Fifth heat. 1. I. N. DAVENPORT, U. S. A.; 2. F. H. HULFORD, Great Britain. Not placed: Bodor, Hungary; Person, Germany; Nazarov, Russia; Mestecy, Bohemia; and Baker, Great Britain. Time: 1.59 (half-mile: $1.59\frac{3}{5}$). — Davenport had the lead for the first 100 metres, being relieved after that distance by Baker. The pace now became pretty warm, but it slackened a little after little more than a lap had been run. 300 metres from the finish Baker had enough, and Davenport once more went forward and won easily, with Hulford second. Bodor never came up, remaining unplaced.

Sixth heat. 1. H.W. HOLDEN, U. S. A.; 2. E. BJÖRN, Sweden. Not placed: Yorke, Great Britain; Forgács, Hungary; Müller, Chili; Haglund, Sweden; Elizarof, Russia. Time: $1.58\frac{1}{10}$ (half-mile: $1.59\frac{1}{10}$). — Forgács went to the front and made the pace for the first lap. When the bell rang, Holden and Björn went forward simultaneously and a hard struggle ensued, the American getting the lead, with Björn as the nearest man behind him. In the final straight, Björn came up abreast of Holden who then spurred again. Björn did not follow suit, as the second man was of course qualified to start in the semi-final, and there was no one to dispute his title to second place. In this way the American won by $2\frac{1}{2}$ met.

Seventh heat. 1. J. T. SOUTTER, Great Britain; 2. M. W. SHEPPARD, U. S. A. Also ran: Lehmann, Germany; Antal, Hungary (did not finish) and Wilhelm

sohn, Russia (did not finish). Time: $2.0\frac{2}{5}$ sec. — Antal, the Hungarian representative, set the pace at the beginning, with Sheppard and Soutter close at his heels. On leaving the last curve, the American saw that it was time to go forward, he being followed in this manoeuvre by Soutter and Lehmann, Antal giving up the race, just as Wilhelmsohn had done some time before. Soutter ran hard at the finish and Sheppard let him win, merely assuring himself of second place in front of Lehmann.

Eighth heat. 1. G. M. BROCK, Canada; 2. J. E. MEREDITH, U. S. A. Not placed: Victor, South Africa; Patterson, Great Britain (did not finish). Time 1.57 (half-mile: $1.57\frac{3}{5}$). — At first the pace was rather slow; then the South African put on the pace for a time, but afterwards fell behind, the final struggle lying between Brock and Meredith. It was a hard tussle, both being dangerous men in the last 100 metres but Brock was the first past the post.

Ninth heat. E. J. HENLEY, Great Britain; 2. H. BRAUN, Germany. Also ran: Frisell, Sweden; Halpin, U. S. A.; Radoczy, Hungary and Pihkala, Finland; (the two latter did not finish). Time: $1.57\frac{8}{5}$. — The lead was taken by Halpin and Frisell, with Braun as third man. When one lap was left, Henley came on, ran outside Braun, and passed Halpin and Frisell. At the beginning of the last curve, Braun began his spurt, and passed Henley, who till then had been leading. In the finish, however, the Englishman once more passed the German representative, who contented himself with second place. There was a hard struggle between Halpin and Frisell for third place, the result being a dead heat in $1.59\frac{1}{5}$.

18 runners had thus qualified for the semi-final. Of this number, 8 were U. S. A. men, 4 Englishmen, 2 Canadians, 1 German, 1 Italian, 1 Portuguese and 1 Swede.

Second Round.

Sunday, 7 July.

First heat. 1. J. MEREDITH, U. S. A., $1.54\frac{2}{5}$; 2. H. BRAUN, Germany, $1.54\frac{3}{5}$; 3. M. W. SHEPPARD, U. S. A., $1.54\frac{4}{5}$; 4. H. N. PUTNAM, U. S. A., 1.55 . Also ran: Tait, Canada, Mann, Great Britain, Hulford, Great Britain (did not finish). — Meredith at once put on the pace without any hesitation, and the first lap was run in very quick time. Then Sheppard went forward with long strides outside of Braun, and at the beginning of the final curve, Meredith and Sheppard occupied the two foremost places, with the German runner playing a waiting game as third man. In the final straight, Meredith still kept the lead, while the struggle between Sheppard and Braun became one of extraordinary severity. 75 metres from the finish Braun began his usual speedy spurt, but Sheppard was ready for it and responded gamely. The American fell behind in the last few metres, however, and made no attempt to rob Braun of second honours. Putnam was a good fourth.

Second heat. 1. G. M. BROCK, Canada, $1.55\frac{7}{10}$; 2. C. S. EDMUNDSON, U. S. A., $1.55\frac{4}{5}$; 3. D. CALDWELL, U. S. A., $1.55\frac{9}{10}$; 4. I. N. DAVENPORT, U. S. A., $1.55\frac{9}{10}$. Not placed: Lunghi, Italy, Holden, U. S. A., Henley, Great Britain, Björn, Sweden and Cortesao, Portugal. — Davenport, the 400-metres sprinter, made the pace for a little while after the start, but was relegated to second place by his countryman Edmundson, who afterwards kept up the pace in front with

tremendous energy. The other runners fell in behind the gigantic American, the field keeping very well together. In the last curve Brock was shut in but got clear very cleverly, and came on in the finish with a magnificent final spurt which carried him over the line as first man, although he was very seriously threatened by the three nearest U. S. A. men, who passed the post almost in a straight line.

The result of the semi-finals left 6 U. S. A. men, 1 German and 1 Canadian for the final race.

Final.

Monday, 8 July.

1. J. E. MEREDITH,..... U. S. A. $1.51\frac{9}{10}$.
(Olympic record).
2. M. W. SHEPPARD... U. S. A. 1.52 .
3. I. N. DAVENPORT,.. U. S. A. 1.52 .

Also ran:

- | | | |
|-----------------------|----------|----------------------|
| H. Braun | Germany | $1.52\frac{1}{5}$. |
| D. Caldwell | U. S. A. | $1.52\frac{3}{10}$. |
| C. S. Edmundson | » | |
| G. M. Brock | Canada. | |
| H. N. Putnam,..... | U. S. A. | |

A finer field of 800 met. sprinters had never been brought together than the one that now waited for the starter's signal. Everybody was convinced that a new record would be made, but that the race would be as sensational as it turned out to be, came altogether as a surprise. As soon as the pistol was fired, Sheppard at once threw himself forward, and led at an unheard of pace, with Meredith and Braun as his nearest men. Sheppard's time for the first 400 met. was $52\frac{2}{5}$ sec., he then still keeping the lead. When the bell rang, Sheppard was still leading, with Meredith close behind him. Behind Meredith came Braun, who had Davenport on his right hand and Edmundson behind him. Behind this group came Caldwell, Brock and the rest of the field. The German was thus pretty well locked in. At the entrance to the last curve, Braun made a desperate attempt to get free by running outside Davenport, but the American was too speedy for him. On leaving the last curve, Sheppard still lay first, but now Meredith came with his spurt which brought him nearer and nearer to the leader. For a moment it looked very possible that Braun would get to the front, but he did not succeed, probably mostly on account of the pace given to the finish by the phenomenal final spurt made by Sheppard and Meredith. Davenport came on, too, in the last five metres, and then Braun was run out. He lost his stride, and was within a hair's breadth of being beaten by Caldwell on the very post. Meredith won the race by half a meter from Sheppard, who was only a hand's breadth before Davenport. Meredith's time for the half mile ($804\frac{1}{2}$ met.) was $1.52\frac{1}{5}$.

1,500 METRES FLAT.

First Round.

Tuesday, 9 July.

First heat. 1. M. W. SHEPPARD, U. S. A., $4.27\frac{3}{5}$; 2. L. C. MADEIRA, U. S. A., $4.27\frac{8}{10}$. Not placed: Hare, Great Britain, $4.39\frac{2}{5}$. — Hare led at an easy trot, and the Americans let him keep his position until the last lap, when they both went ahead at a rapid pace, while Hare soon relaxed his efforts. Sheppard won a very easy heat.

Second heat. 1. N. S. TABER, U. S. A., $4.25\frac{5}{10}$; 2. P. J. BAKER, Great Britain, 4.26. Not placed: Amberger, Germany, 4.27; Savniki, Hungary; Wihtol, Russia; Nazaroff, Russia. The last 3 men did not finish. — In this heat, too, the pace was very easy for the first 3 laps, the final round being taken with a spurt. Taber led at the finish and Baker did not take the trouble to press him, being satisfied with second place, as this qualified him for the final.

Third heat. 1. A. R. KIVIAT, U. S. A., $4.04\frac{2}{5}$; 2. H. A. ARNAUD, France, $4.05\frac{2}{5}$. Not placed: Patterson, U. S. A., $4.05\frac{1}{10}$; Tait, Canada; Forgács, Hungary; Delloye, Belgium; Pederson, Norway; Owen, Great Britain, did not finish. There was a large field for this heat, and Owen was knocked down in the first lap, which made him lose some 30 met. Kiviat led for the greater part of the race and won the heat quite easily. There was a hard struggle between Arnaud and Patterson for second place, but the Frenchman was the quicker, and won with a little bit to spare.

Fourth heat. 1. A. N. S. JACKSON, Great Britain, $4.10\frac{4}{5}$; 2. J. P. JONES, U. S. A., $4.12\frac{2}{5}$. Not placed: Victor, South Africa $4.12\frac{7}{10}$; Anderson, U. S. A.; Larsen, Norway; Indrikson, Russia and Rucks, Russia. — Jones led, running in beautiful and elegant style, with Jackson close at his heels. In the last curve the Englishman went in front with colossal strides, Jones not making any serious effort to dispute the victory of the leader, being satisfied with passing Victor, in order not to be out of the final.

Fifth heat. 1. J. ZANDER, Sweden, $4.05\frac{5}{10}$; 2. E. BJÖRN, Sweden, $4.07\frac{1}{5}$. Not placed: Putnam, U. S. A., $4.07\frac{8}{5}$; Yorke, Great Britain; Mickler, Germany; Elizarof and Charkof, Russia; Ruffell, Great Britain. — With Yorke leading, the two first laps were taken at a fairly good pace, Björn and Zander biding their time in the middle of the field. When the bell rang for the last lap, Zander went forward and increased the pace. Entering the last curve, Zander lay first, with Putnam and Björn as his nearest men; coming into the straight, Zander began his spurt, and Björn, too, passed the American, who had no strength left for the final rush, but had to be contented with the third place. Zander won very nicely and came in a easy first without any very great exertion.

Sixth heat. 1. E. VON SIEGEL, Germany, $4.09\frac{3}{10}$; 2. F. HEDLUND, U. S. A., $4.10\frac{4}{5}$. Also ran: Moore, Great Britain; Frykberg, Sweden; Kruklin, Russia; Hulford, Great Britain; Calvi, Italy, did not finish. — Frykberg took the lead, running at a very moderate pace, the field keeping well together until the bell rang, when Siegel and Hedlund came up abreast of the Swede. The last lap was taken at great speed, the spurt lasting for more than half the distance. Siegel was the quicker and beat Hedlund, while Moore and Frykberg had a hard struggle for third place.

Seventh heat. 1. E. WIDE, Sweden, 4.06; 2. W. MCCLURE, U. S. A., 4.07³/₁₀. Also ran: Cottrill, Great Britain; Harju, Finland; Petroff, Russia; Papazian, Turkey, did not finish. — Cottrill resolutely took the lead, and kept up a good pace during the first two laps, his tactics being followed only by Wide and McClure. Wide ran the whole time very diplomatically, and after the bell rang for the last lap it looked, in the straight, as if McClure and Cottrill were going to leave Wide behind them. Just before the last curve, however, the Swede began a spurt which none of the other runners could follow, and he won as he liked.

There were, thus, 14 men qualified for the final, 7 of them representing the U. S. A., 3 Sweden, 2 Great Britain, 1 Germany and 1 France.

Final.

Wednesday, 10 July.

1. A. N. S. JACKSON,	Great Britain	3.56 ⁴ / ₅ .
(Olympic record.)		
2. A. R. KIVIAT	U. S. A.	3.56 ⁹ / ₁₀ .
3. N. S. TABER	U. S. A.	3.56 ⁹ / ₁₀ .

Not placed:

P. Jones	U. S. A.	3.57 ¹ / ₅ .
E. Wide	Sweden	3.57 ³ / ₅ .

Also started:

M. W. Sheppard	U. S. A.
H. A. Arnaud	France.
F. Hedlund.....	U. S. A.
W. McClure.....	»
L. C. Madeira	»
P. J. Baker.....	Great Britain.
E. Björn	Sweden.
J. Zander.....	»
E. von Siegel.....	Germany.

Arnaud (France) led for the two first laps, the field keeping well together. The U. S. A. runners played a waiting game in the middle of the group, while the Swedish representatives kept stubbornly in the rear. During the second lap, however, Wide went forward to seventh place. When the bell rang for the last lap, Kiviat pressed forward and took the lead, with Taber and Jones following close behind. In this way Arnaud was squeezed out, while von Siegel had already fallen to the rear. At this instant, which was decisive of the race, Wide had taken up his position apparently without the least judgment, being quite 15 met. behind the leader, Kiviat. On coming out of the last curve but one, Wide began his spurt, while, in the last straight but one, Jackson came up into the group of leaders, to which the Swede, too, was getting closer. In the last curve, Kiviat, Taber, Jackson, Jones and Sheppard came along in

a bunch, Wide being somewhat in the rear of this group but running with an enormous stride and, apparently, with sufficient strength left to be able to make a hard finish. The finish along the final straight was one of extraordinary severity, each man doing all he knew. Jones, Taber and Kiviat ran abreast of each other in a hard spurt, with Jackson some distance behind them, and Wide about 10 met. in the rear of Kiviat. The last-mentioned runner drew away from Taber and Jones in the last 30 metres and seemed certain of success, when, all of a sudden, Jackson came on, passed the pumped-out U. S. A. men with gigantic strides and broke the worsted 3 metres in front of Kiviat, who suffered a complete surprise. Wide ran magnificently in the spurt but, although he was then the quickest man, he had let the leading group get too much in front to be able to catch his opponents. There was so little between Kiviat and Taber that the judges would not permit the result to be published before the photograph taken of the finish had been developed, the plate showing that Kiviat was a shade in front of his countryman. There were 3 metres between Kiviat and Wide.

5,000 METRES FLAT.

First Round.

Tuesday, 9 July.

First heat. 1. G. BONHAG, U. S. A., **15.22³/₅**; 2. A. DECOTEAU, Canada, **15.24¹/₅**; 3. F. N. HIBBINS, Great Britain **15.27²/₅**. Also ran: G. Hill, Australasia, **15.56⁴/₅**; K. Lundström, Sweden (did not finish). — Bonhag led the field, with Hibbins as second man, and Lundström third. After three laps had been covered, Lundström went up to Bonhag, Hill dropping more and more behind, and the four other runners being in a bunch. After a few more laps had been run, Hill increased the pace, made a long spurt from the very tail of the field, and took the lead for a time but was soon sent down by Bonhag to a less prominent position. Towards the close, Bonhag made the space still warmer, and won the heat without being at all pressed. Lundström did not finish the last lap.

Second heat. 1. H. L. SCOTT, U. S. A., **15.23⁵/₁₀**; 2. J. KEEPER, Canada, **15.28⁹/₁₀**; 3. G. W. HUTSON, Great Britain. **15.29**. Also ran: B. Modig, Sweden, **16.07¹/₁₀**. M. Persson, Sweden, C. H. Ruffell, Great Britain, and E. J. Fitzgerald, U. S. A., did not finish. — The first lap was run with Ruffell in front, the representatives of the star-spangled banner, in a group, leading the rest of a field, until, after a few laps, Modig caused a surprise by going ahead and increasing the pace, but he soon fell back and dropped more and more to the rear. In the fifth lap Persson left the track, after having been last man since the start. When half the distance was completed, Fitzgerald was leading, followed by Scott and Hutson. One lap and a half from the finish Fitzgerald and Ruffell had had enough and retired, while, during the last lap, Scott made his victory over Keeper and Hutson quite safe.

Third heat. 1. M. KARLSSON, Sweden, **15.34³/₅**; 2. E. GLOVER, Great Britain, **16.09¹/₁₀**; 3. C. H. A. PORTER, Great Britain, **16.23²/₅**. Also ran: M. Ni-

colsky, Russia, $17.2 \frac{1}{10}$; G. M. Wikoff, U. S. A., and A. Lindholm, Finland, did not finish. — Glover and Porter ran in company for the first few laps, with Karlsson 15 metres behind. An attempt by Karlsson to take the lead during the course of the second lap was prevented by Glover. After another lap had been run, Karlsson came on with a fresh spurt, the result of this being that the two Englishmen and the Swede ran together, with Wikoff 25 metres behind, while the rest of the field fell more and more to the rear. Towards the finish, Wikoff fell lame, and left the track, while Karlsson went ahead of the Englishmen and, increasing in speed as he ran, won by half a lap.

Fourth heat. 1. H. KOLEHMAINEN, Finland, $15.38 \frac{8}{10}$; 2. H. NORDSTRÖM, Sweden, $15.49 \frac{1}{10}$; 3. T. S. BERNA, U. S. A., $15.53 \frac{8}{10}$. Also ran: G. Lee, Great Britain, and G. Vietz, Germany, neither of whom finished. — The fourth heat was begun at noon, and everybody was very eager to see Kolehmainen run, although one could understand that in a trial heat it would not be necessary for him to do all he could. Vietz took the lead for the first few laps, but after the fourth lap Kolehmainen went ahead and afterwards ran the race practically without any rivals, winning with ease. There was a hard struggle between Nordström and Berna in the last lap, but the Swede was the speedier man, and was considerably ahead of the American at the finish.

Fifth heat. 1. J. BOUIN, France, 15.05; 2. T. OHLSSON; Sweden, $15.25 \frac{1}{5}$; 3. F. W. JOHANSSON, Finland, $15.31 \frac{9}{5}$. Also ran: A. L. Treble, Great Britain; A. Sanchez, Chili; G. Heuet, France; A. Orlando, Italy; W. M. McCurdy, U. S. A., none of whom finished. — Bouin had, to all appearances, made up his mind to run the distance entirely "on his own", for he immediately left the rest of the field behind him, running at a lively pace which he kept up for the rest of the race, and won in the best time for the day. The struggle between Ohlsson, McCurdy and Johansson, on the other hand, was a very severe one, but the Swede was clearly the best man. In the final spurt Ohlsson left his rivals without difficulty, but Johansson and McCurdy had another desperate fight in the finish which ended in a victory for Johansson, McCurdy falling 50 metres from the winning-post.

Final.

Wednesday, 10 July.

- | | |
|-------------------------------------|----------------------|
| 1. HANNES KOLEHMAINEN ... Finland | $14.36 \frac{3}{5}$ |
| (Olympic record.) | |
| 2. J. BOUIN France | $14.36 \frac{7}{10}$ |
| 3. G. W. HUTSON Great Britain | $15.7 \frac{3}{5}$ |

Not placed:

- | | |
|-------------------|---------|
| G. W. Bonhag..... | U. S. A |
| T. S. Berna | » |
| K. Karlsson | Sweden |

Also started:

- | | |
|----------------------|---------------|
| H. L. Scott | U. S. A. |
| A. Decoteau..... | Canada |
| J. Keeper | » |
| F. N. Hibbins..... | Great Britain |
| C. H. A. Porter..... | » |

Kolehmainen, true to his custom, went ahead without a thought, Bonhag and Bouin lying behind him. After a couple of laps, however, Bonhag went ahead, passing Kolehmainen and carrying Scott and Hutson with him, the latter of whom strove energetically to keep the third place in the field. Kolehmainen was not very long contented to remain so badly placed, however, but with a long, rapid spurt he once more took the lead, Bouin being close behind him. These two men gradually left the rest of the field far in the rear, and the event soon resolved itself into a duel between the Finlander and the Frenchman. Suddenly the pace became quite terrific, Bouin leading. The other competitors began a struggle for third place, Bonhag and Karlsson leading alternately in this group. Bonhag very soon settled down as the leader of this part of the field, Karlsson being relegated to fourth place. In front, Bouin was running ahead of Kolehmainen at a most extraordinary speed, and it soon became clear that there would be a finish between these two men, the like of which had never before been seen. When the bell rang for the last lap, Bouin began his spurt, but Kolehmainen lay as close behind him as if he was the Frenchman's very shadow. In the last straight but one, the Finlander tried to get in front, in order to be assured of the lead in the last curve, but Bouin responded immediately, and the final curve was run at a still greater pace. After leaving the bend, Kolehmainen once more attacked, but found it was still too early to do so. When only 20 metres were left, the Finlander pressed up abreast of Bouin who now, possibly involuntarily in consequence of the unheard-of strain of the race, pressed Kolehmainen out to the right-hand side of the track while, at the same time, he did his very utmost to hold his own against his rival. But Kolehmainen, with stubborn energy, gained decimetre after decimetre, and, just on the very winning-post, flung himself before Bouin and, in this manner, won the most interesting, the severest and the finest long-distance race that has probably ever been witnessed. Of the remainder of the field, Hutson, towards the end, had taken a decided lead, followed by Bonhag, Berna and Karlsson in the order given, which remained unaltered to the finish.

10,000 METRES FLAT.

First Round.

Sunday, 7 July.

First heat. 1. H. KOLEHMAINEN, Finland, **33.49**; 2. J. KEEPER, Canada, **33.58⁴/₅**; 3. G. HEUET, France, **34.50**; 4. J. EKE, Sweden, **34.55⁴/₅**; 5. J. GLOVER, Great Britain, **35.12¹/₅**. Not placed: A. Öberg, Sweden, **35.45**; G. Lee, Great Britain; C. H. Ruffell, Great Britain; V. Penc, Bohemia; W. J. Kramer, U. S. A.; M. Nicolsky, Russia; H. H. Hellowell, U. S. A. (The six runners last named did not finish.) — The first heat in the 10,000 metres flat was started at 9 on Sunday morning, 12 runners awaiting the discharge of the starter's pistol.



400 M. FLAT. HEAT 4.
PAUL ZERLING (Sweden) beating MISHIMA (Japan).

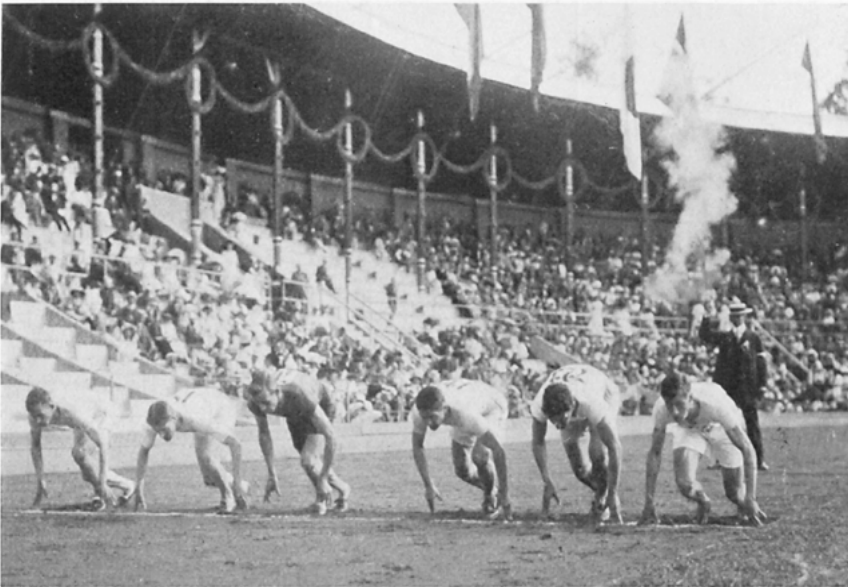

START FOR 400 M. FLAT. SEMI-FINAL.

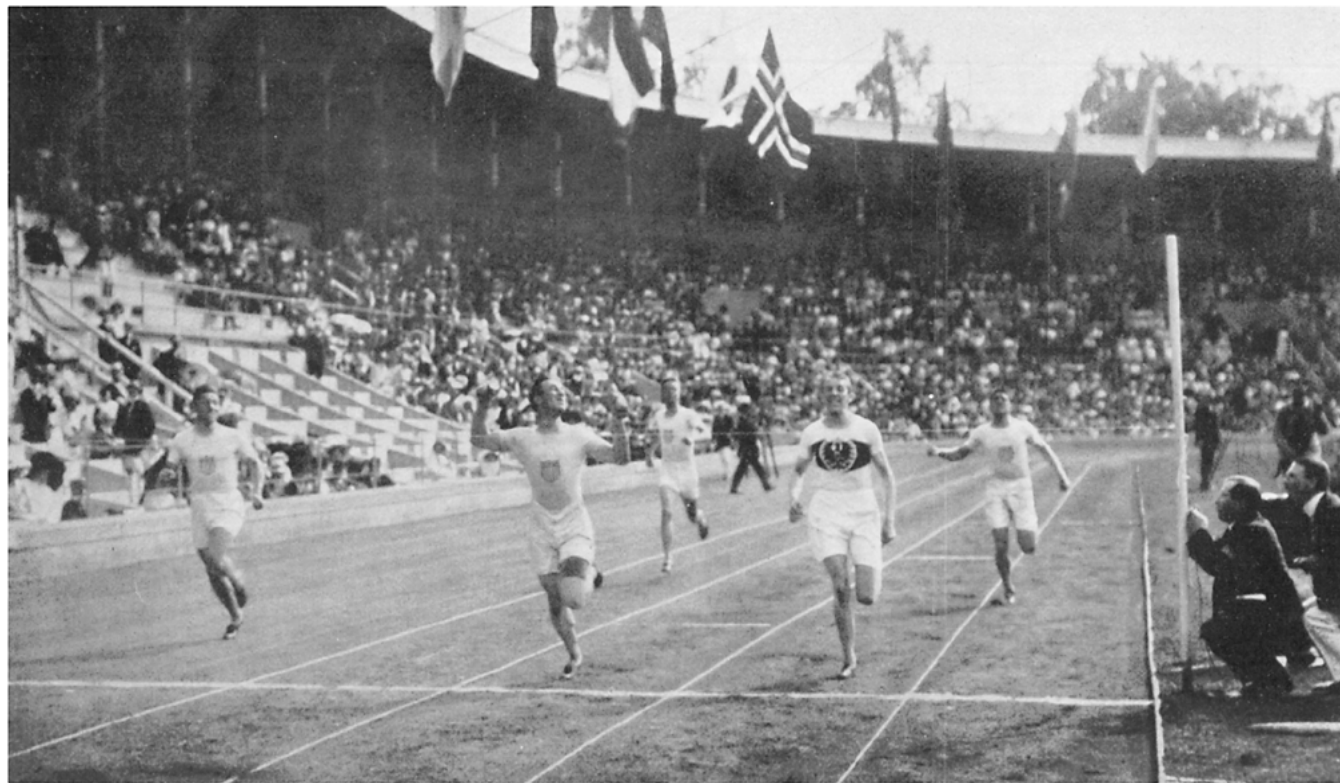

400 M. FLAT, FINAL. The Finish.

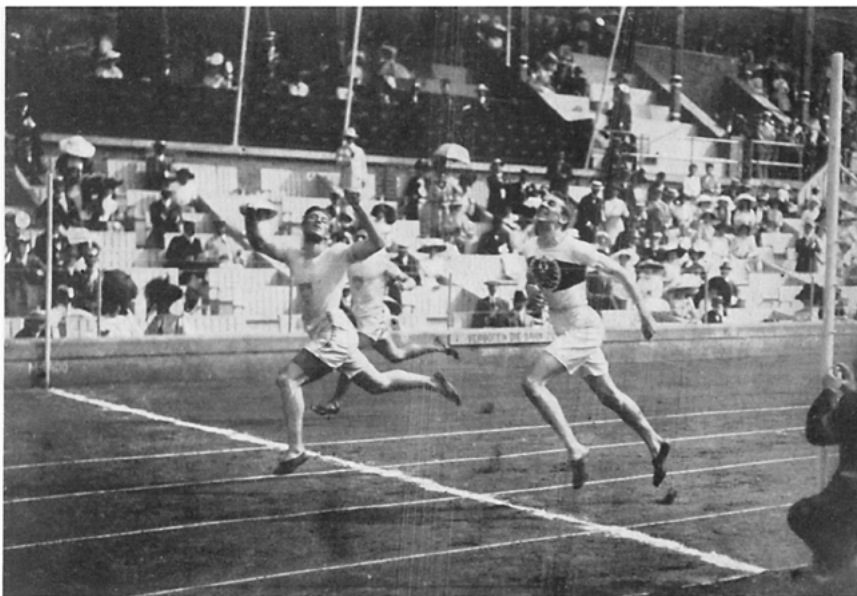

400 M. FLAT, FINAL. The Finish.

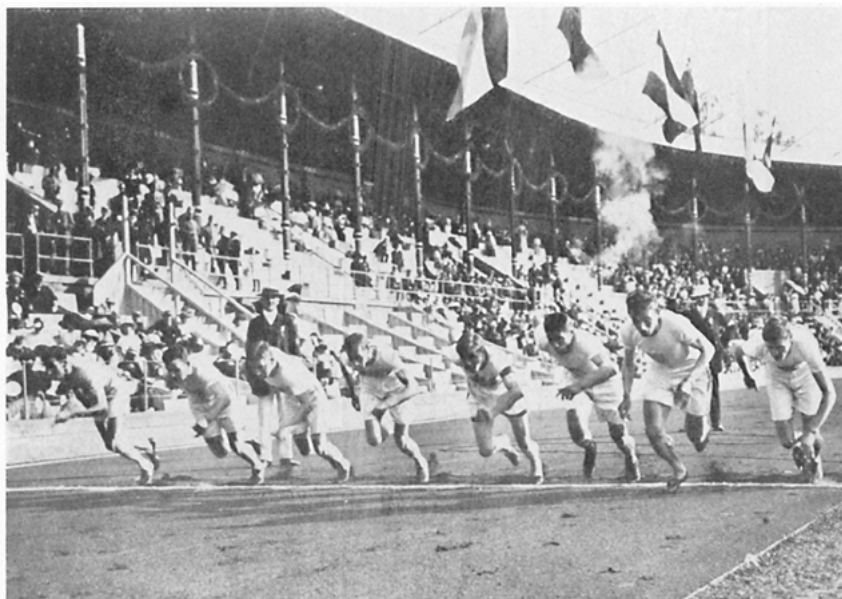

800 M. FLAT, FINAL. The Start.

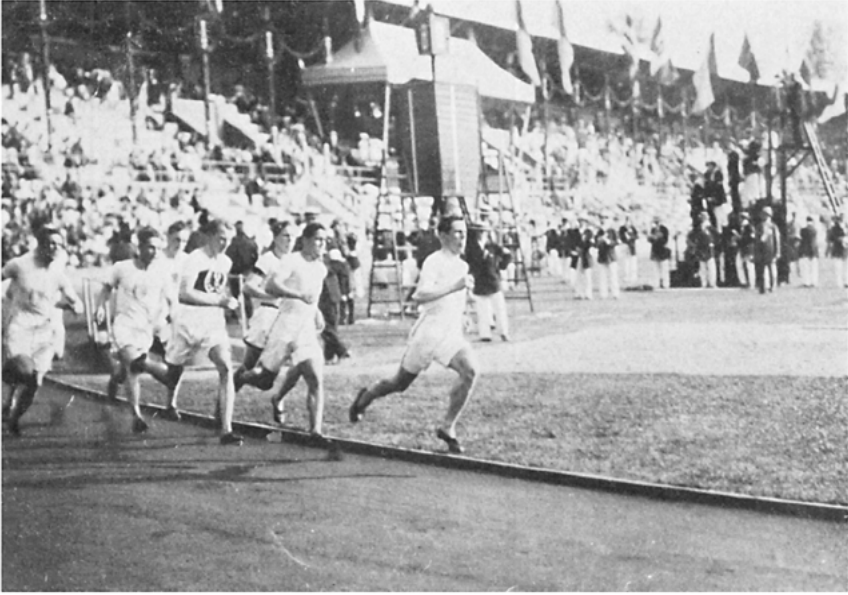

800 M. FLAT, FINAL. During the Race.



1500 M. FLAT, FINAL. The Start.

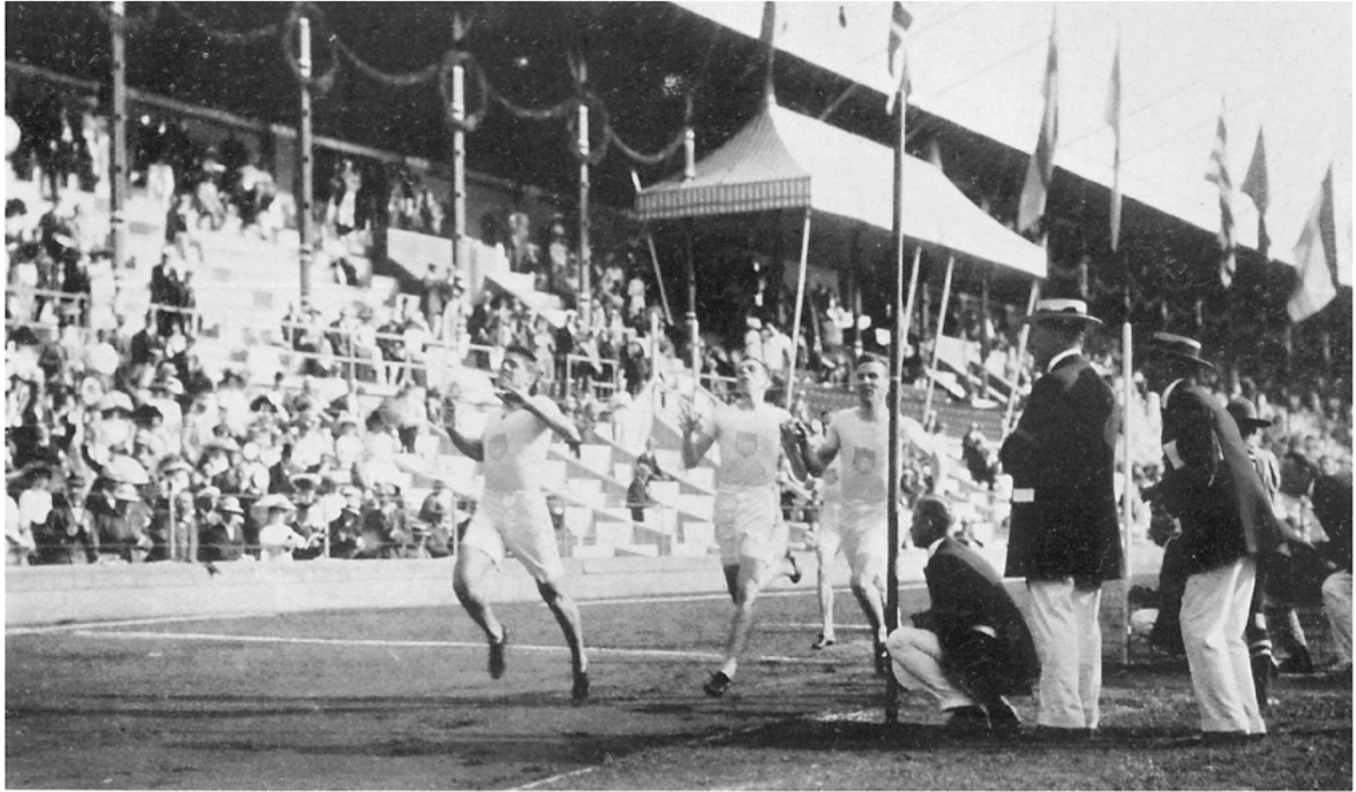

800 M. FLAT, FINAL. The Finish.



1500 M. FLAT, FINAL. The Finish.



5,000 M. FLAT, FINAL. The Start.



5,000 M. FLAT, FINAL. During the Race.
KOLEHMAINEN leading: BOUIN second.



10,000 M. FLAT. H. KOLEHMAINEN, Finland, winner.



5,000 M. FLAT, FINAL. KOLEHMAINEN and BOUIN The Finish.
(Bouin still leading.)

This was the first long-distance race run during the Games, and everyone was uncertain whom to pick for favourite, even if it was thought that Kolehmainen ought to win his heat. During the first two laps, Nicolovsky lay first, but then Kolehmainen, who had been second man, took the lead, and kept his place without any effort until he passed the post an easy winner. At first, Kramer kept close at the heels of Kolehmainen, while the Swedes stayed in the middle of the field. After only four laps had been run, Penc and Hellawell gave up the contest, and left the track. During the seventh lap, a group of leaders was formed, consisting of Kolehmainen, Kramer and Lee, these being followed at some distance by Öberg, Eke and Keeper. In the eighth lap, Keeper increased his pace and came nearer and nearer to Kramer and Lee, both of whom had seen Kolehmainen go away from them. When half the distance had been run, there remained only eight competitors of the field of twelve that had started, Kolehmainen now being 50 metres ahead of Keeper and Kramer. The superiority of the Finnish runner became more and more apparent as the race approached its close, and he won with the greatest ease, without having once been extended. Kramer left the track when nine laps still remained to be covered, while, towards the close of the race, the French representative, Heuet, improved his position more and more.

Second heat. 1. L. RICHARDSON, South Africa, **32.30⁸/₁₀**; 2. L. TEWANIMA, U. S. A., **32.31²/₅**; 3. M. KARLSSON, Sweden, **33.06²/₁₀**; 4. A. STENROOS, Finland, **33.28²/₅**; 5. A. ORLANDO, Italy, **33.44²/₅**. Also ran: B. Fock, Sweden; B. Larsson, Sweden; A. Sanchez, Chili; R. Humphreys, Great Britain; F. N. Hibbins, Great Britain, and G. Vietz, Germany, none of whom finished. — Immediately after the runners in the first heat had passed the post, 11 men drew up in line to begin the second heat. Among the number was Fock, a great favourite of his fellow-countrymen; he was not in the excellent condition he had been in during the training-trials, however; a bad attack of lumbago and a severe cold having put him quite off his previous excellent form. When the signal was given, Brynolf Larsson undertook to set the pace, having Fock and Karlsson close at his heels. Vietz, the German representative, increased the speed, however, when only two laps had been run. Then Richardson, Fock and Tewanima took it in turns to lead, and a good pace was kept up in consequence of this struggle for first place. After the fifth lap, Stenroos took the lead for a time, closely followed by Fock and Karlsson. A few more laps altered the placing of the field, two groups having been formed. In the first ran Stenroos, Karlsson and Tewanima, while Fock, Hibbins and Richardson formed the second. It was now that Fock was observed not to be in his usual running humour, and finally he fell altogether to the rear and soon afterwards left the track, an example that was followed by Humphreys and Hibbins. When there were seven laps left, Richardson went in front after a hard spurt, and only Tewanima followed him, but this the little American Indian did like a shadow. Karlsson lay about 60 metres behind the leading men, with Stenroos some 100 metres in the rear of the Swede. The final struggle between the two leaders was both long and severe, and it was not until just before the tape was reached that Tewanima was unable to hold his rival.

Third heat. 1. T. KOLEHMAINEN, Finland, **32.47⁴/₅**; 2. W. SCOTT, Great Britain, **32.55¹/₅**; 3. H. L. SCOTT, U. S. A., **34.14¹/₅**; 4. M. PERSSON, Sweden, **34.18³/₅**; 5. H. F. MAGUIRE, U. S. A., 34.32. Not placed: G. C. L. Wallach, Great Britain, and G. N. Hill, Australasia, neither of whom finished. — In this heat, which was run at noon, only seven men started. W. Scott at once took

the lead, with Wallach and Tatu Kolehmainen (a brother of Hannes K.) close at his heels. At first W. Scott left the rest of the field some distance behind, the group there being led by Kolehmainen. When half the distance had been covered, H. L. Scott (U. S. A.), was leading, with W. Scott (Great Britain), and T. Kolehmainen (Finland) in close attendance. Towards the end of the race, the Finnish runner's powers of endurance began to be apparent, and when, at 8,000 metres, he made a fresh attack on the leader, H. L. Scott resigned his position without a struggle, and Kolehmainen was then sure of his heat.

As only the first five men in each heat were entitled to run in the final, the following countries were represented in the closing scene as follows: Finland, U. S. A. and Sweden, 3 men each; Great Britain 2; France Italy, Canada and South Africa, 1 each.

Final.

Monday, 8 July.

- | | | | |
|----|--------------------------|---------------|--------------------|
| 1. | HANNES KOLEHMAINEN | Finland | $31.20\frac{4}{5}$ |
| | (Olympic record.) | | |
| 2. | L. TEWANIMA | U. S. A..... | $32.6\frac{3}{5}$ |
| 3. | A. STENROOS | Finland | $32.21\frac{4}{5}$ |

Not placed:

- | | | |
|------------------|--------------|--------------------|
| J. Keeper | Canada | $32.36\frac{1}{5}$ |
| A. Orlando | Italy | $33.31\frac{1}{5}$ |

Also started:

- | | |
|---------------------|---------------|
| T. Kolehmainen..... | Finland |
| H. L. Scott..... | U. S. A. |
| H. F. Maguire | » |
| W. Scott | Great Britain |
| M. Karlsson..... | Sweden |
| L. Richardson..... | South Africa |

Only 11 of the 15 runners qualified to start presented themselves at the scratch or barrier, two Swedes, J. Eke and M. Persson, being among the competitors who were absent. Not more than a lap had been covered before Hannes Kolehmainen was seen in front, where he led at a very rapid pace. He ran from start to finish in a wonderfully easy and attractive style, and was evidently in the best possible form. During the first five laps, Karlsson and W. Scott hung close at the heels of the Finlander, but then Scott had to let his man go, while, a few laps later, Karlsson found that he, too, was unable to keep up with the leader, and when half the distance was covered, the Swede had had enough and retired from the contest. Little more than 3,000 metres had been covered ere the field was scattered all over the track, with Kolehmainen in solitary state in front. The leader covered the first 5,000 metres in $11\frac{2}{5}$. At this distance Tewanima lay second, in company with Stenroos, with Keeper and Tatu Kolehmainen at a respectable distance behind them. The last-named runner retired after covering 6,000 metres,

When eight laps still remained, Richardson and Orlando were lapped by Hannes Kolehmainen, Richardson leaving the track directly afterwards. The sun and the rapid pace became too much for the two Scotts and for Maguire, so that only six men ran to a finish. Towards the close, Kolehmainen made the pace still hotter, and, spurting brilliantly, finished the race in excellent condition. Near the finish, Tewanima went away from Stenroos, who managed to secure third place, however.

HURDLE RACE, 110 METRES.

First Round.

Thursday, 11 July.

First heat. 1. G. A. CHISHOLM, U. S. A., $15\frac{7}{10}$ secs.; 2. K. SOLYMAR, Hungary, $16\frac{3}{5}$ secs. — An easy victory for Chisholm, who beat Solymar without any difficulty, clearing the hurdles elegantly and easily.

Second heat. 1. J. J. ELLER, J:NR., U. S. A., 16 secs.; 2. G. R. L. ANDERSON, Great Britain, $16\frac{3}{5}$ secs. — Eller j:nr. won this heat, after having tipped two hurdles, but evidently without having exerted himself too much. It was clear, too, that that very fine English hurdle-jumper, Anderson, who came in as No. 2, thus assuring himself of a place in the second round, did not show what he was able to do, this being quite unnecessary on the occasion.

Third heat. 1. M. W. HAWKINS, U. S. A., $16\frac{1}{10}$ secs.; 2. G. I. ANDRÉ, France, $6\frac{4}{5}$ secs. — This heat, too, was won by an American, Hawkins breaking the tape as first man, with André, the representative of France, second.

Fourth heat. 1. F. R. BIE, Norway, $16\frac{1}{5}$ secs.; 2. W. WICKHOLM, Finland, $16\frac{3}{5}$ secs. — Bie, Norway, made certain of a place in the final by beating the Finlander, Wickholm, after a race which, most certainly, was not to be taken as any proof of what the winner can do when called upon to make an effort.

Fifth heat. 1. P. EITEL, Chili, $17\frac{1}{5}$ secs. — The Chilian had a walk-over but managed, in any case, to knock down two hurdles.

Sixth heat. 1. M. F. L. DELARY, France, 16 secs.; 2. W. S. BLANCHARD, U. S. A., 16 secs. Not placed: A. Pagani, Italy. — In this heat Delaby, the French representative, had a hard tussle with Blanchard which ended in both finishing in the same time, Delaby breaking the tape a hair's breadth in front of his opponent. Both men tipped a hurdle.

Seventh heat. 1. E. M. PRITCHARD, U. S. A., $16\frac{2}{5}$; 2. H. E. H. BLAKENEY, Great Britain., $17\frac{2}{5}$. — Pritchard tipped no less than two hurdles, but won easily from the English representative, Blakeney, in comparatively poor time.

Eighth heat. 1. J. P. NICHOLSON, U. S. A., $15\frac{5}{10}$; 2. D. COLBACHINI, Italy, $16\frac{1}{10}$. — A very pretty exhibition of technics and speed was given in this heat by Nicholson, who won with the greatest ease in very good time.

Ninth heat. 1. F. W. KELLY, U. S. A., $16\frac{2}{5}$; Walk-over. — This heat was a walk-over for Kelly, so that there was no opportunity of seeing what he was able to do.

Tenth heat. 1. J. R. CASE, U. S. A., $16\frac{3}{10}$; 2. H. VON BÖNNINGHAUSEN, Germany, 17 secs. — The German runner, von Bönninghausen, was beaten easily by the American, who took the heat with evident calmness.

Eleventh heat. 1. K. POWELL, Great Britain, $15\frac{3}{5}$; 2. J. WENDELL, U. S. A., $15\frac{7}{10}$. — This heat gave an opportunity of seeing a struggle between the English university athlete, Powell, and J. Wendell, U. S. A. The result was a victory for the Englishman, who beat his rival by $\frac{1}{10}$ sec., both men running the heat in comparatively good time.

Second Round.

First heat. 1. K. POWELL, Great Britain, $15\frac{3}{5}$. Not placed: J. J. Eller J:nr, U. S. A.; F. R. Bie, Norway; P. Eitel, Chili. — Powell repeated his victory in the trials, and, to the general surprise, beat Eller, J:nr. Bie was in front for the greater part of the distance, but in the finish the Englishman travelled faster and won pretty easily.

Second heat. 1. M. W. HAWKINS, U. S. A., $15\frac{7}{10}$. Not placed: D. Colbachi, Italy; M. F. L. Delaby, France; K. Solymar, Hungary — Hawkins won, but was hard pressed by the Italian.

Third heat. 1. J. Y. NICHOLSON, U. S. A., $15\frac{3}{5}$; Not placed: H. von Bönninghausen, Germany ; W. S. Blanchard, U. S. A. — In this intermediate heat, Nicholson showed that he was an extraordinarily safe hurdle-jumper. He cleared the hurdles with most exquisite technical skill, and he won as he liked in good time.

Fourth heat. 1. J. WENDELL, U. S. A., $15\frac{6}{10}$. Not placed: G. A. Chisholm, U. S. A.; G. R. L. Anderson Great Britain, fell. — Anderson led from the start and even at the eighth flight was a safe winner, but then he managed to get his foot under the top bar, stumbled and fell. This enabled the American runner, Wendell, to break the tape first, with one of his countrymen as next man.

Fifth heat. 1. F. W. KELLY, U. S. A., $15\frac{3}{5}$. Not placed: W. Wickholm, Finland; H. E. H. Blakeney, Great Britain. — Kelly had here an opportunity of showing something of his real form, although the Finnish runner did not really extend him. Kelly's speed over the hurdles, as well as between the flights, was quite extraordinary, and, after the exhibition he gave in this intermediate heat, it was quite evident that he would be one of the most dangerous men in the final.

Sixth heat. 1. J. R. CASE, U. S. A., $15\frac{3}{5}$ secs. Not placed: E. M. Pritchard, U. S. A. and G. I. André, France. — In this heat, too, victory inclined to the Americans, Case coming in first.

The close of the intermediate heats saw 5 U. S. A. men and 1 representative of Great Britain qualified for the final, and, under these circumstances, the former, of course, had the best chance of making a fine show at the end.

Final.

Friday, 12 July.

1. F. W. KELLY	U. S. A.....	$15\frac{1}{10}$	secs.
2. J. WENDELL.....	U. S. A.....	$15\frac{1}{5}$	secs.
3. M. W. Hawkins	U. S. A.....	$15\frac{3}{10}$	secs.

Not placed :

J. R. Case..... U. S. A.
K. Powell Great Britain.
J. P. Nicholson U. S. A. (fell).

Nicholson and Powell were a fraction behind the others in the start, but at the second flight the Englishman was level with the flying group of Americans. The field kept pretty well together until about the middle of the course, when Powell fell behind somewhat, while Kelly, Wendell and Nicholson continued clearing the hurdles at a tremendous pace, with Hawkins and Case the least bit behind them. At this moment it appeared as if the final struggle would lie between Kelly, Nicholson and Wendell, but, at the eighth flight, Nicholson did not lift one of his feet clear, caught the bar and fell, the tremendous finish then resolving itself into a duel between Kelly and Wendell for first place. The first-named managed to get in front the instant before the tape was broken, while Hawkins beat Case for third place by hardly anything to speak of. Powell came on during the last two flights, but was not speedy enough to be able to dispute any of the places with the Americans.

RELAY RACE, 400 METRES.

First Round.

Monday, 8 July.

First heat. I. CANADA (McConnell, Lukeman, Beasley and Howard). W. O. Time: $46\frac{1}{8}$ secs.

Second heat. I. U. S. A. (Courtney, Belote, Wilson and Cooke). W. O. Time $43\frac{7}{10}$ sec.

Third heat. I. GREAT BRITAIN (Jacobs, Macintosh, d'Arcy and Applegarth). W. O. Time: 45 sec.

Fourth heat. SWEDEN (Möller, Luther, Persson and Lindberg). W. O. Time: $43\frac{3}{5}$ sec.

Fifth heat. GERMANY (Halt, Herrman, Kern and Rau). Time: $43\frac{3}{5}$ sec. Not placed: Austria (Krojer, Rauch, Weininger and Fleischer). Time: $44\frac{4}{5}$ sec. Germany had the inner lane, and at once drew away from its opponents, thanks, not least, to the clever way in which the baton was passed on. When Rau, who was last man, got the baton in his hand, he had not the least difficulty in winning for his team by about 15 metres.

Sixth heat. I. HUNGARY, (Szobota, Rácz, Szalai, Jankowich). Time: $43\frac{7}{10}$ sec. Not placed: France (Failliot, Rolot, Lelong and Mourlon). Time: $43\frac{4}{5}$ sec. — The sixth and last heat was a very close thing, although the Hungarians were the best men the whole of the way, and won by a good three metres.

Second Round.

Monday, 8 July.

First heat. I. GREAT BRITAIN, 43 sec. The U. S. A. team was disqualified for a fault in passing the baton. — The American team, which had the inner

lane, caught up the Englishmen at the very first pass, the representatives of Great Britain running on the outer lane. But on the first runner in the American team handing over the baton to the second man, the latter passed the 20-metre mark before the stick was left in his hand, and, consequently, the team was disqualified, Great Britain being declared the winner of the heat.

Second heat. 1. SWEDEN, $42\frac{6}{10}$ sec. Not placed: Hungary, $42\frac{9}{10}$ sec. — The Swedish four lay in the outer lane, but the speedy start made by their first man gave them a lead from the very beginning. Thanks to this and the excellent way in which the baton was passed, the team was always well in front, and Lindberg, the last man, was not called upon to do his best to win the heat for his side.

Third heat. 1. GERMANY, $42\frac{8}{10}$ sec. Not placed: Canada $43\frac{5}{10}$ sec. — The Canadians managed to keep finely ahead of the Germans for the first 100 metres, but the team had only an elementary knowledge of the method of passing the staff, with the result that, after a piece of bad work in this respect by the first and second men, the Canadians were, practically speaking, quite out of the running, in spite of a magnificent sprint by Howard along the last straight.

Final.

Tuesday, 9 July.

1. GREAT BRITAIN..... $42\frac{2}{5}$ sec.
(D. H. Jacobs, H. M. Macintosh, V. H. A.
d'Arcy and W. R. Applegarth)
2. SWEDEN..... $42\frac{3}{5}$ sec.
(I. Möller, C. Luther, T. Persson, K. Lind-
berg)
Germany : disqualified.

Germany started along the inner lane, Great Britain having the middle one and Sweden the outer. The three No 1 men got away together, and when they passed on their batons, Great Britain and Sweden were level, the difference in the position of the scratch mark being taken into account. Germany, on the other hand, had lost a little, most probably the result of some uncertainty when Röhr passed to Herrman. Luther, second man in the Swedish team, ran grandly down the straight, and when he reached Möller's mark he was $1\frac{1}{2}$ metre ahead of Macintosh. Möller fumbled the pass very badly, however, so that d'Arcy was not only able to make good the ground lost, but also to get a most useful lead of a metre. Kern, of the German team, became very nervous when he saw his countryman, Herrman, some $4\frac{1}{2}$ metres behind, and started to run too soon, the result of which was that he was obliged to stop so as to give Herrman a chance of passing him the baton within the stipulated 20 metres. When Herrman was still 7 metres away from Kern, the latter once more went off at full speed, so that Herrman could not give him the baton before he was $1\frac{1}{2}$ metre beyond the limit for the pass. The three judges of the course at once held up their hands, to show that

a faulty pass had been made, and an official report of the matter was made to the leader of the competition at the same moment that the runners passed the finish. In accordance with the regulations, the German team was, consequently, disqualified. In the meantime, Möller and d'Arcy were having a hard tussle at the passing-on station in the curve, and Kern, too, managed to regain a little of the ground lost by the German four. At the last pass, Great Britain led by half a metre, in spite of a most brilliant pass between Lindberg and Möller. Rau, the last in the German team, took the baton finely from Kern and, in the finish, he passed Lindberg and pressed Applegarth hard. The representative of Great Britain broke the worsted a decimetre or two in front of Rau, however, Lindberg being 2 metres behind the German.

RELAY RACE, 1,600 METRES.

First Round.

Sunday, 14 July.

First heat. 1. GREAT BRITAIN (C. N. Seedhouse, J. T. Soutter, E. J. Henley, George Nicol), 3.19; 2. CANADA (G. N. Brock, J. L. Tait, J. A. Howard, T. H. Gallon), **3.22¹/₅**. — The original intention had been that Canada, Great Britain and Italy should start in this heat, but, as Italy did not put in an appearance, the heat resolved itself into a contest between Great Britain and Canada. The first two men in the two teams were pretty equally matched, and it was really Canada's third man who lost so much against Nicol that a victory for Great Britain became a certainty. Seedhouse ran his distance in brilliant style and increased the lead already obtained, so that the British team won by about 20 met. The time taken by the winning team, 3 min. 19 sec., was the best for the day, and showed that Great Britain had sent a very good four to represent her in this competition.

Second heat. 1. U. S. A. (M. W. Sheppard, E. F. Lindberg, J. E. Meredith, C. D. Reidpath), **3.23³/₁₀**; 2. GERMANY, (H. Braun, M. Herrmann, H. Wenseler, E. Lehmann) **3.28¹/₅**. — Germany and the U. S. A. team opposed each other in this heat, as the Bohemians did not come to the scratch. The result of the race was a foregone conclusion, of course. Lindberg, who ran as number 1 in the American team, at once succeeded in getting a lead. The advantage which he thus procured for his team in the first change of the baton was afterwards considerably increased by the remaining members of his side. Braun who, of course, could have given Reidpath a good race for the last distance, had now no chance of catching up the American, and so took things very quietly.

Third heat. 1. FRANCE (C. A. C. Poulenard, P. Failliot, C. L. Lelong, R. Schurrer), **3.22⁵/₁₀**; 2. SWEDEN (J. Dahlin, K. Stenborg, P. Zerling, E. Lindholm), 3.25; 3. HUNGARY (I. Déván, F. Mezei, E. Szerelemhegyi, Ö. Bodor) **3.29³/₅**. — On account of Russia not putting in its appearance in this heat, there were only three teams that competed, France, Hungary and Sweden. Lelong, the first man in the French team, beat his rivals in the first distance with the greatest ease, Zerling (Sweden), especially, not at all running in the form he had been expected to show. At the second change of the baton, Dahlin, who ran number two in the

Swedish team, caught up the Hungarian and was able to pass on the stick at the same time as the second runner in this team. The Frenchmen's baton, however, was already 6 met. in front. Lindholm and Failliot were running in the third stretch, and here the Swede caught up the Frenchman, but he had apparently run himself out at the beginning of his distance and, towards the finish, Failliot again left Lindholm. Poulernard, who ran as the final man in the French team, was able to take the baton about 25 metres in front of Stenborg, the last of the Swedish team, and in spite of the latter's brilliant sprint in the final distance, the Frenchman broke the tape about 15 metres in front of his opponent who, in his turn, was considerably ahead of the Hungarian.

Final.

Monday, 15 July.

- 1. U. S. A. 3.16³/₅.
(Olympic record.)
(M. W. Sheppard, E. F. Lindberg, J. E. Meredith, C. D. Reidpath)
- 2. FRANCE..... 3.20⁷/₁₀.
(C. A. C. Poulernard, P. Failliot, C. L. Lelong, R. Schurrer)
- 3. GREAT BRITAIN 3.23¹/₅.
(G. Nicol, E. J. Henley, J. T. Soutter, C. N. Seedhouse)

The first men in the respective teams were Sheppard, Lelong and Soutter. At first the Frenchman, going at a good pace, took the lead with Sheppard close at his heels, while Soutter, who had the misfortune to hurt his foot some time before the beginning of the race, ran with a limp which, of course, prevented him from doing anything like the good work he had shown in the trial heat. After quitting the last curve, Sheppard took the lead with the greatest ease before handing the baton to the next man in his team, which he did some metres in front of the Frenchman. The remaining members of the U. S. A. team steadily increased the advantage already gained, and Reidpath, who ran the last stretch, broke the tape about 30 metres in front of his French rival. In spite of a very pretty piece of work on the part of the last three men in the British team, the representatives of France succeeded in gaining second honours.

TEAM RACE, 3,000 METRES.

First Round.

Friday, 12 July.

First heat. 1. U. S. A. (A. R. Kiviat, 8.46³/₁₀; T. S. Berna, 8.50¹/₁₀; N. S. Taber, 8.5 I ; S. V. Bonhag, 8.52²/₁₀; H. L. Scott, 8.53⁴/₁₀), 9 points. 2. FIN-

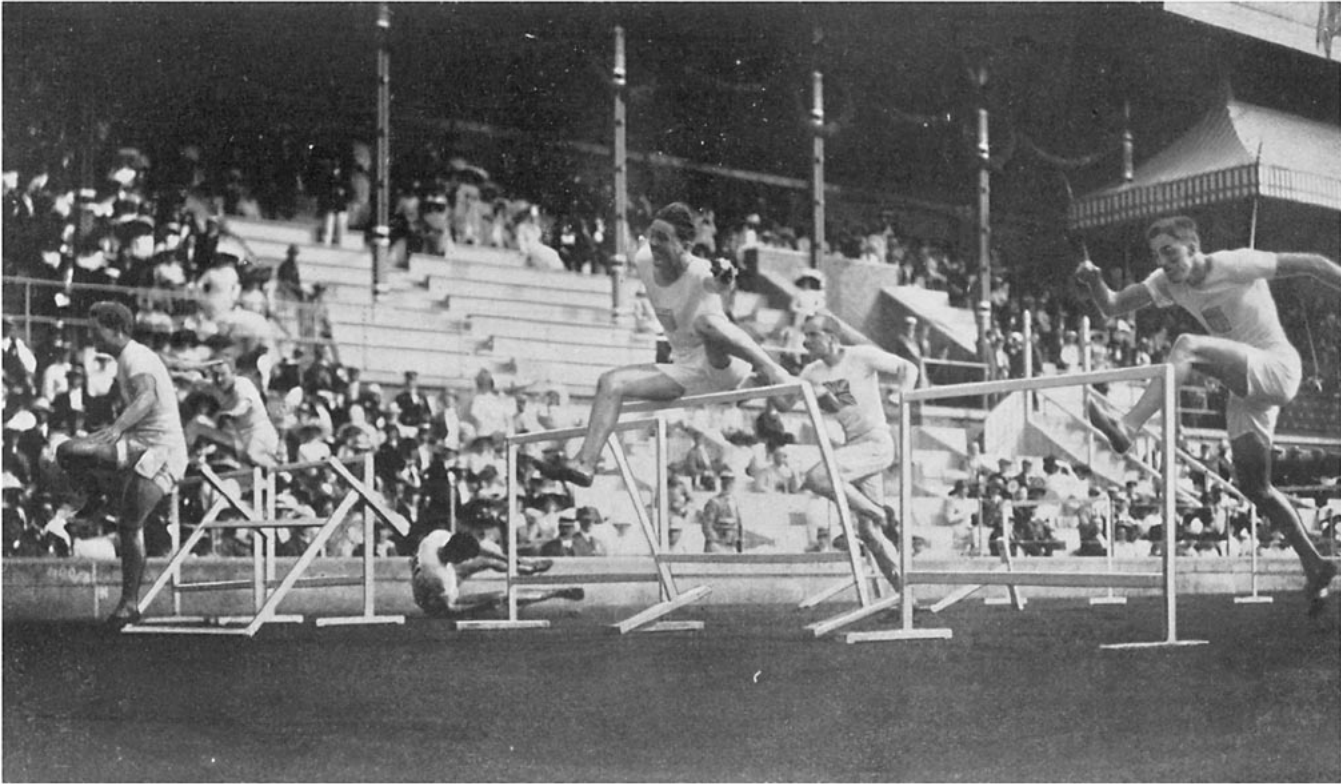

HURDLE RACE, 110 M., FINAL



HURDLE RACE, 110 M., F. W. KELLY, U.S.A., winner

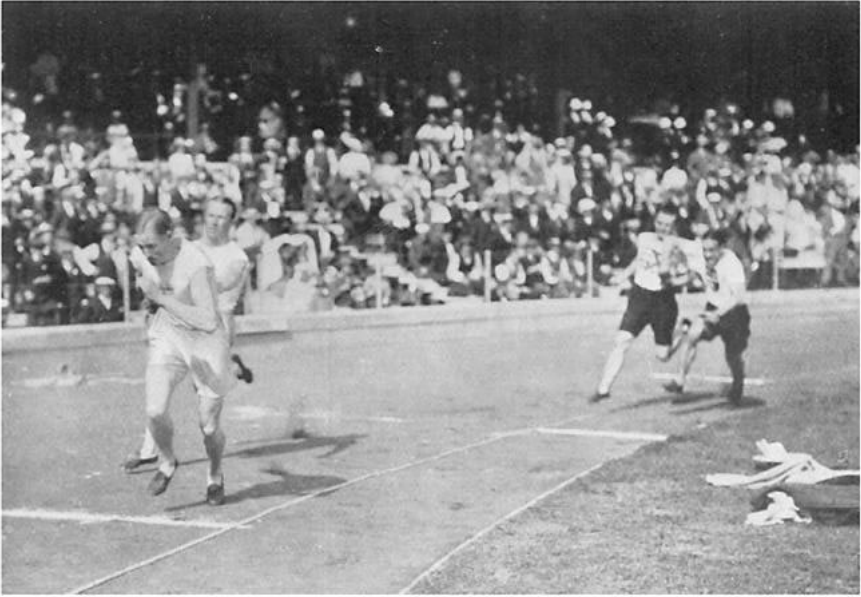

RELAY RACE 400 M. TRIAL HEAT. Sweden—Hungary.



RELAY RACE 400 M., FINAL. During the Race.



RELAY RACE 400 M., FINAL. The Finish.



RELAY RACE 1600 M. The second handing-on of staff by U. S. A. Team.

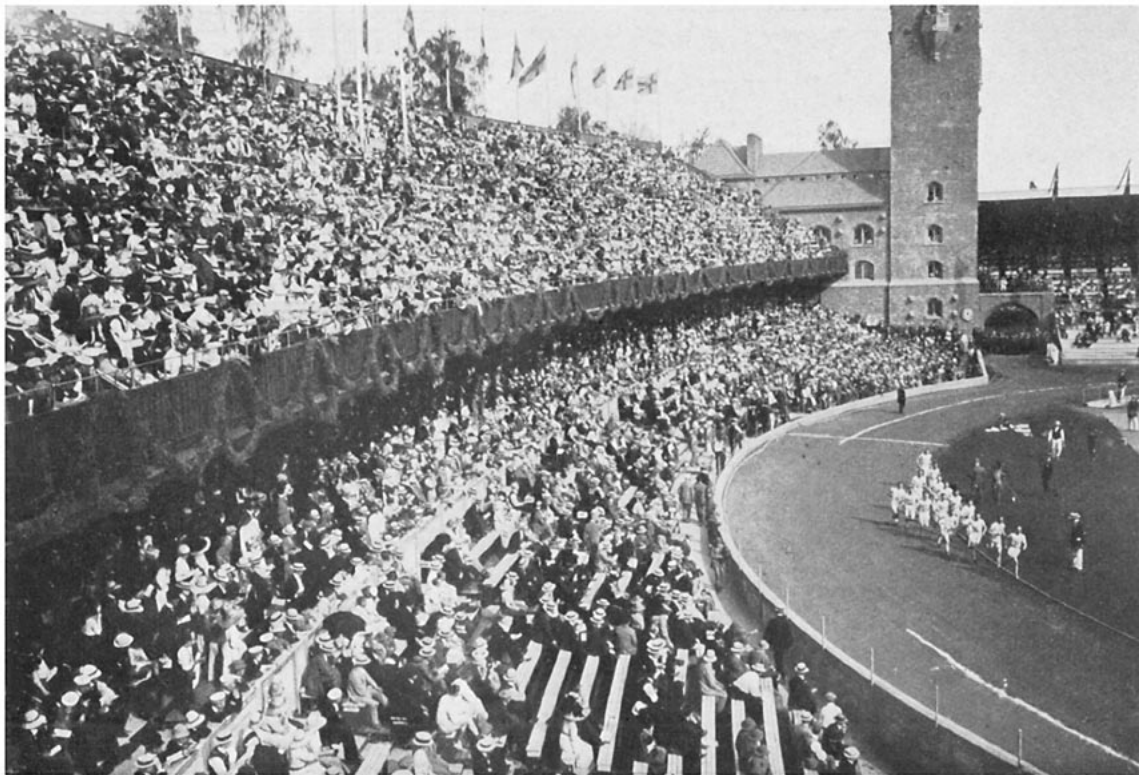

TEAM RACE, 3 000 M., FINAL

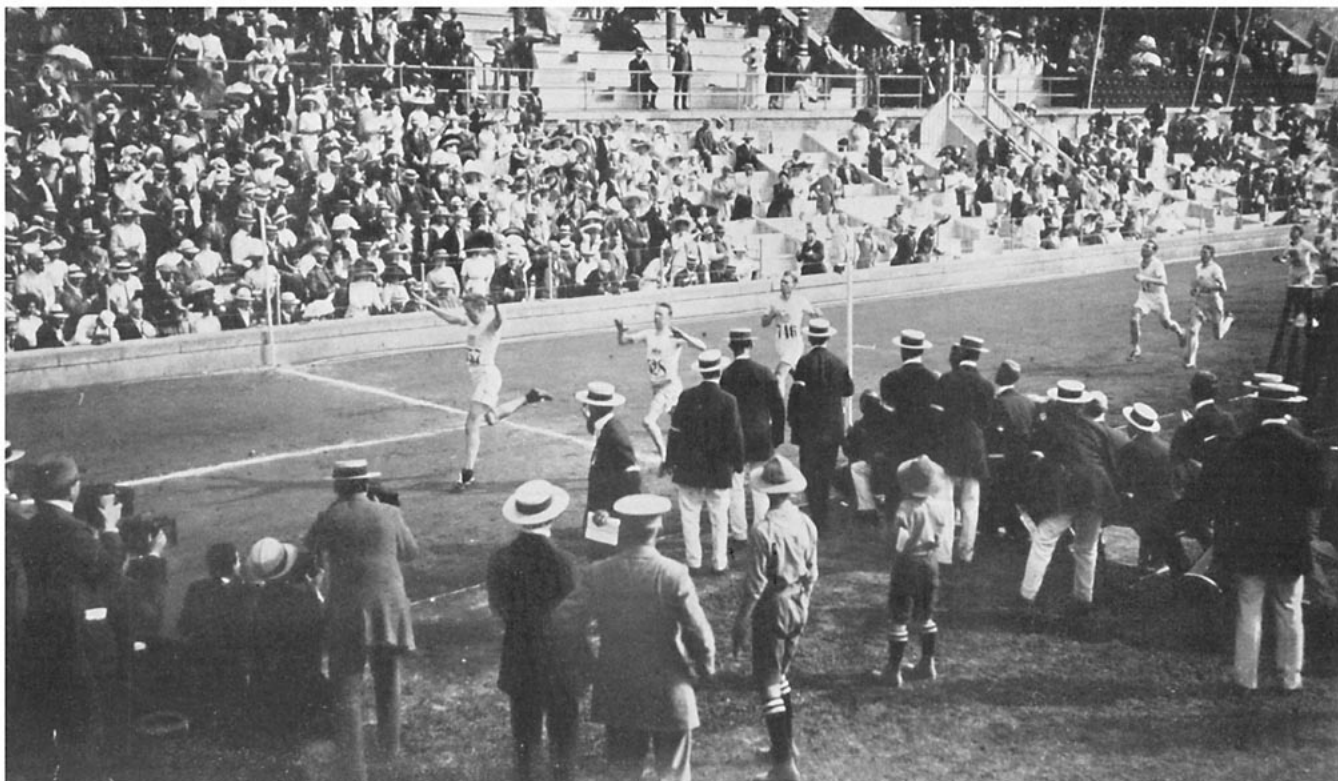

TEAM RACE, 3 000 M., FINAL, The Finish



TEAM RACE 3000 M., FINAL.

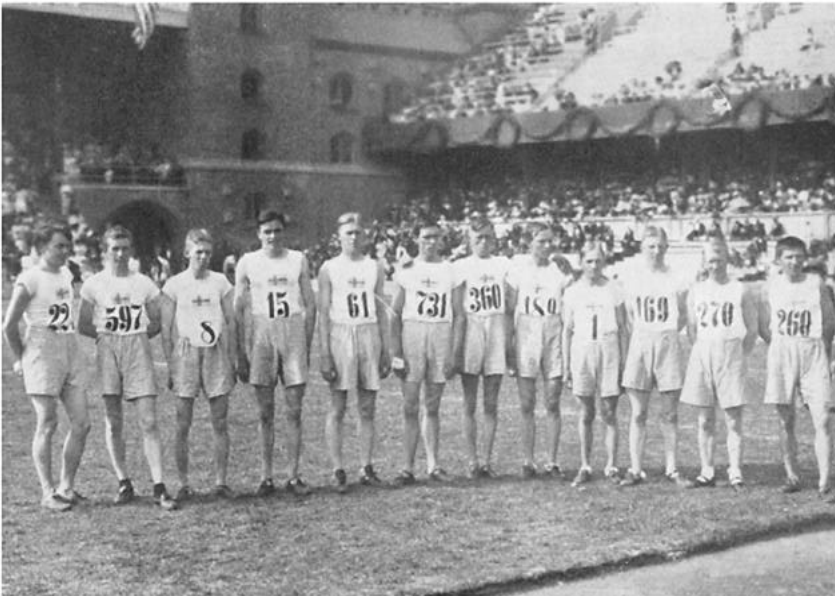

SWEDISH COMPETITORS IN THE CROSS-COUNTRY RACE.

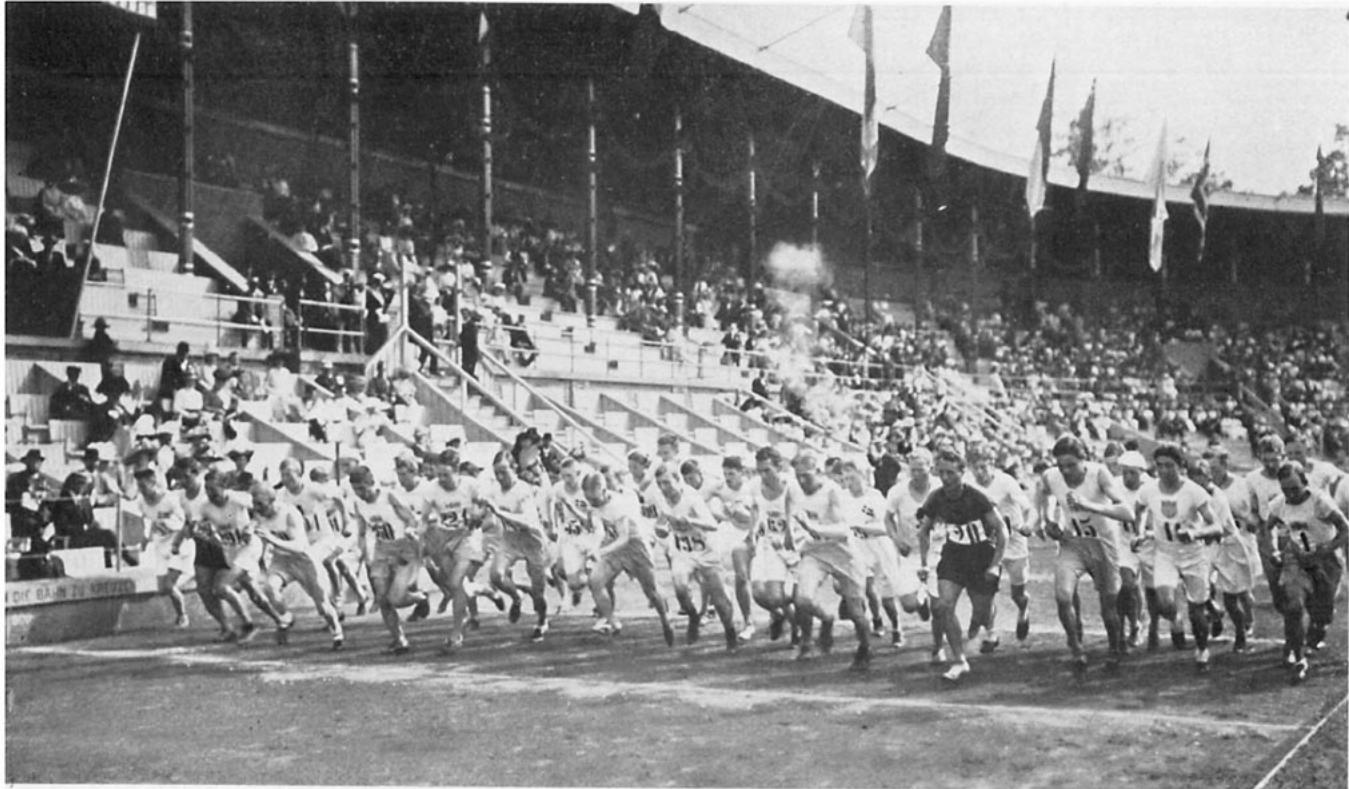

CROSS-COUNTRY RACE, THE START.

LAND (H. Kolehmainen, $8.36\frac{9}{10}$; A. Stenroos, $8.54\frac{1}{10}$; F. W. Johansson $8.57\frac{1}{5}$; A. Lindholm, $9.46\frac{2}{5}$; E. Harju, $10.10\frac{3}{6}$), 12 points. South Africa should have started in the first heat, but the team did not put in an appearance, so that the event resolved itself into a contest between the U. S. A. and Finland. McCurdy at once took the lead, going at a good pace, Kiviat lying third, with Johansson and Stenroos, both Finlanders, behind them. After a couple of laps, two of the other Finlanders, Harju and Lindholm, had got quite enough of the rapid going, and began to fall more and more to the rear. With four laps left, Kolehmainen and Kiviat had drawn about 20 metres in front of the remainder of the field, while Scott came on and took the lead in the rear division, being then third man, with Stenroos and Berna as his nearest rivals. When the bell rang for the last lap, Kolehmainen and Kiviat were about 50 metres in front of Berna. In the straight, Kiviat still succeeded in holding the Finlander, but he gave up the pursuit in the final curve, and, after a grand final spurt, Kolehmainen broke the tape a very easy winner. The Americans, however, qualified for the final. Kolehmainen's time was $8.36\frac{9}{10}$, a world's record.

Second heat. 1. SWEDEN (B. Fock, N. Frykberg, E. Wide, T. Ohlsson and J. Zander; all $9.14\frac{7}{10}$), 9 points. 2. GERMANY (E. von Siegel, $9.06\frac{8}{10}$; G. Amberger, $9.32\frac{5}{10}$; G. Vietz, $9.34\frac{1}{5}$; G. Mickler, did not finish), 12 points. — Russia did not come to the scratch, although entered for the competition. Mickler set the pace, but very poorly, however, and Wide (Sweden) remained quietly as number two. After $1\frac{1}{2}$ lap Fock came on and took up second place behind Mickler, but he was soon passed by Frykberg who held the lead for the next few laps, the placing then being as follows : Frykberg, Siegel, Wide and Fock. After four laps had been run, Mickler had quite enough, however, and left the track, while, three laps from the finish, all the Swedes were in a bunch, with Siegel in the middle. Siegel stubbornly kept the lead he at length succeeded in gaining, and when the Swedish team saw that they were not threatened by the other Germans, who now lay a pretty long way behind, they let Siegel run as he wished, they themselves keeping together and passing the post in a line, thus easily assuring themselves of a place in the final.

Third heat. 1. GREAT BRITAIN (C. H. A. Porter, E. Owen, W. C. Moore, G. W. Hutson, W. Cottrill ; all $10.21\frac{6}{10}$), W. O. — Neither France nor Italy came to the scratch, and the team representing Great Britain ran the distance alone, at a very moderate speed.

The U. S. A., Great Britain and Sweden were thus left in for the final.

Final.

Saturday, 13, July.

1. U. S. A. 9 points.
(T. S. Berna, $8.44\frac{3}{5}$; N. S. Taber, $8.45\frac{1}{5}$; G. V. Bonhag, $8.46\frac{3}{5}$; A. R. Kiviat; H. L. Scott)
2. SWEDEN 13 points,
(T. Olsson, $8.44\frac{3}{5}$; E. Wide, $8.46\frac{1}{5}$; B. Fock, $8.47\frac{1}{10}$; N. Frykberg, 8.49 ; J. Zander, $8.48\frac{9}{10}$)

3. GREAT BRITAIN 23 points.
 (W. Cottrill, G. W. Hutson,
 C. H. A. Porter; E. Owen;
 W. C. Moore).

Individual placing :

- | | | | |
|-----|-----------------|---------------|-------------------------------------|
| 1. | T. S. Berna | U. S. A. | 8.44 ³ / ₅ . |
| 2. | T. Olsson | Sweden | 8.44 ³ / ₅ . |
| 3. | N. S. Taber | U. S. A. | 8.45 ¹ / ₅ . |
| 4. | E. Wide | Sweden | 8.46 ¹ / ₅ . |
| 5. | G. V. Bonhag | U. S. A. | 8.46 ³ / ₅ . |
| 6. | W. Cottrill | Great Britain | 8.46 ⁴ / ₅ . |
| 7. | B. Fock | Sweden | 8.47 ¹ / ₁₀ . |
| 8. | G. W. Hutson | Great Britain | 8.47 ¹ / ₅ . |
| 9. | C. H. A. Porter | Great Britain | 8.48 |
| 10. | J. Zander | Sweden | 8.48 ⁹ / ₁₀ . |
| 11. | N. Frykberg | Sweden | 8.49. |

The first lap was run with Porter leading, followed by Wide and Kiviat, Berna being the very last. After a lap and a half had been run, Fock came on and took the lead, the pace then becoming somewhat better. Moore, Great Britain, worked himself to the front during the second and third laps and was soon running abreast of Fock. The pace however was not so great at this period of the race but that the entire field could keep almost bunched together, lap after lap. After the fourth turn round, Berna grew tired of forming the rearguard and with his long stride came up level with Fock, Wide following close at his heels. It was Berna who took the lead, however, while Moore (G. Britain), kept falling back. It looked as if the field was going to let Berna run away altogether and the Swedes lay pretty badly boxed in, in the middle of the group. When the bell rang for the last lap, Berna still had the lead, with Taber as second man. In the last curve but one, however, Ohlsson began his spurt, which carried him past Taber and threateningly near Berna, the leader. Wide also came on with a spurt, but both the Swedes had begun too late to be able to overtake the first man, who passed the winning-post with Ohlsson only a few centimetres behind him, so close indeed, that no difference in time could be noted. Fock, who had been ill for some time previously, had taken the trouble, however, to form one of the Swedish team, but he did not show anything like the form he possessed a month previously, and failed in the spurt, and was passed by an American and an Englishman. The point-result was, that the U. S. A. gained first place, Sweden being second and Great Britain third.

CROSS=COUNTRY RACE, 8,000 METRES.

Monday, 15 July.

- | | | | |
|----|----------------|---------|-------------------------------------|
| 1. | H. KOLEHMAINEN | Finland | 45.11 ³ / ₅ . |
| 2. | Hj. ANDERSSON | Sweden | 45.44 ⁴ / ₅ . |
| 3. | J. EKE | Sweden | 46.37 ³ / ₅ . |

Not placed :

4.	J. Eskola.....	Finland	46.54 ⁴ / ₅ .
5.	J. Ternström	Sweden	47. 7 ¹ / ₁₀ .
6.	A. Stenroos	Finland	47.23 ² / ₅ .
7.	J. Kyrönen.....	Finland	47.32.
8.	L. Richardsson.....	South Africa	47.33 ⁵ / ₁₀ .
9.	B. Larsson	Sweden	47.37 ² / ₅ .
10.	J. Sundkvist	Sweden	47.40.
11.	F. W. Johanson	Finland	48. 3.
12.	H. Hellawell.....	U. S. A.	48.12.
13.	K. Lundström	Sweden	48.45 ² / ₅ .
14.	L. Christiansen	Denmark	49. 6 ² / ₅ .
15.	F. N. Hibbins	Great Britain	49.18 ¹ / ₅ .
16.	E. Glover	Great Britain	49.53 ⁷ / ₁₀ .
17.	B. Fock	Sweden	50.15 ⁴ / ₅ .
18.	T. Humphreys	Great Britain	50.28.
19.	O. Hovdenak	Norway	50.40 ⁴ / ₅ .
20.	P. Finnerud	Norway	51.16 ¹ / ₅ .
21.	G. Carlén	Sweden	51.26 ⁴ / ₅ .
22.	J. Andersen	Norway	51.47 ² / ₅ .
23.	V. Pedersen	Denmark	53.00 ⁴ / ₅ .
24.	H. L. Scott	U. S. A.	53.51 ² / ₅ .
25.	W. Heikkilä	Finland	54. 8.
26.	C. A. Holmberg	Denmark	54.24 ⁹ / ₁₀ .
27.	G. Vietz	Germany	54.40 ³ / ₅ .
28.	S. Rasmussen	Denmark	55.27.

The course chosen for the cross-country race of the Fifth Olympiad was probably laid across altogether too broken country for both the American and British competitors; the latter, especially, being accustomed to a more liberal allowance of cross-meadow running than was granted here. On this occasion the race had the character loved by Swedes, and was such as they think it ought to be and must be, and the difficult obstacles that nature itself had placed in the way of the competitors formed a test, not only of the running powers of the men, but also of their physical endurance.

The course went in a wide curve north of the Stadium. At first it followed the road, afterwards running into a stretch of woodland which, here and there, was of a very broken character, with stiff climbs and very steep descents which, for those not accustomed to them, were very difficult to negotiate at full speed. Towards the end of the course things were less exacting, and, just before the Stadium was reached, the track lay along the road again. The way was marked out by means of red cloth attached to the trees and bushes along the route, while pieces of paper of the same colour were strewn over the ground the whole of the distance, so that there ought to have been no possibility of mistaking the route.

The start was in the Stadium, just opposite the Royal box. The competitors had first to run a quarter of a lap inside the Stadium,

which was left by the western gateway for the road outside. The length of the course across country was 4,000 metres, and had to be run twice in order to complete the full distance. After the first time round, the track entered the Stadium again, where a full lap had to be run round the cinder-path, the competitors leaving by the same gateway once more for the second 4,000 metres, the race ending with a final lap round the Stadium.

The field ran through the gateway at an excellent pace, a Swede leading. There was no telephonic communication with the control-officials at various places along the course, so that there was no little excitement in the Stadium to see who would be the first man to enter the grounds on the conclusion of the first round. As was expected, it was Kolehmainen that first came through the gateway; he ran a lap round the Stadium in his usual easy style and disappeared outside again.

Even at this period of the race the Finlander had a good lead over the next man, a Swede, Lindahl, who lay about zoo metres behind. After Lindahl came Johansson (Finland) then the Swedes, Lundström, Andersson and Sundkvist ; Hellowell (U. S. A.); two more Finlanders; then Eke and Larsson (Sweden), and, finally, the rest of the field, in groups or singly. Lindahl (Sweden), who was in excellent form, met with an accident as he was leaving the Stadium again, after completing the first half of the race, a runner that came in through the gateway just as Lindahl was passing out, involuntarily striking the Swedish runner with his elbow in the side so severely that Lindahl was knocked down and, in spite of several plucky efforts to go on with the race, was obliged to retire from the contest.

Bouin, France, had had quite enough at the end of the first round and retired, his example being followed by a great many other runners. During the course of the second, the field fell off still more, the difficulties of the course beginning to make themselves fully felt. Kolehmainen kept the lead he had won in the first round, and, practically speaking, he ran more than half the total distance without anyone in his company. Behind him, some 150 metres in the rear, came a bunch of runners, consisting mostly of Swedes and Finlanders.

Halfway in the second round, Andersson (Sweden), began to draw away from the rest of this group, and towards the end of the race came nearer and nearer to the leader. Behind Andersson came Eke, who also began to leave the other runners in the rear, and during the last half kilometre the field commenced to be strung out along the course, the pace increasing more and more, the nearer the runners came to the Stadium. In spite of some excellent work by Andersson during the second round, he could not get into touch with the Finlander, who still kept well ahead of the whole field.

Everybody in the Stadium sat full of expectation to see the first man come in, although there was no one but supposed that Koleh-

mainen would be the victor in this competition too. This turned out to be the case, and, amid a tumult of applause, the Finlander broke the tape in good condition, although it could be seen that he had been somewhat more extended than in any of the other events in which he had come off victor. Kolehmainen had not quite covered the first straight of the running path in the Stadium, before the next man appeared at the gateway. It was Andersson (Sweden), who came on to the track about 60 metres behind the Finlander, while, some few hundred metres in the rear of Andersson, followed another Swede, J. Eke.

Close at the heels of the latter there was a Finlander, J. Eskola, who was only a few score metres in front of the next man, Ternström (Sweden), who had two Finlanders in company, A. Stenroos and J. Kyrönen. The eighth man was the first non-European competitor, Richardson (South Africa), and immediately after him, with but a few metres between them both, came two more Swedes, B. Larsson and J. Sundquist.

The difficulties of the course had evidently been too much for the American and British representatives, none of whom were in the first ten.

TEAM COMPETITION IN CROSS=COUNTRY RACE.

1. SWEDEN 2 + 3 + 5 = 10 points.
(Hj. Andersson, J. Eke, J. Ternström),
2. FINLAND 1 + 4 + 6 = 11 points.
(H. Kolehmainen, J. Eskola, A. Stenroos),
3. GREAT BRITAIN 15 + 16 + 18 = 49 points.
(F. N. Hibbins, E. Glover, T. Humphreys)

Not placed :

- Norway 19 + 20 + 22 = 61 points.
(O. Hovdenak, P. Finnerud, J. Andersen)
- Denmark 14 + 23 + 26 = 63 points.
(L. Christiansen, V. Pedersen, C. A. Holmberg),

The individual cross-country competition served at the same time as the team cross-country event and, as it turned out, the struggle lay between Sweden and Finland. It is true that the team from Great Britain was the favourite, but the course was probably all too difficult to allow the British runners to show their proper speed over the 8,000 metres. The first three men from each country were counted as forming a team, and the place-figures of these three added together decided the placing of the competing nations. It is true that Finland, in consequence of Kolehmainen's victory, got the place-figure, 1, but the Swedish competitors were more even, and took the second, third and fifth places as against Finland's first, fourth and seventh, Sweden thus winning by one point. Great Britain was third, the first three men in its team being fifteenth, sixteenth and eighteenth.

THE MARATHON RACE.

Sunday, 14 July

- 1 K. K. Mc ARTHUR South Africa 2 hrs. 36 min. 54⁴/₅ sec.
2. C. W. GITSHAM South Africa 2 hrs. 37 min. 52 sec.
3. G. STROBINO U. S. A. 2 hrs. 38 min. 42²/₅ sec.

Not placed :

A. Sockalexis	U. S. A.....	2.42. 7 ⁹ / ₁₀ .
J. Duffy	Canada.....	2.42. 18 ⁴ / ₅ .
S. Jacobsson	Sweden	2.43. 24 ⁹ / ₁₀ .
J. J. Callagher J:nr ..	U. S. A.....	2.44. 19 ² / ₅ .
J. Erxleben	»	2.45. 47 ² / ₁₀ .
R. F. Piggott	»	2.46. 40 ⁷ / ₁₀ .
J. Forshaw J:nr	»	2.49. 49 ² / ₅ .
E. Fabre	Canada.....	2.50. 36 ¹ / ₅ .
C. H. de Mar	U. S. A.....	2.50. 46 ³ / ₅ .
Boissière	France	2.51. 6 ³ / ₅ .
H. Green	Great Britain	2.52. 11 ² / ₅ .
W. Ch. Forsyth	Canada	2.52. 23.
L. Tewanima	U. S. A.....	2.52. 41 ² / ₅ .
H. Smith	»	2.52. 53 ⁴ / ₅ .
T. H. Lilley.....	»	2.59. 35 ² / ₅ .
A. Townsend	Great Britain	3.00. 5.
F. Kwieton	Austria	3.00. 48.
F. Lord	Great Britain	3. 1. 39 ¹ / ₅ .
J. Westberg	Sweden	3. 2. 5 ¹ / ₅ .
A. G. Simonsen	Norway	3. 4. 59 ² / ₅ .
C. Andersson	Sweden	3. 6. 13.
E. W. Lloyd.....	Great Britain	3. 9. 25.
H. P. Sakelloropoulos	Greece	3. 11. 37.
Hj. Dahlberg	Sweden	3. 13. 32 ¹ / ₅ .
I. Lundberg	»	3. 16. 35 ¹ / ₅ .
J. Christensen	Denmark.....	3. 21. 57 ² / ₅ .
O. Lodal	»	3. 21. 57 ³ / ₅ .
Ö. Karpati.....	Hungary	3. 25. 21 ³ / ₅ .
C. Nilsson	Sweden.....	3. 26. 56 ² / ₅ .
E. Rath	Austria	3. 27. 3 ⁴ / ₅ .
O. Osen	Norway.....	3. 36. 35 ¹ / ₅ .

As in the preceding Olympic Games, the Marathon Race of the Fifth Olympiad was run on a country road, but, on this occasion, both the start and the finish were in the Stadium, with the turn at the half distance.

The turn was on the high road, north of Stockholm, close to Sollentuna church. On the route between the Stadium and the turning point there were two control-stations, the first at Stocksund, about 3 miles (circa 5 kilometres) from the start, and the other at Tureberg,

9 miles (15 kilometres) from the Stadium. At Söderbrunn, between Stockholm and Stocksund, and at Silfverdahl, between Stocksund and Tureberg, there were arranged special stations, with medical attendants, sick-rooms, and ambulance carriages. The road was swept and put in good repair, and was watered, so that a part, at least, of the great amount of dust was laid. All wheeled traffic was forbidden along the route, for one hour before and one hour after the race. The start was on the running track immediately in front of the Royal box, and the competitors had to run a distance of 350 metres inside the Stadium before leaving it through the grand entrance towards Valhallavägen, and had to traverse the same distance along the running track again, when approaching the finish in front of the Royal lodge.

As in all the previous Marathon Races, there was an enormous amount of interest shown, and there were tens of thousands of spectators along the route, which was lined with rank upon rank of sight-seers all the way to the turn, most of whom had taken up their positions early in the morning in order to obtain a good view of the runners. The weather was oppressively warm, and it was evident that there would be many amongst the competitors that would have to retire before reaching the finish. Every measure of precaution had been taken, however, and nothing was omitted that could have been done to prevent accidents.

Every inch of space allotted to the spectators inside the Stadium was occupied, when the competitors in the Marathon Race, nearly all of whom had white linen hats or handkerchiefs on their heads as a protection against the great heat, began to assemble in front of the Royal box. It took no little time before they were got into line and had their names called over. When the roll-call was finished, it was found that no less than 68 runners were prepared to struggle for victory in the Marathon Race. The following is the list of the competitors entered :

Australasia:
Stuart Henry Poulter.

Austria:
Karl Hack.
Felix Kwieton.
Emerich Rath.

Bohemia:
Bohumil Honzatko.
Vladimir Penc.
Frantisek Slavik.

Canada:
James Joseph Corkery.
A. Decoteau.

James Duffy.
Edouard Fabre.
William Ch. Forsyth.
Geo H. Goulding.
Joseph Keeper.
John Lindsay Tait.

Chili:
Alphonso Sanches.

Denmark:
Johannes Christensen.
Olof Lodal.

Finland:
Aarne Kallberg.
Tatu Kolehmainen.

France:

Ben Ali Allel.
Bossière.
Jean Capelle.
Paul Coulond.
Gaston Heuet.
Jean Lespielle.
Henry Lorgnat.
Edmond Neyrinck.
Louis Pautex.
Ahmed Djebeila.

Great Britain:

Henry Frederick Bar-
r e t t .
James George Beale.
Charles Davenport.
George Joseph Day.
Septimus Francom.
Henry Green.
Henry George Kel-
laway.
Henry Arthur Lewis.
Edgar Williams Lloyd.
Fred Lord.
Arthur Townsend.
Samuel Raynes.

Greece:

Hercules P. Sakello-
ropoulos.

Hungary:

Ödön Kárpáti.
Henrik Ripám Jun.

Italy:

Nino Cazzaniga.
Orlando Cesaroni.
Carlo Speroni.
F. Ruggero.

Japan

Siso Kanakuri.

Norway:

Oscar Fonbaek.
Alfred August Nilsen.

Ole S. Olsen.
Otto Osen.
J:s Chr. Pedersen.
Axel G. Simonsen.

Portugal:

Mathias de Calvalho.
Francisco Lazaro.

Russia:

Nikolas Charkof.
Andrei Kapmal.
Alexandre Krache-
ninin.
Andreas Kruklin.
Michel Nikolsky.
Nicolai Rasso.
Elmar Reimann.
Joseph Saitzeff.
Alexandre Upmal.
René Wilde.

Servia:

Dragutin Tomasche-
vitsch.
Zivko Vastitsch.

South Africa:

Christopher W. Gits-
ham.
K. K. Mc Arthur.
Leonard Richardson.
A. C. C. S:t Norman.

Sweden:

A. Ahlgren.
C. Andersson.
T. Bergvall.
Hj. Dahlberg.
W. Grüner.
D. Guttman.
Sigge Jacobsson.
I. Lundberg.
I. Lönnberg.
G. Törnros.
J. Westberg.
C. Nilsson.

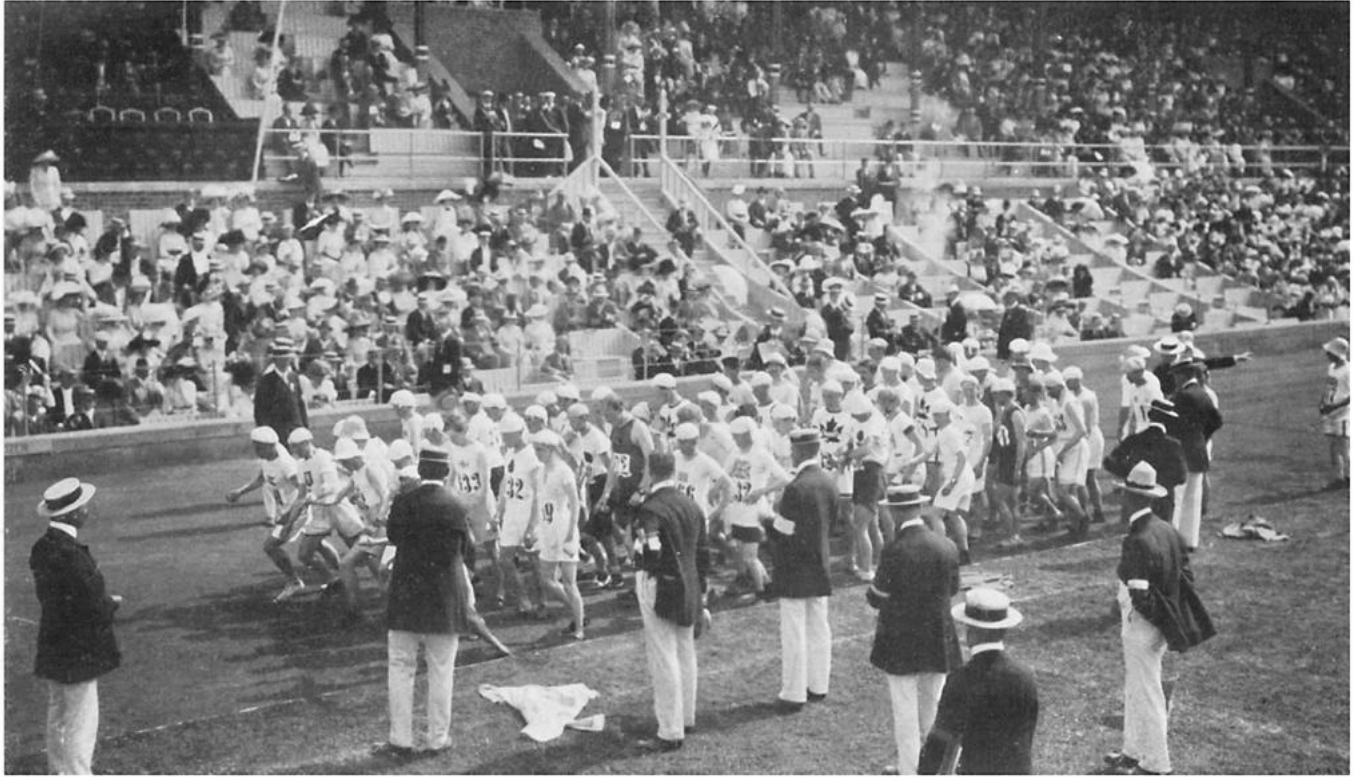

THE START FOR THE MARATHON RACE.



THE MARATHON RUNNERS LEAVE THE STADIUM.



K. K. MC ARTHUR, South Africa, at the Entrance of the Stadium.



MARATHON RACE. K. K. MC ARTHUR, South Africa, winner.



MARATHON RACE. C. W. GITSHAM, South Africa, 2nd Man.

U. S. A.:

Joseph Erxleben.
Joseph Forshaw, J:nr.
J. J. Gallagher, J:nr.
Thos. H. Lilley.
Clarence H. de Mar.

Richard Francis Piggott.
John James Reynolds.
Michael J. Ryan.
Harry J. Smith.
Andrew Sockalexis.
Gaston Strobino.
Lewis Tewanima.

Of these, the following did not start:

B. Allel (France), J. Capelle (France), M. de Carvalho (Portugal), N. Cazzaniga (Italy), O. Cesaroni (Italy), N. Charkoff (Russia), P. Coulond (France), C. Davenport (Great Britain), G. Day (Great Britain), A. Decoteau (Canada), A. Djebelia (France), G. Goulding (Canada), G. Heuet (France), J. Keeper (Canada), A. Kracheninin (Russia), J. Lespielle (France), H. A. Lewis (Great Britain), H. Lorgnat (France), E. Neyrinck (France), M. Nikolsky (Russia), A. Nilsen (Norway), O. Olsen (Norway), J. Pedersen (Norway), S. Raynes (Great Britain), L. Richardson (South Africa), J. Saitzeff (Russia), A. Sanchez (Chili), J. Tait (Canada), Z. Vastitsch (Servia), R. Wilde (Russia).

By 1.48 p. m. everything was clear for the start, and, amid the cheers of the spectators, the 68 competitors swung round the curve and along the straight in the Stadium at a good pace. Ahlgren, a Swede, went to the front at once, closely followed by Tatu Kolehmainen, a brother of Hannes Kolehmainen. On leaving the Stadium and turning sharply to the right along Valhallavägen, Ahlgren was still leading the field, the pace being a very lively one, all the runners appearing anxious to keep in touch with the leaders. Ahlgren kept in front for the first couple of kilometres, (about a mile and a quarter), closely followed by Kolehmainen, with the Italian Speroni, the Frenchman, Boissière, and the two South Africans, Gitsham and Mc Arthur, next.

The first control station (Stocksund; 3 miles, or 5 kilometres), was passed at 2.17.20 p. m., by Kolehmainen, Ahlgren and Speroni, no difference in time between these three being noted. About 10 metres behind the leaders came Boissière (France), and the two South African representatives, Gitsham and Mc Arthur, who were dressed in green; these three men being in a bunch. Then followed at varying intervals and at the *hour* given:

L. Pautex.....	2.17.39	G. Törnros.....	2.18.10
S. Franconi.....	2.17.39	S. Jacobsson	2.18.10
F. Lord	2.17.39	C. Nilsson	2.18.10
O. Fonbaek.....	2.17.54	Hj. Dahlberg.....	2.18.10
A. Kruklin	2.17.54	C. Andersson.....	2.18.10

There were a good many Swedes among the first twenty, and they had apparently made up their minds not to let the leaders run away from them, but the weather was broiling hot and it was to be expected that the heat would gradually begin to affect the men from the north, unaccustomed as they were to such tropical warmth as prevailed on the day of the race. Still, Kolehmainen kept up the pace,

kilometre after kilometre, amid the heat and dust, with the greatest energy, and for a long time Ahlgren followed stubbornly at his heels, but, before Tureberg (9 miles; 15 kilometres), the second control station, was passed, the Swede had to let the Finlander leave him, Kolehmainen running alone for 14 or 15 kilometres (about 9 miles). After the first six miles (10 kilometres), the South Africans had come on more and more, so that at the 14th kilometre (not quite 9 miles), Mc Arthur and Gitsham lay next to the Finlander, with Lord (G. Britain) fourth, Ahlgren now fifth, and another Swede, Jacobsson, about 30 metres behind his compatriot.

As already stated, Tureberg, which lay about 9 miles (15 kilometres) from the start, was passed first by Kolehmainen, at 2.42.19 p. m. and 13 seconds later the two South Africans were at the control station, too. Those of the field that were leading were very careful, during the first part of the race, at least, to abstain from all refreshments, of which there was a plentiful supply at all the control stations, but those competitors that had fallen behind drank their fill at every station, and there were many who retired from the race when only Tureberg was reached, their number increasing more and more the nearer they approached the turn. At Tureberg, Kolehmainen appeared to be in the very best condition, and it was generally thought that, if he could stand the heat, he would come in first. It proved, later on, that the warmth was too much for him. The leaders passed Tureberg at the following hour (N. B. Not *time run.*):

T. Kolehmainen	2.42.19	Boissière	2.44.28
K. K. Mc Arthur.....	2.42.32	L. Pautex.....	2.45.50
C. W. Gitsham.....	2.42.32	O. Fonbaek	2.46.03
F. Lord	2.43.10	J. Ryan	2.46.18
A. Ahlgren.....	2.43.36	C. Andersson.....	2.46.23
S. Jacobsson	2.44.03	T. Bergvall	2.46.24
C. Speroni.....	2.44.17		

From the 15th to the 20th kilometre (9th — 12th mile), and onwards to the turn at Sollentuna, the relative positions of the ten leading men remained much about what they had been at Tureberg, the second control station, with the exception that Gitsham passed Kolehmainen and rounded the turn-point first, it then being 3.00.40 p. m. the Finnish runner, who was scarcely 25 metres behind the South African, passing the turn at 3.00.55 p. m.

Then came at the hour shown:

K. K. Mc Arthur.....	3. 1.15	L. Tewanima.
F. Lord	3. 2.30	G. Strobino.
C. Speroni	3. 2.55	A. Sockalexix.
A. Ahlgren	3. 3.43	J. Erxleben.
S. Jacobsson.		C. Andersson.
J. J. Corkery.		T. Bergvall.
H. Smith.		H. Green.
M. J. Ryan.		J. Duffy.
R. F. Piggott.		T. H. Lilley.

Neither the South Africans nor the Finlander gave themselves the time to take any refreshments or to wash off the dust at the turn, but continued at once. The Italian, Speroni, who rounded the turn fifth, took a mouthful of water and had a pailful of water poured over him, most of the men who came after him following his example. There was a tremendous demand for water, lemonade, tea, etc.

The leaders now had their faces turned towards the goal, the Stadium, but the distance that still remained to be covered, proved to be one of unheard-of difficulty. Gitsham worked like a giant to shake off the stubborn Finlander, but the latter and Mc Arthur hung at the heels of the leader like his shadow. On the return journey, the order of the five leading men remained pretty nearly unaltered, but there were many changes amongst the remainder, for a great number of those that had, at first, been very well placed, now fell more and more to the rear, new men taking their places. The Indian, Tewanima, for example, closed in more and more on the leaders, and while, during the latter part of the outward run, he had lain about the middle of the team, he now came forward to the seventh place. Another U. S. A. man, Sockalexix, neared the leaders more and more; Ahlgren, on the other hand, seemed to have had quite enough of it, and began to drop to the rear.

The first to pass Tureberg on the way home were Gitsham and Kolehmainen, who here lay side by side, with Mc Arthur one or two metres behind them. Nearest to this group came the Italian, Speroni, who was running with the greatest energy, and was only 16 seconds behind the leaders. The Swede, Jacobsson, had now placed himself fifth, and the control-station was next passed by Lord, the first of the representatives of Great Britain.

The order in which the best men passed Tureberg was as follows (the figures show the *hour*):

C. W. Gitsham.....	3.22.40	Boissière	3.29.40
T. Kolehmainen	3.22.40	A. Sockalexix	3.30.04
K. K. Mc Arthur	3.22.41	J. J. Corkery.....	3.30.13
C. Speroni	3.22.56	J. Erxleben.....	3.30.18
S. Jacobsson	3.26.10	A. Ahlgren.....	3.30.40
F. Lord	3.26.24	J. Duffy	3.30.40
R. F. Piggott.....	3.27.31	T. H. Lilley	3.30.40
L. Tewanima.....	3.28.49	H. Green.....	2.30.41
G. Strobino.....	3.29.02	J. J. Gallagher, Jr....	3.30.51
H. Smith.....	3.29.15		

One could have expected the pace to become much quieter towards the close of the race, but this was not at all the case. The South Africans, who, the nearer they came to the end of their task, seemed to get into a finer swing than ever in spite of the intense heat, kept up a good pace, and, when the leading group were between Tureberg and Stocksund, the moment at length came when Kolehmainen had to resign the lead which he had held nearly the

whole of the distance. He was quite run out, and was obliged to retire from the contest. It was now the turn of Gitsham and Mc Arthur to run in company for the next 4 kilometres (2½, miles), the South Africans being followed by Strobino (U. S. A.), who, at the beginning of the race had lain pretty far behind, but had now worked almost to the front. Sigge Jacobsson (Sweden), had still further improved his position and was placed fourth. After the leaders came a long string of U. S. A. runners, who, thanks, as it seemed, to the wonderfully fine training they had received, were less affected by the heat than most of the other competitors.

Stocksund, the last control station before reaching the Stadium, was passed by the leaders in the following order, and at the *hour* given:

C. W. Gitsham..... 4. 2.20	C. Speroni 4. 9.17
K. K. Mc Arthur..... 4. 2.20	L. Tewanima..... 4.10.00
Then came G. Strobino, with	A. Sockalexis..... 4.10.42
S. Jacobsson 1 ½ minute after	J. Erxleben..... 4.11. 2
the U. S. A. runner.	J. J. Gallagher, Jr... 4.11.17
These were followed by:	T. H. Lilley 4.12.50
J. Duffy 4. 9.17	R. F. Piggott..... 4.13. 7

F. Lord (G. Britain), who had been well to the fore at Tureberg, had now fallen back.

Inside the Stadium the excitement was intense. The public had followed with the greatest eagerness the publication of the times and other information respecting the relative positions of the runners, that was sent in from the control stations. Only a few minutes had elapsed from the time when a herald, armed with a megaphone, had stated that the South Africans were leading, followed by a representative of the U. S. A., and with a Swede fourth, when the blowing of a horn at the grand entrance towards Valhallavägen informed the waiting multitude that the first Marathon runner was approaching. Down the hilly country road lying north of the Stadium there came at an easy trot a green-clad figure which, at the next glance, was seen to be that of Mc Arthur, who, at the very close of the race, had managed to go away from Gitsham. Mc Arthur was evidently pretty well "pumped out", but it was equally clear that he had all his wits about him and was still running with judgment. He seemed to be afraid lest Gitsham should be at his heels, however, and kept looking behind him, to try and catch sight of his rival. Someone in the crowd told him that the other South African was five minutes in the rear, and then Mc Arthur grew calmer, and ran the last 100 metres at a very gentle pace before entering the Stadium gateway, evidently in order to man himself for the reception he could be sure was awaiting him when he entered the Stadium as the victor in the Marathon Race of the Fifth Olympiad.

As was quite natural, the greater part of the public assembled within the walls of the Stadium had been hoping to see a Swede come in as first man, but when, finally, these hopes were dashed to



MARATHON RACE. G. STROBINO, U. S. A., 3:rd Man.



MARATHON RACE. SIGGE JACOBSSON, Sweden, Best European.



WALKING RACE 10,000 M. G. H. GOULDING, Canada, winner.



WALKING RACE 10,000 M.

the ground, the feeling of disappointment that, for one instant, came over them, did not prevent them from greeting the victor with the warmest, the most unbounded applause, as, with the Marathon wreath around his breast, Mc Arthur broke the tape amid the indescribable shouts and cheering of the multitude. As soon as he had passed the post he flung himself on the grass, and the doctors present hastened to give him all necessary attention.

The victor was, probably, less overcome with fatigue, however, than by the excessive mental strain under which he had run the last part of the course. For scarcely had Mc Arthur come to the curve of the running track, just before arriving at the winning post, than the other South African was seen passing through the grand entrance. It was Gitsham, who, almost in better condition than the victor, came in second, and ran round the track, greeted with thunders of applause. After Gitsham came Strobino, U. S. A., who was in relatively good condition, too. After the three prize winners had passed the post, there was an interval of some minutes, after which Sockalexis, another U. S. A. man, came running down the track, in the best of humour, although evidently somewhat tired by the run.

Duffy (Canada), the fifth man, appeared to be in equally good humour, and passed the post with a smiling face. The sixth man was a Swede, Sigge Jacobsson, the first European runner to come in. He ran in his usual economical way, and went on to the finish without the least change of expression as he broke the tape, but complained of the galls his new running-shoes had caused him. Then, at intervals of longer or shorter duration, came a long row of runners, who all ran to a finish, there being no painful scene *within* the Stadium at the close, as there had been in London in 1908. Along the route, unfortunately, matters were different.

As can easily be imagined on reading the account of the weather that prevailed during the race, there was a large number of the competitors that did not finish. Only a few hundred metres past Tureberg, Törnros, the Swede who had been fourth man in the Marathon race at the Games in Athens in 1906, was obliged to retire on account of headache, and, altogether, the proportion of competitors who did not finish, was a very large one. The medical attendants and ambulances stationed on the route had a most trying time, going along the road to pick up the many competitors who, for one reason or another, were obliged to fall out of the race.

As might have been feared, the Marathon Race of the Fifth Olympiad was not to be run with impunity beneath the rays of an almost tropical sun, and several of the 68 competitors suffered very greatly from the heat. One poor fellow, indeed, who had started in the best of health, was struck down by the sun and never recovered. This was the Portuguese, Lazaro, who, after having covered the greater part of the distance in the best condition, suddenly staggered and fell, and, after being attended to by the medical men who were immediately called to the spot, was taken to the Seraphim Hospital.

There the doctors did their utmost for the unfortunate man, no means for his restoration being left untried. All these efforts were in vain, however, and Lazaro died early on Monday morning. The news of his death was received with the greatest sorrow by all the athletes gathered at Stockholm, and, in Swedish athletic circles, especially, it cast a gloom over the remainder of the Games. Immediately after the conclusion of the Games, and on the initiative of the leaders of the Swedish athletic world, there was held in the Stadium a special

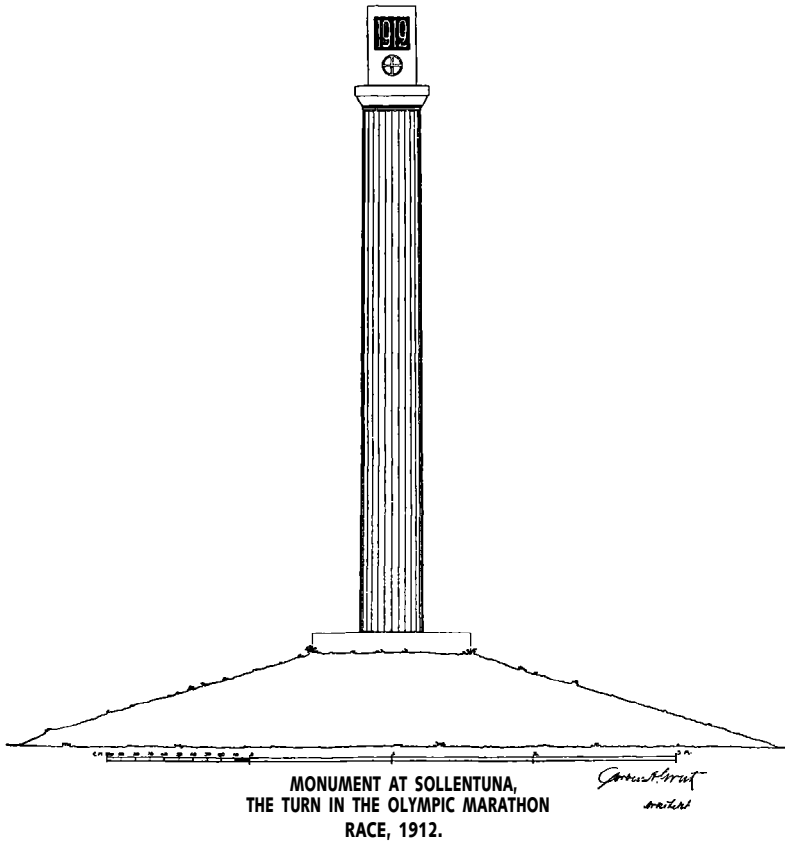

display, for the benefit of Lazaro's family, which produced about Kr. 14,000 (L. 770 \$ 3,850).

Apart from this deplorable incident, the shadow of which still lies over the Marathon Race of the Fifth Olympiad, the event was carried to a successful issue, in spite of the unheard-of heat prevailing on the day of the contest.

The Swedish Olympic Committee having entertained the wish to perpetuate the memory of the Marathon Race of 1912, by raising a monument at Sollentuna, where the runners turned back to Stockholm in the race, Mr. Jaeger, Director of the Swedish Granite-Industry Com-

pany, very kindly presented a column for the purpose, consisting of a ready-hewn monolith of the finest black granite, and as Mr. Grut, the architect of the Stadium, has presented the Committee with the composition and drawings for the monument in question, the only expense to be incurred will be that of the erection of the stone.

There is shown above a projection of the simple, yet striking memorial, which has the form of a fluted Doric column, supporting an oblong block of stone with an inscription. On the front of the stone there is a cross, with the date, 1912, above, and on both sides is the word "Marathon". On the back there is the word "Vändpunkten" (The Turn). The monolith, as stated above, is of fine hewn, black granite, and is about 7 metres (22 ft.) high. The stone is from the Gylsboda Quarries in North Scania, Sweden and its value about Kr. 1,000 (£ 55: \$ 220), exclusive of the cost of the inscription.

WALKING RACE, 10,000 METRES.

First Round.

Monday, 8 July.

First heat. 1. (G. H. GOULDING, Canada **47.14⁵/₁₀**; 2. E. J. WEBB, Great Britain, **47.25³/₅**; A. RASMUSSEN, Denmark, **48.15⁴/₅**; F. ALTIMANI, Italy, **48.54¹/₅**; 5. W. J. PALMER, Great Britain, 51.21. Not placed: S. Schwartz, U. S. A., 53.30 ⁴/₅, and E. Renz, U. S. A., 53.3⁵/₆. Also started but did not finish: R. Richter, Bohemia, and K. Lukk, Russia. — Monday's competitions were begun by the first heat in the walking-race. Goulding, the Canadian, at once took the lead, closely followed by Webb, the old walking champion. After two laps had been covered, Rasmussen came to the front for a while, but soon fell back again. Then Goulding and Webb led alternately and, accompanied by Rasmussen and Altmani, drew away from the remainder of the field. Rasmussen once more got the lead, but Goulding then increased his speed, still preserving the most correct style. The Canadian walked beautifully, though Webb appeared to be going stronger; then the bell rang, Goulding began his spurt, and Webb was unable to hold the leader. Goulding won by 50 metres; Webb, who was second, being 150 metres in front of Rasmussen.

Second heat. 1. W. G. YATES, Great Britain, **49.43⁸/₅**; A. C. ST. NORMAN, South Africa, **50.17⁹/₁₀**; 3. T. H. DUMBILL, Great Britain **50.57⁸/₅**; V. E. GYLCHÉ, Denmark, **51.13⁴/₅**; F. H. KAISER, U. S. A., .37⁴/₅; Not placed: A. Voellmeke, U. S. A., **52.29¹/₅**; R. Salinas, Chili, **55.02**; H. Ripszám, Hungary, **55.20⁹/₅**; A. Ayde, Russia, **59.24²/₁₀**. Also started: W. Murray, Australasia; N. Pedersen, Denmark; R. Bridge, Great Britain and I. Drubina, Hungary. — 13 started in this heat, the pace being made at first by Drubina (Hungary). Gylche and Pedersen soon went forward, however, and passed Drubina, but then Bridge and Yates (G. Britain) relegated Gylche to third place after a few laps. Later on, Bridge was disqualified for unfair walking. Yates was now alone and, going strongly and in perfectly correct style, left the rest of the field more and more behind. Norman improved his position and was placed second. The South African walked with very great energy, but his style was not always above reproach.

Final.

Thursday, 11 July.

1. G. H. GOULDING Canada 46.28²/₅.
2. E. J. WEBB Great Britain, 46.50²/₅.
3. F. ALTIMANT Italy 47.37³/₅.

Not placed :

- A. Rasmussen Denmark 48 min.

As soon as the pistol was fired, Webb (Great Britain) at once took the lead, followed by Gylche (Denmark), Goulding (Canada), and St. Norman (South Africa) in the order named. After one lap had been covered, these four men formed a group by themselves; but the Dane soon left it, falling back to the second party which consisted of Dumbill, Yates and Altimani. Goulding and Webb kept their companion in the first group pretty warm, by the tremendous pace at which they went, and, before the lapse of any great length of time, St. Norman also found himself obliged to part company with the leaders, in spite of his energetic attempts to keep up with them and still walk correctly. When half the distance had been covered, the South African was disqualified, however, in consequence of unfair walking, the same fate afterwards befalling Dumbill and Yates, and these three competitors became merely passive spectators of the latter part of the walking race. One after the other, Gylche, Kaiser and Palmer also left the track and, for the last few laps, there were only four competitors in the race. Towards the end, Goulding left Webb more and more behind, although the latter strove with the greatest energy to keep up with the speedy Canadian. Altimani (Italy), who walked with light, elastic steps, succeeded in retaining his place as third man during the whole of the latter part of the race, without being at all seriously threatened. The order now mentioned was retained when the winning-post was reached.

Jumping Competitions.

RUNNING HIGH JUMP.

First Round.

Sunday, 7 July.

All the competitors that cleared 183 metres were qualified for the final. Those that succeeded in doing so were: T. Carroll, Great Britain; B. H. Baker, Great Britain; J. o. Johnstone, U. S. A.; H. Liesche, Germany; I. Wardener, Hungary; E. R. Erickson, U. S. A.; H. J. Grumpelt, U. S. A.; G. L. Horine, U. S. A.; J. Thorpe, U. S. A.; A. W. Richards, U. S. A.; and K. Kullerstrand, Sweden. Not placed: J. W. Burdick, U. S. A., 180 cm.; H. B. Enight, U. S. A., 180 cm.; G. Hallberg, Sweden, 175 cm.; P. af Uhr, Sweden, 175 cm.; O. Monsen, Norway, 175 cm.; G. Olsen, Norway, 175 cm.; R. Sjöberg, Sweden, 175 cm.; O. Röhr, Germany, 175 cm.; A. Laine, Finland, 175 cm.; J. R. Labat, France, 175 cm.;

W. M. Oler, Jr., U. S. A. 175 cm.; O. A. Aarmaes, Norway, 175 cm. ; G. I. André, France, 170 cm.; R. Mattson, Sweden, 170 cm. ; A. Pagani, Italy, 160 cm.

The competition took place in three groups simultaneously, and began at 9 a. m. In consequence of the practical way in which the jumping-pits had been arranged, the round was soon finished. The Americans, of course, proved themselves the best men, but Horine was very clearly not in his finest form.

Baker was the best man in the first group, as he managed to clear every height at the first time of asking, while Johnstone showed some uncertainty when he came to the 175 cm. mark.

In the second group Grumpelt and Erickson were the safest men, while Horine, from carelessness perhaps, had to make a second try both at the 180 and 183 cm. marks. In the trial rounds, Liesche was not so good as in the final, while Wardener managed to clear the bar at each mark only with very visible effort.

In the third group, Thorpe, Richards and Kullerstrand jumped with unwavering confidence, all of them clearing 183 cm. with ease, while all the other competitors in this group had to stay out of the final.

Final.

Monday, 8 July.

1.	A. W. RICHARDS U. S. A.	193 cm.
	(Olympic record.)		
2.	H. LIESCHE Germany	191 »
3.	G. HORINE U. S. A.	189 »
	Not placed :		
	E. R. Erickson U. S. A.	187 »
	J. Thorpe »	187 »
	H. Grumpelt »	185 »
	J. Johnstone »	185 »
	K. Kullerstrand Sweden	183 »
	I. Wardener Hungary	180 »
	T. Carroll Great Britain	180 »
	B. H. Baker »	175 »

175 cm. proved to be too much for Baker, who did not seem to be in very good form, while at 180 cm., his countryman, lithe, little Carroll, and the equally little Hungarian, Wardener, also had to retire. Then the bar was raised to 183 cm., at which height both Johnstone and Richards had to make two tries, the other competitors clearing at the first time of asking. 185 cm. was too much for Kullerstrand, and he had to retire, in spite of three energetic attempts to clear the bar. Grumpelt made a careless, unsuccessful first attempt, but cleared easily at the second. Only Horine, Thorpe and Liesche managed to clear 187 cm. at the first trial, while Johnstone and Grumpelt missed in all three. With the bar at 189 cm., the German representative cleared first with wonderful litheness at his second try; Horine and Richards too, had to make a second attempt before they got over. Erickson and Thorpe had to retire at this height, Richards, Liesche and Horine thus being the three left in

for the placing. Liesche cleared 191 cm. with the greatest confidence, while Horine and Richards failed in their first try, and they knocked down the bar at the second attempt too, and when Horine failed for the third time, everybody looked for a win for Germany. Richards had one try left, however, and he knew very well what was at stake. He lifted his heavy body with enormous power across the bar, and landed in the pit after a safe clear. The final struggle between the U. S. A. and Germany took place at the 193 cm. mark. At his first attempt, Liesche fell right on the bar, while Richards cleared. The German was too nervous to be able to do anything in his last two tries, and being unable to pull himself together, had to be content with second place.

STANDING HIGH JUMP.

First Round.

Saturday, 13 July.

P. Adams, U. S. A. ; E. Möller, Sweden ; B. W. Adams, U. S. A. ; C. Tsiclitiras, Greece; R. L. Byrd, U. S. A. ; L. Goehring, U. S. A., all cleared 150 cm. ; L. Ekman, Sweden, G. I. André, France, R. Smedmark and K. Bergh, Sweden, and F. Fletcher and F. W. Belote, U. S. A., all cleared 145 cm. ; A. Schwarz, Russia, R. Hammersley, Chili, and B. Brodtkorb, Norway, all cleared 140 cm., while B. H. Baker, Great Britain, could not get above 135 cm.

The trial heats began at 9.30 a. m., the weather even at that early hour being oppressively hot. As the number of competitors was considerably less than the number of entries, the three groups originally made were formed into one.

Even at the lowest marks it could be seen that the struggle would lie between the brothers Adams and the Greek Tsiclitiras. The regulation had been made that only those competitors who cleared 150 cm. in the trial rounds should take part in the final, and the height in question was cleared by 6 men. The first man, Baker, the British representative, was out of it at 135 cm., and three other competitors had to retire at 140 cm. Three more failed at 145 cm., this height afterwards proving to be the maximum for the three Swedish representatives, Bergh, Ekman and Smedmark; the Frenchman, André, and Fletcher and Belote, two competitors from the U. S. A. Four Americans, one Greek, and Möller, a Swede, were left in for the final.

Final.

Saturday, 13 July.

1. PLATT ADAMS	U. S. A.	163 cm.
2. BEN ADAMS	U. S. A.	160 »
3. C. TSICLITIRAS	Greece	155 »
Not placed :		
E. Möller	Sweden	150 »
R. L. Byrd.	U. S. A.	150 »
L. Goehring	»	150 »

To begin with, the bar was put at the 130 cm. mark, which was cleared without difficulty by all the competitors. The 140 cm. mark

was no great obstacle to any of the competitors with the exception of Goehring who, at his first attempt, fell right on to the bar and was obliged to make a second attempt. At 145 cm. no one missed at the first time of asking, and it was not before the 150 cm. mark was reached that any of the jumpers had to retake the jump, the Greek and Byrd being obliged to make a second attempt before they could go on to the next mark. The real difficulties began at 155 cm., a height which was too much for three men, Byrd, Goehring and Möller, while the brothers Adams and Tsiclitiras all cleared the bar. 160 cm. was taken by Ben Adams at his first attempt, and by his brother Platt at the second, but Tsiclitiras could make nothing of his three attempts and so had to be satisfied with third place. Ben Adams was unable to clear more than 160 cm., but Platt Adams, with a grand jump, cleared the 163 cm. mark, thus winning the event. An attempt he made to take 166 cm. was quite unsuccessful.

Running Broad Jump.

Friday, 12 July.

1. A. L. GUTTERSON	U. S. A.....	760 cm.
(Olympic record.)		
2. C. D. BRICKER	Canada.....	721 »
3. G. ÅBERG	Sweden.....	718 »
Not placed :		
H. T. Worthington	U. S. A.....	703 cm.
E. L. Mercer	»	697 »
F. H. Allen	»	694 »
J. Thorpe	»	689 »
R. Pasemann	Germany	682 »
F. Irons	U. S. A.....	680 »
H. S. O. Ashington.....	Great Britain.....	678 »
R. F. Bie	Norway	675 »
S. S. Abrahams	Great Britain.....	672 »
N. Fixdal	Norway	671 »
E. L. Farrell	U. S. A.....	671 »
P. C. Kingsford	Great Britain.....	665 »
A. Campana	France	664 »
C. Lomborg	Sweden	662 »
V. Franzl	Austria	657 »
A. Tonini	Italy	644 »
P. Ohlsson.....	Sweden	628 »
B. Betzén	»	624 »
A. Choultz.....	Russia	615 »
P. Ehrnreich	Austria	614 »
E. Kukkola	Finland	611 »
P. Szalai	Hungary	598 »
M. Kovács	»	596 »
A. Pagani	Italy	595 »
A. Maranda	Canada	587 »
M. Legat	Italy	550 »

The great number of competitors made it necessary to arrange for their jumping in three groups.

Irons began the work in the first group with a jump of 680 cm., but this was immediately beaten by his countryman, Allen, with 694 cm. Then came a

Swede, Åberg, with a fine 704 cm., but he, too, was relegated to the background by another U. S. A. man, Gutterson, who made a phenomenal jump of 760 cm. Amongst the other competitors in this group, Pasemann (Germany), was the only one that was at all dangerous, he clearing 682 cm., the remainder staying at about 620 cm. or even below that figure. At the second attempt, none of the favourites in this group succeeded in improving their figures, Åberg reaching only 670 cm., and Gutterson having to be satisfied with 748 cm., Pasemann this time reaching 680 cm. The third attempt made no change in the placing either, although Åberg this time managed to reach 699 cm., while Gutterson fell to 725 cm. The best three in this group, therefore, were Gutterson, Åberg and Allen, in the order named.

In Group 2, there were several clever jumpers from the U. S. A., and it was generally expected that Gutterson would be the only man from Group 1 that would qualify for the final. Mercer, U. S. A., began with a jump of 697 cm., and was followed by the British representative, Abrahams, with 672 cm., Bie, the Norwegian, in his first try, reaching 675 cm. Bricker, the Canadian representative, was the one that jumped best in this group, reaching 692 cm. at his first attempt. Lomberg could do no better than 644 cm. at his first try, while Fixdal, Norway, jumped 671 cm. At the second attempt, Bricker improved his figures to 707 cm., thereby taking the lead in this division and gaining second place in the trials. Ashington, Great Britain, came on to 678 cm., which gave him third place in the group, this figure being by no means good enough to rob Mercer of second place. The third trial in the series did not alter this state of things, although Bricker succeeded in making a fine jump of 721 cm.

In the third and last group, Farrell, one of the U. S. A. representatives, jumped first, reaching 671 cm. Thorpe, the Indian, reached 667 cm., while his countryman, Worthington, made a good first jump of 703 cm. The second and third trial jumps in this group did not alter the final result, although Thorpe, at the second time of asking, reached 689 cm. The result of the first round, therefore, was that Gutterson, U. S. A., Bricker, Canada, and Åberg, Sweden, qualified for the final.

Of these three competitors, Åberg jumped first and started with 698 cm. Gutterson, who came next, reached 718 cm. while Bricker managed to clear 704 cm. In the second trial in the final, Åberg made his best effort, reaching 718 cm., while Gutterson continued his decline and could do no better than 709 cm., Bricker reaching 685 cm. Everybody believed that Åberg, who was doing better and better nearly every time he jumped, would finally succeed in passing the Canadian, but nothing came of it as, in his last try, the Swede made a bad run and could jump no farther than 663 cm., while Gutterson still kept at 709 cm. The final round, therefore, made no alteration in the placing of the three competitors as decided by the result of the trials.

STANDING BROAD JUMP.

Monday, 8 July.

1.	C. T SICLITIRAS	Greece	337 cm.
2.	PLATT ADAMS	U. S. A.	336 »
3.	B. W. ADAMS	U. S. A.	328 »
	Not placed :		
	G. Malmsten	Sweden	320 cm.
	E. Möller	314 »
	L. Goehring	U. S. A.	314 »

A. Baronyi	Hungary	313	cm.
R. L. Byrd	U. S. A.	312	»
F. Fletcher	»	311	»
A. Motte	France	310	»
G. Ljunggren	Sweden	309	»
B. Brodtkorb	Norway	305	»
R. Ekberg	Sweden	303	»
D. Melin	»	302	»
H. S. O. Ashington	Great Britain	302	»
C. I. André	France	302	»
A. Maranda	Canada	298	»
K. Bergh	Sweden	295	»
P. C. Kingsford	Great Britain	275	»

The competitors taking part in this event were divided into four groups, but only the best three men, irrespective of the groups in which they had competed, were to be entitled to take part in the final round. Judging by the results of the jumping as the competition went on, it seemed pretty evident that the victors were to be looked for in the Greek, Tsiclitiras, and the two brothers, Adams, from the U. S. A. The event justified this assumption, and the struggle that took place between these three men was a most exciting one.

In the first group, Platt Adams had the best figures, 332 cm., made at his third attempt. The nearest man to him in this group was the Frenchman, Motte, with 310 cm. obtained in the second trial.

In the second group, the results were better, some of the aspirants here, too, belonging to the dangerous class. F. Fletcher, U. S. A., managed to make a jump of 311 cm., and led at first with these figures. Close behind him there was a Swede, Ljunggren, with 309 cm. Last of all came Ben Adams, who made 328 cm. in his first jump — his best, too, as his second and third efforts (321 cm., and 324 cm.) were some centimetres worse than the first figures.

In the third group, Tsiclitiras began with a jump of 314 cm., a distance which, at his second attempt, was increased to 326 cm., and, at the third, to 337 cm.

In the fourth group, Malmsten, a Swede, was the best man, clearing 320 cm., a result that gave him fourth place in the competition as a whole.

The following competitors thus qualified for the final: Tsiclitiras, Greece; Platt Adams and Ben Adams, U. S. A. Platt Adams began the jumping in the final with a perfectly executed 336 cm., while Ben Adams could do no better than 318 cm. During the final, Tsiclitiras was very nervous, and could not manage to clear the distance he had done at his third attempt in the trial round. His first jump now, measured 330 cm. Platt Adams, in his second try, cleared 334 cm., and his brother and the Greek competitor, 324 cm. At the third and last try, Platt made an energetic but vain attempt to clear the two additional centimetres that separated him from victory, and Tsiclitiras, with his 337 cm., reached in the trial round, retained pride of place as first man.

HOP, STEP AND JUMP.

Monday, 15 July.

1. G. LINDBLOM.....	Sweden	14.76	metres
2. G. ABERG	»	14.51	»
3. E. ALMLÖF	»	14.17	»

Not placed :

E. Winne	Norway	14.14	metres
P. Adams	U. S. A.	14.09	»
E. Larsen	Norway	14.06	»
Hj. Ohlsson	Sweden	14.01	»
N. Fixdal	Norway	13.96	»
Ch. Brickley	U. S. A.	13.88	»
G. Nordén	Sweden	13.81	»
J. Halme	Finland	13.79	»
I. Lindholm	Sweden	13.74	»
E. Farrell	U. S. A.	13.57	»
O. Bäurle	Germany	13.52	»
P. Ohlsson	Sweden	13.45	»
G. Kröger	Austria	13.33	»
S. Jacobsson	Sweden	13.33	»
C. D. Bricker	Canada	13.25	»
T. Carroll	Great Britain	12.56	»
A. Maranda	Canada	12.53	»

The competitors were divided into three groups, but, as several of the men entered did not put in an appearance, there were comparatively few in each division. The trials in the first group were begun by the Finnish representative, Halme, with a fine effort measuring 13.79 metres, he being followed by Carroll, Great Britain, who did nothing at his first attempt, however. P. Adams, whom a great many expected would be the victor, succeeded in his first try in reaching no more than 13.72 metres, and Åberg, who came immediately after the U. S. A. representative, cleared 13.58 metres. Another Swede, Hj. Ohlsson, was the last in this group, and at his first attempt, he managed to make his best figures, 14.01 metres. At the second time of asking, Halme could not improve his position, but Adams reached 14.09 met., while Åberg came on to 13.90 met. Ohlsson did not succeed in beating his earlier distance, but had to be contented with the 14.01 met. as his best. In the third jump in the trial, Adams was altogether a failure, but Åberg, who managed to make a grand run and to get a fine upward leap, placed himself first with 14.51 metres. The placing of the leading competitors in Group 1, at the close of the first round, was, therefore: Åberg 14.51 metres, Adams 14.09 metres and Ohlsson, 14.01 metres.

The number of competitors in the second group was considerably greater. The Norwegian representative, Larsen, who had been third man in this event at the Olympic Games of London, 1908, began in this group, and made a jump of 13.27 metres, a figure that was at once beaten by Jacobsson with 13.33 metres. This, in its turn, was put into the background by Nordén, Sweden, with a jump of 13.81 metres, and then came Lindblom, another Swede. In initiated circles, Lind-

blom had been thought of as a possible victor, but hardly anyone imagined him capable of doing so finely as he did. He was evidently in his very best form, however, and managed to get a fast run, in addition to which, he succeeded in making the very most of his leaps, and, on these being measured, it was found that he had cleared 14.74 metres. After him came the Canadian jumper, ricker, who reached 13.25 metres; Almlöf, Sweden, failed altogether in his first try, but a Norwegian, Fixdal, covered 13.96 met. — At the second attempt in the series, Larsen came on to 13.90 met., and Lindblom, to everybody's surprise, put on another two centimetres, this second effort, his best, measuring no less than 14.76 metres. Almlöf got a good run this time, it is true, but he could make nothing of his leaps, and did no more than 13.46 met. The third jump in the trial resulted in Larsen managing to reach 14.06 met., but these figures were not good enough to entitle him to a place in the final. Neither did Lindblom succeed in improving his figures, his third jump measuring 14.20 met., while Almlöf cleared 14.17 met. and qualified for the final.

In the third and last group, there was only one man that passed the 14-metres mark, the Norwegian representative, Winne. The next best was Brickley (U. S. A.) who, in his best jump, made at the first attempt in the trial, cleared 13.83 metres, and he was followed by Lindholm, Sweden, with 13.74 metres.

The result of the trial series, therefore, was that the first three places were occupied by Swedes, so that the final resolved itself in a national competition for the prizes in this event.

The final, however, made no difference in the respective positions of the three men; Åberg made only one fair jump, measuring 14.03 metres; Lindblom's second attempt was one of 14.35 metres and the third 14.32 metres, while Almlöf's second and third jumps measured 13.85 and 14.10 metres, respectively.

POLE JUMP.

First Round.

Wednesday, 10 July.

The following competitors qualified for the final, all of them clearing 365 centimetres: F. T. Nelson, U. S. A.; R. Pasemann, Germany; B. Uggla, Sweden; H. S. Babcock, U. S. A.; W. Happenny, Canada; G. B. Dukes, U. S. A.; M. S. Wright, U. S. A.; F. D. Murphy, U. S. A.; S. H. Bellah, U. S. A.; W. H. Fritz, Jr., U. S. A. and F. J. Coyle, U. S. A.

Did not qualify: R. Sjöberg, Sweden, 360 cm.; K. Gille, Sweden, 360 cm.; C. Hårleman, Sweden, 360 cm.; F. Gonder, France, 350 cm.; F. B. Wikke, Denmark, 340 cm.; U. Baasch, Russia, 340 cm.; H. Svensson, Sweden, 320 cm.; S. Santesson, Sweden, 320 cm.; M. Nilsson, Sweden, 320 cm.; G. Banikas, Greece; 320 cm.; J. Jirsak, Bohemia, 300 cm.; V. Franzl, Austria, 300 cm.; M. Legat, Italy, 300 cm.

All those left in for the final had jumped with the greatest confidence, and a most interesting finish was expected.

Final.

Thursday, 11 July.

1. H. S. BABCOCK U. S. A. 395 cm.
(Olympic record.)
2. F. T. NELSON and M. S.
WRIGHT U. S. A. 385 »
3. W. HAPPENNY, Canada, D. MURPHY,
U. S. A., and B. UGGLA, Sweden 380 »

Not placed :

- | | | |
|----------------------|---------------|---------|
| S. H. Bellah | U. S. A. | 375 cm. |
| G. B. Dukes | » | 365 » |
| F. J. Coyle | » | 365 » |
| W. H. Fritz, Jr..... | » | 365 » |
| R. Pasemann..... | Germany | 340 » |

Eleven men had qualified for the final. Of these, eight were representatives of the U. S. A., while there was one Canadian, Happenny, one German, Pasemann, and one Swede, Uggla. To begin with, the bar was placed at a height of 340 cm., which was cleared without difficulty by all the competitors. Pasemann, who did not seem to be in good form, failed at 350 cm. while the Canadian and a couple of the U. S. A. men, had to make two attempts before they cleared the bar at this height. When another 10 cm. had been added, it became a more difficult task for several of the competitors to clear at the first time of asking, and it was only Uggla and a couple of the American competitors who succeeded at the first attempt. At 370 cm. the bar was knocked down by one man after another, and when Uggla cleared it at his very first jump, he was the only one who had hitherto done so. At the second attempt, however, all of the competitors managed to clear the bar, excepting one, who succeeded in his third try. Only Babcock, Nelson and Uggla managed to clear 375 cm. — which was the next height — at the first attempt, the other seven competitors having to make two or three trials before they succeeded. Dukes and Coyle (U. S. A.) failed in their third attempt, too. At 380 cm. there were thus left only five U. S. A. men, one Canadian, and Uggla, the Swedish representative. Nelson began this round with a grand jump that took him easily over the bar, while Uggla, who came next, missed in his run and failed altogether. Babcock was the next U. S. A. representative who went over with ease, and another of his countrymen managed to clear the bar without a touch. Uggla got across at the second attempt, as did the Canadian, Happenny, the latter of whom, however, lost his balance when in the air and fell so heavily on his breast that he had to be carried from the field. There were still five competitors left at the 385 cm. mark. Nelson failed in his first jump, Uggla following his example, while Babcock swung himself across the bar magnificently. Then came Wright and Murphy, both of whom failed in their first attempt, Babcock being thus the only man who cleared



RUNNING HIGH JUMP. A. W. RICHARDS, U.S.A., Winner.



RUNNING HIGH JUMP. H. LIESCHE, Germany, 2:nd Man.



RUNNING HIGH JUMP. G. HORINE, U. S. A., 3:rd Man.

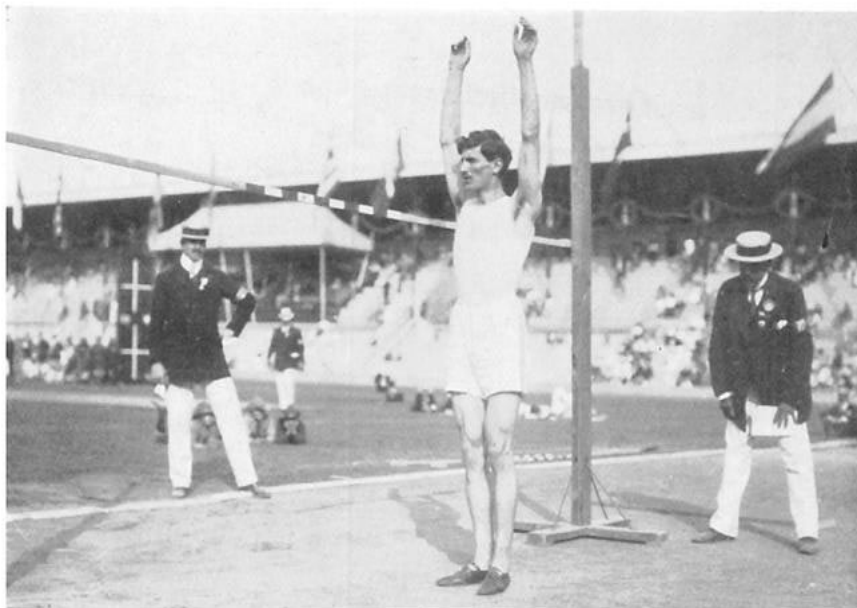

STANDING HIGH JUMP. C. TSICLITIRAS, Greece, 3:rd Man.



STANDING HIGH JUMP. PLATT, ADAMS, U.S.A., Winner.



STANDING HIGH JUMP. PLATT ADAMS, U. S. A., Winner.



RUNNING BROAD JUMP. A. L. GUTTERSON, U. S. A., Winner.



RUNNING BROAD JUMP. C. D. BRICKER, Canada, 2:nd man.



RUNNING BROAD JUMP. G. ÅBERG, Sweden, 3:rd man.



RUNNING BROAD JUMP. A. L. GUTTERSON, U. S. A., Winner.



STANDING BROAD JUMP. PLATT ADAMS, U. S. A.



STANDING BROAD JUMP. PLATT ADAMS, U. S. A., 2:nd man.



STANDING BROAD JUMP. C. TSICLITIRAS, Greece, Winner.



STANDING BROAD JUMP. G. MALMSTEN, Sweden, 4:th man.

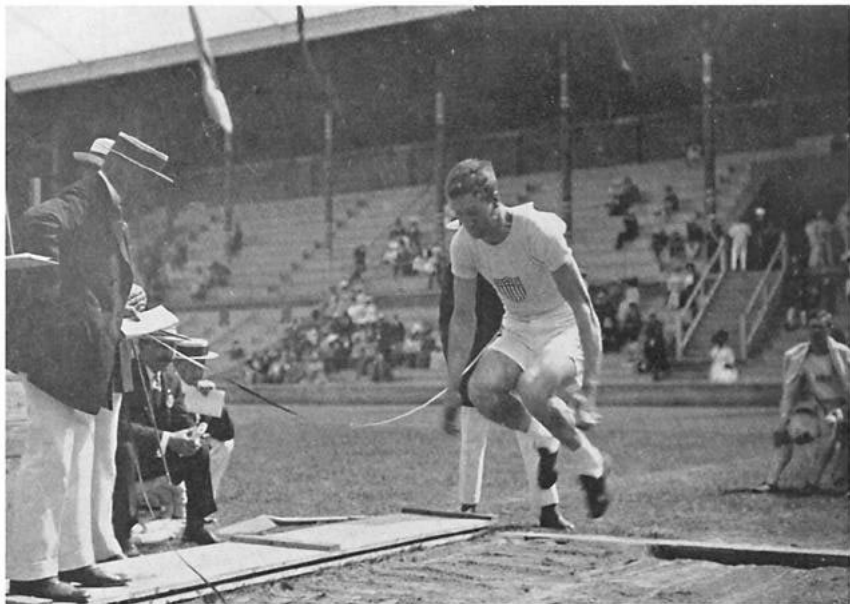

STANDING BROAD JUMP. BEN ADAMS, U. S. A.



THE HOP, STEP AND JUMP. G. ÅBERG, Sweden, 2:nd Man.



THE HOP, STEP, AND JUMP. G. LINDBLÖM, Sweden, Winner.



POLE JUMP. B. UGGLA, Sweden, bracketed 3:rd Man.

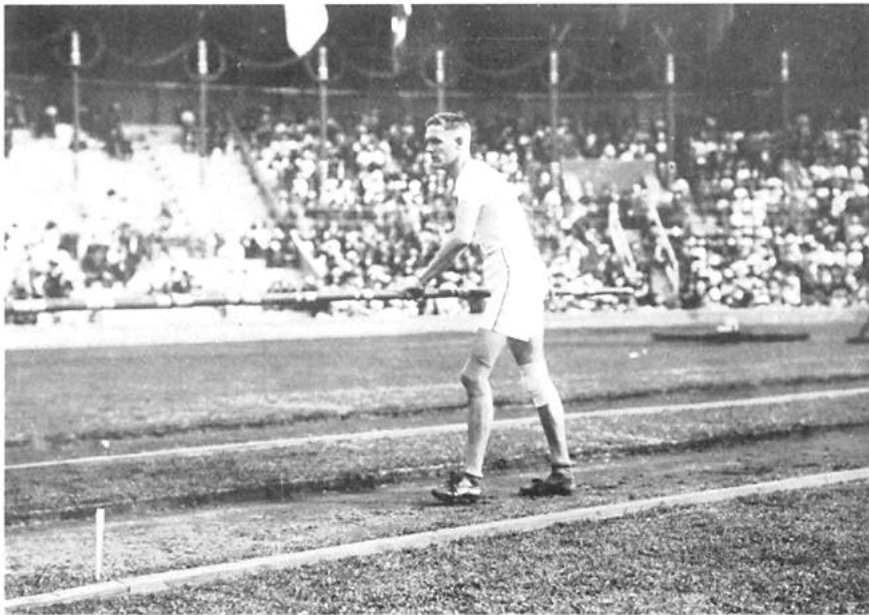

POLE JUMP. H. S. BABCOCK, U. S. A., Winner.

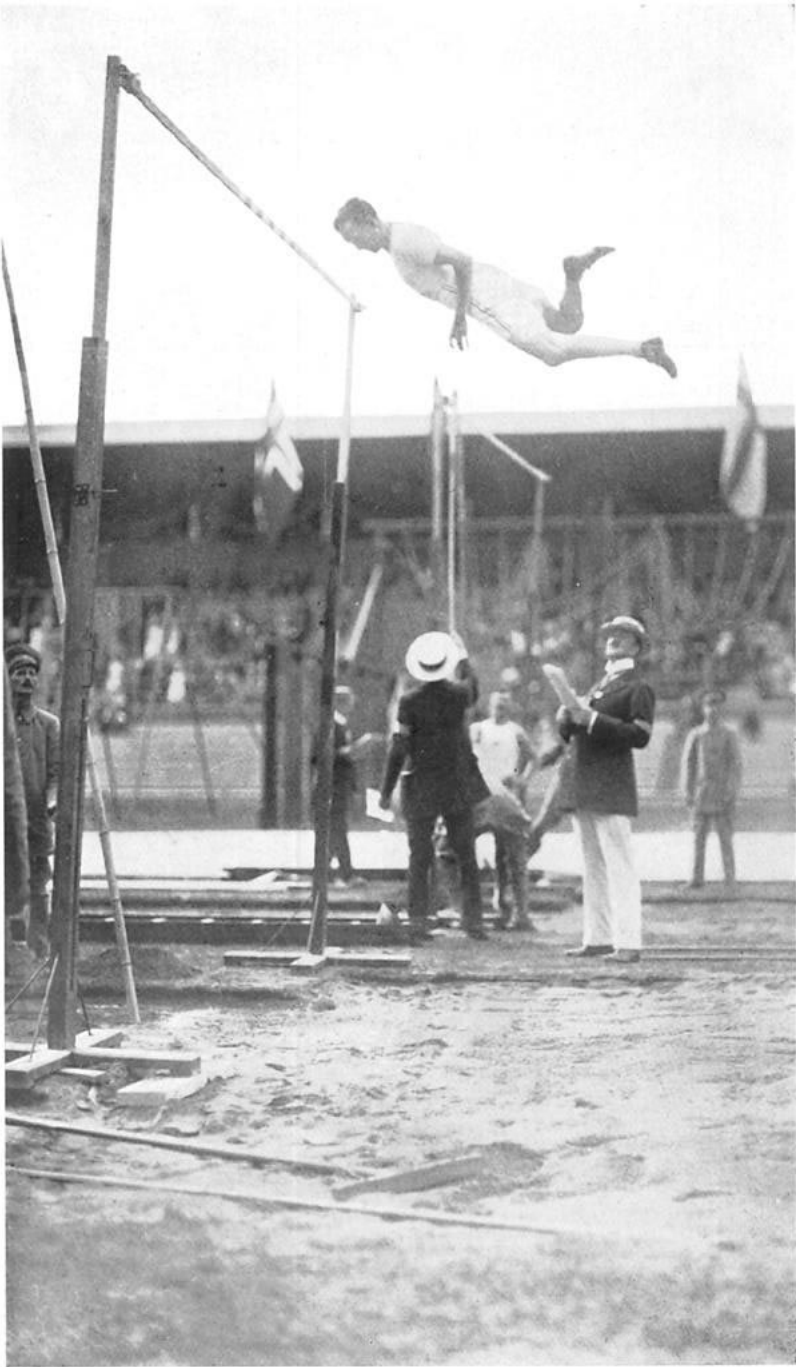

POLE JUMP. F. T. NELSON, U. S. A., bracketed 2:nd Man.

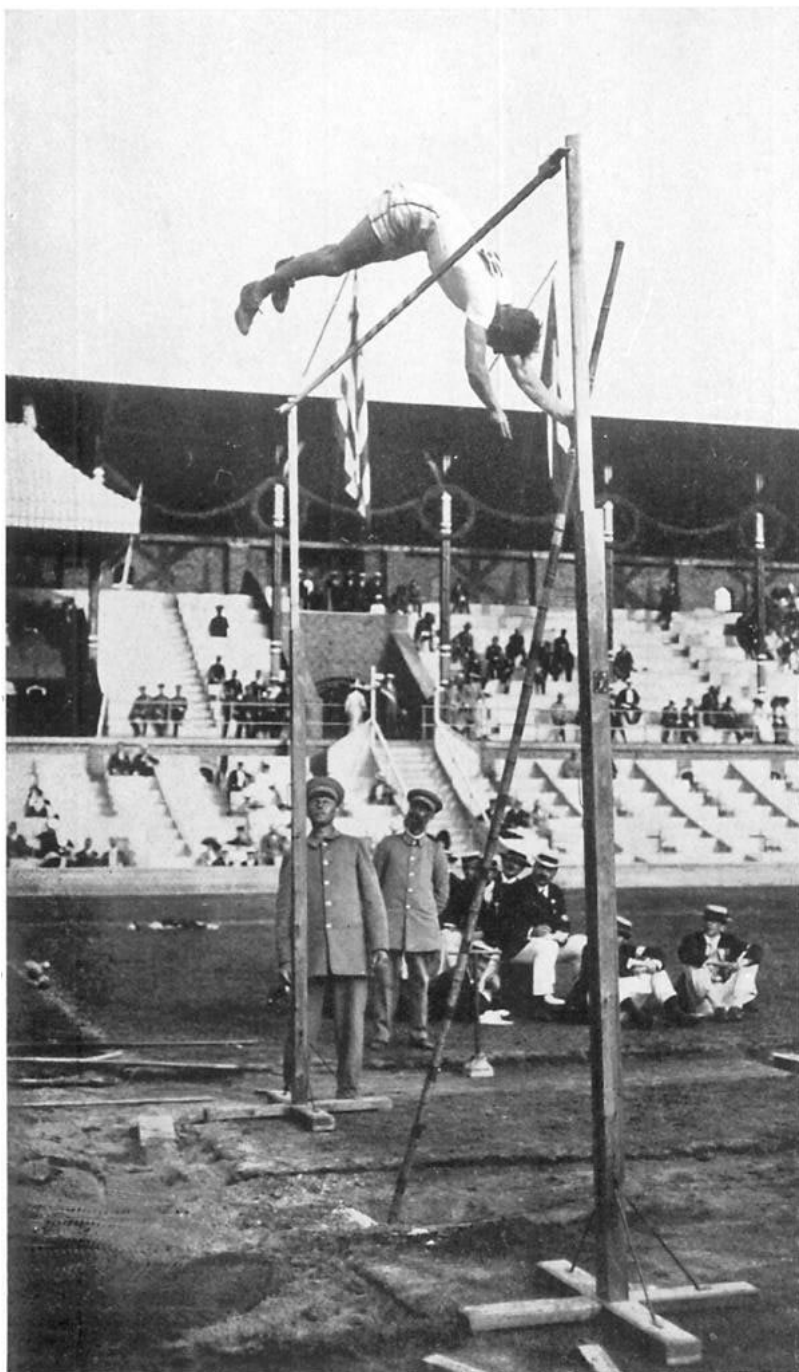

POLE JUMP. M. S. WRIGHT, U. S. A., bracketed 2nd Man.

the bar at the first time of asking. Both Uggla and Murphy failed in the second and third attempts at the 385 cm. mark, so that when 390 cm. was put up there remained only Babcock, Nelson and Wright. With the exception of Babcock, none of the three succeeded in clearing the bar, but Nelson and Wright had to be satisfied with a result of 385 cm. and second place, while Babcock, the bar having been raised to 395 cm., managed to clear this height too. An attempt made by the winner to beat the world's record by putting the bar to 406 cm. failed, however, after three energetic attempts.

Throwing Competitions.

THROWING THE JAVELIN, BEST HAND.

Saturday, 6 July.

1.	ERIC LEMMING.....	Sweden	60.64	met.
	(Olympic record.)			
2.	J. SAARISTO	Finland	58.66	»
3.	M. KOVACS	Hungary	55.50	»
	Not placed :			
	J. Halme	Finland	54.65	m.
	W. Siikaniemi.....	»	52.43	»
	K. Åbrink	Sweden.....	52.20	»
	A. Halse	Norway.....	51.98	»
	J. Myyrä	Finland.....	51.33	»
	U. Peltonen	»	49.20	»
	O. Nilsson	Sweden.....	49.18	»
	H. Sonne.....	»	47.83	»
	D. W. Johansson	Norway.....	47.6r	»
	B. Ohlsson	Sweden.....	46.94	»
	W. Krigsman	»	46.7r	»
	J. Dahl	»	45.67	»
	A. Ohrling	»	45.32	»
	N. Neklepaieff	Russia	44.98	»
	E. Kukkola	Finland	44.66	»
	J. Waitzer	Germany	43.7r	»
	N. Schwedrewitz.....	Russia	43.2r	»
	A. Larsson	Sweden.....	43.18	»
	K. Halt	Germany	41.99	»
	P. Willführ	»	41.05	»

The great number of competitors in this event made it necessary to divide them into four groups for the trials, while the best three men from amongst the total number of competitors were to take part in the final. No consideration was paid to the placing in the respective groups, but only to the absolute results obtained.

No less than 59 competitors had been entered for throwing the javelin, and of these 25 put in an appearance. The Scandinavian countries were very numer-

ously represented, but not one of the athletes entered by the U. S. A. for this event took part in the competition.

Group 1. This was the most interesting of the groups, as it included two of the most prominent aspirants for honours — Eric Lemming, the old Olympic winner, and J. Saaristo, a representative of Finland.

Saaristo began the competition with a throw that measured 54.75 metres, after which, Halme, another Finlander, made a good throw of 53.81 met. Then it was Lemming's turn, but he could not get his arm out as he should have done, and the javelin did not clear more than 53.02 metres. Amongst the other competitors in this group, Peltonen, in his first throw, managed to reach 49.20 met. At the second attempt most of the throwers succeeded in improving their figures, Saaristo, among others, throwing his weapon with tremendous force and skill to a distance of 55.37 metres, and Halme too, increased the length of his throw, and came up to 54.65 met. Lemming's second throw measured 54.78 met. — When the third attempt came, Saaristo's throw was a failure, and so was Halme's, while Lemming, urged by the necessity of exerting himself in order to qualify for the final, flung his javelin confidently and with extraordinary force, and it pierced the ground at a distance of 57.42 metres from the scratch line. With these figures, Lemming beat his own previous Olympic record, and assured himself of a place in the final. — The result in Group 1 was as follows: 1. Eric Lemming, Sweden, 57.42 met.; 2. J. Saaristo, Finland, 55.37 met.; 3. J. Halme, Finland, 54.65 met.; 4. U. Peltonen, Finland, 49.20 met.; 5. O. Nilsson, Sweden, 49.18 met.; 6. H. Sonne Sweden, 47.85 met.; 7. A. Ohrling, Sweden, 45.32 met.; 8. J. Waitzer, Germany, 43.71 met.

Group 2. There were only six competitors in this group, and among these there was no thrower of note, and so the round was not of much interest. Foremost among the men was a Finlander, J. Myyrä, who reached 51.33 met. in the second attempt, the next best man being N. Neklpaieff, Russia, 44.98 metres. Then came: 3. E. Kukkola, Finland, 44.66 met.; 4. N. Schwedrevitz, Russia, 43.21 met.; 5. K. Halt, Germany, 41.99 met.; 6. P. Willführ, Germany, 41.05 met.

Group 3. The competition here was one of more interest, as among the throwers there were two such good men as Kovács, the Hungarian, and the Norwegian, Halse, the latter of whom was second man at the Olympic Games of London, in 1908. Kovács has an extraordinary gift for throwing the javelin, and would have reached a considerably higher figure than he did, if only he had handled his weapon correctly. He was exceedingly uncertain in his run, too, and it was only at his third and last attempt, which measured 54.99 metres, that he was able to prevent himself from going past the scratch line after the throw. Åbrink, a Swede, was the next best in this group, his third throw measuring 52.20 met., while Halse, who was not in the form he was a few years ago, could not throw farther than 51.98 met. The fourth place in this group was taken by a Swede, W. Krigsman, with 46.71 met.; J. Larsson, Sweden, was fifth with 43.18 met. while R. Krojer, Austria, did not succeed in making any fair throw, passing the scratch line each time.

Group 4. Siikaniemi, a Finlander, was the only competitor of any class in this group, and in the third throw he succeeded in reaching 52.43 met., but the throw was not good enough to qualify him for the final. The nearest men in this group were: 2. D. W. Johansen, Norway, 47.61 met.; 3. J. Dahl, Sweden, 45.67 met. E. Falk, Sweden, crossed the scratch line at every throw.

Lemming, Saaristo and Kovács were, thus, those left in for the final. Saaristo, who had the lowest number on the list, began by improving his figures from the trial throws and, in the first attempt in the final, threw 56.21 metres. Lemming, who, evidently, was in his best form, succeeded in taking an exceedingly rapid run, with a lot of strength behind it. In spite of the pace at which he was going, he managed to get his arm stretched well back, with his body, too, bent well backwards, and then, with the greatest skill, he threw his javelin to a distance of 60.64 metres, thus setting another Olympic record. Kovács failed in his first throw, and in the second bout none of those taking part in the final succeeded in improving the figures already reached. In the third and last throw, Saaristo came up to 58.66 metres, and Lemming did about 59 metres. Kovács, in this last attempt, managed to make a beautiful throw, but the javelin flew too high, so that the distance covered was not more than 55.50 metres, which was a little better, however, than the Hungarian's best in the trial throws.

THROWING THE JAVELIN, RIGHT AND LEFT HAND

Friday, 9 July.

1. J. SAARISTO Finland $61.00 + 48.42 = 109.42$ met.
(Olympic record.)
2. W. SIKANIEMI Finland $54.09 + 47.04 = 101.13$ »
3. U. PELTONEN Finland $53.58 + 46.66 = 100.24$ »

Not placed:

Eric Lemming	Sweden	$58.33 + 40.26 = 98.59$	met.
A. Halse	Norway	$55.05 + 41.87 = 96.92$	»
R. Åbrink	Sweden	$50.04 + 43.08 = 93.12$	»
D. Johansen	Norway	$48.78 + 44.04 = 92.82$	»
O. Nilsson	Sweden	$50.21 + 38.69 = 88.90$	»
J. Halme	Finland	$54.90 + 33.64 = 88.54$	»
A. Ohrling	Sweden	$46.51 + 40.66 = 87.17$	»
S. Hagander	»	$46.39 + 40.41 = 86.80$	»
M. Kovács	Hungary	$55.74 + 30.65 = 86.39$	»
W. Krigsman	Sweden	$46.85 + 38.95 = 85.80$	»
H. Sonne	»	$48.48 + 36.48 = 84.96$	»

The competitors were divided into three groups, Saaristo and Lemming being in Group 1. In the right hand throw, Saaristo, in his third attempt, reached the magnificent figure of exactly 61 met., thus beating the previous Olympic record made by Lemming a couple of days previously. Lemming made his farthest throw at the second attempt, but he had to be contented with 58.33 met. Best after these- two was Halme, a Finlander, with 54.90 met. at the third essay. The Finns were the better men in throwing with the left hand, especially as Lemming could not throw with as much power as usual, in consequence of an injury to a muscle of this arm. Saaristo obtained his best figures at his first attempt, when he threw 48.42 met. Ohrling was next to him with 40.66 met., Lemming being

third with 40.26 in his second throw. Saaristo was thus the first man in Group 1, with a total of 109.42 met., Lemming reaching only 98.59 met.

Peltonen was the best in Group 2 and, at his third attempt in the right hand throw, reached 53.58 met. This right hand throw was beaten by the Hungarian, Kovács, who, at his second attempt, managed to reach 55.74 met. In the left hand throw, Peltonen was absolutely the better man, and made three casts of 46.30, 46.63 and 46.66 met. respectively, a very even piece of work. It was evident that Kovács had trained very little for the throw with the left hand, his best figure being no more than 30.65, while Åbrink, a Swedish representative, secured second place in the group with a left hand throw of 43.08.

In Group 3, the Norwegian, Halse, made a brilliant right hand throw of 55.05 met., the best man after him being Siikaniemi, with 54.09 met. In the left hand throw, however, the Finlander had his revenge and, with a throw of 47.04, which he made at the third attempt, qualified for the final.

When the representatives of Finland learned that only their countrymen remained for the final, they determined not to have any final round, but to allow the placing to be determined by the results of the throws in the trial series.

THROWING THE DISCUS, BEST HAND.

Friday, 12 July.

1.	A. R. TAIPALE	Finland	45.21 met.
	(Olympic record.)		
2.	R. L. BYRD	U. S. A.	42.32 »
3.	J. H. DUNCAN	U. S. A.	42.28 »
	Not placed:		
	E. Niklander	Finland	42.09 met.
	H. Tronner	Austria	41.24 »
	A. M. Mucks	U. S. A.	40.93 »
	G. W. Philbrook	»	40.92 »
	E. Magnusson	Sweden	39.91 »
	R. Ujlaky	Hungary	39.82 »
	E. Nilsson	Sweden	39.69 »
	R. W. Rose	U. S. A.	39.65 »
	E. J. Muller	»	39.35 »
	M. Dorizas	Greece	39.28 »
	D. Gillis	Canada	39.01 »
	W. Järvinen	Finland	38.60 »
	J. Waitzer ..	Germany	38.44 »
	F. Janda	Bohemia	38.31 »
	A. Lenzi	Italy	38.19 »
	K. Kobulsky	Hungary	38.15 »
	L. A. Whitney	U. S. A.	37.91 »
	G. Lunzer	Hungary	37.88 »
	A. Brundage	U. S. A.	37.85 »
	G. Nilsson	Sweden	37.44 »
	E. Welz	Germany	37.24 »
	S. Fothi	Hungary	36.37 »
	G. Bolander	Sweden	36.22 »
	C. Lind	»	36.07 »
	F. Fleetwood	»	35.06 »
	J. Schäffer	Austria	34.87 »

A. Tison	France	34.73	met.
M. Pelletier.....	Luxemburg	33.73	»
W. E. B. Henderson.....	Great Britain	33.61	»
M. Kovács	Hungary	33.30	»
M. Megherian	Turkey	32.98	»
N. Neklpaieff	Russia	32.59	»
C. Lagarde	France	32.35	»
H. Möller	Sweden	32.23	»
M. Sustera	Bohemia	31.38	»
W. Wannag	Russia.....	31.34	»
O. Nilsson	Sweden	31.07	»

In this event the competitors had been divided into five groups, so as to save time.

Taipale (Finland), formed one of the first group, and he showed his superiority from the very beginning. It is true that, in the first throw, he did not come farther than 36.84 metres, while the Austrian, Tronner, threw 39.97 and Magnusson, a Swede, 39.91 met., but, at the second attempt, Taipale threw the very fine distance of 43.91 metres. At his second trial, too, Dorizas, the Greek competitor, threw 39.28 met. In the third throw, only Tronner succeeded in improving his figures, reaching 41.24 metres. The final result in Group I was, therefore:

1. Taipale, Finland, 43.91 metres; 2. Tronner, Austria, 41.24 metres; 3. Magnusson, Sweden, 39.91 metres.

In Group 2, only Mucks, U. S. A., managed to exceed the forty metres; reaching 40.93 metres in his second throw.

In the second group the best man was Niklander, of Finland; his longest throw was made at the first trial, and measured 42.09 metres, while Ralph Rose, the U. S. A. athlete, threw 39.65 metres at his third attempt.

In the third group, Byrd, U. S. A., was best man, with a throw of 42.32 metres, his fellow-countryman, Duncan, with 42.28 metres, being a good second. Duncan made this throw in the second trial.

In the fourth group — the last one — Philbrook, U. S. A., threw 40.92 met. at his third attempt.

There thus qualified for the final, Taipale, Finland; Byrd, U. S. A., and Duncan, U. S. A. Of these, none but Taipale succeeded in bettering the figures obtained in the trials, the Finlander, at his first throw in the final, reaching 44.34 metres, while, with his last, he created a world's record, throwing 45.21 metres, this making him an easy winner. Byrd remained second, with the same figures as in the trials, while Duncan had to be satisfied with third place.

THROWING THE DISCUS, RIGHT AND LEFT HAND.

Saturday, 13 July.

1. A. R. TAIPALE ... Finland ... $44.68 + 38.18 = 82.86$ met.
(Olympic record.)
2. E. NIKLANDER ... Finland ... $40.28 + 37.68 = 77.96$ »
3. E. MAGNUSSON ... Sweden ... $40.58 + 36.79 = 77.37$ »

Not placed :

E. Nilsson	Sweden	$40.99 + 30.41 = 71.40$	met.
J. H. Duncan.....	U. S. A.	$39.78 + 31.35 = 71.13$	»
E. J. Muller	»	$39.83 + 29.73 = 69.56$	»
F. Fleetwood	Sweden	$36.95 + 31.27 = 68.22$	»
C. J. Lind	»	$34.20 + 33.82 = 68.02$	»
N. Linde.....	»	$34.98 + 32.12 = 67.10$	»

G. Nilsson	Sweden	36.86 + 30.23 = 67.09	met.
E. Lemming	♦	37.86 + 29.22 = 67.08	»
W. Järvinen	Finland	37.84 + 28.85 = 66.69	»
H. Tronner	Austria	39.95 + 26.71 = 66.66	»
R. Ujlaky	Hungary	40.32 + 25.86 = 66.18	»
A. M. Mucks	U. S. A.	42.63 + 21.20 = 63.83	»
J. Schäffer	Austria	36.59 + 26.91 = 63.50	»
R. L. Byrd	U. S. A.	40.10 + 22.22 = 62.32	»
K. Kobulsky	Hungary	37.01 + 22.47 = 59.48	»
B. Molokanoff	Russia	24.79 + 22.58 = 47.37	»

There were twenty athletes taking part in the competition in throwing the discus, right and left hand, and these were divided into three groups.

Taipale and Magnusson met in the very first division, and the great struggle took place between these two competitors. In his first throw with the right hand, Magnusson made 40.28 metres, while Taipale reached 42.68 met. The next man after these was Muller, U. S. A., with a throw of 39.83 metres. Magnusson did not succeed in improving his figures in the second and third throws, while Taipale, doing steadily better as he went on, made 43.70 in his second throw and 44.68 with his third. At the third time of asking, Tronner, the Austrian representative, made a fine throw, measuring 39.95 metres, and Nilsson, Sweden, made one throw of 40.99 met. In the throwing with the left hand, Magnusson began the first trial with a throw of 35.07 metres, while Taipale had to be satisfied with one of 34.15 met. In this first trial, Lind, Sweden, was third man, with 33.82 met. In these left hand throws, too, Magnusson did best at his first attempt, while his Finnish rival, in the second throw, increased his figures to 35.35 met. In the last throw of the series, none of the competitors succeeded in improving the results already obtained, and the final result of the competition in Group I was: Taipale (right and left hand), 80.03 metres; Magnusson, 75.35 met.; Nilsson, 71.40 met.

In the second group, Niklander was undoubtedly the best, although he threw nothing like the distances one is accustomed to see him reach. For, example, his best throw with the right hand was only 40.28 metres and, with the left 31.77 met., or a total of 72.05 met., which was good enough, how-ever, to give him a place in the final.

In the third group, the best man was Duncan, U. S. A., with a right hand throw of 39.78 met., at the first attempt, and a left hand throw of 31.35 met., also made in the first throw of the series.

In the final, too, it was Magnusson's not very agreeable lot to begin. In his first throw, right hand, he made 37.03 met., which Taipale answered with a first score of 42.78 met. Niklander did not improve on his previous figures. At his second attempt, Magnusson threw 38.90 met., while, this time, Taipale did not do so well as in his first throw, and Niklander threw only 37.94 met. With his third throw, Magnusson added 30 centimetres to the figure he made in his best throw in the trials, reaching 40.58 metres, but then Taipale made a grand throw of 44.68 metres. Niklander failed at his third attempt. In the left hand throws Magnusson did some very even work, all three measuring more than 36 metres; the best, and the last, being

36.79 met. In this series, Taipale, best figures were 38.18 met., and it really looked as if the Swede was going to take second honours, but, at his second throw, left hand, Niklander got the discus up beautifully, and it fell 37.68 met. from the ring. This throw made the Finlander sure of second place, although, as was said above, Magnusson managed to make a last throw that was an improvement on his previous attempts.

PUTTING THE WEIGHT, BEST HAND.

Wednesday, 10 July.

1. P. MC DONALD U. S. A. 15.34 met.
(Olympic record.)
2. R. W. ROSE U. S. A. 15.25 »
3. L. A. WHITNEY U. S. A. 13.93 »

Not placed:

E. Niklander	Finland	13.65 met.
G. W. Philbrook	U. S. A.	13.13 »
I. Mudin	Hungary	12.81 »
E. Nilsson	Sweden	12.62 »
P. Quinn	Great Britain..	12.53 »
A. Tison	France	12.41 »
P. Aho	Finland	12.40 »
M. Dorizas	Greece	12.05 »
A. Lenzi	Italy	11.57 »
J. Schäffer	Austria.....	11.44 »
K. Halt	Germany.....	11.16 »
F. Janda	Bohemia	11.15 »
R. Paoli	France.....	11.11 »
M. Pelletier	Luxemburg.....	11.04 »
P. Willführ	Germany.....	10.90 »
M. Megherian	Turkey	10.63 »
E. Wannag	Russia	10.44 »
A. Ohsol-Berné	»	10.33 »
Ch. Lagarde.....	France.....	9.41 »

Altogether, there were 22 men who took part in this competition, but, of this number, scarcely 8, and not more than 10, can be said to have been really qualified to take part in it. This did not prevent the competition from being a very sharp one, however, even if the match resolved itself into a struggle between MC Donald and Rose. In the first throw of the first round, Rose threw 14.98 met., MC Donald reaching 14.54 met. At the second throw, both men did worse than at first, but, at the third attempt, Rose improved his figures, coming up to 15.25 met., while MC Donald could do no better than 14.78 met. These two, therefore, were sure of being in the final, and another representative of the U. S. A., little Whitney, qualified in the last round for the remaining place. Whitney was remarkable for the grace with which he put the shot, and, considering his size, he obtained most astonishing results. Niklander, in consequence, was altogether out of the running.

In the final, however, Whitney could not improve on his best in the trial, 13.93 metres, and Ralph Rose, too, had to be content with his 15.25, also made in the trial. MC Donald, on the other hand, made an extraordinary throw in this first attempt in the final, the shot landing 15.34 metres from the ring, and giving him the victory.

PUTTING THE WEIGHT, RIGHT AND LEFT HAND.

Thursday, 11 July.

1. R. W. ROSE	U. S. A.....	15.23 + 12.47 = 27.70 met.	
	(Olympic record.)		
2. P. MC DONALD ...	U. S. A.....	15.08 + 12.45 = 27.53	»
3. E. NIKLANDER	Finland	14.71 + 12.43 = 27.14	»
Not placed:			
L. A. Whitney ...	U. S. A.....	13.48 + 10.61 = 24.09 met.	
E. Nilsson	Sweden	12.52 + 10.85 = 23.37	»
P. Aho	Finland	12.72 + 10.58 = 23.30	»
M. Megherian	Turkey	10.85 + 8.93 = 19.78	»

It was pretty generally thought that this competition would result in a victory for the Finlander, Niklander, in consequence of his extraordinary skill in putting the shot with the left hand. These expectations came to naught, however; the two gigantic weight-putters, Rose and Mc Donald, showing their absolute superiority in this event too. There was a very large number of entries for this competition, but there were no more than seven men that took part in it.

In the right hand series, Rose made the longest first throw, with 15.11 metres, Niklander being second with 14.24 met.; Mc Donald next, with 13.95 met., Whitney following with 13.48 met. In the second throw with the right hand, only MC Donald managed to increase his figures, but he succeeded in doing so to the extent of almost a metre, throwing 14.92 met. At the third attempt, Rose was the only one that managed to better his results, this throw measuring 15.23 met. this giving him a good lead over Mc Donald, in the right hand throw. In the left hand series, Niklander made a first throw of 11.84 met., Rose getting no more than 11.04 met., while Mc Donald reached 11.37 met. Niklander could not manage to improve matters at the second attempt, but Rose came on to 11.19 met. and MC Donald to 11.74 met. In the third and last throw of the left hand trials, Niklander made a beautiful throw, of 12.43 metres. Rose improved his, getting 11.27 met., and Mc Donald, 11.85 met., the final totals of the trials being, that Mc Donald came first, with 26.77 metres, Niklander second, with 26.67 met., Rose third, 26.50 met., Whitney fourth, 24.09 met., and Nilsson, Sweden, fifth, with 23.37 metres.

The first three had then to make three additional throws with each hand, in order to decide the placing. In his right hand throws, Niklander managed to bring his figures up to 14.71 metres, but his best left hand throw was 1 centimetre worse than his longest throw in the trials. Rose, who, up to the last of his right hand efforts, had been number three, then succeeded in putting in a grand throw, the shot landing 12.47 metres from the ring, and as Mc Donald could not go



THROWING THE JAVELIN, BEST HAND. E. LEMMING, Sweden, Winner.



THROWING THE JAVELIN, RIGHT AND LEFT HAND, J. SAARISTO, Finland, Winner.



THROWING THE DISCUS. A. R. TAIPALE, Finland, Winner.



THROWING THE DISCUS. A. R. TAIPAILE, Finland.



THROWING THE DISCUS, BEST HAND. R. L. BYRD, U. S. A., 2:nd man.



THROWING THE DISCUS, RIGHT AND LEFT HAND.
E. MAGNUSSON, Sweden, 3:rd man.



THROWING THE DISCUS, BEST HAND. J. H. DUNCAN, U. S. A., 3:rd man.



PUTTING THE WEIGHT COMPETITION.



PUTTING THE WEIGHT, BEST HAND. McDONALD, U. S. A., Winner.



PUTTING THE WEIGHT, RIGHT AND LEFT HAND. RALPH ROSE, U. S. A., Winner.



PUTTING THE WEIGHT, RIGHT AND LEFT HAND. E. NIKLANDER, Finland, 3:rd Man.



THROWING THE HAMMER. M. J. McGRATH, U. S. A., Winner.



DECATHLON. BROAD JUMP. H. WIESLANDER, Sweden.



DECATHLON. BROAD JUMP. E. L. MERCER, U. S. A.



DECATHLON. POLE JUMP. H. WIESLANDER, Sweden.



DECATHLON. POLE JUMP. J. THORPE, U. S. A.

one better, his best put being 124 met., the result was that Rose had his revenge on Mc Donald for the victory of the latter in the competition with the best hand. Niklander, the Finnish representative, had to be contented with third place.

THROWING THE HAMMER.

Sunday, 14 July.

1. M. J. MC GRATH..... U. S. A. 54.74 metres.
(Olympic record.)
2. D. GILLIS Canada 48.39 »
3. C. C. Childs U. S. A. 48.17 »

Not placed :

C. R. Olsson	Sweden	46.50 metres.
C. J. Lind	»	45.61 »
D. Carey	Great Britain...	43.78 »
N. Linde	Sweden	43.32 »
C. Jahnzon	»	42.58 »
R. W. Rose.....	U. S. A.....	42.58 »
A. Åberg	Sweden	41.11 »
G. Johnsson.....	»	39.92 »
B. F. Sherman	U. S. A.....	38.77 »
W. Hackberg	Sweden	38.44 »

The trial rounds took place with the competitors divided into two groups. In the first group G. Johnsson (Sweden) began, and made a throw of 38.66 metres; Childs did best, however, with 48.17 metres and, next to him, a Swede, Lind with 45.06 metres Then came another Swede Olsson, who threw 39.56 metres, and a compatriot, C. Jahnzon, who reached 39.18 metres. In the second throw in the trial series, Olsson, Sweden, was the only man that succeeded in improving his position ; his figures on this occasion being 46.50 met. The nearest man to him at this second attempt, was Carey, Great Britain, 43.78 met., and C. Jahnzon, Sweden, 42.58 met. In the third and last try, Lind came on to 45.61 met., but he was evidently too nervous to be able to do anything like what he ought to. Most of the competitors in the first group failed in the third throw, the only one, with the exception of Lind, that made a throw of any length, being Åberg, Sweden, who, at his third and only successful effort, reached 41.11 metres.

In Group 2, Mc Grath was of a higher class than the other competitors, and threw 54.13 metres at the first time of asking, this being the farthest throw made during the course of the trial rounds. The next man was Gillis, Canada, who threw 46.17 met., but this distance he increased in his third try to 48.39 met. The third man in this group was Linde, Sweden, 43.32 met.

An accident occurred in the course of this competition, Gillis, the Canadian, who, when practising earlier during the week, had injured his foot, now stepping on the iron ring while swinging round for a throw, and spraining the same foot again, so that he had to be carried off the ground.

The result of the trial round was, that two U. S. A. men, Mc Grath and Childs, and the Canadian representative, Gillis, were left in for

the final. Mc Grath was the only one of the three that succeeded in improving the figures made in the trial, his last throw in the competition being the brilliant one of 54.74 metres.

The Pentathlon and the Decathlon.

On the 6 Feb. 1913, the Swedish Olympic Committee received a letter from the Secretary of the U. S. A. Olympic Committee, stating that the Amateur Athletic Union of the United States had declared Thorpe to have lost his amateur standing, as he had received payment for playing in base ball matches. As this offence against the rules of amateurship had taken place before the Olympic Games of 1912, the Union resolved that the prizes won by James Thorpe for the Pentathlon and Decathlon Competitions of the Fifth Olympiad, should be returned to the Swedish Olympic Committee.

The official resolution in the matter come to by the Amateur Athletic Union of the United States was forwarded to the Swedish Olympic Committee, and was as follows:

“The Team Selection Committee of the American Olympic Committee selected James Thorpe as one of the members of the American Olympic Team, and did so without the least suspicion as to there having ever been any act of professionalism on Thorpe’s part.

For the past several years Thorpe has been a member of the Carlisle Indian School, which is conducted by the Government of the United States at Carlisle, Pa. through the Indian Department of the Department of the Interior. Mr. Glenn Warner, formerly of Cornell, a man whose reputation is of the highest and whose accuracy of statement has never been doubted, has been in charge of the athletic activities at the Institution. During the period of Mr. Thorpe’s membership at Carlisle he competed in its football-, base ball-, and track and field teams, and represented it in inter-collegiate and other contests, all of which were open only to amateurs, as neither Carlisle nor any of the Institutions with which it competes has other than amateur teams. Thorpe’s standing as an amateur had never been questioned, nor was any protest ever made against him, nor any statement ever made as to his even having practised with professionals, still less that he had played with, or as one of them.

The widest possible publicity was given of the team selected by the American Olympic Committee, and it seems strange that men having a knowledge of Mr. Thorpe’s professional conduct did not at such time for the honor of their country come forward and place in the hands of the American Committee such information as they had. No such information was given, nor was a suggestion even made as to Thorpe being other than the amateur which he was supposed to be. This country is of such tremendous territorial expanse and the athletes taking part therein are so numerous, that it is sometimes extremely difficult to ascertain the history of an athlete’s past. In the selection of the American Team the Committee endeavored to use every possible precaution, and where there was the slightest doubt as to a man’s amateur standing, his entry was not considered.

Thorpe's act of professionalism was in a sport over which the Amateur Athletic Union has no direct control; it was as a member of a base ball team in a minor league and in games which were not reported in the important papers of the country. That he played under his own name would give no direct notice to any one concerned, as there are many of his name. The reason why he himself did not give notice of his acts, is explained by him on the ground of ignorance. In some justification of his position, it should be noted that Mr. Thorpe is an Indian of limited experience and education in the ways of other than his own people.

The American Olympic Committee and the Amateur Athletic Union feel that while Mr. Thorpe is deserving of the severest condemnation for concealing the fact that he had professionalized himself by receiving money for playing baseball, they also feel that those who knew of his professional acts are deserving of still greater censure for their silence.

The American Olympic Committee and the Amateur Athletic Union tender to the Swedish Olympic Committee and through the International Olympic Committee to the Nations of the World, their apology for having entered Mr. Thorpe and having permitted him to compete at the Olympic Games of 1912.

The Amateur Athletic Union regrets that it permitted Mr. Thorpe to compete in amateur contests during the past several years and will do everything in its power to secure the return of prizes and the re-adjustment of points won by him, and will immediately eliminate his records from the books.

Dated New York City,
Jan. 27th 1913.

(Signed) GUSTAVUS T. KIRBY,
President Amateur Athletic Union and Vice-President of American Olympic Committee.
JAMES E. SULLIVAN,
Chairman National Registration Committee, Secretary Amateur Athletic Union and Secretary American Olympic Committee.
BARTOW S. WEEKS,
Chairman Legislation Committee A, A. U. and Vice-President American Olympic Committee."

The Swedish Olympic Committee resolved, in consequence, to submit the matter concerning James Thorpe to the International Olympic Committee. At a meeting held at Lausanne on the 26 May, 1913, the International Olympic Committee decided that James Thorpe had forfeited the prizes he won at the Fifth Olympiad, and that the results of the Pentathlon and Decathlon had been as follows:

PENTATHLON:

1. F. R. Bie Norway.
2. J. J. Donahue U. S. A.
3. F. L. Lukeman..... Canada.

DECATHLON:

1. H. Wieslander Sweden
2. Ch. Lomberg..... Sweden
3. G. Holmér Sweden

PENTATHLON.

Sunday, 7 July.

1.	F. R. BIE	Norway	21 points
2.	J. J. DONAHUE	U. S. A.	29 »
3.	F. L. LUKEMAN	Canada	29 »

Not placed :

J. A. Menaul	U. S. A.	30 points
A. Brundage	»	31 »
H. Wieslander	Sweden	32 »

In accordance with the rules of the Olympic Games adopted for this competition, the men whose names are given above were left in when the fifth event — the 1,500 metres Flat — began. Among the Swedes that took part in the Pentathlon, Wieslander was the only one that managed to stay until the close of this severely contested competition. Donahue, one of the U. S. A. representatives, and the Canadian, Lukeman, had the same points, and the tie had to be decided by means of calculating their results in accordance with the Decathlon tables, these showing that Donahue was the better man, with a total of 3,475.865 points, Lukeman's figures being 3,396.975.

The results of the various events forming the Pentathlon were as follows:

Running Broad Jump.

1.	F. R. BIE	Norway	6.85 metres
2.	J. J. DONAHUE	U. S. A.	6.83 »
3.	A. BRUNDAGE	»	6.58 »

The U. S. A. man, Brundage, led at first, with a jump of 6.58 metres, but he was soon beaten by Donahue, who, in his turn, lost a point to Bie, who cleared 2 centimetres more than his American rival. Then came Thorpe, and made a fine jump of 7.07 met. Oscar Lemming was the best of the Swedes, and was fourth amongst all the competitors, with 6.55 metres, Lomberg, another Swede, coming next with 6.53 met., while Wieslander was 13:th on the list, with 6.27 met.

Throwing the Javelin, best hand.

1.	H. WIESLANDER	Sweden	49.56 m.
2.	OSCAR LEMMING	»	49.51 »
3.	F. R. BIE	Norway	46.45 »

As had been expected, the Swedish contingent managed to improve its position by this event. Wieslander's victory was a foregone conclusion, of course, but Oscar Lemming threw surprisingly well, and succeeded in reaching third place, as regards total points, after Bie, who was third in the javelin throwing. The position after the close of this event was as follows:

1. Bie, Norway, 4 points, 2. Lemming, Sweden, 6 points, 3. Brundage, U. S. A., 11 points, 4. Wieslander, Sweden, 14 points, 5. Donahue, U. S. A., 16 points, 6. Kugelberg, Sweden, 17 points, 7. E. Nilsson, Sweden, 21 points, 8. Lomberg, Sweden, 21 points, 9. Kukkola, Finland, 21 points, 10. Fjästad, Sweden, 22 points, 11. Holmér, Sweden, 23 points.

R E S U L T
of the five events in the
P E N T A T H L O N .

Placing	Name	Nation	Running Broad Jump	Place number	Throwing the Javelin	Place number	200 metres Flat	Place number	Throwing the Discus	Place number	1,500 metres Flat	Place number	Place number Grand	Placing
1	F. R. Bie	Norway	6.85	1	46.45	3	23.5	4	31.79	3	5,07.8	5	16	I
2	J. J. Donahue	U. S. A.	6.83	2	38.28	9	23.0	1	29.64	10	4,51	2	24	II
	(Points according to Decathlon tables)		840.75		544.875		875.0		550.84		714.40			3,475.865)
3	F. L. Lukeman	Canada	6.45	5	36.02	10	23.2	3	33.76	2	5,00.2	4	24	III
	(Points according to Decathlon tables)		747.65		482.725		800.0		707.40		659.20			3,396.975)
4	J. A. Menaul	U. S. A.	6.40	7	35.85	11	23.0	1	31.38	5	4,49.6	1	25	IV
5	A. Brundage	U. S. A.	6.58	3	42.85	6	24.2	10	34.72	1	—	6	26	V
6	H. Wieslander	Sweden	6.27	9	49.56	1	24.2	9	30.74	6	4,51.2	3	28	VI

200 metres Flat.

1. J. J. DONAHUE.....	U. S. A.	} 23 sec.
2. J. A. MENAUL	»	
3. J. J. ELLER, Jr	»	
			23 ¹ / ₁₀ »

The event was run in nine heats, with three men in each, the time of each man being taken. The winners in the various heats were: Heat 1. G. Krojer, Austria, 24⁷/₁₀ sec.; Heat 2. Bie, Norway, 23⁹/₁₀ sec.; Heat 3. J. Eller, U. S. A., 23⁷/₁₀ sec.; Heat 4. P. Failliot, France, 23¹/₅ sec.; Heat 5. J. Lindholm, Sweden, 23⁹/₁₀ sec.; Heat 6. J. Donahue, U. S. A., 23 sec.; Heat 7. J. A. Menaul, U. S. A., 23 sec.; Heat 8. F. L. Lukeman, Canada, 23¹/₅ sec.; Heat 9. J. Thorpe, U. S. A., 22⁹/₁₀ sec.

After the close of this event, the twelve competitors that had the best positions as regards points were left in to continue the competition. Their names were:

1. Bie, 8 points, 2. Donahue, 12 points, 3. Lemming, 17 points, 4. Lukeman, 18 points, 5. Wieslander, 19 points, 6. Lindholm, 19 points, 7. Brundage, 19 points, 8. Menaul, 19 points, 9. Fjåstad, 23 points, 10. Holmér, 22 points, and 11 Kukkola, 22 points.

There were thus five Swedes, three U. S. A. men, one Norwegian, one Canadian and one Finlander left to begin the next event, throwing the discus.

Throwing the Discus.

A. Brundage.....	U. S. A.	34.72 m.
F. L. Lukeman	Canada	33.76
F. R. BIE	Norway	31.79

The results obtained in this event were not at all so good as had been expected, this being the result, most probably, of the throwers having the sun right in their eyes. Holmér was the best Swede, being fifth man with 31.78 metres, while Wieslander was quite unsuccessful and could do no better than 30.74 metres. Thorpe threw 35.57 m.

1,500 metres Flat.

1. J. A. MENAUL	U. S. A.	4 min. 49 ⁸ / ₅ sec.
2. J. DONAHUE.....	»	4 » 51 »
3. H. WIESLANDER	Sweden	4 » 53 ¹ / ₁₀ »

In addition to Thorpe and the three winners of the race, three others started in this, the last event in the Pentathlon, F. L. Lukeman, Canada, F. R. Bie, Norway, and A. Brundage, U. S. A.

The lead was taken by Menaul, closely followed by Donahue, while Wieslander and Thorpe lay behind during the first lap. In the second lap Thorpe took the lead and kept it for the remainder of the race. Wieslander gradually succeeded in getting a little life into his legs, but he gained nothing better than fourth place. Bie, who was sure of getting the second prize, was satisfied with being placed last but one in this event. Thorpe's time was 4 min. 44⁴/₅ sec.

DECATHLON.

1. H. WIESLANDER	Sweden	7,724.495 points.
2. C. LOMBERG	Sweden	7,413.51 »
3. C. HOLMÉR.....	Sweden	7,347.855 »
Not placed :			
4. J. J. Donahue	U. S. A.	7,083.45 »
5. E. L. Mercer.....	»	7,074.995 »
6. W. Wickholm.....	Finland	7,058.795 »
7. E. Kugelberg	Sweden	6,758.780 »

8. K. Halt.....	Germany	6,682.445	points.
9. J. Schäffer	Austria	6,568.585	»
10. A. Choultz	Russia	6,134.470	»
11. A. Alsleben.....	»	5,294.615	»

The Decathlon competition, which now made its first appearance on the programme of the Olympic Games, was originally intended to be completed within two days, five events being held each day. In consequence of the large number of entries, however, it was not thought possible that the competition could be finished in two days, and so three days were allotted to it, three events to be held on the first day four on the second and three on the last. But, by doing this, the original idea, as conceived in Sweden, was somewhat departed from, the primary intention having been that the Decathlon was to form a competition in which, not only all-round athletic skill but also an equal amount of endurance was to be displayed. The last factor, the test of endurance, was essentially eliminated by extending the competition over three days and the Decathlon became, in the end, really an event in which actual athletic skill played the predominant role.

100 metres Flat.

The competitors were divided into ten heats, with three men in each, the times being taken of all the runners, this being, of course, necessary, in order to be able to determine the proper point-figures for the competitors.

Holmér, Sweden, was the winner of the first heat, running the 100 met. in 11 $\frac{2}{5}$ sec.; his compatriot, Wieslander, who was second, taking $\frac{3}{5}$ sec. longer. The second heat, too, was won by a Swede, Einar Nilsson, who ran the distance in 11 $\frac{5}{10}$ sec., beating the U. S. A. man, Brundage, who apparently had not trained very much for short distance running. In the third heat, Mercer, U. S. A., had the best time of the day, with just 11 sec.; he beat his fellow countryman, Donahue, by no less than $\frac{4}{5}$ sec., Babcock, U. S. A., the pole-jumper, had an easy task in winning the fourth heat, with a time of 11 $\frac{3}{5}$ sec., while, in the fifth heat, the French representative, Failliot, was first man, his time being 11 $\frac{1}{10}$ sec., thus beating the Norwegian, Bie. In the sixth heat, Jacobsson, Sweden, succeeded in running the distance in the same time as Mercer, 11 sec., and in the next heat, Lukeman, the Canadian, gained an easy victory over Lomberg. The eighth heat went to the German, Abraham, in the relatively poor time of just 12 sec. The tenth and last heat was won by the Finlander Wickholm.

The result of the 100 met. flat was, therefore, that Jacobsson and Mercer both gained the highest figures obtained in this event, 952.4, while Lukeman came next with 904.8 points.

Running Broad Jump.

After a short hour's rest, the competitors were recalled to the arena to take part in the running broad jump. The fact that the ground was probably not quite so elastic that day, on account of the intense heat, as on the preceding days of the Games, was probably the reason that none of the competitors could reach the 7 metre's mark. The best man was Lomberg, Sweden, who cleared 687 cm. in his longest jump, while such good jumpers as Mercer and Thorpe had to be contented with 684 cm., and 679 cm. respectively. Wieslander reached 642 cm., while

Kugelberg, a Swede, who at other times could perform very well indeed, was unable to do anything better now than 620 cm. and his fellow-countryman, Einar Nilsson, who seemed to be altogether out of form, stayed at 572 cm.

After the completion of the competition in the running broad jump, the position of the best men was as follows:

E. L. Mercer	U. S. A.	1,795.60	points.
S. Jacobsson	Sweden	1,702.50	»
O. Röhr	Germany	1,623.75	»
C. Lomberg	Sweden	1,612.55	»

Putting the Weight, best hand.

Immediately after the close of the competition in the running broad jump, the men were called upon to take part in putting the weight. The event was confined to the best hand throw, and here, as in the greater number of the other divisions of the competition, Thorpe proved the best man for, with a throw of 12.89 met., he reached the highest point-figures in this event. Nearest to him came Einar Nilsson, Sweden, with a throw of 12.83 met.; Philbrook, U. S. A., 12.79 met.; Wieslander, Sweden, 12.14 met. and Lomberg, Sweden, 11.67 met. Kugelberg lost many points in this event, as he could do no better than 9.98 met., while Mercer, too, fell considerably on the list, as he did not succeed in throwing farther than 9.76 met., and the Canadian, Lukeman, with a throw of 9.29 met. was the third man from the bottom.

After putting the weight, then, the relative positions of the competitors was considerably altered and, at the end of the first day's competition in the Decathlon, the placing of the first men was as follows:

C. Lomberg.....	Sweden	2,299.55	points.
E. L. Mercer	U. S. A.	2,291.60	»
H. Wieslander.....	Sweden	2,236.30	»
Einar Nilsson	»	2,205.20	»

Running High Jump.

The Sunday's events in the Decathlon began at 9 a. m. with the running high jump. Of the 29 men that commenced the Decathlon, 6 had now retired from the contest, so that there were only 23 who took part in the running high jump. It could easily be seen that a great many of these were far from being specialists in this branch of athletics, 150 cm. proving too much for some of them, and three others being stopped by 155 cm. In this event, too, the Indian, Thorpe, proved his superiority, making the highest jump of the day with a fine effort measuring 187 cm., his nearest men being Philbrook and Lomberg, both of whom cleared 180 cm. Then came Wieslander, Sweden; Lukeman, Canada, and André, France, all of whom took 175 cm. After these followed the other competitors, six of whom managed to jump 170 cm., while five more cleared 165 cm.

After the conclusion of the running high jump, the position of the leaders was as follows :

C. Lomberg.....	Sweden	3,159.55	points
H. Wieslander.....	»	3,026.30	»
G. W. Philbrook	U. S. A.	2,998.90	»
E. L. Mercer	»	2,941.60	»
E. Nilsson	Sweden	2,925.20	»

400 metres Flat.

As the contest continued, the number of the competitors grew less and less, and when the Decathlon men assembled for the 400 metres Flat, there were only 18 who responded to their names. These were divided into 6 heats, with three men in each. Many of the competitors did some really excellent work in this event, Mercer, the best man, running the distance under 50 seconds, quite a remarkable time when one remembers that it was in a ten-event competition.

The first heat was won by the Finlander, Wickholm, in $52\frac{8}{10}$ sec., Wieslander, a Swedish representative, who was next man, taking $53\frac{9}{10}$ sec. The second heat went to Donahue, U. S. A. $51\frac{6}{10}$ sec., Holmér, Sweden, $53\frac{4}{10}$ sec., being second. The third heat included Mercer, who ran in the best time of the day, $49\frac{9}{10}$ sec.; Bie, Norway, $53\frac{2}{10}$ sec., won the fourth heat, and in the fifth, Lukeman, Canada, $52\frac{1}{10}$ sec., beat the Indian, Thorpe, by $\frac{1}{10}$ sec. The sixth, and last heat went to the Frenchman, André, $54\frac{5}{10}$ sec.

As can be seen, the U. S. A. men made the best times, and this added considerably to their total point-figures. Mercer placed himself ahead of Wieslander again, the Swede falling to third man, Lomberg still remaining first. At the conclusion of the race the best point-figures were:

C. Lomberg	Sweden	3,911.39	points.
E. L. Mercer	U. S. A.	3,885.00	»
H. Wieslander	Sweden	3,830.78	»

Throwing the Discus, best hand.

As was generally expected, Philbrook, U. S. A., was the winner of this event, he being quite a specialist in throwing the discus. He made a beautiful cast measuring 41,56 metres, a distance that increased his point-figures very considerably. The next man to him was Schäffer, Austria, 37,14 metres, he being followed by Thorpe, 36,98 met., Wieslander, 36,29 met., Halt (Germany), 35,46 met. and Lomberg, 35,35 metres. Mercer who, it will remembered, had hitherto been very well placed, fell altogether behind after this event, his throw measuring no more than 21,95 metres, and, practically speaking, he was afterwards quite out of the running, this being the case, too, with Lukeman, Canada, who made a throw of no more than 30;52 metres.

At the conclusion of this event the position of the leaders was as follows:

G. W. Philbrook.....	U. S. A.	4,724.82	points.
C. Lomberg	Sweden	4,679.21	»
H. Wieslander	»	4,634.32	»
G. Holmér	»	4,279.38	»

Hurdle race, 110 metres.

In this event, too, the competitors were divided into six heats, each of 3 men. Remarkably good results were obtained in some of the heats, Thorpe's running in the fifth heat being quite a surprise, as he beat the Canadian representative, Luke-man, in the very good time of $15\frac{3}{5}$ seconds. Wickholm, Finland, in the first heat, ran the distance in 17 sec. ; Donahue, U. S. A., won the second heat in $16\frac{1}{5}$ sec., while his fellow-countryman, Mercer, won the third heat in $16\frac{2}{5}$ sec. Bie,

Name	Nation	100 m. Flat	Points	Running Broad Jump.	Points	Putting the Weight b. h.	Points	Running High Jump.	Points
H. Wieslander	Sweden	11.8	762.00	6.42	740.30	12.14	734	1.75	790
C. Lomberg	»	11.8	762.00	6.87	850.55	11.67	687	1.80	860
G. Holmér	»	11.4	857.20	5.98	632.50	10.98	618	1.70	720
J. J. Donahue	U. S. A.	11.8	762.00	6.48	755.00	9.67	487	1.65	650
E. L. R. Mercer	»	11.0	952.40	6.84	843.20	9.76	496	1.65	650
W. Wickholm	Finland	11.5	833.40	5.95	625.15	11.09	629	1.60	580
E. Kugelberg	Sweden	12.3	643.00	6.20	686.40	9.98	518	1.65	650
K. Halt	Germany	12.1	690.60	6.08	657.00	11.12	632	1.70	720
J. Schäffer	Austria	12.3	643.00	6.04	647.20	11.50	670	1.55	510
A. Choultz	Russia	12.3	643.00	5.75	576.15	10.08	528	1.55	510
A. Alsleben	»	12.2	666.80	6.27	703.55	8.48	368	1.70	720
G. W. Philbrook	U. S. A.	12.4	619.20	6.34	720.70	12.79	799	1.80	860
F. R. Bie	Norway	11.7	785.80	6.69	806.45	10.20	540	1.65	650
F. L. Lukeman	Canada	11.2	904.80	6.14	671.70	9.29	449	1.75	790
A. Brundage	U. S. A.	12.2	666.80	6.40	735.40	11.12	632	1.70	720
G. I. André	France	11.6	809.60	5.60	539.40	9.90	510	1.75	790
A. Pagani	Italy	12.4	619.20	5.83	595.75	9.67	487	1.65	650
E. Nilsson	Sweden	11.5	833.40	5.72	568.80	12.83	803	1.70	720
O. Röhr	Germany	11.3	881.00	6.43	742.75	9.81	501	1.70	720
S. Jacobsson	Sweden	11.0	952.40	6.46	750.10	9.35	455	1.55	510
G. Rönström	»	12.3	643.00	5.99	634.95	10.69	589	1.60	580
A. Abrahams	Germany	12.0	714.40	5.52	519.80	11.29	649	1.50	440
P. Failliot	France	11.3	881.00	6.05	649.65	10.54	574	—	—
H. S. Babcock	U. S. A.	11.6	809.60	6.29	708.45	10.16	536	—	—
S. Langkjaer	Denmark	12.0	714.40	5.89	610.45	9.86	506	—	—
W. Hackberg	Sweden	12.5	595.40	5.64	549.20	10.30	550	—	—
M. Legat	Italy	12.1	690.60	5.56	529.60	8.23	343	—	—
M. Megherian	Turkey	13.3	405.00	5.43	497.75	11.05	625	—	—

Norway, proved the fastest man in the fourth heat, his time being $16 \frac{2}{6}$ sec., and André, France, won the sixth, and last heat, in the same time.

This event was the last taken on the second day, and at the conclusion of the hurdles — the seventh event out of the ten — the position of the leaders was as follows:

G. W. Philbrook	U. S. A.	5,553.82	points.
C. Lomberg	Sweden	5,432.22	»
H. Wieslander	»	5,425.32	»
F. L. Lukeman	Canada	5,147.16	»

Pole Jump.

The competitors were very well matched in this event, and there were quite a number that cleared 325 centimetres. As was expected, Mercer, U. S. A., the old specialist in the pole jump, proved to be the best man. He cleared 360 cm. quite easily, and, with a little more caution, would probably have jumped some centimetres higher. The next man after Mercer was a compatriot, Donahue, 340 cm., and then came four who all managed to clear 325 cm., viz., Wickholm (Finland),

the Decathlon.

400 m. Flat	Points	Throwing the Discus	Points	Hurdles 110 m.	Points	Pole Jump	Points	Throwing the Javelin	Points	1,500 m. Flat	Points	Total Points
53.6	804.48	36.29	803.54	17.2	791.00	3.10	670.60	50.40	878.175	4.45	750.40	7,724.495
55.0	751.84	35.35	767.82	17.6	753.00	3.25	751.60	41.83	642.500	5.12.2	587.20	7,413.510
53.2	819.52	31.78	632.16	17.0	810.00	3.20	724.60	46.28	764.875	4.41.9	769.00	7,347.855
51.6	879.68	29.95	562.62	16.2	886.00	3.40	832.60	37.09	512.150	4.44	756.40	7,083.450
49.9	943.60	21.95	258.62	16.4	867.00	3.60	940.60	32.32	380.975	4.46.3	742.60	7,074.995
52.3	853.36	29.78	556.16	17.0	810.00	3.25	751.60	42.58	663.125	4.43.9	757.00	7,058.795
55.7	725.52	31.48	620.76	17.2	791.00	3.00	616.60	45.67	748.100	4.43.5	759.40	6,758.780
54.2	781.92	35.46	772.00	17.7	743.50	2.70	454.60	39.82	587.225	5.02.8	643.60	6,682.445
58.2	631.52	37.14	835.84	18.9	629.50	3.25	751.60	41.06	621.325	5.05.3	628.60	6,568.585
54.6	766.88	31.34	615.44	17.8	734.00	2.70	454.60	38.99	564.400	4.46.4	742.00	6,134.470
59.0	601.44	29.21	534.50	19.5	572.50	—	—	37.34	519.025	5.08.6	608.80	5,294.615
56.7	687.92	41.56	1,038.00	16.8	829.00	2.50	346.60	41.67	638.100	—	—	—
53.2	819.52	31.65	627.22	16.4	867.00	2.90	562.60	48.52	826.475	—	—	—
52.1	860.88	30.52	584.28	16.3	876.50	2.70	454.60	—	—	—	—	—
55.2	744.32	34.07	719.18	17.1	800.50	2.90	562.60	—	—	—	—	—
54.5	770.64	25.37	388.56	16.4	867.00	—	—	—	—	—	—	—
56.1	710.48	30.20	572.12	17.2	791.00	—	—	—	—	—	—	—
—	—	—	—	—	—	—	—	—	—	—	—	—
—	—	—	—	—	—	—	—	—	—	—	—	—
—	—	—	—	—	—	—	—	—	—	—	—	—
—	—	—	—	—	—	—	—	—	—	—	—	—
—	—	—	—	—	—	—	—	—	—	—	—	—
—	—	—	—	—	—	—	—	—	—	—	—	—
—	—	—	—	—	—	—	—	—	—	—	—	—
—	—	—	—	—	—	—	—	—	—	—	—	—
—	—	—	—	—	—	—	—	—	—	—	—	—
—	—	—	—	—	—	—	—	—	—	—	—	—
—	—	—	—	—	—	—	—	—	—	—	—	—
—	—	—	—	—	—	—	—	—	—	—	—	—

Lomberg (Sweden), Schäffer (Austria) and Thorpe (U. S. A.). Holmér (Sweden) had to be contented with 320 cm., and Wieslander, another Swede, with 310 cm.

After the pole jump, the relative positions of the leaders was as follows:

- C. Lomberg..... Sweden 6,183.81 points.
- H. Wieslander..... » 6,095.92 »
- E. L. Mercer U. S. A. 5,951.42 »

Throwing the Javelin, best hand.

Wieslander was the victor in this event, with a throw of 50.40 metres, a distance that procured him the place-figure of 878.17 for this part of the competition. Nearest to Wieslander came Bie, Norway, with 48.52 metres, and then Holmér, Sweden, 46.28 met. Kugelberg threw 45.67 met., and, with a throw measuring 45.70 met. Thorpe managed to place himself amongst the foremost in this event, too. In general, the U. S. A. men showed little acquaintance with this branch of athletics, and here many of them lost a great number of valuable points, with the result that they were quite out of the running for the final placing. The position of the leaders after this event was:

H. Wieslander	Sweden ..	6,974,095	points.
C. Lomberg	» ..	6,826,310	»
G. Holmér	» ..	6,578,855	»

1,500 metres Flat.

The competitors were divided into three heats. Of those that had taken part in the competition up to this point, Bie and Philbrook were the only ones that did not now put in an appearance.

In the first heat, Holmér led for the greater part of the distance, and won pretty easily from the Finlander, Wickholm. Wieslander was fourth in this heat. — In the second heat, Mercer led nearly all the way, but towards the finish, Kugelberg (Sweden) went to the front and won as he liked in 4 min. 43 ⁵/₁₀ sec. The third and last heat was Thorpe's, who ran the distance as good as alone, the rest of the field being a long way behind the leader, with Lomberg last of all. The placing of the Swede, however, was already so very good that, in spite of his bad show in the 1,500 metres flat, he managed to secure a position among the prize-winners.

Of the 29 competitors that started in the Decathlon only 12 took part in all the events.

The Decathlon table shows the final placing and place-figures of the competitors.

SOME GENERAL REFLECTIONS AND WISHES CONCERNING FIELD AND TRACK ATHLETICS.

The Committees that had to make the arrangements for the Olympic competitions in athletics were, first of all, seriously inconvenienced by the fact that there does not exist any standard-programme for the competitions in this division of the Games. It is true that every endeavour was made to draw up the programme in as exact agreement as possible with all the demands made by the nations that competed, but it is a very old truth, of course, that it is impossible to satisfy everybody, and the programme of the athletic sports for the Olympic Games of 1912, too, has been criticized, and hints have been made that Swedish interests, in particular, were altogether too much considered in drawing up the lists of events. But all the various athletic competitions on the programme had, as a matter of fact, already won international recognition, and only the throwing competition with both the right hand and the left hand were novelties to the representatives of some countries when the list of the various events were sent out in good time before the beginning of the Games. The principle of using both the right and the left hands in throwing competitions is, however, one of ancient date in Northern Europe, and, in any case, can be considered as a perfectly correct one. There was no promotion of any special Swedish interests, however, by the inclusion of the throwing with the left and the right hands, as may be seen by the lists of results in these competitions. But, in order to avoid future discussion on the subject, it is to be hoped that a standard-programme will be drawn up, and will be in force at all future Olympic Games. By the adoption of such an arrangement, all nations will be placed on an

equal footing as regards the preparations for the branches of athletics which are to form the programme of the Games.

Another question, the early and satisfactory solution of which is also a matter of great importance, is the fixing of uniform rules and regulations for the competitions. In the case of earlier Olympic Games the rules in force in the country where the Games were to be held were those adopted for the meeting. The Swedish Sub-committee for the athletic competitions, however, did not consider this plan a suitable one, but special Olympic rules for the competitions were drawn up, based on those in force in some ten of the countries where athletics are most in vogue. In this manner, the rules and regulations in force at the Olympic Games of 1912 were a selection of the best amongst the rules of these various countries. With these rules as a basis, perfectly satisfactory standard-rules for the Olympic Games could most certainly be drawn up.

Another wish that was pretty generally expressed at the Olympic Games of Stockholm was, that the number of competitors from each nation in each branch of athletics should be restricted to 6 or 8, instead of 12 as the case now is. Most undoubtedly, the present regulation on the subject confers certain advantages on the country that is to be the scene of the Games, and on those countries lying nearest to the one where the Games are to take place. In many cases, financial reasons make it impossible for countries at greater distances to be so fully represented in the various competitions as they might otherwise wish to be.

TABLES SHOWING THE POSITION OF THE VARIOUS COUNTRIES AS REGARDS POINTS OBTAINED IN FIELD AND TRACK EVENTS.

As in the preceding Olympic Games, an official system of counting points had been fixed, according to which, each nation, whose representative gained a first prize received 3 points, 2 points being awarded for a second prize and 1 point for a third prize. The position of the nations in accordance with this official system of counting points is given in the following table:

Country	1:st prize	2:nd prize	3:rd prize	Points
U. S. A.	14	13	12	80
Sweden	5	5	5	30
Finland	6	4	3	29
Great Britain	2	2	5	15
Canada.....	1	2	1	8
South Africa	1	1	—	5
Greece	1	—	1	4
Germany	—	2	—	4
France	—	2	—	4
Norway	1	—	—	3
Italy	—	—	1	1
Hungary	—	—	1	1

DIPLOMAS OF MERIT.

In agreement with the course adopted at earlier Olympic Games, the Swedish Olympic Athletic Committee has also awarded special diplomas of merit, in addition to the three prizes usually given in each branch of athletics. These diplomas have been presented to the athletes who did not win a prize in an event, but who obtained such good results that the Committee considered that they should be rewarded by means of an official acknowledgement in the form of a diploma. As was just said, the diploma has been given only to those athletes who obtained very good results but did not gain any prize. Of course, this must be taken to mean that a competitor who, for example, gained a prize in the 100 met. flat but who, in the 200 met. race was not placed among the first three, in spite of his making very good time, would receive a diploma of merit for his result in the 200 met. event.

Altogether, 111 diplomas of merit have been awarded in athletics, and these have been divided in the following way between the various nations : U. S. A, 44, Sweden 30, Finland 8, Canada 7, Great Britain 6, Norway 5, Germany 3, Austria 2, South Africa 2, Hungary, Denmark, France and Greece, 1 each.

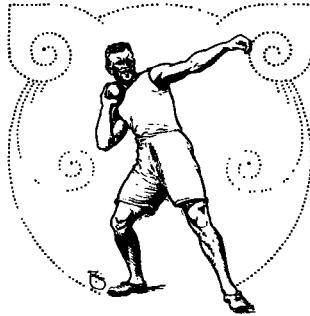

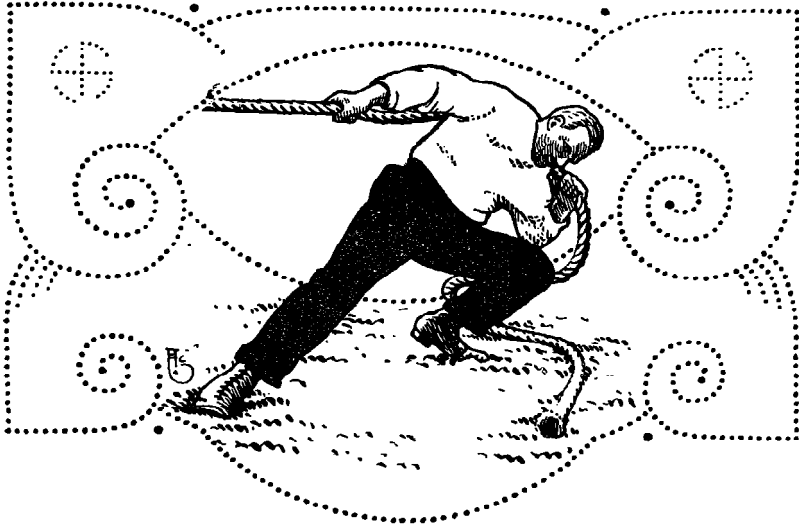

THE TUG-OF-WAR. ITS ORGANIZATION.

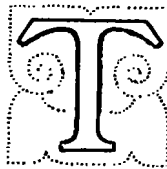

he tug-of-war competition was included in the programme for field and track events when the invitations to the Olympic Competitions were issued, the Committee for Athletics having the management of this event too. At the beginning of October, 1911, the Secretary of the Swedish Olympic Committee issued an appeal in the sporting press of the country, begging those interested in the matter to attend a meeting to be held on the 17 October at the offices of the Olympic Committee "in order to discuss the question of carrying out organized training all over the country and to take other measures to solve the problem of Sweden's participation in the tug-of-war competition". Some 15 persons attended the meeting in question, and, after an animated discussion, a motion was passed for the appointment of a special committee for the tug-of-war competition. The Swedish Athletic Association afterwards approved of the choice of the following Committee for the Tug-of-war competition.

President:..... Captain GÖSTA DRAKE.
Vice-President: Lieutenant E. KILLANDER.
Secretary:..... KRISTIAN HELLSTRÖM, Esq.
Other Members: Sergeant A. ALMQVIST,
 Lieutenant A. DAEVEL,
 Paymaster NILS DJURBERG,
 Police-Inspector A. FÄLDT,
 Lieutenant C. GYLLENHAMMAR,
 J. AF KLERCKER. Esq.

Police-Sergeant G. H. LINDMARK.
Sergeant A. HJ. WOLLGARTH.
Lieutenant B. EKSTRÖM.

The first thing to be done was, of course, to begin the systematic training of our competitors for the event, and then to issue an invitation accompanied with as complete a list of rules as possible. After four preliminary and three final try outs, in all of which the first team of the Stockholm Police was victorious, the team mentioned was chosen to represent the blue and yellow flag of Sweden against the redoubted City of London Police team and other opponents. The Swedish team was composed as follows: Constables A. L. Andersson (Captain), A. Bergman, J. V. Edman, E. A. Fredriksson, C. Jonsson (anchor), E. V. Larsson, — all belonging to the Stockholm Police — Aug. Gustafsson, of the Gothenburg Police, and Mr. C. H. Lindström, Sandhamn. The reserves were Constables D. Larsson, Hj. T. Lundberg, G. S. Strid (Stockholm Police) and Corporal O. E. Sköld, Göta Life Guards.

At first, very short and simple rules had been issued by the Committee for Athletics in the invitation programme for the Tug-of-War competition, but it was now found necessary to revise them and make them considerably stricter. The new rules were specially directed against the turning allowed at the Games in 1908, and also against the plan, adopted by some teams, of making a spring upwards on the word being given to start, so as to get a fast foothold, or hollow, for the feet.

We shall now let the protocol tell its own tale.

THE COMPETITION.

On the close of entries, June 6, five nations had announced their intention of sending a team for the tug-of-war competitions; these were Austria, Bohemia, Great Britain, Luxemburg and Sweden. In order to make the competition as just as possible, the Committee had determined that each team should compete against all the other teams and, after lots were drawn and the dates of the matches fixed, the programme was as follows:

Sunday,	7	July: Bohemia v. Great Britain ; Sweden v. Austria.
Monday,	8	› Great Britain v. Sweden; Luxemburg v. Austria.
Tuesday,	9	› Luxemburg v. Great Britain; Bohemia v. Sweden.
Thursday,	11	› Luxemburg v. Sweden; Bohemia v. Austria.
Friday,	12	› Great Britain v. Austria; Bohemia v. Luxemburg,

For the competition, the Committee had been given a sand track situated at the north end of the Stadium arena, 40 met. long and 8 met. wide, and before the beginning of the competitions the ground became very good indeed, and of a sufficient hardness. New ropes were procured, and to enable those of the spectators that were seated at a distance to follow the progress of the competition, flag staffs with



GT. BRITAIN'S TUG-OF-WAR TEAM.
To the left, Mr. CHAFFE, the captain.

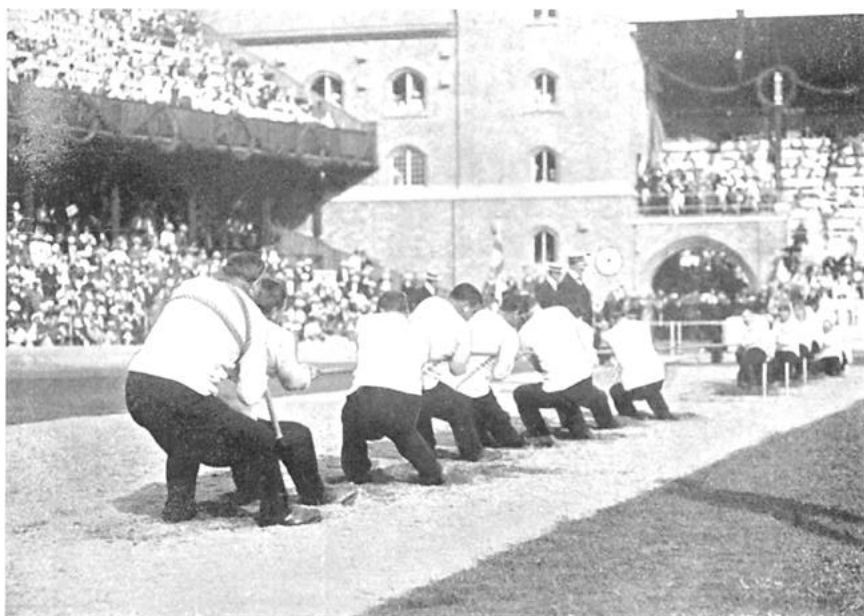

TUG-OF-WAR. GT. BRITIAN V. SWEDEN
The first bout; won by the Swedish team. The British team to the left.

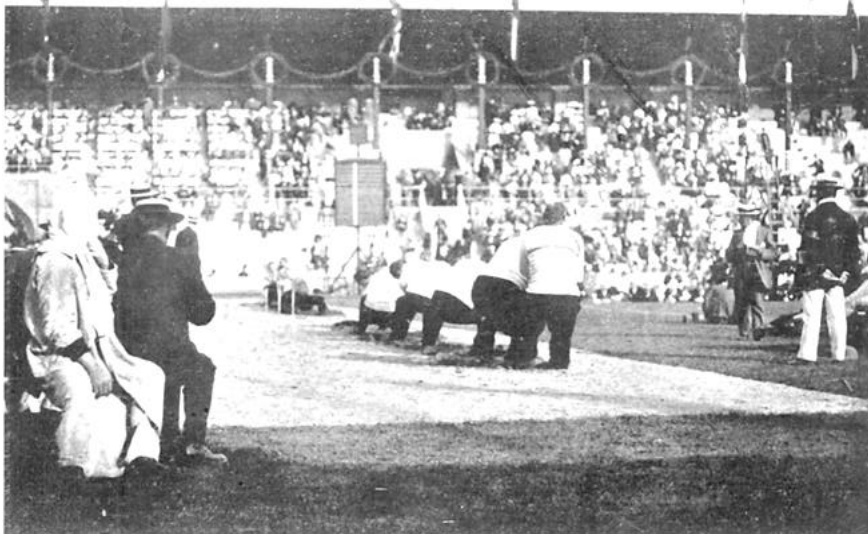

TUG-OF-WAR: GT. BRITAIN V. SWEDEN.



Second bout in Tug-of-War, Gt. Britain v. Sweden. Gt. Britain lost on a foul, several of the team sitting on the ground.

the flags of the competing nations were provided, to be placed at the sides of the track where the respective teams were pulling.

The competition as a whole was disappointing, as, of the five nations entered, only two took part in the event. When, at 3.45 p. m. on Sunday, the 7 July, the match between Bohemia and Great Britain was to begin, the stately British team was the only one that marched into the arena, the Bohemians, for some unknown reason, not putting in an appearance. Great Britain's team was therefore declared the winner of this match.

The same thing happened in the next bout, which was to be held the same day, for, at 5 p. m. the Swedish Police team awaited in vain the arrival of its opponents, the Austrians. The British and the Swedish teams could thus count a win each, without catching even a glimpse of their opponents.

But when at 5.15 p. m. on Monday, the 8 July, notice was given through the megaphones of the beginning of the tug-of-war match for the day, there marched in simultaneously from either tower-entrance, the teams from Great Britain and Sweden. The first-mentioned seemed cast in a more massive mould than the latter, although the Swedish eight seemed a formidable one, in consequence of the finely and harmoniously developed athletic forms of the men.

Great Britain's team was as follows: A. Munro (b. 1870), J. Shepherd (b. 1884), J. Sewell (b. 1882), J. Dowler (b. 1879), E. Mills (b. 1878), F. Humphreys (b. 1878), M. Hynes (b. 1883), and W. Chaffe (b. 1870), all of whom, excepting J. Sewell and M. Hynes were members of the victorious British team at the Olympic Games of London, in 1908.

On drawing lots for sides, the British team won and elected to pull with the sun at its back. The rope lay at full length along the ground, and the teams took up their positions alongside it. The leader of the competition explained the words of command that were to be given, and then everything was in readiness. A feeling of the intensest excitement filled the atmosphere; not a movement was to be seen among the thousands of breathless spectators that filled the stands of the Stadium.

"Ready!" — "Pull!". The rope is lifted from the ground; it tightens and trembles like a well-tuned violin string, for a tremendous amount of massed strength is exerted on each side. The red knots on the rope seem, at first, as if they were nailed fast to the dividing lines, but, after about 30 seconds, the blue band marking the middle of the rope begins slowly but surely to move towards the Swedish side, and, with short, powerful pulls, the Swedish Police draw their City of London comrades gradually nearer to the fatal middle line. For one single moment, which to the spectators seems an eternity, the strife appears uncertain of issue, but then again the Swedish team begins to draw in inch after inch of the rope, until, at last, the judge's red flag is lowered as the signal that the home-team has succeeded in the first pull. A thunder of applause roars through the Stadium, the spectators shouting and stamping with joy at Sweden's success.

The pitch is once more made in readiness and the rope laid down afresh and, after an interval of 5 minutes, the leader summons the teams to meet for the second pull. Having changed sides, the British team now faces the sun, but it gives a tremendous pull, and the Swedes are drawn forward a considerable distance. Then the rope stands still again and, in a short time, the short, intensive "Hej" shout of the Stockholm Police is heard, and the line moves slowly back to their side of the ground. Once or twice the central mark moves in indecision a few inches backwards and forwards, but then the knots on the line suddenly stand still, and the judge's flag falls for the second time. Neither team has succeeded in drawing its opponent across the central mark, but the verdict goes in favour of the Swedish team on this occasion too, as a couple of the British team have become so exhausted during the pull that they sink to the ground, unable to rise again in spite of the repeated admonitions of the judge to do so.

As the Luxemburg team made no appearance when called on, this trial of strength and skill between the chosen representatives of the London and the Stockholm Police was the only match in the tug-of-war competition during the Olympic Games of 1912.

The Gold Medal was thus awarded to Sweden and the Silver Medal to Great Britain.



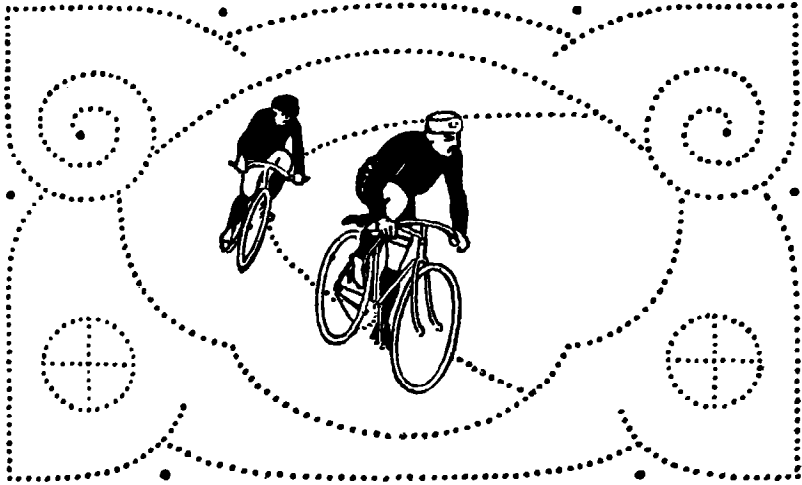

CYCLING.

ROAD RACE ROUND LAKE MÄLAR DURING
THE OLYMPIC GAMES OF STOCKHOLM 1912.

ORGANIZATION.



hen, in 1910, the Swedish Cycling Association appointed the Committee which, together with those nominated by the other Swedish Athletic Governing Bodies, was to have the task of arranging and carrying out the various details of the vast programme of the Olympic Games of Stockholm, the Association mentioned received at the same time the far from welcome information that the only cycle track possessed by Stockholm was to be destroyed, for the purpose of making way for the new Stadium, and that it was not intended to build any new track for cyclists — not even for the Olympic Games of 1912. There could not, therefore, be any question of holding track-races during the Games.

Ever since the year 1901 the race “round Mälär” has certainly been the most popular road-race in Sweden in cycling circles. The competition in question dates back to 1892—93; but after these two years of what may be called premature existence, nothing more was heard of it until the beginning of the new century. In 1912 the event was raised by the Swedish Cycling Association from being the Swedish Long Distance Championship Road Race to a place of honour, as the competition for the premier cycling honours of the world.

The Olympic Cycling Committee was elected by the Swedish Cycling Association at the beginning of 1910, and at once began the

necessary preliminary preparations. The Committee in question, when its numbers were complete, comprised the following members:

President: Captain C. G. DRAKE, President of the
Swedish Cycling Association.
Vice-President: . . A. STORM, Esq.
Treasurer: O. KRAEPELIN, Esq.
Secretary: C. ULLÉN, Esq.
Other Members: ERIK PALLIN, Esq.,
FRANS PETERSSON, Esq.,
S. AKERSTEDT, Esq.,
K. S. HELLBERG, Esq.,
C. F. R. PLATIN, Esq.,
E. SALMSON, Esq.

A special Training Committee, consisting of Messrs. Hellberg, Pettersson and Akerstedt, was chosen from among the members of the principal Committee, for the purpose of arranging, carrying out and supervising the training of the Swedish cyclists.

Early in 1911, a great number of inquiries began to be received from abroad, together with requests for the programme and proposals for amendments in the scheme drawn up, etc. Several nations, too, came forward with additions that they wished to have made to the programme.

One thing that caused a considerable amount of trouble at first, was the determination that all those who intended taking part in the cycling competition, should be provided with a certificate issued by the Union Cycliste Internationale, or by an Association affiliated to that body. Two years before the date mentioned, Germany had withdrawn from the Union, and would not now consent to be compelled to apply to its Committee for a license. The matter was arranged, however, by the Swedish representative at the Congress of the Union Cycliste Internationale, at Paris in February, 1912, and the German Association applied for, and obtained, re-admission to the International Federation in question.

The complete ignorance, shown by many nations, of the existence of the Union Cycliste Internationale and of the method of applying for, and obtaining, the license, also caused some difficulty, but, finally, all these matters were settled satisfactorily. The immediate result of all this trouble about the license was, that all those nations which previous to the Games, had not been affiliated to the Union, took steps to obtain admission to the Federation as soon as they were concluded. The Union Cycliste Internationale has, therefore, grown both in numbers and in strength, as a result of the Olympic Games of 1912.

Several nations requested that track-racing should be included in the programme, but for reasons mentioned on the preceding page, the Committee was, unfortunately, not able to comply with this wish.

Germany asked to have Cycle-Polo and Figure-Cycling placed on the programme, but the Committee considered that it could not comply with this request; first, as far as Cycle-Polo was concerned, because it would be impossible to procure a suitable ground for such an event without going to very great expense, and, secondly, with regard to Figure-Cycling, because this sport could not be considered as being of such athletic importance as to deserve a place on the Olympic programme.

THE METHOD OF STARTING.

Proposals and criticisms respecting the method of carrying out the race were received from many quarters, most of them dealing with the same subject, however, and asking for an alteration of the plan of starting. It was to be expected, of course, that the regulation that the competitors were to start one at a time, at intervals of a couple of minutes, would awaken much opposition abroad, where the custom is for all the riders to start at once. The question had been most thoroughly discussed by the Committee, however. For one thing, the probable number of competitors was not yet known, although the Committee imagined that there might be 100, at most. With such a number, how would it be possible to have all the competitors starting at once in an international race of such importance, and on our Swedish roads, which can by no means be compared with the fine, broad highways of France, Germany or Great Britain, which almost seem to have been constructed with a special view to such competitions. The thought of a simultaneous start, therefore, was at once banished, especially as the Committee was well aware that the Police authorities would never give their consent to such a proposal. And, we may ask, what would have been the result of letting all the 123 competitors that actually took part in the event, starting at one and the same time?

The next idea of the Committee was, to let the competitors start in groups, but it was difficult to draw up the scheme necessary for such a method several months in advance, the Committee having no idea, at the time, of the number of nations that intended to compete, or of how many representatives would be entered by the countries in question. In addition to this, the police absolutely forbade any other kind of start excepting that of sending the riders off one at a time, on account of the traffic along the roads.

It was determined, then, that the method of starting long employed, and approved of, in Sweden, should be used for the race in question. The Committee resolved that there should be an interval of 3 minutes between two starters, but this had to be altered, and the interval fixed at 2 minutes, instead.

THE PREVENTION OF PACING.

Another thing which, long before the event came off, was subjected to much criticism, was the rule: "Pacing by *non-competitors* is strictly forbidden during the race", although, according to the method employed

for the drawing of lots, there would not be the least risk of the representatives of any one nation pacing each other either.

THE ARRANGEMENTS ALONG THE COURSE.

The labours of the Cycling Committee were continued at high pressure during the whole of the winter, 1911—12. Lists of officials were drawn up and a letter was addressed to each person chosen to fill such any post, asking him to forward to the Committee a written pledge that he was willing to undertake the duties of the post during the Cycling competition, and that he would keep the rules and regulations of the Committee and the leader of the competition. For the purpose of establishing control-stations in the country districts along the course, the President of the Committee was desired to personally visit the places in question, and form Control-Committees there. This trying work had the best possible result, however, thanks to the kindness and good-will of everyone concerned. And it was by no means a little troop of assistants that was required, but quite an army of able, interested and experienced men had to be mobilized. Captain Gösta Drake, president of the Cycling Committee, was elected to be the chief manager or leader of the competition, assisted, in the first place by the other members of the Committee, who had the direction of the various details of the work under the leader's general superintendence. Altogether, there were no less than 73 officials required in Stockholm alone for this competition, and 89 in the country districts, or a grand total of of 162 men.

A series of regulations, drawn up by the leader and approved of by the Committee, was issued for the officials acting at the starting-place and at the finish, as well as for those functionaries on duty at the various control-stations along the course.

According to the instructions for the control committees in the country districts, each of the said sub-committees was to be responsible for its own section of the course, i. e., the said committee was answerable for that part of the course lying from and between the control-station in question, to the next station in the direction of the finish. For example, the Södertälje station had to answer for the section Södertälje—Mariefred; Mariefred for the section Mariefred—Strängnäs, and so on. A four-fold object was served by this regulation, viz. :

- 1) The arrangement and carrying-out of the steps necessary for keeping each section of the course clear and fit for the race;

- 2) The keeping open for road-traffic of all canal- and other bridges, railway-crossings, and the like, during the time when the competition was being held, and the seeing that such bridges and crossings were clear for cyclists; there were also to be at each such place not less than two control officials for the purpose of calculating the time a competitor would lose in the event of a bridge being closed to traffic on his arrival at the spot, and in order to be able to give information, etc., to foreign competitors, etc.

3) The obtaining aid from the local police-authorities, for the purpose of admonishing the public to observe correctness of behaviour towards the competitors, so that there would be no disturbance of the peace, and

4) the exercising proper supervision of the competitors, so as to prevent, as much as possible, all illegal pacing.

From the very beginning, the Committee felt the absolute necessity of having the roads and the bridges in the best possible condition. In order to facilitate the labours of the control committees in this respect, written application was made to the County Government Boards of all the counties through which the course ran, begging them to request these responsible for keeping the roads in order, not to mend the roads immediately before the race, by laying down stones, but to do their best, in every possible way, to repair the roads and bridges beforehand, wherever necessary. The County Government Boards were also begged to assist the Committee by seeing that the high road around Lake Mälär, i. e., along the course, was in as good repair as circumstances would allow, so that the competitors would suffer as little inconvenience as possible in this respect. Written application was also made to all the Canal-, Transport-, and Railway Companies that could be in any way affected by the competition, begging them to allow the bridges across the water-ways to be clear for road-traffic, and the bars and the gates at the railway crossings to be open, during the race.

The Cycling Committee also wrote to the State Telegraph and Telephone Co., and to the Stockholm Telephone Co., asking to have extra telephones put up, and also to have the ordinary telephone offices open all the time the race lasted, and, consequently, during the early hours of the morning, too.

All the various departments to which the applications in question were made, showed the greatest willingness to oblige, and promised to do their best to comply with the wishes of the Committee; a promise faithfully kept when the race came off.

Towards the spring of 1912 the Cycling Committee found itself obliged to open its own offices, and took advantage of the kind offer made by O. Kraepelin, Esq., who placed two of his private rooms at the full disposal of the Committee, free of charge. The arduous work of the last two months was carried out at these temporary offices, the address of which was 42, Kommendörsgatan.

The Swedish Cycling Association arranged that the annual race round Lake Mälär, which forms the Swedish long distance championship road race, should be the final try out for the cyclists from whose ranks the Swedish representatives were to be chosen.

THE NUMBER OF COMPETITORS.

The entries for the cycling competition closed on July 7th, at 12 p. m., and showed the surprising result that no less than 19 nations had entered for the Race round Lake Mälär, with 151 competitors and 15 reserves. This number was considerably larger than the Cyc-

ling Committee had counted on, and proved that the interest taken in the competition was very great. The entries were divided among the various nations as follows:

Nation	Entries	
	Competitors	Reserves
Austria	6	—
Belgium	2	—
Bohemia	5	—
Canada	5	—
Chili	4	—
Denmark	8	—
England	12	4
Finland	6	—
France	12	4
Germany	12	2
Hungary	12	—
Ireland	9	—
Monaco	2	—
Norway	7	—
Russia	12	—
Scotland	12	—
South Africa	1	—
Sweden	12	5
U. S. A.	12	—
Total	151	15

THE DRAW FOR THE START.

The draw for the order of starting, a matter of special importance in such a competition as this, took place at the first meeting of the Committee after the close of entries, and in accordance with the following principles.

First of all, the nations entered were divided into groups of 12 riders (the highest number of cyclists any nation was allowed to enter), and lots were drawn to decide the order in which these nations should start in respect to each other. In the groups which were composed of competitors from more than one nation, lots were also drawn to decide the order of starting of the various nations in the groups. By means of this system of drawing lots, the various groups, and also those nations that belonged to one and the same group, came in the following order: 1. France; 2. South Africa, Monaco and Ireland; 3. Sweden; 4. Chili and Denmark; 5. Austria and Finland; 6. Hungary; 7. U. S. A.; 8. Scotland; 9. England; 10. Norway; 11. Germany; 12. Russia; 13. Belgium, Bohemia and Canada.

After this, there was made a final draw, to decide the starting order of the various competitors with respect to each other, this being carried out as follows. First there was drawn, as No. 1, a cyclist from France; then, as No. 2, one representing South Africa; as No. 3, one from Sweden, and so on. In the groups consisting of more than one nation, all the competitors representing the nation that was drawn first

in that group, were first drawn, before any cyclist of the next nation in that group was taken. In consequence of the plan thus adopted for the drawing, it was found possible to prevent two members of the same nation pacing each other.

THE MANAGEMENT OF THE COMPETITION.

By means of the grand try out, held on the 2 June, and which was arranged as a general rehearsal of the coming Olympic race, the Cycling Committee had an opportunity of seeing how the machinery of the whole worked; if all the cogs were there, so to say, and if they engaged in each other as they should. All those persons that had been asked to act as officials were requested to be present at the try out, but before the event came off, the leader of the competition summoned all the officials — those who were to be stationed in the country places, as well as those that were to be on duty in Stockholm, on the occasion of the Olympic Race — to a meeting in Stockholm, 120 persons answering the call. At this meeting, the leader read and explained the “Instructions for officials”, etc., and the functionaries were given the opportunity of making themselves perfectly well acquainted with their duties, by means of questioning, etc. The race on June 2, showed that all the arrangements, with the exception of one or two details of minor importance, were the best possible.

At the start in the try out, which took place on the high road just opposite the primary school at Liljeholmen, the building mentioned was very kindly placed at the disposal of the managers of the race by the head master, Mr. A. G. Kjellberg. It was found possible to make every desirable arrangement in the large, light and convenient rooms, for the comfort both of the officials and the competitors, who found here warm and pleasant rooms for changing clothes, and for the medical inspection as well, in those cases where it had not previously been carried out. Those who came too soon to the starting place were able to rest here in comfort, while, in the large school-yard, there was plenty of room for cycles, the assistants, etc. The important matter of the time-keeping had also been arranged in the best possible way, and first-class chronometers were employed, placed at the disposal of the Committee by F. Höglund, Watchmaker, Stockholm.

The eleven Control Committees, too, — at Södertälje, Läggesta (Mariefred), Strängnäs, Eskilstuna, Kungsör, Köping, Västerås, Enköping, Bålsta and Järfva — did their work excellently. By each of these control committees arrangements had to be made for:

- a) the presence at the stations of persons of linguistic acquirements, or the purpose of rendering the necessary assistance to foreign competitors; the languages that had to be represented first and foremost were English, German, French and Russian, in the order given;
- b) a special attendant to superintend and manage any necessary repairs to the cycles;
- c) a doctor — who, if not actually present, had to be ready to come at a moment's call, if necessary;

d) interesting the local Press in the race, so that the public could be made acquainted with the competition and various details in connection with it.

The instructions for the control committees also contained regulations respecting the telephone arrangements, the use of secret control officials, the reckoning of time lost at open bridges, railway crossings, etc., the providing of suitable refreshments for the competitors, etc.

At the finish, which, according to the original plan, was to have been inside the Stadium, the management had the south-western tower placed at its disposal. Three extra Riks telephones and three additional Stockholm Telephone Co's apparatus were procured specially for this race, while, besides these, which were in direct connection with the chief telephone office in the town, there was a special switch-station in the Stadium, with a number of telephones in the vicinity of the office near the finish, which could be used in case of necessity. In order to keep the public acquainted with the progress of the race, there had been put up just outside the great entrance towards Valhallavägen, between the gate and the railings, and also behind the northern stand, large result-boards, on which were displayed the names, numbers and starting-times of all the competitors, with spaces in which could be written the hours of the arrival of the men at the various control stations. A similar result-board, but of smaller dimensions, was placed close to the stairs of the Press Gallery. All these boards were revised every half hour, so that the public could see, at a glance, the position of the various competitors along the course, and the times made to the different control stations. At the finish, too, of course, arrangements were made for supplying the competitors with refreshments, any necessary medical aid, etc.

ALTERATIONS MADE IN THE RULES.

Both on account of the experience gained by the try out on the 2 of June, and of one or two other circumstances influencing the decision come to, the Committee found itself obliged to make one or two little alterations in the "Special rule" first issued for the Olympic Competition and sent with the official invitation to the Games. As already mentioned, the interval between the competitors at the start was changed from 3 minutes to 2. In order to lessen the inconvenience that would be caused to competitors by their having to prove their identity at several control stations by signing their names, it was determined that this should be done at one such station only, viz., that at Köping (the turning point towards Stockholm). In consequence of the competitions in athletics going on simultaneously with the arrival of the cyclists at the intended finish in the Stadium, it was determined to have the winning-post on the northern carriage-way in Valhallavägen, almost opposite the Sofiahemmet Hospital, at which spot, therefore, a tent was raised, which was placed in telephonic communication with the Cycling Offices in the south-western tower of the Stadium. All possible steps were taken here for the convenience of the judges, timekeepers and other functionaries, and

of the competitors, too, of course. But, although the time was taken at this spot, just outside the Stadium, the competitors had to ride on into the Stadium through the principal entrance, *turn to the left* and cycle *half a lap along* the running track, where they would be met by their countrymen and assistants.

In order to render the greatest possible assistance to the competitors, and especially to those that were unacquainted with the Swedish language, the leader of the competition drew up a P. M. which was printed in English, French, German and Swedish editions, and given to the various competitors in the language they best understood. This P. M. contained all the information the competitor needed to be able to be present at the right time at the starting place, etc., and was as follows :

1. *The competition* will take place on Sunday, July 7th ; the first man starting at 2 a. m.
2. *The medical examination*, which is obligatory for *everyone* taking part in the race, will take place on Saturday, July 6th, from 2 p. m., at the Primary School, 63—65 Valhallavägen, near the Stadium.
You are requested to present yourself for this examination at p. m.
3. *The start* will take place on the high road in front of the schoolhouse, 1,000 metres (ca. $\frac{3}{4}$ mile) south of Liljeholmsbro (L. bridge), which is situated on the south-west outskirts of Stockholm.
4. *Your number in the competition* is
5. *You must present yourself at the starting-post not later than* a. m.
6. After dressing for the race, *unnecessary clothing* will be left in charge of the starter's adjutant (who wears a brown and blue badge on his arm), who will transport each competitor's things, enclosed in a separate sack marked with the name of the competitor, to the dressing room of his nation in the Stadium.
7. Each competitor shall wear, both on his breast and back, the number which has been assigned to him by lot.
8. *Your starting-time in the race* is a. m.
Your *reserve-machines* have been stationed by the Committee at
9. At the start and the finish, the competitors *must not be assisted by anybody else* than persons approved of by the Committee ("start-helpers").
10. *The words of command* on starting are:
30 sec. before the start : "Sitt upp!"
5 » » » » "Färdigza!" (Ready !), and
on the stroke of time: "Gå!" (Go !)
11. *All pacing by persons who are not taking part in the race is strictly forbidden*, and no person not taking part in the competition will be allowed to accompany the competitor.
Refreshments must only be given by persons on foot.
12. During the race the competitor shall *keep to the left*, and shall ring his bell, or other signal, in good time, to warn anyone coming in the opposite direction.
13. In the case of a competitor being, *necessitated against his will*, to wait at the canal-bridges at Fittja, Södertälje, Eskilstuna, Kungsör, Kolbäck, Stäket or Älkistan, the time he has lost at any of these places, in order to allow of the passage of a boat, will be deducted from his total time.
Such a deduction will not be made, however, for a delay caused at any of the railway crossings.
14. At the control station at Köping, you must *sign your name* on the list kept there, in order to show that you have passed the place.
15. Refreshments can be had at all the control stations.
16. *If you retire from the competition*, you are bound to give notice of the fact at the nearest control station as soon as you can, and also to take off your number.

17. On your arrival at the Stadium, you must *ride half a lap round the Stadium track, beginning from the left*. Your time will be taken before this lap is begun, however.
18. In other respects, the competition will take place in accordance with the U. C. I. regulations for racing's.

Thanks to this P. M. the competitors were not obliged to keep on making inquiries every now and then, but, as they all acknowledged after the race, they were able to ride on knowing very well what they had to do. The P. M. was placed in the hands of each nation-leader as soon as he presented himself at the Office of the Cycling Committee, or as soon as the Committee learned of the arrival of the various nations in Stockholm and of their addresses in town.

* * *

Everything now seemed to be in readiness for the cycling competition "round Lake Mälär", but it was hardly possible to foretell what would happen at the grand road race. It could be seen, of course, from the entries, that the match would be an exceedingly keen one, for the very best amateur cyclists from abroad intended competing, and it scarcely lies within the scope of this report, written by Swedes, to discuss the possibilities for and against a Swedish victory. This may be said, however, that those amongst us who took the trouble to try and discover the most dangerous rivals of our representatives, considered that they were to be found among the cyclists from England, France and Finland. But, on the other hand, there were many nations competing, of whose men one knew next to nothing, so that there were really dozens and dozens of "dark horses". In a word, the excitement was intense and the result most uncertain, although hopes were entertained of Sweden being placed at least in the team competition. As far as the individual competition was concerned, however, it was considered, and with very good reason, that the Swedes were "out of the running".

RECEPTION OF THE FOREIGN GUESTS. MEETINGS, ETC.

Our guests from abroad began to arrive as early as the middle of June. The Chilian representatives were the first to put in an appearance, and then came one contingent after another in quick succession, It was a matter of course that all other the competitors should want to cycle over the course once or twice, in order to make themselves acquainted with it, and to examine the character of the road, which the Committee, in its official correspondence, had by no means described in too glowing colours, or as a first class one. During the course of all the experimental runs which were undertaken by our visitors from abroad, they were received and cared for, as they unanimously acknowledged, in the most obliging and hearty fashion, our own representatives outdoing themselves in their endeavours to be of every service to their foreign rivals.

Everything, then, pointed to a most successful meeting and, on Friday evening, July 5, the Swedish Cycling Association invited a

number of its guests from abroad to a banquet at the Grand Hotel Royal, some 50 persons being present. Those invited consisted of the honoratiorees, as they were called, i. e., the managers or leaders of the teams, and the chief representatives for cycling sport. The occasion served to make the visitors from abroad acquainted with the Swedes and with each other, and a most harmonious spirit prevailed, which, there is every reason to believe, lasted long after the evening was over.

There was one drop of bitterness in the cup, however, and that we had to taste the very next morning, for the representative of France protested against the determination of the Cycling Committee to allow England, Ireland and Scotland to compete as separate nations. At the meeting of the Cycling Committee which was held subsequently, when there were present the Rev. Mr. Laffan, representing Great Britain, and delegates from each of the three nations in question, the Committee determined to stand by its resolve. On Saturday evening there was another meeting, at which were present the representatives of all the nations taking part in the competition, who, according to the rules of the Union Cycliste Internationale, had to elect three "commissaires de course" and the following gentlemen were chosen to fill these positions; Comte d'Arnaud, France, Herr Baeckling, Germany and Mr. Blair, England. The three commissaires at once held a meeting together with Captain Drake, leader of the competition, Mr. Salmson, one of the judges at the finish, and Mr. Ullén, the secretary of the Committee, when Captain Drake informed the three commissaires of the circumstances leading to the determination of the Committee to allow England, Ireland and Scotland to each be represented by 12 competitors, i. e., to appear as separate nations. The Cycling Committee regretted that this concession had been made, but declared at the same time that, as the teams from the countries in question had come to Sweden to take part in the event, the Swedish Cycling Committee did not wish to prevent them from doing so, and that the Swedish Cycling Association intended to take the responsibility for their so doing on its own shoulders, should any steps be taken in the matter by the Union Cycliste Internationale. The reason the Cycling Committee had made the original, illegal concession to Great Britain was, that in the Union Cycliste Internationale, the English, Irish and Scotch Cycling Associations are each represented by 4 voting delegates, or 12 altogether, each of the said Associations paying its fees separately to the Federation. The Swedish Cycling Committee had forgotten however, that the three countries in question had only the right of being represented as one whole nation, that representative being England.

The three commissaires de course let the matter remain as it was, although the French representative remarked that he, formally, was obliged to forward the protest to the Union Cycliste Internationale. But, as can be seen by the following detailed account of the race, it would have made no difference in the relative positions of the winning teams if the three nations in question had been represented as but one, with their best four men counting.

THE RACE.

On Sunday, July 7, at 2 a. m. precisely, the race was begun by Rillon, (France), who had the competing number, 1, being sent on his journey, the other competitors following at intervals of 2 minutes. There were 28 absentees out of the 151 entered, so that 123 cyclists took part in the competition. The appended general protocol and tables show to which nations they belonged.

There was an enormous crowd gathered at the starting place, and it with the greatest difficulty that the local police and the soldiers who had been sent to their assistance, could manage to keep just enough of the road clear for the passage of the competitors. During the whole of the race the weather was as fine as could be, although the heat was pretty great, especially towards noon, and greatly troubled our continental visitors. A westerly wind blew now and then during the forenoon, but proved to be of no hindrance to the riders. The choking dust, on the other hand, was what the competitors suffered from most.

All those taking part in the race declared that the control stations were managed in the very best possible way. Lewis, especially, stated that he experienced the greatest help and kindness everywhere, and that, thanks to the instructions he received, he had had no difficulty in finding the way, especially as the control committees, acting on the instructions of the Cycling Committee, had marked out the route by means of large red arrows on a white ground, at all the cross-roads and at other places where it was possible for the competitors to take a wrong turning.

Besides one or two tumbles of the ordinary kind, and which were not at all dangerous, there were not more than a couple of accidents during the whole of this great competition, both of them, however, being, fortunately enough, of such a character that no lasting injury was caused to the sufferers. Stokes (England) broke his collar-bone at Södertälje and he was at once taken in hand by the doctor acting on behalf of the control committee there. The injured man was taken to the hospital where he received every attention, and was soon able to be removed to Stockholm by his fellow-countrymen. The other accident was a more serious one, and happened to one of the Swedish representatives, Mr. Landsberg, of Örebro, only a few hundred metres from the start. He was trying to get out of the way of a motor-waggon, but he was run into, his cycle smashed and he himself dragged along some distance before the waggon stopped. He was carried back to the starting place, whence he was conveyed to St. Mary's Hospital, where he had to remain for some days.

At the finish and the Office in the Stadium, the officials on duty were kept busy from 3 a. m., receiving all the reports sent in by telephone from the various control stations, from which, as we have already mentioned, reports were made every half hour, giving the names of those competitors that had passed, and other information of any importance. The six telephones were ringing incessantly the

whole day, from 3 a. m. until 5 or 6 p. m., i. e., as long as the race continued. There were relays of 12 men each at the office, for the purpose of attending to the telephones, and they were kept at work the whole of the time. Close to each telephone lay special printed forms, on which the assistant who received the messages, wrote the name of the control station and the number of the competitor or competitors that had passed, together with the time of passing; these forms were then given without delay to the secretary who was entering the minutes for the telephone in question. Once every half hour the reports received were sent to the result-boards, to be shown there, as already described. Everything acted most satisfactorily.

* * *

It is hardly possible to give here a fully descriptive account of the race. The best and completest way for the reader to gain some idea of the competition is to study the accompanying general protocol, the protocol of the team competition, and the table showing the comparative results obtained by the various nations, all of which together will show, as clearly as can be desired, the progress of the race from the start to the finish. Still, as this cycle race was the greatest competition that has ever taken place between the best cyclists in the world, certain facts should be related, however, as being well worthy of special mention and study.

If we examine the reports showing the times at which the competitors arrived at the various control stations, we become simply astounded at the way in which the winner, Lewis (South Africa), rode from the very beginning of the race. He started as No. 2 from Liljeholmen (Stockholm) at 2.02 a. m. and at 3.00 a. m. the report was received that he had passed the control station at Södertälje, having traversed the 33 kilometres (ca. $20\frac{1}{2}$ miles) in 57 minutes (cfr. the pace in the 100 kilometres' race in London, in 1908, when *on a cycling-track*, 24 miles, 1,450 yards — 40 kilometres — were covered in the hour), and had then taken the lead, having passed the first starter, the Frenchman, Rillon, just before reaching Södertälje. This lead the South African retained to the end, as he did, too, the time-record in the race for this part of the journey. The next best time to Södertälje, after Lewis's, was that made by Richter (Russia), No. 38, and Brown (Canada), No. 65, both of whom did the distance in 58 minutes. The best Swede along this part of the course was No. 3, Persson, with a time of 59 minutes, the same as was taken by No. 48, Meredith and No. 74, Moss (both representing England), and No. 108, Raita (Finland). The longest time taken for the distance (1 hr. 16 min.) was made by some who held out to the finish, however.

The favourites for the day were Meredith, the English champion, Raita (Finland), Brown (Canada), Racine (France), Loftes (U. S. A.) and, quite naturally, our own Morén, who had 10 times won the Swedish championship over this course.

It is specially interesting to follow the progress of the best twelve riders during the race and see which of them were to the fore at the various control stations, and which of them, from the times they had hitherto made, could be picked out as the winner. We shall examine the times at the control station at Eskilstuna, a little more than one-third of the distance; at that of Köping, which may be considered as the place where the road turned towards Stockholm; at the Västerås control station, when not quite two-thirds of the 320 kilometres (ca. 192 miles) had been covered, and at the last three control stations, Enköping, Bålsta and Järfva. After the last-mentioned stations have been passed, it is easy to place the leaders, and it can be seen that there will be put little difference between them at the finish, an exception, perhaps, being made in the case of Lewis, who can be picked as a safe winner.

At the control station at *Eskilstuna*, 120 kilometres (72 miles) from the start, after somewhat more than one-third of the total distance had been covered, the first twelve men were:

1.	No.	2.	Lewis.....	South Africa ...	3	hrs.	48	min.	16	secs.
2.	»	21.	Hill	Scotland.....	3	»	59	»	52	»
3.	»	48.	Meredith ...	England.....	4	»	00	»	9	»
4.	»	85.	Schutte	U. S. A.	4	»	1	»	15	»
5.	»	20.	Kopsky	U. S. A.	4	»	1	»	54	»
6.	»	3.	Persson	Sweden	4	»	2	»	3	»
7.	»	65.	Brown	Canada	4	»	2	»	8	»
8.	»	47.	Wilson	Scotland.....	4	»	2	»	14	»
9.	»	136.	Grubb	England.....	4	»	2	»	28	»
10.	»	29.	Malm.....	Sweden	4	»	2	»	40	»
11.	»	108.	Raita	Finland	4	»	3	»	35	»
12.	»	74.	Moss	England.....	4	»	3	»	36	»

The times show how very evenly the competitors were matched up to this point.

The first twelve men to reach *Köping* (the turning point), ca. 165 kilometres (99 miles) from the start, were :

1.	No.	2.	Lewis.....	South Africa ...	5	hrs.	15	min.	1	secs.
2.	»	48.	Meredith ...	England	5	»	30	»	55	»
3.	»	29.	Malm.....	Sweden	5	»	31	»	31	»
4.	»	47.	Wilson	Scotland.....	5	»	32	»	55	»
5.	»	136.	Grubb	England	5	»	34	»	7	»
6.	»	85.	Schutte	U. S. A.	5	»	34	»	43	»
7.	»	46.	Krushel	U. S. A.	5	»	34	»	55	»
8.	»	108.	Raita	Finland	5	»	35	»	28	»
9.	»	21.	Hill	Scotland	5	»	35	»	47	»
10.	»	65.	Brown	Canada	5	»	35	»	59	»
11.	»	3.	Persson	Sweden	5	»	36	»	8	»
12.	»	20.	Kopsky	U. S. A.	5	»	37	»	48	»

Here we see that No. 74, Moss (England) has had to make way for Krushel, a representative of the U. S. A., who has placed himself seventh. There are a number of other changes, too, and it can be noticed that the interval between the second man and the twelfth has grown greater, for while at Eskilstuna, the difference between the second and the last man was less than 4 minutes, it is about 7 here.



R. LEWIS, South Africa, chaired by his countrymen, after his victory in the Cycle Road Race round Lake Mälär.



CYCLE ROAD RACE ROUND LAKE MÄLAR. R. LEWIS (South Africa) about to ride in through the grand south entrance of the Stadium, after having passed the winning post at Valhallavägen.

At *Västerås*, c:a 200 kilometres (abt. 123 miles) from the start, the order of the first twelve men, as regards time taken, was as follows:

1.	No. 2.	Lewis	South Africa	6 hrs. 24 min.
2.	» 65.	Brown	Canada	6 » 41 »
3.	» 85.	Schutte	U.S. A.	6 » 43 »
4.	» 136.	Grubb	England	6 » 43 »
5.	» 48.	Meredith	England	6 » 45 »
6.	» 21.	Hill	Scotland	6 » 46 »
7.	» 29.	Malm	Sweden	6 » 46 »
8.	» 47.	Wilson	Scotland	6 » 47 »
9.	» 46.	Krushel	U. S. A.	6 » 49 »
10.	» 108.	Raita	Finland	6 » 49 »
11.	» 72.	Loftes	U. S. A.	6 » 53 »
12.	» 106.	Ekström	Sweden	6 » 53 »

The interval between the second man and the twelfth has now increased to 12 minutes, and Persson (Sweden) and Kopsky (U. S. A.) have been obliged to retire in favour of two new men, representatives of the same countries, however; Persson making way for Ekström, and Kopsky for Loftes. Kopsky does not appear among the first twelve any more.

Enköping, 231 kilometres (c:a 140 miles) from the start, was passed in the following order, by the first twelve in point of time taken:

1.	No. 2.	Lewis	South Africa ...	7 hrs. 34 min. 40 secs.
2.	» 65.	Brown	Canada	7 » 47 » 55 »
3.	» 85.	Schutte	U. S. A.	7 » 49 » 54 »
4.	» 136.	Grubb	England	7 » 53 » 45 »
5.	» 21.	Hill	Scotland	7 » 56 » 50 »
6.	» 108.	Raita	Finland	8 » 3 » 5 »
7.	» 48.	Meredith	England	8 » 3 » 40 »
8.	» 46.	Krushel	U. S. A.	8 » 3 » 50 »
9.	» 72.	Loftes	U. S. A.	8 » 3 » 51 »
10.	» 47.	Wilson	Scotland	8 » 6 » 30 »
11.	» 29.	Malm	Sweden	8 » 6 » 45 »
12.	» 16.	Friborg	Sweden	8 » 6 » 49 »

Friborg (Sweden) has replaced his countryman, Ekström, and 19 minutes now separate the second man and the twelfth. The competition is now beginning to take a more decided character.

At *Bälsta*, abt. 265 kilometres (c:a 162 miles) from the start, the six men who actually passed the post as the first half dozen are already in the front, although their respective positions are not fixed as yet. Of the Swedish competitors, Friborg, Persson and Malm are among the first dozen, and are waiting to come somewhat more to the fore. Hill and Wilson have fallen to the rear, and appear no more among the first twelve. Ekström once more comes on, and the order (in point of time taken) on passing Bälsta is:

1.	No. 2.	Lewis	South Africa	8 hrs. 51 min.
2.	» 85.	Schutte	U. S. A.	9 » 6 »
3.	» 136.	Grubb	England	9 » 8 »
4.	» 65.	Brown	Canada	9 » 9 »
5.	» 108.	Raita	Finland	9 » 5 »
6.	» 48.	Meredith	England	9 » 18 »
7.	» 72.	Loftes	U. S. A.	9 » 21 »
8.	» 16.	Friborg	Sweden	9 » 22 »

9.	No. 46.	Krushel	U S. A.	9	hrs.	22	min.
10.	» 3.	Persson	Sweden	9	»	23	»
11.	» 29.	Malm	Sweden	9	»	24	»
12.	» 106.	Ekström	Sweden	9	»	25	»

The time separating the second man and the twelfth has not increased, but remains at 19 minutes, and it is clear that the competitors are doing all they know, for, from this station to the finish, there remain little more than 50 kilometres (30 miles).

Then the riders reach the last control station, that at *Järfva*, 5—6 kilometres (a little more than 3 miles) from the finish and 315 kilometres (195 miles) from the start. Here the competitors are already in the order (in point of time) in which they will pass the post, with the exception of Brown, Raita, Lönn (the latter of whom is now among the leaders) and Loftes. Lönn has found a place in consequence of Krushel's (U. S. A.) falling back, the new man drawing up and occupying tenth place. It will be seen that the time interval between the second man and the twelfth has increased to 23 minutes, while the difference between the first and second man has fallen to 9 minutes instead of the 13—15 minutes it was a long time before. This final difference between the two remained almost unaltered to the close.

Time-order at Järfva:

1.	No. 2.	Lewis	South Africa	...	10	hrs.	24	min.	—	secs.
2.	» 136.	Grubb	England	10	»	33	»	30	»
3.	» 85.	Schutte	U. S. A.	10	»	36	»	—	»
4.	» 48.	Meredith	...	England	...	10	»	43	»	—	»
5.	» 108.	Raita	Finland	10	»	43	»	—	»
6.	» 65.	Brown	Canada	10	»	44	»	—	»
7.	» 16.	Friborg	...	Sweden	10	»	47	»	30	»
8.	» 29.	Malm	Sweden	10	»	51	»	—	»
9.	» 3.	Persson	...	Sweden	10	»	53	»	—	»
10.	» 72.	Loftes	U. S. A.)	10	»	54	»	—	»
11.	» 42.	Lönn	Sweden	10	»	55	»	—	»
12.	» 106.	Ekström	...	Sweden	10	»	56	»	30	»

* * *

The general protocol, studied in connection with the reports given by the various control-stations, makes a most interesting study, and, consequently, before placing the protocol in question before the reader, some additional comparisons will be made that may be found worthy of his attention. One of them gives the time taken for the second half of the journey, i. e., from Köping to the Stadium; the second is the time required from Enköping to the Stadium. The two distances are, respectively, 155 and 89 kilometres (ca. 95 and 55 miles). It can be seen by both the times given, that Lewis is coming back more and more to the rest of the field. The first distance is covered by 5 men in better time than the leader's, and, as regards that part of the course between Enköping and the Stadium, no less than 9 of the best twelve had better time than the first man.

The times required for the distances in question were:

Köping—the Stadium.

1.	No. 136.	Grubb	5	hrs.	17	min.	17 ¹ / ₅	secs.
2.	» 85.	Schutte	5	»	17	»	55 ⁴ / ₅	»
3.	» 16.	Friborg	5	»	18	»	29	»
4.	» 65.	Brown	5	»	25	»	1	»
5.	» 108.	Raita	5	»	26	»	52 ³ / ₁₀	»
6.	» 2.	Lewis	5	»	27	»	38	»

Enköping—the Stadium.

1.	No. 48.	Meredith	2	hrs.	56	min.	22 ³ / ₅	sec.
2.	» 16.	Friborg	...	2	»	57	»	28	»
3.	» 42.	Lönn	2	»	57	»	52 ¹ / ₂	»
4.	» 136.	Grubb	2	»	57	»	59 ¹ / ₅	»
5.	» 108.	Raita	2	»	59	»	15 ³ / ₁₀	»
6.	» 3.	Persson	3	»	00	»	35 ³ / ₅	»
7.	» 29.	Malm	3	»	1	»	29 ¹ / ₂	»
8.	» 85.	Schutte	3	»	2	»	44 ⁴ / ₅	»
9.	» 106.	Ekström	3	»	7	»	45 ⁷ / ₁₀	»
10.	» 2.	Lewis	3	»	7	»	59	»

After having thus given these various short tables which, in their silent yet eloquent language, give an account of the most prominent features of the race, we shall here present the reader with the general protocol, or full table of results, and a classified list as well, based on the general protocol.

Table showing the best 25 men in the Race.

1.	R. Lewis	South Africa	10	hrs.	42	min.	39	secs.
2.	F. G. Grubb	England (Gt. Brit.)	10	»	51	»	24 ² / ₁₀	»
3.	C. O. Schutte	U. S. A.	10	»	52	»	38 ⁸ / ₁₀	»
4.	L. Meredith	England (Gt. Brit.)	11	»	00	»	2 ¹ / ₁₀	»
5.	F. R. Brown	Canada	11	»	1	»	00	»
6.	A. Raita	Finland	11	»	2	»	20 ³ / ₁₀	»
7.	E. Friborg	Sweden	11	»	4	»	17	»
8.	R. Malm	»	11	»	8	»	14 ⁵ / ₁₀	»
9.	A. W. Persson	»	11	»	10	»	59 ⁶ / ₁₀	»
10.	A. Lönn	»	11	»	12	»	2 ⁵ / ₁₀	»
11.	A. H. Loffes	U. S. A.	11	»	13	»	51 ² / ₁₀	»
12.	A. Ekström	Sweden	11	»	14	»	50 ⁷ / ₁₀	»
13.	A. Krushel	U. S. A.	11	»	17	»	30 ² / ₁₀	»
14.	B. M. Andreasen	Norway	11	»	20	»	14 ⁶ / ₁₀	»
15.	H. Morén	Sweden	11	»	21	»	31 ⁹ / ₁₀	»
16.	J. Wilson	Scotland (Gt. Brit.)	11	»	21	»	43	»
17.	W. C. Martin	U. S. A.	11	»	23	»	55 ² / ₁₀	»
18.	Ch. Moss	England (Gt. Brit.)	11	»	23	»	55 ⁸ / ₁₀	»
19.	W. Karlsson	Sweden	11	»	24	»	18	»
20.	J. G. Kopsky	U. S. A.	11	»	27	»	6	»
21.	V. O. Tilkanen	Finland	11	»	28	»	38 ⁵ / ₁₀	»
22.	V. R. Hammond	England	11	»	29	»	16 ⁸ / ₁₀	»
23.	R. Rammer	Austria	11	»	30	»	40 ⁵ / ₁₀	»
24.	R. Thompson	Scotland	11	»	31	»	16	»
25.	O. Meyland-Smith	Denmark	11	»	32	»	24 ² / ₁₀	»

GENERAL PROTOCOL.

No.	Name	Nation	Time at Start	Södertälje	Läggesta (Mariefred)	Strängnäs	Eskilstuna	Kungsör	Köping	
1	Rillon, René	France	2.00	3.00	Smashed cycle 2 kilometres					
2	Lewis, Rudolph	South Africa	2.02	2.59	3.59	4.35	5.50	6.48	7.17	
3	Persson, A. W.	Sweden	2.04	3.03	4.05	4.43	6.16	7.06	7.40	
4	Torres, José P.	Chili	2.06	3.09	4.17	5.03	6.39	7.54	8.32	
5	Kofler, Adolf	Austria	2.08	3.12	4.21	5.05	6.25	7.31	8.05	
6	Toth, Gyula	Hungary	2.10	Did not start.						
7	Pofhal, W. L.	U. S. A.	2.12	»						
8	Herd, George R.	Scotland	2.14	»						
9	Kirk, J. W.	England	2.16	3.24	4.35	Retired.				
10	Guldbrandsen, Carl	Norway	2.18	3.27	4.45	»				
11	Warsow, Georg	Germany	2.20	3.27	4.41	5.20	6.40	7.43	8.15	
12	Koepke, Karl	Russia	2.22	3.30	Retired.					
13	Bulger, Thomas	Canada	2.24	Did not start.						
14	Ganget, René	France	2.26	3.31	4.46	5.17	6.39	7.54	8.32	
15	Médecin, Julien	Monaco	2.28	Did not start.						
16	Friborg, Erik	Sweden	2.30	3.31	4.46	5.17	6.40	7.43	8.15	
17	Friedemann, Arturo	Chili	2.32	3.34	4.41	5.18	6.47	8.05	8.38	
18	Rammer, Robert	Austria	2.34	3.37	4.41	5.20	6.38	7.43	8.15	
19	Merényi, Lajos	Hungary	2.36	Did not start.						
20	Kopsky, Joseph G.	U. S. A.	2.38	3.40	4.43	5.20	6.39	7.43	8.15	
21	Hill, Charles	Scotland	2.40	3.40	4.43	5.20	6.40	7.43	8.15	
22	Jones, S. L.	England	2.42	3.46	4.53	5.53	6.57	7.57	8.32	
23	Andreasen, B. M.	Norway	2.44	3.46	4.53	5.53	6.55	7.57	8.27	
24	Rabe, Wilhelm	Germany	2.46	3.52	5.01	5.35	7.11	8.21	8.55	
25	Pohle, Ans	Russia	2.48	Did not start.						
26	Spencer, William	Canada	2.50	»						
27	Racine, Joseph	France	2.52	4.08	5.15	5.55	7.19	8.23	8.55	
28	Bernardi, H. J.	Monaco	2.54	Did not start.						
29	Malm, Ragnar	Sweden	2.56	3.56	4.59	5.38	6.58	7.57	8.27	
30	Downey, Alberto	Chili	2.58	3.58	5.04	5.47	7.12	8.23	8.55	
31	Kramer, Rudolf	Austria	3.00	4.03	5.10	5.54	7.19	8.23	8.55	
32	Henzely, János	Hungary	3.02	4.09	5.27	6.11	7.39	8.52	9.26	
33	Kockler, Ernest	U. S. A.	3.04	Did not start.						
34	Stevensen, James	Scotland	3.06	4.10	5.19	6.03	7.31	8.44	9.21	
35	Stokes, A. J.	England	3.08	4.10	Injured : retired.					
36	Hansen, Anton L.	Norway	3.10	4.14	5.26	6.11	7.36	8.52	9.26	
37	Rathmann, Oswald	Germany	3.12	4.12	5.15	5.56	7.26	8.37	9.08	
38	Richter, Edgar	Russia	3.14	4.12	5.19	6.05	7.51	Retired.		
39	Andrews, Walter	Canada	3.16	Did not start.						
40	Capelle, Andre	France	3.18	4.19	5.24	6.06	7.30	8.38	9.10	
41	Mecredy, Ralph J. R.	Ireland	3.20	4.23	5.31	6.20	7.56	9.07	9.44	
42	Lönn, Algot	Sweden	3.22	4.25	5.25	6.06	7.31	8.34	9.04	
43	Koller, Carlos V.	Chili	3.24	4.28	5.36	6.20	7.35	9.07	9.44	
44	Wacha, A.	Austria	3.26	4.29	5.35	6.15	7.34	8.38	9.12	
45	Retzischer, Ferencz	Hungary	3.28	Did not start.						
46	Krushel, Albert	U. S. A.	3.30	4.33	5.35	6.15	7.34	8.34	9.04	
47	Wilson, John	Scotland	3.32	4.33	5.35	6.15	7.34	8.34	9.04	
48	Meredith Leon.	England	3.34	4.33	5.35	6.15	7.34	8.34	9.04	
49	Henriksen, P. G. E.	Norway	3.36	4.38	5.45	6.29	7.56	9.03	9.36	
50	Birker, Robert	Germany	3.38	4.41	5.48	6.29	7.56	9.07	9.45	
51	Koepke, A.	Russia	3.40	4.50	6.03	7.06	9.01	Retired.		
52	Watson, George	Canada	3.42	4.44	5.50	6.31	8.04	9.17	9.51	

Kolbäck	Västerås	Enköping	Bålsta	Järva	Hour of arrival at the Stadium	Time for entire distance	Placing	No.	Remarks
(1 1/4 mile) past Södertälje ; retired.									
7.50	8.26	9.36	10.45	12.26	12.44.39	10.42.39	1	2	
8.22	9.01	10.14	11.29	12.57	1.14.59 ⁸ / ₁₀	11.10.59 ⁸ / ₁₀	9	3	
9.10	9.54	11.15	12.44	2.23	2.45.39 ⁸ / ₁₀	12.39.39 ⁸ / ₁₀	74	4	
8.44	9.24	10.36	11.58	1.32	1.49.32 ⁸ / ₁₀	11.39.32 ⁸ / ₁₀	31	5	2 min. compensation.
								6	
								7	
								8	
								9	
								10	
8.52	9.34	10.52	12.16	1.47	2.05.24	11.45.24	36	11	
								12	
								13	
9.05	9.45	11.05	12.47	2.26	2.46.32 ⁶ / ₁₀	12.20.32 ⁶ / ₁₀	65	14	
								15	
8.49	9.26	10.36	11.54	1.17	1.34.17	11.04.17	7	16	
9.21	10.03	11.25	12.56	2.41	3.00.20 ⁸ / ₁₀	12.28.20 ⁸ / ₁₀	67	17	
8.52	9.34	10.52	12.14	1.47	2.04.40 ⁸ / ₁₀	11.30.40 ⁸ / ₁₀	23	18	
								19	
8.52	9.34	10.52	12.15	1.47	2.05.06	11.27.06	20	20	
8.49	9.26	10.36	12.25	2.17	2.37.56 ⁵ / ₁₀	11.57.56 ⁵ / ₁₀	49	21	
9.10	9.51	11.07	12.35	2.03	2.19.40 ⁶ / ₁₀	11.37.40 ⁶ / ₁₀	29	22	
9.04	9.42	11.02	12.21	1.47	2.04.14 ⁶ / ₁₀	11.20.14 ⁶ / ₁₀	14	23	
9.33	10.14	11.36	12.52	2.35	2.52.55 ⁸ / ₁₀	12.06.55 ⁸ / ₁₀	55	24	
								25	
								26	
9.29	10.07	11.20	12.47	2.26	2.46.32 ⁷ / ₁₀	11.50.32 ⁷ / ₁₀	40	27	4 min. compensation.
								28	
9.04	9.42	11.02	12.21	1.47	2.04.14 ⁵ / ₁₀	11.08.14 ⁵ / ₁₀	8	29	
9.36	10.18	11.33	12.51	2.31	2.51.02 ⁵ / ₁₀	11.53.02 ⁵ / ₁₀	42	30	
9.33	10.14	11.31	12.51	2.35	2.53.12 ⁸ / ₁₀	11.53.12 ⁸ / ₁₀	43	31	
10.04	10.52	12.07	1.44	3.25	3.47.16 ³ / ₁₀	12.42.16 ³ / ₁₀	75	32	3 min. compensation.
								33	
10.00	10.48	12.14	1.44	3.17	3.35.50 ⁸ / ₁₀	12.27.50 ⁸ / ₁₀	69	34	2 min. compensation.
								35	
10.04	10.47	12.05	1.38	3.13	3.31.23 ⁷ / ₁₀	12.20.23 ⁷ / ₁₀	64	36	
9.44	10.25	11.43	1.00	2.35	2.52.18 ⁴ / ₁₀	11.40.18 ⁴ / ₁₀	33	37	
								38	
								39	
9.44	10.25	11.45	1.17	2.59	3.17.48 ⁴ / ₁₀	11.59.48 ⁴ / ₁₀	50	40	
10.25	10.19	12.16	2.21	4.05	4.23.39	13.03.39	80	41	
9.41	10.19	11.36	12.54	2.17	2.34.02 ⁵ / ₁₀	11.12.02 ⁵ / ₁₀	10	42	
10.25	11.05	12.16	1.44	3.17	3.37.49 ³ / ₁₀	12.13.49 ³ / ₁₀	58	43	
9.53	10.37	11.59	1.38	3.08	3.27.12 ⁴ / ₁₀	12.01.12 ⁴ / ₁₀	52	44	
								45	
9.41	10.19	11.33	12.54	2.26	2.47.30 ⁸ / ₁₀	11.17.30 ⁸ / ₁₀	13	46	
9.41	10.19	11.38	1.07	2.35	2.53.43	11.21.43	16	47	
9.41	10.19	11.37	12.54	2.17	2.34.02 ⁹ / ₁₀	11.00.02 ⁹ / ₁₀	4	48	
10.14	10.57	12.10	1.22	3.14	3.31.23 ³ / ₁₀	11.55.23 ³ / ₁₀	47	49	
10.25	11.10	12.34	2.00	3.39	3.57.27 ⁶ / ₁₀	12.19.27 ⁶ / ₁₀	62	50	
								51	
10.30	11.15	12.36	2.38	4.15	4.34.22 ² / ₁₀	12.52.22 ² / ₁₀	78	52	

No.	Name	Nation	Time at Start	Södertälje	Läggesta (Mariefred)	Strängnäs	Eskilstuna	Kungsör	Köping
53	Michiels, Alexis	France	3.44	4.44	5.50	6.31	8.00	9.30	10.39
54	Anderson, C. W.	Ireland	3.46	Did not start.					
55	Karlsson, Werner	Sweden	3.48	4.50	5.57	6.38	8.00	9.03	9.36
56	Hansen, Charles	Denmark	3.50	4.55	6.04	6.46	8.10	9.14	9.44
57	Hellensteiner, Josef	Austria	3.52	4.55	6.04	6.46	8.10	9.14	9.43
58	Mazur, Gyula	Hungary	3.54	5.01	6.09	6.50	8.27	9.45	10.23
59	Becht, John	U. S. A.	3.56	4.58	6.06	6.49	8.13	9.17	9.52
60	Thompson, Robert	Scotland	3.58	5.01	6.06	6.49	8.13	9.17	9.51
61	Hammond, W. R.	England	4.00	5.02	6.06	6.49	8.13	9.17	9.51
62	Saeterhaug, Martin	Norway	4.02	5.09	Retired.				
63	Männel, Otto	Germany	4.04	5.05	6.09	6.50	8.13	9.33	10.03
64	Apsit, Andrei	Russia	4.06	5.06	6.11	6.55	8.27	9.42	10.16
65	Brown, F. R.	Canada	4.08	5.06	6.09	6.50	8.10	9.14	9.43
66	Peinaud, Pierre	France	4.10	5.13	6.21	7.11	8.51	10.09	10.45
67	Donaldson, Thomas	Ireland	4.12	Did not start.					
68	Petersson, Arvid	Sweden	4.14	5.17	6.21	7.03	Retired.		
69	Nielsen, Vald.	Denmark	4.16	5.20	6.27	7.08	8.29	9.34	10.04
70	Zilker, Josef	Austria	4.18	5.23	6.27	7.08	8.29	9.34	10.03
71	Gröger, Károly	Hungary	4.20	Did not start.					
72	Loftes, A. H.	U. S. A.	4.22	5.23	6.27	7.08	8.29	9.34	10.03
73	Quinn, Daniel	Scotland	4.24	Did not start.					
74	Moss, Charles	England	4.26	5.25	6.29	7.09	8.29	9.34	10.08
75	Bye, J. S.	Norway	4.28	Did not start.					
76	Smiel, Hermann	Germany	4.30	5.38	6.48	7.37	9.01	10.21	10.58
77	Bosch, Friedrich	Russia	4.32	5.39	6.58	7.53	Retired.		
78	Rames, Bohumil	Bohemia	4.34	5.40	6.48	7.32	9.04	10.21	10.58
79	Alancourt, Gaston	France	4.36	5.40	6.50	7.37	9.15	11.15	11.50
80	Doyle, B. J.	Ireland	4.38	5.42	6.54	7.44	9.30	10.51	11.27
81	Morén, Henrik	Sweden	4.40	5.42	6.58	7.27	8.49	9.52	10.23
82	Nielsen, Vald. C.	Denmark	4.42	5.45	6.51	7.32	9.09	Retired.	
83	Tilkanen, V. O.	Finland	4.44	5.45	6.46	7.27	8.50	9.58	10.31
84	Paraker, Istvan	Hungary	4.46	Did not start.					
85	Schutte, C. O.	U. S. A.	4.48	5.49	6.53	7.32	8.53	9.54	10.22
86	Stevensen, D. M.	Scott and	4.50	5.52	6.56	7.38	9.01	10.09	10.45
87	Gibbon, A. W.	England	4.52	5.55	7.03	7.46	9.14	10.24	10.58
88	Olsen, Carl Th.	Norway	4.54	5.59	7.07	7.52	9.20	10.30	11.03
89	Rieder, Joseph	Germany	4.56	6.00	7.11	7.56	9.23	10.30	11.03
90	Eulenberg, Jeannot	Russia	4.58	Did not start.					
91	Kubrycht, Bohumil	Bohemia	5.00	6.06	7.21	8.16	10.03	11.35	12.16
92	Lepère, André	France	5.02	6.14	7.40	8.34	10.21	11.52	12.31
93	Livingston, David	Ireland	5.04	Did not start.					
94	Landsberg, K.	Sweden	5.06	Retired before reaching Södertälje ;					
95	Olsen, Hans	Denmark	5.08	6.11	7.18	8.00	9.25	10.30	11.03
96	Kankkonen, J. W.	Finland	5.10	6.14	7.18	8.00	9.25	10.30	11.30
97	Schwartz, Lajos	Hungary	5.12	Did not start.					
98	Martin, W. C.	U. S. A.	5.14	6.14	7.18	8.00	9.25	10.30	11.03
99	Petrie, William	Scotland	5.16	Did not start.					
100	Davey, C. F.	England	5.18	6.22	7.32	8.15	9.41	10.48	11.24
101	Penz, Johann	Germany	5.20	Did not start.					
102	Borrisow, Fedor	Russia	5.22	6.28	7.35	8.16	9.50	11.00	11.35
103	Tintera, Vaclav	Bohemia	5.24	6.33	7.57	8.51	10.42	12.15	12.53
104	Valentin, Georges	France	5.26	6.33	7.47	8.31	10.01	11.15	11.50
105	Guy, Francis	Ireland	5.28	6.40	7.49	8.32	10.07	11.15	11.51
106	Ekström, Alex.	Sweden	5.30	6.33	7.35	8.16	9.37	10.40	11.09

Kolbäck	Västerås	Enköping	Hälsjö	Järfva	Hour of arrival at the Stadium	Time for entire distance	Placing	No.	Remarks
11.20	12.01	1.18	2.58	6.39	6.59.59 ² / ₁₀	15.15.59 ² / ₁₀	94	53	
10.14	10.53	12.07	1.29	2.54	3.12.18	11.24.18	19	54	
10.18	10.56	12.11	1.33	3.11	3.30.04	11.40.04	32	55	
10.23	11.05	12.21	1.50	3.23	3.46.00 ² / ₁₀	11.54.00 ² / ₁₀	45	56	
11.01	11.43	1.09	2.36	4.22	4.44.55 ⁸ / ₁₀	12.50.55 ⁸ / ₁₀	77	57	
10.27	11.09	12.25	1.44	3.14	3.31.04 ⁸ / ₁₀	11.35.04 ⁸ / ₁₀	28	58	
10.27	11.09	12.25	1.44	3.15	3.29.16	11.31.16	24	59	
10.27	11.09	12.25	1.44	3.14	3.29.16 ⁸ / ₁₀	11.29.16 ⁸ / ₁₀	22	60	
10.42	11.22	12.44	2.08	3.39	3.57.27 ⁴ / ₁₀	11.53.27 ⁴ / ₁₀	44	61	
10.52	11.34	12.53	2.29	4.05	4.24.20 ⁶ / ₁₀	12.18.20 ⁶ / ₁₀	60	62	
10.15	10.49	11.55	1.22	2.52	3.09.00	11.01.00	5	63	
11.20	12.01	1.18	2.52	6.39	6.59.59 ⁴ / ₁₀	14.49.59 ⁴ / ₁₀	92	64	
10.45	11.27	12.16	2.52	4.30	4.49.09 ² / ₁₀	12.33.09 ² / ₁₀	72	65	
11.42	11.29	12.53	2.17	3.54	4.12.38 ⁷ / ₁₀	11.54.38 ⁷ / ₁₀	46	66	
10.36	11.15	12.25	1.44	3.16	3.35.51 ⁸ / ₁₀	11.13.51 ⁸ / ₁₀	11	67	
10.43	11.25	12.40	2.00	3.32	3.49.55 ⁸ / ₁₀	11.23.55 ⁸ / ₁₀	18	68	
11.39	12.16	1.36	3.17	4.58	5.19.01 ⁶ / ₁₀	12.49.01 ⁶ / ₁₀	76	69	
11.29	12.16	1.31	2.52	4.33	4.54.12 ² / ₁₀	12.20.12 ² / ₁₀	63	70	
12.40	1.23	3.14	4.37	6.39	6.59.59 ³ / ₁₀	14.23.59 ³ / ₁₀	91	71	
12.07	12.49	2.30	4.04	6.00	6.20.11 ⁸ / ₁₀	13.42.11 ⁸ / ₁₀	85	72	
11.01	11.40	12.58	2.17	3.44	4.01.31 ⁹ / ₁₀	11.21.31 ⁹ / ₁₀	15	73	
11.08	11.45	1.01	2.25	3.54	4.12.38 ⁵ / ₁₀	11.28.38 ⁵ / ₁₀	21	74	
10.55	11.31	12.38	1.57	3.24	3.40.38 ⁸ / ₁₀	10.52.38 ⁸ / ₁₀	3	75	
11.23	12.06	1.25	2.56	4.25	4.42.55	11.52.55	41	76	
11.34	12.15	1.30	2.46	4.19	4.38.00 ² / ₁₀	11.46.00 ² / ₁₀	38	77	
11.39	12.20	3.23	Retired.					78	
11.39	12.16	1.30	2.52	4.38	5.00.32 ⁴ / ₁₀	12.12.32 ⁴ / ₁₀	57	79	
1.10	1.54	3.33	5.05	6.52	7.11.21	14.11.21	88	80	
1.16	2.03	3.49	5.34	7.42	8.05.18 ¹ / ₁₀	15.03.18 ¹ / ₁₀	93	81	
11.39	12.16	2.08	Retired.					82	
11.39	12.16	1.30	2.55	4.31	4.51.35 ⁵ / ₁₀	11.41.35 ⁵ / ₁₀	34	83	
11.39	12.16	1.30	2.49	4.17	4.37.55 ² / ₁₀	11.23.55 ² / ₁₀	17	84	
12.01	12.41	1.58	3.18	4.47	5.05.26 ⁸ / ₁₀	11.47.26 ⁸ / ₁₀	39	85	
12.20	1.02	2.18	4.01	Retired.				86	
1.37	2.25	3.57	5.35	7.14	7.34.34 ⁶ / ₁₀	14.10.34 ⁶ / ₁₀	87	87	
12.36	1.23	3.04	4.41	6.39	6.59.59 ⁹ / ₁₀	13.33.59 ⁹ / ₁₀	83	88	
12.28	1.09	2.29	3.59	5.39	6.00.19 ⁴ / ₁₀	12.32.19 ⁴ / ₁₀	71	89	
11.45	12.23	1.37	2.58	4.26	4.44.50 ⁷ / ₁₀	11.14.50 ⁷ / ₁₀	12	90	

No.	Name	Nation	Time at Start	Södertälje	Läggesta (Mariefred)	Strängnäs	Eskilstuna	Kungsör	Köping	Kolbäck	Västerås	Enköping	Bålsta	Järfva	Hour of arrival at the Stadium	Time for entire distance	Placing	Remarks
107	Jensen, Otto	Denmark	5.32	6.38	Retired.													107
108	Raita, A.	Finland	5.34	6.33	7.35	8.16	9.37	10.40	11.09	11.45	12.23	1.37	2.50	4.17	4.36.20 ³ / ₁₀	11.02.20 ³ / ₁₀	6	108
109	Müller, István	Hungary	5.36	6.46	7.58	8.43	10.15	11.30	12.06	12.46	1.27	2.49	4.18	5.55	6.15.28	12.39.28	73	109
110	Steinert, Jerome	U. S. A.	5.38	6.44	7.49	8.31	10.00	11.08	11.42	12.21	1.03	2.19	3.46	5.25	5.46.32 ² / ₁₀	12.08.32 ³ / ₁₀	56	110
111	Griffiths, A. J.	Scotland	5.40	6.53	8.11	9.01	10.42	11.56	12.37	1.20	2.12	3.22	5.23	7.30	7.55.34	14.15.24	90	111
112	Gayler, H. H.	England	5.42	6.44	7.59	8.32	10.09	11.15	11.49	12.26	1.05	2.18	3.35	5.02	5.21.01 ⁸ / ₁₀	11.39.01 ⁸ / ₁₀	30	112
113	Baier, P. Rudolf	Germany	5.44	6.46	7.52	8.34	10.01	11.08	11.42	12.17	12.54	2.17	3.27	4.59	5.19.01 ⁶ / ₁₀	11.35.01 ⁶ / ₁₀	27	113
114	Pratneck, Iahn	Russia	5.46	6.51	8.02	8.46	10.28	Retired.										114
115	Kundert, Fr.	Bohemia	5.48	Retired before reaching	Södertälje.													115
116	Cheret, Etenne	France	5.50	6.51	8.01	8.45	10.20	11.52	12.31	1.16	2.03	3.49	5.36	7.42	8.05.18 ¹ / ₁₀	14.15.18 ¹ / ₁₀	89	116
117	Walker, John	Ireland	5.52	6.58	8.17	9.08	10.50	12.16	12.53	1.37	2.19	3.42	5.08	6.46	7.07.50 ² / ₁₀	13.15.50 ² / ₁₀	81	117
118	Levin, Hjalmar	Sweden	5.54	6.57	Retired.													118
119	Meyland-Smith, O.	Denmark	5.56	6.57	8.04	8.49	10.15	11.23	11.58	12.36	1.13	2.30	3.46	5.11	5.28.24 ² / ₁₀	11.32.24 ² / ₁₀	25	119
120	Jaakonaho, Juho	Finland	5.58	Retired ; cycle	damaged.													120
121	Teiszenberger, Ignatz	Hungary	6.00	7.09	8.46	9.32	11.11	12.27	1.01	1.41	2.23	3.56	5.26	7.17	7.38.35 ⁸ / ₁₀	13.38.35 ⁸ / ₁₀	84	121
122	Meissner, F. A.	U. S. A.	6.02	7.09	8.21	9.06	10.36	11.47	12.10	12.54	1.35	2.57	4.35	6.11	6.31.09	12.29.09	70	122
123	Corsar, George	Scotland	6.04	7.16	8.28	9.14	10.32	11.34	12.04	12.42	1.25	2.45	5.05	7.30	7.55.22 ⁸ / ₁₀	13.51.22 ⁸ / ₁₀	86	123
124	Higgins, F. C.	England	6.06	7.10	8.17	9.01	10.25	11.29	12.02	12.38	1.15	2.32	4.00	5.32	5.51.44 ⁶ / ₁₀	11.45.44 ⁶ / ₁₀	37	124
125	Lemnitz, Franz	Germany	6.08	7.10	8.15	8.57	10.19	11.21	11.52	12.30	1.08	2.18	3.46	5.23	5.42.32 ² / ₁₀	11.34.32 ² / ₁₀	26	125
126	Liewen, Johan	Russia	6.10	7.21	Retired.													126
127	Vokoun, Jan	Bohemia	6.12	7.24	8.44	9.38	11.34	Retired.										127
128	Bes, Louis	France	6.14	7.29	Retired.													128
129	Walsh, Matthew	Ireland	6.16	7.28	8.44	9.33	11.12	12.29	1.04	1.45	2.29	3.49	5.23	7.22	7.47.17	13.31.17	82	129
130	Björk, Gunnar	Sweden	6.18	7.24	8.31	9.13	10.34	11.44	12.19	12.57	1.39	2.59	4.26	6.00	6.18.49 ⁴ / ₁₀	12.00.49 ⁴ / ₁₀	51	130
131	Olsen, G.	Denmark	6.20	7.24	8.31	9.13	10.32	11.34	12.04	12.45	1.27	3.02	4.33	6.08	6.26.18 ⁸ / ₁₀	12.06.18 ⁸ / ₁₀	53	131
132	Väre, F. A. H.	Finland	6.22	7.24	8.31	9.13	10.43	11.56	12.30	1.12	1.55	3.18	4.45	6.24	6.43.29 ³ / ₁₀	12.21.29 ³ / ₁₀	66	132
133	Huszar, Guyla	Hungary	6.24	Did not start.														133
134	Norgauer, G. F.	U. S. A.	6.26	»														134
135	Farquhar, John	Scotland	6.28	»														135
136	Grubb, F. G.	England	6.30	7.30	8.33	9.15	10.32	11.34	12.04	12.32	1.13	2.23	3.40	5.03	5.21.24 ³ / ₁₀	10.51.24 ² / ₁₀	2	136
137	Lüthje, Carl	Germany	6.32	7.38	8.47	9.32	11.02	12.12	12.46	1.31	2.12	3.36	5.41	7.14	7.32.31 ⁸ / ₁₀	13.00.31 ⁸ / ₁₀	79	137
138	Bukse, Jakob	Russia	6.34	7.44	9.15	Retired.												138
139	Bodson, Omer	Belgium	6.36	Did not start.														139
140	Marcault, Jaques	France	6.38	8.12	Retired.													140
141	Walker, Michael	Ireland	6.40	7.45	8.51	9.37	11.08	12.21	12.56	1.37	2.19	3.42	5.08	6.46	7.07.49 ⁹ / ₁₀	12.27.49 ⁹ / ₁₀	68	141
142	Lundquist, Carl	Sweden	6.42	7.45	8.51	9.37	Retired.											142
143	Reinwald, C. J.	Denmark	6.44	7.48	8.54	9.38	11.05	12.12	12.43	1.19	1.57	3.25	4.50	6.21	6.41.20	11.57.20	48	143
144	Lindberg, C. J.	Finland	6.46	Did not start.														144
145	Teppert, Karoly	Hungary	6.48	8.02	9.23	10.13	12.00	1.18	1.58	2.40	3.24	5.01	6.35	Retired.				145
146	Pike, Jesse K.	U. S. A.	6.50	7.55	9.02	9.45	11.08	12.16	12.48	1.22	2.05	3.18	4.44	6.28	6.56.21 ⁶ / ₁₀	12.06.21 ⁶ / ₁₀	54	146
147	Miller, John	Scotland	6.52	7.58	9.07	9.53	11.25	12.29	1.00	1.35	2.12	3.25	4.44	6.16	6.36.01 ⁶ / ₁₀	11.44.01 ⁶ / ₁₀	35	147
148	Merlin, E. A.	England	6.54	7.58	9.07	9.53	11.25	12.42	1.20	2.00	2.44	3.59	5.17	6.51	7.10.08 ⁸ / ₁₀	12.16.08 ⁸ / ₁₀	59	148
149	Koch, Martin	Germany	6.56	8.06	9.20	10.08	11.40	12.46	1.16	1.56	2.38	4.03	5.36	6.57	7.14.22 ⁸ / ₁₀	12.18.22 ⁸ / ₁₀	61	149
150	Pestereff, Sergei	Russia	6.58	8.12	Retired.													150
151	Patou, Jules	Belgium	7.00	8.12	»													151

Maximum time: 13 hrs. 23 min. 19 secs.

Stockholm, July 7th, 1912.

C. Gösta Drake
 President of the Swedish Cycling Association;
 Leader of the Cycling Competition.
 C. O. Ullén.
 Sec.

COMPARISONS.

After what has been said about the individual competition, the following general protocol ought to be sufficient to give an idea of the result of the team competition, without the aid of any commentary. But, in consequence of the protest by France, which has already been mentioned, it may be as well to point out in some few words, that, even if England, Ireland and Scotland had been obliged to compete with a total of 12 men only, the result would not, consequently, have been altered as far as regards the relative positions of the winning teams.

If, for example, we take the best four men amongst all the representatives of the three countries in question, it will be seen that there is only a Scotchman that has a better time than the worst of England's best four. The man in question is No. 47, Wilson, who, on the hypothesis stated above, would have taken the place of No. 61, Hammond. This alteration would have lowered the total time for what would have been Great Britain's team, to 44 hrs. 37 min. $5\frac{3}{5}$ secs., and this would have brought the team considerably nearer that of Sweden, but would not have beaten it.

General Protocol of the Team Competition.

The sum of the times made by the best four cyclists of each nation decides the relative positions of the various nations.

1. <i>Sweden</i>	16 Friborg 11. 4.17 29 Malm..... 11. 8.14 $\frac{1}{2}$ 3 Persson 11.10.59 $\frac{3}{5}$ 42 Lönn 11.12.02 $\frac{1}{2}$	44.35.33 $\frac{3}{5}$
2. <i>England</i>	136 Grubb 10.51.24 $\frac{1}{5}$ 48 Meredith 11.00.02 $\frac{3}{5}$ 74 Moss 11.23.55 $\frac{1}{5}$ 61 Hammond 11.29.16 $\frac{3}{5}$	44.44.39 $\frac{1}{5}$
3. <i>U.S.A.</i>	85 Schutte 10.52.38 $\frac{4}{5}$ 72 Loftes 11.13.51 $\frac{1}{5}$ 46 Krushel 11.17.30 $\frac{1}{5}$ 98 Martin 11.23.55 $\frac{1}{5}$	44.47.55 $\frac{1}{2}$
4. <i>Scotland</i>	47 Wilson 11.21.43 60 Thompson 11.31.16 147 Miller..... 11.44.01 $\frac{3}{5}$ 86 Stevensen 11.52.55	46.29.55 $\frac{1}{10}$
5. <i>Finland</i>	108 Raita 11. 2.20 $\frac{3}{10}$ 83 Tilkanen 11.28.38 $\frac{1}{2}$ 96 Kaukkonen ... 11.41.35 $\frac{1}{2}$ 132 Väre 12.21.29 $\frac{1}{5}$	46.34.03 $\frac{1}{2}$
6. <i>Germany</i>	125 Lemnitz 11.34.32 $\frac{1}{5}$ 113 Baier 11.35.01 $\frac{1}{2}$ 37 Rathman 11.40.18 $\frac{2}{5}$ 11 Warsow..... 11.45.24	46.35.16 $\frac{1}{10}$

7. Austria	18	Rammer	11.30.40 ⁴ / ₅	46.57.26 ² / ₅
	5	Kofler	11.39.32 ⁸ / ₅	
	31	Kramer	11.53.12 ⁴ / ₅	
	57	Hellensteiner ...	11.54.00 ¹ / ₅	
8. Denmark	119	Meyland-Smith ..	11.32.24 ¹ / ₅	47.16.07
	56	Hansen	11.40.04	
	143	Reinwald	11.57.20	
	131	Olsen	12. 6.18 ⁴ / ₅	
9. Chili	30	Downey	11.53.02 ¹ / ₂	49.14.52
	43	Koller	12 13.49 ¹ / ₅	
	17	Friedemann ...	12.28.20 ⁴ / ₅	
	4	Torres	12.39.39 ¹ / ₂	
10. France.....	27	Racine	11.50.32 ⁷ / ₁₀	49.44.53 ¹ / ₅
	40	Capelle	11.59.48 ² / ₅	
	14	Ganget	12.20.32 ⁸ / ₅	
	134	Valentin	13.33.59 ¹ / ₂	
11. Ireland	151	Walker, M. ...	12.17.49 ⁹ / ₁₀	51.39.38 ¹ / ₂
	105	Guy	12.32.19 ² / ₅	
	41	Mecredy.....	13. 3.39	
	117	Walker, J.	13.15.50 ¹ / ₅	
12. Hungary.....	109	Müller	12.39.28	51.51.15 ⁹ / ₁₀
	32	Henzely	12.42.16 ⁹ / ₁₀	
	58	Mazur.....	12.50.55 ⁴ / ₅	
	121	Teiszenberger ...	13.38.35 ⁴ / ₅	

Bohemia, Norway and Russia took part in the team competition, too, but the prescribed number (4) of representatives of each of these nations did not succeed in reaching the finish.

Stockholm, 10 July, 1912.

C. Gösta Drake.
Leader of the Competition,

Of great interest is the comparison between the number of representatives entered by the various nations and the number that actually started, together with the number of those who retired from the race, and the total that reached the finish within the maximum time which was 13 hrs. 23 min. 19 secs., i. e., the time of the first man plus 25 % of that time. In this respect, Germany makes, most undisputably, a very fine show, no less than all her 11 representatives reaching the finish under the maximum time. All the representatives of Austria, Canada, Chili and the U. S. A., too, came in in less than the maximum time. These nations had, respectively, 6, 2, 4 and 9 men that started. Of the 12 Swedes that started, 8 reached the finish, all under the maximum time. One of the others (Landsberg) retired on account of an accident.

Comparative Table of Results gained by the Nations represented.

Nation	Entries (Exclu- sive of re- serves)	Started	Retired	Completed the Course		How the men were placed
				Fin- ished	Under max. time	
Austria	6	6	—	6	6	23, 31, 43, 45, 46, 52.
Belgium	2	1	1	—	—	
Bohemia	5	5	2	3	1	63, 87, 88.
Canada	5	2	—	2	2	5, 78.
Chili	4	4	—	4	4	42, 58, 67, 74.
Denmark.....	8	8	3	5	5	25, 32, 48, 53, 72.
England	12	12	2	10	10	2, 4, 18, 22, 29, 30, 37, 38, 39, 59.
Finland	6	5	1	4	4	6, 21, 34, 66.
France	12	12	3	9	3	40, 50, 65, 83, 89, 91, 92, 93, 94.
Germany.....	12	11	—	11	11	26, 27, 36, 37, 44, 55, 57, 61, 62, 76, 79.
Hungary	12	5	1	4	3	73, 75, 77, 84.
Ireland	9	6	—	6	4	71, 80, 81, 82, 85.
Monaco	2	—	—	—	—	
Norway	7	6	3	3	3	14, 47, 64.
Russia	12	10	9	1	1	60.
Scotland	12	8	—	8	6	16, 24, 35, 41, 49, 69, 86, 90.
South Africa..	1	1	—	1	1	1.
Sweden	12	12	4	8	8	7, 8, 9, 10, 12, 15, 19, 51.
U. S. A.	12	9	—	9	9	3, 11, 13, 17, 20, 28, 54, 56, 70.
Total	151	123	29	94	81	

PRESENTATION OF THE PRIZES.

The presentation of the prizes took place at 8 p. m., on Monday, July 9, during the course of a banquet given by the Cycling Committee at Hasselbacken. The evening was a most animated and agreeable one, and many speeches were held, of course. After the dinner, the President of the Cycling Committee gave away the prizes, which, in addition to the Olympic gold, silver and bronze medals to the winners of the individual and the team competitions, also included five large commemoration cups of silver, which had been placed at the disposal of the Committee by the Control Committees of Mariefred, Eskilstuna, Köping, Västerås and Enköping, at which towns the means of procuring the cups in question had been collected, and a sixth, presented by the Sundsvall Cycling Club. These cups were to be awarded as follows:

The Eskilstuna Commemoration Cup to the winner of the race — R. Lewis, South Africa.

The Västerås Commemoration Cup to the best Swedish competitor — E. Friborg.

The Enköping Commemoration Cup to the rider that covered the distance between Enköping and the Stadium in the shortest time — L. Meredith, England.

The Mariefred Commemoration Cup to that competitor who, although not among the winners of any Olympic prize for cycling, had done a very good performance — this was awarded by the Cycling Committee to F. R. Brown, Canada.

The Sundsvall Cycling Club's Commemoration Cup to the nation that won the team competition — to Sweden and the Swedish Cycling Association.

The Köping Commemoration Cup to the nation that had the greatest number of representatives reaching the finish under maximum time — this cup was, of course, awarded to Germany and its Cycling Association: all the eleven German representatives that started, finishing under the maximum time.

REFLECTIONS.

As regards the great cycling competition of the Olympic Games of 1912 — the race round Lake Mälär — it may be said that never before had there been such a tremendous rivalry in a road race in this branch of sport, and it can safely be asserted that the struggle which took place on the dusty, rut-marked and hilly highways around the Swedish lake, was the most sternly contested of any in the history of cycling, and may therefore be called, without much fear of contradiction, the greatest event of the kind that has ever been held.

The riding of the winner, Lewis, was simply unique, and the result a magnificent one. He beat the Swedish record for the course, that made by Morén in 1909, by no less than 39 min. 48 secs., his average speed for the whole distance (ca. 320 kilometres ; 198 miles) was 29 kilometres (18 miles) per hour. Lewis rode the whole time without the assistance of the pacing that competitors with other men in front of them generally enjoy, and his work awakened the greatest admiration on the part of the spectators along the course. On the other hand, it must be pointed out that Lewis had the advantage of riding during the early and comparatively cool hours of the day, while other competitors — Grubb, for example — suffered more or less from the intense heat that prevailed later on. Grubb, who started at 6,30 a. m., was exposed to this warmth during the whole of the race, so that it must be said that his feat was a wonderfully fine one, and it would be difficult to say which of the two men, Lewis or Grubb, did the best piece of work.

The Swedish team (Friborg, Malm, Persson and Lönn) is also worthy of all praise, and the men fully deserve the gratitude of their fellow countrymen for the untiring energy with which they performed their work, and for the honour reaped thereby for their nation and themselves. That this gratitude was felt was best shown by the enthusiastic reception they received from the immense crowd that greeted them on their arrival at the finish at Valhallavägen Road, outside the Stadium, and from the 30,000 spectators that crowded the stands inside. The fine work of the Swedish competitors, as a whole, may be seen by a glance at the table of comparative results, which shows that Sweden took 7 of the first 20 places.

Strictly speaking, cycling does not really belong to the Olympic Games, and its right to a place on the programme is more than doubtful. In our opinion, *cycling ought not to be included in future Olympic Games*. It is a form of sport that thrives best by itself, and it should have its own great international celebrations. Pure athletics would then have more justice done to them, and would be of much greater utility than at present. But if cycling races are to form a part of the Olympic Games, then track races should most certainly have their place on the programme. Cycle races are immensely popular, and are always sure to attract vast crowds of spectators, and to keep everyone's excitement at fever-heat — if "crawling" were, as it could be, successfully prevented. Everybody interested in cycling must, therefore, deeply deplore that, when the Stadium was built, it was not considered necessary to construct a cycling track there too. The Stadium as a centre of Swedish athletic life, would certainly have been a gainer by it.

Other forms of cycling sport, such as cycle-polo, or other ball games in connection with cycling, and figure cycling especially, ought not to find a place on the Olympic programme; in the first place, because their athletic value is very, very little, and secondly, and mostly, because their inclusion would at last make it impossible to set a limit to the fertile crop of fantastic proposals that, year by year, is proposed to be garnered for use at coming Olympic Games.

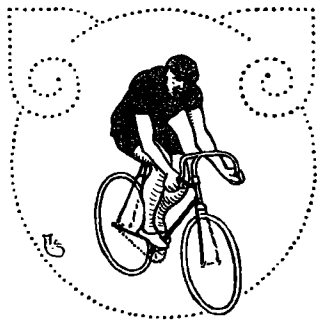

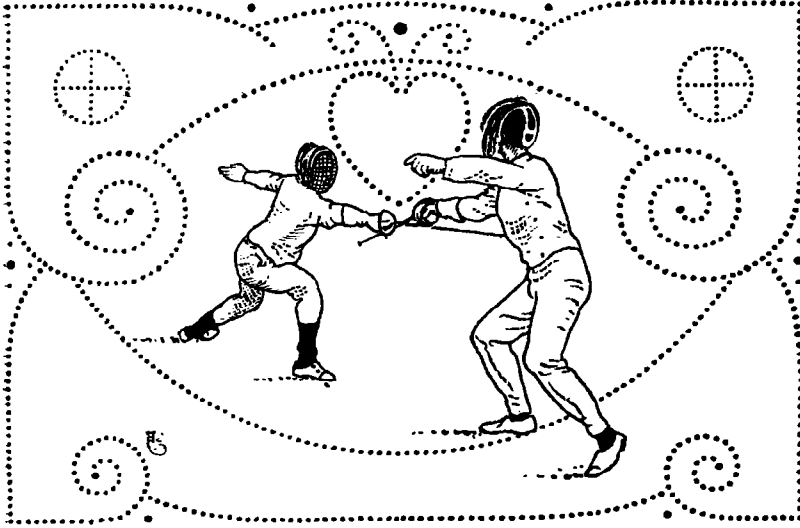

FENCING. ORGANIZATION.

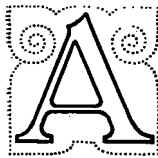

fter the Swedish Olympic Committee for the Olympic Games of Stockholm, 1912, had commenced its labours during the course of 1910, it applied to the Fencing Section of the National Association of the Swedish Gymnastic and Athletic Clubs, requesting it to draw up a plan for the fencing competitions that were to form part of the Games, to make rules and regulations for the competitions in question, and also to take all other measures necessary for the proper representation of this branch of athletics.

The Section undertook this task with the greatest pleasure, as it was quite in agreement with its mission, i. e., the promotion of Swedish Fencing.

The Fencing Committee of the Olympic Games thus first consisted of the above-mentioned section as a whole, but its final composition was as follows :

President: Captain E. FICK.
Secretary: Lieutenant B. CNATTINGIUS.
Other Members: Captain, Baron H. VON ESSEN.
 Lieutenant C. HJORTH.
 I. TÄGTSTRÖM, Esq.
 Lieutenant N. BRAMBACK.

Rules for the Fencing Competitions.

The spirit in which the rules and regulations for any branch of athletics are drawn up is, probably, in a very great measure deter-

minative of the proper carrying out of competitions in the branch of sport in question, and also of its healthy development.

It need hardly be said that the drafting of the said rules involved no very little labour; and the difficulties met with in giving definite form to the various details of an international competition so comprehensive as the one now in question, became still greater as, on the one hand, it was necessary to endeavour to bring into agreement the discordant principles existing between various schools and nations, and, at the same time, to pay due consideration to the peculiarities and demands distinguishing their conflicting views. A short account of some of the details of the task of drawing up the rules will, therefore, probably not be altogether without interest.

The first question that came to the fore was that of the amateur definition. With a knowledge of the difficulties to which this question had given rise within Sweden alone, the problem was solved in the only possible practical way by stating the rule as follows: that anyone who was an amateur according to the rules of his own country would be recognized as such; the Olympic Committees of the respective nations, however, were made responsible for the validity of the statements in this regard made by their competitors for the fencing competitions.

The satisfactory formulation of some of the rules of the competition was a far more intricate matter. One might think that, considering the long time the art of fencing has taken to develop its principles, these rules now ought to be such as are accepted everywhere, but this is by no means the case. The fully justifiable, but somewhat brutal appearance in the field, of *épée* fencing, with its attempts to undervalue and supplant the more classic art of foil-fencing, has given birth to quite a number of new points of view respecting the holding and judging of fencing competitions — points of view which have not obtained general adoption as yet, and which cannot be considered as being altogether correct.

The desire that competitions and the regulations governing them should remain as constant as possible, and should not be altered before fresh conditions make such a step absolutely necessary, is quite a natural one. While warmly acknowledging the merits of the English fencing rules and regulations for the Olympic Games of London in 1908, and the assistance they have been in drawing up those for the Swedish competitions of 1912, it must be stated that there were some rules, one, at least, of which was considered as being incorrect in principle, while others dealt with questions which had come to a head since 1908, and now required to be formulated anew to be able to obtain legitimacy. Fencing with foils had been eliminated from the English programme, and had been replaced in London with a display (in contrast to what had been the case at the Games of Athens, in 1906); this step was explained in the English Official Report of the Games of 1908 by the statement that fencing with foils is not a form of athletic sport suitable for competitions. The Swedish Committee, however, could by no means share this view, and allowed fencing with foils to



GROUP OF COMPETITORS AND OFFICIALS AT THE OLYMPIC FENCING COMPETITIONS.

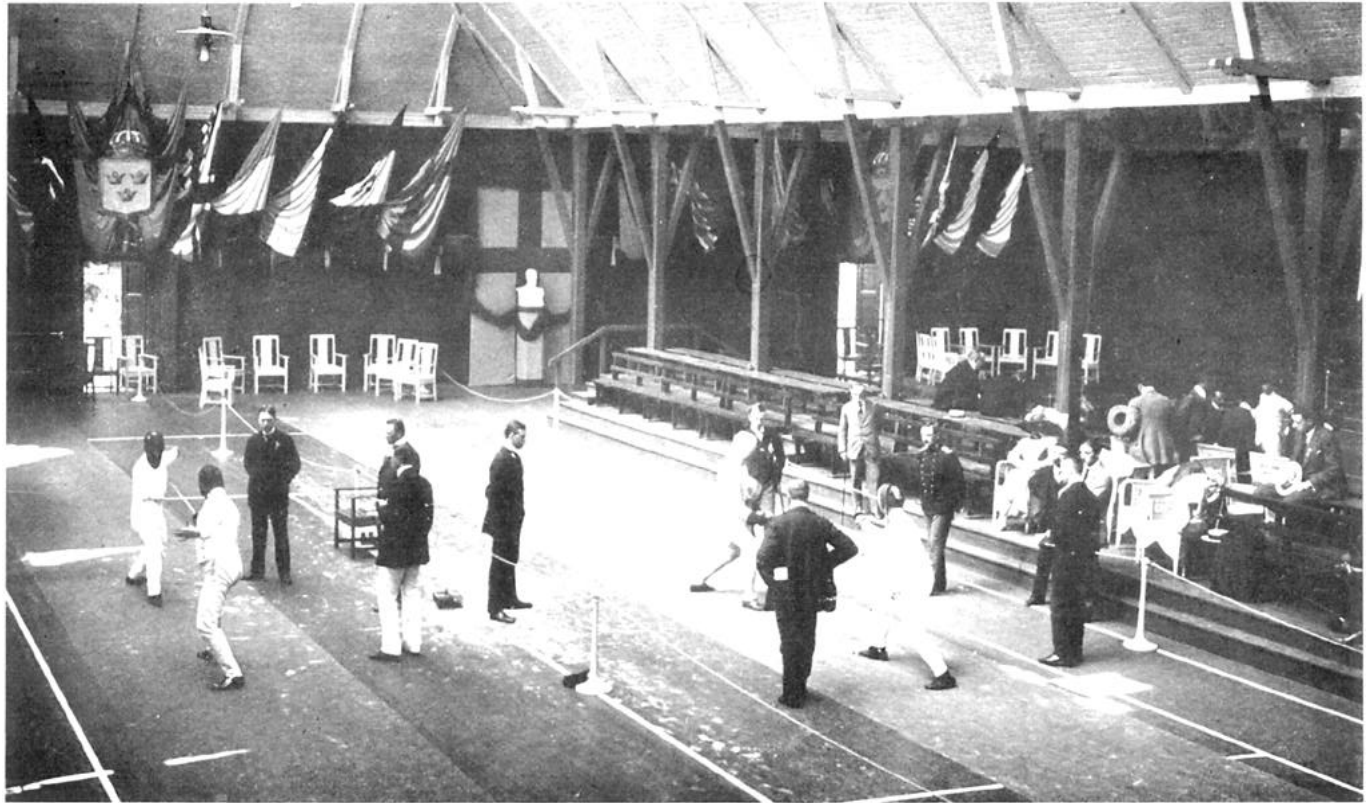

ÉPÉE TEAM COMPETITION.

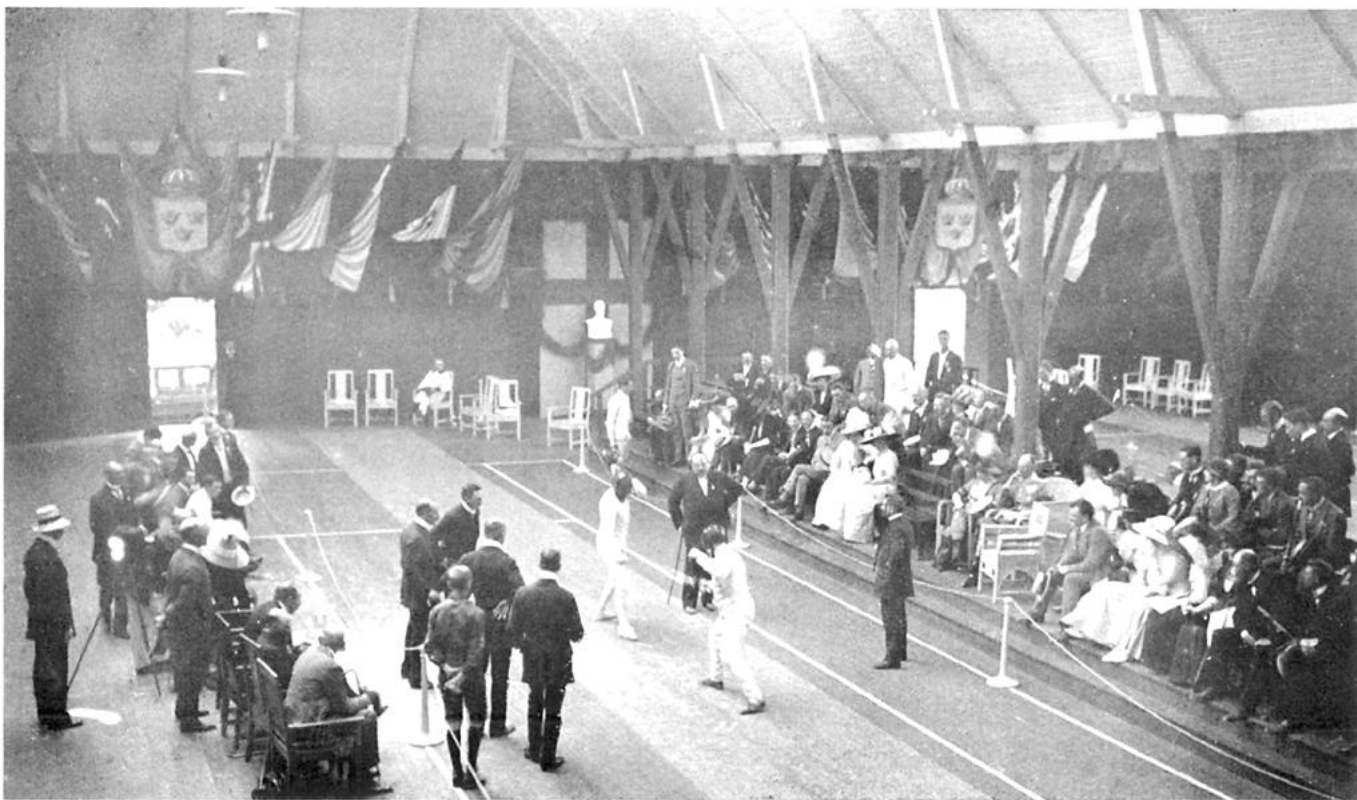

FINAL IN ÉPÉE COMPETITION. P. ANSPACH (Belgium) v. SELIGMAN (Great Britain).

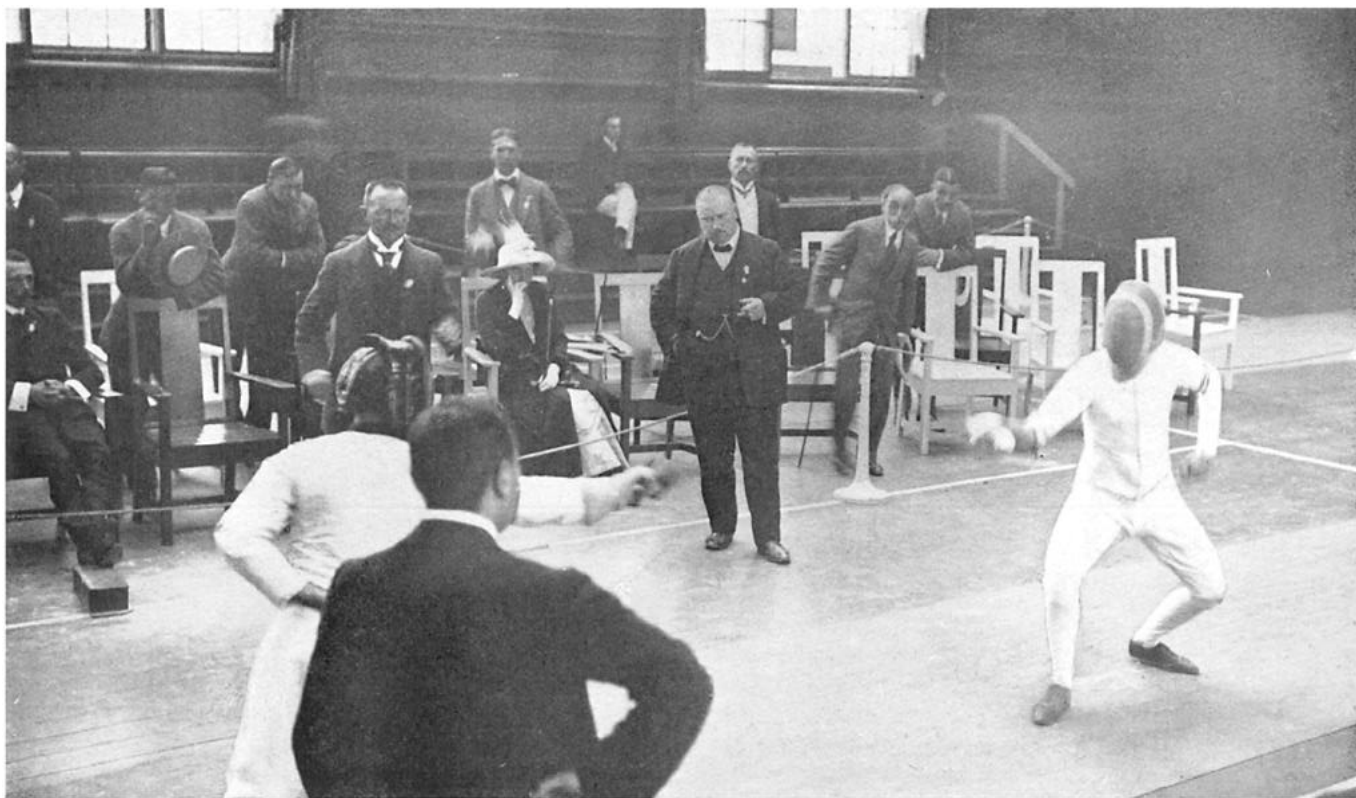

FINAL IN SABRE COMPETITION. FUCHS (Hungary) v. NADI (Italy).



GROUP OF COMPETITORS IN FINAL OF FOIL COMPETITION.

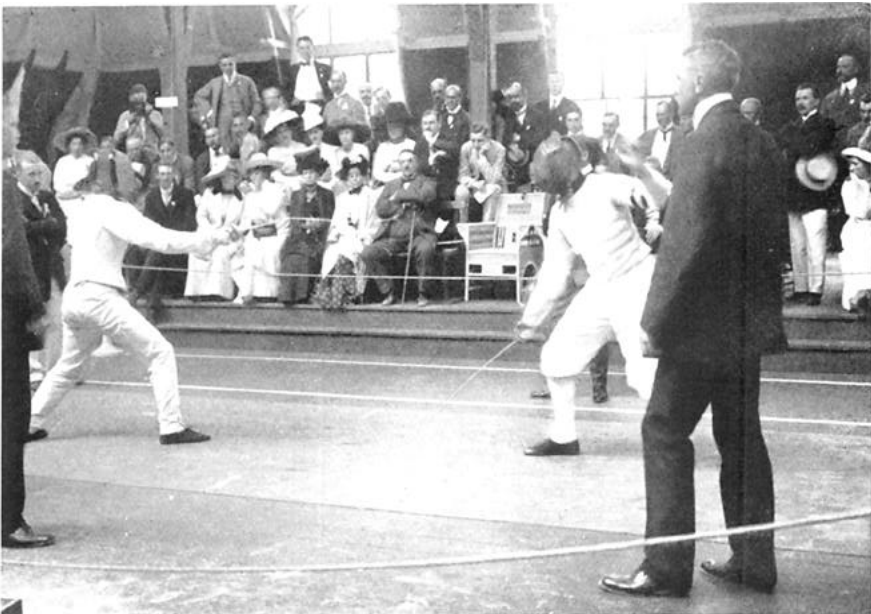

FINAL IN FOIL COMPETITION. BERTI (Hungary) v. BÉKESSY (Hungary).

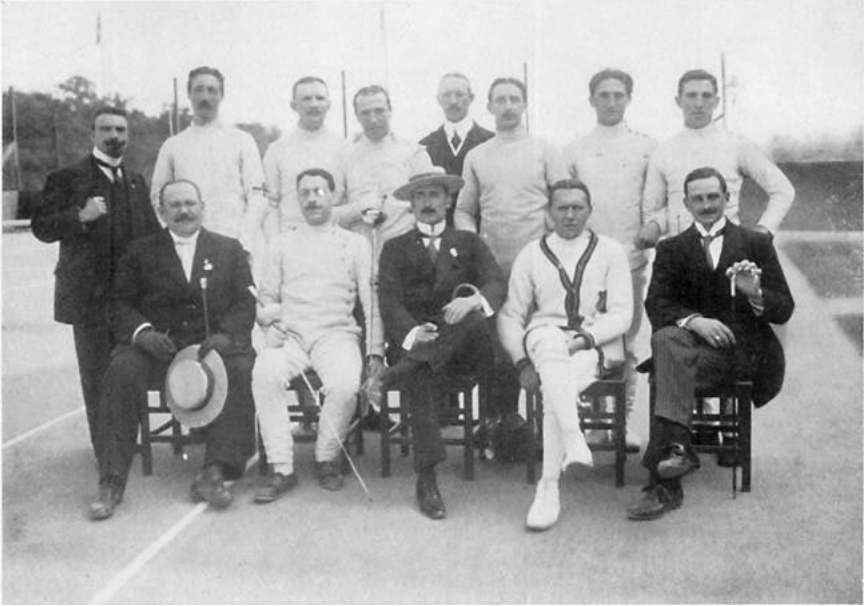

GROUP OF COMPETITORS IN ÉPÉE IN INDIVIDUAL COMPETITION.

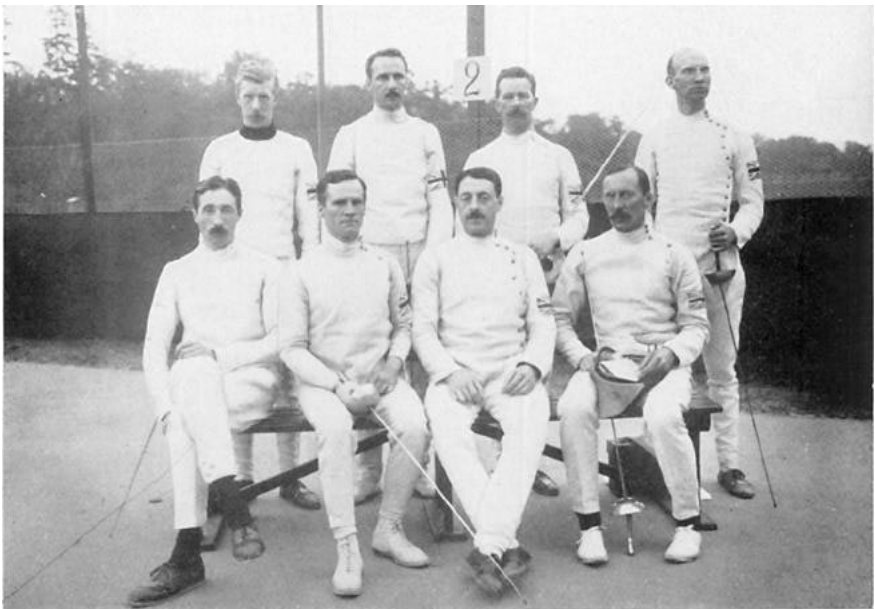

GREAT BRITAIN'S TEAM IN ÉPÉE COMPETITION

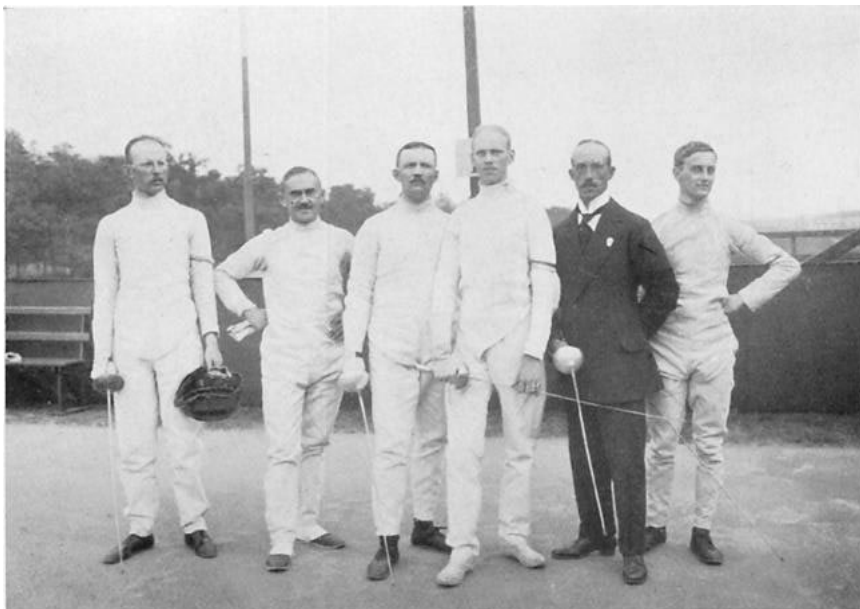

SWEDEN'S TEAM IN ÉPÉE COMPETITION



GROUP OF COMPETITORS IN FINAL OF SABRE INDIVIDUAL COMPETITION.

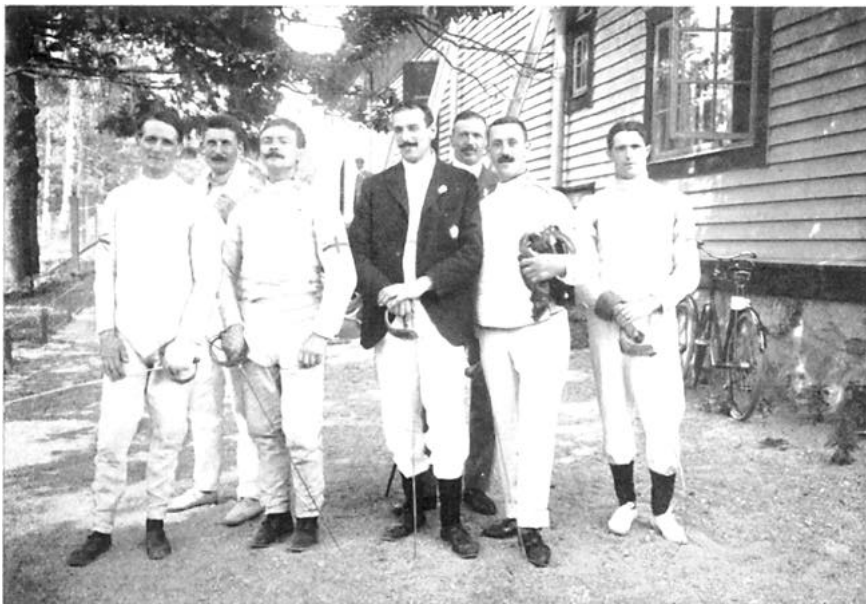

GREAT BRITAIN'S TEAM IN SABRE COMPETITION.



ITALY'S TEAM IN SABRE COMPETITION.

make its appearance once more on the competition "piste", or track, with the hope that it will be found there in future Olympic Games, too.

In other respects, the composition of the programme of the Olympic Games of Stockholm was the same as that of the London competition in 1908, the Swedish Committee being happy to be able to comply with the wish expressed in many quarters, that the team competition in any of the arms might precede the individual meeting with the same weapon.

Questions that were destined, on the other hand, to occasion both trouble and disappointment were:

a) that of the length of the weapon, and, in connection with this matter, the question of the grasp;

b) that of the extent of the vulnerable surfaces in foil-and sabre fencing.

During the elaboration of the regulations for these details (the "Règlement de Combat des Armes de France" being taken as a guide for this work it was found that the rules in force varied very much, not only as far as different countries were concerned, but also within the same nation. In order to decide fairly between all the conflicting regulations it was necessary, therefore, to gain a knowledge of the wishes in the matter entertained by various nations. This gave rise to an instructive and interesting correspondence with persons representing the art of the sword, in the countries interested in the question.

No difficulty was found in the reduction of the vulnerable surface in the sabre competition to include nothing but the trunk alone, while, in most cases, the proposal of France to extend the vulnerable surface in foil competitions so as to include the upper arm, too, was disapproved of. No other objections, however, were raised against the proposed regulations, with the exception that, in the case of the épée competitions, Italy asked for a lengthening of the blade to 94 centimetres, a step that was opposed by France, however.

This proved to be a point in which it was found impossible to reconcile the conflicting interests. It would occupy altogether too much space to give a detailed account of the debate that arose with regard to this matter. The result, however, was, that the original regulations were retained, modified as regards the questions of the extent of the vulnerable surface, in the sabre competitions, and of the grasp of the épée, while the wish of the Italians concerning the lengthening of the blade, and that of the Frenchmen, for an increase of the vulnerable surface in the foil competitions, were negatived.

The result of this was, that France declared that it could not take part in the foil competitions, and the Italians refused to enter for the épée events. Both nations, however, sent in numerous entries for all the other fencing competitions, so that it was a painful surprise for everybody when, at the very last minute, France determined to take no part at all in any of the events. The Committee received this information only two days before the beginning of the competitions, and no official explanation of the grounds of the French withdrawal was ever given.

On the 1 June 1912, the date when entries were closed, 17 nations had entered a total of about 250 competitors.

THE PRINCIPLES FOR THE JUDGING.

Another important question to which the rules and regulations endeavoured to give more definite form, was that of the method of judging to be employed by the juries of the competitions. It is, unfortunately, necessary to employ juries; it must be acknowledged that their task is a most difficult and unthankful one, in fencing especially, for, in the competitions in question, their duty is not restricted to the mere stating of a definite fact as, for example, who has passed the winning post first or who has jumped farthest, but it is necessary to decide at one and the same moment, whether a hit has been made and, if so, also to analyze the movement by which this hit has been brought about, and thereby to come to a fair decision. This is really a very difficult task, especially in the case of rapid fencers, the swiftness of whose movements is, so to say, an endeavour to shuffle the cards. Nothing, either, is more calculated to detract from the pleasure the correct fencer has in this sport, and from the sympathy felt by the spectators, than disputes between the members of the jury, and inconsistencies in their decisions. Considering that an improvement in these respects could be gained by a clearer definition, and a better division, of the tasks of the jurymen, the Committee consulted all available treatises on the matter and finally felt itself most attracted by the rules proposed by Comte du Cugnon d'Alincourt, of the Société de l'Écime à l'épée de Paris. The merits of this paper are its clear division of the tasks of the members of the jury, and the logical arrangement in the method of stating the observations they have made, whereby the *phrase d'armes* is decided in the quickest and most reliable way. Wherever this system has been used in all its strictness it has justified all expectations ; that this could not always be carried out was quite naturally the result of the difficulty there was in obtaining fully competent judges, and of the difficulty of bringing about uniformity in all these international juries, whose members speak different languages and have different customs.

The rules and regulations finally adopted proved to satisfy all reasonable demands for clearness and conciseness; the small number of protests, and the facility with which the matters in dispute were decided, also speak in favour of their practical nature.

The question of the jury is the most delicate matter regarding fencing competitions, for, on the simple, clear decisions that are given, there rests not only the maintenance of the art of fencing, but also the retention of the sympathetic interest of the spectators. The competition ought to consist of the spirited bouts of the fencers, and not of the lengthy deliberations of the jurymen. The attention of future Olympic Committees should be carefully directed to this end.

THE TECHNICAL ARRANGEMENTS.

It is of the greatest importance to find the right place, and to make the proper arrangements, for competitions on an extensive scale, if the events in question are to be carried out in a natural manner, and so that everyone can feel himself quite at home during the course

of the competitions. Our stating that it was that the unanimous opinion the Swedish Committee succeeded in these two points, is merely the expression of the gratitude of the Committee towards all the friendly powers that allowed its lengthy and laborious endeavours to be carried out in their entirety, without any disturbing influences.

The demands that should be made for such arrangements as those in question are: the scene of the combats shall form a suitable "frame" for the competitors and the spectators; there shall be the proper amount of space and a pleasant field for the eye; the competitions shall be arranged in such a manner that those taking part in them know the exact times when they are to be present, so that they can enjoy their leisure in peace and quiet, either for the purpose of rest or to satisfy other interests; in a word, every detail must, as far as possible, be so arranged that when once the competitions have begun, everything will go as if by clock-work.

For the first scheme that was drawn up the following factors were taken as the basis. The number of the competitors was estimated to amount to 200—250, of which total there would be about 100 in each of the individual competitions; the number of the *pistes*, or tracks, was fixed at four, this being considered the greatest number the Committee could venture to arrange, as it could not calculate on more than 40 jurymen for the competitions, divided into two reliefs of 20 jurymen each.

The rules fixing the highest number of competitors in one round at 8, the eliminating rounds in 1 series would thus amount to about 16. As the number of rounds in each following series would be diminished to one half, the total number of rounds, inclusive of the final, would be 29. It was thought that it would not be possible to finish more than 12 rounds each day; consequently, the individual competitions would require three days for their completion, this space of time also including that necessary for the Olympic solemnities in which all the competitors were to take part, and the intervals allowed for Divine Service on Sundays. 2 days were considered sufficient for the team competitions, the same space of time being thought enough for the *épée* event in the Modern Pentathlon, too.

On this basis there was drawn up the time-table, given on pages 458—459, which shows the entire plan of the fencing competitions, and which was of great actual value for their performance according to schedule.

The Tennis Pavilion at the Ötermalm Athletic Grounds was chosen as the scene of the competitions, and it proved to be an ideal one. The two tennis courts, which lie there side by side, gave the four *pistes*, each of which measured 2 metres by 33 metres, together with a sufficient intermediate space where the jurymen could move about without hindrance. The pavilion also allowed of the erection of stands, each of two rows, along the middle and the sides of the hall, and seating altogether 400 spectators. The *pistes* were bounded by low posts supporting ropes separating them from each other and from the spectators. At the farther end of each *piste* there were 8 easy-chairs reserved for the competitors, while the marking-boards were placed

nearest to the wall close to the entrance. Each piste and the fittings belonging to it was of a special colour (blue, yellow, red and white) so that the competitors might more easily find their places.

The interior of the hall was decorated with a bust of H. M. the King, surrounded by the standard of Sweden and those of the other competing nations interwoven with green garlands, the whole offering a very inviting appearance with these simple, yet richly coloured decorations.

Nowadays the wish is generally expressed to have the épée- and sabre competitions as much as possible in the open air, but when arranging such competitions, it is necessary to be certain of having a roof above one's head to be able to feel sure that the events in question can be completed.

The épée competition of the Modern Pentathlon, however, realized the first of these wishes, as it was fought out on the new out-of-doors tennis courts, which, without any very special preparations, satisfied all the demands made on first class fencing-grounds. The only thing wanted to make this competition a success was fine weather, and this we enjoyed, with brilliant sunshine and southern warmth.

As far as regards the arrangements necessary for the personal convenience of the competitors, such as dressing-rooms, lavatories etc. those already existing in the tennis pavilion proved quite sufficient and satisfactory.

After the list of entries of the competitors who were going to take part in the various competitions was definitely fixed, each man's place in the eliminating rounds of the first series was determined by the drawing of lots immediately before the arrival of the competitors. This was done in accordance with the regulations.

The drawing for this first round is given at the beginning of the report of every special competition. It can be seen there, too, how the winners in this round (*italicized*) take part in the rounds of the next series (shown by a Roman figure after the name). The groups in which the competitors were, placed were decided by the drawing of lots at the Secretariat, care being taken to have as few competitors as possible belonging to the same nation opposed to each other, and also that those competitors who had already met should, in the next round, compete with new men.

Immediately after the finish of a series, those competitors that were to take part in a second were given a card, issued by the Secretariat, by the aid of which and of the time-table already mentioned, the competitor at once knew the hour when he should next present himself. The colour of the card agreed with that of the piste where the event was to take place.

These arrangements, which were quite new of their kind, proved to be very practical ones, much questioning being thus made quite unnecessary, for each competitor had a printed notice of the hours when his presence was required, and he could spend his leisure time without any fear of coming too late to a competition.

THE FENCING.

At 5 p. m. on the 5 July, the competitors were summoned to a general meeting held at the Tennis Pavilion in order to receive instructions concerning the dispositions made, and also for the purpose of being introduced to each other. Captain Fick, President of the Fencing Committee, gave the competitors from abroad a hearty welcome to Sweden, after which refreshments were taken. At the same time, the international jury of honour was elected, which, when its numbers were complete, comprised the following members:

President :

Colonel C. G. Platen.

Members :

for Austria	Major Tenner.
» Belgium	M. A. Feyerick.
» Germany.....	Captain Jüst.
» Great Britain	Lord Desborough.
» Holland	Captain A. Wallenberg.
» Italy	Marquis de Brichanteau.
» Russia	
» Sweden.....	Major Drakenberg.

As may be seen by the time-table, the Fencing Competitions of the Olympic Games of 1912 began on July 6 at 8 a. m., the first event being the individual competition with the foil.

I. INDIVIDUAL COMPETITION WITH FOILS.

6—8 July.

Protocol.

Elimination series. 1st Round.

6-7 July.

	<table style="width: 100%; border-collapse: collapse;"> <tr><td style="width: 5%;"></td><td style="width: 40%;">1. de Kniajevitch, D. Russ.</td><td style="width: 5%;"></td><td style="width: 50%;"></td></tr> <tr><td></td><td>2. Tom, L. Belg. I</td><td></td><td></td></tr> <tr><td></td><td>3. Carlberg, E. Swed.</td><td></td><td></td></tr> <tr><td style="vertical-align: middle;">I</td><td>4. Tvorzsky, V. ... Boh. II</td><td></td><td></td></tr> <tr><td></td><td>5. Jack, F. Germ.</td><td></td><td></td></tr> <tr><td></td><td>6. Földes, D. Hung. III</td><td></td><td></td></tr> <tr><td></td><td>7. Suttner, A. Aust.</td><td></td><td></td></tr> </table>		1. de Kniajevitch, D. Russ.				2. Tom, L. Belg. I				3. Carlberg, E. Swed.			I	4. Tvorzsky, V. ... Boh. II				5. Jack, F. Germ.				6. Földes, D. Hung. III				7. Suttner, A. Aust.				<table style="width: 100%; border-collapse: collapse;"> <tr><td style="width: 5%;"></td><td style="width: 40%;">1. Klika, M. Boh.</td><td style="width: 5%;"></td><td style="width: 50%;"></td></tr> <tr><td></td><td>2. Schenker, Z. ... Hung. I</td><td></td><td></td></tr> <tr><td></td><td>3. Gate, W. P. S.-Afr.</td><td></td><td></td></tr> <tr><td style="vertical-align: middle;">IV</td><td>4. Thomson, J. Germ.</td><td></td><td></td></tr> <tr><td></td><td>5. Breckinridge, S. D. U. S. A. III</td><td></td><td></td></tr> <tr><td></td><td>6. Georgacopoulos, P. Greece</td><td></td><td></td></tr> <tr><td></td><td>7. Nadi, N. I t a l. II</td><td></td><td></td></tr> <tr><td></td><td>8. Dawson, P. H. ... G. Brit.</td><td></td><td></td></tr> </table>		1. Klika, M. Boh.				2. Schenker, Z. ... Hung. I				3. Gate, W. P. S.-Afr.			IV	4. Thomson, J. Germ.				5. Breckinridge, S. D. U. S. A. III				6. Georgacopoulos, P. Greece				7. Nadi, N. I t a l. II				8. Dawson, P. H. ... G. Brit.		
	1. de Kniajevitch, D. Russ.																																																														
	2. Tom, L. Belg. I																																																														
	3. Carlberg, E. Swed.																																																														
I	4. Tvorzsky, V. ... Boh. II																																																														
	5. Jack, F. Germ.																																																														
	6. Földes, D. Hung. III																																																														
	7. Suttner, A. Aust.																																																														
	1. Klika, M. Boh.																																																														
	2. Schenker, Z. ... Hung. I																																																														
	3. Gate, W. P. S.-Afr.																																																														
IV	4. Thomson, J. Germ.																																																														
	5. Breckinridge, S. D. U. S. A. III																																																														
	6. Georgacopoulos, P. Greece																																																														
	7. Nadi, N. I t a l. II																																																														
	8. Dawson, P. H. ... G. Brit.																																																														
II	<table style="width: 100%; border-collapse: collapse;"> <tr><td style="width: 5%;"></td><td style="width: 40%;">1. Adam, J. Aust.</td><td style="width: 5%;"></td><td style="width: 50%;"></td></tr> <tr><td></td><td>2. Leparsky, F. ... Russ.</td><td></td><td></td></tr> <tr><td></td><td>3. Benfratello, J. ... Ital.</td><td></td><td></td></tr> <tr><td></td><td>4. Krokstedt, C. G. Swed.</td><td></td><td></td></tr> <tr><td></td><td>5. Larimer, M. W., ... U. S. A. I</td><td></td><td></td></tr> <tr><td></td><td>6. Amphlett, E. M. G. Brit. II</td><td></td><td></td></tr> <tr><td></td><td>7. Berré, M. Belg. III</td><td></td><td></td></tr> </table>		1. Adam, J. Aust.				2. Leparsky, F. ... Russ.				3. Benfratello, J. ... Ital.				4. Krokstedt, C. G. Swed.				5. Larimer, M. W., ... U. S. A. I				6. Amphlett, E. M. G. Brit. II				7. Berré, M. Belg. III			V	<table style="width: 100%; border-collapse: collapse;"> <tr><td style="width: 5%;"></td><td style="width: 40%;">1. Berthelsen, J. O. H. Denm. II</td><td style="width: 5%;"></td><td style="width: 50%;"></td></tr> <tr><td></td><td>2. Fagan, A. W. ... G. Brit. VI</td><td></td><td></td></tr> <tr><td></td><td>3. Lichtenfels, J. ... Germ. I</td><td></td><td></td></tr> <tr><td></td><td>4. Keiser, W. Russ.</td><td></td><td></td></tr> <tr><td></td><td>5. Armgarth, G. ... Swed.</td><td></td><td></td></tr> <tr><td></td><td>6. Salmon, G. C. J. M. Belg.</td><td></td><td></td></tr> <tr><td></td><td>7. Hammond, D. ... U. S. A.</td><td></td><td></td></tr> </table>		1. Berthelsen, J. O. H. Denm. II				2. Fagan, A. W. ... G. Brit. VI				3. Lichtenfels, J. ... Germ. I				4. Keiser, W. Russ.				5. Armgarth, G. ... Swed.				6. Salmon, G. C. J. M. Belg.				7. Hammond, D. ... U. S. A.						
	1. Adam, J. Aust.																																																														
	2. Leparsky, F. ... Russ.																																																														
	3. Benfratello, J. ... Ital.																																																														
	4. Krokstedt, C. G. Swed.																																																														
	5. Larimer, M. W., ... U. S. A. I																																																														
	6. Amphlett, E. M. G. Brit. II																																																														
	7. Berré, M. Belg. III																																																														
	1. Berthelsen, J. O. H. Denm. II																																																														
	2. Fagan, A. W. ... G. Brit. VI																																																														
	3. Lichtenfels, J. ... Germ. I																																																														
	4. Keiser, W. Russ.																																																														
	5. Armgarth, G. ... Swed.																																																														
	6. Salmon, G. C. J. M. Belg.																																																														
	7. Hammond, D. ... U. S. A.																																																														
III	<table style="width: 100%; border-collapse: collapse;"> <tr><td style="width: 5%;"></td><td style="width: 40%;">1. Alexander, G. R. G. Brit. I</td><td style="width: 5%;"></td><td style="width: 50%;"></td></tr> <tr><td></td><td>2. Dunay, B. Hung.</td><td></td><td></td></tr> <tr><td></td><td>3. Pontenani, A. ... Ital.</td><td></td><td></td></tr> <tr><td></td><td>4. Post, A. van Zo. U. S. A. II</td><td></td><td></td></tr> <tr><td></td><td>5. Pfeiffer, V. Boh. III</td><td></td><td></td></tr> <tr><td></td><td>6. Stöhr, G. Germ.</td><td></td><td></td></tr> <tr><td></td><td>7. Guoworsky, P. ... Russ.</td><td></td><td></td></tr> </table>		1. Alexander, G. R. G. Brit. I				2. Dunay, B. Hung.				3. Pontenani, A. ... Ital.				4. Post, A. van Zo. U. S. A. II				5. Pfeiffer, V. Boh. III				6. Stöhr, G. Germ.				7. Guoworsky, P. ... Russ.			VI	<table style="width: 100%; border-collapse: collapse;"> <tr><td style="width: 5%;"></td><td style="width: 40%;">1. Cooke, S. G. Brit.</td><td style="width: 5%;"></td><td style="width: 50%;"></td></tr> <tr><td></td><td>2. Pietrasanta, F. ... I t a l. II</td><td></td><td></td></tr> <tr><td></td><td>3. Aas, L. T. Norw.</td><td></td><td></td></tr> <tr><td></td><td>4. Notaris, S. Greece V.</td><td></td><td></td></tr> <tr><td></td><td>5. Mc Laughlin, J. A. U. S. A.</td><td></td><td></td></tr> <tr><td></td><td>6. Gordetsky, N. ... Russ.</td><td></td><td></td></tr> <tr><td></td><td>7. de Montigny, F. Belg. IV</td><td></td><td></td></tr> </table>		1. Cooke, S. G. Brit.				2. Pietrasanta, F. ... I t a l. II				3. Aas, L. T. Norw.				4. Notaris, S. Greece V.				5. Mc Laughlin, J. A. U. S. A.				6. Gordetsky, N. ... Russ.				7. de Montigny, F. Belg. IV						
	1. Alexander, G. R. G. Brit. I																																																														
	2. Dunay, B. Hung.																																																														
	3. Pontenani, A. ... Ital.																																																														
	4. Post, A. van Zo. U. S. A. II																																																														
	5. Pfeiffer, V. Boh. III																																																														
	6. Stöhr, G. Germ.																																																														
	7. Guoworsky, P. ... Russ.																																																														
	1. Cooke, S. G. Brit.																																																														
	2. Pietrasanta, F. ... I t a l. II																																																														
	3. Aas, L. T. Norw.																																																														
	4. Notaris, S. Greece V.																																																														
	5. Mc Laughlin, J. A. U. S. A.																																																														
	6. Gordetsky, N. ... Russ.																																																														
	7. de Montigny, F. Belg. IV																																																														

VII	<ol style="list-style-type: none"> 1. Personne, C. B. Swed. 2. Hall, S. U. S. A. <i>IV</i> 3. Speciale, P. Ital. <i>III</i> 4. Olsen, H. Denm. 5. Martineau, S. ... G. Brit. 6. Willems, V. Belg. <i>V</i> 7. Mordovine, A. ... Russ. 	XII	<ol style="list-style-type: none"> 1. Goppold de Lobsdorf, V., sr. ... Boh. <i>VII</i> 2. Peyron, H. G. R. Swed. 3. Alajmo, A. Ital. <i>IV</i> 4. de Samawsky, W. Russ. 5. Toth, P. Hung. <i>V</i> 6. Sauer, A. E., U. S. A. 7. Naumann, A. ... Germ.
VIII	<ol style="list-style-type: none"> 1. Rayner, H. M. ... U.S.A. <i>V</i> 2. de Samoiloff, W. Russ. 3. Davids, A. Germ. <i>IV</i> 4. Grönvall, N. R. J. Swed. 5. Rechner, V. Boh. 6. di Nola, N. Ital. 7. Zulawsky, B. ... Hung. <i>II</i> 	XIII	<ol style="list-style-type: none"> 1. Anspach, P. Belg. <i>VIII</i> 2. Montgomerie, R. C. L. G. Brit. <i>VII</i> 3. Hjorth, C. Swed. <i>VI</i> 4. von Tangen, G. Norw. 5. Vigeveno, F. Hol. 6. Martucheff, L. ... Russ. 7. Berntsen, O. Denm. 8. Trampler, R. ... Aust.
IX	<ol style="list-style-type: none"> 1. Diana, D. Ital. 2. Seligman, E. ... G. Brit. <i>III</i> 3. Javurek, J. Boh. 4. Löffler, W. Germ. <i>V</i> 5. Békessy, B. Hung. <i>IV</i> 6. Dereani, F. Aust. 7. Gignoux, J. E. ... U. S. A. 	XIV	<ol style="list-style-type: none"> 1. Eriksen, B. G. ... Norm. <i>VIII</i> 2. Hassanein, A. M. Egy. 3. de Jakovleff, A. Russ. 4. Lindblom, G. T. Swed. 5. Verderber, R. ... Aust. <i>VII</i> 6. Anspach, H. Belg. <i>VI</i> 7. de Jong, A. E. W. Holl.
X	<ol style="list-style-type: none"> 1. Levison, E. Denm. <i>VIII</i> 2. Pajzs, P. Hung. <i>VI</i> 3. Puhm, J. Aust. 4. Castorina, C. ... Ital. 5. Vávra, Z. Boh. 6. Plaskuda, H. Germ. <i>III</i> 7. Bowman, W. L. U. S. A. 	x v	<ol style="list-style-type: none"> 1. Ziegler, H. Germ. 2. Kriz, F. Boh. 3. Ochs, J. Belg. <i>VIII</i> 4. Setterberg, C. L. Swed. 5. Berti, L. Hung. <i>VIII</i> 6. Cvetko, R. Aust. 7. Östrup, L. C. ... Denm. <i>VII</i>
XI	<ol style="list-style-type: none"> 1. Belloni, G. Ital. 2. Kudloff, W. Germ. 3. Rom, F. Belg. 4. Bertrain, G. Russ. 5. Golling, F. Aust. <i>VI</i> 6. Jöncke, A. Swed. <i>IV</i> 7. Osiiier, J. Denm. <i>V</i> 	XVI	<ol style="list-style-type: none"> 1. Böös, G. O. E. ... Swed. 2. Grineff, L. Russ. 3. Hennem, R. Belg. <i>VII</i> 4. Tucek, J. Boh. 5. Cavallini, F. Ital. <i>VI</i> 6. Breed, G. H. ... U. S. A. 7. Schön, E. Germ. <i>VIII</i>

Elimination series. 2nd Round.

7 July.

I	<ol style="list-style-type: none"> 1. Tom, L. Belg. 2. Larimer, M. W. U. S. A. 3. Alexander, S. R. G. Brit. 4. Schenker, Z. Hung. <i>I</i> 5. Nadi, N. Ital. <i>II</i> 6. Lichtenfels, J. ... Germ. <i>III</i> 	III	<ol style="list-style-type: none"> 1. Földes, D. Hung. <i>IV</i> 2. Berré, M. Belg. 3. Pfeiffer, V. Boh. 4. Breckinridge, S.D. U. S. A. 5. Seligman, E. ... G. Brit. <i>I</i> 6. Speciale, P. Ital. <i>III</i>
II	<ol style="list-style-type: none"> 1. Tvorzsky, V. ... Boh. <i>I</i> 2. Amphlett, E. M. G. Brit. <i>II</i> 3. Post, A. van Zo U. S. A. 4. Pietrasanta, F. ... Ital. 5. Berthelsen, I.O.H. Denm. 6. Zulawsky, B. ... Hung. <i>III</i> 	IV	<ol style="list-style-type: none"> 1. de Montigny, F. Belg. 2. Hall, S. U. S. A. <i>IV</i> 3. Davids, A. Germ. 4. Békessy, B. Hung. <i>II</i> 5. Jöncke, A. Swed. 6. Alajmo, A. Ital. <i>I</i>

V	1. Notaris, S. Greece	VII	1. Goppold de Lobsdorf, V., jr. ... Boh.
	2. Willems, V. Belg. IV		2. Plaskuda, H. ... Germ.
	3. Rayner, H. M. U. S. A.		3. Hennet, R. Belg. I
	4. Löffler, W. Germ.		4. Montgomerie, R.C. G. Brit. III
	5. Osier, I. Denm. II		5. Verderber, R. ... Aust. IV
	6. Toth, P. Hung. III		6. Östrup, L. C. ... Denm.
VI	1. Fagan, A. W. ... G. Brit.	VIII	1. Levison, E. Denm.
	2. Golling, F. Aust.		2. Schon, E. Germ. II
	3. Pajzs, P. Hung. I		3. Anspach, P. Belg. II
	4. Cavallini, E. Ital. IV		4. Eriksen, B. G. Norw.
	5. Hjort, C. Swed.		5. Berti, L. Hung. II
	6. Anspach, H. Belg. III		6. Ochs, J. Belg.

Elimination series. 3rd Round.

8. July.

I	1. Schenker, Z. ... Hung.	III	1. Lichtenfels, J. ... Germ.
	2. Tvorzsky, V. ... Boh.		2. Zulawsky, B. ... Hung.
	3. Seligman, E. ... G. Brit. win.		3. Speciale, P. Ital. win
	4. Alajmo, A. Ital. win.		4. Toth, P. Hung.
	5. Pajzs, P. Hung.		5. Anspach, H. Belg.
	6. Hennet, R. Belg.		6. Montgomery, R.C. G. Brit. win.
II	1. Nadi, N. Ital. win.	IV	1. Földes, D. Hung.
	2. Amphlett, E. M. G. Brit.		2. Hall, S. U. S. A.
	3. Békessy, B. Hung. win.		3. Willems, V. Belg.
	4. Osier, J. Denm.		4. Cavallini, F. Ital.
	5. Schon, E. Germ.		5. Verderber, R. ... Aust. win
	6. Anspach, P. Belg.		6. Berti, L. Hung. win

Final Round.

8 July.

Nation	Name	No.	1	2	3	4	5	6	7	8	Wins	Plac- ing
Austria ...	Verderber ...	1	☒	×	○	×	×	○	○	☒	4(10)	3
Hungary..	Berti	2	○	☒	○	×	×	○	×	○	4(10)	4
Hungary..	Békessy	3	×	×	☒	×	×	☒	×	×	1	7
Italy	Nadi	4	○	○	○	☒	○	○	○	○	7	1
Italy	Speciale	5	○	○	○	×	☒	○	○	×	5	2
Gr. Brit..	Montgomerie..	6	×	×	×	×	×	☒	×	×	0	8
Gr. Brit..	Seligman	7	×	○	○	×	×	○	☒	×	3	6
Italy	Alajmo	8	×	×	○	×	○	○	○	☒	4(11)	5

Result :

1. N. NADI Italy.
2. P. SPECIALE Italy.
3. R. VERDERBER Austria.

The foil, which, at the Olympic Games of London, in 1908 made its appearance only at a display, was now again seen in a competition, and it is difficult to understand why this branch of fencing should not have a place on the programme equally with the *épée* and the sabre. Granted, it is not the weapon of actual conflict, but then, on the other hand, it is the classic symbol of instruction and refinement in the art of fencing.

The foil represents the speed-moment in the art of fencing, this being a result of the fact that the points of attack for both opponents are always about equally distant from each other. In the case of the *épée* and the sabre, rapidity of movement plays, in a certain degree, a more subordinate role, as, in a serious attack, the risk is run of being repulsed at a point which is farther forward than that corresponding to the one it was the intention to touch. The rapid, intrepid, and logical play of the foil, with its expression of the real laws of fence is, therefore, quite as entitled to be used in competitions as *épée* and sabre fencing, which base their claims on a closer approach to the realities of actual combat.

Épée-fencing may be an excellent art but, hitherto, it has not proved itself able to replace fencing with the foil, on which science it has merely exercised an injurious influence.

The fencing with the foil showed, consequently, a falling off in style, both as regards the guard position and the attack, and also in the variations of the play in general. This holds good particularly with regard to the French school, where the difference between foil- and *épée* fencing is more pronounced than in the Italian, where both the guard positions are as good as uniform, and it was the Italian school, and the Italian fencers, too, that dominated the meeting. From the very beginning, young Nedo Nadi showed himself to be an attractive exponent of the genial art of his native land. The broad, low-lying guard, with the outstretched weapon-arm, was typically Italian. The vibrating muscles, the speaking movements of the disengaged hand, all showed the southern, nervous impatience. One or two preparatory movements when the right moment seemed to have arrived — a cry — a lightning-like lunge — the whole made a delightful, ideal picture of athletic sport. It mirrored, too, the happy confidence of a southern spirit that success has been attained; spring-like comes the elastic recovery after the lunge; the mask is wrenched from the face, showing a delighted smile sometimes changing, the next moment, to the deepest astonishment, should the judge declare "No hit!" It is a pleasure to see this graceful exhibition of power; one is touched by this naive ingenuousness, this innocent by-play. We see a child of the south from the slopes of Vesuvius.

This school has attracted many disciples of late; it embraces, too, the Austrian countries and Germany, but its characteristics vary somewhat, according to the temperament of the various nations amongst whom it is in use. During the Games of Stockholm it was more numerously represented than the French, and, in the final, by no less than six disciples, three Italians, two Hungarians and one Austrian;

the rival school, on the same occasion, boasted but two, both of them entered by Great Britain. The result of the contest can be seen by the table given above.

An examination of the tables shows us, too, the results gained by the different nations and their representatives in the struggle towards the final. To give an account in words of the "varying issue of the fight" would be of little value; the struggle had to be seen to be appreciated. Still, the characteristic features of the two leading schools, the Italian and the French, are deserving of a word or two of mention.

The Italian School, which, on the whole, is faithful to ancient traditions, with its stronger weapon, its larger guard, its more powerful grasp (the hand often being bound fast) gives at once the impression of a more serious conception of the art; the deep-lying guard with the threatening, outstretched arm gives the illusion of actual combat, especially when a fiery temperament sets every force in motion to reach its aim or to avoid defeat. It is temperament that places its seal on this form of the art of fencing. When it leaves its native country and finds a home beneath northern skies, its characteristics alter to a certain degree. In Austria, its disciples are still warm-blooded fencers; but this feature disappears amongst the colder Germanic peoples. This type of fencing therefore, child of speed and power as it is, seems more pristine, more natural, and possesses a certain uniformity of method in the use of the various weapons.

These characteristics appear most clearly when the Italian school is seen side by side with its most successful rival, the French. The last line of one of Coppée's ballads runs: 'Il n'est de fin fleuret qu'en France!' and perhaps the poet is right. Here we meet a lighter weapon, one possessing no special guard, and with the simplest of grasps. These features alone hint at the refined nature of the school, a nature that is quite a natural one. Transplanted to French soil during the Renaissance period, fencing, like other forms of art, put on the features characteristic of French culture — elegance, lucidity, logic. And it is on this basis that its school of fencing has since developed. We see the French guard a calmer one; its movements are not so threatening; it endeavours to oppose elegance to violence, and to meet the impetuous attacks of an opponent with smiling confidence, in full reliance on the superiority of a refined technique. In a powerful hand it possesses equal authority with the Italian, while, just as a result of its more refined temperament, it lends itself more easily to the subtleties of the art. This it is, that, in France, has given rise to the fanatical strife between the fleuretists and the épéeists — a strife which, hitherto, has brought defeat to the first-named, but which, at bottom somewhat artificial, will probably prove beneficial for the development of both weapons.

The influence of the French school has extended to Great Britain, Scandinavia, Russia and, of late, both to North and South America, while, at the same time, it has numerous adherents in all countries where the art of fencing is practised.

It is more than a pity that the French themselves were not present to defend their own school. Nedo Nadi's skill would then most certainly have been put to a severer test — and his glory have been the greater had he still been the victor.

II. A. ÉPÉE TEAM COMPETITION.

9—10 July.

Protocol.

Elimination Series		Final
1st round	2nd round	
Tuesday, 9 July		Wednesday, 10 July
9—1.30	2—6.30	9—3
I { 1. Holland. I 3. Germany. II	I { 1. Holland. Win. 2. Great Britain. Win. 3. Bohemia. 4. Denmark.	Final { 1. Holland. 2. Great Britain. 3. Belgium. 4. Sweden.
II { 1. Russia. 2. Great Britain. I 3. Belgium. II		
III { 1. Bohemia. I 2. Norway. 3. Sweden. II	II { 4. Germany. 3. Belgium. Win. 2. Sweden. Win. 1. Greece.	
IV { 1. Denmark. I 2. Greece. II 3. U. S. A.		

Result:

1. BELGIUM.
2. GREAT BRITAIN.
3. HOLLAND.

The épée competitions began on July 9th. The épée is the arm that, during the last two decades, has worked its way onwards to the first place in fencing programmes; with much grandesse it has compelled the foil to yield its pride of place, and has quite won the favour of the public.

But épée fencing deserves all possible encouragement, for it affords the spectacle of a play as fine, if not finer than that given by the foil, while, at the same time, it demands of its exponent a real knowledge of the art of fencing. The reproach often directed by the lovers of the épée against fencers with the foil, that their play is all too conventional, can, with much show of reason, be also addressed to the former too; the restrictions blamed differing merely in kind. But, by degrees, the influence of international meetings, and the proper elaboration and application of such criticisms, will be sure to rub off the rough corners of both.

The programme of the épée competitions displayed the fine figure of no less than eleven nations prepared to enter the lists. The

contest was one of special interest to us, Swedes; our team fighting its way on to the final, and, at one moment promising to carry off the third prize.

The draws for the rounds were so arranged that, of three nation-teams in the pools of the first round, two appeared in the second round, while, of four teams in the pools of the second round, two remained for the final, so that no team was excluded from the final unless it had met, and lost against, two other teams at least.

The table given above shows how the nations struggled on the path leading to the final, and it was a pleasure for us, quite naturally, that the Swedish team held its own so long.

The struggle in the final was a hot one, and marked by constantly varying fortunes. The Belgians issued successful from the contest, having beaten all their opponents, thus making sure of the gold medal. The other teams proved to be so well matched that, after the first meeting, they stood equal, with one win and two defeats each. The original intention had been that, in the event of this (barrage) happening, the ties should be fought out, but in consequence of pressure of time and other circumstances, it was determined, later on, that the placing should be settled by the number of hits received. This was fatal to the Swedish team, for it was found that its total hits received amounted to 32, the Dutch team counting but 30, and Great Britain's, only 28.

There were many exciting moments during the course of the final, the result of the matches between the British and Dutch teams, on the one hand, and the Dutch and the Swedish teams on the other, depending on one — the last — hit alone. In the last-named match, the meeting was especially interesting, as it had to be re-fought, in consequence of a fault in the judging leading to a protest which was upheld by the jury of honour. As was said above, the three nations in question proved to be pretty equal, but Holland's team fought on with an energy worthy of all admiration, even when, on one or two occasions, its chances of success seemed very dark. The team's motto was, very evidently "Never despair", and it finally succeeded in gaining third place.

II B. Individual Épée Competition.

11—13 July.

Protocol.

Elimination Series : 1st Round.

11-12 July

I	<ol style="list-style-type: none"> 1. Grönhagen, Å. E. Swed. 2. de Jongh, H. ... Holl. I 3. Notaris, S. Greece II 4. Guoworsky, P. ... Russ. 5. Levison Denm. III 6. Alexander, G. R. G. Brit. 7. Lichtenfels, J. ... Germ. 8. Willems, V. Belg. 	II	<ol style="list-style-type: none"> 1. Hassanein, A. M. Egyp. 2. Manos Greece V 3. Anspach, P. Belg. IV 4. Schwarz, F. Germ. 5. Soldatencow, A. Russ. 6. Enell, K. H. A. Swed. 7. Berthelsen, J.O.H. Denm. VI 8. Tucek, J. Boh.
---	--	----	---

III	I.	Erckrath de Bary,		IX	I.	van Geuns, J. E. G.	Holl.	
		J.	Germ.			2.	Rechner, V.	Boh.
		Correa, F.	Port.			3.	Ziegler, H.	Germ.
		Tvorzsky, V. ...	Boh.			4.	Everitt, A. F. G.	G. Brit. II
		Tom, L.	Belg. VIII			5.	Boin, V.	Belg. VI
		Griez von Ronse,				6.	Mathiesen, S. W.	Norm. V
		A. D.	Aust. IV			7.	Hammond, D., ...	U. S. A.
		Cotzias, C.	Greece VII					
IV	1.	Sörensen, E.	Swed. V	X	1.	Thomson, H. ...	Germ. III	
		Cambas, P. A. ...	Greece			2.	de Beaufort, J. D.	
		Trampler, R. ...	Aust.				H.	Holl. IV
		Goppold de Lobs-				3.	Versis	Greece
		dorf, V., jr. ...	Boh. VI			4.	MacLaughlin, J. A.	U. S. A.
		Hall, S.	U. S. A.			5.	Salmon, G. C. J. M.	Belg.
		Finne, S.	Norm. IV			6.	Dawson, P. M., ...	G. Brit.
		de Samawsky, W.	Russ.			7.	Pfeiffer, V.	Boh.
van Rossem, G.	Hol.	8.	Sparre, L.	Swed. VII				
V	1.	Breed, E. H. ...	U. S. A. V	XI	1.	Anspach, H.	Belg. VII	
		Vávra, Z.	Boh. I			2.	Verderber	Aust.
		Rom, F.	Belg.			3.	Goppold de Lobs-	
		Cvetko, R.	Aust.			4.	dorf, sr	Boh.
		de Laval, E. P. H.	Swed.			5.	Amphlett, E. M. G.	Brit. III
		von Tangen, G.	Norw.			6.	Dahmen von Buch-	
		Charalampoulos...	Greece			7.	holz, R. W. ...	Holl.
		Bertrain, G.	Russ. II			8.	Schenk, F.	U. S. A. I
VI	1.	de Laval, P. G. F.	Swed.	XII	1.	Barta, Z.	Boh. VIII	
		Ochs, J.	Belg. III			2.	Osiier, J.	Denm. I
		Suttner, A.	Aust.			3.	Wooijewaard, H.	Holl.
		Eriksen, B. G. ...	Norw.			4.	Bowman, W. L.	U. S. A. II
		Klika, M.	Boh. II			5.	Peyron, H. G. R.	Swed.
		Breckinridge, S. D.	U. S. A.			6.	Jack, F.	Germ.
		Seligman, E. ...	G. Brit. I			7.	Cook, S.	G. Brit.
		Martucheff, L. ...	Russ.			8.	Hennet, R.	Belg.
VII	1.	Perk, A. C.	Holl.	XIII	1.	Lindblom, G. T.	Swed. VI	
		Holt, M. D. V. ...	G. Brit. VIII			2.	de Jong, A. E. W.	Holl. VII
		Sauer, A. E. ...	U. S. A.			3.	Berré, M.	Belg.
		Hardy de Beau-				4.	Plaskuda, H. ...	Germ.
		lieu, P.	Belg. II			5.	Olsen, H.	Denm.
		Javrirek, J.	Boh.			6.	Versis, C.	Greece VIII
		Aas, L. T.	Norw. III			7.	Gignoux, J. E. ...	U. S. A.
Gate, W. P.	S. Afr.	8.	Martineau, S. ...	G. Brit.				
VIII	1.	Nardus, L.	Holl.	XIV	1.	van Zo Post, A.	U. S. A. VIII	
		de Montigny, F.	Belg. I			2.	Sander, K.	Denm.
		Larimer, M. W.	U. S. A.			3.	Georgiades, J. N.	Greece
		Platou, H.	Norw.			4.	Bos, A.	Holl.
		Kriz, F.	Boh. III			5.	Rosty, P.	Hung. VII
		Schrader, H. ...	Germ.			6.	Naumann, A. ...	Germ.
		Montgomerie, R.				7.	van der Byl, C.	G. Brit. II
		C. L.	G. Brit. IV			8.	Carlberg, E.	Swed.

XV	{	1. Moore, J. M. ... U. S. A.	XVI	{	1. Petropoulos, G. ... Greece IV
		2. van Blijenbourg, W. P. H. Holl.			2. Krokstedt, C. G. Swed.
		3. Triantaphillacos, T. Greece VI			3. Meienreis, W. ... Germ.
		4. Blake, J. P. G. Brit.			4. Molijn, W. E. ... Holl.
		5. Békessy, B. Hung.			5. de Kniajëvitsch, D. Russ.
		6. Branting, G. Swed. VIII			6. Ames, G. G. Brit. V
		7. BeRNtsen, O. Denm.			7. Östrup, L. C. ... Denm.
		8. Schön, E. Germ. V			8. Goppold de Lobs- dorf, K. sr ... Boh. VII

Elimination Series : 2nd Round.

12 July.

I	{	1. de Jongh, H. ... Holl.	V	{	1. Manos, P. Greece I
		2. Vávra, Z. Boh. I			2. Sörensen, E. ... Swed. I
		3. Seligman, E. ... G. Brit. II			3. Breed, E. H. ... U. S. A.
		4. de Montigny, F. Belg.			4. Mathiesen, S. W. Norw.
		5. Schenk, F. U. S. A.			5. Schön, E. Germ.
		6. Osier, J. Denm. III			6. Ames, G. G. Brit. II
II	{	1. Notaris, S. Greece	VI	{	1. Berthelsen, J. O. H. Denm.
		2. Bertrain, G. Russ.			2. Goppold de Lobs- dorf, V., jr ... Boh. IV
		3. Klika, M. Boh. II			3. Boin, V. Belg. III
		4. Hardy de Beau- lieu, P. Belg. IV			4. van der Byl, C. G. Brit.
		5. Everitt, A. F. G. G. Brit. I			5. Triantaphillacos, T. Greece
		6. Bowman, W. L. U. S. A. I			6. Lindblom, S. T. Swed. III
III	{	1. Levison, E. Denm. IV	VII	{	1. Cotzias, C. Greece
		2. Ochs, J. Belg.			2. Anspach, H. Belg. III
		3. Kriz, F. Boh. III			3. Sparre, L. Swed.
		4. Aas, L. L. Norw.			4. Goppold de Lobs- dorf, K., sr ... Boh.
		5. Amphlett, E. M. G. Brit. I			5. Rosty, P. Hung. II
		6. Thomson, H. ... Germ.			6. de Jong, A. E. W. Holl. II
IV	{	1. Anspach, P. Belg. II	VIII	{	1. Tom, L. Belg. I
		2. Finne, S. Norw.			2. Holt, M. D. V. ... G. Brit. IV
		3. Montgomerie, R. C. L. G. Brit. III			3. van Zo Post, A. U. S. A.
		4. de Beaufort, J. D. H. Holl.			4. Barta, Z. Boh.
		5. Griez v. Ronse, A. D. Aust.			5. Branting, G. Swed. IV
		6. Petropoulos, G. ... Greece IV			6. Versis, C. Greece

Elimination Series : 3rd Round.

13 July.

I	{	1. Vávra, Z. Boh.	II	{	1. Seligman, E. ... G. Brit. win.
		2. Bowman, W. L. U. S. A.			2. Klika, M. Boh.
		3. Amphlett, E. H. G. Brit.			3. Anspach, P. Belg. win.
		4. Manos, P. Greece			4. Ames, G. G. Brit.
		5. Tom, L. Belg. win.			5. Rosty, P. Hung.
		6. Sörensen, E. Swed. win.			6. de Jong, A. E. W. Holl.

III	{	1. Osier, J. Denm. win.	IV	{	1. Hardy de Beau-	win.
		2. Kriz, F. Boh.			lieu, P. Belg.	
		3. Montgomerie, R. C. L. G. Brit.			2. Levison, E. Denm.	
		4. Boin, V. Belg.			3. Petrapoulos, G. Greece	
		5. Anspach, H. Belg. win.			4. Goppold de Lobs-	
		6. Lindblom, G. T. Swed.			dorf, V., jr ... Boh.	
		5. Branting, G. Swed.			6. Holt, M. D. V. G. Brit. win.	

Final.

13 July.

Nation	Name	No	1	2	3	4	5	6	7	8	No. of wins	Plac- ing
Belgium	Anspach, P. ...	1	☒	○	○	○	○	×	○	○	6	1
Belgium	Boin, V.	2	×	☒	○	×	○	○	×	○	4	4
Sweden	Sörensen, E. ...	3	×	×	☒	○	○	○	×	×	3	5
G. Britain	Holt, M. D. V.	4	×	×	×	☒	×	×	×	×	0	8
Belgium	Tom, L.	5	×	×	×	○	☒	×	×	×	1	7
G. Britain	Seligman, E. ...	6	○	×	×	×	○	☒	×	×	2	6
Belgium	H. de Beaulieu	7	×	○	○	×	○	○	☒	×	4	3
Denmark	Osiier, J.	8	×	×	○	○	○	○	○	☒	5	2

Result: 1. P. ANSPACH Belgium.
 2. J. OSSIER Denmark.
 3. P. LE HARDY DE BEAULIEU ... Belgium

The above table shows us, in the same way as that for the foil fencing, the progress of the individual épée competition, and we can thus follow the varying fortune of the competitors during the three days' struggle. Quite naturally, during the progress of the team events, the interest of the public is concerned with the triumph of the one nation or the other, while, when the individual competitions begin, it is the fortunes of the single player alone that excites us, and draws our attention to his style and personal ability. In the latter case it is a matter of individual against individual, and the result of the meeting is seen almost immediately, without any very circumstantial calculations.

It was a great loss not to see any Italians present to defend their school in this competition. As it was, the French school dominated the proceedings, represented as it was by Belgians, Danes and Swedes and the competitors from Great Britain. There was no representative of the Italian school in the final, and the Belgians confirmed their success in the team competition by carrying off the gold and the

bronze medals in the individual event, too, the silver medal falling to Denmark.

It was encouraging to Swedish fencing to find that, thanks to Captain Sörensen, who was placed No. 5, our country was again represented in the final.

III A. SABRE TEAM COMPETITION.

14—15 July,

Protocol.

Elimination Series		Final
Ist round	2nd round	
Sunday, 14 July		Monday, 15 July
8—11 a. m.; 1—2.30 p. m.	3—7.30 p. m.	9 a. m.—3 p. m.
I $\left\{ \begin{array}{l} 1. \text{ Bohemia. } I \\ 2. \text{ Hungary. } II \\ 3. \text{ Greece.} \end{array} \right.$	I $\left\{ \begin{array}{l} 1. \text{ Bohemia. } \textit{win.} \\ 2. \text{ Belgium.} \\ 3. \text{ Great Britain.} \\ 4. \text{ Holland. } \textit{win.} \end{array} \right.$	Final $\left\{ \begin{array}{l} 1. \text{ Bohemia.} \\ 2. \text{ Holland.} \\ 3. \text{ Hungary.} \\ 4. \text{ Austria.} \end{array} \right.$
II $\left\{ \begin{array}{l} 1. \text{ Belgium. } I \\ 2. \text{ Russia. } II \\ 3. \text{ Italy.} \end{array} \right.$		
III $\left\{ \begin{array}{l} 1. \text{ Sweden.} \\ 2. \text{ Great Britain.} \\ 3. \text{ Italy.} \end{array} \right.$		
IV $\left\{ \begin{array}{l} 1. \text{ Holland. } I \\ 2. \text{ Austria. } II \\ 3. \text{ Denmark.} \end{array} \right.$		
	II $\left\{ \begin{array}{l} 1. \text{ Hungary. } \textit{win.} \\ 2. \text{ Russia.} \\ 3. \text{ Germany.} \\ 4. \text{ Austria. } \textit{win.} \end{array} \right.$	

Result: 1. HUNGARY.
2. AUSTRIA.
3. HOLLAND.

The competitions with the sabre began on July 14. The weapon used was one somewhat unfamiliar here; it was the light form of the sabre which is generally called 'the Italian', the style of fencing being something between those of the foil and the épée. New nations with victories in new arts of fence now come to the fore, and compel more ancient styles to withdraw to the background. Hungary dominated the entire field and carried off the gold medal in both the team and the individual competition, thus repeating the victories it gained in London, at the Olympic Games of 1908. Now, as then, the fencing of the Hungarians awakened well-deserved attention, and afforded an encouraging example of the results that can be obtained by means of a good school and methodical work. They excluded every other nation from the final with the exception of Italy, whose sole representative was Nedo Nadi, the winner in the foils. Sweden had a team in this event, too, its members giving hopes for the future.

The eliminating rounds were carried out group-wise, on the same principles as those obtaining in the épée competition. In the first round, the Greeks retired without a stroke. In the second, the Russians were beaten after an energetic resistance; the team really deserved a better fate, for its fencing, as a whole, was a most artistic display, and the superiority shown by the Belgians and the Italians was exceedingly little. The Swedes and the Danes were eliminated in the first round, each in its special group, and it soon grew evident that Austria, Hungary, and Bohemia had the lead, no other country than Holland being able to fight its way to the final. This round was a series of most brilliant meetings, the Hungarians remaining unbeaten to the end. As in the contests with the épée, the Dutch team worked with the greatest energy, and finally succeeded in beating the Bohemian team, which, although pursued by ill-luck, gave a first-class exhibition of fencing, under its 50-year old leader, Gopphold de Lobsdorf, sr, seconded by his two sons.

III B. INDIVIDUAL SABRE COMPETITION.

16—18 July.

Protocol.

Elimination Series : 1st Round.

16—17 July.

I	1.	Armgarth, G. ...	Swed.	II	V	1.	van der Byl, C. G. Brit.	V	
	2.	Steffan, M.	Germ.			2.	Javurek, J.	B o h.	II
	3.	Cveto, R.	Aust.			3.	Olsen, H.	Denm.	
	4.	Werkner, L.	Hung.			4.	di Nola, U.	Ital.	
	5.	Danitch, W.	Russ.			5.	Doorman, J.	Holl.	
	6.	Benfratello, J. ...	Ital.			6.	Klerck, C. G. ...	Swed.	
	7.	Cambas, P. A. ...	Greece			7.	Sakiritch G.	Russ.	
	8.	Östrup, L. C. ...	Denm.			8.	Puhm, J.,	Aust.	VII
II	1.	Belloni, G.	Ital.	VII	VI	1.	Kolling, J. C. ...	Holl.	
	2.	Golling, F.	Aust.			2.	Trampler, R. ...	Aust.	
	3.	Werner, H.	Swed.			3.	Tvorzsky, V. ...	Boh.	
	4.	Zulawsky, B. ...	Hung.			4.	Ridley-Martin, A. G. Brit.	VIII	
	5.	Schejbal, B.	Boh.			5.	Kullberg, A. B. G. Swed.		
	6.	Osiier, I.	Denm.			6.	Levison, E.	Denm.	I
	7.	Lichtenfels, J. ...	Germ.			7.	Timofëew, A. ...	Russ.	II
	8.	Andreeff, W. ...	Russ.			8.	Diana, D.	Ital.	
III	1.	Nepokoupoi, B. Russ.		VII	VII	1.	Boin, V.	Belg.	
	2.	Münich, C.	Aust.			2.	Marsh, W. W. ...	G. Brit.	III
	3.	Cipera, J.	Boh.			3.	Jöncke, A.	Swed.	
	4.	Thomson, H. ...	Germ.			4.	Békessy, B.	Hung.	IV
	5.	Berthelsen, J.O.H. Denm.	VI			5.	Watercampf, C. ...	Russ.	
	6.	Cavallini, F.	Ital.			6.	de Jong, A. E. W. Holl.		
	7.	Georgacopoulos, P.	Greece			7.	Dereani, F.	Aust.	V
IV	1.	Kordojannis, T. Greece		VIII	VIII	1.	Jack, F.	Germ.	
	2.	van Rossem, G. Holl.				2.	de Jongh, H. . .	Holl.	VI
	3.	Bogen, A.	Aust.			3.	Ochs, J.	Belg.	
	4.	Barta, Z.	Boh.			4.	Godfree, D. W. G. Brit.		
	5.	Alajmo, E.	Ital.			5.	Nordenström, S. A. M.	Swed.	VII
	6.	Berntsen, O.	Denm.			6.	Toth, P;	Hung.	VIII
	7.	Chkileff, A.	Russ.			7.	Mordovine, A. ..	Russ.	
						8.	Pfeiffer, J.	Boh.	

IX	1. Gopphold de Lobsdorf, K. Hung.	XIII	1. Pajzs, P. Hung. VII
	2. Stöhr, G. Germ. I		2. Gate, W. P. S.-Afr.
	3. Dahmen v. Buchholz, R. W. ... Holl.		3. Pietrasanta, F. ... Ital. VIII
	4. Kousniezoff, N. Russ. IV		4. Syson, A. E. ... G. Brit. VI
	5. Hardy de Beaulieu, P. Belg.		5. Anspach, H. Belg.
	6. Fitz-Clarence, C. G. Brit.		6. Triantaphillacos, T. Greece
	7. Stranne, J. S. M. Swed.		7. Erckrath de Bary, J. Germ.
	8. Mészáros, E. ... Hung. III		8. Suttner, A. Aust.
X	1. Anspach, P. Belg.	XIV	1. Nadi, N. Ital. VII
	2. Goppold de Lobsdorf, V., sr ... Boh.		2. Salmon, G. C. J. M. Belg.
	3. Guiber von Greifenfels, A. Russ. V		3. Plaskuda, H. Germ.
	4. Wooijewaard, H. Holl.		4. Petropoulos, G. Greece
	5. Fuchs, J. Hung. VI		5. Corble, A. H. ... G. Brit.
	6. Feilman, F. E. B. G. Brit.		6. Gerde, O. Hung. II
	7. Personne, C. B. ... Swed. VIII		7. Post van Zo, A. U. S. A. VIII
	8. Schön, E. Germ.		8. Goppold de Lobsdorf, V., jr, ... Boh.
XI	1. Ziegler, H. Germ.	XV	1. Notaris, S. Greece
	2. Dunay, B. Hung. I		2. Speciale, P. Ital.
	3. zu Hohenlohe, E. Aust. III		3. Brambeck, N.F.O. Swed.
	4. van Blijenburgh, W. P. Holl.		4. Meienreis, W. ... Germ.
	5. Georgiades, J. N. Greece		5. Herschmann, O. Aust.
	6. Crawshay, R. O. G. Brit.		6. Sauer, A. E. ... U. S. A. II
	7. Tucek, J. Boh.		7. Foldes, D. Hung. IV
	8. Arsenieff, B. Russ. VI		8. Keene, A. V. ... G. Brit. VII
XII	1. Svorcik, O. Boh.	XVI	1. Berti, L. Hung. I
	2. Versis, C. Greece		2. Patton, G. S., Jr U. S. A.
	3. Filatoff, P. Russ.		3. Adam, J. Germ.
	4. Scalongue, D. ... Holl.		4. Lindholm, G. W. Swed.
	5. Tom, L. Belg.		5. Pontenani, A. ... Ital. IV
	6. Butterworth, H. R. G. Brit. II		6. Brookfield, E. W. H. G. Brit. V
	7. Schwarz, F. Germ. III		7. Cotzias, C. Greece
	8. Schenker, Z. ... Hung. V		8. Verderber, R. ... Aust.

Elimination Series : 2nd Round.

17 July.

I	1. Benfratello, J. ... Ital.	III	1. Danitch, W. Russ.
	2. Andreeff, W. ... Russ. II		2. Alajmo, E. Ital.
	3. Levison, E. Denm.		3. Marsh, W. W. ... G. Brit. IV
	4. Stöhr, G. Germ.		4. Mészáros, E. ... Hung. III
	5. Dunay, B. Hung. I		5. zu Hohenlohe, E. Aust.
	6. Berti, L. Hung. IV		6. Schwarz, F. Germ. I
II	1. Werkner, L. Hung. IV	IV	1. München, C. Aust.
	2. Bogen, A. Aust.		2. Bemtsen, O. Denm. IV
	3. Timoféew, A. ... Russ. I		3. Békessy, B. Hung. I
	4. Butterworth, H. R. G. Brit.		4. Kousniezoff, N. Russ.
	5. Sauer, A. E. ... U. S. A.		5. Földes, D. Hung. III
	6. Gerde, O. Hung. II		6. Potenani, A. Ital.

V	1.	Thomson, H. ...	Germ.	VII	1.	Zulawsky, B. ...	Hung.	I	
	2.	van der Byl, C. ...	G. Brit.		III	2.	Puhm, J.	Aust.	
	3.	Dereani, F.	Aust.			3.	Nordenström, S.		
	4.	G. v. Greifenfels,				4.	A. M.	Swed.	
		A.	Russ.		IV	5.	Keene, A. V. ...	G. Brit.	
	5.	Schenker, Z. ...	Hung.		IV	6.	Nadi, N.	Ital.	I
VI	6.	Brookfield, E. W.			6.	Pajz, P.	Hung.	III	
		H.	G. Brit.						
	1.	Berthelsen, O. ...	Denm.	VIII	1.	Lichtenfels, J. ...	Germ.	II	
	2.	Javurek, J.	Boh.		2.	Ridley-Martin, A.	G. Brit.		
	3.	de Jong, H.	Holl.		3.	Toth, P.	Hung.	III	
	4.	Fuchs, J.	Hung.		II	4.	Personne, C. B.	Swed.	III
5.	Arsenieff, B.	Russ.	III		5.	van Zo Post, A.	U. S. A.		
6.	Syson, A. E. ...	G. Brit.	II		6.	Pietrasanta, F. ...	Ital.		

Elimination Series : 3rd Round.

18 July.

I	1.	Dunay, B.	Hung.	III	1.	Földes D. ...	Hung.	win	
	2.	Timoféew, A. ...	Russ.		2.	van der Byl.	G. Brit.		
	3.	Schwartz, F.	Germ.		3.	Arsenieff, B.	Russ.		
	4.	Békessy, B.	Hung.		win.	4.	Mészáros, E. ...	Hung.	win.
	5.	Zulawsky, B.	Hung.			5.	Pajzs, P.	Hung.	
	6.	Nadi, N.	Ital.		win.	6.	Personne, C. B.	Swed.	
II	1.	Gerde, O.	Hung.	IV	1.	Werkner, L. ...	Hung.	win.	
	2.	Andreeff, W. ...	Russ.		2.	Marsh, W. W. ...	G. Brit.		
	3.	Syson, A. E. ...	G. Brit.		3.	Berntsen, O.	Denm.		
	4.	Fuchs, J.	Hung.		win.	4.	Berti, L.	Hung.	
	5.	Toth, P.	Hung.		win.	5.	Schenker, Z. ...	Hung.	win.
	6.	Lichtenfels, ...	Germ.			6.	Guiber van Grei-	fenfels, A.	Russ.

Final.

18 July.

Nation	Name	No.	1	2	3	4	5	6	7	8	No. of wins	Plac-ing
Hungary	Békessy, B. ...	1	■	○	×	○	○	×	○	○	5(3)	2
Italy	Nadi, Nedo ...	2	×	■	×	○	○	×	○	○	4(8)	5
Hungary	Fuchs, J.	3	○	○	■	○	○	○	○	×	6	1
Hungary	Toth, P.	4	×	×	×	■	×	○	○	×	2	6
Hungary	Földes, D. ...	5	×	×	×	○	■	×	×	×	1(2)	8
Hungary	Mészáros, E. ...	6	○	○	×	×	○	■	○	○	5(6)	3
Hungary	Werkner, L. ...	7	×	×	×	×	○	×	■	×	1(1)	7
Hungary	Schenker, Z.	8	×	×	○	○	○	×	○	■	4(4)	4

- Result:*
1. J. FUCHS Hungary.
 2. B. BÉKESSY..... Hungary.
 3. E. MESZAROS Hungary.

Interest in the sabre competitions increased considerably during the latter part of the meeting, and the public, often present in fairly large numbers, seemed to have a better appreciation of the lively, sporting character of the fencing, features that distinguished it from the competitions with the other weapons.

The Hungarians in this event brilliantly maintained their reputation as, perhaps, the greatest masters of the sabre in Europe, and their leading representative, Dr. Fuchs, awakened general admiration by the skill and strength he displayed during the course of the competition. Although of slight build and rather low stature, he succeeded, by means of his well-calculated sabre-play, in repelling the attacks of, and defeating, the most powerfully built and vigorous opponents. One saw the results of good schooling and methodical training; there were no attempts at artificial surprises; nothing was left to chance; determination and strength were not spared, on the other hand, whenever an attack was at length made from some well-chosen position.

* * *

This event closed the Fencing Competitions of the Olympic Games of Stockholm, 1912. They had continued uninterruptedly for thirteen days, and were a good test of the strength and endurance of those competitors who had taken part in a majority of the events. Nothing occurred to disturb the harmony of the proceedings, and the meeting left nothing but the most pleasant memories.

The chief lessons taught by the competitions, and which are worthy of attention on the part of those that have to undertake the arrangement of future Olympic Games, were:

- 1) The necessity of having a proper time-table and a detailed plan for the competitions, so as to be certain of all the events going off without any hitch as regards time, and of the competitors being caused the least possible inconvenience. The arrangements in these respects made on the present occasion were fully satisfactory.
- 2) The adoption of fixed international rules, accepted by all the nations taking part in the Olympic Games.
- 3) The arrangement of the Jury question, both as regards the matter of obtaining a sufficient number of competent judges, and also with regard to a speedy and uniform method of judging.
- 4) The desirability of the retention of the foil competition.
- 5) The desirability of the inclusion of bayonet-fencing in the programme.

* * *

The relative position of the nations, according to the official method of counting points, was as follows:

Nation	1:st Prize	2:nd Prize	3:rd Prize	Points
Hungary	2	1	1	9
Belgium	2	—	1	7
Italy	1	1	—	5
Austria	—	1	1	3
Denmark	—	1	—	2
Great Britain	—	1	—	2
Holland	—	—	2	2

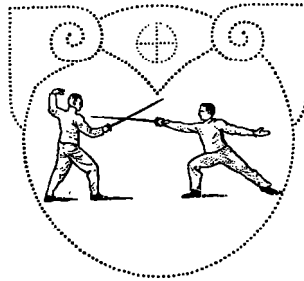

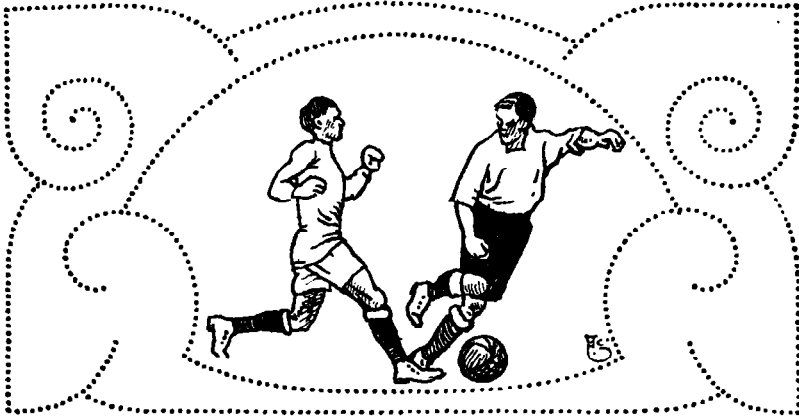

FOOTBALL.

THE INCLUSION OF FOOTBALL IN THE PROGRAMME OF THE FIFTH OLYMPIAD.

When the Olympic Committee began the work of drawing up the plan for the Olympic Games of Stockholm in 1912, there was, as has already been pointed out, one special point of view which was greatly emphasized and kept to, viz., that the programme of the Games should embrace nothing but *real competitions*. This was done for the purpose of freeing the Games, as much as possible, from that sub-division of athletics which goes under the name of 'games' while, of course, it was clearly understood that no forms of sport that were not generally practised were to be included in the coming Games.

The question then quite logically arose of whether Association Football was to be placed on the programme or not. This branch of sport comes, undeniably under the title of "game" but, on the other hand, there was a debate as to whether it had won such world-wide extension, such undisputable popularity, that Association Football clubs were to be found in almost every country where climatic conditions did not place insuperable hindrances in the way. The Committee had to act consistently, too. If football could not be included, its exclusion would result in the omission from the programme of Water-polo ; "aquatic football" as it may be called. In addition to this, the Football Associations of a great number of nations had, as early as the autumn of 1910, made inquiries of the Swedish Olympic Committee and of the Swedish Football Association, whether football according to Association rules would form part of the programme of the Games,

and so the Technical Section of the Committee found itself obliged to recommend the adoption of Association Football as part of the programme of the coming Olympiad.

THE TECHNICAL MANAGEMENT OF THE COMPETITION.

The Swedish Football Association which, at first, had shared the opinion of the Swedish Olympic Committee that it was an error in principle to add games to the Olympic programme, had nothing to urge against Association Football's obtaining a place on the list of events, after the turn matters had taken, and the Swedish Association also expressed its willingness to make itself responsible for all the arrangements necessary for the Olympic football competitions and, for that purpose, instructed its Secretary to draw up the form of agreement to be entered into with the Swedish Olympic Committee, to negotiate with that body and, eventually, to sign the agreement in question on behalf of the Association.

In consequence of the plan of work adopted by the Swedish Olympic Committee, the latter considered, however, that it could not enter into direct communication with the Swedish Football Association in the matter, but begged the Association to appoint a special Committee for the purpose. The request was at once complied with, Messrs. ANTON JOHANSON, GOTTHOLD OHRLING and EDVIN SANDBORG being chosen as the members of this committee.

As early as January, 1911, the negotiations between the Swedish Olympic Committee and the Swedish Football Association had been brought to a close and the above-mentioned agreement signed, after which, the Association, at a meeting held the same month, nominated some of its number as members of the *Olympic Football Committee* which, consisting at first of 11 persons, all of them belonging to the Committee of the Swedish Football Association, was afterwards further increased until its final composition was as follows:

President: C. L. KORNERUP, Esq., Stockholm.
Secretary : ANTON JOHANSON, Esq., Stockholm.
Other Members: Messrs. RICKARD ANDERSSON, Stockholm.
GÖSTA DALMAN, Gothenburg.
OSCAR FORSHELL, Gothenburg.
WILHELM FRIBERG, Gothenburg.
EKIK GRAHN, Örebro.
A. HAMMAR, Gäfle.
CARL HELLBERG, Stockholm.
ERLAND HJÄMEJE, Gothenburg.
IVAR HOLM, Stockholm.
RYBIN JOHANSSON, Helsingborg.
JOHN OHLSON, Eskilstuna.
GOTTHOLD OHRLING, Stockholm.
EDVIN SANDBORG, Stockholm.

The members of the various sub-committees were:



GREAT BRITAIN (white jerseys) v. DENMARK, IN THE FOOTBALL FINAL AT THE STADIUM.



H. R. H. THE CROWN PRINCE AND THE HUNGARIAN FOOTBALL TEAM.



FROM THE FOOTBALL FINAL, GREAT BRITAIN v. DENMARK. M IDDELBOE, the Danish captain, at work.



THE FOOTBALL FINAL, GREAT BRITAIN v. DENMARK. The British goal in danger.

Finance Committee:

Messrs. CARL HELLBERG, ANTON JOHANSON, JOHN OHLSON, G. OHR-
LING and EDVIN SANDBORG.

Reception Committee:

Messrs. GÖSTA DALMAN, OSCAR FORSHELL, CARL HELLBERG, ANTON
JOHANSON, ERNST KILLANDER, C. L. KORNERUP and G. LINDENCRONA.

Technical Committee:

Messrs. OSCAR FORSHELL, WILHELM FRIBERG, ERIK GRAHN, A.
HAMMAR, CARL HELLBERG, ERLAND HJÄRNE, ANTON JOHANSON, RYBIN
JOHANSON, JOHN OHLSON, G. OHRLING and EDVIN SANDBORG.

According to the agreement made between the Swedish Olympic Committee and the Swedish Football Association, the football competitions were to be arranged independently by the Swedish Olympic Football Committee, in full agreement with the regulations of the International Football Federation. The matches were to take place during the period June 29th—July 5th, 1912. The Swedish Football Association was to undertake the financial risk attendant on the competitions, and, in return, was to receive any eventual profit resulting from the matches, the Swedish Olympic Committee, however, being entitled to 25 % of the money received from the sale of tickets, and also to a certain number of complimentary tickets. The Swedish Olympic Committee also reserved the right of inspecting the accounts of the money received from the sale of tickets. The Swedish Olympic Committee was to pay all advertising and printing expenses, whilst the Football Committee itself was responsible for the procural of referees, and for expenses incurred by the arrangement of the competitions and any eventual festivities for the competitors in the matches. The entries for the competition and all the foreign correspondence were to be the charge of the Secretariat of the Olympic Committee.

SPECIAL ARRANGEMENTS FOR THE FOOTBALL COMPETITIONS.

The Swedish Olympic Football Committee thereupon commenced its labours, on the basis of the above-mentioned agreement.

The Committee had a very easy task as regards the general rules and regulations for the football-matches, no special arrangements having to be made in this matter, as, thanks to the existence of the Federation Internationale de Football Association, whose rules were adopted, all the rules of the competitions, the amateur definition, etc., already existed and sufficed for their purpose. The following expression of opinion made in 1911, at the annual meeting of the International Football Federation, in connection with the right of making entries, deserves attention, however: "Although the rules for the Football Competitions at the Olympic Games of Stockholm 1912 permit every nation affiliat-

ed to the Fédération Internationale de Football Association to send four teams to the competition, the Federation considers it most suitable that each nation should send only one", a wish which was complied with by all the nations competing, as the regulation allowing each nation to enter four teams had been made merely to permit the English, Irish, Scotch and Welsh Football Associations to enter separate teams for the Games if they so desired.

One of the most important questions to be settled was that of the grounds where the football-matches were to be held. According to the agreement entered into by the Swedish Football Association and the Swedish Olympic Committee, all the matches in the Olympic competition, with the exception, possibly, of the final, were to take place at the Råsunda athletic grounds, belonging to the Swedish Association and the Viking Football Club. It was seen, however, that it would be impossible to get all the matches in the competition and in the consolation-series finished in time, unless some other football-grounds could be used too, and so, in February 1912, it was found necessary to draw up a fresh agreement respecting the places where the matches were to be played, this new arrangement being made between the Swedish Olympic Committee, the Swedish Football Association, the Råsunda Athletic Grounds and the Djurgården Athletic Club, and placing at the disposal of the Football Committee a total of three grounds, viz., those at the Stadium, Råsunda and Traneberg.

But to put the athletic-grounds at Råsunda and Traneberg in first-class order it was found necessary to carry out some extensive reconstructions and improvements, in addition to erecting extra stands. For this purpose the Swedish Olympic Committee gave a sum of Kr. 33,600 (£ 1,860 : \$ 9,300) to the Football Committee, and the work was carried out under the superintendence of Mr. Charles Bunyan, a retired professional footballer who was then acting as trainer to the Swedish players for the Olympic Games. As a result of the work carried out, the grounds, Råsunda especially, were put into quite first-class order. As regards that at the Stadium, however, it turned out that the dimensions of this ground did not reach the minimum figures mentioned in the official invitation to participation in the football competitions, so that on the 27th June, 1912, it was considered advisable to request all the nations taking part in the competition in question to sign an agreement by which they bound themselves *not* to base any protest against a match in consequence of the minimum measures for the Olympic Football grounds being too small, but on the understanding that the grounds used would measure at least 105 metres x 65 metres, the dimensions of that at the Stadium.

Concerning the teams representing the various nations, it was determined that 22 reserves might be entered, in addition to the 11 men forming the team, a step that caused the German football authorities to inquire whether this proposed number of reserves ought not to be reduced to 11; the memorandum, however, did not influence the determination already come to by the Football Committee.

Referees.

The Football Committee which, in accordance with the agreement made with the Swedish Olympic Committee, had undertaken the task of procuring referees, was not forced to rely solely on our own Swedish football-referees but could also reckon on the assistance of a number of well-known men from abroad who, before the Games began, informed the Football Committee of their intention to be present at these competitions and, at the same time, expressed their willingness to assist the Football Committee as referees, if their help should be desired. The following persons acted as referees during the course of the competition: GROOTHOFF (Holland), HERCZOG (Hungary), H. MEISL (Austria), P. PHILIPS (Scotland), G. WAGSTAFFE-SIMMONS (England), H. G. WILLING (Holland), R. GELBORD and P. SJÖBLOM (Sweden). The linesmen, however, were exclusively Swedes.

The draws for the matches.

When the football-entries closed on the 29 May, the following nations had given notice of their participation in the competition: Austria, Belgium, Denmark, Finland, France, Germany, Great Britain, Holland, Hungary, Italy, Norway, Russia and Sweden, or 13 together. Of this number France and Belgium withdrew from the event.

The matches were played according to the International Cup Tie (elimination) method, by which the teams are drawn in couples. The teams whose lots bring them together play against each other, the winners of the first round having then to draw again in couples, and so on, until but two teams are left. The winner of the final receives the first prize ; the loser in the final, the second, while the two teams that were beaten in the semi-finals play each other for third prize. If, as in the case of the competition in 1912, there are 12 teams entered, only eight of these play in the first round, the other four having a "bye" and not playing before the second round begins; the four matches of this round giving the semi-finalists.

The consolation series, in which all the teams, with the exception of the semi-finalists, had the right to take part, were arranged in accordance with the same system.

Attention is called to the fact that, for the Olympic Football Competition, only nations and associations affiliated to the Fédération Internationale de Football Association were allowed to enter teams, as otherwise, the result would most certainly have been, that the Federation would have vetoed the holding of the competition. The Bohemian Football Association wrote, asking for permission to take part in the event, but, for the reason mentioned above, the Swedish Football Association was unable to be of service to Bohemia in the matter, and the entry was not accepted.

The draws for the Olympic Football Competition of 1912 took place at the Office of the National Association on the 18 June, 1911, the public being allowed to be present. All the nations taking part in the contest had been informed by circular that, if they

so wished, they could be represented at the drawing by their respective Consuls or any other authorized person. The result of the draws will be seen by the reports of the matches given below, and from the table of the series of matches appended to the report.

THE COMPETITIONS.

All the matches took place without any difficulties or complications arising, and the Swedish Olympic Football Committee succeeded in bringing the competition to a successful issue within the time allotted to it. We shall now proceed to give the following account of the various matches.

Principal series.

FIRST ROUND.

FINLAND v. ITALY. 3—2.

Traneberg, Saturday, 29 June, 11 a. m.

FINLAND: (forwards, from left) : A. Niska, J. Öhman, A. Nyysönen, B. Wiberg, A. Wickström; (half-backs): K. Lund, E. A. Soinio, K. Soinio; (backs) G. B. Löfgren, J. Holopainen ; (goal): N. Syrjäläinen.

ITALY: (forwards): D. Mariani, C. Sardi, F. Berardo, F. Bontadini, E. Zuffi; (half-backs): B. Leone, G. Milano, C. Demarchi; (backs): B. Devecchi, A. Binaschi; (goal) : P. Campelli.

Referee: H. Meisl (Austria).

The first football match of the Fifth Olympiad was favoured, like all the succeeding matches, with brilliant, hot, for football, most unsuitably warm weather. The sun was almost unbearably hot but, in spite of this, the game was played at high pressure the whole of the time.

Italy kicked off at 11 precisely and at first pressed their opponents hard, but before 2 minutes had elapsed, Wiberg (Finland) got the first goal of the match and the series. By degrees, play was transferred to the middle of the field until, by means of a beautiful attack, Italy came level after 10 minutes' play, Bontadini scoring for them.

Inspired by their success, the southerners now did all they knew, and a fresh goal by Sardi put them ahead and, immediately afterwards, Syrjäläinen was compelled to kneel in order to save a hard, low shot. Italy continued to press, but their better knowledge of the fine points of the game was more than counter-balanced by the fearless play and great speed of the Finlanders. Just before half-time the score was altered to 2—2 by E. A. Soinio, who played most brilliantly the whole of the time.

The beginning of the second half was distinguished by quite a crowd of free-kicks given against Finland ; Niska, especially, offending very frequently by placing himself off-side. Finland was soon compelled to play a man short, Wickström being pretty badly hurt in a collision.

The game was not without its exciting moments. Twice the Italian forwards had their opponents' goal at their mercy, but Campelli, too, was also kept very busy, the Finnish forwards putting in some hard, straight shots towards the close

of the second half. Comers were forced on both sides, but most of them were badly placed.

When time was called the game thus stood at 2 goals all, and an extra half hour had to be played. This gave the inherent tenacity of the Finnish-Swedish race an opportunity of showing what it could do, the Finns obtaining the lead after 10 minutes and retaining it to the end.

Finland had its best men at centre half-back and outside left, while the strength of the Italian team lay in the outside left — Mariani — the left back and the goal-keeper. All the Italian team seemed to be tired after the long journey from the south of Europe. If the men had been thoroughly rested they would have had a far greater chance of beating the Finlanders.

AUSTRIA v. GERMANY. 5—1.

Råsunda, Saturday, 29 June, 3 p. m.

AUSTRIA : (forwards, from the left): L. Neubauer, A. Müller, J. Studnicka, R. Merz, L. Hussak; (half-backs) : R. Cimera, K. Braunsteiner, J. Brandstetter; (backs): B. Graubard, L. Kurpiel; (goal) : O. Noll.

GERMANY: (forwards): J. Hirsch, E. Kipp, W. Worpitzky, A. Jäger, K. Wegele; (half-backs): H. Bosch, M. Breunig, G. Krogmann; (backs): E. Hollstein, H. Röp-nack; (goal): A. Weber.

Referee: H. G. Willing (Holland).

This match had drawn a pretty numerous public out to Råsunda and, as was to be expected, the spectators saw a hard, quick game. Little was seen of the finer points of football but still, the match was a very entertaining one.

Germany won the toss and, during the first half, played with the wind at its back. At first it seemed as if Austria was going to be beaten by Germany, whose forwards were working magnificently. In front of goal, however, the attack was altogether too nervous to be able to trouble Noll very seriously. Graubard very finely cleared a hard head-punt at goal by Worpitzky. The Austrian right wing Hussak and Merz, distinguished itself now and then by fine runs, but the forwards fell asleep with the ball when they came near the goal.

After 30 minutes, Germany was given the lead by Wegele who should have been given off-side. Immediately after, Noll was hard put to it to keep the ball out, and when half-time came, Germany still led by a goal.

During the pause, the Crown Prince Gustaf Adolf came out to shake hands with the men and then the game began again, but the character of the play was quite altered, the Austrian forwards beginning to get a good deal of life into their work. Their rushes came with lightning rapidity and with lots of power behind them, and during the course of one of these attacks the German goal-keeper was hurt pretty badly, though he managed to stay at his post. Ten minutes after play had re-started, however, he lost his first goal, the ball being put into the net by Studnicka. The ice was now broken for the Austrians, and a brilliant piece of combination by their forwards allowed Müller to give Austria the lead with a very hot shot. A brief pause had to be made in order to attend to the German goal-keeper, who was obliged to leave the ground. Worpitzky took his place, but the match was hopelessly lost for Germany and, with very brief intervals, Merz put 2 balls past the temporary goal-keeper. Germany's defeat was made complete when, just before the whistle was blown, Cimera found the net with a well-directed side-shot.

Austria thus won a well-deserved victory by 5 goals to 1. Their forwards were much superior in combination to those of their opponents, and were better served by their half-backs. The result would probably not have been much changed even if Germany had played the whole of the second half with a full team.

HOLLAND v. SWEDEN. 4—3.

The Stadium, Saturday, 29 June, 7 p.m.

HOLLAND: (forwards from left): N. J. Bouvy, J. Vos, C. H. ten Cate. H. F. de Groot, J. G. van Bredakolff; (half-backs): D. N. Lotsy, J. M. de Korver, N. de Wolf; (backs): C. W. Feith, E. Wijnveldt; (goal): M. J. Göbel.

SWEDEN: (forwards): K. Ansén, H. Ekroth, E. Börjesson, I. Svensson, H. Myrberg; (half-backs): K. Gustafsson, G. Sandberg, R. Wicksell; (backs): J. Lewin, E. Bergstrom; (goal): J. Borjesson.

Referee: G. Wagstaffe-Simmons (England).

About 14,000 persons had passed the turnstiles at the Stadium when the two teams turned out for this match. Never before had there been any football match in Sweden when such excitement prevailed and, in spite of the — from the Swedish point of view — unfortunate result, there were many that drew a breath of relief when the whistle blew at the end of a 2 hours' game, and everybody's nerves could once more settle down into their ordinary condition.

The first few minutes were entirely Holland's. The short rapid passing of their opponent's forwards quite took the Swedish half-backs by surprize and it was only bad luck and the Swedish backs that prevented Holland from obtaining a well-deserved lead.

But before long, Sweden recovered from its first surprise and then it became Göbel's turn to work at high pressure. A perfect hurricane of applause broke forth when Svensson, the best forward on the ground, gave Sweden the lead with a ball that grazed one of the Dutch backs before it flew into the net. A very hard shot by the same man a couple of minutes later found Göbel quite unprepared for its reception, but the ball struck the cross-bar.

Holland's forwards and half-backs now began to show a little better form, and it was clearly only a question of time ere the levelling goal would be made. Börjesson had to give away a corner in order to save a lightning shot off the little ten Cates's foot, and from the scrummage in front of the goal the ball found its way into the net. Ten Cate also had a "foot" in Holland's second goal, which was made just before half time, a nice piece of work between him and Vos resulting in the Dutch getting the lead from a shot by the latter player.

The second half was opened by Holland at high pressure, and the Swedish defence was soon hard put to it. J. Börjesson cleared a low shot from de Groot excellently, but, while he was still on the ground, Bouvy put the ball neatly past him into the net. With a lead of 2 goals Holland slackened speed a bit and this almost cost them the victory. A foul made against Svensson gave Sweden a penalty kick which was used to fullest advantage by E. Börjesson.

During the last fifteen minutes of the second half the Swedish forwards played magnificently. Svensson brought the score level with a shot that gave Göbel no chance at all. Then Börjesson dribbled the ball almost into the net, when he was tripped. He took the penalty kick himself, only to see that most phenomenal goal-keeper, Göbel, clear in some marvellous way, and then Sweden's last

chance went when, a minute later, Ansén, 2 metres from the goal, sent the ball on the wrong side of the post.

There is not much to be said about the extra half hour. Gustafsson made a present of a corner to Holland, which gave the Dutch the winning goal. During the remainder of the time the Dutch played with 4 half-backs, and in the last line of defence Göbel was always where he ought to be.

Although Sweden ought to have won the match if it had had a little luck and had taken advantage of all its opportunities, there is no doubt but that the better team — speaking of it as a whole — won. It was the better combination of the Dutch and the unselfish play of their men that gained them the match. Individually, Sweden had quite as good a side as Holland — with a couple of pretty bad exceptions. Svensson, E. Börjesson, Lewin and E. Bergström were the best of the Swedes, while Göbel, de Korver, Bouvy and van Bredakolff did most work for Holland.

SECOND ROUND.

FINLAND v. RUSSIA. 2—1.

Traneberg, Sunday, 30 June, 10 a. m.

FINLAND: (forwards, from left): A. Niska, J. Öhman, A. Nyssönen, B. Wiberg, A. Wickstrom ; (half-backs): V. Lietola, E. A. Soinio., K. Lund ; (backs): G. B. Löfgren, J. Holopainen ; (goal): M. Syrälänen.

RUSSIA: (forwards, from left): S. Filippoff, B. Gitareff, W. Boutosoff, A. Filippoff, M. Smimoff; (half-backs): N. Kynin, N. Chromoff, A. Akimow; (backs): W. Markoff, P. Sokoloff; (goal): L. Faworski.

Referee: P. Sjöblom (Sweden).

The early hour at which this match was played, and the interesting events which were to come off later on in the day, had the result that there were only a couple of hundred spectators present when the referee blew the whistle for the start.

It could be seen from the first that the two teams knew each other's "points" very well and, although they were the least bit stiff after the fatiguing match against Italy, the Finns played all the time as if they knew that they would win.

The result turned out as had been expected, although by a narrower majority than was generally looked for. No complaint could be made as to the pace of the play, which was very fast the whole of the time — the remarkable pace of the Russian players contributing not least to this — but there is not so much to say as regards the science and combination shown. A couple of first-class Swedish clubs could have shown better form.

From the very beginning Finland had the upper hand, and their forwards attacked again and again, but they shot very badly, so that half an hour passed before anything sensational occurred. At last, however, Finland's inside right sent in a beautiful ball which Faworski could not quite clear, and Nyssönen, who followed up, had no difficulty in getting the ball again and placing Finland ahead. After this success Finland played better, and managed to force several corners, but half time came without any additional goal.

When the second 45 minutes began, Russia seemed as if it meant to surprise its opponents. Filippoff, the outside left, a speedy and intelligent player, being specially prominent, and, if he had had better inside forwards, his well-placed centering must have led to quite a number of goals. As it was, Russia got only

one, made in the scrummage after a corner. The Finns now began to perceive their danger, and commenced to play a harder and more energetic game, and the Russians tiring towards the close of the match as a result of the severe pressure, it could be seen that Finland would be the victor. Just before time was called, Öhman made the winning goal after having dribbled through the Russian defence.

The players on both sides had still much to learn in the technics of the game. As was said above, the Russian forwards were very speedy, but they could do nothing in consequence of faulty combination. Filippoff, the outside left, and Sokoloff, the right back, were Russia's best men, while the strength of the Finland team lay in the stubborn defence offered by their backs.

GREAT BRITAIN V. HUNGARY. 7—0

The Stadium, Sunday, 30 June, 1,30 p. m.

GREAT BRITAIN: (forwards, from left): I. G. Sharpe, Gordon Hoare, H. Walden, Vivian Woodward, A. Berry; (half-backs): J. Dines, E. Hanney, H. C. Littlewort; (backs): A. E. Knight, T. C. Burn; (goal): R. G. Brebner.

HUNGARY: (forwards, from left): Borbás Gáspár, I. Schlosser, M. Pataki, A. Bodnár, B. Sebestyén; (half-backs): A. Vágo, J. Karoly, G. Biro; (backs): E. Payer, J. Rumbold; (goal): L. Domonkos.

Referee: Groothoff (Holland).

In spite of the tremendous heat that prevailed, this match was witnessed by about 7,000 persons, quite a crowd for a football match in Stockholm.

The heat seemed to suit the lively, powerfully built Hungarians and, at first, things looked a little dark for Great Britain, whose defence was really the only part of the team that had anything to do for the first quarter of an hour — though, at the same time, it seemed quite equal to any demands that might be made on it. If the Hungarian forwards had been a little cooler in front of goal, and had calculated their chances better, however, the result might easily have been altogether different to what it was. In any case, the ball went whizzing in every direction round Brebner's goal — in every direction but the right one, and after some fifteen minutes, Hungary was awarded a penalty kick for "hands". Bodnti made an excellent effort, but Brebner cleared grandly.

After this it was Great Britain's turn to attack, Walden giving his team the lead by an irresistible shot, made at a distance of 20 metres from the goal-mouth. Only a couple of minutes elapsed ere the same player came forward again, after a "hands" that Mr. Groothoff, the referee, could not possibly see, and the Hungarians, who unwisely enough, did not play on while waiting for the whistle, but stopped to appeal to the referee, let Walden put the ball into the net without hindrance.

Then succeeded a few uneasy minutes for Great Britain. Hanney, Gordon Hoare and Walden were all injured; the first so seriously that he was compelled to abstain from all further participation in the game, while the two others, fortunately for their side, were able to resume their places after a minute or two,

Gordon Hoare retired from the front line to act as half-back, but, in spite of the numerically weakened attack, Woodward and Co. managed to give the Hungarian defence a very warm time, and, three minutes before the first forty-five was ended, Great Britain's captain made a beautiful goal after a corner.

The second half was entirely Great Britain's, although they were playing only ten men, Sharpe having to do double work on the left wing. Scarcely four minutes had elapsed from the re-start, ere Walden got his forehead to a centre by Sharpe

and made a very pretty goal. The fifth in the series was obtained by Vivian Woodward, after threading through the Hungarian defence, while the sixth and seventh goals came from Walden's foot. The game was now a hopeless one as far as Hungary was concerned, but the Magyar team worked on indefatigably and kept the British defence fully employed, especially during the last few minutes, when the forwards of Great Britain's team, relying on the 7 goals' lead, took things pretty quietly.

Of course, the best team won, but there was by no means 7 goals' difference between the two elevens. If the Hungarians had but had the least bit of their opponents' finishing power, their forwards must have made several goals.

Great Britain won the game by its confident play in front of goal, its fine combination, and the individual skill of its members. Nothing but praise can be given to the team, both as a whole and individually. Domonkos, Rumbold, Karoly and Schlosser, of the Hungarians, deserve more than a word of praise.

DENMARK v. NORWAY. 7—0.

Råsundo, Sunday, 30 June, 4:30 p.m.

DENMARK: (forwards, from the left): V. Wolfhagen, H. J. Christoffersen, Anton Olsen, Sophus Nielsen, Axel Petersen; (half-backs): P. Berth, Niels Middelboe, I. L. Seidelin-Nielsen; (backs): H. Hansen, Ch. Buchwald; (goal): Sophus Hansen.

NORWAY: (forwards, from the left) : E. Maartmann, R. Maartmann, H. Enderrud, K. Krefting, H. Reinholt; (half-backs): G. Andersen, C. Herlofsen, H. Johansen; (backs): E. Baastad, P. Skou; (goal): I. Pedersen.

Referee: R. Gelbord (Sweden).

Denmark, certain of winning, did not place its best team in the field, but played reserves instead of Paul Nielsen, Oscar Nielsen and Castella.

The superiority of the Danes was evident from the very first moment, and the whole resolved itself more into an exhibition game than a match. Only 3 minutes had passed when Anton Olsen, the best shot at goal in all the Olympic football matches, found the way into the Norwegian net after a nice piece of work in combination with Sophus Nielsen. The Norwegians held their own very well for the first quarter of an hour, and the two Maartmanns gave Buchwald a few lively moments. They seldom came past the 18-yards line, however, Buchwald and Harald Hansen at back being in tip-top form. It would occupy too much space to attempt to describe the innumerable attacks on Pedersen's goal made by the smart Danish quintette. Middleboe, undoubtedly one of the foremost football-players in the world, obtained the second goal for Denmark by a hot shot that went just below the cross-bar, and the third was made very prettily by Wolfhagen a couple of minutes later.

The second forty-five did not differ essentially from the first half, unless by a falling-off in the keenness of the play. The result was a foregone conclusion, as both sides seemed to know. Christoffersen and Anton Olsen each made a couple of goals more, but the attention of the lookers-on was, for the most part, directed to the very scientific displays given every now and then by Niels Middelboe, Sophus Nielsen and Berth. Both Middelboe and Berth came very near to making a couple of extra points, after having corkscrewed the ball through the perfectly demoralized Norwegian defence, but in both instances Pedersen saved very resolutely. When the referee blew his whistle at the close of the 90 minutes, however, Denmark had won as it liked by 7 goals to none.

The Danish team is not to be blamed for not having done all it could. In spite of the presence of two or three reserve men in the eleven there was not a weak spot anywhere, and the game was finely generalised by the omni present Niels Middleboe.

Norway fell with honour, for its opponent was immensely superior, but it was weakly represented in places. The best of the Norwegians were the brothers Maartmann, Herlofson and Baastad.

HOLLAND v. AUSTRIA. 3—1.

Råsunda, Sunday, 30 June, 7 p. m.

HOLLAND : (forwards, from the left): Bouvy, Vos, ten Cate, de Groot, van Breda-kolff; (half-backs): Fortgens, Bontmy, Lotsy; (backs): Bouman, Wijneveldt; (goal): Göbel.

AUSTRIA : (forwards, from the left): Müller, Neubauer, Studnicka, Merz, Hussak; (halfbacks): Cimera, Braunsteiner, Brandstetter; (backs): Graubard Kurpiel; (goal): Noll.

Referee: P. Philips (Great Britain).

Austria played the same team that had beaten Germany, while Holland was obliged to bring in a couple of reserves, these, however, by no means weakening the team, but rather the reverse.

A hard, interesting game had been hoped for, and everything turned out according to expectations, the match proving one of the best played up to this point in the competition.

The Austrian forwards took charge of the ball for the first ten minutes, and ought to have made a goal before the Dutchmen warmed to their work and taken the measure of their opponents, but, when once they had done so, the roles were quite altered. The front five of the Hollanders soon found out how to trick the Austrian defence, which everywhere went in for hard, rushing tactics. The ball was sent from one to the other of the five Dutch forwards with wonderful precision, and, after a brief period of this brilliant play the team had gained a lead — a winning one — as it turned out, of three goals.

Bouvy, Holland's reliable and speedy outside left, had the merit of finding the net first, but off-side should have been given against him. Ere Austria had well recovered from the shock, the ball lay once more behind Noll for, directly the ball was started again, Vos got hold of it, dribbled it down to the goal-mouth and, as Noll could only partly divert the shot, ten Cate, following up, had no difficulty in putting the ball in from close quarters. Austria now began to play with all the energy of despair, but Göbel was in the same brilliant form that he had shown against Sweden, and he gathered in with the greatest confidence all the balls directed against the Dutch goal. Then Holland's forwards got possession of the ball again, and, 34 minutes after the beginning of the game, Vos put a lightning shot between Nell's legs, making the game 3—0 in favour of Holland. During the last few minutes of the first half, however, the Dutch defence was tried to its uttermost, and at last Alois Müller succeeded in putting in a ball that even Göbel had no possibility of clearing.

A few sentences will be enough to describe the last half of the game. Holland drew in its team around the home goal and played entirely on the defensive, and it became plain that the hard match against Sweden had made the men a little stiff and tired. In spite of continual pressure, however, the Austrian attack

could not get past Göbel who, during this portion of the game, simply surpassed himself. Towards the close play became a bit rough, while several decisions of the referee's did not seem to be very palatable to the supporters of the Austrians.

The best men amongst Holland's team were Göbel (in goal) the backs and the left wing of the forwards, while Braunsteiner, Studnicka and Müller played a good game for Austria.

* * *

SEMI=FINALS.

GREAT BRITAIN v. FINLAND. 4—0.

The Stadium, Tuesday, 2 July, 3 p.m.

ENGLAND: (forwards, from left): E. G. D. Wright, G. Hoare, H. Walden, Vivian Woodward, I. Sharpe; (half-backs): J. Dines, H. Stamper, H. C. Littlewort; (backs): A. E. Knight, T. C. Burn; (goal): K. G. Brebner.

FINLAND: (forwards, from left): A. Niska, J. Öhman, A. Nyssönen, B. Wiberg, R. Wickstrom; (half-backs): V. Lietola, E. A. Soinio, K. Lund; (backs): G. Löfgren, J. Holopainen; (goal): A. Syrjäläinen.

Referee: R. Gelbord (Sweden).

Finland, although a freak of Fortune had allowed it to reach the semi-final, had not, of course, the least chance of beating Great Britain, but the team in its game with its redoubtable opponent, played a far better game than in any of its other matches on Swedish soil. The forwards worked really well together; the half-backs gave very effective support to the attack, and the backs were of the "do or die" type.

Great Britain, which was giving a rest to a couple of its best men, played merely to win the match, and not to break any record by piling up goals. They very carefully avoided all collisions with the powerfully-built, tough Finlanders, but played a fine passing game, with plenty of science, so as to win with the least possible expenditure of energy.

The game, in consequence, did not present any features of very absorbing interest and a very few words will suffice to describe it in full. Sharpe, who, on this occasion, took Arthur Berry's place as Vivian Woodward's companion on the right wing, made a beginning immediately after the start by centering with a slow, falling ball towards the goal, which Holopainen, in his anxiety to clear, managed to put into the net. Everyone believed that goal would succeed goal in lighting succession when, scarcely 5 minutes later, Sharpe centered another ball which was converted by Walden, who was a bit livelier than the rest of the British forwards. Constantly on the defensive, the Finnish rear men began to be a little careless as to the methods they employed, but when at the end of a quarter of an hour a penalty kick was awarded to Great Britain, the leaders seem to consider that this was altogether too severe a punishment, and the ball was ostentatively put over the cross-bar. During the remainder of the first half the impression grew stronger and stronger that the British team was playing with its opponent as a cat plays with a mouse; beautiful and well combined attacks finishing with careless shots in every direction but the right one.

The second forty-five minutes was of the same character as the first, although, during the first portion of the time, the Finlanders enjoyed a very good deal of the play. Nyssönen lead a number of good attacks, but Brebner, who once or twice put his hand to the ball, never really had to do much behind men like

Burn and Knight. Then some more samples were given of delightful combinations between Great Britain's forward quintette and its half-backs, but no power was put into the shooting, although Syrjäläinen must be paid the compliment of the statement that he was in excellent form in goal. No less than 32 minutes elapsed ere Walden got a third goal for Great Britain from the scrummage a few metres in front of the Finnish net. Five minutes later when the cry of the spectators "We want more g-o-a-l-s" grew too strong, Vivian Woodward headed a fine goal as Great Britain's fourth and last.

DENMARK v. HOLLAND. 4—1.

The Stadium, Tuesday, 2 July, 7 p. m.

DENMARK: (forwards from left): V. Wolfhagen, Sophus Nielsen, Anton Olsen, Poul Nielsen, Oscar Nielsen; (half-backs): P. Berth, E. Jörgensen, Ch. Buchwald; (backs): H. Hansen, Niels Middelboe; (goal): Sophus Hansen.

HOLLAND: (forwards from left): N. J. Bouvy, J. Vos, C. H. ten Cate, H. F. de Groot, J. G. van Bredakolff; (half-backs): D. N. Lotsy, J. V. Bontmy, G. Fortgens; (backs): P. Bouman, D. Wijnveldt; (goal): M. J. Göbel.

Referee: Herczog (Hungary).

If the semi-final, Great Britain v. Finland, had been almost featureless, this match was a beautiful and most interesting one. It may be said, without any exaggeration, that it was the finest game ever played in this country, and it was the play of the Danish team that made it so.

It will be easy to imagine Denmark's superiority when we say that, during the whole of the match, the Danish goal was not even once seriously threatened. The single goal that Holland obtained was simply and solely the result of a misunderstanding between Sophus and Harald Hansen, while Göbel, the brilliant Dutch goal-keeper, was the man that prevented Denmark from more emphatically accentuating its superiority.

Denmark played the game at high pressure from the very first moment. The ball flew from man to man with an almost unnatural precision, and, finely lead by Anton Olsen, the Danish forwards commenced to let the ball whizz in towards the Dutch goal, where Göbel won round after round of thundering applause when he cleared apparently impossible shots. His backs being close in upon him they hid from view, however a long, high ball which was sent in by Jörgensen from the 18 yards line — and Denmark got the lead. The Dutch team strained every nerve and sinew, but all their attacks broke against the stubborn Danish defence which, at the same time, fed its own forwards most brilliantly. After 25 minutes Anton Olsen received the ball from Poul Nielsen, succeeded in avoiding all Bontmy's well-meant attentions and in an instant had found his way through the crowd of defenders. Göbel made a vain attempt to clear the hard and well-directed shot that followed, but the ball flew right into the comer of the net.

The Danes now had their blood up and, during the remainder of the half, they played ideal football. Niels Middelboe dribbled from his position as back, right through the Dutch team, but the ball struck the cross-bar; shots from Jörgensen, Poul and Sophus Nielsen either struck the posts, or were cleared in a masterly fashion by Göbel, but admirably as the latter played he could not prevent Poul Nielsen, after a comer, from getting a third goal for Denmark.

During the second forty-five minutes, Denmark relaxed the pressure somewhat, and began to rely on its defence and a three goals' lead. Bouvy and ten Cate changed

places, but Jorgensen shadowed the speedy Bouvy quite as effectively as Buchwald and Middelboe had done at an earlier period of the game. In a collision with Bouman, Poul Nielsen sprained his knee and had to be carried off the field, but the accident made no noticeable difference in the play of the Danes, Oscar Nielsen surpassing himself now that he was left alone on the right wing. But then Holland managed to get a goal. Van Bredakolff succeeded in getting a loose ball towards the Danish home-quarters; Sophus Hansen rushed forward to take the ball but, at the same instant, Harald Hansen quite unexpectedly hindered him, and put the ball into their own goal into the bargain.

Denmark knew the right kind of cure for this accident. As soon as the ball was kicked off it went to Wolfhagen, who tricked it past Fortgen and Wijnveldt and then sent it with a hard pass at the height of the hips across to Anton Olsen who, from a distance of 20 metres made the loveliest goal of the Olympic football competition. The ball went with the speed of a cannon-ball and, wisely enough, Göbel made no attempt to clear it. Thunders of applause were still echoing round the Stadium when the game was once more started, but then came "Time" with Denmark a well-deserving winner by 4 goals to 1.

The Danes played an ideal game and no weak spot could be found in the team. The soul of the eleven was Niels Middelboe, but all the men deserved praise.

Holland played as well as Denmark allowed them to do. Göbel, in goal, was head and shoulders above the other players of the team, and it was entirely due to him that the defeat of the Dutch was kept within reasonable limits.

FINAL.

GREAT BRITAIN v. DENMARK. 4—2.

The Stadium, Thursday, 4 July, 7 p. m.

GREAT BRITAIN: (forwards, from left): I. Sharpe, G. Hoare, H. Walden, Vivian Woodward, A. Berry; (half-backs): J. Dines, H. C. Littlewort, D. Mc Whirter; (backs): A. E. Knight, T. C. Burn; (goal): R. G. Brebner.

DENMARK: (forwards, from left): V. Wolfhagen, Sophus Nielsen, Anton Olsen, A. Thufvason, Oscar Nielsen; (half-backs): P. Berth, E. F. Jørgensen, Ch. Buchwald; (backs): Harald Hansen, Niels Middelboe; (goal): Sophus Hansen.

Referee: Groothoff (Holland).

The football final in the competition proper had been awaited with the greatest interest, and close on 25,000 persons had passed the many turnstiles of the Stadium when the teams of Great Britain and Denmark met for the final struggle.

Great Britain was able to place its best eleven on the ground, but the chances of its opponent were lessened by the Danes being obliged to play reserves instead of the well-known Danish back, Castella, and Poul Nielsen, Thufvason not being anything like equal to Poul Nielsen in the front line of attack. Against Holland the Danish forwards had played like one man, no one making a single fault, but now the combination often went to pieces in Thufvason's section.

Denmark kicked off, but Great Britain was the first to make an attack by means of Berry. It was evident that the teams were taking each other's measure and, for the first ten minutes, the ball oscillated somewhat nervously between Hansen's and Brebner's goals. When ten minutes had passed, however, the British line of forwards steadied itself, and a well-executed centre attack was completed by Walden's making the first goal of the match.

Great Britain continued to press, but Middelboe and the rest of the Danish defence left nothing to chance, attacking with vigour and assurance, while, at the same time it gave good support to its own forwards. Anton Olsen gave Brebner a whizzing shot which the British goal-keeper was obliged to tip over the bar, but, from the corner that followed, Jørgensen only put the ball hard against the timber.

Great Britain's second goal was a remarkable present from Harald Hansen, who stopped the ball a long way out on the line and directly afterwards, without the least reason in the world, sent it in towards his own goal. Quite naturally, two of the English forwards were unmarked, and Gordon Hoare put the ball past Sophus Hansen, who was absolutely helpless.

But Denmark did not lose courage. The half-backs began to play a harder game and, from a pass by Buchwald, Anton Olsen drove a lightning ball past Brebner from a distance of about 25 metres. This goal poured oil on the Danish fire, and each moment it looked as if the teams would be brought level when, suddenly, Buchwald after having headed a ball, fell and sprained his hand badly. He had to be helped from the field, and Sophus Nielsen, the brilliant strategist of the Danish five, was obliged to retire to half-back. As a natural consequence the Danish combination went to pieces in places, and the British team knew very well how to make use of their opportunities. Before three minutes more had elapsed they had made the figures 4-1, the result of most brilliant play on the part of the forwards. Gordon Hoare made the first of these two fresh goals, a hard and accurate header from Berry's centering, and Berry himself secured the fourth after dribbling past Harald Hansen. Half time came with this result unaltered.

During the second half the Danes continued to play with ten men, and altered the arrangement of their team, Jørgensen and Niels Middelboe changing places. The first part of the second forty-five minutes resolved itself into a long duel between Great Britain's forwards and the Danish defence, the latter being quite equal, however, to dealing with their formidable opponents. On the other hand, the four Danish forwards could make no very great impression on the British defence, the latter, too, playing an exceedingly hard game. But then Middelboe changed places once more, this time with Anton Olsen, and the ball began to whiz about Brebner's goal again. Anton Olsen played excellently at centre halfback — the Danes seemed to be able to play equally well in any position — and from his foot came the only goal made during the second half, once more a long low ball a couple of inches above the ground.

This goal made the British team uneasy. Woodward awakened his comrades' spirits, which had shown the least signs in the world of drooping, and then Denmark could consider itself fortunate that it had a man of Sophus Hansen's high class in front of goal. Many were the shots he saved, but still more numerous were those that whizzed beside and behind the posts. Gordon Hoare, especially, had exceedingly bad luck with a magnificent shot that flew about 18 inches above the ground, and struck the outer corner of the side-post when Hansen was at the other side of the goal.

Great Britain won a well deserved victory, and would probably have come out on top, even if Denmark had been able to play 11 men to the close. The result might have been doubtful, however. Every man in the British team did his duty, and did it to the utmost of his power. The backs allowed no one to come to close quarters.

Denmark had two weak men in Harald Hansen and Thufvason, but it fell with honour and after having been treated by Fortune with more than on average share of ill-will. Its semi-final against Holland was a far pleasanter match to look at, as, in the final, nervousness was too much in evidence in the Danish team.

MATCH FOR THE THIRD PRIZE.

HOLLAND v. FINLAND. 9—0

Råsunda, Thursday, 4 July, 3 p. m.

HOLLAND: (forwards from left): Bouvy, Vos, van der Sluis, de Groot, van Breda-kolff ; (half-backs) : Bontmy, Lotsy, de Wolff; (backs): Feith, Wijnaveldt ; (goal): Göbel.

FINLAND: (forwards from left): Niska, Nyyssönen, Öhman, Wiberg, Tanner; (half-backs) : Lietola, Soinio, Lund ; (backs): Löfgren, Holopainen ; (goal): Syrjäläinen, *Referee*: P. Sjöblom (Sweden).

There was a very small attendance, for the public had evidently made up its mind beforehand as to the probable result of this match, everybody expecting Holland to win, a presumption that was fulfilled to the least tittle, the Dutch team winning with greater ease even, than had perhaps been expected.

The Finlanders pressed at the beginning, still, without giving Göbel very much to do. The great heat prevailing soon caused the pace to slacken somewhat, and this gave Holland a chance to play the game it liked, but 30 minutes passed before the first goal came, made after a corner, and, when once the ice was broken, matters went far better for Holland. The Dutch left wing gave the ball to de Groot as he was excellently placed for the shot, and he fully responded to the confidence placed in him. The Finlanders worked in the sweat of their brows but, after a very short interval, the ball once more found its way into their net, put there by Vos, and immediately before half-time was called, it paid another visit, after a corner.

The Dutch had thus a start of 4 goals and could have felt quite assured of the third prize, but they monopolized the play during the second half too. Van der Sluis, the new centre, was very attentive to the ball and managed to make two goals, in much about the same manner each time. Syrjäläinen muffed the

ball on each occasion, and the Dutchman was altogether too quick for him. Finland's defence was hard put to it the whole of the time and, towards the close, the only question was as the number of goals the Dutch forwards would be able to make. Vos (2) and de Groot succeeded in bringing the total up to 9, and it was only the referee's whistle, proclaiming the finish of the game, that saved Syrjäläinen's goal from further visits.

Finland played a great deal worse than it had done against Great Britain, and no one in the Dutch team had to exert himself very much in order to gain a well-deserved third prize for his country.

Consolation Series.

FIRST ROUND.

AUSTRIA v. NORWAY. 1—0

Traneberg, Monday, 1 July, 11 a.m.

As had been expected, Austria had to bring up its reserves for this match to fill places in goal, the left and right inner forwards, and the centre half-back positions, while Norway had changed only one man, the left half-back. Under ordinary circumstances, Norway would have been an easy prey for Austria, but, as it was, the difference was the least possible, 1 goal.

The attack varied rapidly during the first quarter. of an hour but then came the goal which was to be the only one made during the match and, therefore, the deciding one, the Austrian inner left finding the corner of the net with a chance ball. Norway had quite as much of the game in the open as the Austrians, but the work of the latter in front of goal made their attack considerably more dangerous. They had no lack of opportunities to increase their lead, but every chance was thrown away, or else Pedersen managed to save the Norwegian goal. The first 20 minutes of the last half were entirely Austria's, but after one of the Austrian forwards had been carried off the field injured, things took a fresh turn, and if the Norwegians had kicked straighter they would certainly have equalized. They, too, soon lost one of their attacking force, Reinholt, who hurt his foot. The game now went a bit lamely, and time was called with the figures unaltered.

Austria showed superior skill, and deserved to win by a greater majority. In this match, however, Norway played better than it had done against Denmark.

GERMANY v. RUSSIA. 16—0.

Råsunda, Monday, 1 July, 5 p.m.

For this match, Germany put into the field an almost entirely new team which was, perhaps, the least bit better than the one that had lost to Austria. Consideration must, of course, be paid to the fact that Russia was not able to offer any serious resistance, as the speedy, ready-witted German forwards pierced the Russian defence as easily as a sail-maker's needle does the canvas.

A description of the match would become a somewhat tedious enumeration of the goals made by Germany, which numbered no less than 8 during each period. The Russian defence was continually strengthened by the forwards, who seldom or never received the ball from their half-backs, and who therefore had to do what they could themselves, to prepare the way for an attack.

Fuchs, Förderer and Oberle made the goals for their team, turn and turn about.



FOOTBALL. HOLLAND v. SWEDEN. The Dutch goalkeeper saving.



FOOTBALL. GREAT BRITAIN (white jerseys) v. HUNGARY.



FOOTBALL. FINLAND (dark jerseys) v. ITALY.

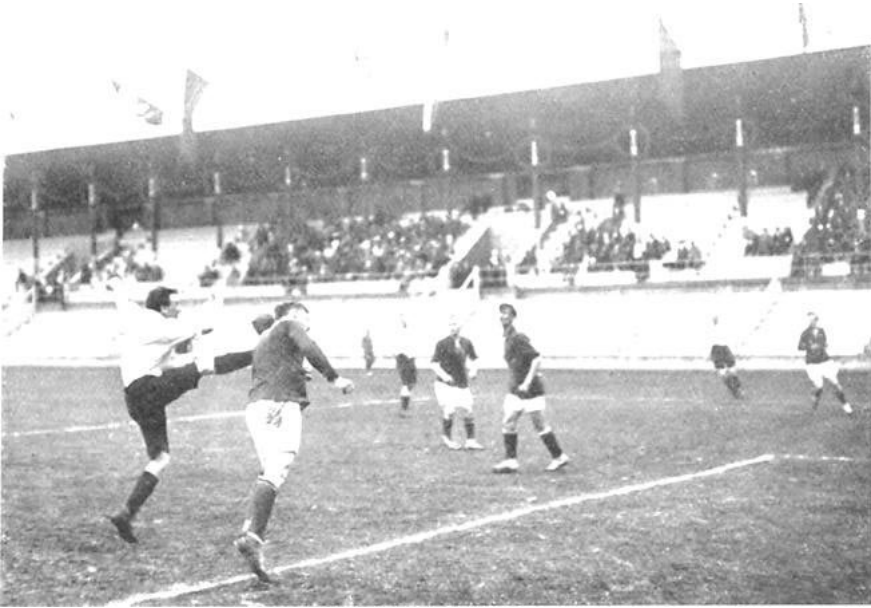

FOOTBALL. GREAT BRITAIN (white jerseys) v. FINLAND.



FOOTBALL. AUSTRIA (white jerseys) v. GERMANY.



DENMARK'S FOOTBALL TEAM.



FINLAND'S FOOTBALL TEAM.

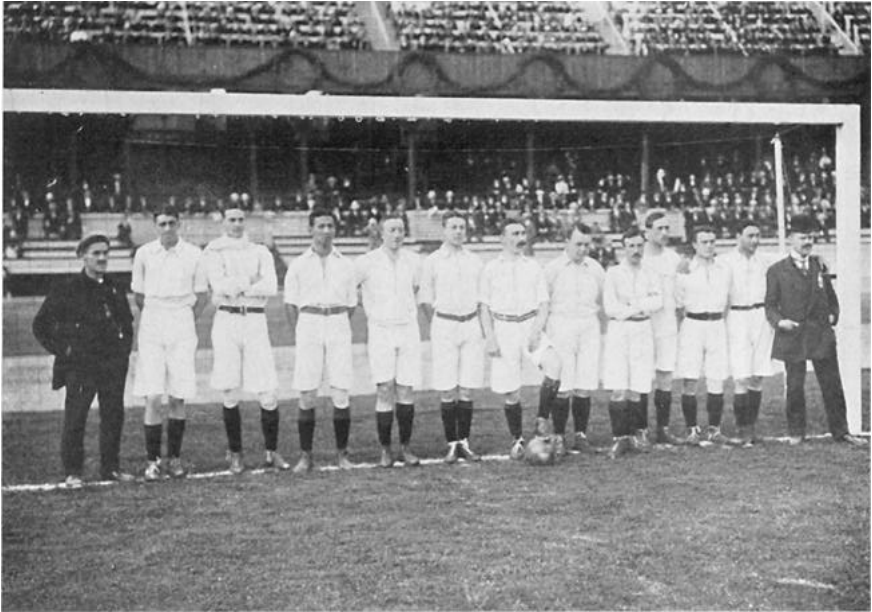

HOLLAND'S FOOTBALL TEAM.



ITALY'S FOOTBALL TEAM.



NORWAY'S FOOTBALL TEAM.



RUSSIA'S FOOTBALL TEAM.

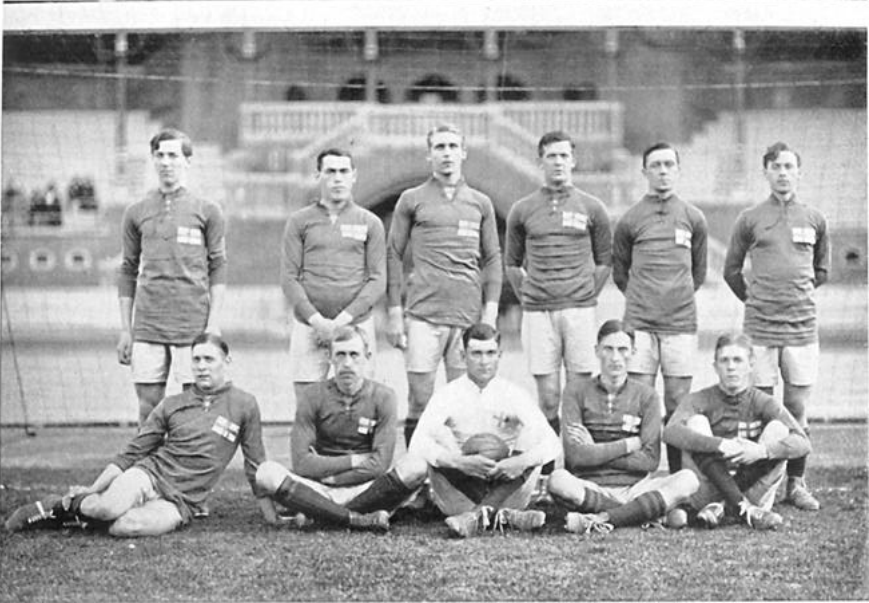

SWEDEN'S FOOTBALL TEAM.



GERMANY'S FOOTBALL TEAM.



HUNGARY'S FOOTBALL TEAM.



AUSTRIA'S FOOTBALL TEAM.

Had they been opposed by a first class goal-keeper, however, the number of goals made against the Russians would have been reduced, as many balls which found the net were shot from at distance of 20 or 25 metres.

ITALY v. SWEDEN. 1—0

Råsunda, Monday, 1 July, 7 p.m.

Italy relied on the same team that had been so narrowly beaten by Finland, while Sweden had new men on the inside left, at centre half-back and at left back, viz. Dahlström (from Eskilstuna), Frykman and Törnqvist. Everyone had prophesied an easy victory for Sweden, and the team evidently suffered from the fault of making light of its opponents.

The Swedes began the game as if it was merely a question of playing with the other team, but they soon had their eyes opened in a very unpleasant way. Italy knew that it was matched against a team which, on paper, was miles superior to its own and so it played for all it was worth, and the Swedish defence almost at once found itself in difficulties. Not more than a couple of minutes had elapsed ere a ball from the Italian centre found its way into the Swedish net, but Mr. Wiling, the referee, disallowed the goal on account of "hands". The Swedish forwards played very limply, and could not keep the ball going, while, after about a quarter of an hour's play the Italian outside right passed very nicely to the centre, who transferred the ball without any difficulty to the net, this time in a perfectly legitimate manner. For a short time the Swedes played up a bit, but Italy soon began to press again and forced a series of corners. Wicksell was injured seriously in the back and was obliged to leave the field but, just before half time, Börjesson, the Swedish centre forward, almost succeeded in equalizing with a hard shot.

During the second half there was a change in the game. Fatigued by their exertions during the first 45 minutes, the Italians kept almost entirely on the defensive, while the Swedes did everything in their power to regain the ground they had lost. But, apparently as a punishment for their laziness during the first part of the game, Fortune turned its back on them entirely, and although the ball was as good as always within the penalty sphere in front of the Italian goal, it was impossible for the Swedes to equalize. Börjesson, Dahlström and Svensson sent in shot after shot, but the Italian goal-keeper saved brilliantly, and when he was unable to reach the ball, the Swedes only managed to hit the cross-bar or the side posts. All their efforts were in vain and they had to leave the field, after having had by far the best of the last half of the game, beaten by 1-0.

Italy won, thanks to the unfailing energy of the team, and to the good fortune that attended them. The best men on their side were the outside left, the centre half-back, the backs and the goal-keeper.

The Swedes lost on account of their unaccountable indifference during the first half. Only the right back, Erik Hergström, and the two outside half-backs, Wicksell and Gustafsson, maintained their reputations, the play of the other members of the team being considerably below par.

SEMI-FINALS.

HUNGARY v. GERMANY. 3—1.

Råsunda, Wednesday, 3 July, 3 p.m.

There were only a couple of hundred spectators of this match which, however, was one of great interest the whole of the time, and well worth watching.

Hungary lost the toss but, during the first few minutes, was too aggressive to suit the German defence, and their inside left made a lovely goal, only eight minutes after the start. By degrees, however, Germany began to get going, and some good combination by their forwards gave the Hungarian half-backs and backs plenty to do. The fine play of the latter, together with the trick the Germans had of continually being off-side, saved a good many dangerous situations, and when Germany began to slacken pace a little, Hungary was quite ready to renew the attack. But the same fault the team had exhibited in its play against Great Britain once more became evident — its incapacity to do any calm, well-calculated work in front of goal being as great as ever. Numberless fine opportunities of scoring were thrown away, but just before half time, the inside left again made a beautiful goal.

It was clear that the lead Hungary had thus obtained was quite sufficient to give them the victory, but Germany worked with undiminished vigour, and, during the second half, had something more than its own share of the game. Now, as in the first half, the Hungarian forwards were unable to make any use of several fine opportunities, and Germany was the first to score during the second forty-five, though the goal should have been disallowed, as it was a clear case of off-side. After half an hour, however, came Hungary's third goal, from a corner, and this settled their opponents' fate.

Hungary well deserved its victory, but it ought to have had at least twice the number of goals it won by. The German goal-keeper had a very successful day.

AUSTRIA v. ITALY. 5—1.

The Stadium, Wednesday 3 July, 7 p.m.

This semi-final of the "Consolation-series" was very poorly supported too, but in contrast with the one just described, the play was hardly up to the level of that shown in the preceding matches. During the first forty-five minutes especially, it was often a matter of very great difficulty indeed, to follow the play with any interest.

Austria had the upper hand the whole of the time, but the unceremonious play of the Italian defence seemed, at first, to make the, physically speaking, weaker Austrian forwards quite dumbfounded, time after time, when these latter were in the neighbourhood of the Italian goal. After 30 minutes' monotonous play, however, Austria at length got its first goal, scored by Alois Müller, the inside right. The next minute, Berardo, the Italian centre forward, neglected a beautiful opportunity of equalizing, and play was at once transferred to the Italian quarters, where Campelli's charge, five minutes before half time, was disturbed by Grundwald.

The second forty-five brought several more goals and thus became somewhat pleasanter to look at. The Austrian forwards at length managed to find their right game and, four minutes after play recommenced, Hussak ran in with the ball towards the Italian goal, Austria's success on this occasion being repeated immediately afterwards, in consequence of a bad blunder by their opponents' defence. By means of a last despairing rally, the Italians succeeded in penetrating the Austrian lines successfully, but this goal was immediately afterwards nullified by one for the other side just before the whistle sounded, and the Austrians left the field victorious by 5 goals to 1.

The Italians could not at all manage to repeat the fine and energetic play they

had shown against Sweden. During the second half, the Austrian forwards did the best piece of work of all of their performances during the Olympic competitions, and it was only Campelli's fine show in goal that kept the result of the play within reasonable proportions.

FINAL.

HUNGARY v. AUSTRIA. 3 — 0

Råsunda, Friday 5 July, 7 p. m.

HUNGARY: (forwards, from left): Borbás Caspár, I Schlosser, M. Pataki, A Bodnár, B. Sebestyén ; (half-backs): B. Zoltan, A. Vago, G. Biró; (backs): E. Payer J. Rumbold ; (goal): L. Domonkos.

AUSTRIA : (forwards, from left) : L. Grundwald, L. Neubauer, R. Merz, A. Müller, L. Hussak ; (half-backs): J. Brandstetter, K. Braunsteiner, R. Cimera ; (backs): B. Graubard, L. Kurpiel ; (goal): J. Kaltenbrunner.

Referee : H. G. Willing (Holland).

As was to be expected, national feeling played no unimportant part in this match, and Mr. Willing's rôle as — peacemaker — was anything but a sinecure. A rougher game has never been played in Sweden, and it was only the fear of causing the scandal to assume still greater proportions that prevented the referee from ordering several of the players of both sides off the field. The whistle was heard incessantly for free kicks, and on one occasion Mr. Willing was obliged to call the teams together and admonish them to play a more gentlemanly game.

Very naturally, the game suffered greatly in consequence of these continual fouls and interruptions, but in spite of this, the match was a most interesting one. The big, powerfully-built and speedy Hungarians played the whole of the time as if they were in an ecstasy, and, at times, the pace was quite abnormal. The brilliant Hungarian outside forwards centered towards goal time after time, but the very agile Kaltenbrunner cleared the hard shots from Schlosser and Bodnár superbly.

It took no less than 30 minutes' play to produce the first goal, this coming off Schlosser's foot, the Hungarian reaching the ball the fraction of a second before Kaltenbrunner, and poking it into the net. Half time came with the score 1-0 in favour of Hungary.

The second half saw the culmination of the foul play which had been visible during the first half, and soon a short pause had to be made in order to allow the hot blood of the players to cool a little. After this pause came the best play of the match. The Austrian forwards combined better than those of Hungary, but the latter's backs, Rumbold especially, played brilliantly, and Domonkos was seldom obliged to put his hand to the ball. After 27 minutes, Hungary's lead was increased by Pataki, who took a pass to centre by Borbás Gaspár and easily placed it into the net. Then Hungary began to force the game, sending the ball from wing to wing, with the result that Bodnár, after a brilliant individual attack, gave Hungary its third and finest goal.

The Hungarians thus became the well-deserving winners of the consolation series. Their best men for the day were the left wing, Gaspár and Schlosser, and the right back, Rumbold.

Austria had more of the game than the goal-total shows. Kaltenbrunner, Braunsteiner and Merz playing a superb game.

Results of the Football Competitions of the Fifth Olympiad.

Principal competition.

		G. Britain 7	}	G. Britain 4	}	Great Britain.
		Hungary 0	}			
Finland 3	}	Finland 2	}	Finland 0		
Italy 2		Russia 1				
		Denmark 7	}	Denmark 4		
		Norway 0	}			
Holland 4	}	Holland 3	}	Denmark 2		
Sweden 3		Holland 1				
Austria 5	}	Austria 0	}			
Germany 1						
Match for third prize:		Holland 9	}	Holland.		
		Finland 0	}			

Consolation series.

Germany 16	}	Hungary 3	}	Hungary 3	}	Hungary.
Russia 0		Germany 1				
Austria 1	}	Austria 5	}	Austria 0		
Norway 0		Italy 1				
Italy 1	}	Sweden 0	}			
Sweden 0						

The 1:st prize in the principal competition thus fell to Great Britain which received the Challenge Cup presented by the English Football Association, with a diploma and a silver-gilt Olympic Medal to each man of the team;

2:nd prize, Denmark, Olympic silver medal to each member of the team, and

3:rd prize, Holland, Olympic bronze medal to each member of the team.

Finland, which reached the semi-final, was awarded the silver medal of the Swedish Football Association for each of its players.

The players received their prizes from the hands of His Majesty, The King, immediately after the conclusion of the final in the Stadium.

In the *consolation series*, the prizes were given away by Dir. Kernerup after the close of the final between Hungary and Austria at Råsunda, each member of the Hungarian team receiving the silver medal of the Swedish Football Association, and the Austrians, the bronze medal of the same Union.

All the referees and linesmen taking part in the matches of the two series, received a little memorial of the Games in the form of a silver cup.

SOME GENERAL REFLECTIONS AND WISHES.

The Football Competitions of the Fifth Olympiad were thus brought to a successful close and, when we make a general survey, we find that the international order of merit, as regards the nations engaged, has remained unchanged since the matches in London, 1908, with Great Britain, Denmark and Holland as Nos 1, 2 and 3 respectively.

There is no doubt but that this placing represents the merits of the rival teams, even if Hungary, had it been matched against Holland, might have been successful against its Dutch rivals. The result, 7—0, of Great Britain's match v. Hungary is most misleading, as the British team itself was the first to acknowledge. Hungary had quite as much of the game as Great Britain, but it was the excellent work of the British forwards in front of their opponent's goal that gave them their overwhelming victory.

The undeniable superiority of Great Britain over the other nations taking part in the competition lay, not only in better developed technical play, both individually and collectively, but also in the cool, well-calculated "finish" in front of goal. With a really representative team, Great Britain's claim to the Olympic Football Cup can never be really challenged by any other football-playing nation, before the work of the opposing teams has become immensely better than it is at present.

The Danes came nearest to the British, and they really are next to them as regards power of combination and all-round skill. It is a debatable question whether Denmark would not have made a better show against Great Britain in the final if Buchwald had not been injured, but, at most, this accident did not mean more than the loss of one point to Denmark. It must be pointed out, that both the goals gained by the Danish team were long shots, so that no one player of the English defence could really be made responsible for them; the points were, consequently, the fruits of superb individual ability in making long shots at goal.

As a whole, the play shown in the football competition was quite high class, even if the work of some of the teams, as, for example, the Russian and Italian, and the Swedish when playing against Italy, was not on a level with that of the other nations. It was specially interesting to make a study of the various styles of play, which differed very greatly. Both Denmark and Holland had fairly confirmed British style, both these teams relying more on science, combination and agility than on speed and hard rushes, especially as regards the play of the forwards. The opposite was the case with Germany, Austria, Hungary (in the case of the latter, less, perhaps, than, as regards the two preceding nations), Finland etc. Their game was tremendously speedy and hard, which was successful as long as the ball

was being carried onwards towards the goal, but it became a great hindrance when any accurate work had to be done immediately in front of the posts. These latter teams threw away innumerable chances by what must really be termed slovenly shooting, added to too great eagerness in front of goal, while it may be questioned whether altogether too much bodily strength was not expended quite unnecessarily, and whether a little more brain-work would not have given far better results. The Swedish team can scarcely be said to have done its duty very successfully in the matches, but there is nothing but praise to be given to its style of play, and Sweden has probably quite as good prospects of development as any other nation. The Swedish forwards played a well-balanced combination of long and short passing, of open, hard play, and fancy work.

It is a pleasure to be able to state that, during the matches, there was no rough play worth mentioning, with the exception, perhaps, of during the game between Austria and Hungary in the consolation series. But in this case, of course, scarcely anything else was to be expected. Hard knocks were given and taken without a word, and there were one or two little accidents, but there is nothing to be said about these, for football could not be what it is, unless physical advantages were allowed to *be* advantages.

The three grounds at the Stadium, Råsunda and Traneberg were in excellent condition the whole of the time, and possessed every convenience for the players as regards dressing-rooms, etc.; the tramway communications to the last two places (which lie outside Stockholm), were such as could satisfy all reasonable requirements, while everyone that paid to see the match could be certain of being able to get a good view of the play, whether he occupied a place on the grand stands, or was one of the standing public. The matches were so arranged that it was possible to attend everyone of them without any great exertion, and the teams were granted so much breathing-space between the matches as the short period allowed for the whole of the competition permitted, while the players were given the fullest information respecting all those matters they had to be acquainted with, in connection with the various matches.

One thing should be pointed out, however, as being exceedingly desirable for future meetings of this kind, viz., that, if possible, the matches should never be played at hours when the sun can be expected to be hottest. Of course it is necessary, in order to make the Olympic Games a whole, for the football competitions to take place simultaneously with the other event in athletics, i. e., in the middle of the summer, but it would not, probably, be a matter of any very great difficulty to have the football matches at a future Olympiad played at 6 p. m. at the very earliest. A football player cannot do

his best when working in the midst of blazing sunshine, and the spectators, too, can be got to attend the matches in far greater numbers if the play takes place at a normal temperature, after the worst heat of the day is over, apart from the fact, that they will be certain to see a far better game in the evening than in the middle of the day.

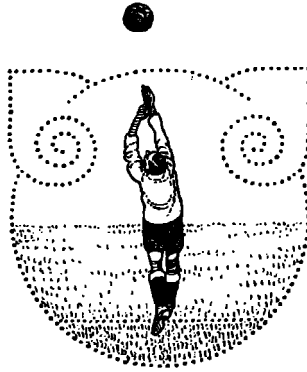

After a number of alterations — caused by representations made from various quarters — had been made in the earliest proposals, the final programme for gymnastics was drawn up as follows.

PROGRAMME FOR GYMNASTICS.

The Stadium, Saturday, 6 July—Monday, 15 July, 1912.

Max. number of competitors from each nation: in the individual competition 6, in each of the team competitions: 1 team.

I. Team competition with exercises according to the Swedish system.

Teams of not less than 16 nor more than 40.

Time limit, 45 minutes.

II. Team competition with exercises according to any system except the Swedish.

Teams of not less than 16 nor more than 40

Time limit, 45 minutes.

III. Individual competition with exercises on horizontal bar, parallel bars, rings and pommelled horses.

IV. Displays.

One team of men and one team of women from each nation.

Time limit, 45 minutes.

The chief diversity of opinion in the Committee was caused by the method to be adopted for the division of the competitors into groups for the team competitions, and the time to be occupied by each group, and as the fixing of a time-limit of 45 minutes for each team, especially, occasioned much discussion, some account ought to be given here of the development of the question.

The Committee for Gymnastics, after consulting the Swedish Olympic Committee, originally fixed the limit at 45 minutes. At the Meeting of the International Olympic Committee at Buda-Pesth, a proposal was made on the part of Denmark that the time should be extended to one hour, but Colonel Balck (Sweden) informed the Meeting that this was impossible. The Swedish Olympic Committee, during the summer of 1911, asked the Committee for Gymnastics, however, whether it had any objection to the proposed extension of the time. The Committee in question recommended the measure, but then the Swedish Olympic Committee found it could not adopt it.

In December, 1911, the Committee for Gymnastics renewed its application for an extension of the time to 60 minutes, but with the same result.

For various motives, Germany, among other countries, determined not to take part in the Gymnastic Competitions, one reason given being that the time proposed — 45 minutes — was too short. To do away with this objection, the Swedish Olympic Committee, in the spring of 1912, determined that the time-limit should be extended to one hour for team competitions, but the step did not have the desired result as far as Germany was concerned.

GENERAL PREPARATIONS.

Apparatus.

No suitable premises of sufficient size for the gymnastic competitions and displays being available, arrangements had to be made to carry them out in the Stadium.

The Committee for Gymnastics, therefore, drew up plans for fixed gymnastic apparatus, so constructed that it could be erected in the Stadium arena. This apparatus was made by E. G. Ekstrand, Gymnastic Apparatus Maker, Stockholm.

Concrete sockets were sunk in the ground, intended to receive the supports.

As can be seen by the drawings, there were in this apparatus 20

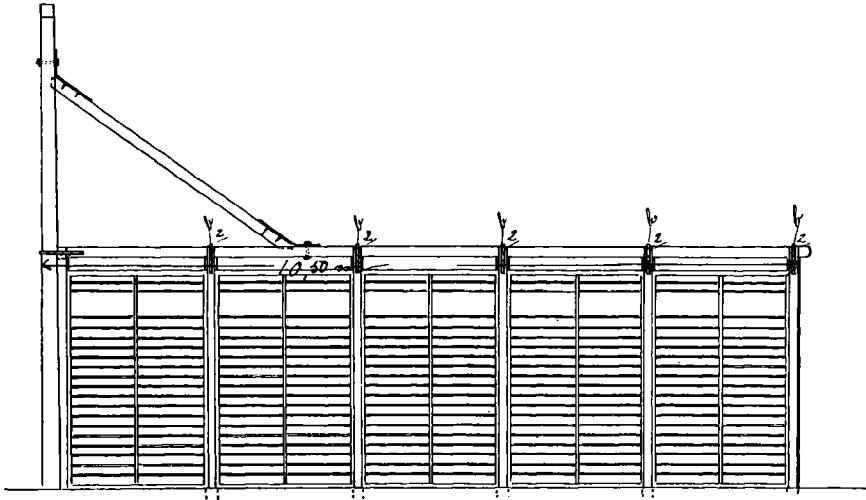

One side of fixed gymnastic apparatus, with 10 sets of ribbstalls.

“ribbstalls”, which could be used from both sides; 34 vertical ropes, 2 inclined ropes, and 4 double beams.

Some of the apparatus needed, but not existing in Sweden — 4 sets of parallel bars; 4 horizontal bars; 4 pommel horses and a staging with 4 rings — was obtained from Dietrich & Hannach, Chemnitz, but, unfortunately, some of the sections were not properly adjusted, nor were the horizontal bars of the length ordered. The competitors criticized this material in other respects, too, during the course of the Games.

In order to give the gymnastic exercises a greater resemblance to those carried out in gymnasiums, a large “floor”, 15 x 25 met., was laid down close to the apparatus.

Dressing Rooms.

In spite of the Stadium being of great size, and of the best use being made of the space available, there was not a sufficient number of dressing rooms for the gymnasts, so that the Riding School behind the Stadium was taken and made use of for the purpose in question.

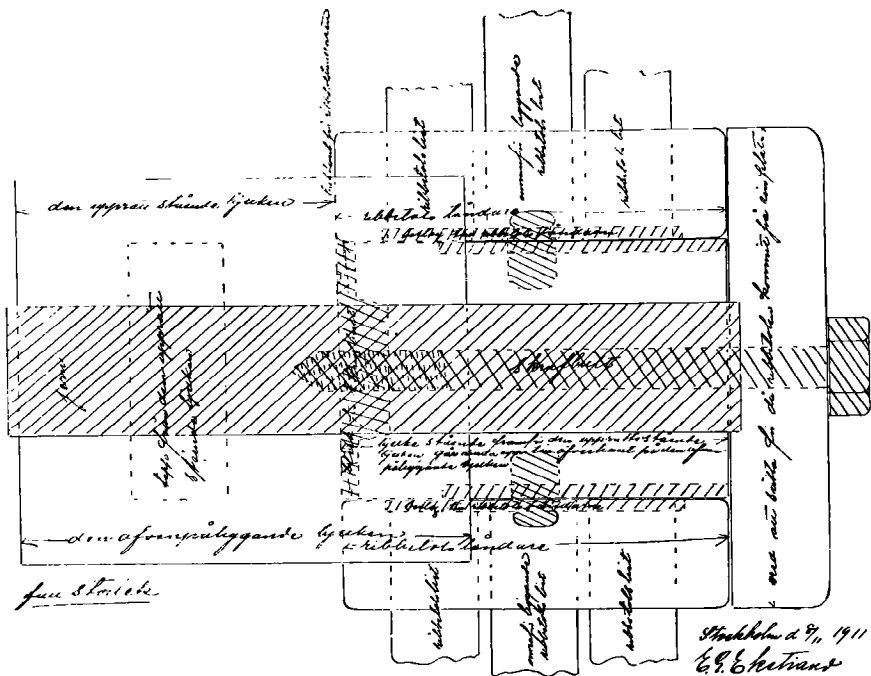

Detail-drawing, showing method of fixing the ribb-stalls, and the beams and the bands of iron across the beams.

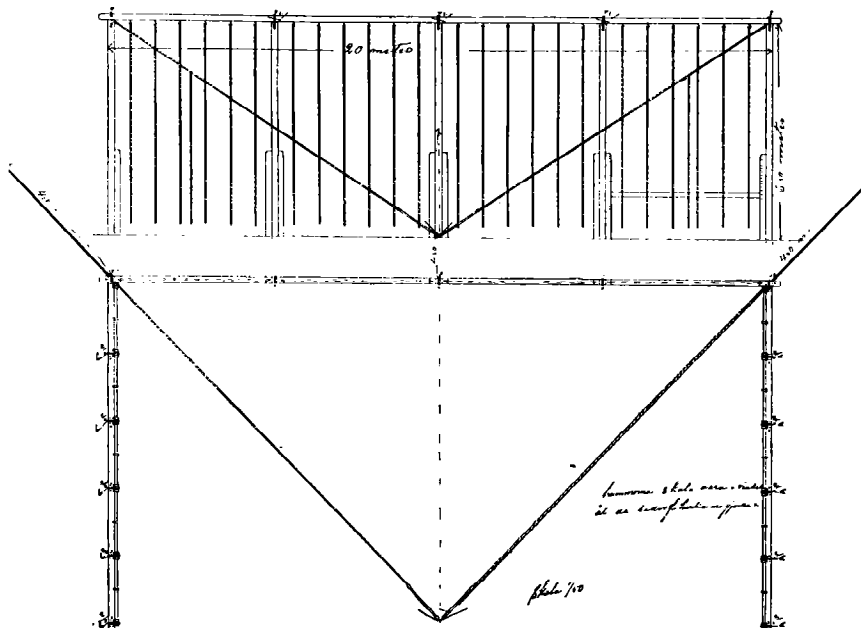

Plan of the removable gymnastic apparatus, with one side turned outwards. Gymnastic apparatus shown: 20 sets ribb-stalls; 4 beams, with double beams and canals for d:o; 2 single inclined ropes with guide ropes: 26 vertical ropes.

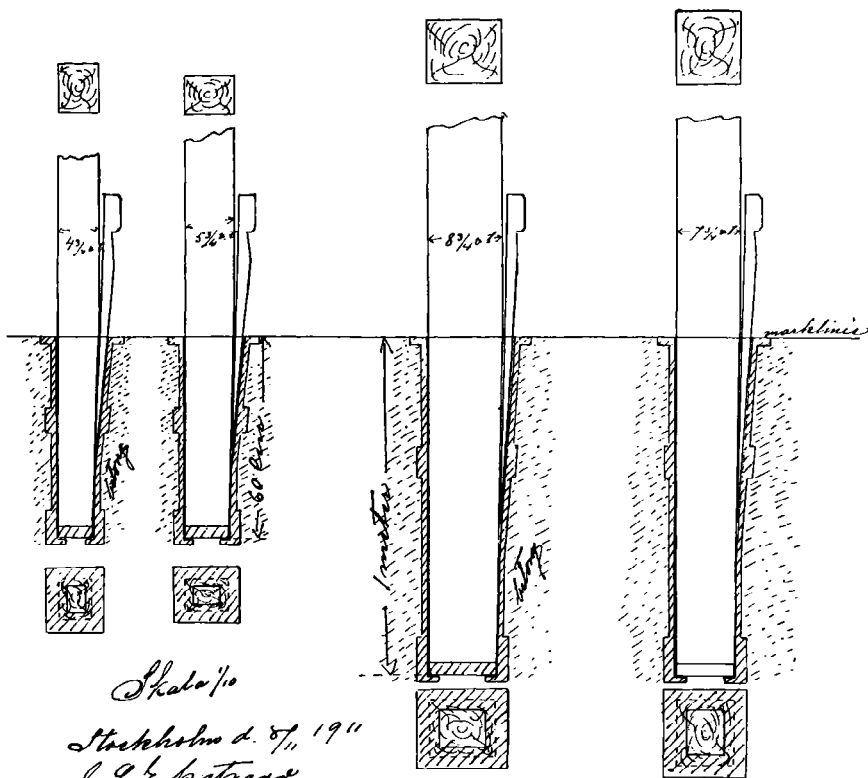

Detail-drawing of iron sockets sunk in arena, and of the posts, for fixed gymnastic apparatus, which are let down into these sockets, together with wooden wedges for wedging fast the posts after insertion.

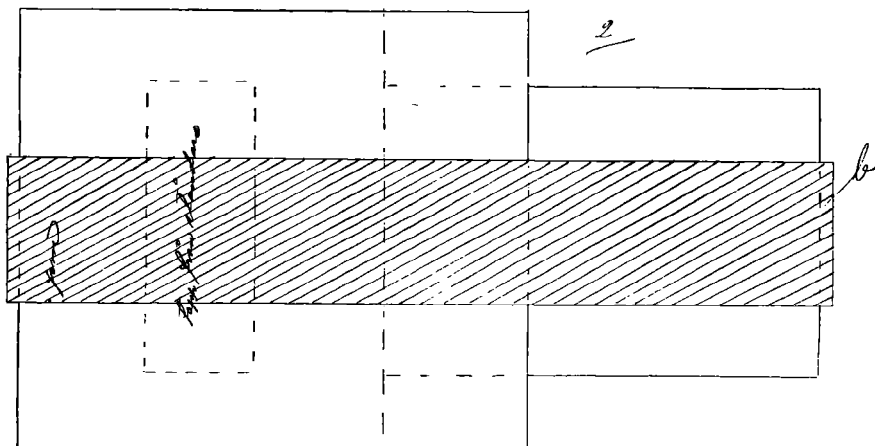

Plan, showing the beams, and the iron-bands across them for fixing the ribb-stalls.

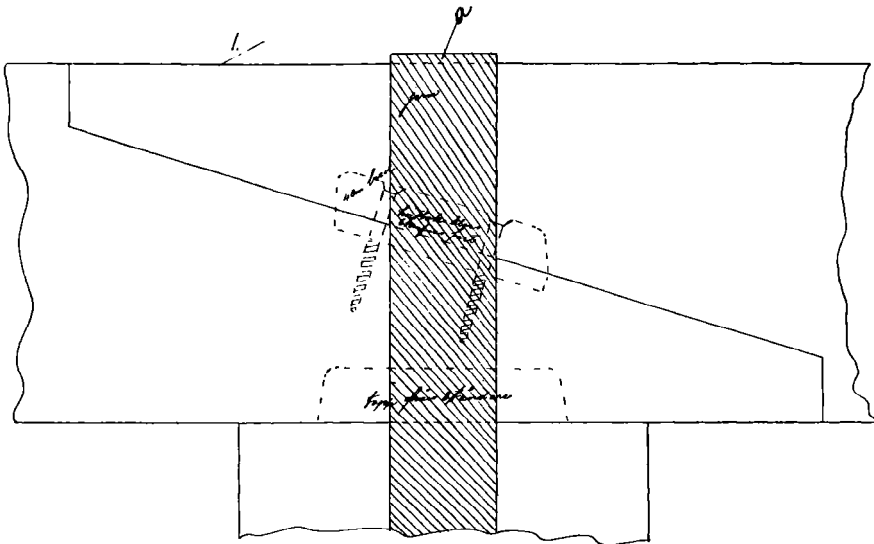

Detail-drawing showing method of fastening together the top beams.

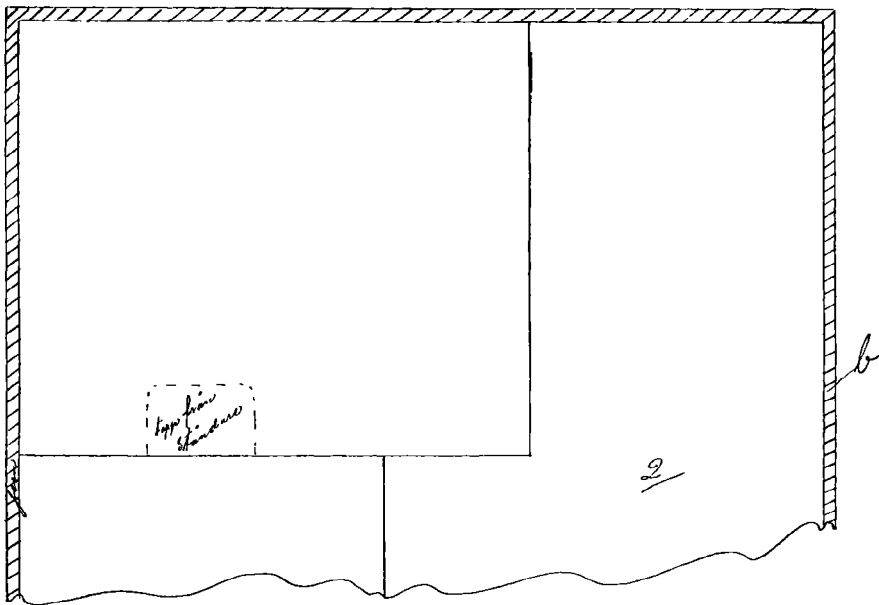

Detail-drawing of the top beams and of the iron band around them.

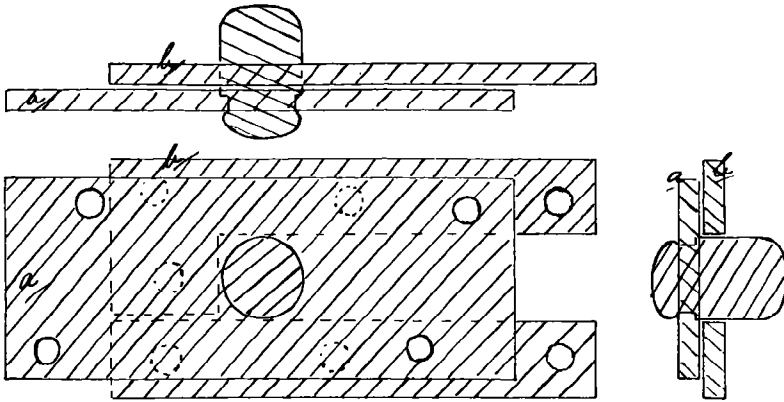

Plan showing mountings for fastening of ribb-stalls.
 a) A piece of metal whose top (riveted on) is screwed fast to the ribb-stall posts;
 b) the metal screwed fast to the beam.

Officials.

The officials were:

Chief Leader: Captain Einar Nerman. *Adjutants:* Dr. Hedvig Malmström; Mr Thure Lindfors (Gymnastic Director) and Lieutenant Hjalmar Hedenblad.

Leader of the Team Competitions: Major P. Lundblad. *Adjutant:* Captain Gerhard Winroth.

Leader of the Individual Competition: Lieutenant Wilhelm Carlberg. *Adjutant:* Lieutenant G. Setterberg.

Leader of the Displays: Captain A. Krautmeyer.

Chief Orderly: Lieutenant A. Berg von Linde. *Adjutant:* Fröken Mia Shannong (Gymnastic Director).

Chief Storekeeper: Georg Löfgren, Esq. *Adjutant:* Lieutenant Gunnar Höjer.

Secretaries of the Competitions: E. Löfvenius, Esq., Captain Carl van Platen, Lieutenant Gustaf Moberg.

Hostesses of the Women Gymnasts: Fröknarna Louise von Bahr, Anna Lundberg, Maria Palmqvist, Sigrid Hellström and Signild Arpi.

Offices.

During the Games, the Offices of the Gymnastic Competitions were on the 5th floor in the east tower of the Stadium. At this place information was supplied, meetings were held, and results were calculated.

THE COMPETITIONS AND DISPLAYS.

Meetings of the Judges.

In order to obtain uniformity in the judging, and to avoid disputes between the judges, during or after the competitions, the said officials in the various groups were called to meetings at different

times by the chief leader, who then informed the judges in question of their duties, gave them copies of the programme of the competitions, showed them the protocol-forms, etc. This having been done, the judges had private deliberations concerning their work.

Time Table.

<i>Saturday, 6 July:</i>		
12.00 noon—p. m.	}	Sweden: Display by men gymnasts.
		» » » women »
<i>Monday, 8 July:</i>		
9.30a. m.—11.00 a. m.	}	Denmark: Display by men gymnasts.
		» » » women »
11.00 » —11.45 »		Norway: » » »
11.45 » —12.30 p. m.		Finland: » » »
2.00 p. m.—3.00 »		Sweden: Team competition I
3.00 » —4.00 »		Norway: » » »
4.00 » —5.00 »		Denmark: » » »
		(with movements according to Swedish system)
<i>Wednesday, 10 July:</i>		
9.30 a. m.—10.30 a. m.		Germany: Team competition III
10.30 » —11.30 »		Norway: » » »
11.30 » —12.30 p. m.		Denmark: » » »
2.00 p. m.—3.00 »		Finland: » » »
3.00 » —4.00 »		Luxemburg » » »
4.00 » —4.45 »		Hungary: Display by men gymnasts.
		(with free choice of movements and apparatus)
<i>Thursday, 11 July:</i>		
9.30 a. m.—10.30 a. m.		Luxemburg: Team competition II
10.30 » —11.30 »		Hungary: » » »
11.30 » —12.30 p. m.		Germany: » » »
2.00 p. m.—3.00 »		Great Britain: » » »
3.00 » —4.00 »		Italy: » » »
		Russia: Display by men gymnasts.
		(according to special regulations)
<i>Friday, 12 July:</i>		
9.30 a. m.—12.30 p. m.	}	Individual competition on horizontal bar, parallel bars,
2.00 » —5.00 »		rings and pommel horse.

THE COMPETITIONS.

TEAM COMPETITION I.

This competition took place between 2 and 5 p. m. , Monday, 8 July.

Judges:

- Major O. Lefebure, Belgium,
- N. H. Rasmussen, B. A., Denmark,
- Captain A. E. Syson, Great Britain,
- Major L. Bentzen, Norway,
- Captain L. K. Wallenius, Sweden.

SWEDEN, 2—3 p. m.

Leader, Captain Ebbe Lieberath.

The team consisted of 24 men, in addition to the bearer of the colours, Lieutenant K. E. E. Ekblad.

Osvald Holmberg; Nils Daniel Granfeldt; Lars Daniel Norling; Knut E. Torell; Karl Silfverstrand; Karl J. Svensson; Axel Norling; Claës A. Wersäll; David Wi-

man; P. D. Bertilsson; Per E. Nilsson; J. Sörensson; Sven Landberg ; Karl Erik Svensson; Bengt Rudolf Norelius; A. B. G. Kullberg; Anders Hyllander; Yngve Stiemspez; O. Edward Wennerholm; C. Hartzell; Axel J. Janse; C. E. Carlberg; S. A. A. Rosén; O. Silfverskiöld.

Dress : White gymnastic jersey with short arms; white trousers; white shoes; blue and yellow belt.

Programme.

Introductory Exercises:

Arm rotating.

Stretch — Knee-bend position. Double knee-bending to sitting (squat) position. Double arm sinking and lifting.

Rest-Step (a) — Turn position. Back-bending backwards.

Stretch-Step (a) — Turn—Steep position. Double arm-stretching outwards and upwards.

Rest-Step (a) position. Twisting and bending of trunk to same side as rear foot, with lifting of heel of front foot.

Foot-flitting sideways (stand astride) ; rise on toes; double knee-bending with double arm-stretching upwards and downwards.

Archflexion (Span-bending) Movements:

Span-bending position. Alternate leg-lifting, with rising on toes.

Crook-hanging position. Double knee-stretching.

Stretch-Span-hanging position. Jump down to knee-bend position.

Wing—Sitting (squat; position. Head twisting.

Heaving Movements:

Travelling along beam, with alternate grasps with hands and knees.

Reverse-hanging position. Circle over and jump down to knee-bend position.

Balance Movements:

Counter-hanging position. Circle over to balance-hanging. Riding position.

Rise to balance-standing position. Wave—Half-standing position. Spurn position. Sink to sit-position across beam. Back circle downwards.

Shoulder-blade Movement:

Stretch—Wave—Ankle-support position. Back-bending forwards and downwards (:).

Abdominal Exercise:

Stretch—Facing apparatus—Fall—Half-standing position. Double arm bending and stretching.

Lateral (Alternate) Trunk Movement:

Half-stretch—Lunge (a) position. Arm shifting, with twisting and effacing.

Marching and Doubling.

Shoulder-blade Movement:

Stretch—Lunge (a)—Turn position, Double arm-stretching.

Abdominal exercise:

Arch—Steep position. Starting position and double arm-bending (:).

Lateral (Alternate) Trunk Movement:

Rest—Side facing apparatus—Half-standing position. Side-bending (:).

Leg movement:

Rest position. Rise on toes; double knee-bending.

Heaving Movement:

Steep—Wave—Hanging position. Climbing downwards with alternate movements of arms and legs.

Vaulting:

Free jumping.

Circle over.

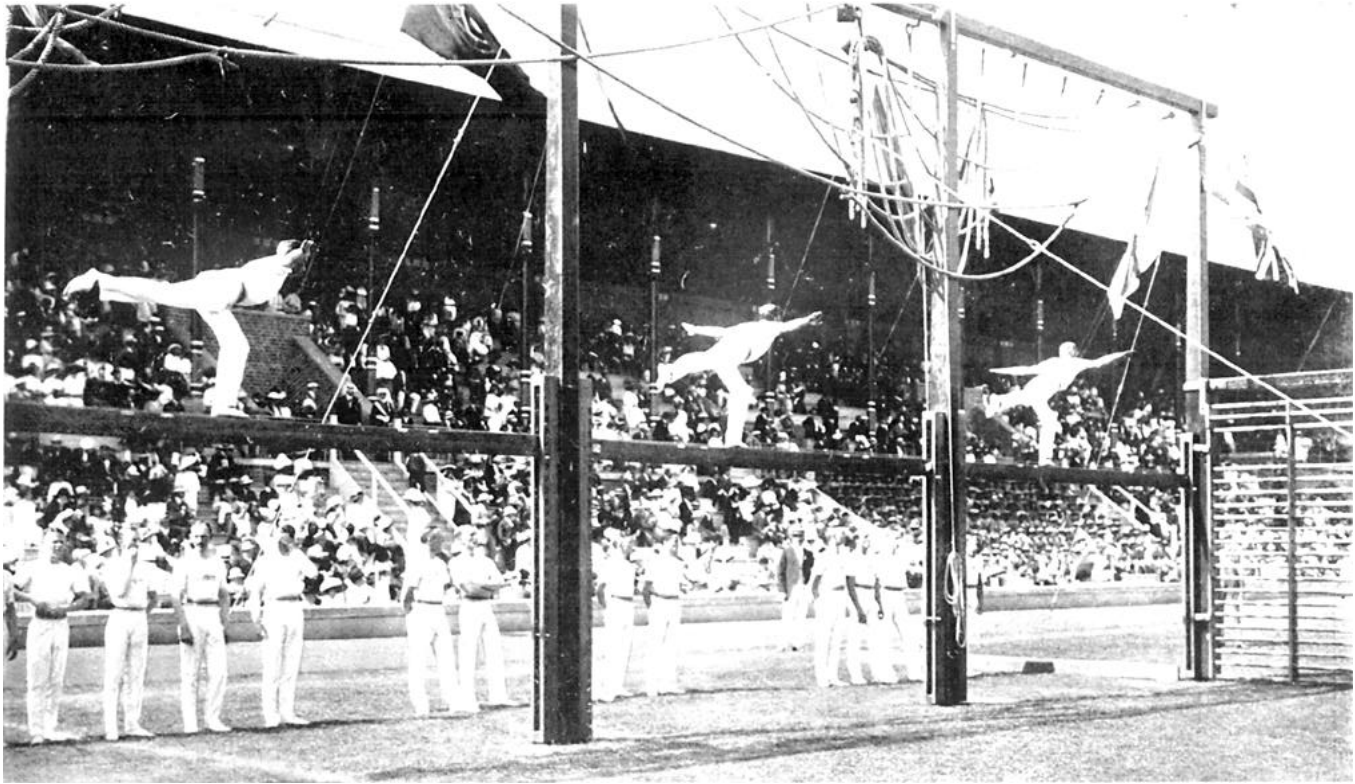

THE SWEDISH GYMNASTS IN TEAM COMPETITION I. Balance-walk on beam.

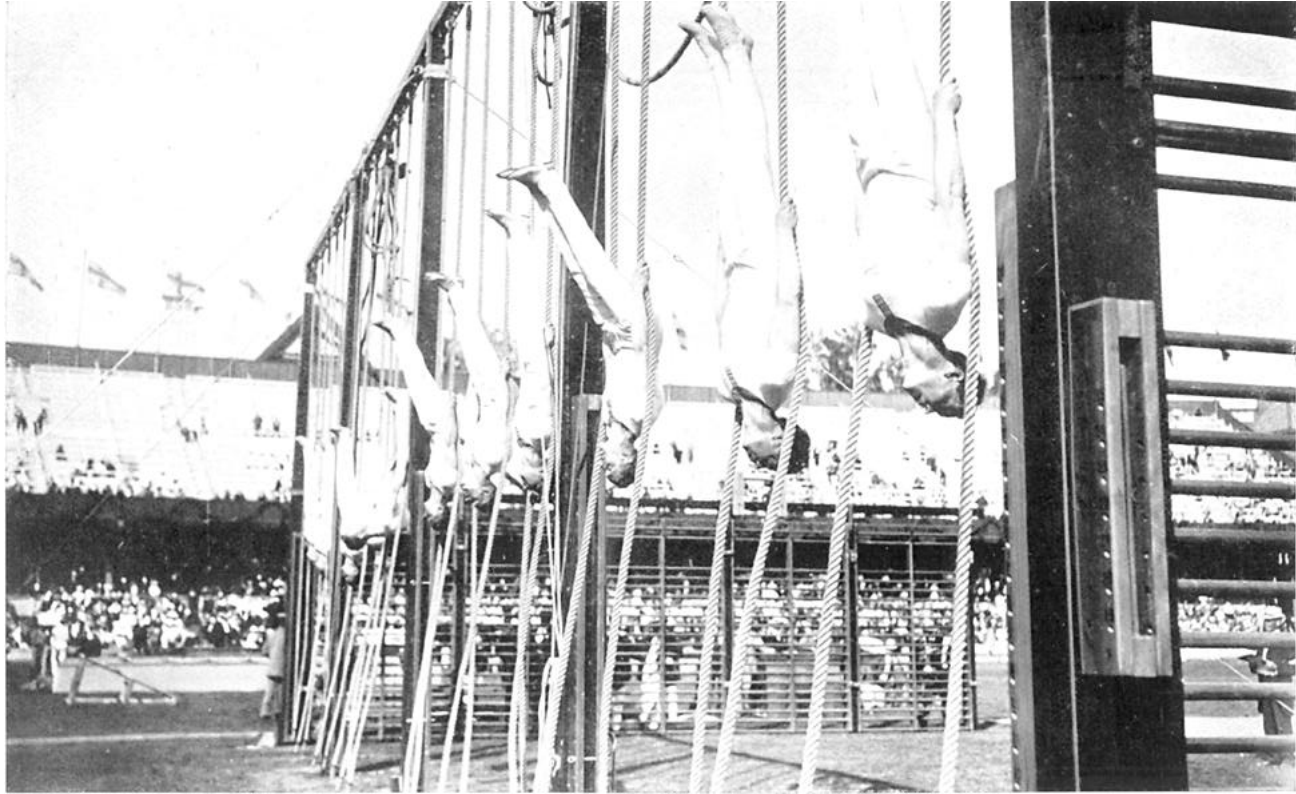

THE NORWEGIAN GYMNASTS IN TEAM COMPETITION I.
"Steep-hanging".

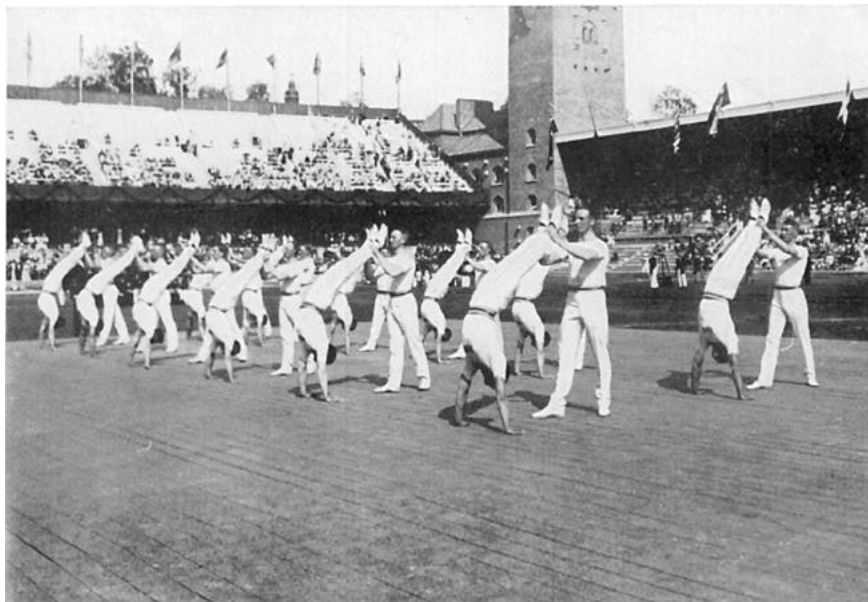

THE SWEDISH GYMNASTS IN TEAM COMPETITION I. "Arch-steep-standing".

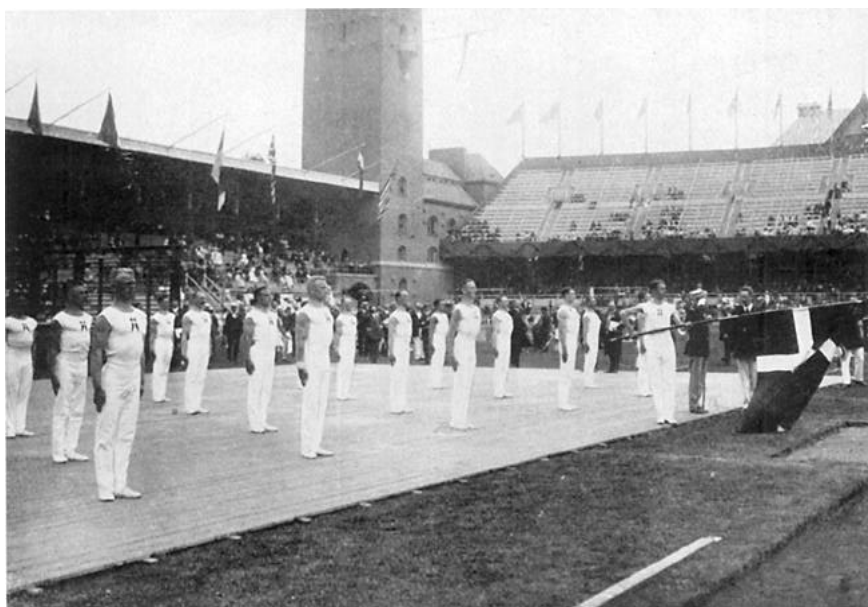

THE DANISH GYMNASTS IN TEAM COMPETITION I.

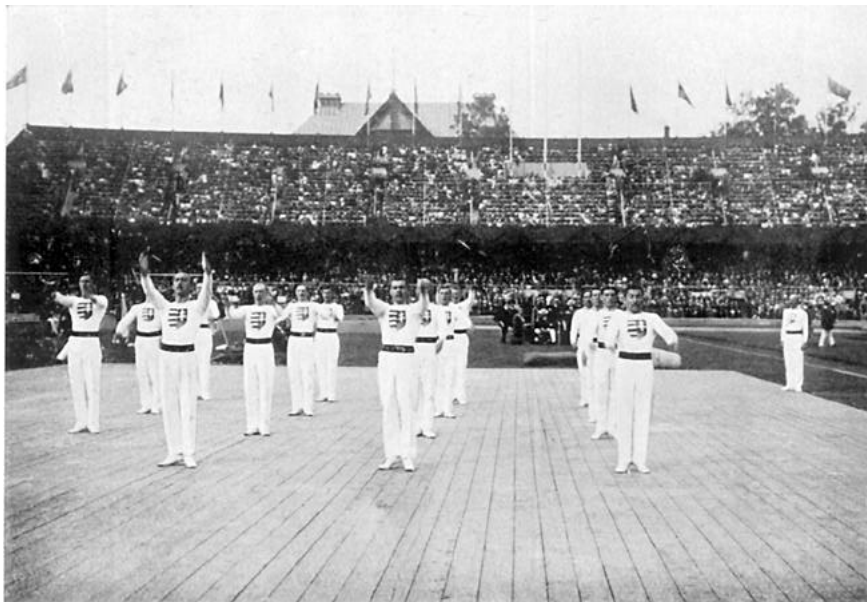

THE HUNGARIAN GYMNASTS IN TEAM COMPETITION II.

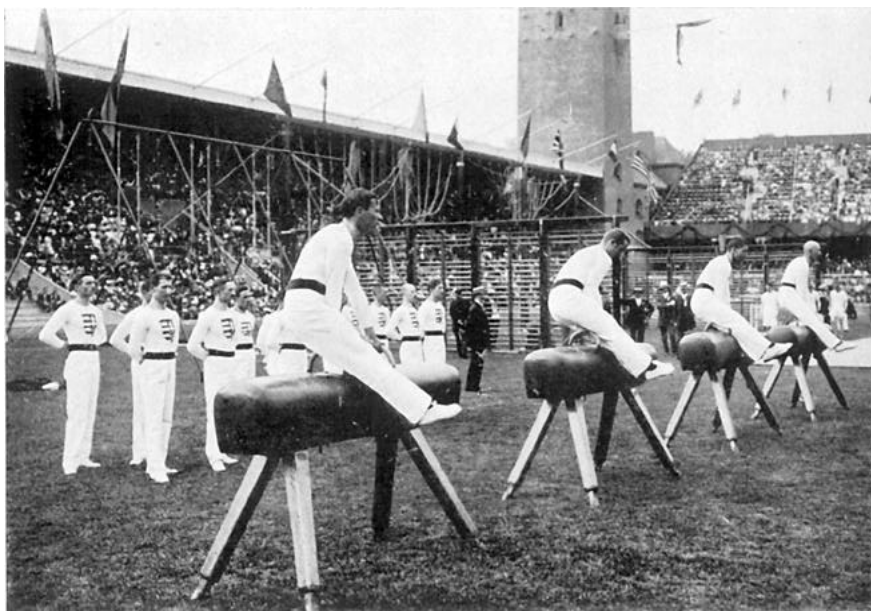

THE HUNGARIAN GYMNASTS IN TEAM COMPETITION II
(on pommelled horse).

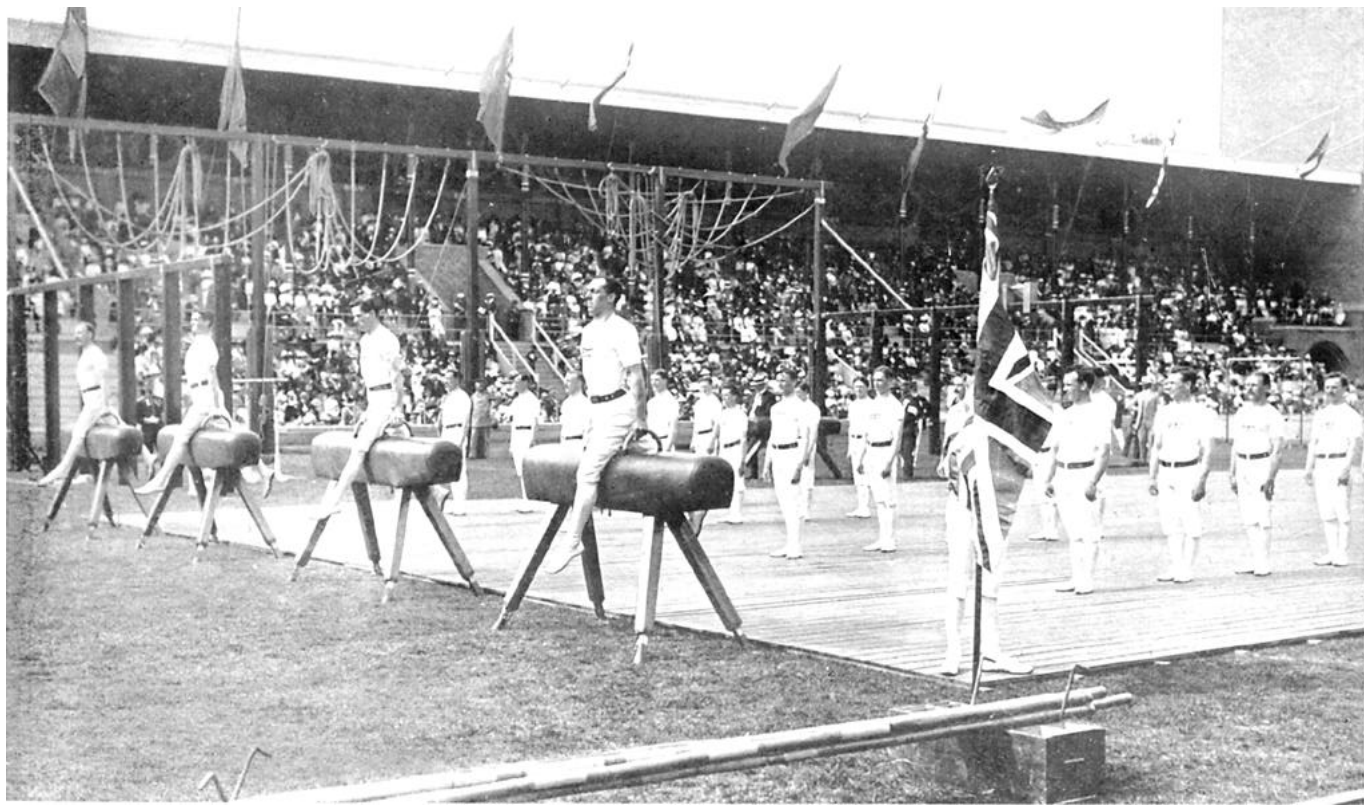

THE BRITISH GYMNASTS IN TEAM COMPETITION II.
(on pommel horse).

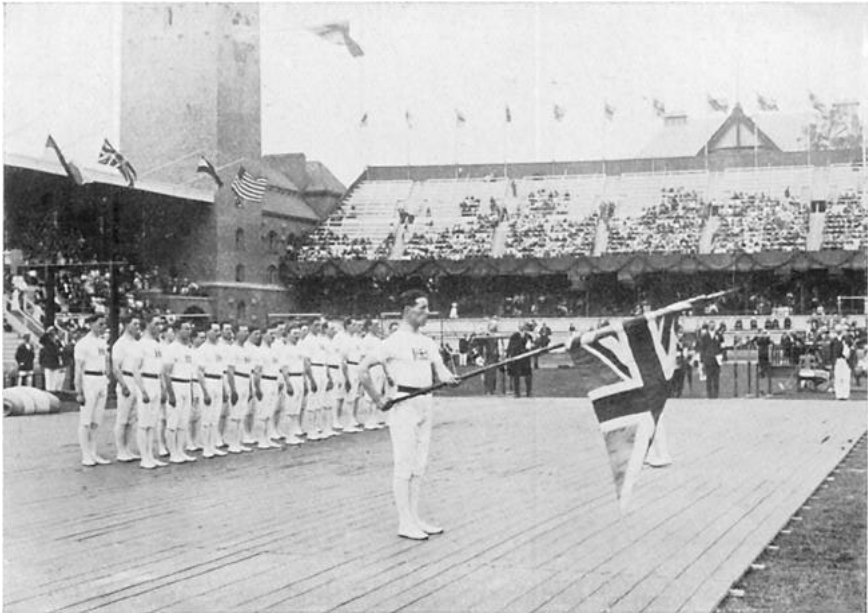

THE BRITISH GYMNASTS IN TEAM COMPETITION II.

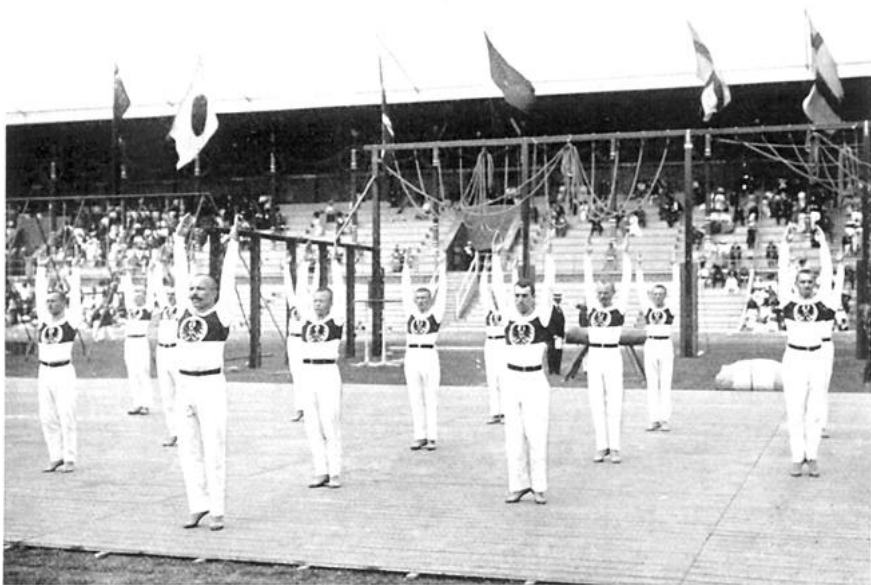

THE GERMAN GYMNASTS IN TEAM COMPETITION II.



THE LUXEMBURG GYMNASTS IN TEAM COMPETITION II.

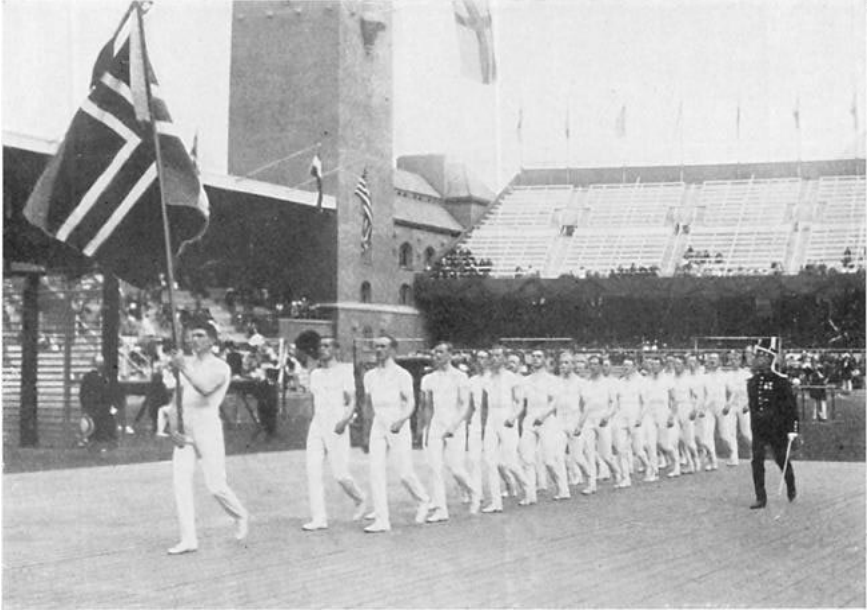

THE NORWEGIAN GYMNASTS IN TEAM COMPETITION III.

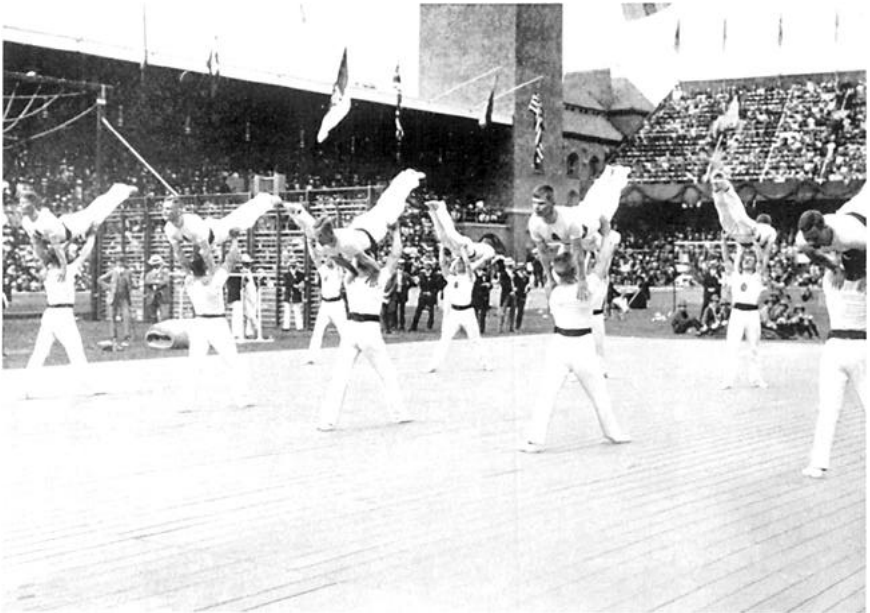

THE FINNISH GYMNASTS IN TEAM COMPETITION III.
Forward Bow-lying with living support.

Inside jump.
Outside jump.
Balance jump.

Concluding exercises:

Foot-flitting outwards; rising on toes and knee-bending, with double arm-stretching upwards and downwards.
Clasp position. Back-bending backwards, with double arm-lifting.
Rest—Stride position. Side twisting.
Double arm-lifting upwards, with rising on toes and double knee-bending.

NORWAY 3—4 p. m.

Leader: First Lieutenant C. Frølich-Hanssen.

The team consisted of 22 men, as follows:

Thorleif Thorkildsen; Conrad Christensen; Paul Pedersen ; Fritjof Olsen; Edvin Paulsen; Jörgen Andersen; Carl Pedersen; Arthur Amundsen; Georg Brustad; Marius Eriksen; Peter Hol; Olof Ingebretsen; Thor Jensen; Sigurd Smeby; Reolf Roback; Eugen Engebretsen; Oscar Engelstad; Erling Jensen; Trygve Boysen; Axel Henry Hansen; Oscar Olstad; Olof Jacobsen.

Dress: White jersey with short sleeves; white trousers; white shoes; white belt.

Programme.

Order- and Time exercises.

Standing position. Head-bending backwards, with arm-lifting outwards.

Wing position. Introduction to free jumping.

Standing position. Arm stretching upwards, outwards, forwards and downwards.

Stretch—Step position. Back-bending backwards.

Clasp—Step position. Back-bending forwards.

Rest—Step position. Twisting.

1. Standing position. Foot-flitting outwards, with rising on toes and knee-bending and arm-lifting outwards and upwards.
2. Span-bending position. Leg-lifting and rising on toes.
Stretch position. Back-bending forwards and downwards.
Wing—Toe position. Deep knee-bending.
3. Under-hanging position. Travel sideways, with alternate grasps, and with turning and heaving each time.
4. Wing—Crook—Half-standing position. Knee stretching backwards.
Balance exercise on high beam (Hanging somersault backwards and up. Mount beam: Balance march. Clasp—Wave—Half-standing position. Somersault down).
5. Stretch—Ankle-fast—Wave position. Back-bending forwards-downwards.
6. Stretch—Counter—Half-standing position. Back-bending backwards.
7. Stretch—Side-counter—Half-standing position. Side bending.
8. March. March at the double. March on toes.
9. Wing—Lunge (a) position. Rise on toes.
10. Change between Stretch—Toes-fast—Half-standing position, and Clasp—Wave—Half-standing position, forwards.
(Moving forwards with arm-swinging upwards — Wave-position with arm-sinking outwards. Toes fast — Half-standing position, with arm swinging downwards, forwards, upwards.)
11. Span—Steep position. Arm-bending (:).
A game: (Relay race).
12. Clasp—Stride—Toe-position. Knee-bending with arm-lifting upwards.
13. Travelling on arms, in vertical position on 2 ropes, with somersault backwards. "Pumping" downwards on arms.
14. Standing position. Throwing a "Catherine wheel".
15. Running "Land Surveyor's" jump. In stream.
Running jump with turn (right and left) over rope. Height 1 metre.

With vaulting-horse lengthwise: Height 1.45 metre.
 Running riding jump to standing position on saddle. Low jump down.
 Running straddle jump over horse.
 Running side jump; back turned to apparatus.
With plinth sideways: Height 1.25 metre.
 Running circle over, with turn (right and left).
With horse sideways: Height 1.45 metre.
 Inside Jump, in stream.

16. Rest—Stride—Twist position. Back-bending backwards and forwards
 Clasp—Toe position. Knee-bending
 Clasp position. Marching with arm-swinging.
 Clasp position. Deep breathing.

DENMARK 3—4 p. m.

Leader: Captain A. Hansen.

The team consisted of 28 men, as follows:

Søren Peter Christensen; Ingvald Eriksen; George Falche; Thorkild Garp; Hans Trier Hansen; Johannes Hansen; Rasmus Hansen; Jens Kristian Jensen; Søren Alfred Jensen; Valdemar Jensen; Karl Kirk; Jens Kirkegaard; Olav Nielsen Kjems; Carl Otto Lauritz Larsen; Jens Peter Martinus Laursen; Marius Ludvig Lefevre; Povl Sørensen Mark; Ejnar Olsen; Hans Ejler Pedersen; Olaf Pedersen; Peder Larsen Pedersen; Hans Pedersen; Aksel Sørensen; Martin Hansen Thau; Søren Frederik Thorborg; Kristen Møller Vadgaard; Peder Villemoes; Johannes Larsen Vinther.

Dress: white jersey with short sleeves; white trousers; white shoes; white belt.

Programme.

- A. 1. Half-stretch—Lunge a) position. Charge arms per Wing position.
 2. Standing position. Head-bending backwards.
 3. Standing position. Arm-stretching forwards, outwards, upwards, with arm-sinking outwards, downwards.
 4a. Clasp—Stride position. Twisting, followed by arm-lifting upwards.
 b. Clasp—Stride position. Side-bending with arm-sinking. Hips-fast, and single-knee bending.
 5. Clasp—Step (a) position. Arm-flinging outwards.
 6. Wing—Half-kneel position. Trunk-bending backwards.
 7. Wing—Stride position. One-sided rising on toes and deep knee-bending.
 B. 1a. Stretch—Span—Sitting (Squat) position. Span-bending with rising on toes and leg-lifting.
 b. Trunk-bending forwards, with arm-lifting upwards ; Trunk-bending downwards; Span—Steep—Hand-standing position. Arm-bending.
 2a. Counter Hanging position. Travel on arms, with heaving on alternate sides.
 B. 2b. Stretch—Reverse-hanging position. Forward circle up, and backward swing down.
 3. Half-wing—half-stretch position. Side-falling with leg lifting.
 4. Stretch—Toes-fast — Wave position. Arm sinking outwards, followed by trunk-bending downwards.
 5. Wing—Facing apparatus—Ankle-fast position. Trunk-bending backwards, followed by one-sided knee-bending and arm-bending, and slow arm-stretching upwards.
 6a. Marching.
 b. Side March.
 March with leg-swinging.
 c. Parade March.
 d. March at the Double.
 e. Free side-lying, with arm-lifting outward and upward, and with leg-lifting.
 8a. Jumping on place.
 b. 1. High jump: Right and left foot first. Any foot first.

GENERAL PROTOCOL.

I. Team Competition with movements according to Swedish system.

	Points awarded by						
	Lefebure	Bentzen	Rasmussen	Syson	Wallenius	Total	Average
<i>Sweden:</i>							
Introductory exercises	70	68.75	70	60	70		
Archflexions	120	108	112	104	104		
Heaving movements	98	98	98	89.25	101.5		
Balance movements	52	56	52	40	52		
Shoulder-blade movements	78	82.5	84	75	84		
Abdominal exercises	81	82.5	84	75	87		
Marching and running	105	99.75	98	98	105		
Lateral trunk movements	91	91	98	85.75	94.5		
Vaulting	101.5	98	93.8	80.5	98		
Concluding exercises	54	57	56	48	56		
Evenness and precision	120	112	112	86	112		
Total points	970.5	953.5	957.8	841.5	964	4,687.3	937.46
<i>Norway:</i>							
Introductory exercises	55	68.75	65	50	67.5		
Archflexions	80	110	112	86	104		
Heaving movements	70	98	91	84	84		
Balance movements	46	54	54	43	50.4		
Shoulder-blade movements	72	81	78	66	78		
Abdominal exercises	75	84	78	69	78		
Marching and running	84	98	84	84	93		
Lateral trunk movements	94.5	96.25	91	75.25	94.5		
Vaulting	84	98	86.8	66.50	89.6		
Concluding exercises	44	54	48	46	56		
Evenness and precision	92	110	88	80	112		
Total points	796.5	952	875.8	749.75	912	4,286.05	857.21
<i>Denmark:</i>							
Introductory exercises	60	67.5	68	65	63		
Archflexions	104	106	120	104	112		
Heaving movements	84	110	94.5	77	84		
Balance movements	44	54	56	32	52		
Shoulder-blade movements	78	79.5	84	60	84		
Abdominal exercises	75	81	78	69	84		
Marching and running	94.5	92.75	98	80.5	88.2		
Lateral trunk movements	91	98	98	77	98		
Vaulting	94.5	96.25	98	80.5	84		
Concluding exercises	52	54	56	44	56		
Evenness and precision	112	112	112	104	112		
Total points	889	932.5	962.5	793	917.2	4,494.2	898.84

Approved, Stockholm, 8 July, 1912.

O. LEFEBURE. L. BENTZEN. N. H. RASMUSSEN.

A. E. SYSON. KONR. WALLENUS.

Judges.

Confirmed: EINAR NERMAN, Chief Leader.

2. Straddle vault over plinth (plinth lengthwise).
 3. Running jump. Stand on horse between pommels. Deep-jump down (feet together) forwards. (Horse sideways.)
 4. Running circle over (horse sideways). The jump down to be the start for summersault on floor.
 5. Balance jump.
 6. Straddle vault (horse lengthwise).
 7. Inside jump (horse lengthwise).
 8. Side jump with front turn. (High plinth, sideways.)
 9. Straddle vault over high plinth (p. lengthwise).
 10. "Land Surveyor's" jump over low plinth (p. sideways).
 11. Running circle over low plinth (p. sideways).
 12. Free foot, broad jump forward, with start from low plinth.
 13. "Wheeling", on floor with both feet together; with feet apart. Walking on hands.
- C. 1. Foot-flitting sideways; with arm-swinging outwards + Wing position, foot-flitting outwards + Clasp position, foot-flitting forwards with arm-flinging outwards.
2. Half-Wing—Half-standing—Step a) position. Side bending.
 3. Clasp—Stride position. Trunk-bending backwards with hand-turning inwards.
 4. Stretch—Stride position. Back-bending, forwards and downwards.
 5. Standing position. Arm-lifting outwards and upwards, with hand-tuning upwards and deep breathing.

Result:	I prize.....	SWEDEN	937,46	points
	II »	NORWAY	898,84	»
	III »	DENMARK	857,21	»

TEAM COMPETITION II.

Thursday, 11 July.

This competition took place on Thursday, 11 July, between 9,30 a. m.—12,30 p. m. and 2 p. m.—4 p. m.

Judges :

Herr Michael Bély, Hungary,
 Dr. Abr. Clod-Hansen, Denmark,
 Captain A. E. Syson, Great Britain.
 Professor Cesare Tifi, Italy,
 Dr. Wagner Hohenlobbese, Germany.

LUXEMBURG 9,30—10,30 a. m.

Leader: Direktor Valentin Peffer.

Team: 16 men took part in the competition.

Nic. D. Adam: Charles Behm; André Bordang; François Hentges; Pierre Hentges; Michel Hemmerling; J. B. Horn; Nicolas Kanivé; Nicolas Kummer; Marcel Langsam; Emile Lanners; J. P. Thommes; François Wagner; Antoine Wehrer; Ferdinand Wirtz; Joseph Zouang.

Dress: White jersey, with sleeves reaching to elbows; black stock-inet pantaloons with white facings.

Programme.

A) EXERCICES D'ENSEMBLE LIBRES.

Remarques: Les exercices libres sont au nombre de trois; ils s'exécutent sur deux faces.

Le premier exercice se compose de 6 mouvements, ce qui donne pour les deux faces, 12 mouvements à 4 temps, soit au total 48 temps.

Les deux derniers exercices se composent de 7 mouvements, ce qui donne pour les 2 faces 14 mouvements à 4 temps, soit au total, 56 temps, soit pour les 3 exercices $48 + 56 + 56 = 160$ temps.

La cadence est de 80 à la minute.

Positions. Les chiffres soulignés indiquent les mouvements d'exécution, les autres les maintiens. Les positions se prennent toujours au 1:er et au 3ieme temps.

Mains. Elles sont toujours ouvertes, sauf indication contraire. Dans la position: bras en avant, -en haut, -latéralement, -en arrière, -en bas, se reporter à l'indication de l'exercice.

Jambes. "Position d'à fond". On tombe à fond en déplaçant et en fléchissant une jambe et en posant ce pied au *plus grand écartement* possible, tandis que la jambe stationnaire reste tendue. Le tronc se met en ligne droite avec la jambe tendue. La tête reste toujours droite dans la ligne médiane du corps, comme dans la position initiale,

Par exemple: Tomber à fond du pied gauche (droite) en avant, veut dire: Placer le pied gauche (droit) le plus loin possible en avant, en fléchissant la jambe gauche (droite), la jambe droite (gauche) reste tendue; le tronc se met en ligne droite avec la jambe droite (gauche) tendue et la tête reste droite dans la ligne médiane du corps.

Les élévations de jambes, en avant, en arrière et de côté se font à environ 40 cm. du sol.

Position initiale: Station tendue jointe, bras en bas, mains ouvertes.

I. *Exercice.*

I. 1. 2. Lever la jambe gauche tendue en avant, en élançant les bras horizontalement en avant; mains ouvertes, paumes en dedans.

3. 4. Poser à fond de la pointe du pied gauche en arrière, en élançant bras gauche en arrière en bas, bras droit en haut; mains ouvertes, paumes en dedans. (Ne pas confondre avec tomber à fond.)

II. 1. 2. Changer par un quart de tour à gauche sur les talons, à la station écartée, en étendant jambe droite et en élançant les bras en haut; (bras droit passe par en bas, -en avant, -en haut, bras gauche par en avant, -en haut); mains ouvertes, paumes en dedans.

3. 4. Fléchir le tronc en avant, en élançant les bras par en dehors à gauche en avant; (le tronc doit suivre les mouvements des bras) mains ouvertes, paumes en dedans.

III. 1. 2. Élaner les bras par en dehors à droite en haut, en suivant avec le tronc les mouvements des bras, puis fléchir les bras; mains fermées, ongles en dedans, coudes en bas et joints au corps.

3. 4. Tourner tête et tronc un quart de tour à gauche, en étendant les bras latéralement; mains ouvertes, paumes en dessous.

IV. 1. 2. Tomber à fond du pied gauche en avant, en tournant sur le talon droit un quart de tour à droite et en élançant les bras par en bas, -en avant, -en haut; bras mi-fléchis, mains fermées, poings au-dessus de la tête, ongles en avant.

3. 4. Étendre les bras transversalement; mains ouvertes, paumes en dessous (bras gauche horizontalement en avant, bras droit horizontalement en arrière).

V. 1. 2. Quart de tour à droite sur les talons, en étendant jambe gauche et en élançant les bras de côté en haut; mains ouvertes, paumes en dedans.

3. 4. Demi-tour à droite sur le talon droit et la pointe du pied gauche, puis abaisser les bras latéralement (tronc tout détourné); mains ouvertes, paumes en dessous.

VI. 1. 2. Quart de tour à droite sur la pointe du pied droit, joindre le pied gauche, en élançant les bras, par en bas, -en avant, -en haut; mains ouvertes, paumes en dedans, talons levés.

3. 4. Position initiale, en élançant les bras par en arrière en bas.

VII—XII. Continuer l'exercice sur l'autre face en lisant "droite" au lieu de "gauche" et vice versa.

II. Exercice.

I. 1. 2. Fléchir les avant-bras sur les bras levés horizontalement de côté; mains ouvertes au-dessus des épaules, paumes en dessous.

3. 4. Tomber à fond du pied gauche à gauche, en étendant les bras en haut; mains ouvertes, paumes en dedans.

II. 1. 2. Étendre jambe gauche, en fléchissant les bras; mains fermées, ongles en avant, coudes légèrement détachés du tronc.

3. 4. Changer à l'à fond du pied droit à droite (en fléchissant jambe droite) et en étendant les bras latéralement; mains ouvertes, paumes en dessous.

III. 1. 2. Étendre jambe droite, en fléchissant légèrement le tronc en arrière et en élançant les bras par en arrière, -en bas, -en avant, -en dehors, -en haut; mains ouvertes, paumes en haut.

3. 4. Grande flexion de la jambe gauche sur la pointe du pied (jambe droite bien étendue à droite); mains ouvertes, paumes en dedans, talons levés.

IV. 1. 2. Quart de tour à gauche sur la pointe du pied, en posant les pointes des mains écartées sur le sol; talons levés.

3. 4. En sautellant en haut, changer à l'à fond de la pointe du pied droit, en élançant les bras en arrière en bas; mains ouvertes, paumes en dedans.

V. 1. 2. Joindre le pied gauche, en élançant les bras par en avant, -en haut; mains ouvertes, paumes en dedans.

3. 4. Poser la pointe du pied droit à gauche (en croisant jambe droite) devant jambe gauche fléchie et en fléchissant les avant-bras sur bras levés en avant; mains ouvertes, paumes en dessous (main gauche sur l'épaule droite, main droite sous l'aiselle gauche).

VI. 1. 2. Tomber à fond du pied droit à gauche, en avant, en étendant les bras transversalement; mains ouvertes, paumes en dessous (bras droit horizontalement en avant, bras gauche horizontalement en arrière).

3. 4. Changer à l'à fond du pied gauche en avant, en tournant $\frac{5}{8}$ de tour sur le talon gauche et la pointe du pied droit, et en élançant le bras droit en haut fléchi au-dessus de la tête, la bras gauche en arrière, -en bas, mains fermées, ongles en avant (tête et tronc doivent être bien détournés et faire face en avant).

VII. 1. 2. Joindre la jambe droite, en faisant face en avant et en élançant les bras étendus en haut (bras droit par en arrière, -en bas, -en avant, -en haut, bras gauche par en avant, -en haut); mains ouvertes, paumes en dedans, talons levés.

3. 4. Position initiale, en faisant tourner une fois les bras devant le corps (bras gauche passe dessus bras droit).

VIII—XIV. Comme VII. du 1er. exercice.

III. Exercice.

I. 1. 2. Sauteler par en haut à la station fléchie, en faisant tourner les bras $\frac{5}{4}$ de cercle devant le corps (bras passant par en avant, -en haut, puis tourner par en bas, -latéralement, bras gauche dessus); mains ouvertes, paumes en dessous, talons joints et levés.

3. 4. Poser à fond du pied gauche en arrière, en élançant les bras en arrière, en bas; mains ouvertes, paumes en dedans.

II. 1. 2. Élançant le bras droit par en avant en haut, en tournant tronc et tête à gauche; mains ouvertes, paumes en dessus.

3. 4. Demi-tour à gauche sur les pointes des pieds, en étendant jambe droite et en fléchissant fortement jambe gauche et en élançant le bras droit par en haut, horizontalement en avant (pointes des doigts de la main gauche écartées touchent le sol); main droite ouverte, paumes en dessous, talons levés.

III. 1. 2. Demi-tour à droite sur les pointes des pieds, en étendant jambe gauche et en fléchissant fortement jambe droite; le bras droit passant par en haut, -en bas, bras gauche de côté, -en haut, -en avant (pointes des doigts de la main droite touchent le sol), -main gauche ouverte, paumes en dessous, talons levés.

3. 4. Étendre la jambe droite en levant la jambe gauche et le tronc horizontalement en arrière (station horizontale faciale), et en écartant les bras latéralement; mains ouvertes, paumes en arrière.

IV. 1. 2. Poser le pied gauche sur le sol (station écartée transversalement) en fléchissant les bras; mains fermées, poignets en hauteur de la ceinture, ongles se faisant face.

3. 4. Étendre le tronc en avant, en levant la jambe gauche en arrière à gauche, et en élançant bras droit en haut, bras gauche, à gauche en bas; mains ouvertes, paumes en bas.

V. 1. 2. Quart de tour à droite sur le talon droit, en posant le pied gauche à fond en avant et en fléchissant bras droit et en levant bras gauche horizontalement en avant; main ouverte, main droite écartée à la hauteur des épaules, paume de la main gauche en bas.

3. 4. Étendre vivement le tronc et le bras droit en avant, en étendant et en levant la jambe droite en arrière en haut; bras gauche passant par en arrière en bas; mains ouvertes, paumes en bas, talon gauche levé.

VI. 1. 2. Quart de tour à droite sur la pointe du pied gauche, en posant pied droit latéralement à droite et en élançant les bras latéralement (bras droit passant par en haut, bras gauche de côté); mains ouvertes, paumes en bas.

3. 4. Demi-tour à droite sur le talon droit sur la pointe du pied gauche en fléchissant la jambe droite et le tronc en avant et en élançant le bras gauche fléchi au-dessus de la tête, bras gauche tendu en arrière en bas; mains fermées, ongles en avant (tête et tronc bien détournés).

VII. 1. 2. Demi-tour à droite sur la pointe du pied droit, grande flexion des jambes, en joignant les pieds et en élançant les bras horizontalement en avant; mains ouvertes, paumes en bas, talons joints et levés.

3. 4. Sauter à la position initiale, en élançant les bras par en haut, -en arrière, -en bas.

VIII—XIV. Continuer l'exercice sur l'autre face en lisant "droite" au lieu de "gauche", et vice versa.

B) BARRE FIXE.

Position initiale: Suspension tendue latérale faciale, prise palmaire gauche, dorsale droite.

1. Élaner en avant, lâcher la main gauche, élaner en arrière et en même temps tourner le corps un demi-tour à gauche, en reprenant avec la main gauche la prise à gauche de la main droite, lever les jambes à la suspension mi-renversée faciale et se basculer à l'appui tendu (face en arrière); et sans arrêt, laisser tomber le corps en arrière, élaner en avant, puis en arrière par la suspension tendue à l'appui tendu et au temps, tourner librement en arrière autour de la barre et sans arrêt, pousser le corps en arrière, élaner en avant, engager le jarret droit à droite de la prise et se basculer par en avant à l'appui tendu et au siège sur la cuisse droite à droite de la prise.

2. Joindre les jambes à l'appui dorsal, en passant la jambe gauche tendue sous la main gauche.

3. Changer la prise et tourner par en avant à la suspension horizontale dorsale.

4. Abaisser à la suspension dorsale; — lâcher la main droite et par un tour à gauche, changer à la suspension faciale (face en avant).

5. En prenant la prise sur les poignets, se lever à l'appui tendu.

6. Balancer en avant, en arrière et en écartant les jambes latéralement, sauter par dessus la barre à la station sur le sol.

C) BARRES PARALLÈLES.

Position initiale; Station tendue jointe devant les barres, pencher le corps un peu en avant, en élançant les bras en arrière en bas.

1. Sauter au bout des barres à la suspension tendue (prise dorsale, — jambes levées en avant), balancer en avant, -en arrière, en levant les jambes à la suspension mi-renversée (position de bascule) et se basculer à l'appui tendu, jambes horizontalement en avant.

Élaner en arrière, en avant, en passant les jambes jointes, du dehors en dedans sous la main gauche et sans arrêt, élaner en arrière, -en avant, en passant les jambes du dehors en dedans, sous la main droite à l'appui tendu, jambes horizontalement en avant.

3. Se lever lentement en arrière à l'appui tendu renversé.
4. Abaisser à l'appui fléchi renversé, élaner en avant par l'appui fléchi à l'appui tendu, en sautellant le plus loin possible, jambes tendues en avant.
5. Abaisser les jambes et se lever lentement par appui horizontal facial, à l'appui d'épaules.
6. Tourner en avant par appui brachial à l'appui tendu, élaner en avant à l'appui brachial mi-renversé (position de bascule) se basculer à l'appui tendu, élaner en arrière, en -avant, en passant jambe gauche sous main droite (d'arrière en avant), puis passer la même jambe sous la main droite d'avant en arrière, joindre les jambes en dehors des barres et au temps, appui de coude droit horizontal.
7. Revenir aux barres, élaner en avant par appui fléchi à l'appui tendu, élaner en arrière à l'appui renversé.
8. Abaisser à l'appui fléchi renversé, élaner en avant et sauteler en tournant en arrière à l'appui fléchi, renversé (petit arrêt); élaner en avant par appui fléchi à l'appui tendu, élaner en arrière et sauter en passant les jambes jointes par dessus les deux barres (d'arrière en avant), à la station sur le sol.

D) CHEVAL-ARÇONS.

Position initiale: Appui tendu latéral facial, prise radiale. Élaner jambe gauche sous main gauche, passer jambe droite sous main droite, sous jambe droite et mains gauche et droite; élaner les jambes jointes sous la main gauche, sous la droite, passer jambe gauche sous la main gauche, élaner le corps à droite, joindre les jambes au-dessus de la croupe, les écarter transversalement, gauche en avant (ciseaux); passer jambe gauche sous la main gauche, jambe droite sous la main droite, jambe gauche sous la main gauche, élaner les jambes jointes sous la main droite, sous la gauche, sous la droite, passer jambe gauche sous la main gauche, élaner le corps à droite, joindre les jambes au-dessus de la croupe, les écarter transversalement, jambe droite en avant (ciseaux) et arrêter à l'appui écarté à droite de la prise. — Élaner jambe droite par dessus la croupe, joindre les jambes et les élaner par dessus arçon gauche et la croupe, pour sauter à la station sur le sol.

E) ANNEAUX.

Position initiale: Suspension latérale faciale, prise radiale.

1. Lever les jambes à la suspension mi-renversée, élaner en avant, -en arrière, -en avant, pour tourner en arrière à l'appui tendu, jambes horizontalement en avant.
2. Abaisser en arrière à la suspension mi-renversée, se basculer à l'appui tendu, et sans arrêt, tourner en avant en force (autour de l'axe de largeur) à l'appui fléchi et au temps, tourner en avant à la suspension mi-renversée, élaner en arrière par la suspension tendue, à l'appui tendu.
3. Lever les jambes horizontalement en avant; en maintenant les jambes tendues en avant, abaisser à la suspension tendue.
4. Fléchir les jambes, tourner en arrière, et étendre jambes et cuisses à la suspension horizontale dorsale.
5. Tourner en avant, jambes et corps tendus à la suspension renversée, élaner en arrière, -en avant et sauter, en tournant en arrière et en passant les jambes écartées latéralement sous la prise, à la station sur le sol.

HUNGARY 10,30—11,30 a.m.

Leader: Bábel Rezső.

The team was 16 men strong:

Aradi Lajos; Berkes Iózsef; Erdödy Imre; Fóti Samu; Gellért Imre; Halmos Gyözö; Hellmich Ottó; Herczeg István; Keresztessy Iózsef; Korponai Iános; Pászthy Elemér; Pédery Arpád; Réti Ienö; Szüts Ferenc; Téry Ódon; Tuli Géza.

Dress: White gymnastic jersey with long sleeves, and with the Hungarian arms on the breast; white trousers; yellow belt; white shoes.

Programme.

FREIÜBUNGEN.

1. Übung.

Rückstellen des linken Beines und Armbeugen zum Stoss (Hände in Faust geballt).

2. 3, 4 Grätschstellung links rückwärts und Armstossen in die Hochhebbhalte (Finger gestreckt).

1. $\frac{1}{4}$ Drehung links (auf beiden Fersen) zur Seitgrätschstellung und Armschwingen zur Seithebbhalte (Speichhalte).

2. 3, 4 Ausfall links seitwärts mit Rumpfeigen links zugleich Armbeugen zum Nacken.

1. $\frac{1}{4}$ Drehung rechts (auf beiden Fersen) und Armschlagen zur Seithebbhalte (Speichhalte links Bein gebeugt, Rumpf nach rückwärts gebeugt).

2. 3, 4 Kniebeugewechsel und Vorneigen des Rumpfes gleichseitig Armschwingen vorwärts in die Schräghochhebbhalte (Arme neben dem Kopf, Speichhalte).

1. $\frac{1}{4}$ Drehung links zur Seitschrittstellung links und linkes Armschwingen durch die Tiefhalte zur Seithebbhalte links, rechtes Armschwingen zur Seithebbhalte rechts (Handfläche nach unten gedreht).

2. 3, 4 Schliessen des linken Beines zur Grundstellung.

2. Übung.

1. Rückstellen des rechten Beines und Armschwingen durch die Vorhebbhalte zur Hochhebbhalte (Speichhalte).

2. 3, 4 Grätschstellung rechts rückwärts und Armschwingen in die Seithebbhalte (Handfläche nach oben).

2. $\frac{1}{4}$ Drehung rechts (auf beiden Fersen) und Armbeugen zu den Schultern (Oberarme wagerecht, Hände in Faust geballt).

2. 3, 4 Ausfall recht seitwärts mit Rumpfeigen rechts und zugleich Schlagen des linken Armes in die Seitschräghochhebbhalte, Schlagen des rechten Armes in die Seitschrägtiefhalte (Handfläche nach unten).

1. $\frac{1}{4}$ Drehung links (auf beide Fersen) Schwingen des linken Armes in die Hochhebbhalte, rechter Arm auf den Rücken gelegt (Speichhalte der linken Hand, rechte Hand in die Faust geballt, rechtes Bein gebeugt, Rumpf nach rückwärts gebeugt).

2. 3, 4 Kniebeugewechsel und Vorneigen des Rumpfes, zugleich linkes Armschwingen in die Tiefhalte und r. Armschwingen in die Hochhebbhalte (Speichhalte).

1. $\frac{1}{4}$ Drehung rechts zur Seitschrittstellung rechts und r. Armschwingen durch die Tiefhalte zur Seithebbhalte rechts, linkes Armschwingen zur Seithebbhalte links (Handfläche nach unten).

2. 3, 4 Schliessen des rechten Beines zur Grundstellung.

3. Übung.

1. Seitspreitzhalte links (Schwebestand auf dem rechten Bein) und Schwingen beider Arme in die Seithebbhalte (Finger gestreckt, Speichhalte).

2. 3, 4 Auslage des linken Beines schräg rechts rückwärts (l. Bein stützt auf den Zehen) und Armbeugen auf den Kopf (Hände in Faust geballt, Handfläche nach vorne gerichtet).

1. $\frac{3}{8}$ Drehung links mit gleichzeitigem Strecken des rechten Beines zur Seitgrätschstellung, Armschwingen durch die Seithebbhalte in die Tiefhalte, Unterarme gekreuzt, l. Arm vorne.

2. 3, 4 Ausfall links seitwärts und Schwingen des linken Armes in die Seithebbhalte links (Speichhalte), Armbeugen rechts (mit Seitschwingen) zum Nacken (Hände in Faust geballt, Kopf nach links gedreht).

1. Strecken des linken Beines zur Seitschrittstellung links und l. Armbeugen auf den Kopf, rechtes Armschlagen in die Seithebbhalte rechts (Speichhalte, Hände in Faust geballt, Kopf nach rechts gedreht).

2. 3, 4 $\frac{1}{8}$ Drehung rechts mit gleichzeitigem Schliessen des linken Beines zum mässigen Kniebeugen, Stossen des linken Armes und Schwingen des rechten Armes in die Hochhebbhalte (Finger gestreckt, Speichhalte).

1. Kniestrecken in den Zehenstand und mässiges Rumpf beugen rückwärts, gleichzeitiges Armschwingen vorwärts in die Tiefhalte (Handfläche nach vorne gerichtet).

2. 3, 4 Grundstellung.

4. Übung.

1. Seitspreitzhalte recht (Schwebestand auf dem linken Bein) und Armschwingen in die Seithebbhalte (Finger gestreckt, Handfläche nach unten).

2. 3, 4 Auslage des rechten Beines schräg links rückwärts (rechtes Bein stützt auf den Lehen) Armbeugen zur Brust (in die Schlaghalte, Handfläche nach unten).

1. $\frac{3}{8}$ Drehung rechts mit gleichzeitigem Strecken des linken Beines in die Seitgrätschstellung und Armstossen in die Hochhebbhalte (Speichhalte).

2. 3, 4 Ausfall rechts seitwärts mit Rumpfeigen rechts, gleichzeitig Beugen des linken Armes mit Ellenbogenheben zur Brust (Hände in Faust geballt, Handfläche nach unten) und Schwingen des rechten Armes in die Seitschrägtiefhalte (Hände in Faust geballt, Handfläche nach oben, Kopf nach rechts gedreht).

1. $\frac{1}{8}$ Drehung links und Strecken des rechten Beines in die Schrägschrittstellung rechts rückwärts, gleichzeitig Armhaltewechsel (l. Arm in die Seithebbhalte links, r. Arm zur Brust gebeugt mit Ellenbogenheben, Hände in Faust geballt, Handfläche nach unten).

2. 3, 4 Schliessen des rechten Beines zum mässigen Kniebeugen und Schwingen der Arme zur Vorhebbhalte (Finger gestreckt, Speichhalte).

1. Kniestrecken in den Zehenstand und Armschwingen in die Hochhebbhalte (Speichhalte).

2. 3, 4 Grundstellung (Schwingen der Arme durch die Seithebbhalte in die Tiefhalte).

KEULENÜBUNGEN.

1. Übung.

Schwingen in die Vorhebbhalte,

Schwingen in die Tiefhalte und darin — mit Nebengriff — äusserer Handkreis vorwärts.

$\frac{1}{2}$ innerer Handkreis vorwärts (Keulen zwischen dem Körper und Armen). Ellenbogen Heben zur Brust (Hände vor der Brust, Ellenbogen nach seitwärts gerichtet, Keulen oberhalb der Unterarme).

5. $\frac{1}{2}$ Unterarmkreis nach innen beginnend in die Seithebbhalte Keulen schwingen hinter die Unterarme.

6. 7. Schnecke auswärts.

8. Endbewegung der Schnecke und $\frac{3}{4}$ Armkreis auswärts in die Hochhebbhalte.

9. I $\frac{1}{4}$ Armkreis auswärts in die Seithebbhalte.

10. Handkreis auswärts vor den Armen.

11. Handkreis auswärts hinter den Armen.

12. $\frac{1}{2}$ Armkreis abwärts beginnend (Arme vor der Brust gekreuzt).

13. $\frac{1}{2}$ Armkreis abwärts beginnend in die Seithebbhalte.

14. Handkreis einwärts vor den Armen.

15. Handkreis einwärts hinter den Armen.

16. $\frac{3}{4}$ Armkreis einwärts in die Seithebbhalte,

17. $\frac{1}{2}$ Drehung links, Schrittstellung links vorwärts und $\frac{1}{2}$ Armkreis des rechten Armes durch die Tiefhalte in die Vorhebbhalte neben den linken Arm.

18. Ausfall links vorwärts mit Rumpfeigen vorwärts und Armschwingen in die Schräge Tief halte rücklings.

19, 20. Pause.

21. Knien auf dem rechten Knie, gleichzeitig Schwingen der Keulen in die Vorhebbhalte und $\frac{1}{2}$ Handkreis rückwärts auf die Unterarme (Handfläche nach oben).

22. Armschwingen in die Seithebbhalte (Handfläche nach oben).

23. 24. Pause.

25. Kniestrecken mit einer $\frac{1}{4}$ Drehung recht; in die Seitgrätschstellung und Armschwingen in die Hochhebblehalte (Keulen hängen neben den Armen).
26. Linkes Kniebeugen und gleichzeitig Rumpfeigen links und Armschwingen in die Seithebblehalte.
27. 28. Pause.
29. Strecken in die Schrittstellung links und Schnecke einwärts in die Seithebblehalte.
30. Schliessen des linken Beines zur Schluss-Stellung und $\frac{3}{4}$ Armkreis auswärts in die Hochhebblehalte.
31. 32. Ausserer Armkreis neben den Schultern in die Tiefhalte.
- 33—64. Dasselbe wieder gleich.

2. Übung.

1. Schwingen der Keulen in die Seithebblehalte.
2. Handkreis auswärts vor den Armen.
3. Mit Nebengriff ein $\frac{1}{2}$ Handkreis abwärts beginnend (Keulen liegen auf der Rückseite der Unterarme).
4. 5. Schnecke auswärts.
6. $\frac{3}{4}$ Armkreis auswärts in die Hochhebblehalte.
7. Linker Handkreis auswärts vor dem Kopfe und gleichzeitig rechter Handkreis auswärts hinter dem Kopfe.
8. Linker Handkreis auswärts hinter dem Kopfe und gleichzeitig rechter Handkreis auswärts vor dem Kopfe.
9. 10. Linker Armkreis auswärts, inzwischen ein Handkreis vorlings in der Tiefhalte gleichzeitig rechter Handkreis auswärts hinter und vor dem Kopfe.
11. 12. Linker Handkreis auswärts hinter und vor dem Kopfe, gleichzeitig rechter Armkreis auswärts, inzwischen ein Handkreis vorlings in der Tiefhalte.
13. $\frac{1}{2}$ Linker Armkreis seitwärts in die Tiefhalte und fortgesetzt ein Handkreis vorlings auswärts, gleichzeitig $\frac{1}{2}$ rechter Armkreis seitwärts in die Tiefhalte und fortgesetzt ein Handkreis rücklings auswärts (hinter dem Körper).
14. 15. Linker Handkreis rücklings auswärts (hinter dem Körper), rechter Handkreis vorlings auswärts und fortsetzend schwingen mit Kreuzen der Arme vor der Brust in die Seithebblehalte.
16. $\frac{1}{2}$ Armkreis durch die Tiefhalte in die Seithebblehalte.
17. Schrittstellung links seitwärts und $\frac{1}{2}$ rechter Armkreis durch die Tiefhalte in die Seithebblehalte links.
18. Ausfall links seitwärts mit Rumpfeigen links und linkes Armbeugen auf den Rücken, rechtes Armkreisen ($\frac{5}{8}$ Kreis) durch die Tiefhalte in die schräge Hochhebblehalte rechts seitlings (Keulen parallel).
19. 20. Pause.
21. Mit Strecken $\frac{1}{4}$ Drehung links (auf beiden Fersen) in die Quergrätschstellung und Schwingen beider Arme durch die Tiefhalte in die Vorhebblehalte.
22. Ausseres Armkreisen rückwärts und Schwingen in die schräge Hochhebblehalte vorling zu gleich rechtes Kniebeugen und mässiges Rumpfeigen rückwärts.
23. 24. Pause.
25. Mit $\frac{1}{4}$ I Drehung rechts (auf beiden Fersen) Strecken in die Seitgrätschstellung und Schwingen in die Hochhebblehalte.
26. Rumpfeigen vorwärts Schwingen beider Arme in die Seithebblehalte, zugleich *Umkippen* der Keulen auf die Unterarme.
27. 28. Pause.
29. Strecken in die Schrittstellung links seitwärts und Schnecke nach innen in die Seithebblehalte.
30. Schliessen des linken Beines in die Schluss-Stellung und $\frac{3}{4}$ Armkreis nach aussen in die Hochhebblehalte.
31. 32. Schwingen in die Tiefhalte inzwischen ein vorderer Handkreis nach aussen in der Seithebblehalte.
- 33—64. Wiedergleich nur beim Takt 26. beziehungsweise 58 anstatt Rumpfeigen ein mässiges Rumpfeigen rückwärts zu machen.

3. Übung.

Rechts um!

1. Rumpfdrehen links und Schwingen in die Seithalte.
2. Handkreis nach aussen vor den Armen.
3. Mit Nebengriff $\frac{1}{3}$ Handkreis abwärts beginnend (Keulen liegen auf der Rückseite des Unterarmes).
4. 5. Rumpfdrehen vorwärts und Schnecke vorwärts.
6. Endbewegung der Schnecke und an der linken Seite $\frac{3}{4}$ Armkreis nach vorne in die Hochhalte.
7. Armkreisen vorwärts an der rechten Seite in die Hochhalte.
8. $\frac{3}{4}$ Armkreis vorwärts (durch die Tiefhalte) in die Seithalte links zugleich $\frac{1}{4}$ Drehung links zum Grätschtanz (*links*).
9. $\frac{3}{4}$ Armkreisen nach links (durch die Tiefhalte) in die Hochhalte.
10. Handkreisen rücklings (hinter dem Kopf) nach links.
11. 12. 13. Armkreisen nach links inzwischen in der Tiefhalte ein Handkreis vorlings und rücklings (vor und hinter dem Körper).
14. $\frac{3}{4}$ Armkreis nach links in die linke Seithalte, zugleich $\frac{1}{2}$ Drehung links mit Rumpfeigen rechts (rechtes Bein gebeugt, die Zehen des linken Beines berühren den Boden, Keulen in ebener Fläche, Kopf nach links gedreht).
15. 16. Pause.
17. Strecken mit $\frac{1}{2}$ Drehung rechts in den Seitgrätschstand und Schwingen durch die Tiefhalte in die linke Seithalte.
18. $\frac{3}{4}$ Armkreis links in die Hochhalte.
19. 20. Kreisen des linken Armes inzwischen ein Handkreis in der Tiefhalte vor dem Körper und rechtes Handgreifen rücklings und vorlings (hinter und vor dem Kopfe) nach innen beginnend.
21. $\frac{1}{4}$ Drehung rechts zur Schrittstellung rechts und $\frac{3}{4}$ Armkreis durch die Tiefhalte in die Vorhebbalte.
22. $\frac{1}{4}$ Drehung rechts mit Rumpfeigen nach links (rechtes Bein gebeugt, die Zehen des rechten Beines berühren den Boden) und rechtes Armschwingen durch die Tiefhalte in die schräge Seithochhalte, linkes Armschwingen in die schräge Seittiefhalte.
23. 24. Pause.
25. Strecken mit $\frac{1}{4}$ Drehung rechts zur Schrittstellung rechts und Schwingen beider Arme (rechter Arm durch die Tiefhalte) in die Vorhebbalte.
26. 27. $\frac{1}{2}$ Drehung links in die Schrittstellung links vorlings und $\frac{1}{2}$ Armkreis durch die Tiefhalte in die Vorhebbalte inzwischen ein beidarmiges Handkreisen rücklings in der Tiefhalte.
28. Ausserhandkreis rückwärts beginnend.
29. $\frac{1}{2}$ Handkreis rückwärts auf die Unterarme (Handfläche nach oben).
30. Schnecke rückwärts in die Hochhalte.
31. 32. Ausserhandkreis vorwärts neben den Schultern in die Tiefhalte.
- 33—64. Wiedergleich.

GERÄTÜBUNGEN.

Zusammengestellt für das Sektionsturnen vom Verbandsturnwart.

Anmerkung: Das in den Übungen vorkommende Zeichen (+) bedeutet eine momentane Unterbrechung, das Zeichen (—) hingegen eine ausdauernde Unterbrechung.

Übungen am Reck:

1. Sprung zum Seithang Ristgriffs —, Heben der gestreckten Beine zur Vorhebbalte —, Durchhocken zum Schwebehang rücklinks —, Strecken zum Abhang rücklings —, Senken zur Hangwage rücklings —, weiteres Senken zum Hang rücklings —, Heben des Körpers bei gebeugten Hüften und Zurückhocken zum Schwebehang vorlings —, Senken der Beine zum gestreckten Seithang vorlings —, Schwungholen und beim zweiten Vorschwung Kippe zum Seitschwebestütz vorlings +, freier Felgüberschwung vorlings rückwärts zum Seithang +, und beim nächsten Vorschwung Mühlaufschwung links vorwärts zwischen den Händen in den Seitsitz

auf dem linken Schenkel —, linke Hand fasst Kammgriff —, rechts Bein schwingt über der Stange hinweg und Absprung mit einer $\frac{1}{4}$ Drehung links zum Querstand links.

2. Sprung zum Seithang Ristgriffs —, Heben der gestreckten Beine zur Vorhebbalte —, Durchhocken zum Schwebehang rücklings —, Strecken zum Abhang rücklings —, Senken zur Hangwage rücklings —, weiteres Senken zum Hang rücklings —, Heben des Körpers bei gebeugten Hüften und Zurtickhocken zum Schwebehang vorlings —, Felgaufzug vorlings rückwärts zum Seitstreckstütz vorlings —, Schwingen zum Seitschwebestütz vorlings +, Unterschwingung zum Hang und Schwungstemme beim Rückschwung zum Seitschwebestütz vorlings —, freier Felgüberschwung zum Seithang +, Felgüberschwung rücklings vorwärts zum Seitstand rücklings.

Übungen am Barren:

1. Aus dem Querstand vorlings am Ende des Barrens (Gesicht nach Innen) Griff an beiden Holmen —, Sprung zum Aussenquersitz links am rechten Schenkel (linkes Bein schwingt in der Holmgasse, rechtes Bein hingegen ausserhalb des rechten Holms) —, Schwingen rückwärts in die Holmgasse mit sofortigem Kreisen links rückwärts (mit Schleifen) zum Schwebestütz +, Abhangkippe zum Schwebestütz +, Schwingen vorwärts mit gebeugten Armen zum Grätschsitz vor den Händen und sofortiges Vorgreifen —, Heben zum Oberarmstand bei gegrätschten Beinen —, Schliessen der Beine —, Überrollen vorwärts zum Oberarmhang, beim nächsten Vorschwingung Oberarmkippe und sofort Wende links zur Kehre (Wende links mit einer $\frac{1}{2}$ Drehung links) in den Ausserquerstand links.

2. Anfang wie bei der ersten Übung, aber gegengleich bis zum Grätschsitz hinter den Händen —, Heben zur Querknickstütz — wäge rechts — $\frac{1}{4}$ Drehung zur Seitknickstützwage —, Heben zum Oberarmstand —, Überrollen vorwärts zum Oberarmhang, Rolle rückwärts zum Oberarmhang, Schwingen vorwärts zum Oberarmschwebestütz +, Schwungholen und beim Rückschwung Schwungstemme zum Querliegestütz vorlings —, Schliessen der Beine und Vorschwingen zum flüchtigen Grätschsitz, Schwingen rückwärts und Kreiskehre recht zum Aussenquerstand links —.

Übungen am Pferd:

1. Mit Griff auf den Pauschen Sprung zum Stütz vorlings +, Vorschwingen links, Kreisen des linken Beines unter der rechten und linken Hand, Einschwingen rechts unter der rechten Hand zur Scheere links in den Seitschwebestütz, rechtes Bein schwingt über dem Rücken zum Seitschwebestütz auf den rechten Arm (über der zweiten Pausche) —, rechtes Bein schwingt über dem Rücken, das linke hingegen unter der linken Hand zum Seitstütz vorlings, Einschwingen des rechten Beines unter der rechten Hand, Gegenscheere rechts zum Seitschwebestütz, Zurtick-schwingen des linken Beines unter der linken Hand zum Seitstütz vorlings, Flankenkreisen einmal unter der rechten und linken Hand, Vorschwingen rechts +, und Doppelkehre rechts zum Querstand links hinter dem Rücken.

2. Grätsche mit Anlauf über das breitgestellte Pferd (ohne Sprungbrett) zur Seitstand rücklings.

GERMANY 11,30—12,30 a.m.

Leader: Univers.- und Oberturnlehrer Dr. Kuhr.

The team consisted of 16 men belonging to the Leipziger Studentenmannschaft.

St. rer. nat. Ergelmann; st. phil. Seebass; st. agr. et chem. Staats; cand. med. Roth; st. rer. nat. Glockauer; cand. jur. Sperling; st. phil. Reichenbach; st. rer. nat. Körner; st. paed. Buder; st. phil. Brülle; st. math. Pahuier; st. jur. Reuschle; cand. phil. Jesinghaus; st. theol. Sorge; st. rer. nat. Rächler; st. rer. nat. Worm; st. rer. nat. Jordan; st. jur. Werner.

Dress: White jersey with broad vertical field on breast and back; long sleeves; white trousers; black belt; yellow shoes.

Programme.

I. AUFMARSCH.

II. RECK.

1. Heben der gegrätschten Beine, durchspreizen des einen Beines, Hangwage, seitliches Aufstemmen zum Streckstütz, Senken rückw. mit Vorhebbalte, Durchhocken rückw. Felgaufzug rücklings, Niedersprung.
2. Knieweilaufschwung r. vorw., $\frac{1}{2}$ Drehung l., Ueberspreizen r, Grätschitzwellumschwung, Unterschwingung.
3. Freier Felgüberschwung Durchschub zum Stand.
4. Kippe zum Stütz, freier Felgüberschwung, Reisenfelgaufschwung, Fallkippe, Flanke.
5. Schwungstemme, freie Felge, Kippe, Fallkippe, Kehre.
6. Reisenfelgaufschwung, freie Felge, Kippe, Ueberspreizen, Fechterwelle zum Stand.
7. Schwungstemme mit sofortigen Unterspreizen, Mühlumschwung rückw. Zurückhocken, Kippe, Hocke.
8. Schwungstemme freier Felgüberschwung, Hangkehre, Kippe, Schraubenwelle Wende.
9. Schwungstemme, freie Felge, Reisenfelgaufschwung, Fallkippe, Felge vorlings vorwärts, Hocke.
10. Kippe, Flanke, Abhang rücklings, Zurückhocken, Kippe, Reisenfelgumschwung zum Stütz, Fallkippe, Grätsche.
11. Kippe, kammgriffs, Sturzwelle zweimal, Reisenhocke.
12. Schwungstemme, Drehschwungstemme mit Uebergreifen, Riesenfelge vorw. Riesengrätsch.
13. Kippe, Einflanke l. Rückfallen, Durchhocken, Kippe, Unterschwingung, Schwungstemme, freie Felge, Durchschwub.
14. Knieweilaufschwung, mit sofortiger $\frac{1}{2}$ Drehung l. und Ueberspreizen r. zum Grätschitz, Grätschwellumschwung rückw., Zurückgrätschen, Kippe, Unterschwingung, $\frac{1}{2}$ Drehung um die Breitenachse beim Vorschwing (Salto).
15. Freier Felgüberschwung, Drehschwungstemme, freier Felgumschwung, Kippe, Handstand, Abhocken.
16. Kippe kammgriffs, Reisenfelgumschwung vorwärts, Griffwechsel, Reisenfelgumschwung rückw. Durchhocken, Kippe rücklings, Abhang rücklings, Zurückhocken, Kippe zum Stütz, Kehre zum Hang, Kippe, Abwerfen rückw. und Unterschwingung rückwärts zum Stand.

III. BARREN.

I. Querstand.

1. Einspreizen l., ausspreizen r., Kehrschwung r. zum Quersitz r., Schraubenspreizen r. vorw. zum Quersitz, Fechterwende.
2. Kehrschwung l. zum Reitsitz l., Schraubenspreizen r. rückwärts zum Quersitz, Wende mit Stütz l.
3. Eingrätschen zum Grätschitz, Schraubenspreizen rückw. mit $\frac{1}{2}$ Drehung, Kreisen r. über l., l. über l., und Kehre mit $\frac{1}{2}$ Drehung nach innen.
4. Ausgrätschen zum Stand, Eingrätschen zum Stütz, Spreizen links über r., Schraubenspreizen r. vorw. zum Grätschitz, $\frac{1}{1}$ Drehg. l. rückw. zum Grätschitz, Spreizen l. über r., und Schraubenspreizen vorw. über beide Holme zum Stand.

II. Querstand.

1. Schwungstemme beim Rückschwung, Spreizen r., über l. und Kehre l.
2. Kippe zum Stütz, Oberarmstand, Rolle vorw. Schwungstemme, Wende l.
3. Schwungstemme beim Vorschwing, Rolle rückw. Kippe, Kreiske re über beide Holme.
4. Ellengriffskippe zum Oberarmhang, Schwungstemme beim Vorschwing, Rolle rückw. zum Stütz, Fallkippe, Rolle vorw. Kippe zum Stütz, Spreizen l. über l., Kreiskehrrschwung l. über r., Handstehen, Wende r.

III. Seitstand.

1. Felgaufschwung rückw., Hocke.
2. Felgüberschwung, Durchschub zum Knieliegehang freier Knieabschwung zum Stand.
3. Felgüberschwung, Knieliegehang r., Knieweilaufschwung rückw. mit $\frac{1}{1}$ Drehg. l. zum Grätschsitz, Kreiskehre vorw. zum Stand.
4. Felgüberschwung, Scheraufschwung zum Grätschsitz, Kreiswende zum Stand.

IV. PFERD.

I.

- 1 u. 2. $\frac{1}{2}$ Rad. r. Einspreizen l., Schraubenspreizen r., vorw. mit $\frac{3}{4}$ Drehung l. zum Querstand; widergleich.
- 3 u. 4. $\frac{1}{2}$ Rad l. Einflanken r. Schraubenspreizen r. vorw. mit $\frac{3}{4}$ Drehung l. zum Querstand; widergleich.
5. Wolfsprung l. Schraubenspreizen r. vorw. mit $\frac{3}{4}$ Drehg. l. zum Querstand.
6. Schraubenspreizen l. rückwärts Schraubenspreizen r. vorw. mit $\frac{3}{4}$ Drehg. l. zum Querstand.
7. Schraubenspreizen l. rückwärts, Vorschwingen zum Schwebestütz, Rückschwingen links zum Stütz rücklgs., Schraubenspreizen vorw. zum Stand.
8. Kreisen links des l. Beines über Hals, Schraubenspreizen l. rückw. Abgang wie 5.

II.

- 9 u. 10 Kreisen l. des r. Beines über Sattel und Kreuz mit $\frac{1}{2}$ Drehg. l. zum Stütz rücklgs. Flanke.
- 11 u. 12 Kreisen des r. Beines über Sattel und Kreuz mit $\frac{1}{2}$ Drehg. l. Kreisen l. Kehre.
13. Kreisen l. des r. Beines über Sattel und Kreuz mit $\frac{1}{2}$ Drehg., l. Kreisen l. des l. Flanke, r. zum Stütz, rückl. Kreisen l. des l. Beines und Wende.
14. Kreisen l. des r. Beines Nachschw. l. zum Stütz rücklgs. Kreise l. des r. Beines und Kehre l.
15. Einspreizen l. auf Sattel, vorschwg. r. rückschw. r., mit $\frac{1}{2}$ Drehg. zum Stütz auf Hals, Einspreizen l. Vorschwg. r. mit $\frac{1}{2}$ Drehg. l., Rückschwung l. zur Flanke, Kehre über Kreuz.
16. Wie 5, aber noch hinter r. Uebergreifen l. auf Vorder r. auf Hinterpausche zur Finte, Kehre über Hals.

III.

Gesellschaftsprünge.

V. SPRUNGTISCH.

VI. EISEN-STABÜBUNGEN.

I. Übung.

Ausfall l. schräg vorw. nach aussen, Stab schräg Vorstossen l., mit Unter- und Schlussgriff l. (Umgreifen der l. Hand zu Untergriff; während des Vorstossens gleitet der Stab durch die l. Hand bis zum Schlussgriff l. bei der r. Hand am r. Stabende; das l. Stabende schliesslich in der Brusthöhe des gedachten Gegners); Blick links schräg vor.

Mit $\frac{1}{4}$ Drehung r. auf den Fersen und Wechselbeugen der Kniee zur Auslagetrittstellung l. schräg vorw. nach aussen, Stab Zurückziehen durch die l. Hand zum Griff der l. Hand am l. Stabende (r. Hand am r. Stabende) und gleichzeitiges Kreisen über die Grundhalte zur Schräghalte (Deckung) an der l. Leibesseite (r. Hand an der l. Schulter, l. Arm schräg an der l. Leibesseite abwärts) Blick l. schräg vor.

Rückbewegung zur vorigen Stellung (die Stabführung beginnt mit Kreisen über r. seitau, alsdann durch die Grundhalte u. s. w.).

Grundstellung.

Wie 1—4, widergleich,

II. Übung.

Ausfall l. schräg vorw. nach aussen, Stab schräg Vorhochstossen l. (zur Kopfhöhe des gedachten Gegners). Mit Unter- und Schlussgriff l., Blick l. schräg vor.

Auslagetritt l. schräg rückw. nach innen, Stab Kreisen durch die Grundhalte (mit gleichzeitigem Durchziehen zu Griff an beiden Enden) und über r. seitwärts zur Schräghalte (Deckung) über dem Kopf l. ab- und vorwärts (r. Arm) gebeugt, r. Hand über den Kopf s. 4. Gruppe.

Rückbewegung zur vorigen Stellung (die Stabführung mit Kreisen über r. seitwärts beginnend).

Grundstellung.

Wie 1—4. widergleich.

III & IV Übung.

Die Übungen 3 und 4 werden in 2 Flankenreihen gleichzeitig widergleich ausgeführt und zwar so, dass in der I Zeit die Turner der 1. Flankenreihe mit dem Ausfall l. seitwärts zur Deckung, in der 5. Zeit die Turner der 2. Flankenreihe mit dem Ausfall r. seitwärts und die Turner der 1. Flankenreihe mit dem Auslagetritt l. seitwärts zur Deckung beginnen.

Abmarsch.

GREAT BRITAIN 2—3 p.m.

Leader: C. J. West.

The team consisted of the following 24 men:

A. E. Betts; H. Dickason; S. Hodgetts; A. W. Messengers; E. E. Pepper; C. A. Vigurs; S. Walker; J. Whitaker; S. Cross; B. W. Franklin; E. W. Potts; K. H. Potts; G. J. Ross; H. Oberholzer; C. Simmons; A. G. H. Southern; R. G. McLean; C. J. Luck; H. J. Drury; W. Mac Kune; W. Titt; W:m Cowhig; L. Hanson.

Dress: White jersey with short arms, and with Gr. Britain's flag on breast; white knickerbockers; red belt; white stockings and shoes.

Programme.

GROUP I.

(*Slow March Time.*)

Starting Position: Position of Attention.

Exercise 1.

Raise L. knee, arms by side of thighs.

Extend L. leg forward (at height of hips).

Step forward downwards (twice the length of own foot).

Swing R. leg backward and hollow the back and raise arms slightly backward (keep upright).

Raise L. knee.

Extend R. leg forward.

Step forward down with R. foot.

Swing L. leg back and hollow the back, trunk upright, and raise arms slightly backward (keep upright).

Repeat L. and R. alternately, thereby travelling four steps forward.

Close R. foot forward up to L. foot with $\frac{1}{2}$ R. turn.

Repeat, travelling in the opposite direction back to starting position.

Exercise 2.

Step L. foot forward (twice its own length) arms horizontally forward, palms inwards.

Fling R. leg backwards and arms sideways (palms down) trunk upright and hollow back.

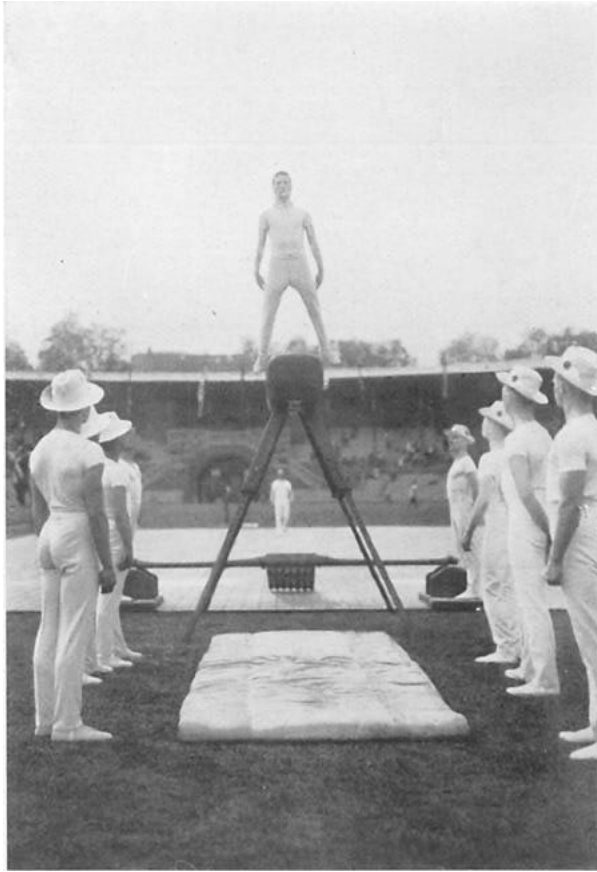

THE NORWEGIAN GYMNASTS IN TEAM COMPETITION III. Straddle-vault over horse from spring-board.



THE DANISH GYMNASTS IN TEAM COMPETITION III. (Parallel bars.)

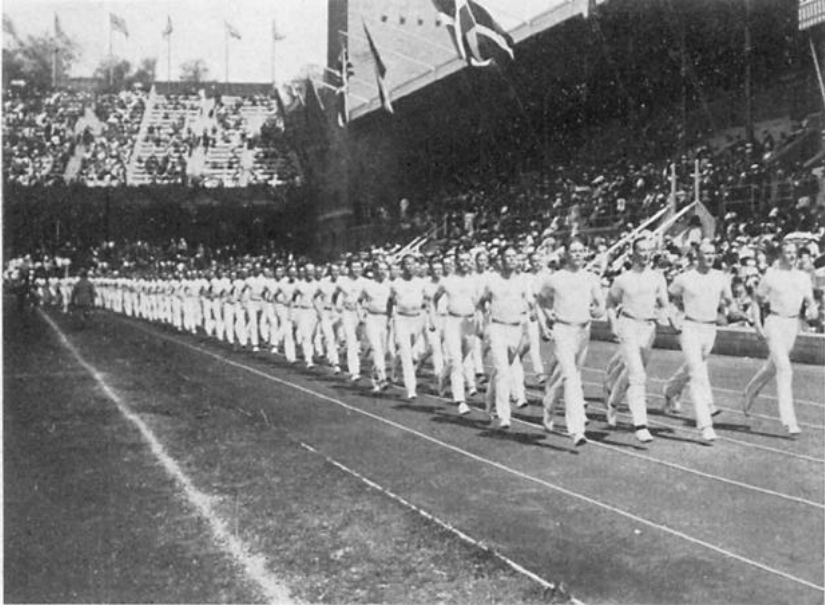

DISPLAY TEAM OF SWEDISH MEN GYMNASTS. March at the double.

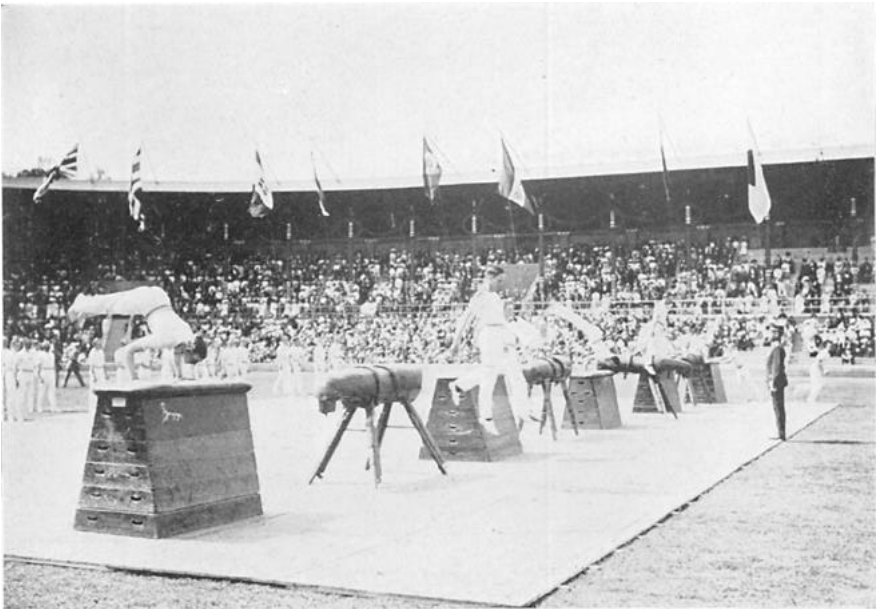

DISPLAY BY SWEDISH GYMNASTS. Various styles of vaulting.



DISPLAY BY SWEDISH GYMNASTS.

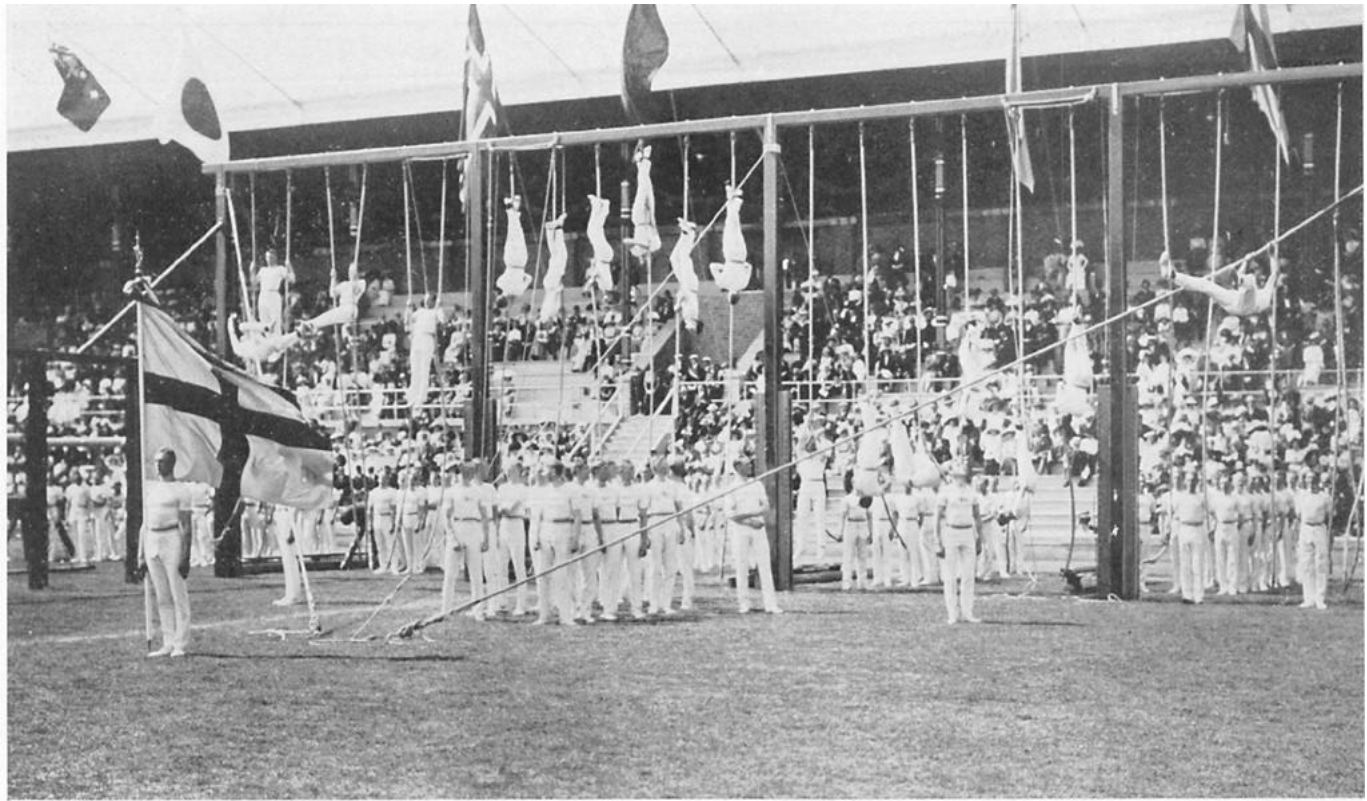

DISPLAY BY SWEDISH GYMNASTS.

- 3 Step R. foot forward down, arms horizontally forward.
- 4 Fling L. leg back and arms sideways.
- 5-7 Repeat L. and R. alternately.
- 8 Join L. to R. foot to attention.
- 9-16 Same backwards, starting to step backwards with R. foot, finishing with joining L. to R. foot.

Exercise 3.

- 1 Step L. foot straight forward (twice its own length) with $\frac{1}{8}$ R. turn on R. heel, arms upward bent.
- 2 Bend knees, squat on R. heel, extend arms upward (palms inwards).
- 3 Rise, step forward with R. foot with $\frac{1}{8}$ R. turn on L. heel, arms upward bent.
- 4 Squat on R. heel, extend arm upwards.
- 5-7 Repeat R. and L. alternately (travelling forward).
- 8 Join L. foot forward to R. foot to attention.
- 9-16 Same exercise backwards, starting to step back with R. foot and instead of extending arms upwards, extend them sideways (palms down) and join R. to L. foot at the finish.

GROUP II. (2—4 time).

Trunk bending and Twisting in combination with alternate knee bending and stretching.

Starting position : Stand astride, arms to height of shoulders—raise.

Exercise 1.

- 1-2 Trunk horizontal, forward bend and to the R. twist, L. arm vertically down and R. arm vertically up in line with each other (palms to the R. and legs straight).
- 3-4 Trunk to the L. twist, R. arm vertically down and L. arm vertically up in line (palms to the L.).
- 5-16 Twist R. and L. alternately.

Exercise 2.

- 1-2 R. knee bend, reach with L. hand to L. foot (instep), R. arm oblique R. upwards in line with L. arm.
- 3-4 Change, bend L. knee, stretch R. knee, reach with R. hand to R. foot, L. arm oblique L. upwards in line with R. arm.
- 5-16 Repeat L. and R. alternately.

Exercise 3.

- 1-2 R. knee bend, L. knee stretch, turn trunk full L., R. arm pointing L. oblique forward, L. arm R. obliquely backward in line (the trunk is in forward bent position, hands closed, palms downwards).
- 3-4 Change over, bend L. knee, stretch R. knee, turn trunk $\frac{1}{4}$ R., L. arm oblique R. forward, R. arm obliquely L. backward in line with each other.
- 5-16 Repeat L. and R. alternately.

Exercise 4.

- 1-2 $\frac{1}{4}$ L. turn on heels, trunk upward stretch, R. knee bend, R. arm upward bend (as if putting the shot), L. arm obliquely forward downwards (hand closed, palm down).
- 3-4 Bend L. knee, stretch R. knee, raise R. heel, stretch L. arm obliquely forward upward (as if putting the shot).
- 5-6 $\frac{1}{2}$ R. turn on heels, bend L. knee, stretch R. knee, L. arm upward bend, R. arm obliquely forward downward.

- 7-8 Bend R. knee, stretch L. knee, raise L. heel, stretch L. arm (as if putting the shot).
 9-16 Repeat R. and L. alternately.

GROUP III. (4-4 time.)

Trunk bending and twisting and rotating.
 Starting position.

- 1-2 Turn front, arms sideways to height of shoulders, palms down.
 3-4 Arms upwards raise.

Exercise 1.

- 1-4 Trunk backward bend (arch flexion).
 5-8 Trunk upwards stretch.
 9-16 Trunk forward downwards bend.
 17-24 Trunk upwards stretch.
 25-28 Trunk backward bend.
 29-32 Trunk upwards stretch and arms to height of shoulders lower (palms down, hands closed).

Exercise 2.

- 1-4 Trunk to the L. twist (arms horizontal).
 5-8 Trunk to the L. bend.
 9-12 Trunk upward stretch and $\frac{1}{2}$ R. rotate (arms horizontal).
 13-16 Trunk R. sideways bend.
 17-20 Trunk upward stretch and $\frac{1}{2}$ L. rotate (arms horizontal).
 21-24 Trunk L. sideward bend.
 25-28 Trunk upward stretch and $\frac{1}{2}$ R. rotate.
 29-30 Trunk to the front turn.
 31-32 Hands in neck rest-place.

Exercise 3.

- 1-4 Trunk horizontal forward bend.
 5-12 Trunk to the L. completely rotate.
 13-20 Trunk to the R. completely rotate.
 21-24 Trunk upward stretch.
 25-28 Feet close L. R., arms sideways downward lower.
 29-32 Mark Time.

GROUP IV.

Deep Breathing Exercise.

8 Movements in 32 Beats.

- 1-4 Raise arms slowly sideways to height of shoulders, lift the chest and inhale through the nostrils.
 5-8 Slowly lower the arms and exhale through the nostrils, sinking the chest and relaxing.
 9-32 Repeat (1-4) and (5-8) alternately.

GROUP V. (4-4 time.)

Balancing Exercises.

24 Movements in 96 Beats.

- 1-4 Raise L. leg forward at height of hips, raise arms forward at height of shoulders (palms inwards).
 5-8 Bend L. knee at right angles and fling arms horizontally sideways (palms downwards).
 9-14 Stretch L. leg backwards and swing arms backward in line with the trunk (palms inward) to front balance.
 15-16 Join L. foot to R. foot and arms down to attention.
 17-32 Same R. side.

Exercise 2.

- 1-4 Raise R. leg sidwards (18 inches off the ground), raise arms sidwards at height of shoulders (palms down).
- 5-8 Bend L. knee at R. angles in front and raise arms upward (palms inward).
- 9-14 Stretch L. leg backward to front balance, L. arm forward, R. arm backward in line with each other (palms inward).
- 15-16 Join L. to R. foot, and arms downward to attention.
- 17-32 Same R. side.

Exercise 3.

- 1-4 Raise L. leg backwards and arms forward upward above head.
- 5-8 Raise L. knee at R. angles and swing arms downward and backward (palms inward).
- 9-14 Stretch L. leg forward downward 6 inches off the ground and raise arms upward above head, incline trunk backwards.
- 15-16 Join L. foot to R. foot and arms forward down to attention.
- 17-32 Same R. side.
Mark time four steps.

GROUP VI. (4-4 time.)

Squatting and Lunging in Combination with trunk bending.
32 Movements in 128 Beats.

Exercise 1.

- 1-8 Squat on heels, raising arms sidwards above head (palms inward).
- 9-12 Lunge L. sidwards trunk in line with the straight leg, arms remain above head.
- 13-16 Squat on L. heel, raise trunk upright, lower arms forward to height of shoulders.
- 17-20 Stretch L. leg, bend R. leg to R. lunging position, swing arms horizontally sidwards (palms down) trunk upright.
- 21-24 Bend trunk slowly L. sidwards, hands in neck rest.
- 25-28 Stretch trunk upright and arms sidwards stretch R. leg and bend L. leg.
- 29-32 Join L. to R. foot and arms down to attention.
- 33-64 Same R. side.

Exercise 2.

- 1-4 With heels raising arms horizontally sidwards raise.
- 5-8 Squat on heels (on first beat) swing arms horizontally forward (palms inward).
- 9-10 Jump on place with $\frac{1}{4}$ L. turn swing arms sidwards (palms forward).
- 11-12 Jump on place with $\frac{1}{4}$ L. turn swing arms horizontally forward (knees remain bent while jumping).
- 13-16 Stretch legs and $\frac{1}{4}$ L. turn on toes of both feet, L. foot turned outwards (45 degrees) R. heel raised swing arms sidwards obliquely downwards palms forward hands closed.
- 17-20 Bend arms upwards on first beat and at once lunge R. foot obliquely R. forward extending R. arm obliquely upwards L. arm obliquely downwards to the rear in line with each other, hands closed (palms outwards).
- 21-24 Bend trunk slowly backwards raising R. heel, raise L. arm forward above head and lower R. arm forward vertically downwards (look upwards). R. knee remains bent, while bending (trunk backwards).
- 25-28 Stretch trunk upwards with arms horizontally sidwards (on the first beat) open hands, palms downwards.
- 29-32 Join R. to L. foot and arms down to attention.
- 33-64 Same the opposite side.
Mark time four steps.

GROUP VII.

Leaning Rest, Abdominal Exercise.

Exercise 1.

- 1-4 Step with L. foot backward to R. lunging position and place hands to ground.
5 R. circle of L. leg with $\frac{1}{4}$ R. turn on R. foot (toes) raising trunk upright while circling the leg.
6 Put L. heel to ground and make $\frac{1}{2}$ R. turn and fall on hands to the front leaning rest, raising R. leg backwards up and bending the arms.
7-8 Remain in this position.
9-12 Squat R. foot between hands and stretch arms (L. leg remains straight).
13 Same as 5.
14 Same as 6.
15-16 Same as 7-8.
17 Lower R. leg. to join L. leg.
18-20 Squat L. foot between hands.
21 L. circle of R. leg with $\frac{1}{4}$ L. turn of the trunk.
22 L. turn, fall on hands to front leaning rest, raising L. leg backwards up and bending arms.
23-24 Remain in this position.
25-28 Squat L. foot between hands.
29-32 Repeat as 21 and 22 and 23-24.

Exercise 2.

- 1-4 From last position in first exercise put L. foot to ground and make $\frac{1}{2}$ R. turn to sitting position, placing hands on hips on 4.
1-8 Slowly lower trunk backward to ground.
9-16 Slowly raise legs above head.
17-24 Slowly lower legs.
25-32 Slowly raise trunk to sitting position.
33-64 Repeat.

To assume position of attention:

$\frac{1}{2}$ L. turn to front leaning rest, squatting R. foot between hands on 1-2, rise to attention joining L. foot to R. on 3-4, marking time from 5-8 placing hands on hips on 5.

GROUP VIII.

- 1-16 Trot on place with knee raising.
17-32 Trot on place with knees straight, with last beat "halt", stretching arms down to attention.

GROUP IX.

Deep Breathing Exercise.

Repeat Group IV.

EXERCISES ON THE APPARATUS.

B. Horizontal steel bar.

The exercises to be executed by three or four men on three or four horizontal bars simultaneously.

Note.—Start the exercise on the L. side of bar.

From the sidehang with ordinary grasp :—

Upstart,

Front circle, fling upwards,

$\frac{1}{2}$ long circle,

Underswing and backs up to front rest, sink to hang (front to bar) with legs in half lever,
 $\frac{1}{2}$ R. turn on R. arm, releasing L. hand to hang with reversed grasp on opposite side of bar,
 Slow circle to front rest, overthrow to hang with reverse grasp, Back Up to front rest, front rest, front vault R. to cross stand.

Horizontal bar. (Slow.)

Exercise 2.

From the sidehang with ordinary grasp,
 Raise legs to $\frac{1}{2}$ lever, rise to Rest,
 Turn over forward to inverse hang with straight body,
 Thighs to bar lower to front lever,
 Squat to Rear to inverse hang with straight body,
 Thighs to bar, lower to back lever,
 Lower to Back Hang, return with bent body,
 Squat to front, insteps to bar, circle to rest,
 Flank vault L.

C. Parallel bars.

The exercises to be executed by three or four men simultaneously on three or four parallel bars.

Exercise 1.

At end of bars facing inwards: short underswing upstart swing back to double Shoulder-stand,
 Roll over with straight body to upper arm hang,
 Swing forward, upper arm upstart to indicate handstand,
 Pump forward and travel forward to rest with legs in $\frac{1}{2}$ lever,
 $\frac{1}{4}$ R. turn to rest on R. bar with legs in $\frac{1}{2}$ lever,
 $\frac{1}{4}$ R. turn to rest in between bars with legs in $\frac{1}{2}$ lever, cross seat on R. bar,
 R. elbow lever,
 Lift to R. Shoulder stand,
 Swing down and forward, and upper arm upstart,
 Swing back to front leaning rest,
 Swing forward and backward and double rear vault R.

Exercise 2. (Slow.)

In centre of bars-jump to upper arm hang,
 Raise legs to $\frac{1}{2}$ lever,
 Pull in and rise to rest with legs in $\frac{1}{2}$ lever,
 Open legs to straddle seat,
 Place hands in front and lift to handstand,
 Lower to double shoulder stand, place hands to rear, thumbs underneath with arms straight,
 Lower to level lever towards the arms,
 Lower to upper-arm-hang,
 Place hands to front, raise legs and roll backwards to double shoulder stand,
 Lower legs and stretch arms to rest,
 Raise legs to $\frac{1}{2}$ lever,
 Place L. leg on R. bar in front of R. hand,
 Circle R. leg backwards on to R. bar, with $\frac{3}{4}$ L. turn to front leaning rest across bars,
 Squat over both bars to sidestand with arms sideways when alighting.

D. Horse. (Pommelled.)

The exercises to be executed by three or four men simultaneously on three or four horses.

Exercise 1.

R. circle of R. leg, R. circle of both legs,
 $\frac{1}{2}$ R. circle of L. leg, complete L. circle of R. leg,
Feint R. leg over croup to rest astride R. arm,
 $\frac{1}{2}$ L. circle of L. leg, backshears R. into saddle,
 $\frac{1}{2}$ L. circle of L. leg, $\frac{1}{2}$ L. circle of R. leg,
 $\frac{1}{2}$ R. circle of L. leg and screw mount R. to riding seat on croup, place both hands on neck pommel rear vault R. over neck to cross stand on offside.

Exercise 2.

Same exercise the opposite side.

VOLUNTARY EXERCISE.

E. Rings.

The exercise to be executed by three or four men simultaneously on three or four pairs of rings.

From the hang:—

Raise legs slowly to inverse hang with bent hips,
Back upstart to rest,
Raise legs to $\frac{1}{2}$ lever,
Lift to bent arm handstand lower legs to front lever above rings,
Slow circle backward to back lever,
Lower legs to back hang,
Swing backward and turn over forward with straight body to indicate front lever below rings,
Swing back in bent arm rest,
Swing forward and back circle to rest,
Sink to bent arms hang,
Stretch and bend L. and R. arm alternately,
Stretch arm to rest,
Lower to indicate crucifixion and drop to ground.

ITALY kl. 3—4 p. m.

The team consisted of the following 16 men:

Guido Boni ; Guiseppe Domenichelli ; Luciano Savorini ; Guido Romano ; Angelo Zorzi ; Giorgio Zampori ; Giovanni Mangiante ; Lorenzo Mangiante ; Adolfo Tunesi ; Pietro Bianchi ; Paolo Salvi ; Alberto Braglia ; Alfredo Gollini ; Serafino Mazzarochi ; Francesco Loy ; Carlo Fregosi.

Dress: White jersey with sleeves to elbows ; black stockinet pantaloons with straps; black soft shoes.

Programme.

DESCRIPTION DES EXERCICES.

Premier groupe.

Premier exercice

- I. 1. Élaner les bras, par en avant, en haut; mains ouvertes (paumes en dedans).
- I. 2-3-4. Fléchir les bras ; mains fermées (ongles en dedans).
- II. 1-2-3-4. Poser à fond, du pied gauche, en arrière (écartement moyen); en teédant les bras en haut; mains ouvertes (paumes en dedans).
- III. 1-2. Joindre jambe gauche en écartant les bras latéralement (paumes en bas)

III. 3-4. Quart de tour à gauche, sur le talon droit, et poser à fond du pied gauche, en-arrière, en élançant les bras, par en bas et en avant, en haut (paumes en dedans).

IV. 1-2-3-4. Quart de tour à droite, sur le talon droit, et joindre la jambe gauche en abaissant les bras, par en dehors, en bas, à la position initiale.

V—VIII. Reprendre l'exercice en partant du pied droit pour tourner à droite au 3^e temps de la III^e mesure.

Deuxième exercice.

I. 1. Écarter les bras latéralement; mains ouvertes (paumes en dedans).

I. 2-3-4. Fléchir les bras; mains fermées (ongles en avant).

II. 1-2-3-4. Poser à fond, du pied gauche, à gauche (écartement moyen) en étendant les bras latéralement en dehors; mains ouvertes (paumes en bas).

III. 1-2. Joindre la jambe gauche en élançant les bras, par en avant et en haut (paumes en dedans).

III. 3-4. Quart de tour à gauche, et poser à fond du pied gauche, à gauche, en écartant les bras latéralement (paumes en bas).

IV. 1-2-3-4. Quart de tour à droite, sur le talon droit, et joindre la jambe gauche en abaissant les bras en bas, à la position initiale.

V—VIII. Reprendre l'exercice en partant du pied droit pour tourner à droite au 3^e temps de la III^e mesure.

Troisième exercice.

I. 1. Élaner les bras, par en avant, -en dehors, -en haut; mains ouvertes (paumes en haut).

I. 2-3-4. Fléchir les bras; mains fermées (ongles en dedans).

II. 1-2-3-4. Poser à fond du pied gauche en avant (écartement moyen), en étendant les bras obliquement en dehors, -en haut; mains ouvertes (paumes en haut).

III. 1-2. Joindre la jambe gauche en élançant les bras, par en avant, -en arrière -en bas (paumes en dedans).

III. 3-4. Quart de tour à gauche, en élançant les bras obliquement en dehors, -en haut (paumes en haut) à fond gauche en avant.

IV. 1-2-3-4. Quart de tour à droite sur le talon droit et joindre la jambe gauche, en abaissant les bras, par en dehors, -en bas, à la position initiale.

V—VIII. Reprendre l'exercice en partant du pied droit, pour tourner à droite au 3^e temps de la III^e mesure.

Deuxième groupe.

Premier exercice.

I. 1. Fléchir les bras; mains fermées (ongles en dedans).

I. 2-3-4. Poser à fond, du pied gauche, en arrière, en étendant les bras en haut; mains ouvertes (paumes en dedans).

II. 1-2-3-4. Par un quart de tour à gauche, en pivotant sur les talons, changer au à l'à fond latéral (jambe droite reste fléchie), et écarter les bras latéralement (paumes en bas).

III. 1-2. Quart de tour à droite, sur le talon droit; joindre la jambe gauche en élançant les bras, par en bas et en avant, -en haut (paumes en dedans).

III. 3-4. Demi-tour à gauche, sur le talon droit, et poser à fond, du pied gauche, en arrière, en faisant tourner une fois les bras (cercle) en arrière.

IV. 1-2-3-4. Demi-tour à droite, sur le talon droit et joindre la jambe gauche, en abaissant les bras, par en dehors, -en bas à la position initiale.

V-VIII. Reprendre l'exercice, en partant du pied droit.

Deuxième exercice.

I. 1. Fléchir les bras; mains fermées (ongles en avant).

I. 2-3-4. Poser à fond, du pied gauche, à gauche, en étendant les bras latéralement en dehors; mains ouvertes (paumes en bas).

II. 1-2-3-4. Par quart de tour à gauche, en pivotant sur les talons, changer au à l'à fond en arrière (jambe droite reste fléchie) et élaner les bras, par en bas et en avant, -en haut (paumes en dedans).

III. 1-2. Quart de tour à droite, sur le talon droit, et joindre la jambe gauche, en écartant les bras latéralement (paumes en bas).

IV. 3-4. Demi-tour à gauche, sur le talon droit, et poser à fond du pied gauche, à gauche, en faisant tourner les bras une fois (cercle) par en bas en dedans).

IV. 1-2-3-4. Demi-tour à droite, sur le talon droit, et joindre la jambe gauche, en abaissant les bras, à la position initiale.

V—VIII. Reprendre l'exercice en partant du pied droit.

Troisième exercice.

I. I. Fléchir les bras; mains fermées (ongles en dedans).

I. 2-3-4. Poser à fond, du pied gauche, en avant, en étendant les bras obliquement en dehors, -en haut; mains ouvertes (paumes en haut).

II. 1-2-3-4. Quart de tour à gauche, sur le talon droit, et poser à fond, du pied gauche, en arrière, en élançant les bras, par en avant, -en arrière, -en bas (paumes en dedans).

III. 1-2. Quart de tour à droite, sur le talon droit, et joindre la jambe gauche, en élançant les bras obliquement en dehors, -en haut, en passant par en bas, -en avant et -en haut (paumes en haut).

III. 3-4. Demi-tour à gauche, sur le talon droit, et poser à fond du pied gauche, en avant, en faisant tourner les bras (cercle) en arrière, -en bas, -en avant et -en haut pour revenir à la position oblique en dehors -en haut (paumes en haut).

IV. 1-2-3-4. Demi-tour à droite, sur le talon droit, et joindre la jambe gauche en abaissant les bras, par en dehors, en bas à la position initiale.

V—VIII. Reprendre l'exercice en partant du pied droit.

BARRES PARALLÈLES.

Premier Degré.

Position initiale: Station transversale à l'entrée des barres.

Attention. — Saisir les barres.

1. Sauter à l'appui tendue en lançant la jambe gauche tendue par-dessus la barre gauche du dehors en dedans; balancer en arrière, -en avant, sortir la jambe droite tendue par-dessus la barre gauche, du dedans en dehors à la station (sans arrêt), sauter à l'appui tendu en lançant la jambe droite tendue par-dessus la barre droite du dehors en dedans, balancer en arrière, -en avant, sortir la jambe gauche tendue par-dessus la barre droite du dedans en dehors, passer les jambes jointes par dessus la barre gauche du dehors, en dedans, siège écarté devant les mains.

2. Changer la prise, mains devant, joindre les jambes, rouleau en avant sur les épaules, corps tendu, balancer en arrière, -en avant bascule à l'appui tendu, balancer en arrière, -en avant, appui renversé sur les épaules.

3. Abaisser lentement le corps tendu en arrière avec extension des bras, en passant par l'appui horizontal, balancer en avant, jambes jointes au siège sur la barre gauche, bras gauche tendu horizontalement à gauche.

4. Quart de tour à droite, en déplaçant main gauche sur la barre droite changer à l'appui latéral sur la barre droite, avec impulsion des cuisses, en passant les jambes jointes à gauche par-dessus les barres, à la station latérale, le dos vers la barre droite.

Deuxième Degré.

Attention. — Saisir les barres à l'extrémité.

1. — Sauter à l'appui tendu en lançant la jambe gauche tendue par-dessus la barre gauche du dehors en dedans, sortir la jambe droite tendue par-dessus la barre gauche du dedans en dehors, passer les jambes jointes par-dessus la barre gauche du dehors en dedans, siège écarté devant les mains.

2. — Joindre les jambes, balancer en arrière à la station et sans arrêt sauter à l'appui tendu en lançant la jambe droite tendue par-dessus la barre droite de dehors en dedans, sortir la jambe gauche tendue par-dessus la barre droite du dedans en dehors, passer les jambes jointes par-dessus la barre gauche du dehors en dedans, siège écarté devant les mains.

3. — Changer la prise, mains devant, rouleau en avant sur les épaules, corps tendu, balancer en arrière à l'appui tendu, balancer en avant, -en arrière à l'appui tendu renversé.

4. — Abaisser lentement le *corps* tendu en arrière à l'appui horizontal, en passant par l'appui tendu jambes à l'équerre, tomber en arrière à la suspension tendue, jambes à la position de bascule, bascule à l'appui tendu, balancer en arrière, -en avant, poser la jambe droite par en avant sur la barre gauche, et par quart de tour à droite, réunir jambe gauche à la droite, en déplaçant main gauche sur la barre droite, impulsion des cuisses, en passant les jambes jointes à gauche par-dessus les barres, à la station latérale, main gauche à la barre droite. —

Troisième Degré.

Attention. — Saisir les barres à l'extrémité.

1. — Sauter à l'appui tendu en lançant la jambe gauche tendue par-dessus la barre gauche du dehors en dedans et sortir la jambe droite tendue par-dessus la barre gauche du dedans en dehors, passer les jambes jointes par-dessus la barre droite du dehors en dedans, à l'appui tendu jambes à l'équerre.

2. — Passer la jambe droite tendue par-dessus la barre droite du dehors en dedans et sortir la jambe gauche tendue par-dessus la barre droite du dedans en dehors, passer les jambes jointes par-dessus la barre gauche du dehors en dedans, siège écarté devant les mains.

3. — Changer la prise, mains devant, joindre les jambes, rouleau en avant sur les épaules, corps tendu, balancer en arrière à l'appui tendu, sans arrêt, avec sursaut tomber à la suspension tendue, jambes à la position de bascule, bascule à l'appui tendu, porter le corps tendu à la position horizontale latérale droite sur le coude droit; rentrer dans les barres et se lever à l'appui tendu renversé.

4. — Abaisser lentement le corps tendu en arrière à l'appui horizontal, en passant par l'appui tendu jambes à l'équerre, tomber en arrière à la suspension tendue, jambes à la position de bascule et sans arrêt, basculer en arrière à l'appui sur les aisselles (bascule dorsale), balancer en avant à l'appui brachial à la position de bascule, balancer en arrière -en avant, poser la jambe droite, tendue par en avant sur la barre gauche, et par quart de tour à droite, réunir jambe gauche à la droite, en déplaçant main gauche sur la barre droite changer à l'appui latéral sur la barre droite, impulsion des cuisses, en passant les jambes écartées latéralement par-dessus les barres, sauter en avant à la station latérale, le dos vers la barre droite.

BARRE FIXE (RECK.).

Premier Degré.

Attention. — Bras en arrière, tête levée, regard vers la barre.

1. — Suspension tendue, monter à l'appui sur le bras droit fléchi, puis sur le gauche, étendre les bras à l'appui tendu.

2. — Lancer le corps tendu en arrière à la suspension tendue, balancer en avant et s'établir par renversement corps tendu à l'appui tendu et tourner en arrière à l'appui tendu facial (demi-tour en arrière autour de la barre).

3. — Prise palmaire, lancer le corps tendu en haut, en avant, balancer en arrière et par renversement en arrière se lever à l'appui tendu (demi-tour en avant autour de la barre).

4. — Prise dorsale, balancer sensiblement les jambes en avant, en arrière et passant les jambes par-dessus et entre les bras, sauter en avant à la station, le dos vers la barre.

Deuxième Degré.

Attention. — Bras en arrière, tête levée, regard vers la barre.

1. — Suspension tendue, puis temp de reins à l'appui tendu.

2. — Tourner en avant à la suspension faciale mi-renversée, bras tendus, jambes tendues et pointes des pieds à la barre, passer les jambes groupées sous la barre et les étendre à la suspension horizontale dorsale.

3. — Tourner à la suspension dorsale mi-renversée, monter par traction des bras simultanément à l'appui dorsal (siège).
4. — Demi-tour à gauche à l'appui tendu facial en se déplaçant à gauche.
5. — Lancer le corps tendu en haut presque à l'appui tendu renversé, déplacer la main droite à gauche (croisant) et par demi-tour à gauche, changeant main gauche à la prise palmaire, s'établir à l'appui, balancer sensiblement les jambes en avant -en arrière, élaner le corps tendu en avant, par l'appui renversé passager, tourner une fois autour de la barre (en prise palmaire) par un second tour dorsal à gauche par -dessus la barre, corps tendu, sauter à la station costale droite.

Troisième Degré.

Attention. — Bras en arrière, tête levée, regard vers la barre.

1. — Suspension tendue, monter lentement par traction simultanée des bras à l'appui tendu facial.
2. — Tourner en avant, à la suspension horizontale faciale.
3. — Groupier vivement les jambes, les passer sous la barre, les étendre vivement à la suspension dorsale horizontale.
4. — Tourner le corps tendu sur le bras gauche, monter à l'appui sur le bras droit en changeant la prise, demi-tour à droite quittant la prise gauche et en déplaçant la main gauche par-dessus la barre, à l'appui tendu facial (au côté opposé de la barre).
5. — Lancer le corps en haut tendu, presque à l'appui tendu renversé, tourner deux fois en arrière autour de la barre (en prise dorsale) en complétant le deuxième tour, déplacer la main droite à gauche (croisant) et par demi-tour à droite en changeant main gauche à la prise palmaire, tourner en avant une fois autour de la barre et par un deuxième tour en avant, passer les jambes, écartées latéralement par-dessus la barre, sauter en avant à la station, le dos vers la barre.

CHEVAL-ARÇONS.

Premier Degré.

Attention. — Prise radiale aux argons, en passant les bras par dehors.

1. — Passer jambe gauche sous la main gauche, ciseaux en avant à droite, passer jambe gauche sous la main gauche, passer jambe droite sous la main droite, ciseaux en arrière à gauche, passer jambe droite à droite, balancer jambe gauche en dehors à gauche.
2. — Réunir jambe gauche, passer jambe droite sous la main droite, ciseaux en avant à gauche, passer jambe droite sous la main droite, passer jambe gauche sous la main gauche, ciseaux en arrière à droite, passer jambe gauche sous la main gauche, passer jambe droite sous la main droite et repasser jambe droite sous la main droite en la réunissant à jambe gauche, dorsale à droite en passant par-dessus le cou et la croupe à la station costale gauche, main gauche à la croupe.

Deuxième Degré.

Attention. — Prise radiale aux arçons, en passant les bras par dehors.

1. — Cercle des jambes jointes sous la main gauche, droite et gauche, passer jambe droite sous la main droite, ciseaux en arrière à gauche, passer la jambe droite sous la main droite, passer jambe gauche sous la main gauche, ciseaux en avant à droite, passer jambe droite sous la main droite, cercle des jambes jointes sous la main gauche et droite, balancer jambe gauche en dehors à gauche.
2. — Réunir jambe gauche, cercle des jambes jointes sous la main droite, gauche et droite, passer jambe gauche sous la main gauche, ciseaux en avant à droite, passer jambe gauche sous la main gauche, passer jambe droite sous la main droite, ciseaux en arrière à gauche, passer jambe droite sous la main droite, cercle des jambes jointes sous la main gauche, droite et gauche, et par demi-tour à droite en tournant sur le bras droit, passer jambes jointes par-dessus la croupe, poser main gauche sur la croupe, passer jambes jointes sous la main droite (par-dessus les argons) à la station costale gauche, main gauche sur la croupe.

Troisième Degré.

Attention. — Prise radiale aux argons, en passant les bras par dehors.

1. — Cercle des jambes jointes sous la main gauche, droite, gauche, droite passer jambe gauche sous la main gauche, ciseaux en avant à droite, passer jambe gauche sous la main gauche, passer jambe droite sous la main droite, ciseaux en arrière à gauche, passer jambe droite sous la main droite, cercle des jambes jointes sous la main gauche, droite, balancer jambe gauche en dehors à gauche.

2. — Réunir jambe gauche, cercle des jambes jointes sous la main droite, gauche, droite et gauche, passer jambe droite sous la main droite, ciseaux en avant à gauche, passer jambe droite sous la main droite, passer jambe gauche sous la main gauche, cercle des jambes jointes sous la main droite, gauche, droite, passer jambe gauche sous la main gauche, passer jambe droite sous la main droite, cercle des jambes jointes sous la main gauche, droite, gauche et par demi-tour à droite, en tournant sur le bras droit, passer jambes jointes par-dessus la croupe, poser main gauche sur la croupe, passer jambes jointes par-dessus l'argon droit, et par demi-tour à gauche, à la station costale droite, main droite sur la croupe.

ANNEAUX.

Premier Degré.

Attention. — Bras en arrière, tête levée, regard vers les anneaux.

1. — Suspension tendue, renversement en arrière (jambes avec un peu d'équerre) à l'appui fléchi.

2. — Continuer le renversement en arrière à la suspension mi-renversée.

3. — Élaner les jambes en avant, balancer en arrière, dislocation, balancer en avant à la suspension mi-renversée.

4. — Élaner les jambes en avant, balancer en arrière à l'appui fléchi.

5. — Appui tendu, jambes à l'équerre, monter corps tendu à l'appui fléchi renversé.

6. — Abaisser le corps en étendant les bras à l'appui tendu, tomber en arrière à la suspension mi-renversée, élaner les jambes en avant, balancer en arrière, -en avant, tourner en arrière, corps tendu et, en quittant les anneaux, sauter à la station.

Deuxième Degré.

Attention. — Bras en arrière, tête levée, regard vers les anneaux.

1. — Suspension tendue, renversement en arrière (jambes avec un peu d'équerre) à l'appui tendu.

2. — Jambes à l'équerre, continuer le renversement en arrière à la suspension mi-renversée, étendre vivement le corps à la suspension dorsale horizontale.

3. — Retourner à la suspension mi-renversée.

4. — Élaner en avant, balancer en arrière, dislocation, balancer en avant à la suspension mi-renversée et, sans arrêt, élaner en avant, balancer en arrière à l'appui tendu, jambes à l'équerre.

5. — Monter à l'appui tendu renversé.

6. — Abaisser lentement le corps tendu à l'appui tendu, sans arrêt, renversement en arrière corps tendu à la suspension tendue renversée; abaisser le corps tendu en avant à la suspension faciale horizontale, balancer en arrière, -en avant, tourner en arrière, corps cambré et en quittant les anneaux, sauter à la station.

Troisième Degré.

Attention. — Bras en arrière, tête levée, regard vers les anneaux.

1. — Suspension tendue, renverser lentement en arrière le corps presque tendu à l'appui tendu et, sans arrêt étendre les bras de côté (la croix).

2. — Descendre lentement à la suspension dorsale; en passant lentement par la suspension dorsale horizontale, élever le corps tendu à la suspension tendue renversée.

3. — Suspension mi-renversée, élaner les jambes en avant, balancer en arrière dislocation à la suspension dorsale horizontale.

4. — Suspension mi-renversée, élaner les jambes en avant, balancer en arrière, -en avant et par renversement tourner en arrière à l'appui tendu renversé.

5. — Abaisser lentement le corps à l'appui horizontal, continuer à descendre lentement en arrière à la suspension faciale horizontale.

6. — Élaner en arrière, balancer en avant, tourner en arrière, corps cambré, jambes écartées par-dessus les bras et, en quittant les anneaux, sauter à la station.

Result: I. prize ITALY..... 53.15 points.
 II. » HUNGARY..... 45.45 »
 III. » GREAT BRITAIN... 36.90 »

GENERAL PROTOCOL.

II. Team Competition according to special conditions.

		Points awarded by				
		Clod-Hansen	Tifi	Syson	Wagner	Bély
<i>Luxemburg:</i>						
A. Free	Carriage	I	0.75	0.25	0	0.50
	Execution	9	7	2	6	6
B. Hor. Bar	To apparatus.....	I	0.50	0.25	0	I
	Execution	9	6.50	3.25	6	4
	From apparatus...	I	0.25	0.25	0	I
C. Par. Bars	To apparatus.....	0.75	0.50	0.25	I	I
	Execution	8	7	4.75	6	3
	From apparatus...	I	0.75	0.25	I	I
D. Horse	To apparatus.....	0.75	0.75	0.25	I	I
	Execution	9	5	4	8	4
	From apparatus...	I	0.75	0.25	I	I
E. Free	Execution	9	7	6.25	8	9
Total points		50.50	36.75	22	38	32.50
179.75 : 5 Average points 35.95						
<i>Hungary:</i>						
A. Free	Carriage	0.75	I.50	I	I	2
	Execution	7.75	9	6.75	9	10
B. Hor. Bar	To apparatus	0.25	0.75	0.50	I	I
	Execution	3	8	6.50	8	8.50
	From apparatus...	I	0.75	0.50	I	I
C. Par. Bars	To apparatus.....	0.75	0.75	0.50	I	I
	Execution	5	7	7.25	9	8
	From apparatus...	0.75	0.75	0.50	I	I
D. Horse	To apparatus.....	I	0.75	0.50	I	I
	Execution	9	6	6.75	9	10
	From apparatus...	I	0.75	0.25	I	I
E. Free	Execution	7	8	8.50	10	10
Total points		37.25	44	39.50	52	54.50
227.25 : 5 Average points 45.45 (II)						

		Points awarded by				
		Clod-Hansen	Tifi	Syson	Wagner	Bély
		<i>Germany:</i>				
A. Free	Carriage	1	1.25	0.75	1	0.75
	Execution	7	6	5	7	4
B. Hor. Bar	To apparatus	0.25	0.50	0.50	1	0.75
	Execution	7	5	5.50	9	3.50
	From apparatus	0.25	0.50	0.25	1	0.75
C. Par. Bars	To apparatus	0.25	0.50	0.50	1	0.75
	Execution	7	4	6	8	3.25
	From apparatus	0.50	0.50	0.50	1	0.75
D. Horse	To apparatus	0.25	0.50	0.25	1	0.50
	Execution	5	4	5.25	8	3
	From apparatus	0.25	0.50	0.50	1	0.50
E. Free	Execution	4	4	5.25	10	4.25
Total points		32.75	27.25	30.25	49	22.75
		162 : 5 Average points 32.40				
		<i>Great Britain.</i>				
A. Free	Carriage	1	1.25	1	1	1.25
	Execution	9	7	6.50	8	5
B. Hor. Bar	To apparatus	1	0.50	0.25	1	0.75
	Execution	9	5	5.25	8	5.50
	From apparatus	1	0.50	0.75	1	0.75
C. Par. Bars	To apparatus	1	0.50	0.25	1	0.75
	Execution	8	5	6.50	7.50	5
	From apparatus	1	0.75	0.75	1	0.75
D. Horse	To apparatus	1	0.75	0.50	1	0.75
	Execution	8.50	5	7.50	7	3.50
	From apparatus	1	0.50	0.75	0.50	0.75
E. Free	Execution	6	4	5	6	3.50
Total points		47.50	30.75	35	43	28.25
		184.50 : 5 Average points 36.90 (III)				
		<i>Italy:</i>				
A. Free	Carriage	1.75	2	1.50	1	2
	Execution	9	9.50	8	8	9
B. Hor. Bar	To apparatus	1	1	0.75	1	1
	Execution	9.50	9.50	8.25	9.50	8.25
	From apparatus	1	1	1	0.50	1
C. Par. Bars	To apparatus	1	1	1	0.50	1
	Execution	10	9.50	8.75	9.50	9.25
	From apparatus	1	0.75	1	0.50	1
D. Horse	To apparatus	1	1	1	1	1
	Execution	9.75	9.50	7.25	10	9
	From apparatus	1	1	1	1	1
E. Free	Execution	10	10	8.50	10	10
Total points		56	55.75	48	52.50	53.50
		265.75 : 5 Average points 53.15 (I)				

Stockholm, 11 July, 1912.

CESARE TIFI. A. E. SYSON. ABR. CLOD-HANSEN.
DR. MED. WAGNER-HOHENLOBBESE. MICHAEL BÉLY.

Confirmed: EINAR NERMAN, Chief Leader.

TEAM COMPETITION III.

Wednesday, 10 July.

This competition took place on July 10 between 9.30 a.m.—12.30 p.m. and 2—4 p.m.

Judges:

Dr. J. F. Allum, Norway.
Dr. A. Clod-Hansen, Denmark,
Captain A. E. Syson, Great Britain,
Dr. Wagner-Hohenlobbese, Germany,
Dr. Ivar Wilskman, Finland.

GERMANY 9.30—10.30 a.m.

Leader: Univers.- und Oberturnlehrer Dr. Kuhr.

The team consisted of the following 16 members of the Leipziger Studentenmannschaft:

St. rer. nat. Eugelman; st. phil. Seebass; st. agr. et Chem. Staats; cand. med. Roth; st. rer. nat. Glockauer; cand. jur. Sperling; st. phil. Reichenbach; st. rer. nat. Körner; st. paed. Buder; st. phil. Brülle; st. math. Pahuer; st. jur. Reuschle; cand. phil. Jesinghaus; st. theol. Sorge; st. rer. nat. Richler; st. rer. nat. Worm; st. rer. nat. Jordan; st. jur. Werner.

Dress: White jersey with broad, vertical, red field on breast and back; long sleeves; white trousers; black belt; yellow shoes.

Programme.

I. FREIÜBUNGEN.

1.

1. Rückstellen I. Rückschwingen der Arme.
2. Schrittsprung vorw. zur tiefen Kniebeuge mit Vorschwingen der Arme.
3. Heben zum Zehenstand und Vorhochschwingen.
4. Grundstellung und Vortiefschwingen.

2.

1. Stellung I. 3.
2. Rückschrittstellung I. hinter r. mit Kniebeugen r. und $\frac{3}{4}$ Armkreisen zur Seithalte r.
3. Rückbewegung.
4. Grundstellung.

3.

1. Stellung II. 2.
2. $\frac{5}{4}$ Armkreis l. Ausfall l. seitw. und Rumpfbeugen l. seitw.
3. Rückbewegung-
4. Grundstellung.

4.

1. Ausfall. l. seitw mit Rumpfbeugen l. seitw.
2. Standwage l. mit Anlegen des r. Armes.
3. Rückbewegung.
4. Grundstellung.

5.

1. Stellung IV. 2.
2. $\frac{1}{4}$ Drehung l. und Senken zum Liegestütz vorlings.
3. Sprung zum Hockstand mit Vorheben der Arme.
4. Grundstellung mit $\frac{1}{4}$ Drehung r.

6.

1. Senken mit gestreckten Hüften zum Liegestütz vorlings.
2. Durchhocken zum Liegestütz rücklings.
3. $\frac{1}{2}$ Drehung zum Liegestütz vorlings (mit Armwippen).
4. Grundstellung.

7.

1. a) Rückstellen l. Rückschwingen der Arme.
b) Schrittsprung vorw. zur tiefen Kniebeuge mit Vorschwingen der Arme.
2. a) Heben zum Zehenstand und Vorhochschwingen.
b) Rückschrittstellung l. hinter r. mit Kniebeuge r. und $\frac{3}{4}$ Armkreis l. zur Seithalte r.
3. $\frac{5}{4}$ Armkreis l. Ausfall l. seitw. und Rumpfbeugen l. seitw.
4. Standwage l. mit Anlegen r.
5. $\frac{1}{4}$ Drehung l. und Senken zum Liegestütz vorlings.
6. a) Durchhocken zum Liegestütz rücklings.
b) $\frac{1}{2}$ Drehung l. zum Liegestütz vorlings.
7. Tiefe Kniebeuge mit Vorheben der Arme.
8. a) Heben zum Zehenstand, Hochheben der Arme.
b) $\frac{1}{4}$ Drehung l. und Seitssenken ellengriffs.

II. RECK.

- a) Knieweilaufschwung, Schraubenspreizen vorw. zum Stütz Unterschwing.
- b) Kippe ristgriffs zum Stütz, Flanke zum Stand.
- c) Drehkippe zwiegriffs zum Stütz, freier Felgüberschwung rückw. zum Stand
- d) Schwungstemme, freier Felgüberschwung rückw. zum Hang, Kippe, Hocke.

III. BARREN.

- a) Einspreizen l. zum Quersitz r., Stützwage, Oberarmstand, Rad seitw.
Querstand
- b) Oberarmkippe zum Grätschsitz, Schraubenspreizen r. rückw. zum Quersitz,
Wende mit Stütz l.
Schrägstand
- c) Scheraufschwung zum Oberarmhang, Kippe, Rolle vorw. Schwungstemme rückw.,
Kehre mit $\frac{1}{2}$ Drehung innen.
Seitstand vorlings
- d) Felgaufschwung rückw. zum Seitstütz, Unterkreisen mit sofortiger Flanke.

IV. PFERD.

- a) $\frac{1}{2}$ Rad r., einspreizen l., nachspreizen r. zurückspreizen l., zurückspreizen r.,
Flanke l.
- b) Einspreizen l., nachspreizen r., Flanke l. rückw., einspreizen r., Scheer l.,
Schraubenspreizen mit $\frac{3}{4}$ Drehung zum Stand.
- c) Aufhocken r. auf Hals, Kreisspreizen l. mit $\frac{1}{2}$ Drehung r. zum Grätschstand,
Niedersprung,
d) Hocke.
e) Grätsche.

V. STABWEITSPRUNG.

VI. LANGSTABREIGEN.

Anmerkung: A. bedeutet Marschbewegung a, b, c, d die Viererreihen;
B. » Freiübung;
C. » Gruppe 1. 2. 3. 4. die Glieder der Viererreihen.

- 1.) A.) 8 Schritt vorw., 8 an Ort; dasselbe wiederholt.
- B.) 1-4) Vorschreiten links, Vorheben des Stabes.
5-8) Rückschreiten links, Hochheben des Stabes.
9-12) Füße in Grundstellung, Rumpfbeugen vorw. mit Vorheben des Stabes.
13-16) Grundstellung.
17-32) Widergleich.

- C.) a.) Aussen:
- 1-8) Heben in den Zehenstand, Hochheben des Stabes.
 - 9-16) Tiefe Kniebeuge, Vorheben des Stabes.
 - 17-24) Rückschreiten links, Beugen der Arme (Stab in Schulterhöhe).
 - 25-32) Grundstellung.
 - 33-64) Widergleich.
- b.) Innen:
- 1-3) Hinterreihen von 3 hinter 2. 2: Tiefe Kniebeuge, Vorheben der Arme.
3: Rückschreiten links, Hochheben der Arme.
 - 9-16) 2: Vorschreiten links, Vorheben der Arme.
3: Tiefe Kniebeuge, Seitensenken der Arme.
 - 17-24) 2: Erfassen des Stabes.
3: Vorschreiten und Heben von 2 zum Liegestütz auf dem Stabe.
 - 25-32) Grundstellung.
 - 33-64) Widergleich.
- 2.) A.) 1-32) Aufmarschieren zur Stellung im Stern.
Bein Schlusstritt $\frac{1}{4}$ Drehung rechts nach aussen, Stab in der linken Hand.
- B.) 1-4) Seitstellen links, Beugen der Arme zum Stoss.
5-8) Ausfall links seitwärts, Strecken der Arme zur Schräghaltung (links oben, rechts unten).
9-12) Anziehen des linken Fusses, tiefe Kniebeuge, Hochheben des Stabes und Erfassen mit beiden Händen.
13-16) Grundstellung, Stab rechts.
17-32) Widergleich.
- C.) a.) Aussen:
- 1-8) Heben in den Zehenstand und Hochheben des Stabes und Erfassen des Stabes mit beiden Händen.
 - 9-16) Tiefe Kniebeuge, Auflegen des Stabes auf linke Schulter.
 - 17-24) Seitschreiten links Stab bleibt auf l. Schulter.
 - 25-32) Grundstellung.
 - 33-64) Widergleich.
- b.) Innen:
- 1-8) 2: Ausfall links seitwärts, Heben der Arme zur Schräghalte (Links oben, rechts unten).
3: Widergleich.
 - 9-16) 2 und 3: $\frac{1}{4}$ Drehung links bez. rechts, Uebergang zur tiefen Kniebeuge, Vorheben der Arme.
 - 17-24) Liegestütz, Auflegen der Fussriste auf den Stab.
 - 25-32) Grundstellung.
 - 33-64) Widergleich.
- 3.) A.) 1-32) Auf marschieren zur Stellung im Viereck.
1-24) $\frac{3}{4}$ Schwenkung im Stern.
25-32) Aufmarsch zum Viereck.
- B.) 1-4) Rückschreiten rechts zur Auslage links, Hocheben des Stabes mit Rumpfrückbeugen.
5-8) Ausfall rechts vorwärts, Rumpfvorbeugen, Aufstützen auf den Boden.
9-12) Aufrichten, Vorheben des rechten Beines, Hochheben des Stabes.
13-16) Grundstellung.
17-32) Widergleich.
- 3.) C.) *Aussen:*
- 1-8) Rückschreiten des Aussenbeins zur Auslage, Rumpfrückbeuge, Hochheben des Stabes.
 - 9-16) $\frac{1}{4}$ Drehung nach der Stabmitte mit Seitschreiten lk. bzw. r. Auflegen des Stabes auf die äuss. Schulter.

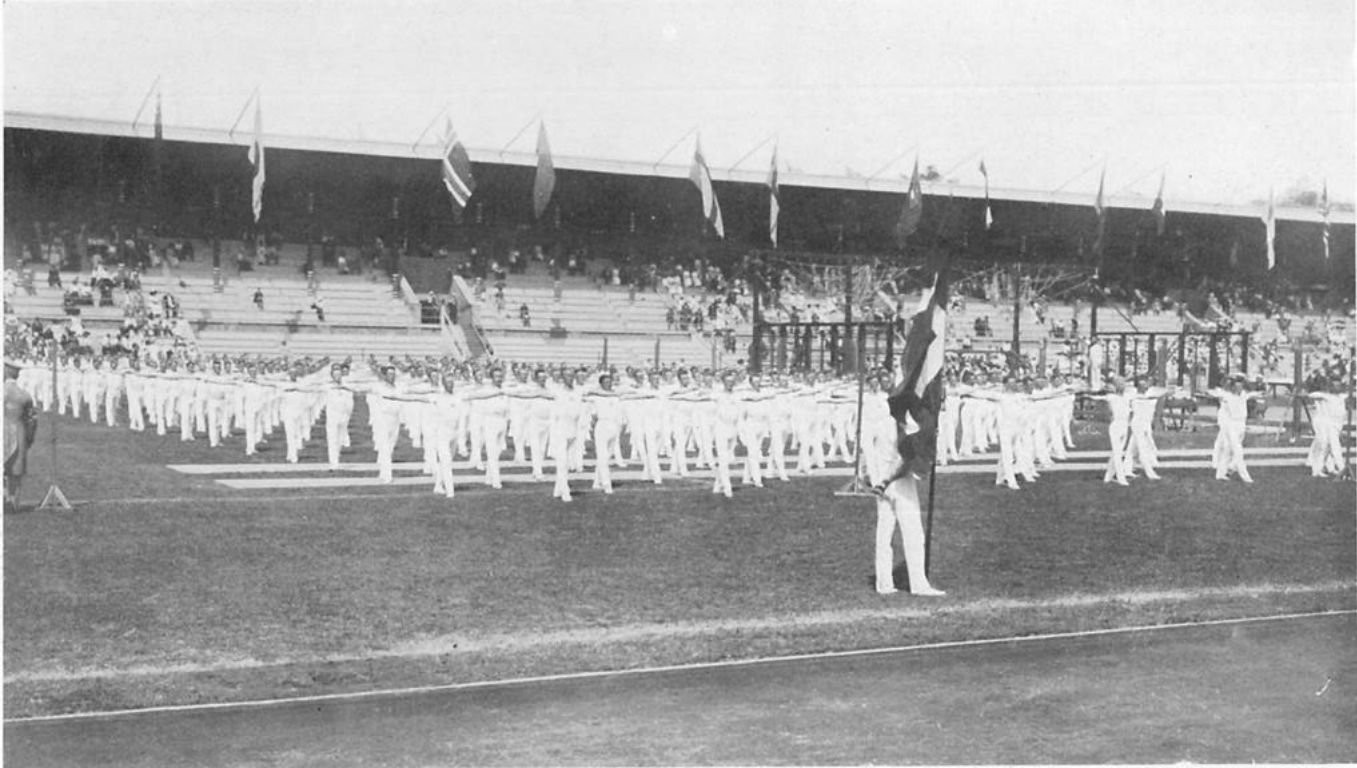

DISPLAY-TEAM OF DANISH GYMNASTS.

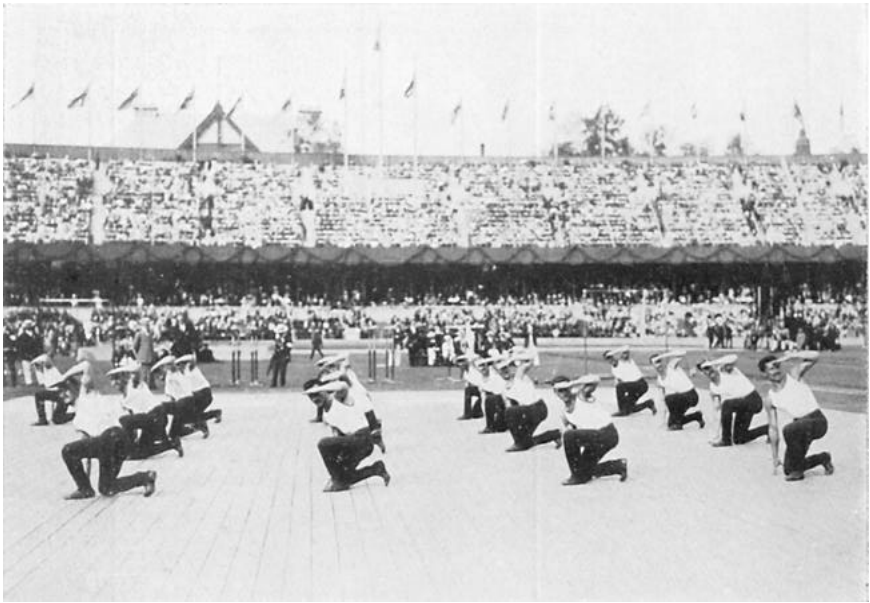

DISPLAY BY RUSSIAN GYMNASTS.



DISPLAY BY NORWEGIAN WOMEN GYMNASTS.

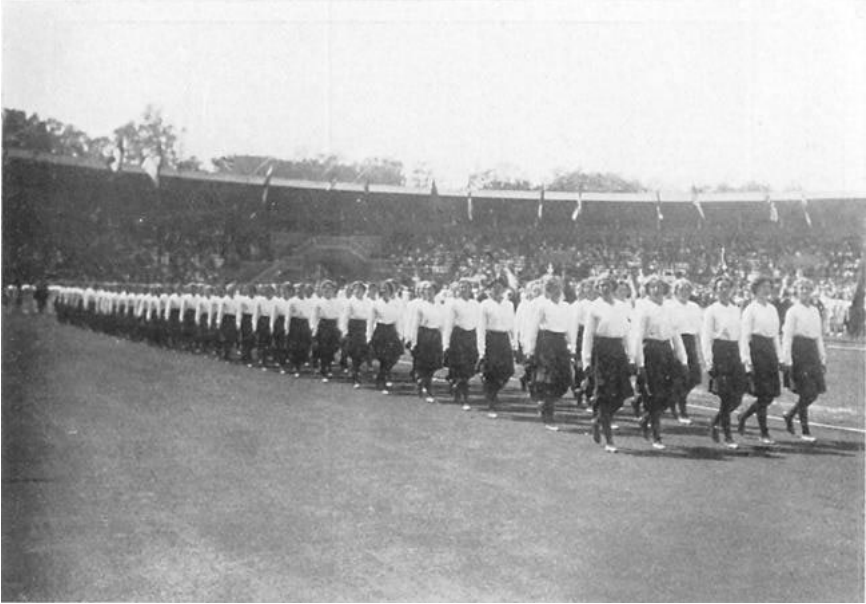

MARCH PAST OF DANISH WOMEN GYMNASTS.



DISPLAY BY DANISH WOMEN GYMNASTS. Inside Vault over Horse
(Feet between hands).

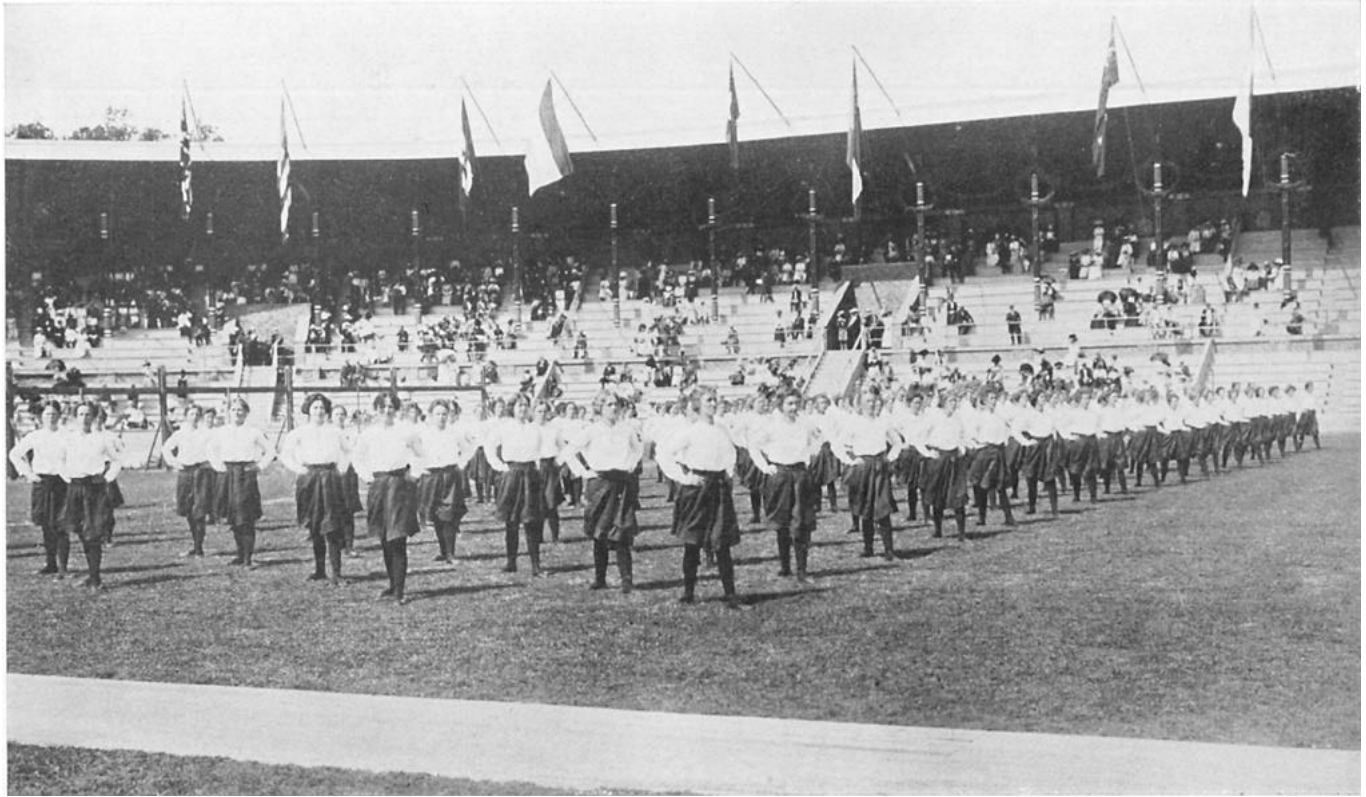

DISPLAY BY DANISH WOMEN GYMNASTS. Wing-step position. Side-twisting.

- 17-24) Verharren in dieser Stellung.
 25-32) Grundstellung.
 33-64) Dasselbe.
Innen.

- 1-8) 2: Einen Schritt schräg rückwärts hinter die Mitte des Stabes, Heben in den Zehenstand und Vorheben der Arme.
 3: Einen Schritt schräg vorwärts vor die Mitte des Stabes, tiefe Kniebeuge und Vorheben des Stabes.
 9-16) 2: Erfassen des Stabes, Durchhocken zum Streckhang rücklings.
 3: Liegestütz vorlings.
 17-24) 2: Kreuzaufzug zum Seitstütz rücklings.
 3: Durchhocken zum Liegestütz rücklings.
 25-32) Grundstellung.
 33-64) Dasselbe.

4.) A.) 1-32) Aufmarsch zu folgender Stellung

$\frac{\quad}{b}$ $\frac{\quad}{a}$ $\frac{\quad}{c}$

B.) *a von Ausßen von b und c:*

- 1-4) Heben in den Zehenstand, Hochheben des Stabes.
 1-8) 5-8) $\frac{1}{4}$ Drehung r. bez. l. nach der Stabmitte, Ausfall l. bez. r. seitwärts und Schräghochheben des Stabes (l. bez. l. oben).
 9-16) Aufrichten, Seitheben d. l. bz. r. Beines Seitensenken d. Arme $\frac{1}{4}$ Drehung zurück, tiefe Kniebeuge und Vorheben des Stabes.
 17-24) Vorschreiten links und Beugen der Arme (Stab in Schulterhöhe):
 25-32) Grundstellung.

d und Innen von b und c:

- 1-8) 1-4) Tiefe Kniebeuge, Vorheben der Arme.
 5-8) Liegestütz vorlings.
 9-16) 9-12) Durchhocken zum Liegestütz rücklings.
 13-16) $\frac{1}{2}$ Drehung l. und Uebergehen durch den Liegestütz vorlings zum Ausfall links vorw. mit Vorhochheben der Arme.
 17-24) Handstand mit Anlegen der Beine an den Stab.
 25-32) Zurtick zur Grundstellung und $\frac{1}{2}$ Drehung l.
 C.) 1-64) Gruppe durch stufenweisen Aufbau.

NORWAY 10.20—11.30 a. m.

Leader: Captain Joh:s Dahl.

Team: 24 men.

Einar Strøm; Alfred Engelsen; Frithjof Sælen; Robert Sjørusen; Isak Abraham- sen; Sigurd Jørgensen; Per A. Mathiesen; Bjarne Johnsen; Knud I. Knudsen; Rolf Lie; Alf Lie; Ths. Thorstensen; Nils Opdahl; Jacob Opdahl; Hans Beyer; Sigv. Sivertsen; Tor Lund; Bjarne Pettersen; Georg Selenius; Nils Voss; Øistern Schirmer; Gabriel Thorstensen; Hartmann Björnson; Petter Martinsen.

Dress: White gymnastic jersey with short sleeves; white trousers; white belt; white shoes.

Programme.

- I. 1. a) Hände am Kopf. — Beinspreizen mit Heben auf Zähnen und Kniebeugen.
 b) Spreizstehend — mit aufgestreckten Armen und Drehung des Körpers — Rumpfbeugen rückwärts und vorwärts.
 c) Mit aufgestreckten Armen, Spreiz — breit stehend Rumpfbeugen. Seitwärts.
 d) Armstrecken auf — aus — vor — nieder.
 e) Hände an Hüften — Kniebeugen mit Armstrecken aus.
 f) Hände am Kopf — Ausfall mit Kniebeugen.

2. Spannstand — Heben des Beines mit Heben auf Zähnen.
 3. Armgang — Wechsel Kamm — und Rissgriff — mit Drehung des Körpers.
 4. a) Armheben vorwärts — aufwärts mit Beinheben vorwärts und Führung auswärts mit volg. Vorlehnen (und Kniebeugen) mit Senken der Armen bis $\frac{1}{2}$ Wagestehend (mit ausgestreckten Armen).
 - b) Stehender Ueberschlag.
 5. a) Aufgestreckten Armen — Fuss stütz stehend — Rumpfheugen vorwärts.
 - b) Fallen vorwärts bis Liegestütz — Heben der Beine bis Handstand — Handgang.
 - c) Marsch.
 6. Hangend — Heben der Beine.
 7. a) Hände am Kopf — Ausfallstehend mit gedrehten Körper — Rumpfheugen Seitwärts.
 - b) Ueberschlag Seitwärts ("Das Rad").
 8. Heben und Senken der Armen mit Kniebeugen und Strecken.
- II. Eine obligatorische und eine gewählte Uebung auf Reck und Barren.
Die obligatorische Uebungen sind:

Auf Reck:

Anlauf — Felgüberschwung mit Vorschwung.
Kippe bis Streckstütz — Wippe bis Handstand — Vorschwung mit Felg-ausschwung $\frac{1}{2}$ Riesenschwung) bis Streckstütz.
Unterschwingung.

Auf Barren:

Anlauf — Sprung bis Streckstütz mit Vorschwung — Rückschwung bis Handstand — Rolle rückwärts.
Vorschwung bis hohe Kiplage — Kippe — Rückschwung — Vorschwung mit Armwippen und Armhupfen vorwärts. — Rückschwung — Vorschwung — $\frac{1}{2}$ Schraubenschwung vorwärts — Abschwung mit $\frac{1}{2}$ Drehung einwärts.

III. *Sprünge:*

1. Pferd (quer) — Die Hocke — Wendesprung mit $\frac{1}{2}$ Drehung einwärts Ueberschlag (gestreckten Körper).
Pferd (längs) — Kehrsprung — Kehrsprung mit $\frac{1}{2}$ Drehung auswärts Flugsprung — Grätschsprung (rasch nach einander).
2. Mit Sprungbrett (Tramplin).
Grätschsprung (Pferd).
Ueberschlag (Sprungtisch).
Gewählter Sprung (wenn Zeit),

- IV. Hände an Hüften — Langsam Kniebeugen.

DENMARK 11:30 a.m.—12:30 p.m.

Leader: Captain H. Mølgaard.

Team: 20 men.

Krebs; A. Andersen; C. Svendsen; Hjalmar Johansen; Arvor Hansen; Christian Hansen; Birch; Charles Jensen; Meulengracht Madsen; P. Jorgensen; M. Hansen; Niels Petersen; O. Olsen; Christian Petersen; Grimmelmann; R. Nordström; Lucas Nielsen; Carl Juul-Petersen; Lerche Olsen; Nørgaard Andersen.

Dress: White jersey with short sleeves; white trousers; white belt; white shoes.

Programme.

I. *Exercices préliminaires.* Dénomination en danois des exercices.

1. Foot-flitting sideways; rise on toes; knee-bending. Arm-stretching up-wards; arm-sinking outwards.
2. Head-twisting; head-bending backwards.
3. Clasp—stride position, Side-bending.

4. Clasp—Wave—Toes-fast position. Arm-flinging outwards; hand-turning: Rest—Half-kneeling position; trunk-bending backwards.
 5. Bend—Toe position. Arm-stretching outwards.
2. *Extension dorsale; pointe des pieds.*
3. *Exercices à la barre fixe:*
 Chaque gymnaste deux exercices dont un obligatoire et un à son choix.
 (Une subdivision de gymnastes pour chacun des quatre appareils dressés.)
4. *Exercices aux anneaux:*
 Chaque gymnaste un exercice à son choix. (Une subdivision de gymnastes pour chacun des quatre appareils dressés.)
5. *Exercices préliminaires:* Dénomination en danois des exercices:
 1. Leg-swinging forwards, outwards and backwards, with arm-lifting forward and outwards: then to Wave—Half-standing position. Knee-bending
 2. Hand-lying position. Arm-bending with leg-lifting.
 3. Lunge (a) with divided arm-stretching up and down:
6. *Marche et course.* Dénomination en danois des exercices:
 1. Common march, with turnings and haltings during the march.
 2. Side-march from forward-march, and in reverse order.
 3. March at the double, with turnings and haltings during the march.
 4. March with ankle-bending and stretching.
7. *Exercices aux barres parallèles:*
 Chaque gymnaste deux exercices dont un obligatoire et un à son choix
 (Une subdivision de gymnastes pour chacun des quatre appareils dressés.)
8. *Saut en hauteur:*
 De 100 cm. — 115 cm. Le professeur commande le pied partant. Élan de 3 pas.
 De 120 cm. — 130 cm. Saut libre.
9. *Voltige; le cheval en travers (avec arçons).* Dénomination en danois des exercices:
 - a) *Sans élan:*
 Chaque gymnaste un exercice à son choix. ("Balance", "Leg-swinging", "Go!")
 - b) *Avec élan:*
 1. Side jump to left: breast turned to horse. Body erect.
 2. » » to right, » » » » » » » »
 3. Balance jump, with turn to left in jump down.
 4. » » » » to right » » »
 5. Sauts se suivent rapidement:

a) Inward jump	}	over horse.
b) Outward		
c) High		
10. *Voltige; le cheval en long (sans arçons).* Dénomination en danois des exercices:
 1. Side jump to left; back turned to horse.
 2. » « » right » » » »
 3. Flying straddle vault over horse; arms thrown far forward.
 4. Flying vault over horse; feet together.
 5. Circle over.
 6. Sauts se suivent rapidement: Straddle vault; body erect.
 7. Vaulting over various heights; body erect.

11. *Exercices de souplesse.* Dénomination en danois des exercices :

1. Quick summersault (on floor); feet apart; followed at once by quick summersault with feet together: followed at once by Arch—Step position, concluding with backward summersault.
2. Long summersault.
3. Wheeling, with turning towards take-off place. Followed at once by backward summersault.
4. Forward summersault.
5. As in 3. Backward summersault.
6. Sauts se suivant rapidement: 3 "Head"-summersault.

Note. En ce qui concerne les quatre derniers groupes des exercices (sauts en hauteur, voltige en travers et en long et exercices de souplesse) toute la section des gymnastes est divisée en deux parties qui exécutent, en même temps, le même groupe d'exercices.

12. *Exercices finals.* Dénomination en danois des exercices.

1. Clasp—Lunge (b) position: Arm-flinging and change of foot.
2. Wing—Stride position. Twisting and trunk-bending backwards, and trunk-bending forwards.
3. Arm-lifting forwards, upwards, outwards and downwards.

FINLAND 2—3 p. m.

Leader: Arvo Vartia.

Team: 20 men.

Aarne Silovaara; Hannes Sirola; Eino Forsström; Kalle Vähämäki; Eino Saistamoinen; Heikki Sammallahhti; Eero Hyvärinen; Mikko Hyvärinen; Lauri Tanner; Väinö Tiiri; Ilmari Keinänen; Tauno Ilmoniemi; Aarne Pelkonen; Kalle Vasama; Unno Suomela; Hjalmar Kivenheimo; Ilmari Pernaja; Fredrik Lund; Arvi Rydman; Kalle Ekholm.

Dress: White jersey with short sleeves; white trousers; black belt; white shoes.

Programme.

A. STABÜBUNGEN

nach Ausrücken zu vieren.

- I. 1) Zehenstand, Vorhochheben des Stabes, tiefes Einathmen.
- 2) Grundstellung. Die Übung wird in ungefähr 8 Sekunden ausgeführt; das Herabsenken des Stabes geschieht schneller als das Hochheben. Im Takte.
- II. 1) Ausfall links seitwärts nach aussen, Stab (mit der rechten Hand am Ende gefasst) rechts nach aussen, linke Hand an der Hüfte, Kopf nach rechts gedreht.
- 2) Ausfall links seitwärts nach innen, Stab swingt von oben nach unten und zur Seithebehalte links schräg nach hinten.
- 3) Durch Vorschreiten rechts schräg vorwärts — zur Gangstellung auf dem linken Fuss mit tiefer Kniebeuge links, Stab von oben zur Seithebehalte rechts schräg vorwärts.
- 4) Ausfall schräg vorwärts rechts nach aussen, Rumpfdrehen nach rechts, Stab schräg vorwärts nach rechts.
- 5) Grundstellung vorwärts.
Dasselbe rechts. Nach Zählung.
Pause.
- III. 1) Kniestellung links seitwärts (Schreiten links nach aussen mit Kniebeuge links), Seithochswingen des Stabes links, Rumpfbeugen nach rechts.
- 2) Seitspreizen links, Seithochswingen des Stabes (den unteren Weg) nach rechts.
- 3) Rumpfdrehen rechts schräg vorwärts, Beinspreizen links schräg nach hinten, Stab hochheben. Wagestellung.
- 4) Aufrichten.
- 5) Grundstellung.
Dasselbe rechts, Nach Zählung.

- IV. 1) Zehenstand. Stab vor-hochheben.
 2) Seitgrätschstellung links mit Kniebeuge links, Stab vor der Brust.
 3) Drehen nach links auf den Absätzen zur Kniestellung. Stab hochheben.
 4) Rumpfbeugen vor-abwärts.
 5) = 3.
 6) Rumpfbeugen rückwärts. Stab auf den Nacken.
 7) Drehen nach rechts, Seitgrätschstellung rechts mit Kniebeugewechseln (Kniebeuge rechts), Stab hochheben.
 8) Grundstellung nach links.
 Nach der anderen Seite. — Im Takte.
- V. 1) Mit Drehung nach links 3 Schritte vorwärts (linker Fuss beginnt) nach dem dritten Schritt Schluss-Sprung, Beinwerfen rückwärts, Stabschwingen nach oben. — Beim Absprung Stab vorheben, schnelle Grundstellung. Die Übung wird 4 Mal nacheinander ausgeführt, mit dem linken Fuss angefangen und 4 Mal mit dem rechten Fuss. Zählung bis 7. Im Takte.

B. GERÄTÜBUNGEN.

I. *Reck.*

- I. 1) Sprung in den Hang mit Rissgriff.
 2) Langsamer Felgaufschwung zum Stütz.
 3) Langsames Herablassen rückwärts zum Hang.
 4) Absprung.
- II. 1) Sprung in den Hang mit Rissgriff.
 2) Kippe, halber Riesenschwung, Schwungstemme, freie Felge, Kreuzaufschwung zum Stütz rücklings, Abschwung rückwärts.

II. *Barren* (im Seitstand).

- I. 1) Mit Anlauf Sprung in den Liegestütz mit den Händen auf den vorderen Holm.
 2) Spreizen des rechten Beines unter dem linken Bein und zwischen den Holmen zurück zum Liegestütz, dasselbe mit dem linken Bein, dann wieder rechts mit Drehung nach rechts zum Grätschsitz vor den Händen.
 3) Schwung in den Handstand.
 4) Rolle Rückwärts, Vorschwung mit Armbeugen zum Grätschsitz und Drehung nach rechts mit Kniebeuge rechts.
 5) Ganze Drehung nach rechts mit Spreizen des Linken Beines erst über, dann zwischen den Holmen zum Grätschsitz — Drehung nach links mit Kniebeuge links.
 6) Ganze Drehung nach links, Beinspreizen rechts über beide Holme zum Liegestütz, die Hände auf den vorderen Holm.
 7) Sprung zum Stand auf den vorderen Holm und sofort Absprung vorwärts mit Armschwingen nach aussen seitwärts.

III. *Kästen.*

- I. Flanke mit Drehung nach aussen (ohne Sprungbrett).
 II. Hocke über quergestellten Kasten (Sprungbrett).
 III. Freier Sprung mit Absprung vom Kasten (Sprungbrett).

C. FREIÜBUNGEN OHNE STAB.

I. *In einfacher Stirnreihe.*

- I. 1) Seitstellen links auswärts. Armheben von aussen nach oben.
 2) Rumpfbeugen links, Arme nach aussen, Kopfdrehung nach rechts.
 3) = 1.
 4) Grundsteilung.
 Dasselbe rechts. Nach Zählung.

II. *In vier Reihen.*

- I. 1) Seitspreizen links seitwärts in die Grätschstellung, Arme zum Schlagen.
 2) Rumpfdrehen nach links mit Armschlagen.

- 3) = 1.
 4) Grundstellung.
 Dasselbe rechts. Im Takte.
- II 1) Kniestellung links seitwärts nach aussen. Arme zum Stossen gebeugt.
 2) Rumpfdrehen nach links und Rumpfeigen vorwärts, rechter Arm stösst nach oben, linker Arm stösst nach unten.
 3) = 1.
 4) Grundstellung.
 Dasselbe rechts. Im Takte.
- III. *In zwei einander zugewandten Stirnreihen.*
 Tigersprung.
- IV. *Laufen und Gehen auf dem Zehen.*
- V. *In Keilauflagestellung.*
- I. 1) Links Beinheben vorwärts mit Armheben vorwärts.
 2) Beinspreizen nach aussen. Arme nach aussen.
 3) Beinspreizen rückwärts. Arme nach oben.
 4) Wagestellung, Arme vor- und abwärts.
 5) Beugen der Knie, Armheben vorwärts.
 6) Grundstellung.
 Dasselbe rechts. Nach Zählung.
- II. Heben in den Zehenstand.
 Armkreisen. Im Takte.

LUXEMBURG 3—4 p. m.

Leader: Direktor Valentin Peffer.

Team: 16 men of those named below took part in the competition.

Nic. D. Adam; Charles Behm; André Bordang; J. P. Frantzen; François Hentges; Pierre Hentges; Michel Hemmerling; J. B. Horn; Nicolas Kanivé; Emile Knepper; Nicolas Kummer; Marcel Langsam; Emile Lanners; J. P. Thommes; François Wagner; Antoine Wehrer; Ferdinand Wirtz; Joseph Zouang; Maurice Polyen.

Dress: White jersey, with sleeves reaching to elbows; black stockinet pantaloons with white facings.

Programme.

I. EXERCICES D'ENSEMBLE IMPOSÉS.

(*Mouvements de Tunis.*)

Les exercices préliminaires sont au nombre de quatre.

Les trois premiers s'exécutent sur quatre faces; chaque face se compose de quatre mouvements, ce qui donne pour chacun des trois premiers exercices, 12 mouvements à quatre temps; le quatrième s'exécute sur deux faces; chaque face se compose de 12 mouvements à quatre temps, soit au total 96 temps.

La cadence est de 84 à la minute pour les trois premiers exercices et de 80 pour le quatrième.

Positions. — Les positions se prennent aux temps indiqués par numéros soulignés. Si plusieurs chiffres sont soulignés l'exécution se fait en plusieurs temps.

L'indication de "station régulière" signifie "position du soldat sans arme".

Tête. — Elle est toujours directe, sauf indication contraire.

Mains. — Mains aux épaules, à la poitrine, à la nuque, aux hanches; se conformer au règlement de l'Union sur l'Instruction de la gymnastique (1908).

Elles sont toujours ouvertes.

Dans la position de: bras en avant, bras en haut, bras de côté, bras en arrière, se reporter à l'indication de l'exercice.

Bras. — Les cercles de bras doivent se faire bras bien tendus, sans contraction musculaire.

Jambes. — Les élévations de jambes en arrière et sur les côtés doivent se faire à environ 40 centimètres du sol; les lancers de jambe en avant, jambe hori-

zontale. Les flexions des membres inférieurs se font sur la pointe des pieds, genoux écartés, tronc droit (ne reposant pas sur les mollets).

Cercle. — Le bras gauche passe toujours par-dessus le bras droit.

Fentes. — Pour les fentes en avant et en arrière, le tronc incliné et dans le prolongement de la jambe tendue.

La fente se fait à 65 centimètres (environ) les pieds selon l'indication.

Rassemblements. — Ils se font toujours sur la jambe stationnaire.

Commandements. — Pour le concours, le moniteur se place de façon que sa voix soit bien entendue des gymnastes.

Il commande: Garde à vous! Après avoir indiqué le numéro de l'exercice, il commande: Commencez, et compte les temps à haute voix.

Les gymnastes prennent d'eux-mêmes la position de repos au quatrième temps du dernier mouvement en plaçant les mains au dos à hauteur de la ceinture et en portant le pied gauche en avant.

1^{er} Exercice.

Thème. — Élévation des bras — cercle des bras — fentes latérales — mains à la poitrine — bras obliques — élévation de la jambe tendue en arrière.

- | | | |
|------|-----|--|
| I. | 1 2 | Élever les bras tendus en avant en haut (paumes des mains en dedans). |
| | 3 4 | $\frac{3}{4}$ de cercle des bras devant le corps, bras de côté (paumes des mains en dessous). |
| II. | 1 2 | Fente latérale à droite, pieds à plat, tronc dans le prolongement de la jambe droite tendue, jambe gauche fléchie, mains à la poitrine. |
| | 3 4 | Extension des avant-bras de côté, bras perpendiculaires à la position du corps (paumes des mains en dessous.) |
| III. | 1 2 | Rassembler le pied droit au gauche, bras en haut, passant par en bas et en avant (paumes des mains en dedans). |
| | 3 4 | Fente latérale à gauche, pieds à plat, tronc dans le prolongement de la jambe gauche tendue, droite fléchie, bras perpendiculaires à la position du corps (paumes des mains en dessous). |
| IV. | 1 2 | Faire face à droite, en pivotant et en s'élevant sur la pointe du pied droit, élever la jambe gauche tendue en arrière, abduction des bras en arrière, passant par en bas. |
| | 3 4 | Rassembler le pied gauche au droit, station régulière. |

II^e Exercice.

Thème. — Pas gauche en avant — pas latéral — mains aux épaules — fentes latérales avec extension d'un bras — cercle du bras gauche — lancer de jambe en avant.

- | | | |
|------|-----|--|
| I. | 1 2 | Pas gauche en avant, jambes tendues et élever les bras tendus en avant (paumes des mains en dedans). |
| | 3 4 | Pas latéral à gauche, jambes tendues, bras tendus de côté (paumes en dessus). |
| II. | 1 2 | Faire face à gauche, en pivotant sur le talon gauche et la pointe du pied droit, talon droit levé, jambe gauche fléchie, droite tendue, mains aux épaules. |
| | 3 4 | Extension des bras dans le prolongement du tronc et de la jambe tendue, droit oblique en haut et gauche oblique en bas (paumes des mains en dedans). |
| III. | 1 2 | Faire face à droite, en pivotant sur le talon gauche et la pointe du pied droit, bras tendus de côté, passant par en bas (paumes des mains en dessus). |
| | 3 4 | Faire face à droite, en pivotant sur le talon droit et la pointe du pied gauche, talon gauche levé; jambe gauche tendue, droite fléchie, bras passant par en bas, gauche oblique en haut, droit oblique en bas (paumes des mains en dedans). |

- IV. **1 2** Lancer la jambe gauche tendue en avant, bras horizontaux en faisant décrire au bras gauche $\frac{3}{4}$ de cercle d'arrière en avant (paumes des mains en dedans).
3 4 Station régulière.

III^e Exercice.

Thème. — Élévation de la cuisse, — mains aux épaules, — extension des bras, extension de la jambe, mains à la nuque, cercles des bras.

- I. **1 2** Élever la cuisse gauche, mains aux épaules.
3 4 Extension verticale des bras, extension de la jambe gauche, pied à 0,40 du sol (paumes des mains en dedans).
 II. **1 2** Pas à gauche de côté, jambes tendues, bras de côté par $\frac{3}{4}$ de cercle devant le corps (paumes des mains en dessous).
3 4 Fléchir la jambe droite, mains à la nuque, tronc dans le prolongement de la jambe gauche tendue.
 III. **1 2** Faire face à droite sur les talons, mains aux épaules.
3 4 Extension oblique des bras en haut dans le prolongement du tronc et de la jambe gauche tendue (paumes des mains en dedans).
 IV. **1 2** Rassembler le pied gauche au droit, par $\frac{3}{4}$ de cercle des bras devant le corps, bras de côté, et élever la jambe gauche tendue de côté (paumes des mains en dessous).
3 4 Station régulière.

IV^e Exercice.

Thème. — Sursaut à la station écartée, élévation des bras, flexion sur les extrémités inférieures, appui couché facial, costal, dorsal, fente, cercle des bras.

- I. **1 2** Sursaut à la station écartée, bras de côté (paumes des mains en dessous).
3 4 Sursaut pieds réunis talons levés, bras tendus verticaux (paumes des mains en dedans).
 II. **1 2 3 4** Fléchir sur les extrémités inférieures, bras horizontaux (paumes des mains en dedans).
 III. **1** Poser les mains à terre, devant la pointe des pieds, genoux en dehors.
2 3 4 Extension du corps et des jambes en arrière, à l'appui facial couché.
 IV. **1** Passer la jambe droite tendue par-dessus la gauche et poser le pied à 0,20 environ du gauche.
2 3 4 Tourner sur le bras gauche à l'appui costal, élever le bras droit de côté en haut (paume de la main en avant).
 V. **1 2 3 4** Poser la main droite à terre en pivotant sur le bras gauche à l'appui dorsal couché, talons réunis.
 VI. **1 2** Élévation de la jambe gauche tendue.
3 4 Abaisser la jambe gauche.
 VII. **1 2** Élévation de la jambe droite tendue.
3 4 Abaisser la jambe droite.
 VIII. **1** Passer la jambe droite tendue par-dessus la gauche et poser le pied à 0,20 environ du gauche.
2 3 4 Tourner sur le bras gauche à l'appui costal, élever le bras droit de côté en haut (paume de la main en dedans).
 IX. **1** Appui facial tendu, tourner sur le bras gauche en posant la main droite à terre et rapporter le pied droit au gauche.
2 Flexion des bras.
3 4 Extension des bras.
 X. **1** Fléchir les jambes en ramenant les pieds en arrière des mains, genoux en dehors des bras.
2 3 4 Fente de la jambe gauche tendue arrière (0,65), jambe droite fléchie, corps incliné en avant, pieds à plat, bras tendus obliquement en arrière en bas.



DISPLAY BY FINNISH WOMEN GYMNASTS,



DISPLAY BY FINNISH WOMEN GYMNASTS.



DISPLAY BY FINNISH WOMEN GYMNASTS.

- XI. 1 Faire face en arrière en tournant à gauche sur les talons, mains aux épaules, jambe droite fléchie, gauche tendue.
 2 3 4 Extension oblique des bras en haut dans le prolongement du corps (paume des mains en dedans).
- XII. 1 Rassembler le pied gauche au droit, talons levés, bras tendus de côté par $\frac{3}{4}$ de cercle devant le corps.
 2 3 4 Station régulière.

II. BARRES PARALLÈLES.

Hauteur des barres: 1,60 m. Écartement des barres: 0,42 m.

Position initiale: Au commandement "Attention": Pencher le corps un peu en avant, étendre les bras en arrière en bas, mains ouvertes, paumes en dedans. Au commandement "Commencez": Sauter le plus loin possible au milieu des barres à l'appui brachial, prise radiale, et en même temps, s'élancer en avant à l'appui brachial mi-renversé transversal dorsal.

- I. 1. Se basculer à l'appui tendu.
 2. Élaner en arrière.
 3. Élaner en avant par appui fléchi à l'appui tendu.
 4. Élaner en arrière à l'appui renversé.
- II. 1. 2. 3. 4. Abaisser lentement à l'appui d'épaules.
- III. 1. Poser la tête sur la poitrine.
 2. Tourner $\frac{3}{4}$ de tour en avant à l'appui brachial.
 3. Tourner $\frac{6}{4}$ de tour en arrière par l'appui brachial écarté latéralement.
 4. Terminer l'élan à l'appui brachial mi-renversé.
 5. Élaner en avant en fléchissant légèrement les bras.
 6. Élaner en arrière à l'appui tendu et au siège dorsal en dehors à droite, derrière la prise.
- IV. 1. Lever le corps sur le coude droit.
 2. Lever les jambes à l'appui de coude droit horizontal latéral.
- V. 1. Revenir en barres à l'appui tendu.
 2. Élaner en avant.
 3. Élaner en arrière en passant la jambe gauche sous la main droite, d'avant en arrière et croiser les jambes derrière la prise (jambe gauche en dedans droite en dehors).
 4. Frapper la cuisse droite derrière la prise sur la barre droite en élançant en même temps la jambe gauche devant la prise par-dessus la barre droite.
 5. Sauter par $\frac{1}{2}$ tour à gauche à la station fléchie, en reprenant avec la main droite la barre droite; bras gauche tendu en avant, main fermée, ongles en dedans.
 Position.

N.B. Les chiffres romains signifient les arrêts; les chiffres arabes marquent les temps d'exécution. Les mouvements marqués de chiffres arabes sont à exécuter sans arrêt. La durée des différents arrêts au travail simultané est réservée à l'appréciation du moniteur.

III. ANNEAUX.

1. Lever les jambes horizontalement en avant; — puis se lever à la suspension renversée.
 2. Tourner en arrière, cuisses et jambes tendues à la suspension horizontale dorsale.
 3. Tourner en avant, corps tendu, à la suspension renversée.
 4. Fléchir les cuisses, se basculer à l'appui tendu et puis, lever les jambes horizontalement en avant.
 5. En maintenant jambes tendues en avant, abaisser à la suspension faciale.
 6. Élaner en arrière, puis en avant à l'appui tendu.
 7. Tourner en avant à la suspension mi-renversée; élaner en arrière, en avant et sauter, en tournant en arrière, corps tendu à la station fléchie; bras tendus en avant; maintien dorsal.

IV. BARRE FIXE.

Hauteur: 2,40 m. Position initiale: Suspension tendue latérale faciale, prise dorsale.

1. Lever les jambes horizontalement en avant.
2. Fléchir les jambes, les passer entre la prise et les étendre vivement à la suspension horizontale dorsale.
3. Abaisser à la suspension dorsale.
4. Changer à la suspension faciale, en lâchant main gauche et en tournant un tour à droite.
5. Prendre la prise sur les poignets et se lever à l'appui tendu.
6. Tourner en arrière à la suspension mi-renversée faciale et au temps, élaner en avant, en arrière, en avant et par suspension mi-renversée, se basculer en avant à l'appui tendu et sans arrêt, pousser le corps en arrière, pour tourner en arrière par grand élan, corps bien étendu, à l'appui facial.
7. Élaner légèrement en avant, puis en arrière en levant les jambes tendues et écartées sur la barre en dehors de la prise; tourner en arrière à la suspension mi-renversée et en joignant les jambes devant la barre, sauter en avant à la station fléchie; bras tendus en avant, maintien radial.

Result: I. prize..... NORWAY
 II. » FINLAND
 III. » DENMARK

GENERAL PROTOCOL.

III. Team Competition, with free choice of movements and apparatus.

	Points awarded by				
	Clod-Hansen	Allum	Wilskman	Syson	Wagner
Total points	18	12	14	16.25	24
Total points	20	24	22	23.25	25
Total points	23	19	21.5	20.75	22
Total points	20	20	23	22.25	24
Total points	19	15.5	18	17	12

Stockholm, 10 July, 1912.

Ivar Wilskman. Abr. Clod-Hansen. Dr. Med. Wagner-Hohenlobbese.
 F. D. Allum. A. E. Syson.

Confirmed: Einar Nerman. Chief Leader.

INDIVIDUAL COMPETITION.

Friday, 12 July.

The competition took place on July 12 between 9.30 a.m.—5 p.m.

Judges:

Dr. F. Allum, Norway,
Dr. Lachaud, France,
Captain A. E. Syson, Great Britain,
Professor Cesare Tifi, Italy,
Dr. Ivar Wilskman, Finland.

Result: I. prize..... ALBERTO BRAGLIA..... Italy..... 135 points
II. » LOUIS SÉGURA..... France..... 132.50 »
III. » ADOLFO TUNESI Italy..... 131.50 »

44 men took part in this competition, but two of these did not finish. The names of the nations represented can be seen from the general protocol on pp. 558—559.

The Displays.

In these there took part: 4 teams of women: the Swedish team being 48 strong; the Norwegian numbering 22; the Danish 148 and the Finnish 18, and

4 teams of men: the Swedish team numbering 192; the Danish 320; the Hungarian 16 and the Russian 18.

DISPLAY BY THE SWEDISH TEAM OF MEN GYMNASTS.

Saturday, 6 July.

With the Swedish colours waving at their head, the 192 men forming the Swedish team marched into the arena at 12.30 p.m., under the command of Captain E. Lieberath.

Dress: white jersey with short sleeves, white trousers, white shoes with rubber soles, blue and yellow belt. The Swedish flag was sewn on the breast of each jersey.

The execution of the programme took about 40 minutes. The vertical and inclined ropes of the gymnastic apparatus were employed for the heaving movements; four horses and five vaulting plinths were used simultaneously for the vaulting. The marching in ordinary time and at the double were executed on the running track.

DISPLAY BY THE SWEDISH TEAM OF WOMEN GYMNASTS.

Saturday, 6 July.

Immediately after the Swedish men gymnasts had left the arena, the 48 Swedish women gymnasts entered under the command of Miss Marrit Hallström, Director of Gymnastics, who wore the same dress as the team. The Swedish flag was carried in front of the troop by one of the women.

Dress: blue blouse with black collar, above which there appeared to be attached to the blouse the Three Crowns of Sweden, executed in yellow silk. The sleeves reached to a little below the elbows and

had black cuffs; the Swedish flag in miniature was attached to the left upper arm of the blouse; blue "bloomers"; black stockings, black shoes, with leather soles, attached by a leather strap passing round the ankles.

The free exercises (i. e. without apparatus) were executed on the gymnastic floor.

The gymnastic apparatus was employed for the heaving movements and for the vaulting, plinths, too, being used for the latter. The apparatus was managed by the women themselves. The marching was performed on the gymnastic floor, and the programme was concluded at 2 p. m.

About 1.30 p. m., officials and competitors in other branches of athletics began to assemble in the arena, and this somewhat marred the effect of the display.

DISPLAY BY THE DANISH TEAM OF WOMEN GYMNASTS.

Monday, 8 July.

Under the command of Miss Bentsen the 148 Danish women gymnasts marched into the arena at 9.30 a. m., preceded by a man carrying the national flag.

Dress: white blouse with the "Dannebrog" (Danish flag) on the left upper arm; black bloomers; black shoes and stockings.

The team had its own apparatus, which was managed by the Danish men gymnasts.

DISPLAY BY THE DANISH TEAM OF MEN GYMNASTS.

Monday, 8 July.

Commanded by Herr Vilhelm Kristensen, Director and Vice-Inspector of Gymnastics, the great team, 320 strong, of Danish men gymnasts, preceded by the Danish colours, which were hung with crape owing to the recent death of the Danish King, marched into the arena at 10.37 a. m., the ranks being somewhat disturbed by the passage of the competitors in the walking competition. On its arrival in the arena, the team marched forward singing a song, and drew up in two columns fronting the east, near the middle of the southern third-of the arena.

Dress: white jersey with short sleeves, and with the "Dannebrog" on the breast; white trousers with straps; white shoes and belt.

The team had its own apparatus, which was employed whenever necessary.

The leader of the team stood on a little platform. Counting time was employed very much.

The programme was concluded about 11.20 a. m.

DISPLAY BY THE NORWEGIAN TEAM OF WOMEN GYMNASTS.

Monday, 8 July.

Under the command of Captain Reidar Fabritius, the Norwegian team of 22 women gymnasts, preceded by a man carrying their national colours, marched into the arena after the conclusion of the display given by the Danish men gymnasts.

Dress: white blouse with black collar and black cuffs; black skirts; black stockings and shoes. The leader was in full parade.

The introductory exercises, marching and concluding exercises were carried out on the gymnastic floor. The Swedish gymnastic apparatus was employed, but was managed by men assistants. Beams, resembling bars, were also employed.

The display was concluded about 12.10 p. m.

DISPLAY BY THE FINNISH TEAM OF WOMEN GYMNASTS.

Monday, 8 July.

Immediately the previous division had left the arena, the Finnish team of women gymnasts, 18 strong, marched in, under the command of Miss Björkqvist, who was attired in a light-coloured walking-dress, but wore no hat.

Dress: grey pleated blouse and skirt of antique cut; grey stockings and shoes.

In addition to the Swedish apparatus, bars and a spring-board were also employed. A great number of the movements were executed on the turf close to the Royal box.

DISPLAY BY THE HUNGARIAN TEAM OF MEN GYMNASTS.

Wednesday, 10 July.

The team, consisting of 16 men in addition to the leader, Herr Bâbel Rezsô, marched in at 4 p. m., preceded by the Hungarian flag.

Dress: white jersey with long sleeves, and with the Hungarian arms on a large badge attached to the breast; rather wide, white trousers without straps; narrow red-yellow belt; white shoes.

The programme embraced free exercises with Indian clubs; similar movements without clubs, and others with gymnastic apparatus. The apparatus was managed by special attendants.

DISPLAY BY THE RUSSIAN TEAM OF MEN GYMNASTS.

Thursday, 11 July.

The team, 18 men strong, consisted of officers from the Russian Gymnastic School.

Dress: white sleeveless jersey, with a red edging round the neck, shoulders and bottom; belt in the Russian colours; blue, tight-fitting, narrow trousers with straps; black shoes with leather soles.

The programme embraced free movements and movements with horizontal bar, parallel bars and vaulting horse. About half the time was devoted to the free movements.

COMPARATIVE VIEW OF THE COMPETITIONS AND DISPLAYS.

A comparative view of the competitions and displays in Gymnastics during the Olympic Games of 1912 is of the very greatest interest, as, on that occasion, every nation tried, of course, to exhibit the best and most characteristic features of its own form of work in this branch of physical education. But when this comparison is made, respect must be paid, first and foremost, to one important factor

GENERAL PROTOCOL.
IV. Individual Competition.

No.	Name	Horizontal Bar				Parallel Bars				Rings				Pommel Horses				Total Points
		Wilskman	Allum	Syson	Total	Lachaud	Tifl	Bely	Total	Wilskman	Allum	Syson	Total	Lachaud	Tifl	Bely	Total	
1	Gellért Imre	9.75	6	8.25	24	11.25	11	11.75	34	9	9	8.75	26.75	10.50	10.75	11	32.25	117
2	William Cowhig	10.75	7	8	25.75	10	10.50	9	29.50	9.25	9	8.50	26.75	7.50	7.50	7.50	22.50	104.50
3	Giorgio Zampori	11	8	10	29	11.75	11.75	11.50	35	11.25	8.75	10.75	30.75	10.75	11.75	10.75	33.25	128
4	Emil Lanners	9	7	9	25	10	9.50	9.50	29	10.50	8.50	8	27	10	9.50	9.25	28.75	109.75
5	Ein. Aug. Möbius	6.50	5	2	13.50	8.50	8.50	10	27	9	9.25	8	26.25	6.50	6.50	7	20	86.75
6	Aug. Pompogne	9	9	9	27	11.50	10.50	10	32	10.50	8	9.50	28	11.25	9.75	10	31	118
7	Nicolas Kanive	8.50	6	7.75	22.25	11	10	10.25	31.25	10.75	8.50	10.25	29.50	10.75	9.25	8.50	28.50	111.50
8	Louis Charl. Marty	10	7	9.75	26.75	12	10.75	12	34.75	10.75	9	10.75	30.50	10.75	10.25	9.50	30.50	122.50
9	József Szalay	10.75	8	9.25	28	11	11	11	33	10.50	8.75	10.50	29.75	9	9	8.50	26.50	117.25
10	Iános Korponay	10.75	7	8.75	26.50	9	9.75	10	28.75	9.25	8.75	8.75	26.75	11	11	11	33	115
11	Honzacko Bohumie	8.25	4.50	4.25	17	9	8	8	25	9	8	8.50	25.50	8.75	7.50	7.50	23.75	91.25
12	Alexandre Achun	8.50	6.50	5.75	20.75	9	8	8.25	25.25	7.75	7.50	8	23.25	6.50	6	6	18.50	87.75
13	Axel Sigurd Andersen	9	6.75	6.50	22.25	10.25	9.50	10.25	30	8.75	8.75	9	26.50	6.75	6.50	6.75	20	98.75
14	Antoine Costa	10.75	9.50	9.50	29.75	11.75	11	11.50	34.25	10	9	10.75	29.75	11.25	9.50	10	30.75	124.50
15	Niels Petersen	7.75	5.75	7.25	20.75	8.75	10.25	9.25	28.25	10	9	9.25	28.25	7	6.50	6.50	20	97.25
16	William Nieminen	10.50	8	8	26.50	10	11	9	30	9	7.50	8.50	25	9	7.25	8	24.25	105.75
17	Guido Romano	10.75	8.50	10	29.25	10.50	11.75	10.25	32.50	11	8.50	10.50	30	11.25	11.75	11.50	34.50	126.25
18	Sam. Hodgetts	10.75	8.50	6	25.25	9.25	8.50	10	27.75	10.75	8	9.50	28.25	9.25	9	9	27.25	108.50
19	Elemér Pátzthy	10.25	9.50	8	27.75	10.25	9.50	10.75	30.50	9.75	8.50	8.75	27	11.25	11.25	11.25	33.75	119
20	Guido Boni	10.50	9.50	9.75	29.75	11.25	12	12	35.25	10.50	8	9.75	28.25	10.75	12	12	34.75	128
21	Arvor Hansen	9.50	9	8.50	27	11	8.50	10	29.50	10.50	8.50	9.50	28.50	7	7.50	8	22.50	107.50
22	Semen Kulikoff	8	5.75	2.75	16.50	8.50	8	7.50	24	7	7	7.50	21.50	6.50	5.50	5.50	17.50	79.50
23	Ch Simmons	8.50	7.50	7.50	23.50	10.50	9.50	10.50	30.50	10.50	8	10	28.50	7.50	7.50	8	23	105.50
24	François Hentges	7.75	6.25	6.75	20.75	10.50	11	11	32.50	10.25	8.50	8.25	27	11	9.75	9.50	30.25	110.50
25	Louis Ségura	10.25	9.75	10	30	12	11.75	12	35.75	10.75	10.50	11	32.25	12	10.50	12	34.50	132.50
26	Adolfo Tunesi	10.75	9	10.50	30.25	11.75	11.75	11.50	35	11	9	10.50	30.50	11.75	12	12	35.75	131.50
28	Ch. Chr. P. Jensen	9.25	7.50	8.50	25.25	8.75	9	9.25	27	9.50	7.25	9.50	26.25	7.50	9.25	8.50	25.25	103.75
29	Marcel Lalu	10.50	9.75	9	29.25	12	11.50	12	35.50	10.50	9	11	30.50	11.25	10.50	10	31.75	127
30	Alberto Braglia	11.25	11	10.50	32.75	10.75	12	12	34.75	11.50	9	11.25	31.75	11.75	12	12	35.75	135
31	Pierre Hentges	10	7.50	8.50	26	10.25	8.50	10.75	29.50	10.75	9.25	9.25	29.25	10.25	10	10.50	30.75	115.50
32	John Whitaker	10	8.50	8	26.50	10	8.25	9.50	27.75	10.75	9	10	29.75	9.25	9	9	27.25	111.25
36	Reg. Hubert Potts	9.75	7.50	8.25	25.50	8.50	7.50	7.25	23.25	10.50	7.50	10.25	28.25	7.50	8.75	8.50	24.75	101.75
37	Kaarlo W. Ekholm	8.75	8	8.25	25	9	8.50	8	25.50	—	—	—	—	—	—	—	—	—
38	Teodore Zabeline	7.25	5	2.50	14.75	7.50	7	7.50	22	7.50	7	8	22.50	5.25	5.75	6	17	76.25
39	Antti Fr. Tamminen	10.50	5.75	6.75	23	8.50	7	7.75	23.25	9.50	8	8.50	26	5.25	6.50	6.50	18.25	90.50
42	Jean Pierre Thomas	9.50	7	6.25	22.75	11	10	11	32	9.75	9	8.75	27.50	10.50	9.50	8.50	28.50	110.75
43	Pietro Bianchi	10.75	8	10.75	29.50	11.25	11.50	11	33.75	11	9	10.75	30.75	11.25	11	11.50	33.75	127.75
44	Antoine Wehrer	9.75	8.50	8.25	26.50	11	10.75	11.25	33	10.25	9	9.50	28.75	10.50	9.25	9.25	29	117.25
45	Carl Jul. Pedersen	9.75	7	8.25	25	8.75	8.75	8.75	26.25	10	7	8.25	25.25	5.50	7.75	7.50	20.75	97.25
46	Paul Konchorikoff	9.50	7.50	7.75	24.75	8.75	7.75	8	24.50	6.50	6.75	8.25	21.50	6.50	6.25	6.50	19.25	90
48	Urho W. Wuolio	8	7.50	7.75	23.25	9.50	9.75	9.75	29	—	—	—	—	—	—	—	—	—
50	Marcos Torrès	10.75	9	10.50	30.25	12	11	12	35	11	9.25	10.75	31	11.75	9.50	9.50	30.75	127
51	Karl Edv. Jansson	10.75	9	8.50	28.25	10.75	10	10	30.75	9.50	6.50	8.25	24.25	6.75	6.50	6.50	19.75	103
53	Leon. Hansson	10.75	9	8.75	28.50	9.75	10.50	11.50	31.75	11	10.50	10	31.50	10.25	9.75	9.50	29.50	121.25

Stockholm, July 12 1912.

IVAR WILSKMAN.

F. D. ALLUM.

A. E. SYSON.

CESARE TIFL.

LACHAUD.

MICHAEL BELY.

WILHELM CARLBERG.

Leader.

Confirmed:

EINAR NERMAN

Chief Leader.

— the system employed — for the various systems stand entirely outside the scope of such a comparison and must be treated individually. Of such systems we saw “Ling’s System”, as it is called, in more or less pure forms; the German “Turn”, and a third, displayed by a Russian team, and the originator of which was an Russian officer. It is true that gymnastics displayed by a team, on the one hand, and an exhibition of purely individual skill, on the other, in accordance with the same system, can be compared, although such an examination would be very defective, and altogether valueless. Competitions or displays in gymnastics, per se, have often and very thoroughly been discussed, as far as regards the Swedish (Ling’s) system. Nowadays, it is pretty generally acknowledged that this form of gymnastics is not suited for competitions, although many are of the opinion that such competitions, if held, tend to development. Both forms, however, occurred at the Games. From a purely gymnastic point of view, the competing- and the display teams can be judged together, but, in other respects, the points of comparison are more numerous and not without interest.

Finally, gymnastics for men and gymnastics for women must be looked at separately, not because there is any definite difference in the system, but as, in many respects, the method of applying the system is, and must be, very different, a comparison is not unjustifiable. Gymnastics for women occurs only within the Ling-group, which, on the other hand, did not send a single representative to the individual competition — a fact which, of itself, is most significant

The Swedish school was represented by the three northern countries, Denmark, Norway and Sweden. Although, of late years, Ling’s teachings have begun to spread, and have won an increasing number of adherents in many countries, such as Belgium, Great Britain, Holland, Russia and, in part, Germany, none of these nations had sent representatives. This circumstance was greatly regretted, as, without doubt, it would have been both instructive and interesting to observe how the great man’s principles had been transformed into practice under varying conditions. As the case was, the teams taking part in the Games bore a great resemblance to each other. The task of the judges, however, was certainly a far lighter one than it was in London. The reason of this was, that, in certain respects, the Swedish team was considerably better, and the divisions from Denmark and, especially, Norway, not at all so good as those that took part in the London competition, in 1908.

As there can be no question of publishing here a personal view of the results, the most natural way of making a comparison between the competing teams is to give some extracts from the protocols, or minutes, of the judges. But if the figures given are to be viewed in their true light, respect must be paid to the groups of exercises which were to be judged; the marks given, and the co-efficient. According to the protocol, Sweden gained 4,687.3 points, Denmark 4,494.2 and Norway 4,286.05. In the two most important groups — archflexions (“span-bending”) movements and



SWEDISH WOMEN GYMNASTS MARCH INTO THE STADIUM.

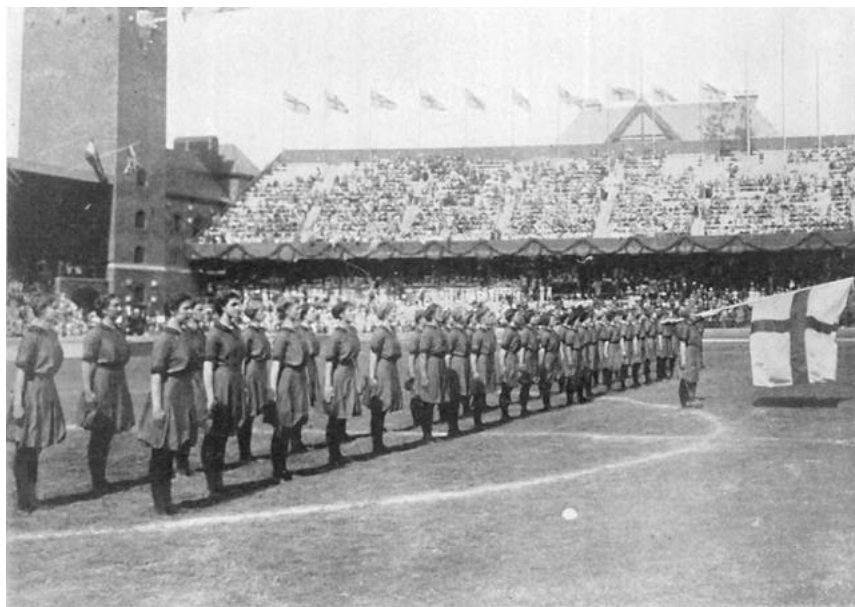

DISPLAY TEAM OF SWEDISH WOMEN GYMNASTS.

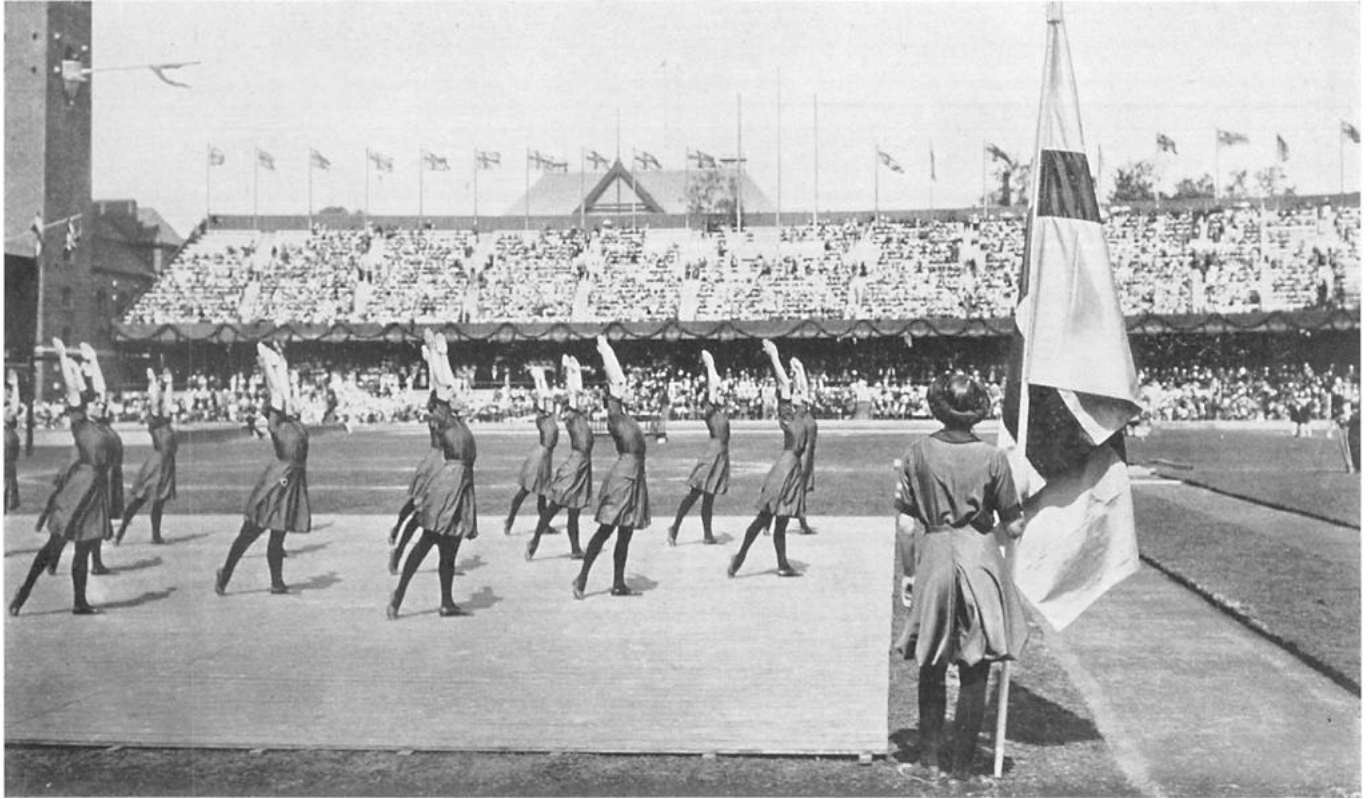

DISPLAY BY SWEDISH WOMEN GYMNASTS.

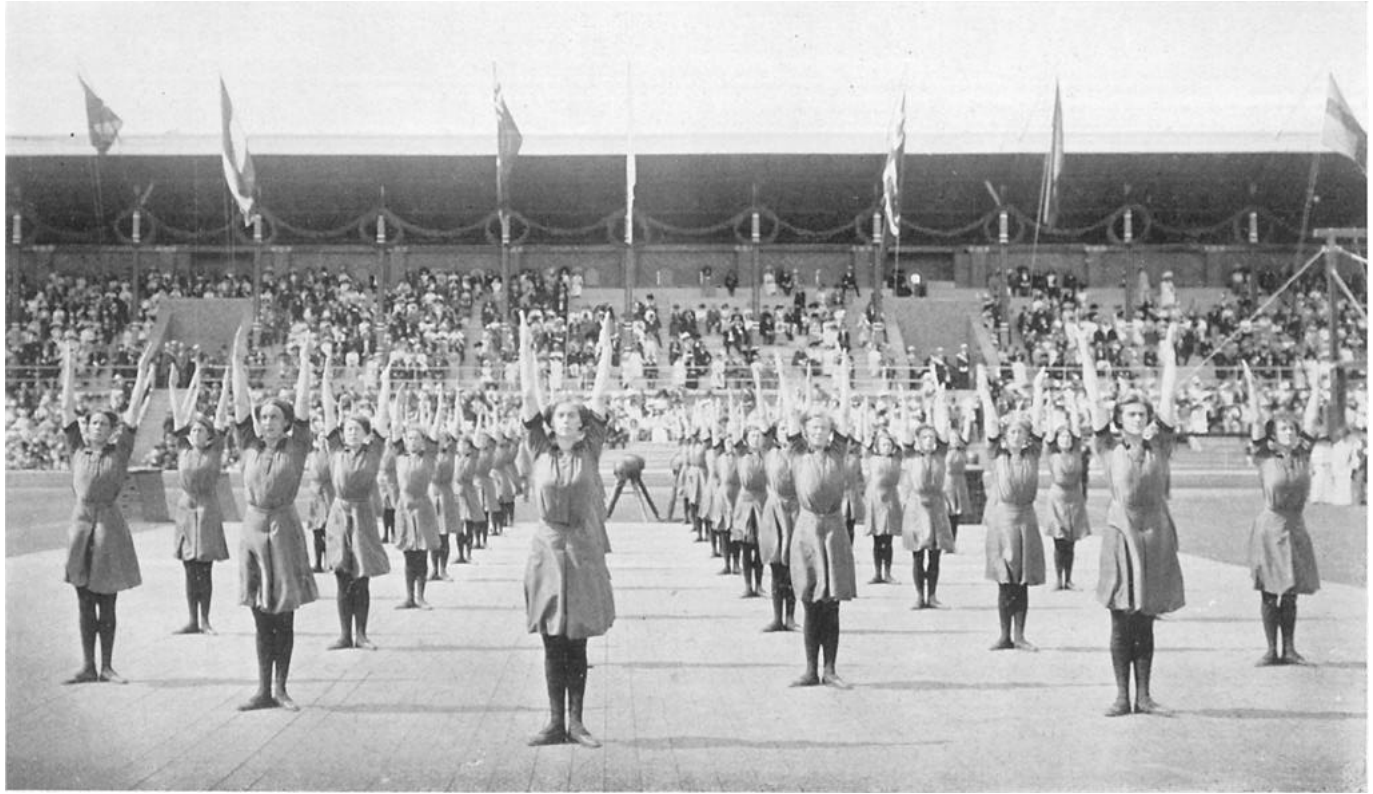

DISPLAY BY SWEDISH WOMAN GYMNASTS.

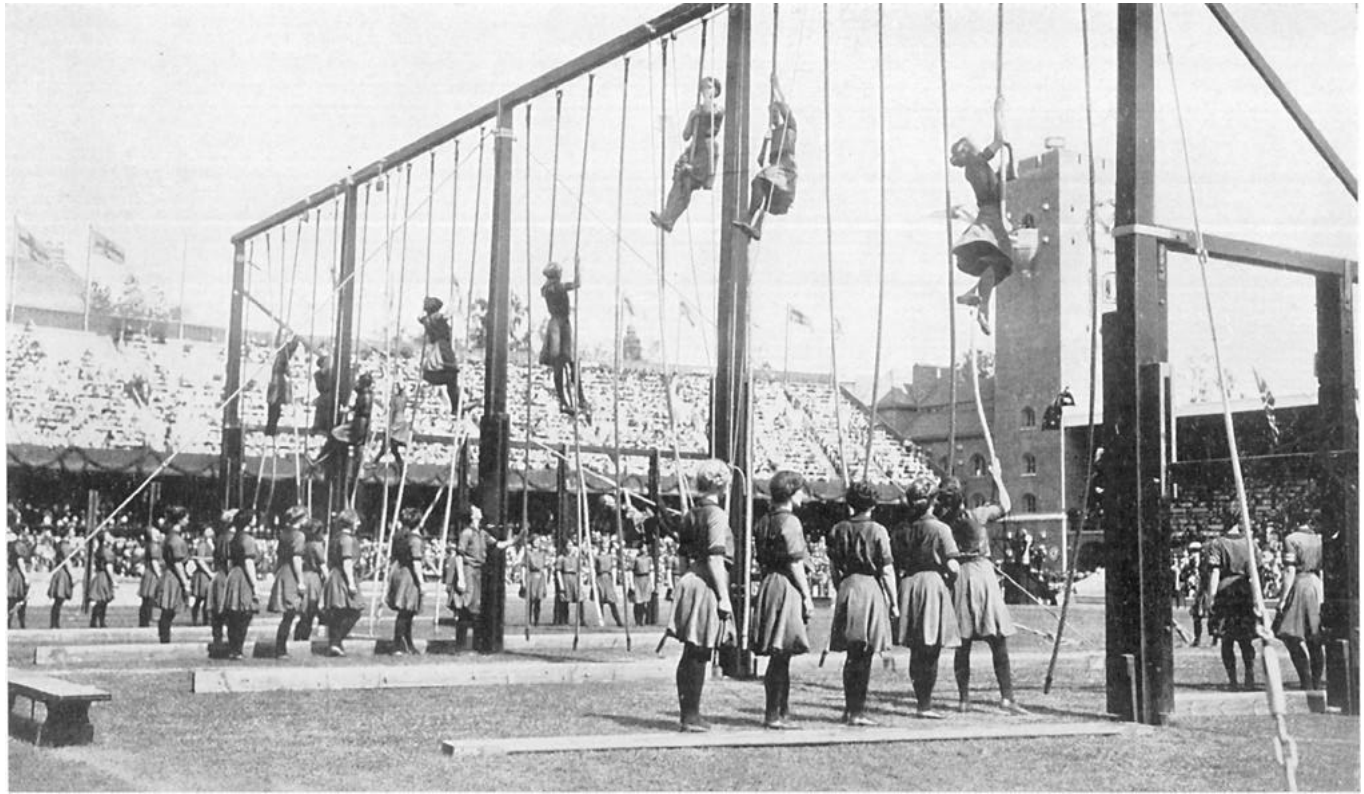

DISPLAY BY SWEDISH WOMAN GYMNASTS Climbing vertical ropes.

evenness and precision, Sweden had 548 and 542 respectively; Denmark 546 and 552 and Norway 492 and 492 points, out of 600 possible, from which can be seen that Denmark, in the last-mentioned group, was considered to be first. In the heaving movements, marching and running, lateral (alternate) trunk movements and vaulting, Sweden was given 484.75, 505.75, 460.25 and 471.80, or a total of 1,922.55 points; Denmark 449.50, 453.95, 462 and 453.25, or a total of 1,818.70 points, and Norway 427, 448, 451.50 and 424.90, or a total of 1,751.40. These marks were of 2,100 possible. In the shoulder-blade movements and abdominal exercises, Sweden obtained 403.50 and 409.50 respectively, or a total of 813 ; Denmark 385.50 and 381, total 766.50, and Norway 375 and 384, total 759, of 900 possible. For the introductory exercises, the figures for the three countries were 338.75, 323.50 and 306.25, respectively, of 375 possible, and, finally, for the balance movements and the concluding exercises, the figures for the three countries were 252, 238, 247.4 and 271, 262 and 248, of 375 possible in each case.

It will be seen from this, not only that the judges had a very clear idea of the relative order of merit of these three countries, but also that the difference between the countries was not very great. If we make an attempt to discover any special, characteristic features from the total impression given, it would be, that the carriage of the Danish team was a little stiff — the result, perhaps, of the shoulders being drawn somewhat too much back — while in the case of the Norwegians, there was noticeable a certain disposition to back-swank (a swaying in of the back) a fault which, formerly, was quite noticeable in our Swedish gymnasts but which, happily, in the younger generation in Sweden, seems about to disappear. All three teams were well and evenly trained. It was apparent that much time and care had been devoted to the vaulting, which went with life and confidence.

In the displays, there were teams of women and of men; four teams altogether of women from Sweden, Denmark, Finland and Norway, and a total of two teams of men from Sweden and Denmark.

The work of the Swedish team of women was worth all possible praise. It displayed an evenness in the movements and an observance of style which was seldom disturbed ; there was suppleness, combined with strength in the heaving exercises and the vaulting, and a dignity over the whole which gave an impression of perfect confidence and self-control on the part of the executants.

The programme of the Danish women's team was considerably easier than that of their Swedish sisters, both from a purely gymnastic point of view and also as regards the character of the movements. The impression given, however, was a sprightlier one than that afforded by the Swedish team, the reason probably being that the Danes were 148 strong ; the Swedes only 48.

From the very instant of their entrance into the arena, the team of Finnish women made a most sympathetic impression, the result, in a great measure of a very attractive dress, but also of a well-composed programme and good execution of the movements — there being in

the two latter moments, one might venture to say, a mournful poesy, which could not but awaken the sympathies of the public. There was much esthetic gymnastics in the programme, but a great amount of energetic heaving movements and vaulting, too. It was somewhat unusual to see women make use of the parallel bars, and the employment of a spring-board in the vaulting seemed a little old-fashioned.

The display by the Norwegian women was beautiful as a whole, but the team was numerically too small to be able to make any real, permanent impression.

Of the men's display teams, the Danish deserves special mention, The division numbered no less than 320; it was composed of persons belonging to all classes of society, and displayed what the system can, and wishes to, produce in the gymnastic instruction of great masses.

The nations representing another system of gymnastics than the Swedish were very numerous. In Group II, where the programme consisted of movements according to fixed regulations, there took part Luxemburg, Hungary, Germany, Great Britain and Italy, in the order mentioned. Russia also formed part of this group, but did not compete. In group III, with free choice of movements, an opportunity was given of seeing Norway, Denmark, Finland, Germany and Luxemburg. A team from Hungary gave a display.

It was very difficult — for a Swedish gymnast especially — to judge the competitions and displays in Group II from the spectators' benches, as it was the details in the execution of a programme which was the same for all the teams, that decided the competition. There are some few general points of view, however, that deserve to be emphasized and are not without interest.

As we stated before, it was the German "turn" that was exhibited. The series-movements, as usual, gave character to the whole, and exercised its usual influence, i. e., form having to give way to the observance of the order in which the movements were to be taken. The very natural result was, that the carriage, on the whole, was not good, and little respect was shown to the details of the positions. The German system hardly tends to promote good marching, and what was shown on this occasion was not better than the usual displays. On the whole, there did not exist that harmony over the whole that a Swedish gymnast wishes to see.

The judges placed Italy first in this competition, and public opinion had, probably, previously come to the same decision. The protocol shows a certain superiority for Italy in nearly all the groups of exercises judged. The carriage in the free movements was better than that of the other teams, and one could not avoid noticing the better all-round physical development of the Italian division. The same team got pretty high point-totals for the execution of the movements, too. The placing was: Italy, Hungary, Great Britain. As a summary of our opinion it may be said, that all the teams gave the impression of being a number of individuals specially trained in certain difficult exercises, who had been brought together to display their talents collectively.

In Group III an opportunity was given of seeing a mixture of the Swedish system and the German "turn". No one doubted but that the Norwegian team would win the contest. Everybody's opinion was, that the division in question was not a little superior to the Norwegian team that had competed in Group I, both as regards uniformity in the movements, and also as regards the correctness with which they were carried out. The Danish team also took part in a mixed programme, of which exercises on the horizontal and parallel bars and with rings formed no slight proportion. Finland and Germany displayed some staff-exercises. The Finlanders have always loved the iron staff as a gymnastic attribute, and it cannot be denied that it is an interesting item in gymnastics. The same can be said of the long staves used by the Germans, with which figures were formed and curves described. The programme of the nations now mentioned also embraced the usual exercises derived from "turn" -gymnastics.

The judges placed Finland next to Norway, Denmark being awarded the third prize.

As regards the individual competitions, it only needs to be said that, in all the exercises, the representatives of the various nations displayed a skill which must have been seen to be properly understood. The reader is referred to the judges' protocol for the result of this competition.

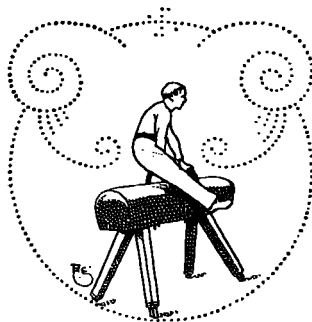

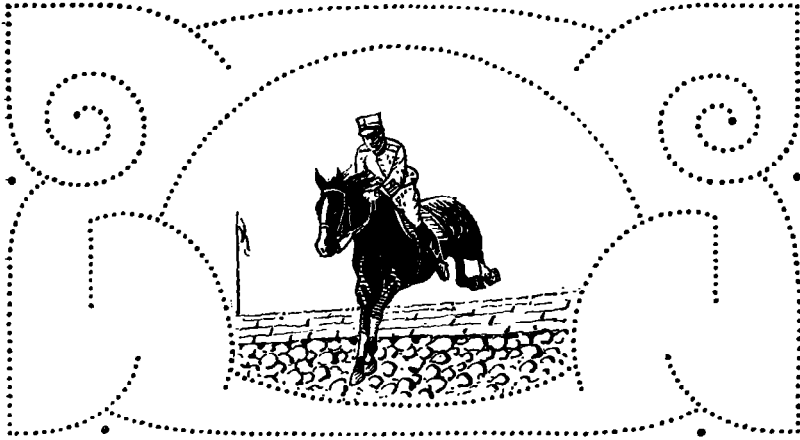

HORSE RIDING COMPETITIONS.

It was first at the Olympic Games of Stockholm that Horse Riding competitions were placed on the programme of the modern Olympiads, and many difficulties had to be overcome before even that measure of success was obtained.

The first time that the idea was brought forward of including Horse Riding events among the Olympic competitions, was at the meeting of the International Olympic Committee, at Athens, in 1906. The proposer of the plan was Count Clarence von Rosen, the Swedish representative on the Committee, who urged the great importance of Horse Riding, too, forming part of the Games. Military representatives ought to take part in the proposed competitions, as the Games would thereby be strengthened by an element that would otherwise be absent, and would certainly gain in popularity and scope, while the various Governments and other State authorities would feel much more interest in the Games, were the cavalry officers of different countries to compete with each other. The opponents of the measure pointed out, on the other hand, that the cost of the proposed event would be very great, and that, consequently, there would not be many entries.

Count von Rosen succeeded in gaining the support of Baron Pierre de Coubertin, President of the Committee, who requested him to prepare a scheme for the competitions in question, and to lay it before the Meeting of the International Olympic Committee at the Hague, in 1907.

A Committee was, consequently, formed in Stockholm the same year, consisting of (then) Captain G. A. Boltensern, Baron Cl. Cederström, Captain E. af Kleen, Lieut. Count C. Bonde and Count Cl. von Rosen, the latter of whom acted as secretary.

This Committee drew up a proposal which was signed by H. R. H. Prince Carl, Inspector of the Swedish Cavalry, and Major General, Count A. Gyldenstolpe, the then President of the Swedish Jockey

Club. The document was translated into English and laid before the Meeting of the International Olympic Committee at the Hague in 1907. It embraced prize riding, a riding-pentathlon and the Jeu de Rose. It was considered a good idea, and Lord Desborough, Great Britain's representative at the Meeting, and President of the 'British Olympic Council, declared that Great Britain would be prepared to place Horse Riding Competitions on the programme for the Games of London, 1908, if Count Clarence von Rosen could show that there existed any enthusiasm on the continent for the plan.

This Count von Rosen was able to do, and in the autumn of 1907, the question arising of the best manner of organizing the competitions in question, Count von Rosen was called to London, Count C. Bonde accompanying him as a member of "Le comité pour la redaction des règlements équestres Olympiques et Internationaux".

As the British Olympic Council considered that it was not able to arrange Horse Riding competitions in the Stadium, it communicated with the International Horse Show, Ltd, Olympia, which undertook to hold the competitions if Count von Rosen would organize them and, within a fixed period, was able to guarantee that six nations would each enter at least 4 representatives.

Before the close of the time fixed, 8 nations had entered a total of 88 competitors, and His Majesty King Edward VII had personally expressed the wish to present a challenge cup for prize riding. As, however, an unexpectedly large number of entries had been made for the Horse Show, the Olympia Board found itself unable to carry out the Olympic programme too, so that nothing came of the matter.

At the meeting of the International Olympic Committee in London during the Games of 1908, Sweden expressed its readiness to arrange the Olympic Games of 1912 in Stockholm. In Berlin, in 1909, Sweden came forward with a programme which included Horse Riding competitions in accordance with the programme drawn up for the London event. This was adopted in principal, and Sweden was officially given the honourable task of carrying out the Olympic Games of 1912 in Stockholm.

In the autumn of 1909 there was formed, under the patronage of H. R. H. Prince Carl, a preliminary Committee for the Horse Riding competitions, this Committee taking definite form at a meeting held at Prince Carl's Palace, on the 8 April, 1910, under the title of "The Committee for the Horse Riding Competitions of the Olympic Games of Stockholm, 1912".

ORGANIZING= AND PREPARATORY WORK.

The Committee formed at the meeting on the 8 April, 1910, consisted of

Hon. President: H. R. H. PRINCE CARL,
President:..... Colonel, Count E. OXENSTIERNA,
Treasurer: Captain, Count FAB. F:SON WREDE,
Secretary:..... Count CL. VON ROSEN, Master of the Horse,
 Colonel G. TORÉN,
 Major, Baron CL. CEDERSTRÖM,
 Count C. BONDE, Master of the Horse.

During the spring of 1910 the following members were added to the Committee :

Colonel B. MUNCK,
 J. PHILIPSON, Esq.,
 Captain, Baron N. PALMSTIERNA,
 Lieut., Count C. G. LEWENHAUPT,
 Lieut. C. TRÄGÄRDH,

the latter of whom afterwards officiated as Secretary, Count von Rosen being the General Secretary.

The first questions dealt with by the Committee were the placing of the Horse Riding competitions on a secure economic basis, and the drafting of the programme.

While, at previous Olympic Games, only medals and challenge prizes had been awarded in every branch of athletics, the first idea, when the proposal was made to place Horse Riding competitions on the programme, was, that in consequence of the very great expense entailed on those taking part in the events, it would not be possible to carry them out successfully unless large money-prizes were also given. In consequence, the first measure taken by the Committee was to endeavour to obtain funds for the prizes in question.

As a means of comparison between the original and the final programmes and budgets, it may be of interest to mention that the earliest draft of the programme included prize riding, prize jumping, pentathlon on horseback (the latter embracing team cross-country riding, prize jumping and prize riding, individual steeple-chase riding and a long distance ride with prize jumping), and Jeu de Rose, while the first budget amounted to Kr. 35,000 (£ 1,925 : \$ 9,625), of which Kr. 15,000 (£ 825 : \$ 4,125) was to be awarded in money prizes, the rest going to pay expenses.

In order to be able to carry out the competitions, the Committee determined to apply first of all to the Swedish Olympic Committee with a request for a guarantee fund of Kr. 10,000 (£ 550 ; \$ 2,750), the Committee also applied to the Horse Show in Stockholm, the Stockholm Horse Racing Club and all the Field Riding Clubs in the country asking them to give guarantees to cover the expenses.

As a result, the following guarantees were signed:

The Swedish Olympic Committee	10,000: — (£ 550 : \$ 2,750)
The Stockholm Horse Racing Club ...	10,000: — (£ 550 : \$ 2,750)
The Stockholm Field Riding Club.....	5,000: — (£ 275 : \$ 1,375)
The Scanian » » »	5,000: — (£ 275 : \$ 1,375)
The Gothenburg » » »	5,000: — (£ 275 : \$ 1,375)
The Småland—Östergötland Field Riding Club	2,000: — (£ 110 : \$ 550)
The Uppland—Vestmanland Field Riding Club	1,000: — (£ 55 : \$ 275)
The Norrland Field Riding Club ...	1,000: — (£ 55 : \$ 275)
Total : Kronor: 39,000: — (£ 2,145 : \$ 10,725)	

This sum was not considered large enough, however, and early in May a new budget was drawn up, amounting to Kr. 45,000 (£ 2,475: \$ 12,375), this, too, soon being rejected as insufficient.

The work of the Committee during the spring of 1910 was concentrated on an examination of the possibility of, and the conditions necessary for, holding the Horse Riding competitions in connection with the Olympic Games. It was then thought that the events in question ought to be arranged like those in Brussels and London, i. e., with money prizes ("objets d'art"), and in order to obtain sufficient funds, the Committee then determined to endeavour to obtain guarantee-subscriptions from private persons.

The condition had been attached to the guarantee of Kr. 10,000 given by the Swedish Olympic Committee, that the said Committee should enjoy preferential rights of repayment. As the Horse Riding Committee felt that it could not accept this condition, it determined to make another appeal to the Swedish Olympic Committee and, on the supposition that private persons would give guarantees amounting to Kr. 8,000 (£ 440 : \$ 2,200), fresh estimates were made, amounting to Kr. 50,000 (£ 2,750 : \$ 13,750), of which Kr. 25,000 (£ 1,375 : \$ 6,875) were to be awarded as money prizes, the remainder to be employed to cover expenses. It was thought that these should be restricted to Kr. 25,000, i. e., the limit covered by the guarantee fund, as the money received by the sale of tickets, etc., could not be used to cover expenses, but was to be employed for the repayment of the guarantees.

A committee was appointed to draw up estimates for the competitions, the total amount to be awarded in prizes being fixed at Kr. 25,000. These estimates were ready about the 1 June.

At the meeting of the Swedish Olympic Committee on the 6 June, 1910, it was resolved to subscribe Kr. 10,000 towards the Horse Riding Competitions held in connection with the Olympic Games.

Immediately after this meeting, which had such important results for the carrying out of the competitions, the International Olympic Committee met at Luxemburg on the 11 June. At this meeting it was determined, amongst other things, that, in future, only medals, and no money prizes or prizes of honour, were to be awarded in all the branches of sport at the Games.

This resolution with regard to the award of medals gave a new turn to the question of the arrangement of the Horse Riding competitions in connection with the Olympic Games, for, from the very beginning, everything had been grounded on the principle that money prizes would be allowed, the estimates being based on this idea and the guarantees asked for having been given on this supposition. It now became necessary to make different economic arrangements for the competitions which were to be held under these new conditions, and at first the Committee was very doubtful what steps to take, for, remembering the large money prizes awarded at horse riding competitions in London and on the continent, a doubt was felt whether there would be any large number of entries for these Olympic events, — the first

of the kind at which no money prizes were to be awarded, although participation in them would be attended with heavy transport expenses.

During the early part of the summer of 1910, however, at the request of the Committee, Count von Rosen, the General Secretary, went to London, Brussels, Paris and Berlin. The result of this journey showed that Great Britain, Belgium, France and Germany intended to take part in the Horse Riding competitions although no prizes were to be awarded and, in consequence, the Committee, at a meeting held on the 11 November, 1910, determined to arrange Horse Riding competitions in connection with the Olympic Games and that no money prize, in any form, should be then awarded, but that the prizes should consist of medals and challenge prizes and that the estimates should be increased to Kr. 60,000 (£ 3,300 : \$ 16,500).

At the beginning of 1912 the estimates were further increased to Kr. 81,000 (£ 4,455 : \$ 22,273), a sum that soon rose to Kr. 100,000 (£ 5,500 : \$ 27,500), the guarantee-sum given by the Swedish Olympic Committee being, at the same time, increased to Kr. 15,000 (£ 825 : \$ 4,125).

In spite of some pessimistic opinions in different quarters, the economic result of the 'competitions was exceedingly good. It is true that the highest sum allowed by the estimates for expenses (kr. 100,000) was exceeded by Kr. 3,992: 01 (£ 220 : \$ 1,100) this step being permitted by the Swedish Olympic Committee), so that the total expenses of the Horse Riding competitions were Kr. 103,992 : 01 (£ 5,720 : \$ 28,600), but the receipts amounted to Kr. 123,539: 69 (£ 6,794 : \$ 33,970), giving a surplus of Kr. 19,547 : 68 (£ 1,074 : \$ 5,370).

It was also decided that competitors should be allowed their travelling expenses, that no entrance fees should be demanded, and that all competitors non-resident in Stockholm should be offered free accommodation. In this connection an Executive Committee was appointed as follows : President, Major, Baron Cl. Cederström ; Secretary, Lieutenant C. Trägårdh ; Treasurer, Captain, Count Fab. F:son Wrede; with Count Cl. von Rosen; J. Philipson, Esq., and Captain, Baron N. Palmstierna.

Among the important questions referred to the Executive Committee may be mentioned: the drawing up of a draft programme and propositions for the Horse Riding competitions of the Olympic Games of 1912, and the organization of Horse Riding competitions in 1911 in accordance with the programme for the coming Olympic events, but open only to Swedish competitors. During the autumn the Executive Committee worked energetically at the task of drawing up the programme and propositions for the competitions, so that, at a meeting held on the 15 December, 1910, it was able to place its scheme before the General Committee. At this meeting it was determined that the proposed propositions should be submitted to a number of authorities, asking for an expression of their opinion, and that, after the receipt of replies, a new draft programme, etc., should be drawn up by the Executive Committee at the beginning of 1911. At the meeting in question it was also considered advisable to investigate the probabilities



COMMITTEE FOR HORSE RIDING COMPETITION AT THE OLYMPIC GAMES OF STOCKHOLM, 1912.



THE STADIUM DURING THE PRIZE JUMPING. In the foreground, H. R. H. Prince FRIEDRICH KARL of Prussia.

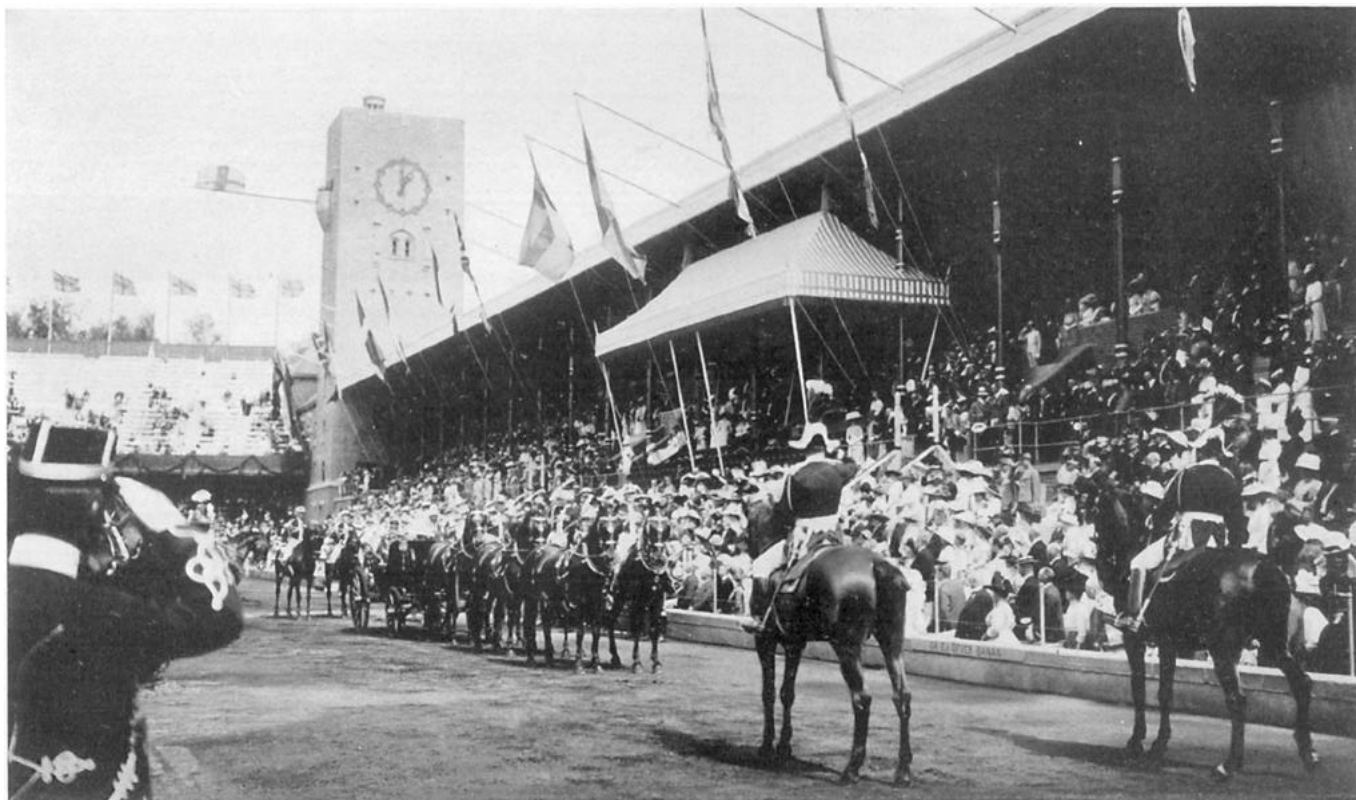

ARRIVAL IN STATE OF THEIR MAJESTIES, THE KING AND QUEEN OF SWEDEN.

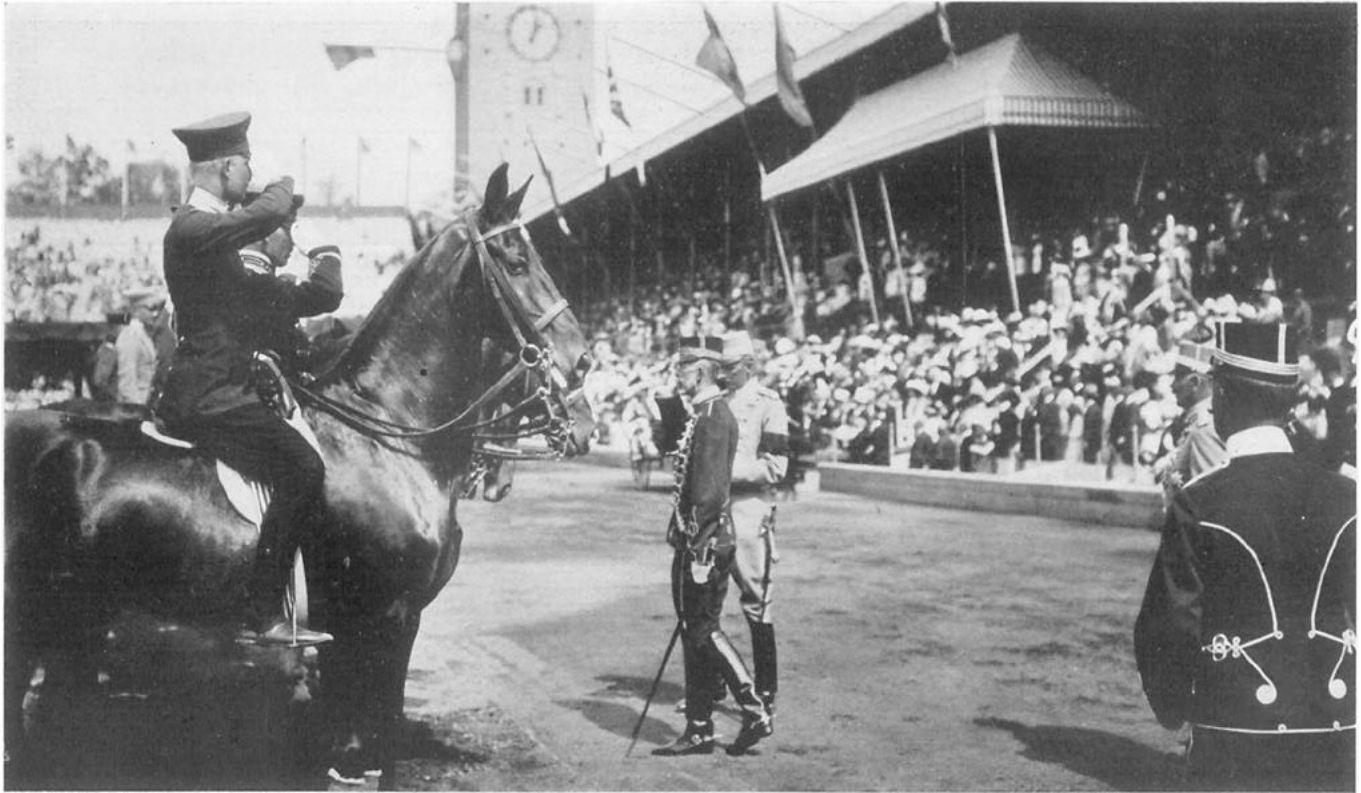

THE COMPETITORS IS THE HORSE RIDING EVENTS PRESENTED TO H. M. THE KING.

of receiving numerous entries from abroad, and the General Secretary, Count von Rosen, was commissioned to go to Berlin, Vienna and Rome, to endeavour to awaken interest in, and obtain promises of entries for, the Horse Riding competitions. This journey was afterwards extended to St. Petersburg, and it is a pleasure to state that Count von Rosen performed his task in a way that had the happiest results.

GENERAL REGULATIONS, PROGRAMME AND PROPOSITIONS.

General Regulations.

On examining the regulations issued for the Olympic Games as a whole, it proved that some of the rules were not suited to the Horse Riding competitions, so that the Committee was obliged to draw up special regulations for the events in question. Amongst the questions which then came under discussion was that of the right of a competitor to enter several horses. As it was of the greatest importance for the Horse Riding competitions to have the various nations represented by as many riders as possible, it was determined that each competitor could enter two horses, but that he would be allowed to ride only one horse in each competition.

As, from the very beginning, the Committee had begged the Foreign Office to take steps to have the propositions, etc., forwarded to the War Departments and Foreign Offices abroad, and the Swedish Foreign Office having most kindly complied with this request, the Committee considered that the most suitable thing to do with regard to the question of entries for the Horse Riding competitions would be to communicate, not only with the Olympic Committees, but also with the War Departments abroad, begging that the entries should be made through the latter authorities. This was done, as, from the very first, it appeared as if the competitors from abroad in the Horse Riding events would consist of officers only, an assumption which was afterwards confirmed.

The Horse Riding Committee also considered it necessary that it should form the highest court of appeal in the case of protests concerning entries, etc., as the protests would not be sent in through the Swedish Olympic Committee. When forming the International Jury for the Horse Riding competitions, the principle was adopted that the President should be a Swede and that each nation competing should nominate one representative, irrespective of the number of competitors which it had entered. In the event of a nation considering that it could not send a representative to the Jury, the regulation was made, that one nation could be represented in the jury by the delegate of another.

The question concerning the privileges that could be granted competitors from abroad, necessitated a thorough economic investigation. The Committee applied to the Board of the State Railways, requesting, and obtaining, free transport for the horses taking part in the Games, while the Swedish Olympic Committee obtained a reduction of fares on the State Railways for all the competitors and officials

taking part in the Games. In consequence of these measures, the Horse Riding Committee found itself able to offer four competitors from each nation free passes on the Swedish State Railways, for themselves and their grooms, and free board and lodging in Stockholm during the time the Horse Riding competitions were going on. In the General Regulations this period was fixed at 7 days, but it was extended later on to 10. The reason that these advantages were conferred in the first place on the competitors entered for the "Military", or Field Competition, was because the greatest importance was justly ascribed to this event, as it combined both an individual- and a team competition, and as in it an opportunity was given of seeing the representatives of various nations taking part in several different trials of skill. The fact that the judges, as a rule, were Swedes alone, was merely in accordance with the general regulations of the Olympic Games, and it caused no difficulty as far as regards the Military and the prize jumping, in which events the judging was merely automatic. In the prize riding, on the other hand, where different systems had to be judged, these systems had to be represented amongst the judges, just as in gymnastics and fencing. The general regulations for the Horse Riding competitions will be found at the end of the book.

The Programme.

The drafting of the programme was at first a matter of very great difficulty, it being almost impossible to calculate the number of entries, either of nations or of competitors. As the Stadium was not to be at the disposal of the Committee for more than two days, it proved necessary from the very beginning to limit the number of the competitions and to fix the maximum number of competitors that could be entered by the various nations for each competition.

The competition which had to be omitted was the *Jeu de Rose*, as the event in question was unknown to a number of the nations competing, and also because it is one that causes the judges many difficulties. Even at a moderate calculation of the number of the competitors, it appeared impossible to hold all the competitions in the Stadium, and so the Committee determined that prize riding, as not being of such very great, general interest, should take place, if necessary, elsewhere than at the Stadium, while the prize jumping, on the other hand, should, under all circumstances, be held there.

It was thought that it would be of the greatest interest to include in the programme, not only individual prize jumping — in which personal skill would come to the fore — but also team prize jumping, so as to more clearly mark the character of the event as a competition between the nations taking part in the event. On drawing up the programme for the "Military", consideration had to be paid to other Olympic competitions, etc., so as not to tax the horses too severely that were to take part in other events. In consequence, it was determined that the competition in question should continue for

a period of 5 days, with a day of rest after the first two events. The final programme consequently embraced :

I. *Military Competition.*

Combined team and individual competitions consisting of:

1. Long distance ride, 55 km. (33 miles), of which
2. Cross country ride, 5 km. (3 miles).
3. Individual riding over steeplechase course.
4. Prize-Jumping.
5. Prize-Riding.

II. *Prize-Riding Competition.*

Individual competition.

III. *Prize-Jumping Competitions.*

A. Individual competition.

B. Team competition.

Maximum number of competitors from each nation:

in the individual competitions: six (3 reserves),

in the team competition, and

in the combined team- and individual competition: *one team of four men* (two reserves), the first three to count.

A competitor was allowed to enter not more than two horses, but was not allowed to ride more than one horse in the same competition.

Entries closed the 1 June, 1912.

Propositions.

As the basis of the propositions there was adopted, from the very first, the scheme drawn up in Sweden in 1907 and which was laid before the Meeting at the Hague, together with the plan adopted for the "Military" competition as already held in Sweden for a number of years past. In addition to this, material was obtained from competitions held abroad, and draft propositions were then drawn up and afterwards sent to a number of cavalry officers who were considered to be authorities in the matter.

Military : In drawing up the regulations for this competition, the Committee was of the opinion that, unlike the other competitions, this event should only be open to officers actually serving, and that the riders should be mounted on their service horses, whether these were provided by the State or owned by the officers themselves. This resolution, however, caused a number of difficulties in drawing up the propositions, and as, at a number of Military Riding Schools abroad, there are special horses, belonging to the State, which are employed for purposes of instruction, it was determined that such horses should not be included in the term "Service horses". The question of a minimum weight being fixed or not was much discussed. On the one hand it was pointed out that, in such a severe competition, it would be desirable to allow all the horses to compete without their being handicapped by any difference in weight; on the other

hand it was thought possible that some riders would be obliged to ride with dead weight, and this, in some quarters, was considered unsuitable. A minimum weight of 80 kg. (circa 13 st.) was fixed, based on the principle that the competition, being a "Field" event, ought to be carried out under such weight conditions corresponding to those under which an officer of average weight rides when carrying field-accoutrements. With respect to the order in which the various tests should be executed, it was thought best to place the prize riding last, as the clearest obedience-test could thereby be obtained. A well trained horse that has been severely taxed should, even after taking part in the previous tests, be able to do itself justice in the final one too. The propositions for the horse riding competitions will be found among the Rules at the end of the book.

Prize Riding: In drawing up the programme for the prize riding, the Committee considered that, as this was an international competition, the best thing would be to give a specimen of a display-programme, with a detailed account of the order in which the various movements should most suitably be carried out. As an international jury was to judge the prize riding, it would have been a rather hard task to obtain an accurate calculation of the merits of the riders, unless the movements executed had, so to say, been forced within the limits of a certain programme.

After the principles of the programme had been fixed and its main features drafted, the whole was given to Lieut.-Colonel G. A. Boltens-tern, the then chief of the Military Riding School, who drew up the programme in detail and afterwards, at the Riding School, tested the suitability and also the possibility of carrying it out in the time fixed, in the tempo and within the time allowed for the various movements. The propositions, principles of judging, etc., for the prize riding, will be found at the end of the book.

The Prize Jumping: With regard to the propositions for the prize jumping, consideration had to be paid to the limited possibilities offered by the Stadium — in consequence of the little space available there — as regards the number and character of the obstacles, the tempo, etc. A draft-list of obstacles had been drawn up by Captain, Baron N. Palmstierna, and this was laid before the Committee, together with the programme and propositions, at its meeting on the 22 March, 1911. The Committee then determined that, before being accepted, the proposed obstacles, together with the propositions for the prize riding, should be tested during the competitions that were to take place in the spring of 1911. It was not before the meeting held on the 29 June of that year that the programme, propositions and list of obstacles were finally decided on, as a result of the experience gained by the Committee during the competitions held in 1911. As regards the obstacles, the original list was accepted without any alterations. Immediately after the programme and propositions had been fixed, they were printed, and then translated into German, French and English. In this work of translation the Committee obtained most valuable help from the Rev. Dr. Sterzel, Professor Schulthess and Mr.

Kidd, and the Committee wishes to express its deep sense of gratitude for all the pains these gentlemen took in order to have the programme and the propositions as correct as possible, even in technical respects. This work was finished in November, 1911, after which the programme and propositions were immediately sent by the Foreign Office and the Swedish Olympic Committee to the War Departments and Olympic Committees abroad.

When the programme for the prize jumping was being determined, the question was also raised of giving a prize for high jumping, but it was negatived, partly in consequence of the limited time available for the competitions, and also because such a competition necessitated special training of the horses, this being at variance with the general principles on which the competitions were based.

The propositions and principles for judging, etc., of the prize jumping, can be found at the end of the book.

PREPARATIONS FOR SWEDEN'S PARTICIPATION IN THE COMPETITIONS.

From the very first moment the Committee felt assured that Sweden's participation in the Horse Riding competitions of the Olympic Games would not result in success, unless the work of training was organized, and unless trial competitions were arranged which were in accordance with the propositions in force for the Olympic Games, and in which the same obstacles would be used as those fixed for these last-named events. As, however, taking part in the training and these competitions, would occasion the individual officer great expense, larger money prizes had to be offered than those usually given in Sweden. This found expression in the first estimates adopted by the Committee on the 15 December, 1910, according to which Kr. 5,000 (£ 275 : \$ 1,375) was to be devoted to the Swedish try outs, etc., for the Horse Riding competitions of the Olympic Games. At a meeting held on the 3 February, 1911, the Committee determined to devote a large sum to the support of the Horse Riding competitions at the Horse Show which was to be held in Stockholm during the spring of the same year, and, at a meeting on the 8 May, 1911, the question was again raised of the preparations for Sweden's participation in the coming competition.

With regard to the scope of the try outs, it was determined that the programme should include the Military, prize riding and prize jumping. It was also determined to write to H. R. H. Prince Carl, Inspector of the Swedish Cavalry requesting that the propositions for the Army-Military for 1912 might be drawn up in agreement with those adopted for the Military try outs, and also that the Army "Military" should be arranged in connection with the try outs.

A sum of not less than Kr. 20,000 (£ 1,100 : \$ 5,500) was assigned as money prizes for the try outs. The principle was adopted in drawing up the regulations for the competitions in question, that those desirous of representing Sweden in the Olympic Games had to take part in

the try outs, while the money prizes offered for the try outs were not to be given until after the Olympic Games. In addition to this, the Hon. President, H. R. H. Prince Carl, expressed his intention to exhort the Cavalry Regiments to take part in the competitions and to make inquiries respecting the preparatory steps taken, or about to be taken, by the various regiments, so as to enable Sweden to take part in the Olympic Games. At the next meeting of the Committee the try outs were made still more thorough by the determination then come to, that preliminary competitions should precede the try outs, so as to make both riders and horses better accustomed to taking part in competitions. Small money prizes were to be awarded at these events, too.

In accordance with the above, the following programme was arranged for the preparatory competitions and try outs:

I. *Prize Riding and Prize Jumping.*

- a) Early in the spring of 1912, competitions for the various regiments.
- b) *Preliminary competitions* at Gothenburg, Malmo, Norrköping and Stockholm, in connection with Horse Shows and competitions at these places.
- c) *Try outs* in connection with the Horse Show in Stockholm during the latter part of May.

It was thought best to arrange only one such try out, this to take place in Stockholm, and to be the final trial competition.

II. *Military.*

At a meeting on the 8 September, 1911, it proved necessary to alter the above programme. According to the new arrangements, the try outs in prize riding and prize jumping were to be arranged by the Småland-Östergötland Field Riding Club and were to be held at Norrköping, while the preliminary competitions for the try outs in question were to be held at Gothenburg, Malmö, and Stockholm. The Committee gave a sum of Kr. 1,500 (£ 82 : \$410) each to the Gothenburg and the Scanian Field Riding Clubs and to the Horse Show Committee in Stockholm, of which sum, Kr. 900 (£ 50 : \$ 250) was to be awarded for prize jumping and Kr. 600 (\$32 : \$ 160) for prize riding.

Kr. 13,000 (£ 715 \$ 3,575) was assigned to the try outs, this sum being divided as follows:

(“Military” Kr. 4,500 (\$ 250 : \$ 1,250); prize riding, Kr. 3,000 (£ 83 : \$ 415), and prize jumping Kr. 5,500 (£ 382 : \$ 1,910). The following regulations were to be observed at the preliminary competitions and the try outs:

Preliminary competitions.

- I. The Field Riding Club in question shall itself appoint judges, but it must not employ those persons who have been requested by the Committee for the Horse Riding competitions to act as judges at the try outs.

2. Competitors in a preliminary meeting shall pay an entrance fee of Kr. 10 (11/- : \$ 2,68). The sum obtained in this way shall be used to increase the money prizes given in the various preliminary competitions.

3. All the original protocols of the judges at the preliminary competitions shall be in the hands of the Committee for the Horse Riding competitions not later than the 25 May, 1912.

The Try Outs.

1. The general regulations issued for the try outs by the Field Riding Club must be approved of by the Committee for the Horse Riding competitions.

2. Participation in the try outs is obligatory for entries for the Horse Riding competitions of the Olympic Games, unless the Committee determines otherwise in special cases.

3. In order to obtain a money prize at the try outs, it is necessary that both rider and horse be approved of for participation in the Horse Riding competitions of the Olympic Games, and that rider and horse take part in these said competitions in such way as the Committee shall determine, unless an obstacle arise that can be accepted by the Committee as a sufficient excuse.

4. Money prizes awarded at the try outs will not be given before the close of the Olympic Games.

5. The Committee shall decide in each special case what can be accepted as a lawful excuse for the non-participation of rider or horse in the Olympic Games.

6. Non-participation in the Games will cause the loss of the prize unless the excuse be accepted.

7. If, in the try outs, the number of accepted competitors does not amount to the number of prizes, those money prizes that cannot be awarded shall be employed to increase the value of the prizes for those placed in the competitions in question.

8. Should anything happen to prevent a rider or horse, chosen at a try out, from taking part in the Olympic Competitions, information shall immediately be sent by telegram to the Committee for the Horse Riding competitions.

In order to still further increase the interest for these preliminary competitions, the Committee resolved to devote Kr. 1,000 (£ 55 : \$ 275) to the purchase of a Prize of Honour to be awarded to that regiment which had worked most successfully for the preliminary competitions and the try outs for the Olympic Games. This prize of honour, which consisted of an equestrian statue by Fagerberg, was afterwards presented to the Committee by F. Löwenadler, Esq., and was won by the Royal Horse Guards.

In order that the Committee could be assured that the preliminary competitions would be arranged in agreement with the rules and regulations fixed for the Olympic Games, it was determined that the Body undertaking the organization of the preliminary competitions should be requested to have the course in full agreement with that which would be made at the Stadium, in respect to the number, sequence and dimensions of the obstacles. In order to encourage training, the Committee also determined to allot Kr. 3,000 (£ 165 : \$ 825) for division among those garrisons that expressed a desire to take part in the work, the money to be employed for the construction of the obstacles. A contribution towards the cost of training could only be expected if three, at least, of the officers of the garrison went into training, and if the chief of the regiment made himself responsible for the construction of the obstacles, and for the work of training being organized in the district.

During the spring of 1912 the preliminary competitions and try outs took place in accordance with the above mentioned programme,

with the exception that the try out for the Military took place in Stockholm in the middle of June. After the try outs in Norrköping on the 25 May, the Committee considered it necessary to still further concentrate the work of training and that an "inspection-competition" was desirable, and so the Committee determined to send a number of riders and horses to the Riding School at Strömsholm in order to continue training there. An inspection-competition was to be held at Strömsholm on the 30 June, the day before the close of entries, at which competition the entire Committee should be present and when the final try outs were to take place. This was rendered possible by a private person placing a sum of Kr. 6,000 (£ 336 \$ 1,650) at the disposal of the Committee, to cover the travelling and living expenses of the officers, etc., chosen for this training.

While the plan of organization and the work of training for Sweden's participation in the Horse Riding competitions of the Olympic Games was being carried out, and also during the progress of the preliminary competitions, varying opinions prevailed as to whether the work would tend to the success of the Swedish competitors. The results of the competitions have shown, however, that the Committee had performed its responsible task most satisfactorily, both as regards the plan of the work and the choice of representatives finally made.

SUB-COMMITTEES.

During the spring of 1911 it proved necessary to take measures for the decentralization of the work of the Committee, by forming sub-committees for various purposes, and by adding suitable persons to the Committee itself. The Chief Committee was accordingly subdivided into sections, the final constitution of the Committee being as follows :

Hon. President: H. R. H. PRINCE CARL.

President: Colonel, Count E. OXENSTIERNA.

1. *Secretariat.*

General Secretary : Count CL. von ROSEN, Master of the Horse.

Secretary : Lieutenant C. TRÄGÅRDH.

Treasurer : Captain, Count FAB. F:SON WREDE.

2. *Executive Committee.*

President : Major, Baron CL. CEDERSTROM.

General Secretary : Count CL. VON ROSEN.

Secretary : Lieutenant C. TRÄGÅRDH.

Treasurer : Captain, Count FAB. F:SON WREDE.

Captain, Baron N. PALMSTIERNA.

J. PHILIPSON, Esq.

3. *Reception Committee.*

President : Colonel G. TORÉN.

Secretary : Lieutenant, Count CH. LEWENHAUPT.

A. *Accommodation Bureau:*

Director: Captain, Count G. L. HAMILTON.
Secretary: Lieutenant C. VON HORN.

Guides.

Belgium: Captain B. G:SON HOLM.
Denmark: Lieutenant F. MARTIN.
France: Captain R. CEDERSCHIÖLD.
Germany: Lieutenant W. LÖWENHJELM.
Great Britain: Canada , Lieutenant C. BJÖRNSTIERNA.
Norway: Lieutenant W. KLEEN.
Russia: Lieutenant C. VON HORN.
U. S. A.: Chili: Lieutenant, Count N. BONDE.

B. *Stabling Bureau:*

Director: Lieutenant G. HERNLUND.
Assistant: Lieutenant J. MALMSTEN.
» Lieutenant, Baron S. ÅKERHJELM.

C. *Travelling Bureau:*

Director: Lieutenant I. ÖSTERMAN.

Representatives:

Gothenburg: Lieutenant K. VON SYDOW.
Malmö: Lieutenant, Baron FR. BENNET.
Stockholm: The Director.
Trelleborg: Lieutenant, Baron M. FALKENBERG.

4. *Entertainments Committee:*

President: Colonel, Baron C. ROSENBLAD.
Vice-President: Lieutenant-Colonel, Count R. VON ROSEN.
Secretary: Lieutenant E. ALB:SON UGGLA.
Major C. G. O. ANKARCRONA.
Major G. BJÖRNSTRÖM.
Captain, Baron C. VON ESSEN.
Lieutenant O. ANKARCRONA.
Lieutenant, Baron S. ÅKERHJELM.

5. *Jury:*

President: Colonel B. MUNCK.
Secretary: Captain J. MAULE.

A. *Field Competition:*

President: Colonel, Count TH. RUDENSCHIÖLD.
Adjutant: Captain C. KNÖS.

B. *Prize Riding:*

President: Lieut.-Col., Baron B. CEDERSTRÖM.
Adjutant: Lieut., Baron FR. BENNET.
Major W. CRONEBORG.
Major P. KARSTEN.
Captain A. AHNSTRÖM, Adjoined member.

Countries represented:

France.
Germany.
Norway.
Russia.

C. *Prize Jumping:*

President: Lieut.-Col., Baron A. ADELSWÄRD.
Adjutant: Lieut. B. SALMSON.
Adjoined member: Lieut. Col. J. ÅKERMAN.
In addition to 15 officers (*v.* officials).

6. *International jury :*

President: Colonel G. NYBLÆUS.
Member: Lieut.-Col., Count R. VON ROSEN.

Countries represented:

Belgium.
Denmark.
France.
Germany.
Great Britain.
Norway.
Russia.
U. S. A.

7. *Advertisement Committee:*

General Secretary: Count CL. VON ROSEN, Master of the
Horse.
Lieut., Count C. G. LEWENHAUPT.

8. *Press Bureau:*

Lieutenant S. GADD.

The first sub-committee to begin work was the Reception Committee, which was placed under the Presidency of Colonel G. Torén, and was divided into the following sections:

The Accommodation Bureau, the Stabling Bureau and the Traveling Bureau.

Of these sections, the *Accommodation Bureau* began its labours in the spring of 1911, by making agreements respecting rooms and board with a number of large hotels in Stockholm.

The *Stabling Bureau* commenced operations at the beginning of 1912. An application to the King-in Council resulted in horses from abroad that were to take part in the Olympic Games, being allowed to enter Sweden without staying in quarantine. The condition was attached, however, that the horses from abroad should be brought into as little contact as possible with Swedish mounts. It therefore became necessary to procure special stables for the horses in question, and, permission being obtained of the military authorities to fit up the so-called north Summer Stables of the Svea Artillery Regiments for the horses from abroad, the building was provided with boxes, accommodation for the grooms, etc.

The *Travelling Bureau*. Representatives were appointed at Gothenburg, Malmö, Trelleborg and Stockholm, and special instructions issued to them, according to which they had to render assistance to competitors, of whose arrival (with or without horses), at the various ports, information had been sent by the Committee. Special instructions were also issued for the transport of the horses, and for the journey of the competitors, to and from the Games, all of which will be found on pp. 613—615.

Guides were appointed by the Reception Committee, each foreign nation being assigned one of the number, whose duty it was to keep the competitors entrusted to his charge informed of the time and place of the competitions, entertainments, etc., during the whole period of their stay in Stockholm. The guides had also to see that the hotels satisfactorily carried out the engagements they had undertaken.

During the Games, the guides assembled daily in order to receive their instructions, etc. The guides had also to be fully acquainted with all the rules and regulations and the programme of the competitions, so as to be able to supply the guests with the information they might desire.

The Executive Committee also published a Memorandum for the Horse Riding competitions, together with a P. M. for the competitors, the little book being distributed by the guides to all the foreigners taking part in the Horse Riding competitions. Its contents are given on pp. 612—613.

During the spring of 1912 it proved necessary for the Committee to hire special offices, and with the kind help of H. R. H. Prince Carl, President of the Red Cross Society, large central offices were obtained at the premises of the Society, 4 Karlavägen.

CHALLENGE PRIZES.

During the course of the Olympic Games in London, Count Géza Andrassy had presented a challenge prize for the Horse Riding Competitions, but as none were held in 1908, the prize was placed in the hands of the Committee for the Horse Riding Competitions of the

Olympic Games of Stockholm, 1912 and was awarded to the winner of the individual prize jumping.

According to a ruling of the International Olympic Committee at its meeting at Luxemburg in 1910, prizes at the Olympic Games may consist only of medals and diplomas, though challenge prizes can also be awarded. In order to obtain a large number of entries to the Horse Riding Competitions in spite of the absence of money prizes, the Committee, from the very first, endeavoured to obtain challenge prizes for all the competitions. The General Secretary, Count Cl. von Rosen succeeded in doing so, during the course of the journeys undertaken on behalf of the Committee, and the result far surpassed that body's wildest hopes, no less than four monarchs each placing a challenge prize at its disposal, three of the gifts to be awarded at the Horse Riding competitions. This fact probably contributed most essentially to the large number of entries from abroad in these events, while it also set a grand and international stamp on the first Olympiad of the competitions in question.

At the horse riding competitions the following prizes were awarded:

Military: The German Emperor's challenge prize, a magnificent silver shield, on which was engraved the portrait of the Emperor; for *Prize Riding:* the Emperor of Austria's prize, an equestrian statuette in silver (a copy of the statue of Prince Eugene of Savoy in Vienna); and for *Team Prize Jumping:* the King of Italy's prize, a silver-gilt "Victory" on a marble base.

The Swedish Cavalry had also presented a challenge prize to be awarded to that nation whose representatives obtained the best total results in all the Horse Riding competitions. The prize consisted of an equestrian statue of a Carolean soldier, modelled by Baroness Amen, née Sparre.

Of these prizes, Captain Cariou, on Mignon, won that presented by Count Géza Andrassy. The other challenge prizes were all won by Sweden, and the Committee for the Horse Riding Competitions has succeeded in obtaining for them a worthy place of deposition, permission having been obtained to place them in the Royal Armoury at the Northern Museum.

ENTERTAINMENTS.

In order to worthily welcome the foreign competitors, the Committee arranged a Reception Banquet at Hasselbacken on the 13 July, at which Prince Carl took the chair. There were also present H. R. H. the Crown Prince, Their Royal Highnesses, Prince Wilhelm and Prince Eugen of Sweden, the Grand Dukes Kyrill, Boris and Dmitri of Russia, Prince Friedrich Karl of Prussia, 120 foreign officers and members of the Diplomatic Corps, and about 220 Swedes, amongst whom were the members of the Swedish Olympic Committee. During the banquet, H. R. H. Prince Carl, Hon. President of the Committee, proposed the health of the sovereigns or other Heads of the nations represented and Colonel, Count E. Oxenstierna, proposed the health of the guests from abroad in the following speech:

Altesses royales et impériales! Messieurs!

“Bisher, aber nicht weiter, kamen die Schwedischen Reiter” — “jusqu’ici, mais pas plus loin, sent parvenus les cavaliers suédois”.

Les mots que j’ai cites se trouvent sur une pierre en Moravie, pas très loin de Vienne, et se rapportent aux cavaliers du général suédois Torstenson dans la guerre de 30 ans.

Ils sont loin, ces temps où des cavaliers suédois étaient les hôtes — quelquefois peu bienvenus — des autres peuples sur tous les champs de bataille glorieux de l’Europe.

Pourtant il me semble qu’aujourd’hui est un jour où la cavalerie suédoise est parvenue même plus loin, et qu’elle a obtenu un résultat des plus précieux.

Ce résultat, Messieurs! c’est que vous êtes tous ici, c’est que vous êtes venus maintenant chez nous.

* * *

Quand le président du comité international olympique, le Baron Pierre de Coubertin, commença son oeuvre grandiose, il concevait déjà la pensée de gagner pour l’idée olympique le sport équestre avec son organisation actuelle. Seulement la réalisation de ce programme si juste n’a pas été sans difficultés sérieuses.

Pas moins de cinq fois les jeux olympiques ont été célébrés avant que les cavaliers aient pris place aux rangs des combattants.

* * *

Toute idée juste et saine a une force immanente pour vaincre les difficultés et la resistance qui s’y opposent. La pensée du Baron de Coubertin était de réunir dans les jeux olympiques *tous les sports* ayant justement ces qualités, et à l’aide de partisans convaincus et énergiques, entre lesquels je crois devoir nommer les membres suédois du comité international: le Colonel Balck et le Comte de Rosen, la question s’est approchée peu à peu vers sa solution.

A l’instigation de ces membres, la Reunion olympique d’Athènes, en 1906, a résolu, que dorénavant les jeux équestres seraient inscrits sur le programme olympique et que les Suédois devaient élaborer les règles concernant ces jeux. Ce travail a été fait sous l’auguste patronage de S. A. R. le Prince Royal de Suede.

Néanmoins les jeux olympiques à Londres n’ont pas réalisé nos espérances.

Quand le comité suédois des jeux équestres sous la Présidence d’honneur de S. A. R. le Prince Carl de Suède, Inspecteur de la cavalerie suédoise, a commence, il y a plus de deux ans, ses travaux, tous les doutes n’étaient pas dissipés. Nous avons même discuté un projet d’organiser des jeux équestres internationaux sans leur donner le caractère olympique. On prétendait que notre appel aux sportsmen équestres des nations serait vain, que les grands frais de ces jeux, le prix élevé des chevaux et des transports empecheraient les cavaliers de combattre pour la gloire seule sans autre récompense que les lauriers olympiques.

* * *

Cependant nous avons décidé de nous adresser à vous, pour tenter ce que je voudrais appeler “le saut de tribune des jeux équestres”. C’est que nous avons la foi dans le but à réaliser et dans les sentiments de chevalerie qui n’ont jamais fait défaut dans le coeur des cavaliers.

Le résultat a dépassé toute notre attente. Toutes les nations ont répondu à notre invitation avec une courtoisie parfaite et la plupart ont donné des preuves d'un intérêt réel, même dans les cas où une participation officielle a été impossible. Sa Majesté L'Empereur d'Allemagne, Sa Majesté Apostolique l'Empereur François-Joseph ainsi que Sa Majesté le Roi d'Italie ont daigné nous accorder de magnifiques prix Challenge.

Dans cette salle sont réunis des participants de dix nations différentes dont quelques-unes n'ont pas hésité à amener leurs chevaux de très loin et même de l'autre côté de l'Océan. Le nombre des participants, parmi lesquels nous avons l'honneur de compter S. A. I. le Grand Duc Dmitri de Russie et S. A. R. le Prince Friedrich Carl von Preussen, est imposant.

On ne pouvait certainement demander mieux et c'est avec un sentiment de fierté légitime que le Comité suédois des jeux équestres tient à vous souhaiter la bienvenue et à vous témoigner notre profonde reconnaissance.

En vous rendant à notre appel, vous avez donné une preuve de votre pleine adhésion à cette renaissance physique de l'humanité, à cette lutte contre les forces destructives de la culture qui a trouvé son expression peut-être la plus complète dans les jeux olympiques.

J'ai la conviction, que le sport équestre lui-même ne pourra que gagner à être compté parmi ceux dans lesquels — sans souci des sacrifices pécuniaires et personnels — on combat seulement pour l'honneur.

Au nom de S. A. R. l'Inspecteur de la cavalerie suédoise et du comité suédois des jeux équestres j'ai l'honneur de vous souhaiter, Altesses Royales et Impériales, ainsi qu' à vous tous nos hôtes étrangers, la bienvenue la plus cordiale au milieu de nous.

Your Royal Highnesses; Gentlemen,

In addition to its guests from abroad, the Committee for the Horse Riding competitions has to day the honour of seeing here the Hon. President of the Swedish Olympic Committee, H. R. H. the Crown Prince, together with the President and other members of this Committee; Their Royal Highnesses, the Dukes of Närke and Södermanland; the Swedish honorary members of the Horse Riding Committee; all the members of that vast organization which, during the preparatory work, has stood by our side; the Swedish competitors, members of the Press and others.

I must here confine myself to welcoming our Swedish guests on the part of the Committee for the Horse Riding Competitions, and to respectfully thank Your Royal Highness and the Swedish Olympic Committee for the co-operation which — in spite of all difficulties and differences of opinion — finally made possible the Horse Riding Competitions of the Fifth Olympiad.

Last of all, a word, of praise and recognition to the Swedish officers who have not hesitated to make the sacrifices — both personal and economical — which the honour of Sweden demanded.

I now call upon you, Gentlemen, to unite with us in giving a cheer for Sweden's guests at the Horse Riding competitions of the Fifth Olympiad.

Baron Pierre de Coubertin, President of the International Olympic Committee said a few words in reference to the newly-instituted Horse Riding competitions.

After the close of the Games, the competitors from abroad, the officials, etc., were invited by the officers of the garrison of Stockholm to a banquet at Saltsjöbaden.

THE COMPETITIONS.

As may be seen by the "Programme" and the "Propositions", the competitions included the Military (with 5 sections and consisting of both individual and team events), Prize Riding, individual competition, and two Prize Jumping events, the one merely an individual competition and the other purely a team event. The order in which the various numbers came off and the time at which they were held is shown by the Daily Programme of the Olympic Games. The composition of the International Jury officiating at the competitions, together with the names of the judges, the leaders of the events, the officials and the competitors, can be found in their special places of this book. The competitors, all of whom were officers, represented no less than 10 nations. The order of starting was determined by means of drawing lots. During the four days on which the competition went on, the weather was gloriously fine, although a little warm, the heat causing most trouble during the trials held on the first day — the distance riding and the cross-country ride.

THE MILITARY.

Seven nations took part in this event, Denmark, Germany and Sweden each having entered the maximum number of competitors, 4 riders and 2 reserves; the U. S. A. and France 4, men and 1 reserve; and Belgium and Great Britain, 4 men. All the countries — with the exception of Denmark, which had only three men present — had four representatives at the starts for trials I and 2, the distance riding and cross-country riding. The start and finish were both on the grounds of the Field Riding Club, and the course for the two events named, of a total length of 55 kilometres (33 miles), is shown on the accompanying map. All the competitors were previously shown the course, and Major, Baron Cl. Cederström took them over, and described, the scene of the cross-country ride, which was marked with red flags. In addition to this, a map of the course and definite instructions were given by the guides to the competitors on their arrival in Stockholm. Three riders missed the way, however, and thus lost the right to further participation in this competition. Only one rider exceeded the time-limit (by 40 seconds), this in consequence of his watch being slow. In consequence of the hot weather prevailing, the ground was very hard, but nothing better was to be had in the vicinity of Stockholm. The cross-country course could not be called difficult, the obstacles consisting chiefly of fences, with or without ditches, and streams. The heat was oppressive, and most of the competitors lost weight during the ride, some as much as $4\frac{1}{2}$ lbs., or more, while the saddles grew considerably heavier, by absorption of sweat from the horses.



Map of the Course for the Distance- and Cross-country Riding in the Military.
 1. Start and finish of the Distance ride. 3. Control station. 7, 8. Start and finish of Cross-country ride. 2, 4, 5, 10. watering places. 6, 9. Veterinary surgeon and farrier.

List of Competitors and Horses.

Programme n.º	Name of Rider	Country	Name of Horse	Where foaled	Remarks
1	Adlercreutz, N., Captain Royal Horse Guard.	Sweden	Atout, br., g., a.	Sweden	
3	Horn af Åminne H., Count, Lieut. Royal Scanian Dragoons.	»	Omen, br., g., a.	»	
4	Nordlander, A., Lieut. Royal Scanian Hus- sars.	»	Lady Artist, xx br., m., a.	England	
5	Casparsson, E. G., Lieut. Royal Småland Hus- sars.	»	Irmelin, br., m., a.	Sweden	
7	de Blommaert, E., Bar- on, Capitaine du 1:er régiment de guides.	Belgium	Clonmore, br., g., 12 y.	—	Rode wrong in trial 2. Retired.
8	Convert, Paul, Lieute- nant du 1:er regiment de guides.	»	La Sioute, bl., m., 8 y.	—	Retired after trial 4.
9	Reyntiens, Guy, Lieute- nant du 1:er regiment de guides.	»	Beau Soleil, b., g., 7 y.	—	Rode wrong in trial 2. Retired.
10	de Trannoy; Gaston, Lieutenant du 2:e ré- giment de guides.	»	Capricieux, b., g., 9 Y.	—	Retired after trial 4.
11	Kenna, P. A., Colonel, V. C.	G. Britain	Harmony, br., m., 9 y.	—	
12	Lawrence, Lieutenant, 18th Hussars.	»	Patrick, br., g., 8 y.	Ireland	Fell in trial 3. Retired.
13	Radcliffe-Nash, E., Lieutenant, 16th Lancers.	»	The Flea, br., m., 6 y.	—	
14	Scott, H. S. L., Lieute- nant, 4th Hussars.	»	Whisper II, br., m., 8 y.	—	Rode wrong in trial 3. Retired.
15	d'Astafort, Lieutenant, 6:e Cuirassiers.	France	Castibalza xx b., g., 10 y.	France	Rode wrong in trial 2. Retired
16	Cariou, Capitaine, École d'artillerie.	»	Cocotte, b., m., 12 y.	»	
17	Meyer, Commandant, 3:e Dragons.	»	Allons-y, br., g., a.	»	
18	Seigner, Lieutenant, 12:e Cuirassiers.	»	Dignité br., m., 9 y.	»	
21	Kraft, C. A., Premier- løjtnant, 4. Dragon- regiment.	Denmark	Gorm, br. g., 12 y.	Ireland	Retired after trial 3.
23	Saunte, C. H., Rit- mester 4. Dragon- regiment.	»	Streg, b., g., 9 y.	Mecklen- burg	Retired during trial 2.

Programme n.º	Name of Rider	Country	Name of Horse	Where foaled	Remarks
25	Kirkebjerg, Frode, Premierløjtnant, 2. Feltartilleriregiment.	Denmark	Dibbe-Libbe, br., m., 7 y.	Ireland	Retired after trial 3.
26	Ben Lear, Jr, Lieutenant, 15th Cavalry, U. S. Army.	U. S. A.	Poppy, br., g., a.	America	
27	Graham, Ephraim F., Lieutenant, 15th Cavalry, U. S. Army.	»	Connie, br., g., a.	»	
28	Henry, Guy V., Captain, 13th Cavalry, U. S. Army.	»	Chiswell, b., g., 7 Y.	»	
29	Montgomery, John C., Lieutenant, 7th Cavalry, U. S. Army.	»	Deceive xx br., g., a.	»	
31	V. Lütcken, Oberleutnant, Ulanen-Regiment	Germany	Blue Boy, br., g., a.	Ireland	
32	^{17.} v. Moers, Rittmeister, Militär-Reit-Institut.	»	May-Queen, br., m., 6 y.	England	
33	v. Rochow, Oberleutnant, Ulanen-Regiment	»	Idealist, br., g., 6 y.	Ireland	
34	^{16.} v. Schaesberg-Thannheim, R., Graf, Leutnant, Ulanen-Regiment 5.	»	Grundsee, b., g., a.	England	

Summary of Protocol for Trial 1.

Maximum time, 4 hrs.

Distance 55 km. (33 miles).

Programme n.º	Start n.º	Name of Rider	Started			Arrived			Time taken	Time deduction	Total points	Remarks
			hr.	min.	sec.	hr.	min.	sec.				
5	1	Casparsson	8	—	—	11	52	41	3,52'41"	—	10	
8	2	Convert	8	5	—	11	50	31	3,45'31"	—	10	
12	3	Lawrence	8	10	—	12	03	48	3,53'48"	—	10	
16	4	Cariou	8	15	—	11	50	31	3,35'31"	—	10	
21	5	Kraft	8	20	—	12	15	38	3,55'38"	—	10	
27	6	Graham	8	25	—	12	16	06	3,51'06"	—	10	
34	7	v. Schaesberg-Thannheim	8	30	—	12	22	59	3,52'59"	—	10	
1	8	Adlercreutz	8	35	—	12	28	30	3,53'30"	—	10	
10	9	de Trannoy	8	40	—	12	29	05	3,59'05"	—	10	
13	10	Radcliffe-Nash	8	45	—	12	40	28	3,55'28"	—	10	
17	11	Meyer	8	50	—	12	41	47	3,51'47"	—	10	
25	12	Kirkebjerg	8	55	—	12	53	50	3,58'50"	—	10	

Programme n.r.	Start n.r.	Name of Rider	Started			Arrived			Time taken	Time deduction	Total points	Remarks
			hr.	min.	sec.	hr.	min.	sec.				
28	13	Henry	9	—	—	12	56	19	3,56'19"	—	10	Retired
33	14	v. Rochom.....	9	5	—	1	03	41	3,58'41"	—	10	
3	15	Horn af Aminne	9	10	—	1	05	56	3,55'56"	—	10	
9	16	Reyntiens	9	15	—	1	03	41	3,48'41"	—	10	
11	17	Kenna	9	20	30	1	19	25	3,59'25"	—	10	
15	18	d' Astafort	9	25	—	1	07	22	3,42'22"	—	10	
23	19	Saunte	9	30	—	—	—	—	—	—	—	
26	20	Ben Lear, Jr.....	9	35	—	1	25	34	3,50'34"	—	10	
32	21	v. Moers.....	9	40	—	1	31	30	3,51'30"	—	10	
4	22	Nordlander	9	45	—	1	34	03	3,49'09"	—	10	
7	23	de Blommaert	9	50	—	1	34	08	3,44'08"	—	10	
14	24	Scott	9	55	—	1	38	48	3,49'48"	—	10	
18	25	Seigner	10	—	—	2	—	40	4,00'40"	1	9	
29	27	Montgomery	10	10	—	2	06	39	3,56'39"	—	10	
31	28	v. Lütcken.....	10	15	—	1	57	12	3,44'12"	—	10	

Maximum time 15 min. Summary of Protocol for Trial 2. Maximum points 130.

Programme n.r.	Start n.r.	Name of Rider	Time taken	Deduction		Total deductions	Total points	Remarks
				for time	for faults			
5	1	Casparsson	10'10"	—	5	5	125	
8	2	Convert	9'12"	—	2	2	128	
12	3	Lawrence	9'8"	—	2	2	128	
16	4	Cariou	10'33"	—	—	—	130	
21	5	Kraft	10'18"	—	—	—	130	
27	6	Graham	11'29"	—	5	5	125	
34	7	v. Schaesberg- Thannheim	9'11"	—	—	—	130	
1	8	Adlercreutz	10'28"	—	2	2	128	
10	9	de Trannoy	11'29"	—	4	4	126	
13	10	Radcliffe-Nash	10'15"	—	4	4	126	
17	11	Meyer	9'43"	—	—	—	130	
25	12	Kirkebjerg	10'8"	—	56	56	74	
28	13	Henry	10'22"	—	7	7	123	
33	14	v. Rochow	9'2"	—	—	—	130	
3	15	Horn af Aminne	9'23"	—	—	—	130	
9	16	Reyntiens	8'35"	—	—	—	—	Rode wrong way. Retired.
11	17	Kenna	11'28"	—	—	—	130	
15	18	d' Astafort	10'38"	—	—	—	—	Rode wrong way. Retired.
23	19	Saunte	—	—	—	—	—	Retired.
26	20	Ben Lear	11'23"	—	—	—	130	
32	21	v. Moers	11'0"	—	—	—	130	
4	22	Nordlander	9'37"	—	—	—	130	
7	23	de Blommaert	8'49"	—	—	—	—	Rode wrong way. Retired.
14	24	Scott	8'44"	—	—	—	130	
18	25	Seigner	11'3"	—	10	10	120	
29	27	Montgomery	11'1"	—	—	—	130	
31	28	v. Lütcken	9'25"	—	—	—	130	

Individual Placing after Trials 1 and 2.

Programme n.r.	Name of Rider	Total points	Placing	Remarks
3	Horn af Aminne	20	1	
4	Nordlander	20	1	
11	Kenna	20	1	
14	Scott	20	1	
16	Cariou	20	1	
17	Meyer	20	1	
21	Kraft	20	1	
26	Ben Lear	20	1	
29	Montgomery	20	1	
31	v. Lutcken	20	1	
32	v. Moers	20	1	
33	v. Rochow	20	1	
34	v. Schaesberg-Thannheim	20	1	
1	Adlercreutz	19.85	2	
8	Convert	19.85	2	
12	Lawrence	19.85	2	
10	de Trannoy	19.69	3	
13	Radcliffe-Nash	19.69	3	
5	Casparsson	19.62	4	
27	Graham	19.62	4	
28	Henry	19.46	5	
18	Seigner	18.23	6	
25	Kirkebjerg	15.69	7	

The next trial — individual riding over steeple-chase course — took place at Lindarängen, there being 22 competitors. Of these, two rode the wrong way and retired, one of them, Lieutenant Lawrence (Great Britain) falling at a grass-covered ditch outside the course, the accident causing a slight concussion of the brain, from which the rider soon recovered, however.

Summary of Protocol for Trial 3.

Maximum time 5 m. 50 sec.

Maximum points 100.

Programme n.r.	Start n.r.	Name of Rider	Time taken	Deduction		Total deductions	Total points	Remarks
				for time	for obstacles			
5	1	Casparsson	5'22"	—	—	—	100	
8	2	Convert	5'37"	—	—	—	100	
12	3	Lawrence	—	—	—	—	—	Fell. Retired.
16	4	Cariou	5'45"	—	—	—	100	
27	6	Graham	5'45"	—	—	—	100	
34	7	v. Schaesberg-Thannheim	5'38'	—	—	—	100	
1	8	Adlercreutz	5'36'	—	—	—	100	
10	9	de Trannoy	5'31"	—	—	—	100	

Programme n.º	Start n.º	Name of Rider	Time taken	Deduction		Total deductions	Total points	Remarks
				for time	for obstacles			
13	10	Radcliffe-Nash ...	5'58"	16	—	16	84	
17	11	Meyer.....	5'37"	—	—	—	100	
25	12	Kirkebjerg	5'25"	—	—	—	100	
28	13	Henry.....	5'46"	—	—	—	100	
33	14	v. Rochow.....	5'22"	—	—	—	100	
3	15	Horn af Aminne	5'40"	—	—	—	100	
11	17	Kenna	5'53"	6	—	6	94	
26	20	Ben Lear	5'41"	—	—	—	100	
32	21	v. Moers	5'59"	18	—	18	82	
4	22	Nordlander ...	5'19"	—	—	—	100	
14	24	Scott	5'35"	—	—	—	—	Rode wrong way. Retired.
18	25	Seigner	5'40"	—	—	—	100	
29	27	Montgomery ...	5'40"	—	—	—	100	
31	28	v. Lutcken.....	5'30"	—	—	—	100	

Individual Placing after Trials 1—3

Programme n.º	Name of Rider	Total points	Placing	Remarks
3	Horn af Aminne.....	30	1	
4	Nordlander	30	1	
16	Cariou	30	1	
17	Meyer	30	1	
26	Ben Lear.....	30	1	
29	Montgomery	30	1	
31	v. Lutcken	30	1	
33	v. Rochow	30	1	
34	v. Schaesberg-Thannheim	30	1	
1	Adlercreuts	29.85	2	
8	Convert	29.85	2	
10	de Trannoy.....	29.69	3	
5	Casparsson	29.62	4	
27	Graham	29.62	4	
28	Henry	29.46	5	
11	Kenna	29.40	6	
18	Seigner	28.23	7	
32	v. Moers	28.20	8	
13	Radcliffe-Nash	28.09	9	
25	Kirkebjerg	25.69	10	

Trial 4 — the Prize Jumping — took place at the Stadium, which, after the presentation on Monday afternoon of the prizes won in field and track events, had been transformed into an obstacle-course, with flower-beds here and there. In this event there were 19 competitors, 2 of whom did not clear the obstacles perfectly. The obstacles, which were of small dimensions and fewer in number than for the other prize jumping events, can be seen in the illustrated supplements, 1 and 2, to the Programme and the Propositions.

Maximum time 2 min. 45 sec.

Summary of Protocol for Trial 4.

Maximum points 150.

Programme n.r	Name of Rider	Time taken	Deduction for faults at obstacle													Total Deductions	Total points	Remarks		
			1 Hedge	2 Fence	3 Stone-Wall	4 Railway-gates	5 Triple-bar	6 Fence in Dike	7 Hedge and Top Bar	8 Fence—Dike Hedge	9 Fence	10 Brick-Wall	11 Country Road	12 Earth-Wall with Bar	13 Stone-Wall—Dike- Stone-Wall				14 Bank-Fence	15 Dike
1	Adlercreutz	2 : 42	—	—	4	—	—	—	—	4	4	1	—	—	—	2	—	15	135	1) Did not take the Bank-Fence. 2) Did not clear the obstacle.
3	Horn af Aminne	2 : 49 ² / ₅	2	—	4	—	2	1	1	4	4	1	1	—	4	—	2	26	124	
4	Nordlander	2 : 46	2	—	—	5	1	—	—	4	—	—	—	—	4	—	—	16	134	
5	Casparsson.....	2 : 44 ³ / ₅	—	—	—	2	—	—	—	—	—	1	—	—	—	—	—	5	145	
8	Convert.....	3 : 17	14	—	—	1	—	1	—	—	2	1	—	—	6	—	—	25	125	
10	de Trannoy.....	3 : 12 ² / ₅	12	—	—	2	—	1	1	1	2	1	—	—	1)	—	—	22	128	
11	Kenna	3 : 20	14	—	—	—	—	—	—	4	—	—	—	—	—	—	—	18	132	
13	Radcliffe-Nash	3 : 14	12	—	—	4	—	—	—	4	—	—	1	—	6	—	—	27	123	
16	Cariou	3 : 16	14	—	1	—	—	—	—	2	1	1	—	2	—	—	—	21	129	
17	Meyer	2 : 47	2	—	—	1	—	—	—	4	—	—	—	—	—	—	—	7	143	
18	Seigner.....	2 : 51	4	—	—	—	—	—	—	4	2	—	—	—	—	—	—	10	140	
26	Ben Lear, Jr.....	2 : 55 ¹ / ₅	6	—	—	—	2	2	—	2	—	1	—	—	1	—	—	14	136	
27	Graham.....	2 : 33 ³ / ₅	—	—	—	2	—	—	—	4	2	1	—	—	—	—	—	9	141	
28	Henry	2 : 33 ⁴ / ₅	—	—	—	5	—	—	—	4	4	4	—	—	—	—	—	13	137	
29	Montgomery.....	2 : 47 ² / ₅	2	—	—	—	—	—	—	2	4	1	—	—	—	—	—	9	141	
31	v. Lütcken.....	2 : 41	—	—	—	3	4	—	—	4	—	—	—	—	—	—	—	11	139	
32	v. Moers	2 : 48	2	—	—	8	—	—	—	4	—	1	—	—	4	—	—	20	130	
33	v. Rochow.....	2 : 44	—	—	—	1	1	—	—	4	—	1	—	—	—	—	—	7	143	
34	w Schaesberg-Thannheim	2 : 43 ⁴ / ₅	—	—	—	1	—	—	—	4	—	—	—	—	4	—	—	9	141	

Individual Placing after Trials 1-4.

Programme n.r.	Name of Rider	Total points	Placing	Remarks
17	Meyer	39.53	1	
33	v. Rochow	39.53	1	
29	Montgomery.....	39.40	2	
34	v.Schaesberg-Thannheim	39.40	2	
5	Casparsson	39.29	3	
31	v. Lütcken	39.27	4	
26	Ben Lear.....	39.07	5	
27	Graham	39.02	6	
4	Nordlander	38.93	7	
1	Adlercreutz	38.85	8	
16	Cariou	38.60	9	
28	Henry	38.59	10	
3	Horn of Aminne	38.27	11	
8	Convert	38.18	12	
18	Seigner	37.56	13	
32	v. Moers.....	36.87	14	
13	Radcliffe-Nash	36.29	15	

In this Prize Jumping, the maximum time was exceeded by no less than 12 of the 19 competitors, this, however, apparently serving as a warning, for in the two remaining jumping events, the maximum time was exceeded by only 8 of 54 riders.

The fifth trial, which took place at the Stadium, decided the competition in favour of the Swedish contingent. The number of competitors in this last trial had now fallen to 15. The order in which the four remaining nations stood *before* this last event was as follows:

Germany	118,20 points
U. S. A.	117,49 »
Sweden.....	117,07 »
France	115,69 »

Summary of Protocol for Trial 5.
Total maximum points 770.

Programme n.r.	Name of Rider	Total points given by judges							Total points	Remarks
		88	85	82	79	76	73	70		
1	Adlercreutz	88	58,2	97	74	83	93	81	574,2	
3	Horn af Aminne	90	63,8	86	65	99	98	82	583,8	
4	Nordlander	85	63	90	64	102	99	87	590	
5	Casparsson.....	82	54	94	52	87	89	71	529	
16	Cariou	99	56,2	96	73	100	85	85	594,2	
17	Meyer.....	93	47	91	46	61	56	50	444	
18	Yeigner	92	61,2	101	65	93	88	84	584,2	
26	Ben Lear, Jr.....	101	58	85	48	71	82	82	527	
27	Graham	85	51,5	82	47	72	77	69	483,5	
28	Henry	91	55,5	86	58	77	88	80	535,5	
29	Montgomery	89	56	75	49	69	86	75	499	
31	v. Lütcken.....	91	58,5	89	51	72	78	71	510,5	
32	v. Moers.....	93	60,5	87	78	94	89	81	582,5	
33	v. Rochow.....	84	54,7	81	60	81	84	86	530,7	
34	v. Schaesberg-Thannheim.....	87	57,5	81	56	86	80	73	520,5	

Final results.

Programme nr.	Name of Rider	Trial 1	Trial 2	Trial 3	Trial 4	Trial 5	Total	Individual Placing	Total points in team comp. (best 3 competitors)	Placing in team competition
4	Nordlander	10	10	10	8,93	7,66	46,59	1	139,06	I
1	Adlercreutz	10	9,85	10	9,00	7,46	46,31	4		
5	Casparsson	10	9,62	10	9,67	6,87	46,16	5		
3	Horn af Äminne	10	10	10	8,27	7,58	45,85	9		
33	v. Rochow	10	10	10	9,53	6,39	46,42	2	138,48	II
34	v. Schaesberg-Thannheim.....	10	10	10	9,40	6,76	46,16	5		
31	v. Lütcken	10	10	10	9,27	6,63	45,90	7		
32	v. Moers.....	10	10	8,2	8,67	7,56	44,43	13		
26	Ben Lear, J.	10	10	10	9,07	6,84	45,91	6	137,33	III
29	Montgomery	10	10	10	9,40	6,48	45,88	8		
28	Henry.....	10	9,46	10	9,13	6,95	45,54	10		
27	Graham	10	9,62	10	9,40	6,28	45,30	11		
16	Cariou.....	10	10	10	8,60	7,72	46,32	3	136,77	IV
17	Meyer.....	10	10	10	9,53	5,77	45,30	11		
18	Seigner	9	9,23	10	9,33	7,59	45,15	12		



GERMANY'S TEAM IN THE FIELD COMPETITION ("MILITARY"). 2:nd prize.
Lieutenant VON ROCHOW; Lieutenant VON LÜTKEN; Lieutenant, Count
VON SCHAESBERG-THANNHEIM.

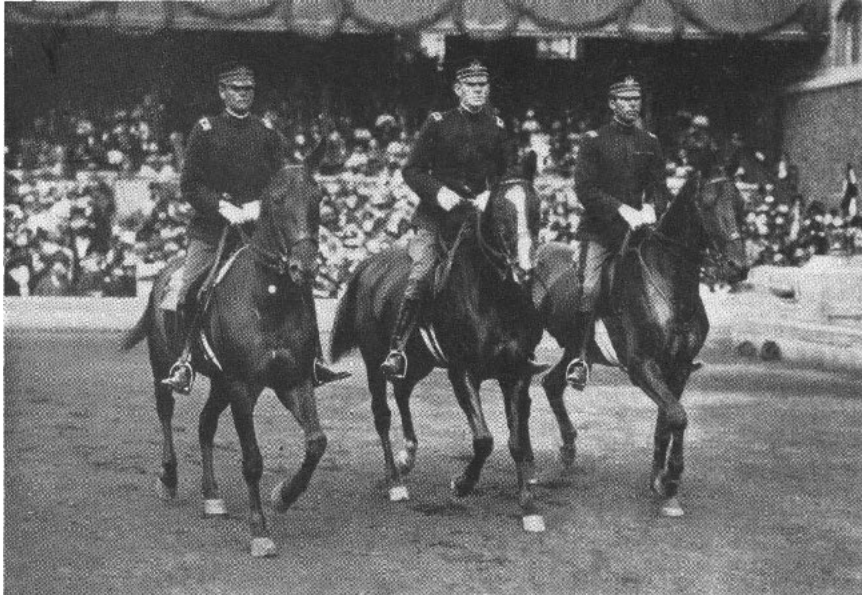

U. S. A. TEAM IN FIELD COMPETITION ("MILITARY"). 3:rd prize.
Captain HENRY; Lieutenant MONTGOMERY; Lieutenant BEN LEAR.



INDIVIDUAL COMPETITION IN THE FIELD COMPETITION ("MILITARY").
Lieutenant VON ROCHOW, Germany, 2:nd prize.

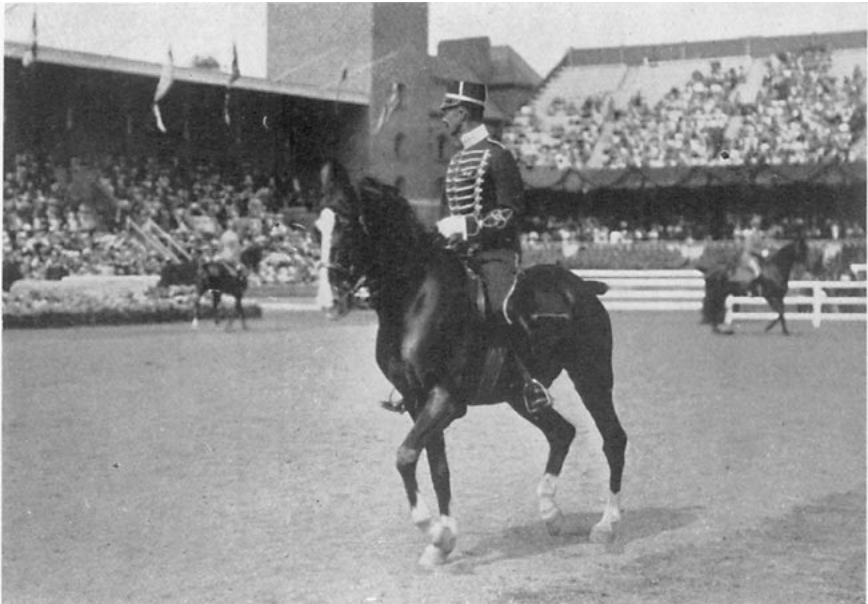

PRIZE RIDING. Captain, Count C. BONDE, Sweden, 1:st prize.

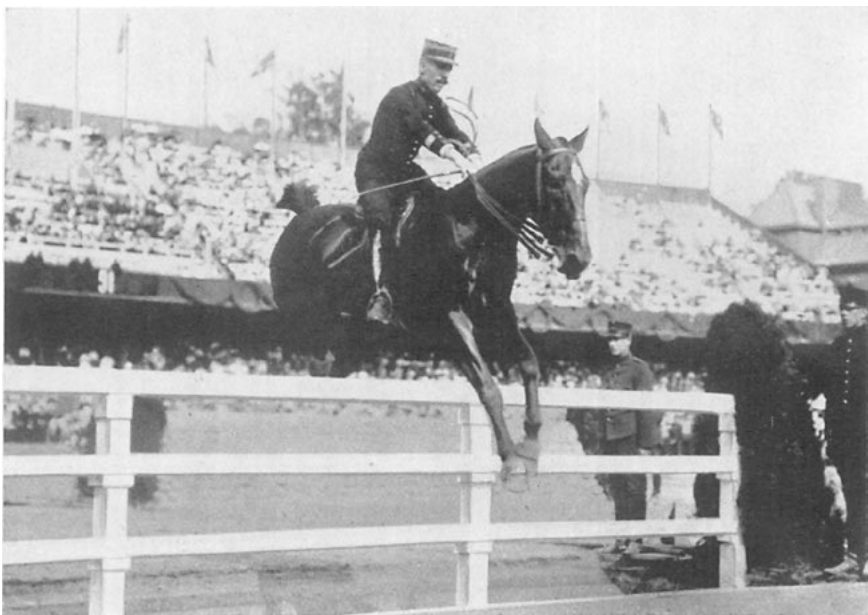

INDIVIDUAL PRIZE JUMPING. Captain CARIOU, France, 1:st prize.



INDIVIDUAL PRIZE JUMPING. Captain, Baron DE BLOMMAERT, Belgium, 3:rd prize.



INDIVIDUAL PRIZE JUMPING. H. R. H. Prince FRIEDRICH KARL of Prussia.



INDIVIDUAL PRIZE JUMPING. Captain RODZIANKO, Russia.

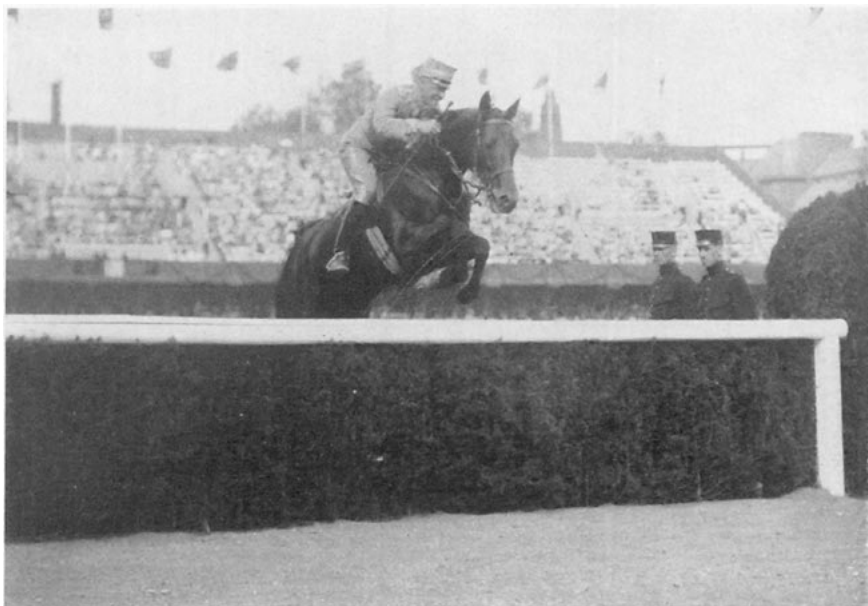

INDIVIDUAL PRIZE JUMPING. Lieutenant, Count G. LEWENHAUPT.



THE TEAM OF FRANCE IN TEAM PRIZE JUMPING. 2:nd prize.
Lieutenant D'ASTAFORT; Major MEYER; Captain CARIOU; Lieutenant SEIGNER.

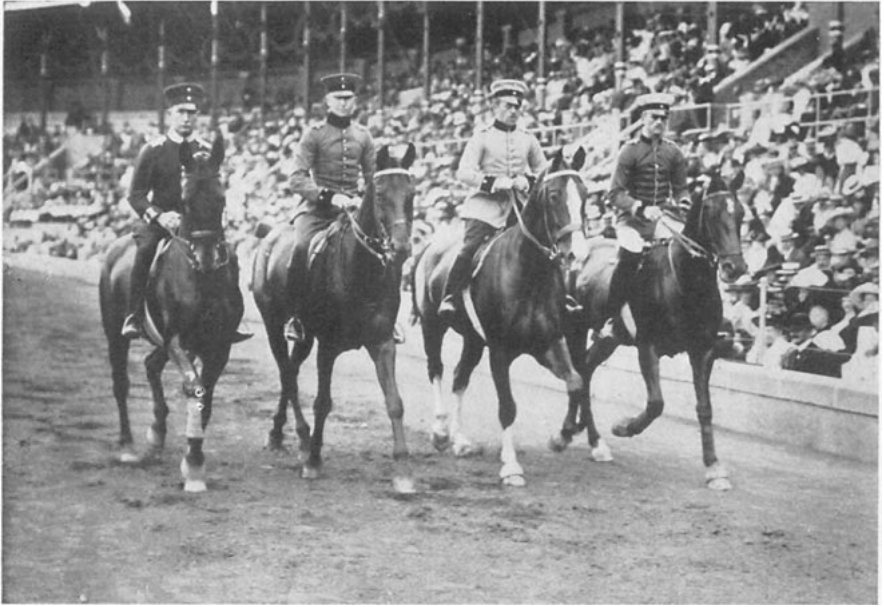

GERMANY'S TEAM IN TEAM PRIZE JUMPING. 3:rd prize.
H. R. H. Prince FRIEDRICH KARL; Lieutenant DELOCH; Lieutenant FREYER;
Lieutenant, Count VON HOHENAU.



RUSSIA'S TEAM IN TEAM PRIZE JUMPING.
The Grand Duke DMITRY PAWLTOVITCH; Captain RODZIANKO; Captain SELIKHOFF;
Lieutenant PLECHKOFF.



H. M. THE KING PRESENTING THE SWEDISH CAVALRY'S PRIZE TO H. R. H. PRINCE CARL OF SWEDEN.



H. M. THE KING PRESENTING THE 1:ST PRIZE FOR INDIVIDUAL PRIZE JUMPING TO CAPTAIN CARIOU (France).

The mounts used in this competition were, as a rule, of first rate quality, and it would probably be difficult to obtain a finer collection of service horses. Of the 27 horses, no less than 15 were quite certainly foaled within Great Britain; 4 were French and 4 Americans; Sweden contributed 3 and Germany 1. Only 3 were full-bloods; the others were half-bloods.

THE PRIZE RIDING.

9 nations had entered for this competition. Sweden had the maximum number, 6 with 3 reserves; Denmark, France and Germany each had 5; Great Britain and the U. S. A. had 4 each; Norway 3 and Russia 1. At the start, however, there were only 21 riders from 8 nations, Great Britain's representatives not putting in an appearance.

The competition took place on the course specially arranged for the event on the Field Riding Club's ground. According to the propositions, the obstacles which were to be taken consisted of an earth-wall with bar 0.80 met.; fence, 1 met.; fence 1,10 met., dry ditch with bar in front, 3 met., and fence, 1 met. The obedience test consisted of the rolling towards the horse of a wooden cylinder, 80 cm. diameter and c:a 1,50 met. long, and painted with stripes in 3 colours.

List of competitors and horses.

Programme n.º	Name of Rider	Country	Name of Horse	Where foaled	Remarks
39	Cariou, Capitaine, École d'artillerie.	France	Mignon, b., g., a.	France	
41	Seigner, Lieutenant, 12:e Cuirassiers.	»	Dignité, br., m., 9 y.	»	
45	d'Astafort, Lieutenant, 6:e Cuirassiers.	»	Castibalza, b., g., 10 y.	»	
46	v. Flotow, Oberleutnant, Ulanen-Regiment 13.	Germany	Senta, b., m., a.	Prussia	
47	Bonde, C., Count, Master of the Horse, Captain, Royal Life Guard Hussars.	Sweden	Emperor, br., g., a.	Sweden	
48	v. Moers, Rittmeister, Militär-Reit-Institut.	Germany	New Bank, br., m., a.	England	
50	de Trannoy, Gaston, Lieutenant du 2:e ré- giment de guides.	Belgium	Capricieux, b., g., 9 Y-	—	
51	Bürkner, Oberleutnant, Jäger-Regiment zu Pferd 2.	Germany	King, b., g., a.	Galicia	
54	de Blommaert, E., Bar- on, capitaine du 1:er regiment de guides.	Belgium	Clonmore, br., g., 12 y.	—	
55	v. Blixen-Finecke, H., Baron, Lieut., Royal Scanian Dragoons.	Sweden	Maggie, br., m., a.	Sweden	

Programme n:r	Name of Rider	Country	Name of Horse	Where foaled	Remarks
56	Keyper, R. J. G., Premierløjtnant, 4. Dragonregiment.	Denmark	Kinley Princess, bl., m., 10 y.	England	
57	Kruckenbergh, C. W., Lieut., Royal Småland Hussars.	Sweden	Kartusch, br., g., a.	Sweden	
58	Montgomery, John, C., Lieutenant, 7th Cavalry, U. S. Army.	U. S. A.	Deceiv** br., g., a.	America	
60	v. Oesterley, Rittmeister, Militär-Reit-Institut.	Germany	Condor, br., g., a.	Prussia	
61	Boltenstern, G. A., Major, Royal Horse Guard	Sweden	Neptun, br., g., 6 y.	Sweden	
62	v. Rochow, Oberleutnant, Ulanen-Regiment 16.	Germany	Else, br., m., a.	Hanover	
63	Henry, Guy V., Captain, 13th Cavalry, U. S. Army.	U. S. A.	Chiswell, b., g., 7 y-	America	
64	Ekimoff, Michel, Capitaine, 5. Regiment dragons de Kargopolle.	Russia	Tritonytch ** br., g., 6 y.	Russia	
65	Saunte, C. H., Rittmeister, 4. Dragonregiment.	Denmark	Streg, b., g., 9 y.	Mecklenburg	
68	af Ström, O., Captain, Royal Life Guard Dragons.	Sweden	Irish Lass, br., m., a.	Ireland	
69	Falkenberg, I. C. B., Kaptein, Feltartilleriregiment n:r 2.	Norway	Hjördis, b., m., 7 y.	,	
75	Rosenblad, C., Lieut., Royal Life Guard Dragons.	Sweden	Miss Hastings, b., m., a.	Sweden	

Summary of Judges' Protocols.

Programme n:r	Name of Rider	Place figures							Total place figures	Placing
		1	2	3	4	5	6	7		
47	Bonde	1	1	1	1	3	3	5	15	1
61	Boltenstern	1	2	2	2	3	5	6	21	2
55	V. Blixen-Finecke	2	3	4	5	5	5	8	32	3
60	v. Oesterley	2	2	3	4	6	9	10	36	4
75	Rosenblad	3	4	4	5	7	9	11	43	5
68	af Ström	4	6	6	6	8	8	9	47	6
51	Bürkner	1	2	6	7	8	13	14	51	7
57	Kruckenbergh	4	6	7	8	8	8	10	51	8
64	Ekimoff	3	7	7	10	10	12	13	62	9
41	Seigner	1	4	12	13	13	13	17	73	10
46	v. Flotow	7	9	9	9	12	13	18	77	11
48	v. Moers	10	10	11	11	11	15	15	83	12

Programme n.r.	Name of Rider	Place figures								Total place figures	Placing
		9	12	12	13	14	15	18			
63	Henry	9	12	12	13	14	15	18		93	13
39	Cariou	5	7	11	15	17	19	20		94	14
69	Falkenberg	12	14	14	14	16	16	17		103	15
56	Keyper	12	14	15	15	17	18	20		111	16
50	de Trannoy	10	14	17	18	19	19	20		117	17
65	Saunte	11	15	16	16	20	21	21		120	18
45	d'Astafort	11	17	18	18	19	19	21		123	19
58	Montgomery	16	17	18	19	19	20	21		130	20
54	de Blommaert	16	16	20	20	21	21	21		135	21

In the prize jumping, two systems, so to say, were shown; the one, that employed by the Germans and Swedes, and the other, that used by the other nations, to which, however, that employed by Captain Ekimoff (Russia) the pupil of Fillis, was an exception. The 6 Swedes and the 4 Germans in the competition were all placed by the judges among the first twelve, i. e. nearly all in the better half of the list. The Frenchmen taking part in the competition ought not, however, to be considered as the best possible representatives of French manège as it can be displayed during a prize riding. The prize riding which formed part of the Military with its lesser requirements, resulted in the first and third places being taken by France. Great Britain and Sweden were the birthplaces of 6 and 5 respectively of the horses taking part in the competition. Germany contributed 2, France 3, the U. S. A. 2, and Russia and Austria 1 each. Of the mounts, 3 were full bloods, and the remainder half-bloods.

PRIZE JUMPING.

Before the individual prize jumping began, the Royal Party arrived at the Stadium in state, the Royal Cortège, escorted by cavalry, entering the great gateway and driving round the running track, enthusiastically greeted by a public that filled every seat in the building. After the members of the Royal Family had left their carriages, His Majesty The King passed along the front of the riders, who were drawn up in front of the Royal box, each of the competitors being presented to His Majesty by H. R. H. Prince Carl. Then came a display by those taking part in the prize riding, after which the individual prize jumping began.

The maximum number, 6 competitors and 3 reserves, had been entered by Sweden only; Russia and Germany had 6 competitors and 2 reserves; Denmark, 6 competitors; France and the U. S. A. 5 each; Belgium, Great Britain and Norway 4 each, and Chili 2. There were thus, in all, 10 nations entered, but at the start, which embraced 31 riders, Denmark and the U. S. A. were absent.

A. Individual competition.

List of competitors and horses.

Programme n:r	Name of Rider	Country	Name of Horse	Where foaled	Remarks
77	de Blommaert, E., Baron, Capitaine du 1:er regiment de guides.	Belgium	Clonmore, br., g., 12 y.	—	
82	Casparsson, E. G., Lieut. Royal Småland Hus-sars.	Sweden	Kiriki, bl., m., a.	Ireland	
85	v. Hohenau, Graf, Leutnant, Kürassier-Regiment 1.	Germany	Pretty Girl, br., m., 6 y.	England	
89	Deloch, Leutnant, Artillerie-Regiment 5.	Germany	Hubertus, bl., g., a.	Posen	
90	v. Krocher, Oberleutnant, Kürassier-Regiment 6.	"	Dohna, b., g., a.	Hanover	
91	Cariou, Capitaine, École d'Artillerie.	France	Mignon, b., g., a.	France	
93	Yañez, Elias Lieutenant, Chilian cavalry.	Chili	Patria, b., m., 8 y.	Ireland	
96	Lewenhaupt, Ch., Count, Lieut. Royal Svea Artillery Regt.	Sweden	Arno, b., g., a.	Sweden	
98	Kildal, K., Premierløjtnant, infanteriregiment n:r 12.	Norway	Garcia, br., m., 11 y.	England	
99	d'Astafort, Lieutenant, 6:e Cuirassiers.	France	Castibalza, b., g., 10 y.	France	
100	Rodzianko, Alexandre, Capitaine, Chevaliers-Garde.	Russia	Eros, br., g., a.	Russia	
104	Hök, Åke, Lieut. Royal Scanian Dragoons.	Sweden	Mona, b., m., a.	Sweden	
105	Deichler, Enrique, Lieutenant, Chilean cavalry.	Chili	Chile, b., g., 7 y.	England	
107	Scott, H. S. L., Lieutenant, 4th Hussars.	G. Britain	Shamrock, br., g., 10 y.	—	
108	Lewenhaupt, G., Count, Lieut. Royal Horse Guards.	Sweden	Medusa, br., m., a.	Sweden	
109	Seine Königliche Hoheit Prinz Friedrich Karl von Preussen, Lieutenant, 1. Garde-Regiment zu Fuss.	Germany	Gibson Boy, br., g., a.	Ireland	
112	Radcliffe-Nash, E., Lieutenant, 16th Lancers.	G. Britain	Betty, br., m., 10 y.	—	
113	Falkenberg, I. C. B., Kaptein, Feltartilleriregiment n:r 2.	Norway	Florida, br., m., 11 y.	Ireland	

Programme n.º	Name of Rider	Country	Name of Horse	Where foaled	Remarks
114	Selikhoff, Alexis, Sous-capitaine, 2:de Batterie à cheval.	Russia	Tugela ** br., m., a.	Russia	
116	Son Altesse Impérial, Grand Duc Dmitry Pawlowitch, Lieutenant, Garde à cheval.	»	Unite, br., g., a.	Ireland	
117	Adlercreutz, N., Captain, Royal Horse Guards.	Sweden	Ilex, br., g., a.	Sweden	
118	v. Roummel, Charles, Lieutenant, Régiment Ismailoffsky (de la Garde).	Russia	Siablik, b., g., a.	Russia	
120	Zagorsky, Serge, Lieutenant, Régiment de réserve de la Garde.	»	Bandoura, br., m., a.	»	
121	Grote, Graf, Leutnant, Ulanen-Regiment 13.	Germany	Polyphem, b., g., a.	England	
122	Torén, C. A. O., Lieut. Royal Life Guard Hussars.	Sweden	Falken, br., g., a.	Sweden	
123	Plechhoff, Michel, Lieutenant, Cuirassiers de la Garde de Sa Majesté l'Impératrice Marie Fedorowna.	Russia	Yvette, b., m., a.	Ireland	
124	Jensen, J., Premierløjtnant, Skoleskadronen.	Norway	Jessy, b., m., 7 y.	»	
127	Meyer, Commandant, 3:e Dragons.	France	Ursule, br., m., a.	France	
128	Freyer, Oberleutnant, Dragoner-Regiment 14.	Germany	Ultimus, b., g., a.	Mecklenburg	
130	Kenna, P. A., Colonel, V. C.	G. Britain	Harmony, br., m., 9 y.	—	
131	Reyntiens, Guy, Lieutenant du 1:er régiment de guides.	Belgium	Beau Soleil, b., g., 7 y.	—	

Of the horses, 15 were foaled in Great Britain; 5 in Sweden, 4 in France and in Russia, and 3 in Germany. Only 1 was full blood, the remainder half-bloods.

The team prize jumping concluded the competitions. Entries had been made by 9 nations; Germany, Russia and Sweden with the maximum of 4 competitors and 2 reserves; France and the U. S. A., 4 competitors and 1 reserve; Belgium, Denmark, Great Britain and Norway had not entered any reserves. Only 6 nations were represented by the starters, however, and Belgium and the U. S. A. had only 3 riders each.

A. Individual competition.

Total maximum points 190

Summary of judges' protocols.

Maximum Time 3 min. 50 sec.

Programme n:r	Name of Rider	Time taken	Deduction for exceeded time	Deduction for								faults at obstacles															Total deductions	Total points	Placing	Remarks
				1	2	3	12 a	13 a	10 a	11 a	4	5	6	7	8	9	10 b	11 b	12 b	13 b	14	15								
				Hedge	Fence	Stone-Wall	Earth-Wall with Bar	Stone-Wall—Dike—Stone Wall	Brick-Wall	Country Road	Railway gates	Triple Bar	Fence in Dike	Hedge and Top Bar	Fence—Dike—Hedge	Fence	Brick-Wall	Country Road	Earth-Wall	Stone-Wall—Dike—Stone-Wall	Bank—Fence	Dike								
91	Cariou	3:46	—	—	—	—	—	—	—	—	1	—	—	—	—	—	—	—	—	—	3	—	4	186	1					
90	v. Kröcher	3:37 ^{1/5}	—	—	—	—	—	—	—	—	2	—	—	—	—	—	—	—	—	2	—	—	4	186	2					
77	de Blommaert	3:18	—	—	—	—	—	—	—	—	1	—	—	—	—	—	—	—	—	—	—	—	5	185	3					
107	Scott	3:26 ^{2/5}	—	—	4	—	—	—	—	—	1	—	—	—	—	—	—	—	—	—	—	—	6	184	4					
128	Freyer	3:24	—	—	—	—	—	—	2	—	—	—	—	—	—	—	—	—	—	—	—	—	7	183	5					
85	v. Hohenau	3:19	—	—	—	—	—	—	—	—	2	—	—	—	—	—	—	—	—	—	—	—	9	181	6					
117	Adlercreutz	3:30	—	—	—	4	—	—	—	—	—	—	—	—	—	—	—	—	—	—	—	—	9	181	6					
82	Casparsson	3:29 ^{2/5}	—	—	—	—	—	1	—	—	1	—	—	—	—	—	—	—	—	—	—	2	9	181	6					
116	Son Altesse Imperial, Grand Duc Dmitry Pawlowitch	3:23 ^{3/5}	—	—	—	—	—	1	—	1	1	—	—	—	—	—	—	—	—	—	—	—	10	180	7					
96	Lewenhaupt	3:33	—	—	—	—	—	—	—	—	2	—	—	—	—	—	—	—	—	—	—	—	10	180	7					
89	Deloch	3:39	—	—	—	—	—	—	—	—	4	2	—	—	—	—	—	—	—	—	—	—	10	180	7					
108	Lewenhaupt	3:35	—	—	—	—	—	—	—	—	—	1	—	—	—	—	—	—	—	—	—	—	10	180	7					
99	d'Astafort	3:38 ^{3/5}	—	—	—	—	—	—	—	1	—	—	—	—	—	—	—	—	—	—	—	—	11	179	8					
122	Torén	3:41 ^{1/5}	—	—	—	4	—	—	—	—	2	—	—	—	—	—	—	—	—	—	—	—	11	179	8					
118	v. Roummel	3:49	—	—	—	—	—	—	—	—	—	—	—	—	—	—	—	—	—	—	—	—	12	178	9					
105	Deichler	3:40	—	—	—	—	—	—	—	1	—	—	—	—	—	—	—	—	—	—	—	—	14	176	10					
100	Rodzianko	3:21	—	—	1	—	—	—	—	2	2	—	—	—	—	—	—	—	—	—	—	—	14	176	10					
121	Grote	3:39 ^{4/5}	—	—	—	2	2	—	—	—	5	1	—	—	—	—	—	—	—	—	—	—	16	174	11					
120	Zagorsky	3:18	—	—	—	—	—	—	—	—	2	—	—	—	—	—	—	—	—	—	—	—	16	174	11					
109	Seine Königliche Hoheit Prinz Friedrich Karl von Preussen	3:25	—	—	—	—	—	—	—	—	1	—	—	—	—	—	—	—	—	—	—	—	16	174	11					
123	Plechhoff	3:46 ^{4/5}	—	—	—	—	1	—	—	—	—	—	—	—	—	—	—	—	—	—	—	—	10	173	12					
104	Hök	3:38 ^{4/5}	—	—	—	—	4	—	—	—	5	—	—	—	—	—	—	—	—	—	—	—	20	170	13					
114	Selikhoff	3:42 ^{2/5}	—	—	—	—	—	1	—	—	—	—	—	—	—	—	—	—	—	—	—	—	20	170	13					
98	Kildal	3:34 ^{1/5}	—	—	—	—	4	4	—	—	4	—	—	—	—	—	—	—	—	—	—	—	22	168	14					
93	Yañes	3:35	—	—	—	—	—	—	—	2	8	—	—	—	—	—	—	—	—	—	—	—	24	166	15					
124	Jensen	3:38 ^{3/5}	—	—	—	—	—	—	—	—	—	—	—	—	—	—	—	—	—	—	—	—	25	165	16					
130	Kenna	4:12	10	—	—	—	1	2	4	—	1	—	—	—	—	—	—	—	—	—	—	—	28	162	17					
113	Falkenberg	4:31 ^{2/5}	—	—	—	—	—	—	—	—	—	—	—	—	—	—	—	—	—	—	—	—	29	161	18					
112	Radcliffe-Nash	4:30 ^{1/5}	18	—	—	—	—	—	—	—	—	—	—	—	—	—	—	—	—	—	—	—	37	153	19					
131	Reyntiens	4:23	14	—	—	—	—	—	—	—	—	—	—	—	—	—	—	—	—	—	—	—	43	147	20					
127	Meyer	—	—	—	—	—	—	—	—	—	—	—	—	—	—	—	—	—	—	—	—	—	—	—	—	—	*Retired.			

Re=jumping.

91	Cariou	1:16	—	—	—	—	—	—	—	—	—	—	—	—	—	—	—	—	—	—	—	—	5	—	—	
90	v. Kröcher	1:10	—	—	—	—	—	—	—	—	—	—	—	—	—	—	—	—	—	—	—	—	7	—	—	

B. Team competition.

List of competitors and horses.

Programme n:r	Name of Rider	Country	Name of Horse	Where foaled	Remarks
132	Son Altesse Imperial, Grand Duc Dmitry Pawlowitch, Lieute- nant, Garde à cheval.	Russia	Unité, br., g., a.	Ireland	
134	Plechhoff, Michel, Lieute- nant, Cuirassiers de la Garde de S. M. l'Impératrice Marie Fedorowna.	»	Yvette, b., m., a.	»	
135	Rodzianko, Alexandre, Capitaine, Chevaliers- Garde.	»	Eros, br., g., a.	Russia	
136	Selikhoff, Alexis, Sous- capitaine, 2:e Batterie à cheval.	»	Tugela ** br., m., a.	»	
138	Seine Königliche Hoheit Prinz Friedrich Karl von Preussen, Leut- nant 1. Garde-Regi- ment zu Fuss.	Germany	Gibson Boy, br., g., a.	Ireland	
139	Deloch, Leutnant, Artil- leriregiment 5.	»	Hubertus, bl., g., a.	Posen	
140	Freyer, Oberleutnant, Drag.-Reg. 14.	»	Ultimus, b., g., a.	Mecklen- burg	
141	v. Hohenau, Graf, Leut- nant, Kürassier-Regi- ment 1.	»	Pretty Girl, br., m., 6 y.	England	
144	Kilman, G., Lieut. Royal Göta Artillery Regt.	Sweden	Gåtan, b., m., a.	Sweden	
145	Lewenhaupt, G., Count, Lieut. Royal Horse Guards.	»	Medusa, br., m., a.	»	
147	Rosencrantz, F., Lieut. Royal Scanian Dra- goons.	»	Drabant, br., g., a.	»	
149	v. Rosen, H., Count, Lieut. Royal Horse Guards.	»	Lord Iron, b., g., a.	»	
154	Ben Lear, Jr, Lieute- nant, 15th Cavalry, U. S. Army.	U. S. A.	Poppy, br., g., a.	America	
156	Henry, Guy V., Captain, 13th Cavalry, U. S. Army.	»	Chiswell, b., g., 7 y.	»	
157	Montgomery, John C., Lieutenant, 7th Ca- valry, U. S. Army.	»	Deceive br., g., a. **	»	
167	de Blommaert, E., Ba- ron, Capitaine du 1:er reg. de guides.	Belgium	Clonmore, br., g., 12 y.	—	

Programme n.º	Name of Rider	Country	Name of Horse	Where foaled	Remarks
168	Convert, Paul, Lieutenant du 1:er régiment de guides.	Belgium	La Sioute, bl., m., 8 y.	—	
170	de Trannoy, Gaston, Lieutenant du 2:e régiment de guides.	»	Capricieux, b., g., 9 y.	—	
171	d'Astafort, Lieutenant, 6:e Cuirassiers.	France	Amazone, br., m., 11 y.	France	
173	Meyer, Commandant, 3:e Dragons.	»	Allons-Y, br., g., 12 y.	»	
174	Seigner, Lieutenant, 12:e Cuirassiers.	»	Cocotte, b., m., 12 y.	»	
175	Cariou, Capitaine, École d'Artillerie.	»	Mignon, b., g., a.	»	

If this competition had also been individual, re-jumping would have been necessary between Captain de Blommaert, on Clonmore (Belgium), and Lieutenant, Count G. Lewenhaupt, on Medusa (Sweden), each of whom had only 2 faults, while the third prize would have gone to Lieutenant d'Astafort, on Amazone (France). Had the competition on the preceding day also been a team event, the resulting order would have been: Germany, Sweden, Russia. Of the horses taking part in the team competition 7 were foaled in Great Britain; 4 each in France and Germany, (i. e. the horses employed by the teams of these two countries); 3 in the U. S. A. and 2 each in Germany and Russia. There were 2 full-blood mounts. During the jumping there were, of course, many methods employed of taking the obstacles; the French and the Italian styles — the latter of which, in what may be called an exaggerated form, was employed by the Russian riders — being those that differed most widely. The Russians, it is true, did not succeed in placing their names on the prize list, but their excellent jumpers seemed to suffer from the severe system of training employed and which was carried on until the very last moment, and for which the heat-hardened training courses were, probably, not quite suitable.

Captain de Blommaert (Belgium), on his magnificent Clonmore, was the only rider who started in all the competitions, though it must be observed that he completed only the first two trials in the Military. Of the horses that completed this fatiguing event, Chiswell and Deceive ** (U. S. A.), ridden by Captain Henry and Lieutenant Montgomery, also took part in the prize riding and the team prize jumping, while Cocotte (France) which, ridden by Captain Cariou, won the third prize in the individual competition, took part in the team prize jumping, ridden then by Lieutenant Seigner. Dignite, also a French horse, was ridden by Lieutenant Seigner both in the Military and in the prize riding.

Those horses which, besides taking part in the prize riding, also competed in the prize jumping were, in addition to Clonmore, Chiswell, Deceive ** and Dignité (all of whom have been previously mentioned), were the French horses Miss Mignon and Castibalza, ridden by Captain Cariou and Lieut. d'Astafort, and Capricieux, ridden by Lieut. de Trannoy (Belgium). 11 horses took part in both the great jumping competitions, which were held over the same course. Of these 11, only 3 obtained better results during the jumping on the second day, viz., Clonmore, which reduced its total number of faults from 5 to 2; the Swedish Medusa, which, on the first day, had 10 faults and on the second only 2, and Captain Selikhoff's Tugela ** (Russia) with 20 faults the first day and 18 the second.

PRESENTATION OF THE PRIZES.

After the close of the team prize jumping, His Majesty King Gustaf gave away the prizes, which were received by the competitors mounted, after which, all the competitors defiled by nations before the Royal box, passing round the running track. Of the Challenge Prizes, 4 were won by Sweden and 1 by France.

Gold Medals	Sweden	8
»	» France	1
Silver	» Germany	5
»	» France	3
»	» Sweden	1
Bronze	» Germany	3
»	» U. S. A.	3
»	» Belgium	1
»	» France	1
»	» Sweden	1

P. M. AND INSTRUCTIONS, ETC., ISSUED BY THE COMMITTEE FOR THE HORSE RIDING COMPETITIONS.

These are issued by the Committee for the Horse Riding Competitions of the Olympic Games of Stockholm, 1912, and are intended to be merely a *brief summary* of the Daily Programme of the Games, to which the competitors in the Horse Riding events are referred for further, full information.

Competitions are to take place in the Stadium every day from July 6—July 17, both days included.

The ordinary entrance tickets to the Stadium are not available for the competitions, displays, etc., marked below with an asterisk.

The silver badge of the Committee for the Horse Riding Competitions do not, of themselves, entitle the wearer to entrance to the Stadium, but *a ticket shall also be shown*.

Saturday, July 6th.		
11,00 a.m.	Stadium	Solemn Opening of the Games.
12,00 noon.	»	Swedish Gymnastics.
4,00 p.m.	The Palace	Garden Party given by H. M. The King.
7,00 p.m.	Djurgårds- * brunnsviken	Swimming & diving.
8,00 p.m.	Stadium	Grand Military Concert. (300 musicians).

<i>Sunday, July 7th.</i>		
1,00 p.m.	Stadium	Cycle race round Lake Mälär, Arrival of the first men.
3,00—6,00 p.m.	Lindarängen *	Horse Racing (15 min. by motorcab from the Stadium).
4,00—6,30 p.m.	Lindarängen *	Trotting Races. d:o d:o
8,00 p.m.	Royal Opera *	Fête given by the "Friends of National Dances".
7,00 p.m.	Djurgårdsbrunnsviken *	Swimming, High Diving.
<i>Monday, July 8th.</i>		
9,30 a.m.—12,30 p.m.	Stadium	Gymnastics. Denmark, Norway, Finland.
11,00 a.m.	Djurgårdsbrunnsviken *	Modern Pentathlon, 2:nd event.: Swimming.
2,00—5,00 p.m.	Stadium	Gymnastics. Sweden, Norway, Denmark.
7,00 p.m.	Djurgårdsbrunnsviken *	Swimming and Diving.
	Foreign Minister's Hotel	Reception by His Excellency the Minister of Foreign affairs.
<i>Tuesday, July 9th.</i>		
9,00 a.m.—5,00 p.m.	Östermalm Tennis Courts *	Modern Pentathlon. 3:rd event. Épée Fencing.
4,30—6,30 p.m.	Lindarängen *	Trotting Races (15 min. by motorcab from the Stadium).
7,00 p.m.	Djurgårdsbrunnsviken *	Ladies' Swimming display. Final in Diving.
8,00 p.m.	The Palace	Dinner given by H. R. H. the Crown Prince of Sweden.
<i>Wednesday, July 10th.</i>		
9,30 a.m.—12,30 p.m.	Stadium	Gymnastic Competition. Germany, Norway, Denmark.
3,00—6,00 p.m.	Lindarängen *	Horse-Racing (15 min. by motorcab from the Stadium).
7,30 p.m.	Stadium	Athletics. Competitions between the crews of the foreign warships.
<i>Thursday, July 11th.</i>		
9,30 a.m.—12,30 p.m.	Stadium	Gymnastics Luxemburg, Hungary, Germany.
12,15 p.m.	Barkarby *	Modern Pentathlon, 4th event. Cross-country Ride (45 min. by motorcab from the Stadium).
4,30—6,30 p.m.	Lindarängen *	Trotting Races (15 min. by motorcab from the Stadium).
	The Palace	Dinner given by H. R. H. the Crown Prince of Sweden.
9,00 p.m.	Royal Opera *	Gala representation. Dress: Uniform.
<i>Friday, July 12th.</i>		
8,00 a.m.	Hotel Continental	The participants in the Military assemble and make definite entries. Train leaves the Central Station at 9 a.m. for Spånga, where horses will be waiting and the Course will be shown. Return by train & arrival at Stlm. C. 1,29 p.m.

11,00 a.m.	Stadium	Modern Pentathlon, 5th event. Cross-Country race.
2,00 p.m.	Lindarängen *	Steeple-chase Course shown to the participants in the Military.
4,30—6,30 p.m.	»	Trotting Races.
<i>Saturday, July 13th.</i>		
8,00—10,30 a.m.	Field Riding Club's Course	Start of 1st event. in the Military. Distance Riding.
12,00—2,30 p.m.	Field Riding Club's Course	Arrival at finish of competitors in the Military Distance Ride.
4,00 p.m.	Barracks of Royal Horse Guards	Reception by the Officers' corps.
6,30—8,00 p.m.	Stadium	Grand Choral festival (4,000 men).
8,30 p.m.	Hasselbacken	Banquet by the Horse Riding Committee. Dress: Uniform.
<i>Sunday, July 14th.</i>		
1,45 p.m.	Stadium	The Marathon Race.
7,30 p.m.	Prince Carl's Palace	Dinner by H. R. H. Prince Carl of Sweden.
<i>Monday, July 15th.</i>		
8,00—11,00 a.m.	Field Riding Club's Course	Prize-Riding Competition.
12,00—3,00 p.m.	Field Riding Club's Course	Prize-Riding Competition.
11,00—2,30 p.m.	Lindarängen	Military, 3d event. Individual riding over the Steeple-chase Course.
5,00 p.m.	Stadium	Distribution of the prizes for Athletic Competitions etc.
8,00 p.m.	Djurgårdsbrunnsviken	Illumination Festival.
<i>Tuesday, July 16th.</i>		
9,00—11,30 a.m.	Stadium	Military, 4th event. Prize jumping.
1,00 p.m.	»	Solemn Arrival of Their Majesties, the King and Queen; presentation of the Competitors.
1,00—2,00 p.m.	»	Display by the participants in the Prize-Riding Competition.
2,00—6,00 p.m.	»	Individual Prize-Jumping Competition.
8,00 p.m.	The Palace	Dinner by H. M. The King.
8,00 p.m.	Djurgårdsbrunnsviken *	Illumination Festival.
<i>Wednesday, July 17th.</i>		
7,00 a.m.—12,00 noon	Stadium	Military, 5th event. Prize-Riding.
1,00—4,00 p.m.	»	Prize-Jumping, Team competition.
4,00 p.m.	»	Presentation of the Prizes for the Horse Riding Competitions.
8,00 p.m.	Saltsjöbaden	Dinner by the Officers of the garrison of Stockholm. Evening dress.
<i>Thursday, July 18th.</i>		
10,00 a.m.—8,00 p.m.	Djurgårdsbrunnsviken *	Rowing Races.
8,30 p.m.	Hasselbacken	Dance given by the Stockholm Field Riding Club.

INFORMATION FOR INTENDING COMPETITORS IN THE HORSE RACES.

I. Situation of Hotels, Military Offices and Barracks.

Hotels: The Grand Hotel and Hotel Royal, The Strand Hotel, Hotel Continental, Hotel Terminus, Hotel Anglais, Hotel Rydberg.

Military offices: The Inspector of the Cavalry, The War Office, The Commandant-General of Stockholm.

Barracks: The Royal Horse Guards (Cav. 1), The Royal Dragoons (Cav. 2), The Royal Svea Artillery Regiment (Art. 1), The Royal Svea Life-Guards (Inf. 1), The Royal Göta Life-Guards (Inf. 2).

II. Visits of Ceremony.

The following *royal personages* and *chiefs* (authorities) should be called on by the foreign officers taking part in the Horse Races of the Olympic Games (visiting-card).

1. *H. R. H. Crown Prince Gustaf Adolf*, Honorary Chairman of the Organising Committee of the Olympic Games; the Royal Palace, west archway. Names can be entered in the visitor's book from 9 a.m. to 6 p.m.

2. *H. R. H. Prince Carl, Inspector of the Cavalry*, Honorary Chairman of the Horse Racing Committee, 56, Storgatan, from 12 noon to 1 p.m.; telephone to the adjutant; Riks 19 68.

3. *Dr. D. Bergström, Minister for War*, 2, Mynttorget, from 10,30 to 11,30 a.m.; telephone to the adjutant; Riks 18 79.

4. *Major-General C. A. Jungstedt, Commandant-General of Stockholm*, Commander of the 4th Army section (Öfverkommendantsexpeditionen), from 11 a.m. to 3 p.m. Telephone: Riks 19 95.

III. The Secretary's Office of the Horse Riding Committee.

Karlavägen 4.

Telephone: Riks 24. Allm. 234 50.

From the 16th July inclusive, a secretary's office will be opened in the Stadium, too.

IV. Stables.

Chief of the Stabling Bureau: G. Hernlund, Lieutenant, Royal Svea Artillery Regiment. Can be seen at the barracks, (telephone: Riks 936, Allm. 69 22); all the stables are situated here.

Stabling for foreign horses, in the stables on the ground north of the barracks; telephone, Riks 10 57, Allm. 268 50.

Stabling for Swedish horses, in the north-west stable wing of the barracks, and in the grounds to the west of it; telephone, Riks 121 94, Allm. 51 74.

Saddling stable just north of the Stadium in the Stockholm Riding Institute, where there are about 30 boxes, intended only for horses awaiting their turn to compete.

The shortest roads for leading horses to the saddling stables are marked in broad black lines on the plan at the end of the book.

For the convenience of pedestrians steps are erected leading from the grounds at stable A to Sturevägen.

V. Galloping and Steeple-chase Tracks and Bridle-Roads.

Galloping Track in the Stockholm Race-course in Lindarängen, 2 km. (1 mile) east of the barracks of the Royal Svea Artillery Regiment. The use of the grass track and the obstacles is subject to the regulations issued by the official steward.

Steeple-chase Tracks. 1. Sand track, immediately east of the Barracks of the Swedish Artillery Regiment, exactly similar to the Stadium track.

2. Grass track on the race-course of the Stockholm Field Riding Club; about 25 different obstacles.

Bridle-Roads. There are a number of bridle-roads suitable for exercising horses in Djurgården.

VI. Doctors and Veterinary Surgeons.

At the Horse Riding Competitions of the Olympic Games the following doctors and veterinary surgeons will be in attendance:

Doctor: Dr. *S. Hybbinette*, Riks 123 79.

Veterinary Surgeons: Prof. *T. Wennerholm* and his assistant, *G. Forsell*; the Veterinary Institute, Riks Tel. 899.

The above officials will be present at all the Horse Riding Competitions.

Plan of Stadium Stables.

Steeple-chase course, etc.

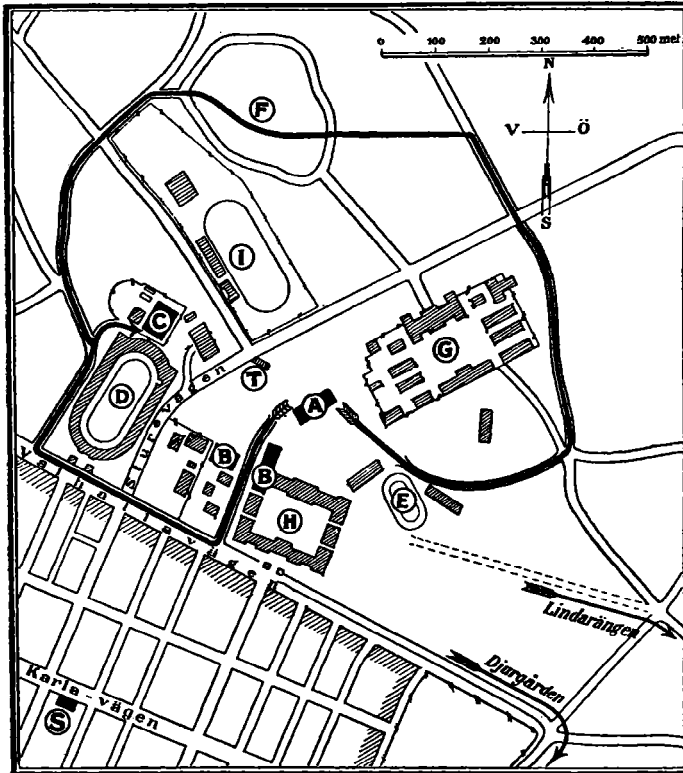

A Stables for foreign horses. B Stables for Swedish horses. C Saddling stable, D Stadion. E Steeple-chase course. F Course of the Stockholm Cross-country Riding Club. G The Royal Horse Guards. H The Royal Svea Artillery Regiment. I Östermalm (Athletic Grounds) Idrottsplats. S The Secretary's Office of the Horse Riding Committee. T Steps. ⇌ Roads to the saddling stable and the course of the Cross-country Riding Club (Fältrittsklubb).

P. M. For competitors in the Military.

Competitions 1 and 2.

1. A map will be given of the course (road and cross-country sections) for the Long Distance Ride.

2. The course for the Cross-country ride will be shown on the 12 July. The competitors meet at the Hotel Continental at 8 a.m.

3. Roll-call of competitors at the Hotel Continental at 8 a.m.
4. In competitions 4 and 5, the riders will start in the order given in the programme; in competitions 1—3 according to a special starting-list.
Riders who do not appear at the start at the time fixed, will be excluded from the competition unless their excuses are accepted by the Committee.
5. The rider must weigh out at the weighing-tent not later than 20 minutes before the start.
6. On weighing out, a numbered voylock (badge) will be handed to the competitor which must be worn visibly, and in such a way that it cannot be lost.
The voylock must be returned on weighing-in.
7. Five minutes before the start, the rider shall notify his presence to the starter on the course of the Field Riding Club.
The rider will be notified one minute before the start.
8. The starting-place is marked by two red flags.
The start shall be made on the word "Ride" being given and the red flag being lowered. The time will be reckoned from this instant.
9. Military guides will be stationed at all cross-ways, etc., to show the way.
10. If the railway-crossings at Rotebro and Silfverdal, and the bridges at Ålkistan and Stocksund are blocked, the time lost will be deducted by a timekeeper. The rider must start again as soon as the way is free, the deduction ceasing from this moment. A man stationed about 100 metres from the crossing will raise a flag as a signal to stop, the rider then halting at once. The time-deduction begins with the halt, and ceases when the flag is lowered again.
At Odenslunda, the programme-number must be stated to the control-official stationed there.
11. The starting-point of the cross-country ride is marked by two yellow flags, between which the rider must pass and, at the same time, state his programme-number to the control-official there.
The taking of the time for the cross-country ride will begin when the flags are passed.
12. The cross-country course is marked by flags, of which, the red shall be kept to the right, and the white to the left. A competitor who rides on the wrong side of the flags will be disqualified.
That part of the course passing through timber will be marked by pieces of red cloth hung on the trees.
The obstacles where points are counted are marked by a red and a white flag, and the obstacle must be taken between these flags.
13. The finish of the cross-country course is marked by two yellow flags, between which the rider must pass. His time will then be taken, and he must state his number to the control-official stationed there.
14. The finish of the Long Distance Ride over the course of the Field Riding Club is situated at the same place as the start. The time will be taken when the rider passes the finish.
15. Immediately after arrival, the competitor shall ride to the weighing-tent, to weigh in.
16. During the ride, veterinary surgeons and farriers can be consulted at the Rotebro Inn, and at the finish of the cross-country ride. Horses can be watered at Hagby, Odenslunda, Rotebro, and at the finish of the cross-country ride.
17. If a rider retires during the course of the ride, information must be given to the nearest control-official or judge, or a telephone message must be sent to the barracks of the Royal Horse Guards (Riks. 18 83; 63 93. Allm. 73 48.)
18. In the event of a competitor not starting, information of the fact should be given to the starter before 8 a.m.

Competition 3.

Lindarängen.

The steeple-chase-ground will be shown on July 12th, 2 p.m. The riders will start in accordance with a special starting list See Comp. 1 and 2. § 4).

1. The first start takes place at 11 a.m., July 15th.

2. The rider shall weigh out not later than 20 minutes before the start. He will receive a numbered voylock, which must be placed in the same manner as for the long Distance Ride.

3. 5 minutes before the start the rider shall mount and walk to the saddling-place.

4. When requested, he shall ride to the starting-place and notify his presence to the starter.

5. When requested by the starter, the competitor will ride to the appointed place behind the starting line. As soon as the rider has answered "yes" to the starter's question if he is ready, he will advance at a walk. When he passes the starting line, the starting-flag will fall and his time be taken.

As soon as the starting-flag is down, this will count as the start, even if the rider for some reason or other, cannot make his horse start.

6. Immediately the finish is passed, the rider shall ride to the weighing-in paddock to weigh in.

7. Those who do not appear at the starting-place at the time fixed will be excluded from the competition, unless their excuses are accepted by the Committee.

Competition 4. In the Stadium.

1. On the 16th July, at 8.30 a.m., the competitors will meet on foot for the roll-call, in the north-west gateway, when the starting-time will be given. First start at 9 a.m.

2. The rider shall weigh out in the saddling-stable not later than 20 minutes before the start.

3. 5 minutes before the start, the rider has to notify his presence to the leader's adjutant, in the north-west gateway. When requested by the said official, the competitors ride into the Stadium, following the running track to the right, then pass the Royal box, and ride across the arena to the starting-place, after which the riding begins. See instructions in the P.M. for competitors in the Prize-Jumping-Competition.

4. On passing the starting-place, a bell will ring and the time will be taken until the finish (15 m. behind the ditch) is passed.

Competition 5. In the Stadium.

1. On the 17th July, at 6.30 a.m., the competitors will enter on foot for the roll-call, at the north-west gateway, when the starting-time will be given. First start at 7 a.m.

2. 5 minutes before starting-time the competitor has to notify his presence to the leader of the competition and, when requested, will ride into the arena and pass before the judge.

3. See the instructions in the P.M. for competitors in the Prize-Riding-Competition.

P. M. for competitors in the Prize-Riding Competition.

The Course of the cross-country Riding Club.

1. On July 15th at 7 a.m., the competitors meet on foot for roll-call, in the stables for the foreign horses, when the starting-time will be given. The competitors will ride in the order given in the list. First start at 8 a.m.

2. 5 minutes before starting-time the competitor shall notify the leader of his presence.

When requested by this official, the competitor will ride into the Stadium, follow the running track at a trot, pass the Royal box and then ride on* to the prize-riding course at a gallop.

(After the riding is concluded, the competitor will ride round the course to the right and pass out through the north-western entrance.*

* Only for prizering- in "Military".

V. OLYMPIAD
OLYMPIC GAMES
OF
STOCKHOLM, 1912

ENTRY FORM
FOR
HORSE-RIDING COMPETITIONS

JULY 13-17, 1912

This entry form carefully filled in shall be sent in by the Olympic Committees of the respective countries far, if so desired by the War Department of the land in question to the Swedish Committee for the Horse-Riding Competitions under the address:
KOMMITTÉN FÖR HÄSTTÄVLINGAR STOCKHOLM

*Extract from
The General Regulations for the Olympic Games:*

A competitor has the right of entering not more than two horses for each competition, but he may not ride more than one horse in any one competition

Entries shall either be type-written, or written in other distinct Latin characters on this form

Each form is for *one* competitor and *one* competition only.

This Entry

shall contain the name of the rider and his horses (see General Regulations for the Horse-Riding competitions, section 7), and must be in the hands of the Swedish Committee for the Horse-Riding competitions not later than July 1, 1912.

Entries made by telegram will not be accepted.

Face of Entry-form for Horse Riding Competitions.

3. The following notes are given to elucidate the "Programme" and the "Principles for judging":

By *collected trot* is meant a pace of not more than 200 metres a minute, and by *fast trot*, a pace of at least 250 metres a minute.

By *collected gallop* is meant a pace of at most 225 metres a minute and by *fast gallop* a pace of at least 300 metres a minute.

Points will be counted separately for the collected and the fast paces.

For riding and holding the reins with two hands the highest number of points is 7.

For riding and holding the reins principally with one hand in walking and trotting taken together, one point can be added, and in the gallop 2 additional points can be gained.

Special points will be counted for the movements of the horse, and special points for the turnings.

The judging of the jumping will take place partly in accordance with the directions for judging in the prize-jumping competition (400 metres tempo not necessary), partly according to the tempo and bearing of the horse, and partly of the rider's seat and his command of his mount.

ENTRY FORM FOR HORSE-RIDING COMPETITIONS

JULY 13-17, 1912.
This entry form is intended for entry to individual competitions and also for each person using part in the team-competitions, and is for use separately and not competition entry.

Competition	Owner	Rider	Name	Color	Sex	Age	Pedigree & Remarks
I. MILITARY A. <small>For Cavalry, Artillery, Infantry, etc.</small> B. <small>For Cavalry, Artillery, Infantry, etc.</small>	Name Address	Name Regiment Address	Name				
II. PRIZE-RIDING	Name Address	Name Regiment Address	Name				
III. PRIZE-JUMPING A.	Name Address	Name Regiment Address	Name				
III. PRIZE-JUMPING B.	Name Address	Name Regiment Address	Name				

Date _____ 1912.

Name of rider _____

Signature _____

Name of official _____

Back of Entry-form for Horse Riding Competitions.

P. M. for competitors in the Prize-Jumping Competition. *In the Stadium.*

1. On July 16th and 17th, at 11 a.m., competitors in the prize-jumping A and B will meet on foot in the north-west archway of the Stadium, for roll-call, when the starting-time will be given.
The competitors will ride in the order given in the list. The first start on the 16th is at 2 p.m. and on the 17th at 1 p.m.
The rider shall weigh out at the saddling-place not later than 20 minutes before starting-time.
2. 5 minutes before starting-time the rider has to notify his presence to the leader's adjutant in the north-west archway. When requested by this official, the competitor shall ride into the Stadium, follow the running track to the right, pass

by the Royal box, and then cross the arena to the starting-place; the riding will then begin.

3. The following notes are given to elucidate the "Programme" and the "Principles for judging":

A flying start must be made. On the lowering of the starting flag a bell will ring, and the time will be taken until the finish is passed. This is marked with two flags behind obstacle No. 15.

The course must be taken over and outside obstacle No. 1 (see programme supplements 2 and 3), except in the last turn from obstacle No. 13 to obstacle No. 14, and always on the outside of the flags at the ends of the course.

Touching or knocking down the fences will be counted only if part of obstacle falls down.

At refusal or falling of the horse in a combined obstacle, the part of the obstacle passed need not be taken again.

If a horse stands still or refuses at an obstacle, and knocks down the whole or part of it, the rider has to ride over the obstacle in the condition it is in.

All ditches must be taken in their whole breadth, the far-side is marked with two small flags, between which the horse must pass.

In the case of hedges, neither touching nor knocking-down will be counted.

No outside assistance is allowed the rider if he falls off (is unseated) or if the horse falls, if the competition is to be continued.

MEMORANDUM FOR OFFICIALS AND COMPETITORS AT THE HORSE RIDING COMPETITIONS OF THE OLYMPIC GAMES, RESPECTING THE JOURNEY TO AND FROM THE GAMES OF STOCKHOLM.

Every official or competitor at the Horse Riding Competitions of the Olympic Games of Stockholm, 1912, has been granted by the Swedish State a reduction of 50 % on the ordinary fares between the Swedish frontier station, where the country is entered, and Stockholm, and vice-versa, *but this reduction shall not apply to the price of the supplementary tickets necessary for journeys by express trains, nor to that of sleeping-berth tickets.*

In order to enjoy this reduction of the fares, the traveller, when he buys his ticket between the frontier-station in question and Stockholm, or vice-versa, shall give the ticket-clerk the Identity-cards signed by Mr. N. Thisell, of which the blue one is intended for the journey to the Games, and the yellow for the one journey from Stockholm.

As a result of the agreement which has been entered into between the Swedish State Railways and the Tourist Offices named in the accompanying list, it will be possible for the traveller to buy at one of these Offices through tickets between the starting point of the journey and Stockholm. Either single or return tickets may be purchased, and if, in the first case, the blue Identity-card and, in the second case, both cards are given to the Tourist Office in question, the above-mentioned reduction will be made in that part of the fare which covers the Swedish State Railways.

If the traveller prefer to purchase his tickets himself, without application to the above-mentioned Tourist Offices, then he should take a ticket from his starting-point at home *only* to the Swedish frontier station via which he intends travelling, and, on arrival there, get a new ticket thence to Stockholm, giving the blue Identity-card to the booking-clerk, as mentioned above.

In those cases when the traveller does not at once buy a ticket for the return journey, i. e., a return ticket, he should bring the yellow Identity-card with him to Stockholm, to be used there when the ticket for the return journey is bought.

The Swedish Olympic Committee cannot undertake to make compensation in the event of a traveller-losing his Identity-card.

As regards those travellers — four from every nation — who, according to the General Regulations issued by the Committee for the Horse Riding Competitions, have been promised the payment of all their railway expenses in Sweden to and from the Games, they, too, should themselves take their tickets to Stockholm in one of the ways mentioned above. The price of the total railway fares within

Sweden, to and from Stockholm (1st class), inclusive of the cost of sleeping-berth tickets, which may be taken, will afterwards be refunded at the Office of the Committee for the Horse Riding Competitions, Stockholm.

For the convenience of the travellers, special representatives of the Committee for the Horse Riding Competitions will be in attendance at the Swedish boundary stations, and can be seen at the place stated on the notices posted up at these Swedish stations.

In order to enable both the Committee itself and its representatives to do their utmost for the convenience of the traveller, it is necessary for the latter to inform the Committee in good time before beginning the journey — even if notice is sent by telegram, it must not be done later than three full days previously — of the route that he intends to travel by, and of the time when he can be expected at the frontier station.

The traveller should, at the same time, inform the Committee whether he wishes to have a sleeping-berth booked for him, etc.

The traveller will be subject to the ordinary regulations in force respecting the customs examination and the payment of duty.

Postal communications should be addressed to:

"Kommittén för Hästtäflingar",
4, Karlavägen,
Stockholm.

Telegrams: "Centaur", Stockholm. Telephone, Riks. 24.

Stockholm, May, 1912.

The Committee for the Horse Riding Competitions.

MEMORANDUM RESPECTING THE TRANSPORT TO AND FROM STOCKHOLM OF HORSES FROM ABROAD WHICH HAVE BEEN ENTERED FOR THE HORSE RIDING COMPETITIONS OF THE OLYMPIC GAMES.

Every horse from abroad that has been properly entered for the Horse Riding competitions of the Olympic Games of Stockholm has been granted by the Swedish Government:

1. Free transport between the Swedish frontier-station and Stockholm, both to and from the competitions;
2. Full exemption from customs-duties on entering Sweden;
3. Exemption, to a certain degree, from the quarantine regulations in force respecting the import of foreign horses to Sweden.

Free transport from the said frontier-stations to and from Stockholm has also been granted to the grooms in charge of the horses, while the horse-furniture (saddles, horse-clothes, etc.) can also be taken carriage- and duty-free.

In order to be able to claim the above-mentioned privileges respecting transport, and also to make the transport of the horses to and from the competitions as convenient as possible for the owners, the latter are desired:

1. To book the horses through to "Olympiska Spelens Hästtäflingskommitté", Stockholm.
2. Either to send the horse direct to Stockholm, or else via one of the following places: Trelleborg, Malmö, Gothenburg or Charlottenburg;
3. In the event of the horses being sent by rail from some place in Europe whose horse-trucks run over the Swedish railways, to make out the bill of freight in such a way, that *the freight-costs shall be paid on arrival in Stockholm.*
4. In the event of the horses being sent by boat to Sweden, to pay the steamship charges and then to forward the bill of lading to the Swedish Committee (as above):

5. To inform the "Olympiska Spelens Hästtäflingskommitté" at Stockholm of the name of the frontier-station at which the horses will be brought into the country; of the route taken, and of the time when they may be expected at the said station; this information should reach the Committee not later than three full days before the calculated arrival of the horses at the frontier-station;

6. To see that the groom accompanying the horses is provided with the following documents, viz.:

a) A certificate in agreement with the official form (green), issued on the writer's word of honour and conscience, to the effect that, during the two months previous to transport, the horse has not been affected by glanders, nor has been in any kind of communication with an animal suffering from the said disease; the reliability of the attester's word being certified to in due form by a Swedish Consul, or by some other official authority;

b) Duplicate lists of the horse-furniture accompanying the horses.

The Committee will see that the grooms are supplied with meals during transport with horses in Sweden, and it will also have the necessary quantities of oats, hay and straw at the frontier-stations, for supplying the horses during transport.

On the condition that the above directions are exactly carried out, the Committee will attend to all the necessary formalities for the transport of the horses in Sweden, and also for the veterinary- and customs-examinations. It will, in addition, advance the amount necessary for the payment of that part of the costs of freight which is due for the transport outside the Swedish frontiers, but the owner of the horses shall be bound to repay the Committee, on demand, the amount of this disbursement for freight.

All postal communications must be addressed:

"Kommittén för Hästtäflingar",
4, Karlavägen, Stockholm.

Telegrams: "Centaur", Stockholm.

The Secretary's telephone is: Riks. 24.

Stockholm, May, 1912.

The Committee for the Horse Riding Competitions.

Relative positions of the Nations in the Horse Riding Competitions, according to the official method of calculating points.

N a t i o n	1:st Prize	2:nd Prize	3:rd Prize	Points
Sweden	4	1	1	15
Germany ..	—	3	1	7
France	1	1	1	6
U. S. A.	—	—	1	1
Belgium	—	—	1	1

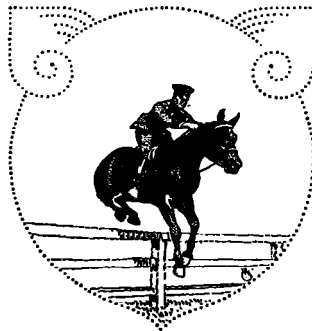

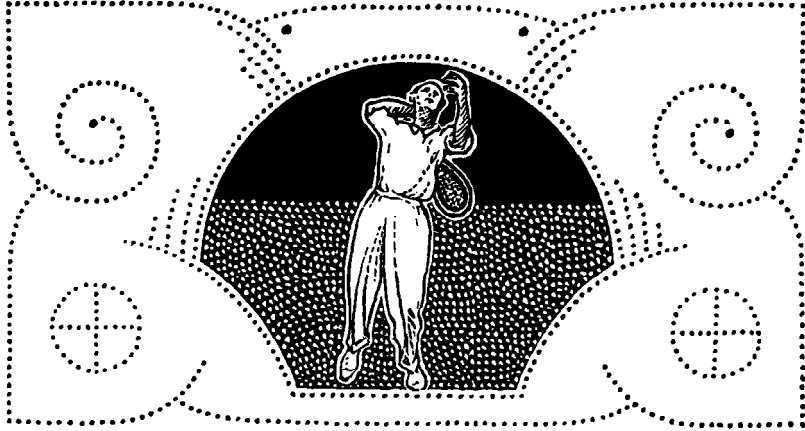

LAWN TENNIS.

REPORT OF THE LABOURS OF THE COMMITTEE.

The Committee of the Swedish Lawn Tennis Association held a meeting on the 15 April, 1910, in consequence of the receipt of a written communication from the Swedish Olympic Committee, asking for an expression of opinion as to the placing of Lawn Tennis competitions on the programme of the Fifth Olympiad.

With regard to the future programme of the Olympic Lawn Tennis Competitions, the Committee, at the meeting, gave its voice for covered court competitions, to be played during the month of May, and to include Gentlemen's Singles, Ladies' Singles, Gentlemen's Doubles, and Mixed Doubles, but, as the proposal of the Swedish Olympic Committee was, that the competitions, if they were to form part of the programme, should be held in connection with the other Olympic events, the Lawn Tennis Committee was consequently obliged to propose another date, and determined to have the matches between June 29 — July 5. The question of out-of-door court competitions was also discussed, and it was thought that a series of such matches should be arranged for the period above mentioned, but nothing came of the plan, in consequence of there being neither courts nor money for the competitions. At the same meeting, a special committee for the Lawn Tennis competitions of the Olympic Games was nominated, the members of the Committee being nearly the same as as those constituting the governing body of the Swedish Lawn Tennis Association.

The Lawn Tennis Committee was as follows.

<i>Hon. President</i>	H. R. H. PRINCE WILHELM.
<i>President</i>	Captain A. WALLENBERG.
<i>Secretary</i>	KURT ZETTERBERG, Esq., Asst. Paymaster, R. N.
<i>Other members</i>	Mrs. M. ADLERSTRÄHLE. Miss EBBA HAY. W. BOSTRÖM, Esq., First Private Secretary to H. M. the King. Lieutenant H. FICK. Consul, JAMES KEILLER Jr. F. BOHNSTEDT, Esq., B. A.

The first thing the Committee did was to draw up the general regulations for the competitions and to fix the rules of the game. As regards the latter, the English Lawn Tennis Association's rules were adopted.

During the winter of 1911, the Tennis Pavilion at the Östermalm Athletic Grounds was completed and then let by the Swedish Central Association for the Promotion of Athletics to a member of the Swedish Olympic Committee, which body determined to make two out-of-door courts just outside the Pavilion.

The holding of Olympic Lawn Tennis out-of-door court competitions was now assured, and the Lawn Tennis Committee at once applied to the Swedish Olympic Committee, requesting that out-of-door court competitions might be placed on the programme of the Games, and that they should take place at the time previously fixed for the covered court events, while the latter, in their turn, should be held in the month of May. In consequence of this request, the out-of-door court competitions for the period above mentioned were placed on the programme, but the Swedish Olympic Committee was not very much inclined to have the covered court matches in May.

Just before the general programme, as a whole, was to be determined, however, the Lawn Tennis Committee made a fresh application, urging their, as they considered, good motives for holding covered-court competitions, and so finally, May 5—12 was fixed as the date of these matches.

The next question of importance was that of the erection of stands for the out-of-door courts. Plans were drawn in the autumn of 1911, and the work of building began in the following March. The stands were ready by the end of April, 1912, and seated 1,500 persons.

At the beginning of 1912, series-cards of admission were issued at 25 kronor (27/6 d.) each, one series for the covered court competitions and another for the out-of-door events. They were in great demand, every ticket being sold about a fortnight before the respective competitions began.

The next task of the Committee was to make a number of alterations in the Tennis Pavilion, to make marking-arrangements, etc. The entries for the covered court competitions closed on the 5 April,

and the draw was at once carried out, while the programmes were printed in English and forwarded to the Olympic Committees of the nations that had entered for the competition.

Before the competitions began, the Committee took steps to procure nets, and balls, and to print day-tickets, protocol-forms and advertisements, while, during the progress of the competitions, the programmes had to be made out and printed day by day.

When the covered court competitions had been brought to a successful issue, the next thing to be done was to at once begin the preparations for the out-of-door events.

At the end of May there was only one court ready, and when entries closed, on the 29, it was found that two courts would not suffice for the great number of competitors. Such an event had been foreseen, however, and sites for two additional courts were already provided. Three of the courts were intended for the matches and the fourth for training. The courts were laid with "Adekvat", a mixture of coal-tar and limestone-tailings, with a thin layer of sand on top.

The Lawn Tennis competitions of the Fifth Olympiad were concluded on the 5 July, after which, the Committee at once commenced to make up its books. They showed an expenditure of 30,000 kronor (c:a £ 1,650: \$ 8,250), including the expense of making two out-of-door courts, the sum required for this swallowing up the surplus that would otherwise have existed.

THE COMPETITIONS.

The covered court competitions.

The close of entries for the covered court competitions was awaited with the greatest interest, and when this took place, a month before the matches begun, six nations were represented, viz., Australasia, Bohemia, Denmark, France, Great Britain and Sweden.

Next to Sweden, which entered the maximum number in every class excepting in the Ladies' Singles, came Great Britain with 11 representatives, 3 lady- and 8 gentlemen players.

Great Britain had sent some of the very best fighters it had: A. W. Gore, C. P. Dixon (the captain), H. Roper-Barrett, G. A. Caridia, A. E. Beamish, T. M. Mavrogordato, the brothers A. H. and F. G. Lowe. The ladies of the team, Mrs. M. Barton, Mrs. E. M. Hannam and Miss Aitchison, are all well known names in the tennis world.

France had entered Monsieur and Madame Decugis, A. H. Gobert and M. Germot.

The representatives of Denmark were Mr. E. Larsen and Miss S. Castenschiold, the best players Denmark possesses for the Gentlemen's and Ladies' Singles.

Australasia sent only one representative, but this was none other than the world-renowned A. F. Wilding, holder of the Wimbledon Championship.

According to the International Olympic regulations, Bohemia had the right to play as a separate nation and had entered four gentlemen for the singles and doubles, and one pair for the mixed doubles. Only two gentlemen, K. Fuchs and J. Haintz, put in an appearance, however, but, not being entered as a pair for the gentlemen's doubles they took part in the singles only.

The covered court competitions began on Sunday May 5 at 1.15 p.m. The doors of the Tennis Pavilion were not opened before 1 p.m. but a long queue had been formed by noon, and when the public was at last granted admission, all the day-tickets that remained were sold within a quarter of an hour, and many hundreds of enthusiasts who had been waiting a considerable time were turned away from the doors.

At 1.15 precisely, the referee made a signal to the umpires for the game to start. C. Kempe gave the first serve, thereby beginning the Games of the Fifth Olympiad — a very simple ceremony, in all truth.

Nothing was finished the first day but the first round in the gentlemen's singles.

GENTLEMEN'S SINGLES.

First Round.

Some really fine matches were seen in this round. G. A. Caridia (Great Britain), who was the favourite in the competition on account of his beautiful style and unique half-volley stroke, had a warm bout with our second player, F. Möller, who succeeded in winning the third set and had lost the second only after it had reached 7—5. Although the Swedish player showed excellent form, he was finally beaten by 6—2, 7—5, 3—6, 6—4.

A. W. Gore (Great Britain) was stoutly opposed by another Swedish player, H. Leffler. Both men were distinctively base-line players, so that the match was a pretty lengthy one, Gore winning by 7—5, 6—4, 7—5.

W. Boström (Sweden) had not been expected to play so finely against A. H. Lowe as he did, for the latter is one of Great Britain's best representatives and has a very difficult screw serve. Boström, on the other hand, possess a strong back hand and has seldom played this stroke with such precision as in this match. He took the first set by 7—5, but lost the following three, all by 6—4.

Among other matches in the first round deserving of mention was that between the French champion A. H. Gobert, and E. Larsen (Denmark). After having lost the first two sets, Larsen began to give a display of quite first-class tennis, took the next set by 7—5 and gained the lead in the fourth by no less than 5—1. Gobert recovered and won the set by 8—6. The French player had some singularly beautiful, lightning strokes. He is evidently an all-round man, with apparently no weak stroke. His forte, however, is the serve, which is mercilessly swift and finishes with an "American" screw. He seemed a little nervous, and often gave double faults. If Gobert could free himself of these weaknesses he would be the beau ideal of a tennis player.

Second Round.

Here Sweden's representative, T. Grönfors, after a good defence, was beaten by A. F. Wilding (Australasia), by 6—3, 6—3, 6—3. Grönfors played with great life and did some very fine volleying, his strong point.

A W. Gore, the English ex-champion, and now in his forty-fifth year, was, probably to the surprise of a great many persons, beaten in the same round by G. A. Caridia by 3 sets to love; 6—2, 9—7, 7—5. Caridia played an excellent game, while Gore's formidable forehand drives did not always come off.

The match which, in this round, was awaited with the greatest interest by Swedish spectators was that between G. Setterwall, the Swedish champion, and H. Roper-Barrett (Great Britain). Opinions were divided as to the result of the match for, from the very first, it could be seen that both men were in their best form. Roper-Barrett took the first set by 6—4 and then Setterwall won two in succession by 6—1 6—4. The fourth went to Roper-Barrett by 8—6. In the fifth set Setterwall managed to get the upper hand by means of some energetic play at the net and won the set and the match by 6—4.

Roper-Barrett is certainly the most subtle player that Great Britain boasts. His every stroke seems to be given only after wonderful deliberation, and he takes balls in the most impossible places and in the most impossible way. It is difficult to understand, however, how a player like Roper-Barrett, who does not possess any really well-defined stroke, can play so effectively. Setterwall won by means of his charming volleys and killing smashes.

Third Round.

In the third round G. A. Caridia suffered a crushing defeat at the hands of A. F. Wilding. The first-named, who on the two previous days had played excellently, could never find himself in this match, none of his finest strokes coming off. Wilding played throughout with uniform energy and won by 6—1, 6—2, 6—2.

After his victory over Roper-Barrett, Setterwall had to meet F. G. Lowe (Great Britain). In his match against Barrett the Swede played against loose, well-placed balls. In this match, on the other hand, he had to fight against hard, long, safe drives, and instead of playing a hard game in return Setterwall unfortunately adopted the tactics he had employed against his previous opponent and did not venture up to the net so often, Lowe getting the ball past him several times when he did. Setterwall played altogether too much on the defensive — quite the wrong game against such a steady player as Lowe — and the Swede lost, the final result being 6—4, 1—6, 6—3, 8—6.

SEMI-FINALS.

The most extraordinary of all the matches, in the Gentlemen's Singles at least, was that in which Wilding was beaten by Dixon. The result was a perfect surprise, for Dixon never plays well on covered courts. As it happened, however, those at Stockholm suited him to perfection, as Dixon himself declared, stating that he had never played so well on covered courts as in this match. It must be acknowledged, however, that against Dixon — as, indeed, throughout the whole of the competition — Wilding was hardly in his usual form, probably from want of training. Dixon played scarcely anything else than a net-game, nearly always following up his serve by going forward. Dixon is a perfect master at this play and, thanks to his successful tactics on this occasion, he beat the holder of the World's Championship by three sets to one; 6—0, 4—6, 6—4, 6—4.

The second semi-final was that between A. H. Gobert (France) and F. G. Lowe (Great Britain). Gobert won the first two sets by 6—4, 10—8 but then fell off

altogether and the next two sets were won easily by Lowe, 6—2, 6—2. In the deciding set, however, Gobert was his old self, and won the final set and the match by 6—2.

Wilding, and F. G. Lowe, having thus been beaten in the semi-finals, had to play for third prize. Wilding, however, was not altogether in form. He lost the first set by 6—4 and won the next by 6—2. In the third set Lowe led by 5—1 but then Wilding came on, took the set by 7—5, and the next and last by 6—0.

THE FINAL.

After the conclusion of a week's matches, A. H. Gobert and C. P. Dixon met in the final of the Gentlemen's Singles. Both men did some beautiful work, though Dixon possibly did not play so well now as he had done against Wilding. The Englishman had the lead at the beginning of all the three sets, in the first two by 2—0, and in the third by 3—1. On each occasion, however, Gobert showed that he was master of his game, and, after a warm contest, succeeded in getting the lead. After 90 minutes' play the French Champion won the Olympic Gold Medal in the Gentlemen's Singles by 8—6, 6—4, 6—4, amid the lively applause of the spectators, who occupied every spare inch of the Tennis Pavilion.

LADIES' SINGLES.

Second Round.

In the Ladies' Singles, Miss F. H. Aitchison (Great Britain) was beaten in the second round by the holder of the Danish Ladies' Championship, Miss S. Castenschiold, a result that had scarcely been expected. Miss Aitchison possessed some fine, long strokes, and placed her balls far back along the side lines, while Miss Castenschiold, on the other hand, gave short balls which seldom came farther than half-way over her opponent's court. The Danish representative, however, had an enormous amount of energy and never seemed to tire, in spite of all the exercise her opponent gave her. Her aim evidently was merely to get the ball over the net and allow Miss Aitchison to strike it out. The latter tired by degrees, and her strokes beginning to lose in accuracy, she quickly lost the last two sets after having won the first with similar ease. The result was 2—6, 6—2, 6—1 in favour of Miss Castenschiold.

SEMI-FINALS.

Miss Castenschiold had now to meet in the first semi-final the Lady Champion of Sweden, Mrs. S. Fick. A victory was hardly expected for the Swedish colours, but a good match was hoped for, and Mrs. Fick played very well the whole time. Her strokes had not the accuracy that marked Miss Castenschiold's, however, and the Danish champion won after two equal sets by 6—4, 6—4.

The second semi-final was played between two representatives of Great Britain, Mrs. M. Parton and Mrs. E. Hannam, the latter winning, thanks to the pace of her balls and her own greater activity. The result was 7—5, 6—2.

Mrs. Parton and Mrs. Fick had to play for the third prize, and in this game the difficult screws of the former were altogether too much for the Swedish representative, Mrs. Parton winning by 6—3, 6—3.

Gentlemen's Singles. (Covered courts.) 25 entries.

.....	bye	C. P. Dixon, Great Britain ...	C. P. Dixon			
.....	»	T. M. Mavrogordato, Great Britain	6-2 9-7 4-6 10-8	}	C. P. Dixon	6-2 6-4 6-1
.....	»	K. Fuchs, Bohemia	K. Fuchs			
M. Decugis, France		J. Just	W. O.	}	C. P. Dixon	6-0 4-6 6-4
J. Just, Bohemia		W. O.				
T. Grönfors, Sweden		T. Grönfors		}	C. P. Dixon	6-4
J. Sebek, Bohemia		W. O.	A. F. Wilding ...			
L. Silverstolpe, Sweden		A. F. Wilding	6-3 6-3 6-3	}	A. F. Wilding ...	6-1 6-2 6-2
A. F. Wilding, Australasia ...		6-0 6-1 6-1				
F. Möller, Sweden		G. A. Caridia		}	A. H. Gobert.	8-6 6-4 6-4
G. A. Carida, Great Brit.		6-2 7-5 3-6 6-4	G. A. Caridia ...			
A. W. Gore,		A. W. Gore	6-2 9-7 7-5	}	A. H. Gobert	8-6 6-4 6-4
H. Leffler, Sweden		7-5 6-4 7-5				
W. Boström,		A. H. Lowe	A. H. Lowe	}	A. H. Gobert	6-4 10-8 2-6
A. H. Lowe, Great Britain ...		5-7 6-4 6-4 6-4	6-4 3-6 6-1			
M. Germot, France		M. Germot	6-4	}	A. H. Gobert	2-6 6-2
A. E. Beamish, Great Britain ...		4-6 6-2 4-6 6-2 6-4				
E. Larsen, Denmark		A. H. Gobert		}	A. H. Gobert	6-4 10-8 2-6
A. H. Gobert, France		8-6 6-1 5-7	A. H. Gobert ...			
I. Haintz, Bohemia		C. Kempe	6-1 6-2 7-5	}	A. H. Gobert	6-4 10-8 2-6
C. Kempe, Sweden		6-1 6-4 3-6 6-3				
.....	bye	H. Roper-Barrett, Great Britain ...	G. Setterwall	}	F. G. Lowe	8-6
.....	»	G. Setterwall, Sweden	4-6 6-1 6-4 6-8 6-4			
.....	»	F. G. Lowe, Great Britain ...	F. G. Lowe	}	F. G. Lowe	6-4 1-6 6-3
.....	»	C. Wennergren, Sweden	6-4 6-1 6-4			

Game for third prize A. F. Wilding beat F. G. Lowe 4-6 6-2 7-5 6-0.

Ladies' Singles. (Covered courts.) 10 entries.

.....	bye	Mrs. E. Arnheim, Sweden	E. M. Hannam
.....	•	Mrs. E. M. Hannam, Great Britain	7-5	6-1	
.....	•	M-me M. Decugis, France	M. Parton	E. M. Hannam
.....		W. O.	6-4 6-3
.....		Miss M. Cederschiöld, Sweden	M. Parton	
.....		Mrs M. Parton, Great Britain	6-0	6-1	
.....		Mrs S. Fick, Sweden	S. Fick	
.....		Miss E. Magnusson, Sweden	W. O.	
.....	bye	Miss A. Holmström, Sweden	S. Fick	S. Castenschiöld
.....	•	Miss S. Castenschiöld, Denmark	6-1	6-1	6-4 6-4
.....	•	Miss F. H. Aitchison, Gr. Britain	S. Castenschiöld	
.....		2-6	6-2	6-1

Game for third prize. M. Parton beat S. Fick 6-3 6-3.

THE FINAL.

The final in the Ladies' Singles 1 brought together Mrs. Hannam and Miss Castenschiöld, representatives respectively of Great Britain and Denmark. Never before, on Swedish lawn tennis courts, has there been seen such first-class play by a lady as that shown by Mrs. Hannam. She held the upper hand from the first moment of the game to the very last, and her well placed drives kept Miss Castenschiöld running without a pause from one side of the court to the other. The Danish representative made a good fight, however, and showed great cleverness in taking the most difficult balls, but, unfortunately, could only make very feeble returns. This, of course, allowed Mrs. Hannam to come forward to the net and kill her opponent's balls with some well-placed smashes. Mrs. Hannam won by two sets to love: 6-4, 6-3.

GENTLEMEN'S DOUBLES.

First Round.

The most interesting match in the first round of the Gentlemen's Doubles was that between the leading representatives of Sweden, G. Setterwall—C. Kempe and G. A. Caridia—T. M. Mavrogordato (Great Britain). The struggle was a very keen one, all the five sets being played. The Swedish pair seemed more accustomed to playing together than were their opponents and won the match by 6-4, 4-6, 6-8, 6-2, 6-3.

In the same round, the brothers Lowe (Great Britain) had a by no means easy task before they succeeded in beating C. Wengergren and C. O. Nylén (Sweden). The latter came very near winning the first two sets, which were finally carried off by the Lowes by 9-7, 11-9. The third set was won by Great Britain's representatives, in considerably shorter time, by 6-2.

Second Round.

In the second round, after playing five sets, the Lowes had to acknowledge defeat at the hands of A. H. Gobert and M. Germot (France). The latter pair lost the first two sets by 3—6, 6—8 but won the next three pretty easily by 6—4, 6—2, 6—3.

SEMI-FINALS.

The first match was between Dixon—Beamish (Great Britain) and Gobert—Germot (France). The Frenchmen won a very easy victory by 6—3, 6—1, 6—2, Beamish being altogether out of form.

The second semi-final was perhaps the most exciting match of any in the competition, the winners of the Gold Medal at the Olympic Games of London, 1908, A. W. Gore—H. Roper-Barrett playing against G. Setterwall — C. Kempe (Sweden). At first, things went badly for the Swedes, who appeared to be a little uncertain in their game, and the first two sets went to their opponents by 6—4, 6—3. Then came a wonderful change however, and from this point to the end of the match, the Swedish players easily held the upper hand, winning the last three sets by 6—1, 6—4, 6—3. The victory awakened a storm of enthusiasm among the spectators.

C. P. Dixon—E. A. Beamish (Great Britain) played for the third prize against their fellow countrymen, A. W. Gore—H. Roper-Barrett, and won by 6—2, 0—6, 10—8, 2—6, 6—3.

FINAL.

The final in the Gentlemen's Doubles (covered courts) between A. H. Gobert—M. Germot (France) and G. Setterwall—C. Kempe (Sweden) was another delightful match, and probably the finest of any in the covered court competitions, all the players being in brilliant form. The serve dominated the game so entirely that each set was nearly always taken by the server. In the first, however, Setterwall was unlucky enough to lose a serve-game, and the set was taken by the Frenchmen by 6—4. When 25 games had been played in the second set, Germot lost his serve and the set was won by Setterwall—Kempe by 14—12. In the third and fourth sets the Swedes fell off somewhat, but still gave their opponents a very good game, who won here by 6—2, 6—4, thereby carrying off the Olympic Gold Medal.

The fine play of the Swedes against such a strong combination as Gobert—Germot at their best, gained them the honour of being called "a great pair", by the English journal, "Lawn Tennis and Badminton".

MIXED DOUBLES.

Preliminary rounds.

The idea prevailed that, in the Mixed Doubles, Mrs. M. Parton and Mr. T. M. Mavrogordato, the winners of the Wimbledon championship in 1911, would carry off the final honours here too, but they were beaten in the second round by Mrs. Hannam and C. P. Dixon, 2—6, 6—4, 6—3. The pair last mentioned were thus certain of being in the final.

On the other half of the programme, Miss F. H. Aitchison and H. Roper-Barrett fought their way onwards to meet the two players just mentioned. In the semi-

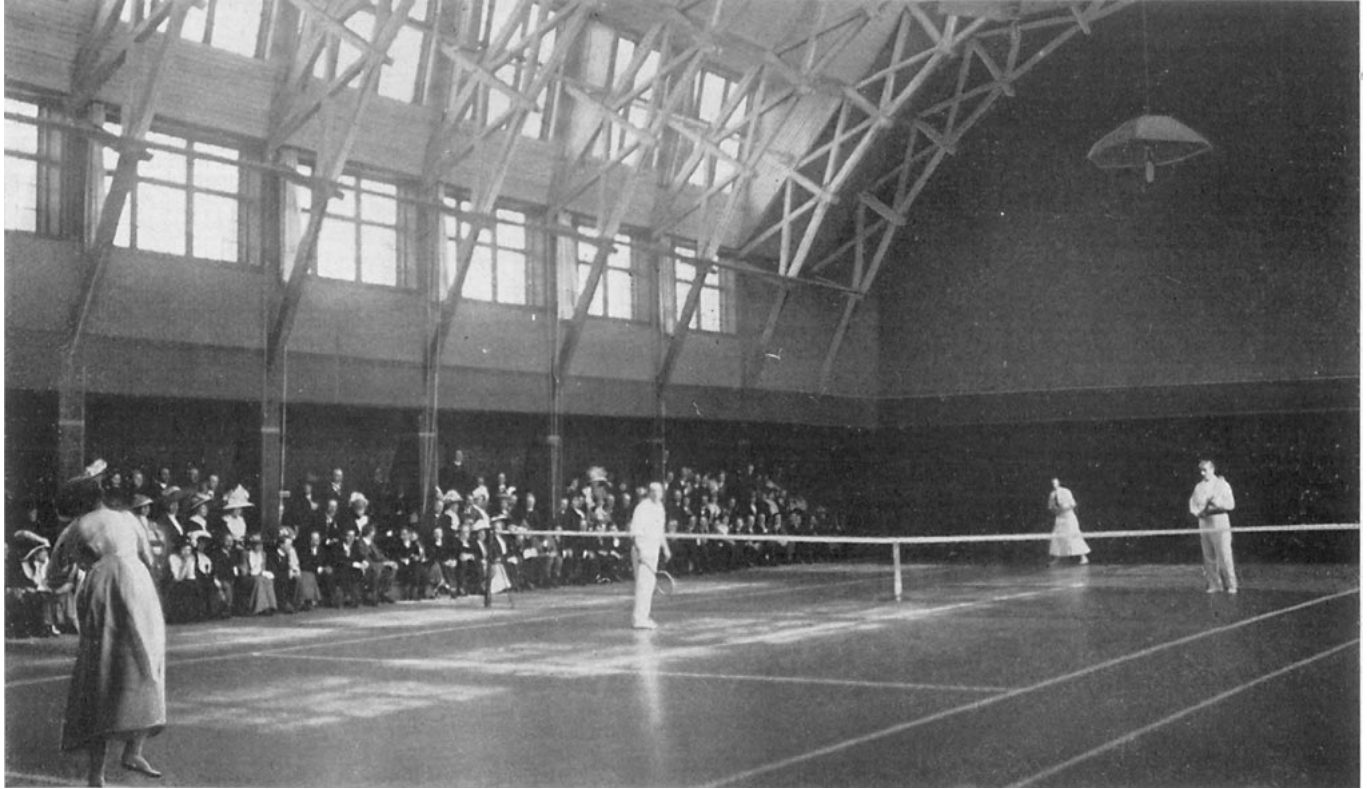

FINAL IN MIXED DOUBLES. Mrs. E. HANNAM and C. P. DIXON v. Miss F. H. AITCHISON and H. ROPER-BARRET.

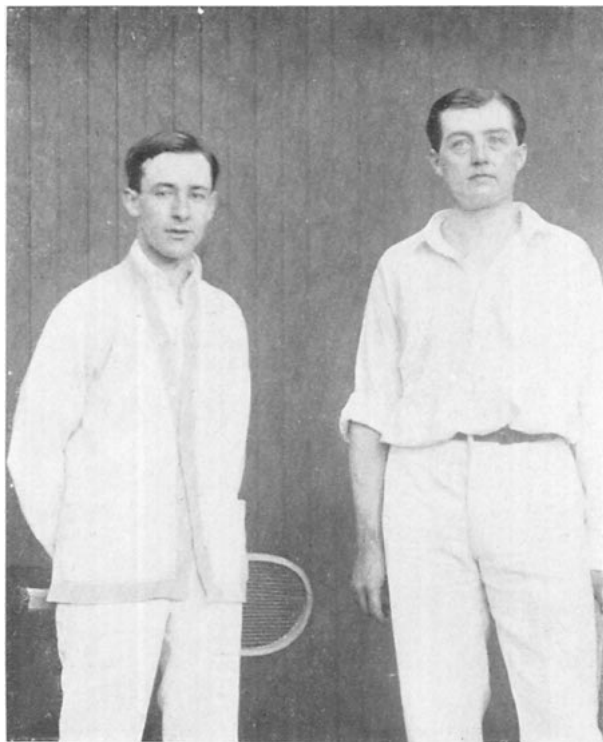

GENTLEMEN'S DOUBLES (covered courts).
C. KEMPLE and G. SETTERWALL, winners of 2:nd prize, Sweden.

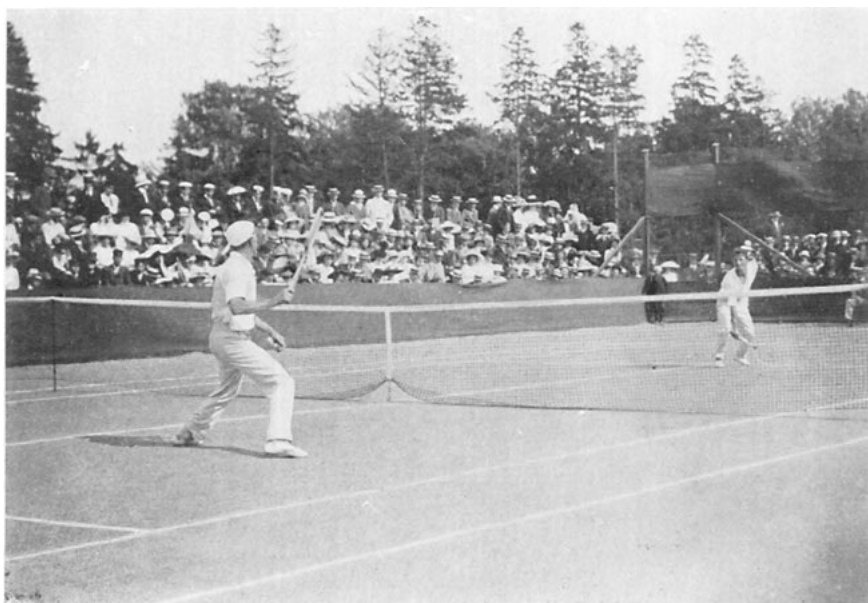

FINAL IN GENTLEMEN'S SINGLES.
C. WINSLOW (winner) and H. A. KITSON, both South Africa.

Gentlemen's Doubles. (Covered courts.) **11** entries.

40
Fifth Olympiad.

625

.....	bye	{ C. P. Dixon, Great Britain	} C. P. Dixon and E. Beamish	} A. H. Gobert and M. Germot	
.....		{ E. A. Beamish, „			A. Beamish
.....		{ K. Fuchs, Bohemia	} W. O.	} 6-3 6-1 6-2	
.....		{ J. Just, „			
F. G. Lowe, Great Britain	}	F. G. Lowe and A. H. Lowe	} A. H. Gobert and M. Germot	} 3-6 6-8 6-4 6-2	
A. H. Lowe, „					
C. Wennergren, Sweden					9-7 11-9 6-2
C. Nylén, „					
A. H. Gobert, France	}	A. H. Gobert and M. Germot	} 6-3	} A. H. Gobert and M. Germot	
M. Germot, „					W. O.
J. Sebek, Bohemia	}	W. O.	}	} 6-4 12-14 6-2	
J. Haintz, „					
G. A. Caridia, Great Britain	}	G. Setterwall and C. Kempe	} G. Setterwall and C. Kempe	} G. Setterwall and C. Kempe	
T. M. Mavrogordato, „					
G. Setterwall, Sweden					9-4 4-6 6-8 6-2 6-3
C. Kempe, „	}	} F. Möller, Sweden	} W. O.	} 4-6 3-6 6-1 6-4	
.....					bye
.....	}	} W. Boström, Sweden	} A. W. Gore and H. Roper-Barrett	} 6-3	
.....					{ C. Benckert, „
.....	}	} A. W. Gore, Great Britain	} 7-5 6-4 6-1	}	
.....					{ H. Roper-Barrett, „

Game for third prize. C. P. Dixon—A. E. Beamish beat A. W. Gore—H. Roper-Barrett 6-2 0-6 10-8 2-6 6-3.

final Miss Aitchison and Roper-Barrett beat the best Swedish pair, Mrs. S. Fick and G. Setterwall, after some fine play on both sides, all three sets having to be played. Mrs. Fick, especially, was in her very best form, but Setterwall, although he made some good strokes, was not in sufficient evidence at the net. Roper-Barrett, on the other hand, let very little get past him there, and Miss Aitchison's long drives along the side-lines awakened general admiration. Barrett-Aitchison won by 3—6, 6—1, 6—2,

FINAL.

The final of the Mixed Doubles was the last event of the competition, and gave a fine example of the way in which this game should be played, i. e., with the man at the net and his partner at the base-line. The struggle for the Gold Medal was between two pairs both representing Great Britain; Miss Aitchison — H. Roper-Barrett and Mrs. Hannam—C. P. Dixon. The first set was won by Aitchison—Roper-Barrett by 6—4, but the next two sets went to their opponents by 6—3, 6—2, this deciding the match in favour of Hannam—C. P. Dixon. The winners were greeted with well deserved applause.

Presentation of Prizes.

H. M. The King gave away the prizes immediately after the close of the competitions at 5 p. m., May 12th.

PRIZE LIST.

Gentlemen's Singles.

I prize:	A. H. Gobert	France.
II »	C. P. Dixon	Great Britain.
III »	A. F. Wilding	Australasia.

Ladies' Singles.

I prize:	Mrs. E. M. Hannam ..	Great Britain.
II »	Miss S. Castenschiold	Denmark.
III »	Mrs. M. Parton.....	Great Britain.

Gentlemen's Doubles.

I prize:	A. H. Gobert and M. Germot.....	France.
II »	G. Setterwall and C. Kempe.....	Sweden.
III »	C. P. Dixon and A. E. Beamish	Great Britain.

Mixed Doubles

I prize:	Mrs. E. M. Hannam and C. P. Dixon	Great Britain.
II »	Miss F. H. Aitchison and H. Roper-Barrett	Great Britain.
III »	Mrs. S. Fick and G. Setterwall	Sweden.

Mixed Doubles. (Covered courts.) 10 entries.

.....	bye	{ Mrs. S. Fick, Sweden G. Setterwall, Sweden	S. Fick and G. Setterwall W. O.	} F. H. Aitchison and H. Roper-Barrett 3-6 6-1 6-2			
.....	,	{ M:me M. Sebkova, Bohemia..... J. Sebek, »	F. H. Aitchison and H. Roper-Barrett..... 6-0 6-3				
.....	,	{ Miss S. Castenschiold, Denmark ... E. Larsen, »					F. H. Aitchison and H. Roper-Barrett..... 6-2 6-4
Mrs. E. Arnheim, Sweden			F. H. Aitchison and H. Roper-Barrett..... 6-2 6-4				
C. O. Nylén, »							F. H. Aitchison and H. Roper-Barrett..... 6-2 6-4
Miss F. H. Aitchison, Great Britain			F. H. Aitchison and H. Roper-Barrett..... 6-2 6-4				
H. Roper-Barrett, »							F. H. Aitchison and H. Roper-Barrett..... 6-2 6-4
Mrs. M. Parton, »			M. Parton and T. M. Mavrogordato 6-3 6-0				
T. M. Mavrogordato, »							M. Parton and T. M. Mavrogordato 6-3 6-0
Miss E. Hay, Sweden.....			M. Parton and T. M. Mavrogordato 6-3 6-0				
F. Möller, »				M. Parton and T. M. Mavrogordato 6-3 6-0			
.....	bye	{ Mrs. E. M. Hannam, Great Britain C. P. Dixon, »	E. M. Hannam and C. P. Dixon 6-2 6-2		} E. M. Hannam and C. P. Dixon 4-6 6-3 6-2		
.....	,	{ Miss M. Cederschiöld, Sweden..... C. Kempe, »	M. Cederschiöld and C. Kempe W. O.				
.....	,	{ M:me M. Decugis, France				M. Cederschiöld and C. Kempe W. O.	
.....	,	{ M. Decugis, »	M. Cederschiöld and C. Kempe W. O.				

Game for third prize. S. Fick—G. Setterwall. W. O. M. Cederschiöld—C. Kempe, retired.

Gentlemen's Singles. (Out-of-door courts.) 67 entries.

.....	bye	H. Leffler, Sweden	A. H. Kitson ..	A. H. Kitson			
.....	»	A. H. Kitson, South Africa	6-2 6-1 6-0	6-2 6-2	A. H. Kitson		
.....	»	F. Möller, Sweden	F. Möller.....	6-3	6-2 6-2		
.....	»	J. P. Samazeuilh, France ...	W. O.		6-3		
.....	»	R. C. Spies, Germany	R. C. Spies.....	H. Schom- burgk.....			
.....	»	J. Just, Bohemia	2-6 6-3 3-6	8-6 6-1		A. H. Kitson	
.....	»	H. Schomburgk, Germany...	6-3 6-1	4-ret.		6-2 6-2	
.....	»	J. Montariol, France	W. O.			6-4	
.....	»	W. Boström, Sweden	W. Boström.....	L. Salm.....			
.....	»	T. Smith, Norway	6-2 6-4 6-1	7-5 6-4			
.....	»	P. M. Peterson, Norway ...	L. Salm	6-1	L. Salm.....		
.....	»	Count L. Salm, Austria.....	6-1 7-5 6-3		6-3 5-7		
.....	»	J. Zeman, Bohemia.....	C. Wennergren	C. Wenner- gren	7-5 6-1		
.....	»	C. Wennergren, Sweden ..	6-1 6-0 6-0	4-6 9-7		A. H. Kitson	
.....	»	L. Rovsing, Denmark	L. Rovsing	6-8 6-1		2-6 6-3	
.....	»	P. Segner, Hungary	W. O.	6-1		6-2 4-6	
.....	»	V. G. Hansen, Denmark ...	V. G. Hansen...	B. v. Kehrling		6-3	
.....	»	O. Schmid, Hungary	W. O.	6-2 6-1			
.....	»	C. Kempe, Swden	B. v. Kehrling...	6-8 6-4	O. V. Müller		
.....	»	B. v. Kehrling, Hungary ...	W. O.		6-2 6-1		
.....	»	E. Zsigmondy,	E. Zsigmondy ...	O. v. Müller	6-1		
.....	»	H. Liebisch, Austria	W. O.	6-1 6-2			
.....	»	O. v. Müller, Germany	O. v. Müller ...	6-0		L. Zemla ...	
.....	»	O. Frederiksen, Denmark ...	6-2 6-1 6-4			6-4 7-5	
.....	»	H. Planner v. Plaun, Austria	R. Bertrand.....	L. Zemla ...		6-4	
.....	»	R. Bertrand, Austria	W. O.	W. O.			
.....	»	A. Hammacher, Germany ...	L. Zemla		L. Zemla ...		
.....	»	L. Zemla, Bohemia.....	W. O.		1-6 4-6		
.....	»	F. J. Blanchy, France	F. J. Blanchy ...	L. E. Tapscott	6-2 6-4		
.....	»	B. Hyks, Bohemia	5-7 6-1 6-2	1-6 5-7	6-2		
.....		J. Kodl, Bohemia	L. E. Tapscott	6-3 6-4			
.....		L. E. Tapscott, South Africa	6-4 6-1 6-2	6-4			
.....		F. Pipes, Austria	F. Pipes	3-6 7-5 4-6			
.....		O. Lindpainter, Germany...	6-2 6-3 6-3	7-5 7-5			

C. Winslow
7-5 4-6
10-8 8-6

K. Thayssen, Denmark ...	A. Thayssen	A. Thayssen ...				
A. Ardel, Bohemia	W. O.	6-1 6-3 3-6	C. Winslow			
.....	bye	6-3	6-4 3-6	C. Winslow		
.....	»	A. S. Madsen, Denmark ...	6-4 6-4	6-4 8-6		
.....	»	C. Winslow, South Africa ...	C. Winslow	6-4		
.....	»	P. Frigast, Denmark	7-5 6-2 6-3			
.....	»	T. Grönfors, Sweden	T. Grönfors	V. Ingerslev		
.....	»	E. Toth, Hungary	W. O.	6-1 6-2		
.....	»	J. Arenholt, Denmark.....	V. Ingerslev ...	6-2		
.....	»	V. Ingerslev,	6-2 1-6 6-0			
.....	»	M. Mény, France	6-4			
.....	»	L. M. Heyden, Germany ...	L. M. Heyden ...	C. Winslow		
.....	»	L. v. Baráth, Hungary	7-9 4-6 6-2	6-2 6-4		
.....	»	A. v. Kelemen,	7-5 6-1	8-10 4-6		
.....	»	A. H. Canet, France	A. v. Kelemen ...	6-3		
.....	»	C. Langaard, Norway	6-1 6-3 6-4	6-3		
.....	»	P. Gyula, Hungary.....	A. H. Canet ...	6-2 6-3		
.....	»	T. Roosevelt-Pell, U. S. A. ...	6-3 6-0 6-1	6-4		
.....	»	N. Stibolt, Norway.....	T. R. Pell			
.....	»	D. E. Lawton, France	W. O.			
.....	»	J. Sebek, Bohemia	N. Stibolt	J. Sebek ...		
.....	»	O. Froitzheim, Germany ...	W. O.	6-1 6-3		
.....	»	K. Fuchs, Bohemia	J. Sebek	6-0		
.....	»	C. v. Wessely, Austria	W. O.	A. Zborzil...		
.....	»	A. Zborzil,	A. Zborzil	6-1 6-0		
.....	»	C. Benckert, Sweden	6-2 6-4 1-6	3-6 6-2		
.....	»	O. Blom, Holland	6-3			
.....	»	G. Setterwall, Sweden	G. Setterwall ...	O. Kreuzer..		
.....	»	Count M. Soumarokoff, Russia	6-3 6-3 8-6	6-4 6-2		
.....	»	A. Alenitzyn, Russia	M. Soumarokoff	6-2 6-3		
.....	»	O. Relly, Austria	W. O.	11-13 6-2		
.....	»	B. Angell, Norway.....	W. O.	6-2 10-12		
.....	»	O. Kreuzer, Germany	O. Kreuzer	6-4 6-0		
.....	»	H. Björklund, Norway	6-0 6-0 6-1	W. O.		

Game for third prize. O. Kreuzer beat L. Zemla 6-2 3-6 6-3 6-1

Placing of the competing nations in Cov.-Court Comp.

	Gold Medals.	Silver Medals.	Bronze Medals.	Total Points.
1. Great Britain.....	2	2	2	12
2. France	2	—	—	6
3. Sweden	—	1	1	3
4. Denmark.....	—	1	—	2
5. Australasia	—	—	1	1
6. Bohemia	—	—	—	0

Out-of-door court competitions.

Of course, it was expected that there would be a greater number of entries for the Lawn Tennis out-of-door court competitions than for the covered court events, the first-named class being more generally played abroad, but, in spite of this fact, it was somewhat of a surprise to have a total of no less than some 70 players from 11 other nations in addition to Sweden.

The nations that signified their intention to take part in the Lawn Tennis out-of-door competitions were Austria, Bohemia, Denmark, France, Germany, Holland, Hungary, Norway, Russia, South Africa, Sweden and the U. S. A.

As may be seen, Great Britain was not of the number, the reason being that the time at which the Olympic out-of-door court matches were to be held was the same as that fixed for the English Championship meeting at Wimbledon. The Lawn Tennis authorities of Great Britain made many attempts to get the date of the Olympic competitions altered, but for several good and sufficient reasons the Swedish Olympic Committee found it impossible to make the desired change, with the result that there were no entries from Great Britain.

Amongst the competitors entered we must mention the German champion, O. Froitzheim, who, however, finally took no part in the matches, but played instead in the Wimbledon competitions. In addition, there were A. H. Kitson, C. Winslow and L. E. Tapscott (South Africa) whom rumour stated to be first-class players and who surpassed all expectations. Among the other players deserving of special mention may be named O. Kreuzer, O. v. Müller, H. Schombourk and L. M. Heyden (Germany); Count Salm and Dr. F. Pipes (Austria); Count M. Soumarokoff (Russia); M. Mény, A. H. Canet, and F. J. Blanchy (France); T. Roosevelt-Pell (U. S. A.) and the Bohemian champion, L. Zemla. Among the ladies were Mlle Broquedis, lady-champion of France, Frl. M. Rieck, G. Kaminski and D. Köring (Germany) and the two Miss Bjurstedts, Norway. Of these, Frl. Rieck and Frl. Kaminski, two of Germany's best lady-players, did not put in an appearance.

In consequence of the great number of entries, the Committee for Lawn Tennis endeavoured to have the beginning of the competitions moved forward to the 28 June instead of the 29, as was previously determined, in order not to be obliged to hurry the matches and unnecessarily fatigue the players. It was found impossible to add that

day to the period fixed for the Lawn Tennis competitions, as the fencing was to begin on the 6 July, and the dressing-rooms, etc., had to be ready for their new occupiers by the date fixed.

All the nations that had made entries, were asked if there was any objection on their part against beginning the competitions on the 28 June, and, as nearly all of them approved of the proposed change, the out-of-door court events began on the new date and were concluded on Friday, the 5 July.

The competitions were favoured with the most glorious weather, with the exception of one day when rain interrupted play from 10 a. m. to 5 p. m. Happily, however, the rain came at a time when most of the matches were finished and, consequently, it occasioned no difficulty in carrying out the competitions. The oppressive heat, on the other hand, caused serious inconvenience to many of the players, the thermometer showing every day a temperature of 26°—28° C. (78—81° Fahr.) in the shade, while, during the whole of each forenoon there was absolutely no shelter against the heat of the sun.

GENTLEMEN'S SINGLES.

First and second rounds.

There was no match of any great interest in the first round of the Gentlemen's Singles, but, in the second round, L. E. Tapscott, the young South African (who is only 18) succeeded, after a hard game, which was continued to the end of the fifth set, in beating F. Pipes (Austria) by 3—6, 7—5, 4—6, 7—5, 7—5. In spite of his youth Tapscott is undoubtedly a player of high rank, possessing a hard screw-serve and a screwing forehand-stroke. In addition to this, his balls have a high rebound and break away considerably. He also volleys very well. Pipes has the American serve, too, and is very safe, but, unlike the South African, is a base-line player.

G. Setterwall, the Swedish champion, who had a bye in the first round, met O. Blom, the holder of the Dutch championship, in the second. As Setterwall, like other Swedish players, is not at home on out-of-door courts, some doubt was felt by spectators as to the result. He played an energetic game, however, and seized every opportunity of employing his effective volleys. Blom, again, was almost too careful and played into the hands of his opponent at the net. Setterwall won by 3 successive sets, 6—3, 6—3, 8—6.

Third round.

In this round Setterwall met the young Russian, Count M. Soumarokoff, who won by three sets to one; 6—2, 6—3, 11—13, 6—2. Soumarokoff, is a left hand player with a very peculiar style, his balls, like Tapscott's, breaking away finely. It was just this break that won the game, for Setterwall could never quite get hold of his opponent's balls, although the Russian played a good game at the net too, getting past Setterwall very often, this preventing the Swedish champion from using his volley-play as much as he ought to have done. Soumarokoff, with a little more experience and greater steadiness, will probably become a formidable figure on tennis courts.

Forth round.

In the fourth round, Soumarokoff met O. Kreuzer (Germany), and was beaten after a sharp contest, Kreuzer winning by 6—2, 10—12, 6—4, 6—0.

In the same round, the U. S. A. representative, T. R. Pell, to everybody's surprise was beaten by L. M. Heyden (Germany) by 2—6, 7—5, 8—6, 7—5. Pell is one of the many good players in the U. S. A. and great hopes were entertained of his success, and it was only his somewhat uncertain play that lost him several sets in this match. Heyden's play is deserving of all praise, not only on account of what he did in this match, but also for his many fine performances during the competition. He is quite an all-round man with a hard, well-placed ball and; taking into consideration that he is: only 19 years of age, he seems to have good prospects of advancement on the tennis court.

The only Swede that reached the fourth round was C. Wennergren, but he was beaten by Count L. Salm (Austria) by three sets to one; 6—3, 5—7, 7—5, 6—1.

Another match worthy of mention in this round was that between L. Zemla, the Bohemian champion, and L. E. Tapscott (South Africa), the former winning by 1—6, 4—6, 6—2, 6—4, 6—2. Zemla was one of the favourites in the tournament in consequence of his graceful, safe play. He is master of every stroke, and handles his racket beautifully.

Fifth round.

Eight players were left in for the fifth round; A. H. Kitson, Count L. Salm, O. von Müller, L. Zemla, C. Winslow, L. M. Heyden, A. Zborzil and O. Kreuzer,

Kitson (South Africa) had no trouble in beating Count Salm (Austria) by three sets in succession; 6—2, 6—2, 6—4.

L. Zemla beat O. von Müller (Germany) by three sets, too. Von Müller is one of the best players that Germany boasts and plays a beautiful, safe base-line game. In this match with Zemla, however, he did not seem to be in his best form, otherwise the victor's task would have been a severer one.

There was a long five-sets match between C. Winslow and L. M. Heyden, the latter being in the same excellent form as when he beat Pell, and Winslow had to do all he knew to win. The result was 6—2, 6—4, 8—10, 4—6, 6—3 in favour of the South African.

O. Kreuzer easily beat Zborzil (Austria) by 6—4, 6—3, 6—2.

SEMI-FINALS.

The match between Zemla (Bohemia) and A. H. Kitson (South Africa) in this semi-final was really the first time the latter had met with any opposition during the course of the competition. Five sets were played and if Kitson had played less carefully, the result would probably been very doubtful. As it was, however, Kitson led the whole time in the fifth set and won by 2—6, 6—3, 6—2, 4—6, 6—3.

In the second semi-final, O. Kreuzer was comparatively easily beaten by the other South African, C. Winslow, by 9—7, 7—5, 6—1. This was perhaps Winslow's best game, although the oppressive heat undoubtedly influenced Kreuzer, who seemed to be less energetic than usual.

L. Zemla and O. Kreuzer, having thus been beaten in the semi-finals had to play for the bronze medal. In this match, Kreuzer was much safer than in his bout against Winslow while Zemla, on the other hand, seemed less confident than when he met Kitson, and his opponent won fairly easily by 6—2, 3—6, 6—3, 6—1.

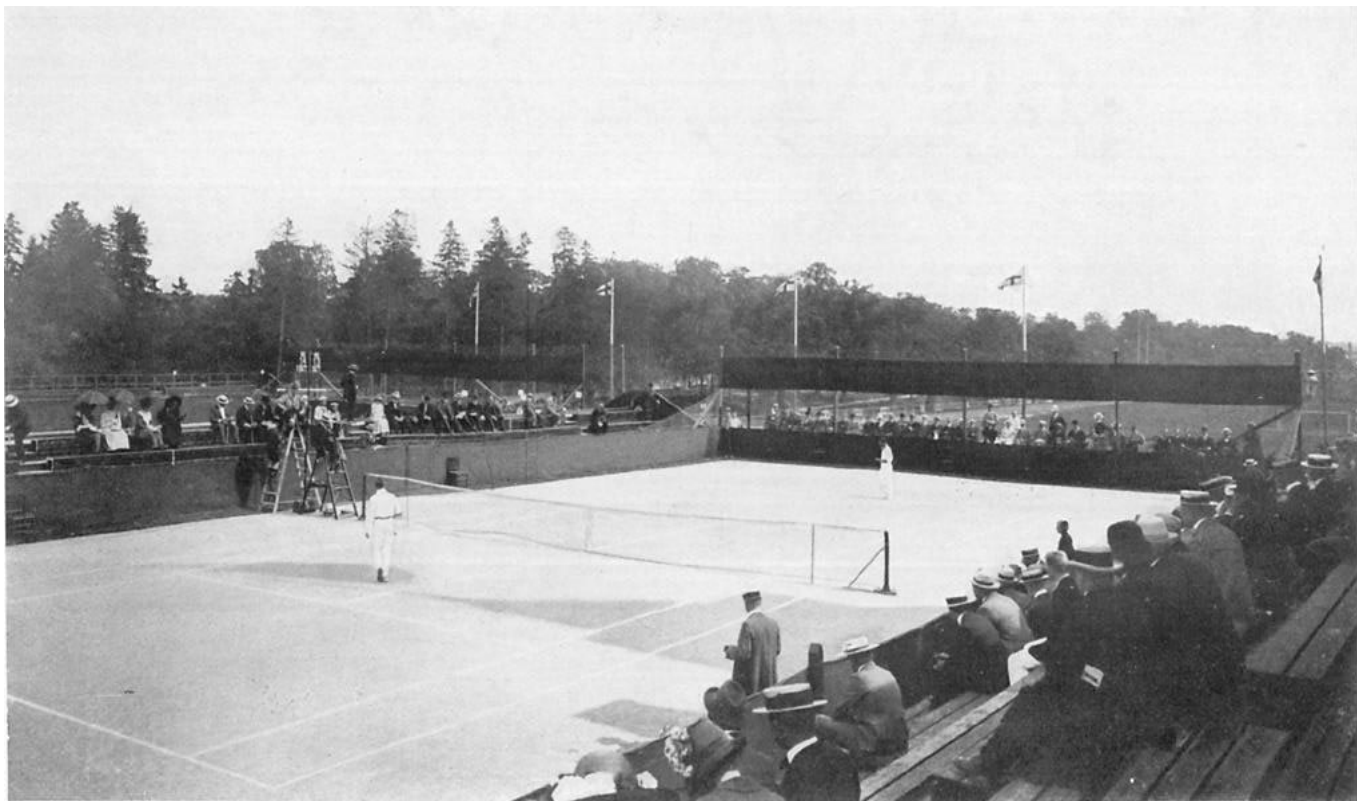

VIEW FROM LAWN TENNIS COMPETITIONS (out-of-door courts).

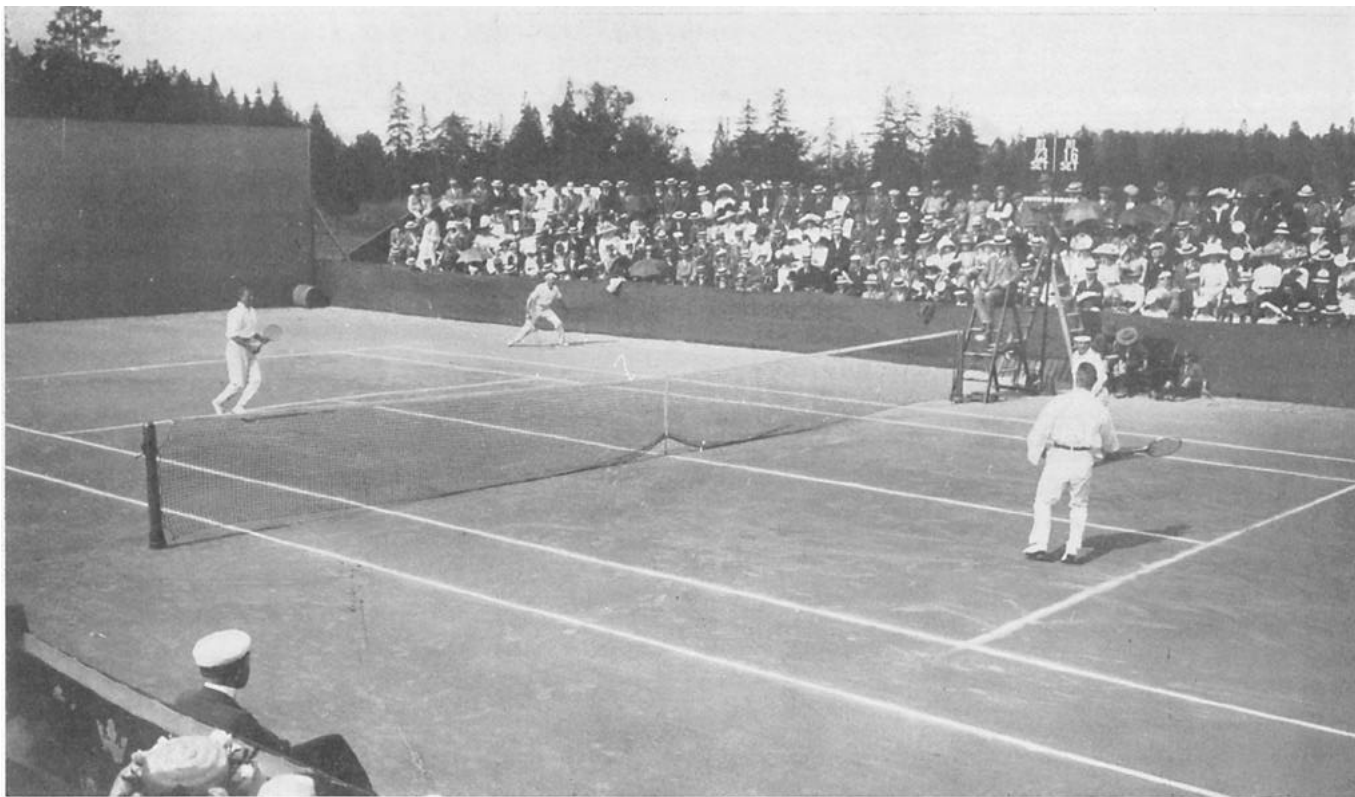

FINAL IN GENTLEMAN'S DOUBLES (out-of-door courts).
H. A. KITSON and C. WINSLOW (South Africa) v. Dr. F. PIPES and A. ZBORZIL (Austria).

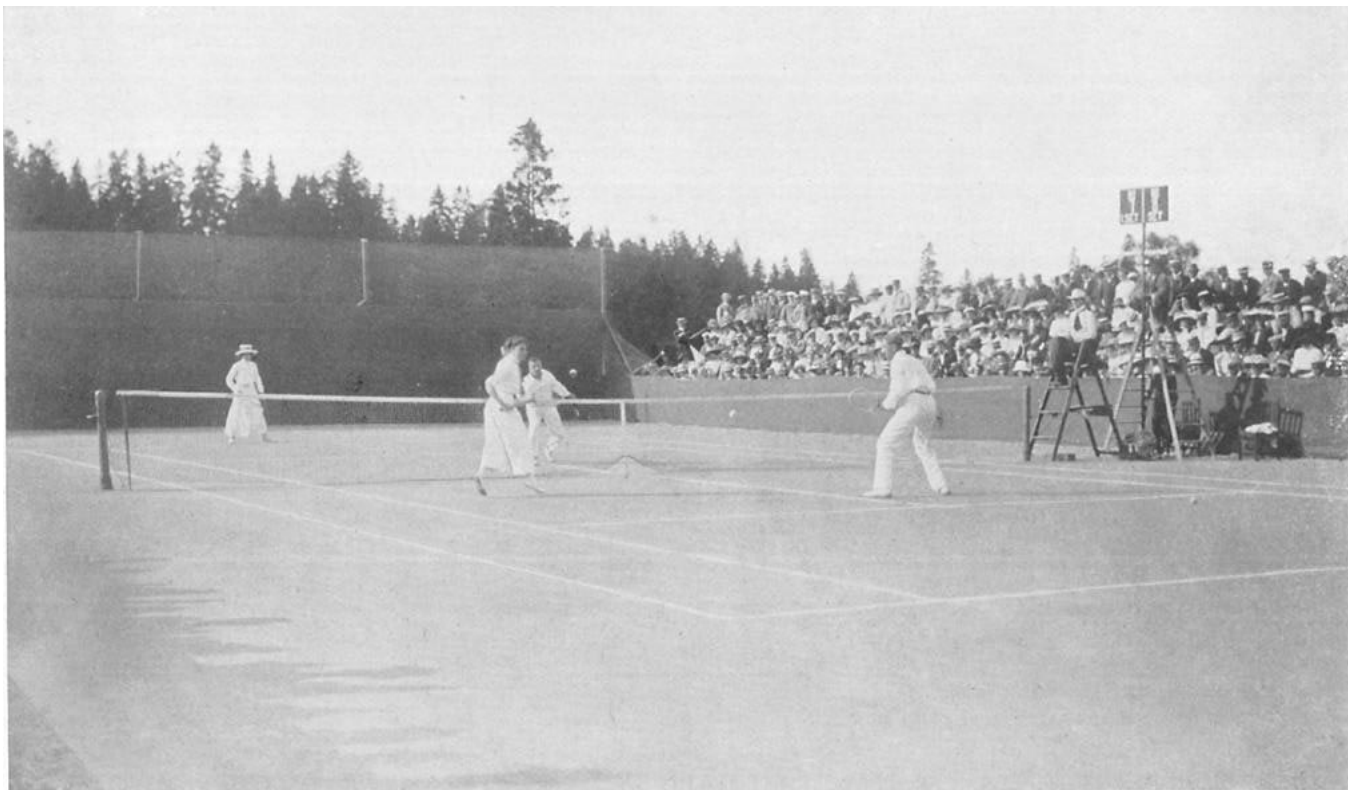

FINAL IN MIXED DOUBLES (out-of-door courts).
Fri. D. KÖRING and H. SCHOMBURGK (Germany) v. Mrs. S. FICK and G. SETTERWALL (Sweden).



H. M. THE KING PRESENTING PRIZES FOR LAWN TENNIS COMPETITIONS (out-of-door courts).

FINAL.

The Gentlemen's Singles thus finished with a meeting between two representatives of South Africa; A. H. Kitson and C. Winslow. Kitson is the safer player, while Winslow is more brilliant; they themselves think that they are very evenly matched.

The game was a beautiful exhibition of lawn tennis, both men playing with the greatest care, Kitson devoted himself to long, swift drives; Winslow, on the other hand, playing very short, and seeming to have a partiality for a forehand stroke with a tremendous back-screw which often brought the ball in close to the net. Winslow appeared to possess more endurance than his opponent, who is 15 years older than he, and it was probably this that led to the former's victory after four well-contested sets: 7—5, 4—6, 10—23, 8—6.

GENTLEMEN'S DOUBLES.

This class in the competitions lost much of its interest in consequence of two of the best pairs, O. Froitzheim — O. Kreuzer, holders of the World's Championship on "Hard courts", and the Swedish champions, G. Setterwall — C. Kempe, not putting in an appearance Froitzheim and Kempe being unable to be present.

This left the two South Africans, Kitson and Winslow really without any competitors, and they had no difficulty in carrying off the gold medal.

First round.

The only match in the first round deserving of mention was that of R. C. Spies—L. M. Heyden (Germany) against F. Möller—T. Grönfors (Sweden). All the five sets had to be played, and had not Grönfors been somewhat out of form the game would have been still closer. The Germans played well on the whole, although Spies was unlucky with his smashes. Spies-Heyden won by 3-6, 6-4, 6-2, 4-6, 6-1.

Second round.

In the second round, A. Canet—M. Mény (France) beat H. Schomburgk—O. von Müller (Germany) by 6—8, 6—3, 6—2, 6—3. The French couple played far better together than did their opponents, their volleys being very good. Schomburgk played well, but von Müller did not give him much assistance, being very unsuccessful at the net.

SEMI-FINALS.

The winners last mentioned appeared in one semi-final against Zborzil—F. Pipes (Austria) who, in the third round, had beaten W. Boström and C. Benckert (Sweden) by 6—3, 4—6, 6—1, 6—1. The semi-final between the Frenchmen and the Austrians was, undoubtedly the most exciting of all the matches in this class, the Frenchmen repeatedly being on the point of winning, but being pursued by a remarkable run of bad luck. They led by two sets to one, and were five — three and 40—love in the fourth set, when what should have been the finishing ball, struck by one of the Austrian players, ran along the net cord and at last fell softly down on the Frenchmen's side. Canet—Mény finally lost this set, but in the fifth and deciding set they again managed on two occasions to get "set ball" and each time lost, Zborzil—Pipes winning the game by 7—5, 2—6, 3—6, 10—8, 10—8. Canet seemed to be dreadfully nervous in the last set, in conse-

Gentlemen's Doubles. (Out-of-door courts.) 31 entries.

634

H. Schomburgk, Germany ...	H. Schomburgk	A. Canet	A. Canet
O. v. Müller, »	and		
L. v. Barath, Hungary	O. v. Müller	M. Mény	A. Canet
A. v. Kelemen, »	6-0 6-0 6-2	6-8 6-3 6-2	
D. Lawton, France	A. Canet	6-3	A. Canet
J. Samazeuilh, »	and	6-3	
A. Canet, »	M. Mény	W. O.	M. Mény
M. Mény, »	W. O.		6-3 6-0 6-1
Count M. Soumarokoff, Russia	M. Soumarokoff	Count M. Sou-	A. Zborzil
A. Alenitzyn, Russia	and		
F. J. Blanchy, France	A. Alenitzyn	and	F. Pipes
J. Montariol, »	W. O.	A. Alenitzyn	7-5 2-6 3-6
L. S. Roving, Denmark	L. S. Roving	2-6 6-3 7-5	10-8 10-8
V. G. Hansen, »	and	6-3	
V. Kodl, Bohemia	V. G. Hansen		
K. Ardel, »	W. O.		
O. Frotzheim, Germany	W. Boström	W. Boström	A. Zborzil
O. Kreuzer, »	and		
W. Boström, Sweden	C. Benckert	W. O.	F. Pipes
C. Benckert, »	W. O.		6-3 4-6 6-1
O. Lindpainter, Germany	O. Lindpainter		6-1
A. Hammacher, »	and		
P. Gyula, Hungary	A. Hammacher		
O. Schmid, »	W. O.		
G. Setterwall, Sweden	L. Salm	A. Zborzil	F. Pipes
C. Kempe, »	and		
Count L. Salm, Austria	H. Planner von Plaun		
H. Planner von Plaun, Austria	W. O.		
T. Smith, Norway	A. Zborzil		
H. Björklund, Norway	and		
A. Zborzil, Austria	F. Pipes		
F. Pipes, »	6-0 6-2 6-0		
			A. H. Kitson
			and
			C. Winslow
			4-6 6-1 6-2
			6-2

J. Sebek, Bohemia	A. Thayssen	}	C. Wennergren ...	}	A. H. Kitson ...
B. Hyks,	and				
A. Thayssen, Denmark	A. S. Madsen	}	6-3 6-4 6-4	}	C. Winslow
A. S. Madsen,					
C. Wennergren, Sweden	C. Wennergren	}	6-1 6-2 6-4	}	6-3 7-5 6-1
C. O. Nylén,	and				
E. Toth, Hungary	C. O. Nylén	}	W. O.	}	A. H. Kitson ...
P. Segner,					
B. von Kehrling, Hungary ...	B. von Kehrling.....	}	and	}	A. H. Kitson ...
J. Zsigmondy,	and				
J. Zeman, Bohemia	J. Zsigmondy	}	3-6 6-1 6-4 6-4	}	C. Winslow
K. Fuchs,					
A. H. Kitson, South Africa ...	A. H. Kitson	}	6-3 6-3 7-9	}	A. H. Kitson.....
C. L. Winslow,	and				
V. Ingerslev, Denmark	C. L. Winslow	}	6-4 6-1 6-4	}	C. Winslow
J. Arenholt,					
B. Angell, Norway	L. Zemla	}	and	}	4-6 6-1 7-5
N. Stibolt,	and				
L. Zemla, Bohemia	J. Just	}	6-1 6-2 6-0	}	6-4
J. Just,					
R. M. Peterson, Norway	R. M. Peterson	}	6-1 6-2 6-4	}	L. Zemla
C. Langaard,	and				
R. Bertrand, Austria	C. Langaard	}	W. O.	}	and
C. von Wessely, Austria					
R. C. Spies, Germany	R. C. Spies.....	}	and	}	J. Just...
L. M. Heyden,	and				
F. Möller, Sweden	L. M. Heyden	}	3-6 6-4 6-2 4-6 6-1	}	6-0 8-6 6-4
T. Grönfors,					
..... bye	E. P. Frigast, Denmark	}	6-2 7-5 6-3	}	L. M. Heyden ...
	O. Frederiksen,				

Game for third prize. A. Canet—M. Mény beat L. Zemla—J. Just 13-11 6-3 8-6.

quence of the bad luck attending him and his companion in the fourth, and played far below his form.

Pipes and Zborzil thus qualified for the final, where they had to meet Kitson and Winslow who, in their semi-final, had beaten L. Zemla and J. Just (Bohemia) by 4—6, 6—1, 7—5, 6—4.

Canet—Mény met Zemla—Just for the bronze medal, the French pair winning after a good game by 13—11, 6—3, 8—6.

FINAL.

The final between the Austrian representatives, F. Pipes—A. Zborzil and the two South African players, A. H. Kitson—C. Winslow could, undoubtedly, have been better, the last named players taking some time before they found themselves, and losing the first set by 4—6. After this they led easily, and won the gold medal by 4—6, 6—1, 6—2, 6—2.

LADIES' SINGLES.

The Ladies' Singles, too, lost much of their interest in consequence of the absence of Fr. Rieck and Fr. Kaminski, both German representatives.

Mlle Broquedis (France) and Fr. Köring (Germany) had been drawn in separate halves of the programme and, consequently, were pretty sure finalists.

First and second rounds.

Before reaching the final, however, Fr. Köring had to meet two Swedish representatives in succession; Mrs. S. Fick, the Swedish lady champion, who was beaten by 7—5, 6—3, and Mrs. E. Arnheim, who was defeated in the semi-final.

SEMI-FINALS.

Mlle Broquedis had a very severe struggle in one semi-final with Miss Bjurstedt (Norway), the three sets having to be played before the French representative won, the final result being 6—3, 2—6, 6—4. Miss Bjurstedt is a very good player, with long, hard drives and possessing a very safe racket.

In the other semi-final, Fr. Köring beat Mrs. Arnheim comparatively easily by 6—4, 6—3.

In the match for the bronze medal, Miss Bjurstedt beat Mrs. Arnheim by 6—2, 6—2.

FINAL.

This match between Mlle Broquedis (France) and Fr. D. Köring (Germany) was a pretty exhibition of Ladies' Tennis. The former was a little uncertain to begin with, but her litheness and pace awakened general admiration. Fr. Köring played with the greatest calm, and her long, hard drives won her the first set by 6—4 and gave her the lead in the second by 3—love. Mlle Broquedis seemed to perceive that the situation was a dangerous one and successfully curbed her too great liveliness while, at the same time, Fr. Köring appeared to tire a little. The French lady-champion took 6 games in succession and won the second set by 6—3 while, after some beautiful play on both sides in the third set, Mlle Broquedis won this, too, and gained the gold medal by 4—6, 6—3 6—4.

MIXED DOUBLES.

Preliminary rounds.

The Mixed Doubles broke the record as regards w. o. for, of 13 matches on the programme, only 5 were played, and of these latter not one produced any first-class exhibition of tennis.

Our best Swedish pair, Mrs. S. Fick and G. Setterwall, were fortunate in getting into the final, as they had not to meet either of the German couples, Fr. G. Kaminski—O. von Müller and Fr. M. Rieck and O. Kreuzer, both of whom scratched.

In the other half of the programme, the German couple, Fr. G. Köring and H. Schomburgk qualified for the final after beating M. Broquedis—A. Canet in the semi-final by 6—2, 6—3.

The French representatives, Broquedis—Canet had, in the first round, beaten the Swedish couple, Mrs. E. Arnheim—C. O. Nylén by 6—2, 6—4.

No game was played for the third prize, M. Broquedis—Canet being awarded the bronze medal from a w. o. on the part of Fr. Rieck—O. Kreuzer.

FINAL.

The final in the Mixed Doubles was fought out between Fr. D. Köring—H. Schomburgk and Mrs. Fick—G. Setterwall. Immediately after the game began, Mrs. Fick gave her partner a severe blow in the face with her racket. This little accident seemed to put Setterwall off his game, for his play fell off tremendously and Köring—Schomburgk had no difficulty in winning by 6—4, 6—0. The winning pair made an excellent combination, with Schomburgk at the net, and Fr. Köring along the base-line.

This was the last match in the Olympic Lawn Tennis competitions

Ladies' Singles. (Out-of-door courts.) 12 entries.

.....	bye	Miss A. Holmström, Sweden	E. Arnheim	D. Köring	M. Broquedis
.....	„	Mrs E. Arnheim	4—6 6—4 6—1	6—4 6—3	4—6 6—3 6—4
Mrs. S. Fick, Sweden	D. Köring	D. Köring
Fr. D. Köring, Germany	7—5 6—3	W. O.
Miss V. Bjurstedt, Norway	V. Bjurstedt	M. Broquedis
Fr. M. Rieck, Germany	W. O.	6—1 6—4
Mrs. E. Brusewitz, Sweden	M. Cederschiöld
Miss M. Cederschiöld, Sweden	8—6 8—6
Mlle M. Broquedis, France	M. Broquedis
Princess J. de Lobkowitz, Bohemia	W. O.
.....	bye	Miss M. Bjurstedt, Norway	M. Bjurstedt
.....	„	Fr. G. Kaminski, Germany	W. O.

Game for third prize. M. Bjurstedt beat E. Arnheim 6—2 6—2.

Mixed Doubles. (Out-of-door courts.) 13 entries.

.....	bye	{ Miss M. Cederschiöld, Sweden ... C. Kempe,	{ M. Broquedis	} D. Köring
Mrs. E. Amheim, Sweden.....		{ M. Broquedis	{ and	
C. O. Nylén,		{ and	{ A. Canet	
M:elle M. Broquedis, France		{ A. Canet	{ W. O.	
A. Canet,		{ 6-2 6-4		
Princess J. M. Lobkowitz, Bohemia		{ Princess J. Lobkowitz	} D. Köring	
J. Just, Bohemia		{ and		
M:me J. Kubesova, Bohemia		{ J. Just	} H. Schomburgk	
A. Kubes,		{ W. O.		
Miss W. Bjurstedt, Norway		{ D. Köring	} D. Köring	
T. Smith,		{ and		
Frl. D. Köring, Germany		{ H. Schomburgk	} H. Schomburgk	
H. Schomburgk, Germany		{ W. O.		
Mrs. S. Fick, Sweden		{ S. Fick	} D. Köring	
G. Setterwall, Sweden		{ and		} and
M:me A. Sebkova, Bohemia		{ G. Setterwall	} H. Schomburgk	
J. Sebek,		{ W. O.		} W. O.
Miss M. Bjurstedt, Norway		{ A. Holmström	} S. Fick	
C. Langaard,		{ and		} and
Miss A. Holmström, Sweden		{ T. Grönfors	} G. Setterwall	
T. Grönfors,		{ 6-4 4-6 7-5		} W. O.
.....	bye	{ Frl. G. Kaminsky, Germany.....	{ M. Rieck	
.....		{ O. v. Müller,	{ and	
.....		{ Frl. M. Rieck,	{ O. Kreuzer	
.....		{ O. Kreuzer,	{ W. O.	

Game for third prize: M. Broquedis—A. Canet W. O. M. Rieck—O. Kreuzer retired.

Presentation of the Prizes.

The Olympic Lawn Tennis out-of-door court competitions were concluded at 5 p. m., on Friday, the 5 July, by the presentation of the prizes, the ceremony being carried out by H. M. The King. Some 1,500 spectators were present, and hearty cheers greeted the winners as they went forward to receive their medals.

PRIZE-LIST

Gentlemen's Singles.

I prize:	C. Winslow.....	South Africa.
II »	A. H. Kitson.....	South Africa.
III »	O. Kreuzer	Germany.

Gentlemen's Doubles.

I prize:	A. H. Kitson and C. Winslow.....	South Africa.
II »	A. Zborzil and F. Pipes	Austria.
III »	A. Canet and M. Mény	France.

Ladies' singles.

I prize:	M:lle M. Broquedis	France.
II »	Frl. D. Köring.....	Germany.
III »	Miss M. Bjurstedt	Norway.

Mixed Doubles.

I prize:	Frl. D. Köring and H. Schomburgk.....	Germany.
II »	Mrs. S. Fick and G. Setterwall	Sweden.
III »	M:lle M. Broquedis and A. Canet.....	France.

Total points made by the different nations in the Lawn Tennis Competitions, out-of-door courts.

	Gold medals.	Silver medals.	Bronze medals.	Total points.
1. South Africa.....	2	1	—	8
2. Germany.....	1	1	1	6
3. France.....	1	—	2	5
4. Austria.....	—	1	—	2
5. Sweden	—	1	—	2
6. Norway ..	—	—	1	1

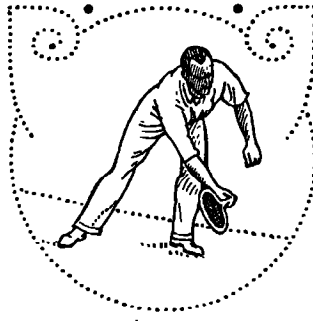

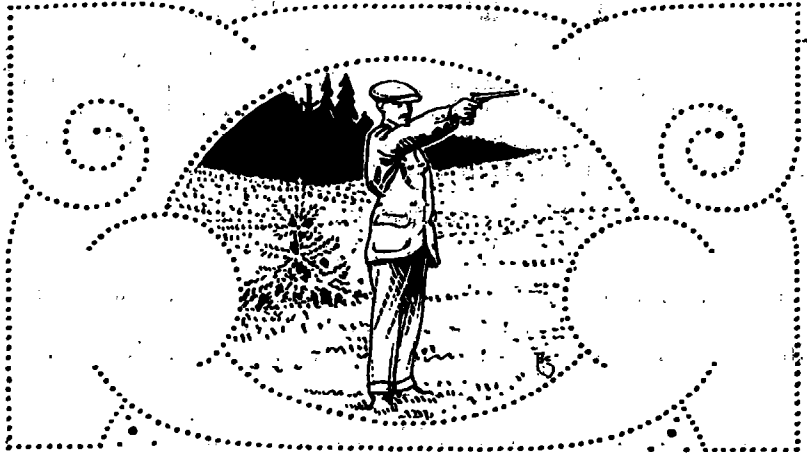

MODERN PENTATHLON.

PREPARATORY WORK OF THE COMMITTEE.

On the proposal of its President, the International Olympic Committee decided that, in the programme of the Fifth Olympiad which was to be held in Stockholm in 1912, there should be placed a new competition — the Modern Pentathlon — comprising the following events : athletics, fencing, riding, swimming and shooting.

This decision was received with the greatest interest by the Swedish Olympic Committee which took its first steps for the organization of the competition, as early as the autumn of 1910. This was no easy matter, however, for there was nothing to go by as regards the new event as there was in the case of the other competitions. In determining the five branches of sport that were to make up the Modern Pentathlon, the Swedish Olympic Committee had the following points in view: the five events ought to be such as would test the endurance, resolution, presence of mind, intrepidity, agility and strength of those taking part in the competition, while, in drawing up the detailed programme, it was necessary to have all the events of equivalent value, in order to make the Modern Pentathlon a competition of really all-round importance. As regards the shooting, which, of course, was not any test of physical strength, it was necessary to demand a corresponding degree of skill in that branch, in order to make it equivalent to each of the other four events.

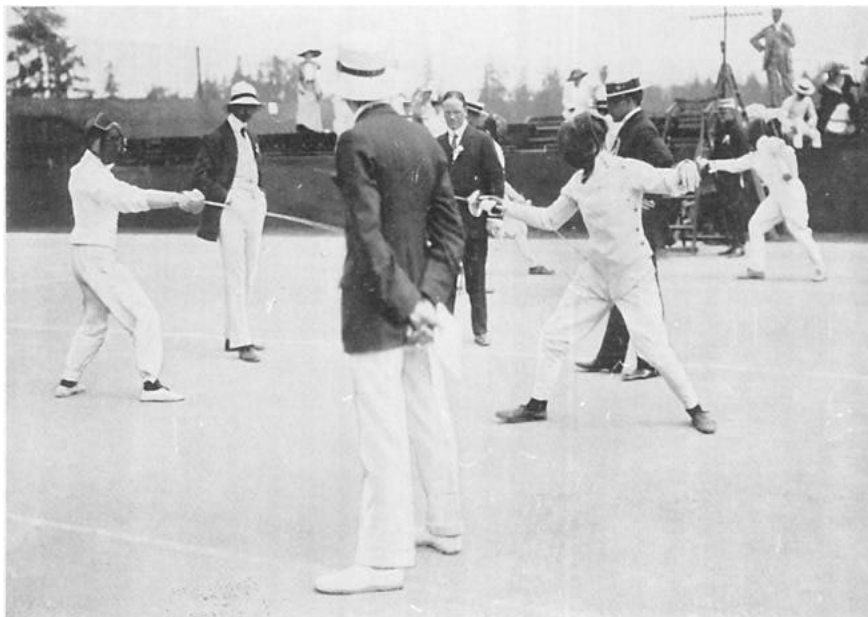

ÉPÉE FENCING, MODERN PENTATHLON.



ÉPÉE FENCING, MODERN PENTATHLON. WERSÅLL (Sweden) v. ÅSBRINK (Sweden).

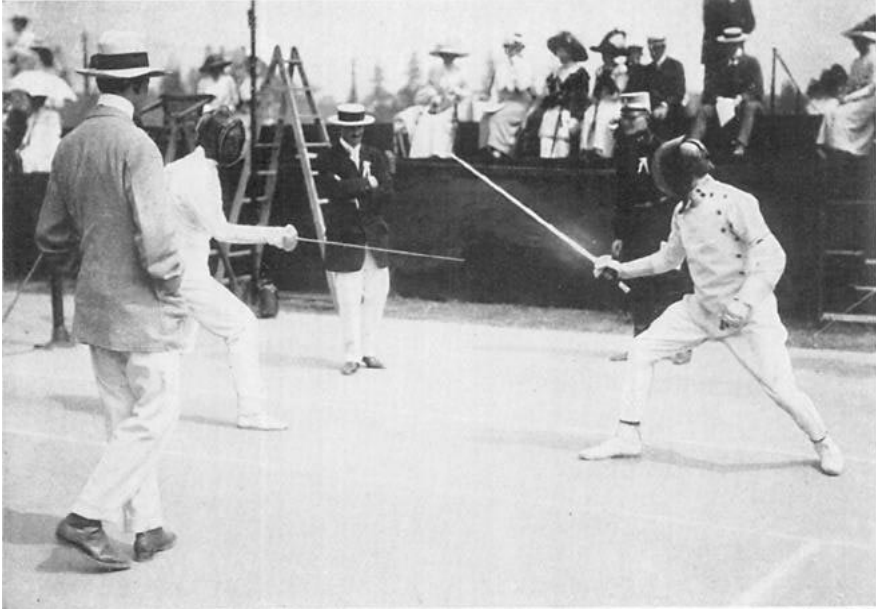

ÉPÉE FENCING, MODERN PENTATHLON.
DE MAS LATHIE (France) 2:nd Man—G. PATTON (U. S. A.), 4:th Man.

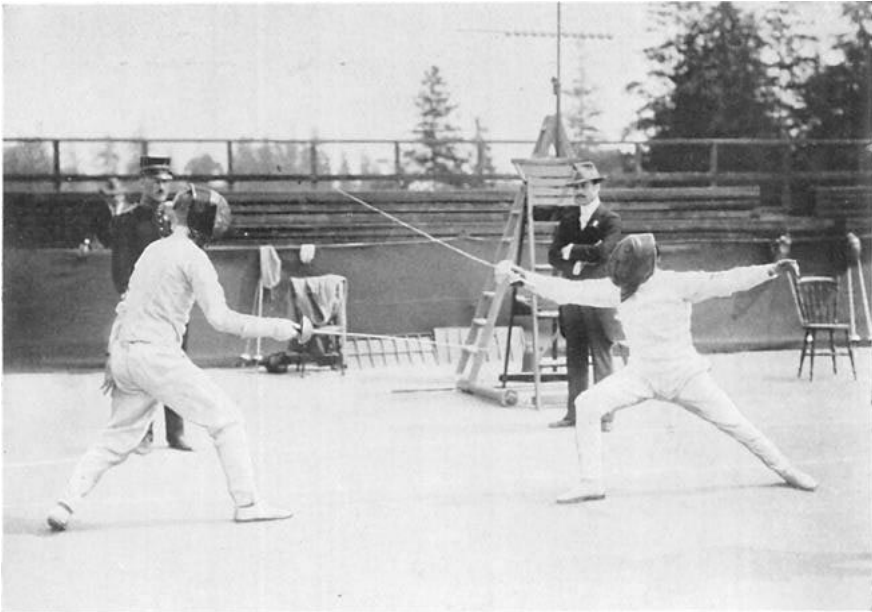

ÉPÉE FENCING, MODERN PENTATHLON.
AEJMELAENS (Russia)—MANNSTRÖM (Sweden).

But this was not enough. It was also necessary to consider the reciprocal order in which the events should be placed, this being an Olympic competition, although the real value of the Modern Pentathlon ought, of course, to consist in the fact, that a man who is really in perfect physical and psychical condition, and who is expert in the branches of sport in question, will always be able to satisfy these tests, irrespective of the order in which they come, so that, for example, he will be able to pass the shooting test perfectly well, even if he has previously been swimming, riding across very rough country, taking part in a cross-country run, or, for a longer or shorter length of time, been engaged in meeting an opponent with the épée.

Of course, the difficulty in executing the tests would be the same for all the competitors, so that, in this respect, the events could be placed in any order, but, on the other hand, there was the desire to obtain the best possible result that could be gained in each of the five events, so it was considered that the most suitable method to be adopted for the Olympic Games would be to place the events in a certain order, in accordance with the claim each made on the skill and endurance, etc., of the competitor.

In consequence of the character of the Modern Pentathlon, the question may be asked whether, eventually, the competition should not be so arranged that the competitor is left in ignorance of the order in which the five events are to be taken, and that the order is determined by drawing lots. This arrangement, however, might have the result of unsteadyng the competitors to some degree, and of making it a matter of exceeding difficulty for the Olympic Committee to organize the competition.

The following brief account of the arrangements made for each of the various branches of the Modern Pentathlon at the Fifth Olympiad, in Stockholm, is given as some aid for future Olympic Games.

Shooting.

In the autumn of 1911, the Swedish Olympic Committee proposed that the shooting should be carried out with pistols (so-called "Duel-shooting") at a distance of 20 metres, at a disappearing target consisting of a whole-figure, which was to be visible for 3 seconds. Later on, however, the thought arose that it would be better to increase this, perhaps, too short, distance by 5 metres, so as to make the event more in accordance with the value of the competition, and so the distance of 25 metres was adopted.

The target was to consist of standing whole-figure, 1.70 metres high, i. e., corresponding in length to a man of normal height; the greatest breadth was 0.50 metre. In order to determine the respective value of the hits, the figure was to be divided into 10 zones, the bull's-eye to count 10. The figure was to be visible 3 seconds, with an interval of 10 seconds between each shot, this period being fixed so as to allow ample time for reloading, for such competitors as did not use automatically loading pistols.

As regards the weapon, it was not considered suitable to require the use of any fixed model, otherwise than that it had to be one intended to be held in one hand only, and any revolver or pistol could be used provided that it had open fore- and back-sight.

Regarding the number of shots, these were fixed at 20, which were to be fired in 4 series of 5 shots each. With respect to the trial of the weapon it was determined that, before the shooting for the event began, 2 sighters should be allowed at the ranges, under similar conditions to those obtaining during the competition.

Swimming.

The first thing that had to be done in regard to this event was to determine the distance that would give a suitable test of strength and endurance. In general, it was considered that a length of 300 metres would be enough, and the proposal was adopted, the distance mentioned being, probably, the most suitable one.

The free swimming style must also be considered as the only one that could be adopted. The event was arranged in heats without any final, the time taken being the only decisive factor.

Fencing.

A discussion arose as to whether free choice of weapons (*épée*, *sabre* or *bayonet*) should be allowed, or if the obligatory employment of one of these arms should be enforced, the *bayonet* being, most certainly, the weapon which would be least used. Both plans have their advantages and inconveniences, of course, but it will certainly be acknowledged that to allow a free choice of weapon would lead to many grave difficulties — when judging results in an Olympic competition, at least.

Judging from every plausible reason, the choice of one, fixed arm would be the right method, as the judging, in the case of such a competition as this, must be based on a comparison between two opponents of supposed equal capacity. It was a matter of exceeding difficulty, on the other hand, to decide whether the *épée* or *sabre* should be used, though it must be acknowledged that, in such an event as this, there is much that speaks for the adoption of the former weapon — even if, in many instances, a sympathy for the *sabre* was very noticeable — and it was found that the proposal of the Swedish Committee in favour of the first-named arm was the fittest.

It was determined that the fencing should be determined by three hits of five, and that the encounters should, preferably, take place in the open air, on some fairly level ground, rather than indoors on a wood floor, or on a platform covered with a linoleum carpet.

The construction of the weapon was to be similar to that fixed by the rules for fencing with the *épée* (see “Fencing Competitions”)-

Riding.

The determination of the rules for the riding was, probably, the question involving the greatest difficulties. From the very first, however, it was determined that the event should be an individual competition from point to point, over a fixed cross-country course with obstacles, as the rider, as well as the horse, would thereby be best tested. The distance, it was considered, should lie within the limits 3,000—5,000 metres. In such a competition from point to point, with a number of obstacles at varying distances, too short a distance, however, would not be enough to fully test the skill of the rider, as, in such a case, it would not be necessary for him to pay attention in so high a degree to the endurance and power of his horse and, consequently, to husband these resources to the utmost.

Another great reason for the non-adoption of the shorter distance was that arising from the unanimous opinion, that a maximum time ought to be fixed which was not to be exceeded. In other respects, no attention was to be paid to the time taken for the competition, but the event should be decided by the points given for form in the execution of the ride, the way in which the obstacles were taken, etc. In the event, however, of two or more competitors having the same number of points, the result was to be decided by the time taken. In order not to be bound to a distance determined to the very metre — as there would then exist greater freedom to pay regard to the character of the country when choosing the course — it was decided that the distance should not exceed 5,000 metres, a solution of the question which must be considered as the most successful one.

In order to give the riding event a fully field-service character, the leaders of the riding competition were empowered to so arrange the course, which was not to exceed 5,000 metres (for which a maximum time of 15 minutes was fixed), that the height, breadth, character and number of the obstacles would correspond to the demands such service would make. According to this plan, the course would remain unknown to the competitors, who would not gain any knowledge of it from the programme and rules they received, while they were not allowed to ride over the ground before the actual performance of the event on the day of the competition, although the course, as regards its chief features, was to be shown to the riders a day or two before the competition, none of the obstacles being then pointed out, however.

The most difficult point in this event was as regards the procural of the horses. Here there were 3 points of view, viz.: 1:o, that each competitor should have his own horse; 2:o. that the Swedish Olympic Committee should have saddled horses at the service of the competitors at the starting point of the race, each competitor drawing lots for the horse he was to ride, or, as a compromise, 3:o. that, if the competitor so wished, he could ride his own horse, but that the Committee would provide horse for those riders who could not

bring their own. There were advantages and disadvantages attached to each of the three alternatives.

With the first alternative, it would be a matter of the very greatest difficulty to hold the competition for, by the adoption of such a regulation, it would become impossible for all the competitors to take part in the event; on the other hand, the rule would give the greatest advantage to the competitors themselves, although, in such a case, the fundamental idea of the Modern Pentathlon — that an athlete should be able, at any time, to ride across unknown country on a strange horse — would be, in a great measure, lost.

The second alternative reverses the position of the above advantages and disadvantages. In this case, the idea of the Modern Pentathlon is given its right value, but the advantages to be gained by the individual competitor are considerably diminished, in addition to which, there is the disadvantage that it would be a difficult matter to distribute the horses among the competitors quite justly, even if done by means of drawing lots, for it would, of course, be exceedingly difficult to provide a certain number of horses all as good as each other even if, during a certain period they had gone through a thorough course of training in steeple-chase-riding. By such an arrangement there would be a diminution in the value of the horse riding event in the competition.

But to eliminate the riding from the Pentathlon on account of the weaknesses attending these alternatives, and to replace it by another branch of athletics, would considerably detract from the special character of the competition. The question was discussed at the Luxemburg Congress, and it was not before the adoption, as a matter of principle, of the view that horses should be placed at the disposal of the competitors on the course, that the riding event was included in the programme. The question was once more debated at the Congress of Buda-Pesth and a compromise was adopted — the third alternative mentioned above — whereby competitors had the right of providing their own horses, but that those who were unable to do so, should have a mount placed at their disposal on the course by the Swedish Olympic Committee. The said Committee afterwards determined that these competitors should draw lots for their horses on the occasion when the course was shown them, as in this way horses and riders would not be altogether strangers to each other.

Athletics.

Finally, it was necessary to choose a branch of athletics, from amongst its many forms, which would best be in agreement with the special character of the Modern Pentathlon. The choice fell on cross-country running, and the distance was fixed at 4,000 metres.

In order to thoroughly carry out the idea of the Pentathlon as an individual competition, it was determined that the competitors should start one at a time, at intervals of 1 minute, instead of allowing them to start together, as in the case of an ordinary cross-country run.

The event was to be decided by time alone.



CROSS-COUNTRY RACE, MODERN PENTATHLON. GRÖNHAGEN, Sweden.

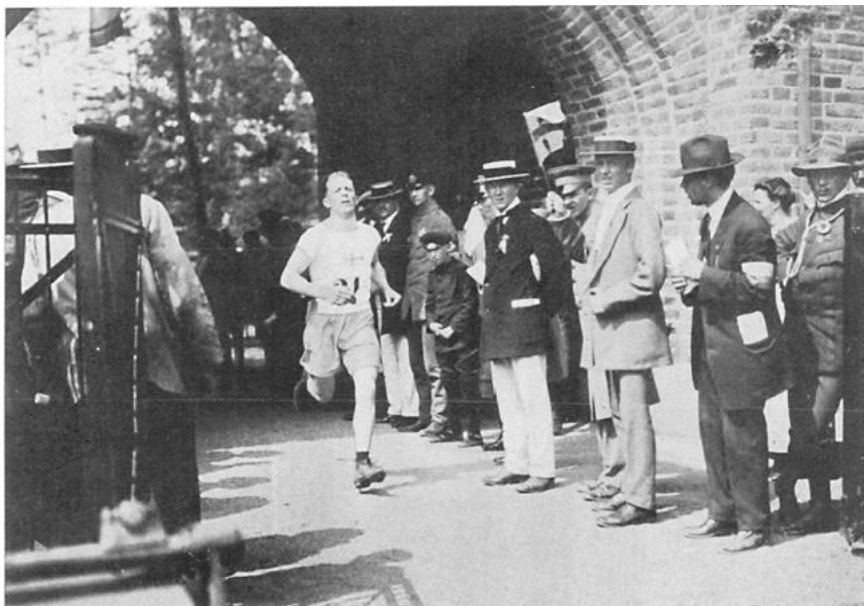

CROSS-COUNTRY RACE, MODERN PENTATHLON. ÅSBRINK, Sweden, 1:st Man.



CROSS-COUNTRY RACE, MODERN PENTATHLON. GRÖNHAGEN, Sweden.



CROSS-COUNTRY RACE, MODERN PENTATHLON. G. DE LAVAL, Sweden.



SINGING THE SWEDISH NATIONAL ANTHEMN IN THE STADIUM, WHEN THE THREE SWEDISH PRIZE-FLAGS WERE HOISTED FOR THE MODERN PENTATHLON

JUDGING THE COMPETITION.

As the fundamental principle for judging the competition as a whole it was determined to adopt a method of calculating points based on the place-numbers in the various sub-events, with the greatest number of victories (or the best relative places) as the decisive factor in the event of two or more competitors obtaining an equal number of points. In the case of two or more competitors obtaining an equal number of points and an equal number of best relative places, the result would thus be decided by the competition held *last*.

In order to obtain a prize, the competitors had to take part in, and complete, all the five tests.

It was determined, with respect to the calculation of points, that the 1:st man in each event should receive 1 point, the 2:nd man 2 points, and so on, and that the competitor with the lowest number of points should be declared the winner.

If any competitor omitted to take part in any of the 5 events, he was to be considered as having withdrawn from the competition as a whole, but the calculation of points for the other competitors would not be altered.

If two or more competitors obtained similar results in running, swimming and riding, the events were not to be taken over again. If, thus, two competitors tied for first place, each of these would be awarded 1 point, and the next man 3 points, etc.

Equal points in fencing, on the other hand, would have to be decided by another pool (1 hit), while in the shooting, the contest was to continue (the entire series to be fired) until one man proved himself the best.

The rules for the competitions for the 5 sections were:

Shooting: the number of hits were to be counted; in the event of an equal number of hits, the points were to be calculated according to the zones. The edge of the shot-hole was to determine the value of the shot;

Swimming: The time alone was to decide the placing;

Fencing: The number of hits (3) was to decide;

Riding: Each rider was to receive 100 points to start with, from which were to be deducted:

for refusing and bolting the first time.....	2 points,
" refusing or bolting again, each time.....	5 »
" the horse falling.....	5 »
" falling off (the rider being unseated), either at the obstacles or between them	10 »
" every period of 5 seconds or fraction -thereof, in excess of the maximum time.....	2 »

These deductions of points were to be made on each occasion, and for each obstacle.

If two or more competitors had the same number of points, the time taken was to decide the order in which they were to be placed. In the *cross country running*, time alone was to be decisive of the event.

THE COMMITTEE FOR THE MODERN PENTATHLON.

The Committee for the Modern Pentathlon, the President of which was Colonel V. G. Balck, Kristian Hellström, Esq., General Secretary of the Olympic Games, being the secretary, elected a select committee for arranging and directing the organization of this competition for the Olympic Games. This special committee consisted of Colonel, Count C. E. Taube, Captain C. Silfverstolpe and Lieutenant F. S. Granfelt, the two latter, as president and secretary, respectively, of the administrative committee of the Stockholm District of the Military Athletic Association, having the charge and direction of the training of the Swedish competitors in the Modern Pentathlon.

The other members of the committee were:

For athletics	Lieutenant G. G:son Uggla.
» »	S. Smedmark, Esq.
» fencing	Captain E. Fick
» »	Lieutenant B. Cnattingius
» riding.....	Lieutenant, Count C. G. Lewenhaupt
» »	Lieutenant C. König
» swimming.....	E. Bergvall, Esq., Editor
» »	G. Wretman, Esq.
» shooting	Colonel, Count C. E. Taube
» »	Lieutenant E. Carlberg.

THE COMPETITION.

As was case with the other competitions during the Olympic Games, the Modern Pentathlon was begun and continued under the most favourable conditions of the weather, although the great heat was somewhat oppressive and probably affected the results of the several events.

In consequence of the special character of this competition, it was watched with very great interest both at home and abroad. As will be seen by the list of entries, the Modern Pentathlon, in contrast with athletics in general was an almost exclusively military event.

The various sections of the competition were placed on the programme in the following order:

7 July:	duel-shooting
8 »	swimming 300 metres
9 »	fencing with épée
10 »	continuation of d:o
11 »	cross-country riding, and
12 »	cross-country running.

Duel-shooting.

The shooting took place at a 10-zoned whole figure which was visible to the competitor for the space of 3 seconds, with intervals of 10 seconds, after which the target again appeared; during the interval the competitor had, if necessary, to reload his weapon.

After each series of 5 shots, the hits were counted and the holes afterwards covered over. A majority of the competitors, hit the target nearly every time, and with relatively good results.

The Swedish marksmen used the American Smith and Wesson target-practice pistol exclusively, while the Norwegians and the German representatives used various calibres of the German Parabellum automatic pistol.

Patton, the only representative from the western continent, shot with a Colt. All the Danes used the Danish Army pistol. These weapons, like the other pistols used in the competition, were of calibres varying between 6.5 and 9 millimetres.

The report of the judges was as follows.

Name	Nation	Series	Points per shot					No. of misses	Total	Grand total
			1	2	3	4	5			
Ussing	Denmark	1	—	—	—	—	—	*****	—	points
		2	9	8	—	—	—	***	17	
		3	10	7	7	—	—	**	24	
		4	9	7	—	—	—	***	16	
Patton	U. S. A.	1	10	9	9	9	8		45	150 points
		2	10	10	10	—	—	**	30	
		3	9	9	9	7	—	*	34	
		4	9	9	8	8	7		41	
Lewenhaupt.....	Sweden	1	10	9	9	—	—	**	28	148 points
		2	10	9	8	8	—	*	35	
		3	10	9	9	9	8		45	
		4	10	10	10	10	—	*	40	
Almkvist	Russia	1	8	8	7	—	—	**	23	143 points
		2	9	9	9	7	7		41	
		3	10	9	9	8	—	*	36	
		4	9	9	9	8	8		43	
Mannström	Sweden	1	10	9	9	8	8		44	171 points
		2	10	10	10	10	9		49	
		3	10	8	8	8	7		41	
		4	10	9	9	9	—	*	37	
Clilverd	Great Britain	1	10	10	9	9	8		46	172 points
		2	9	9	8	8	7		41	
		3	10	9	9	8	8		44	
		4	10	8	8	8	7		41	
Wersäll	Sweden	1	10	10	10	10	9		49	182 points
		2	10	9	9	9	8		45	
		3	10	9	9	8	7		43	
		4	10	10	9	9	7		45	

Name	Nation	Series	Points per shot					No. of misses	Total	Grand total
			1	2	3	4	5			
Åsbrink	Sweden	1	10	10	9	9	9		47	193 points
		2	10	10	10	10	9		49	
		3	10	10	10	9	9		48	
		4	10	10	10	10	9		49	
Doorman.....	Holland	1	9	9	9	7	—	*	34	149 points
		2	10	9	9	8	—	*	36	
		3	9	9	9	9	7		43	
		4	10	10	9	7	—	*	36	
Paaske.....	Norway	1	9	9	7	6	—	*	31	147 points
		2	9	9	9	8	8		43	
		3	10	8	8	7	—	*	33	
		4	9	8	8	8	7		40	
Nepokoupnoi ...	Russia.....	1	10	10	9	9	9		47	185 points
		2	9	9	9	9	9		45	
		3	10	10	9	9	9		47	
		4	10	9	9	9	9		46	
E. de Laval.....	Sweden	1	10	10	9	9	9		47	185 points
		2	10	10	9	9	9		47	
		3	10	9	9	9	8		45	
		4	10	10	10	9	7		46	
Norway	Norway	1	8	8	7	7	—	*	30	110 points
		2	10	10	9	9	—	*	38	
		3	9	7	7	—	—	**	23	
		4	10	9	—	—	—	***	19	
Zeilau	Denmark.....	1	9	8	8	8	6		39	93 points
		2	10	7	4	—	—	**	21	
		3	8	8	—	—	—	***	16	
		4	7	6	4	—	—	**	17	
P. de Laval.....	Sweden	1	10	10	9	9	9		47	188 points
		2	10	10	9	9	8		46	
		3	10	10	10	9	9		48	
		4	10	10	10	9	8		47	
Durant	Great Britain	1	10	10	9	9	8		46	191 points
		2	10	10	10	9	9		48	
		3	10	10	10	10	9		49	
		4	10	10	10	9	9		48	
Jólver	Denmark.....	1	9	8	—	—	—	***	17	52 points
		2	—	—	—	—	—	*****	—	
		3	8	7	5	—	—	**	20	
		4	8	7	—	—	—	***	15	
Aejmelaens.....	Russia.....	1	10	10	9	9	9		47	151 points
		2	9	8	8	8	8	*	33	
		3	10	10	9	8	8		45	
		4	9	9	8	—	—	**	26	
G. de Laval.....	Sweden	1	10	10	10	10	10		50	192 points
		2	10	10	9	9	9		47	
		3	10	10	9	9	9		47	
		4	10	10	10	9	9		48	

Name	Nation	Series	Points per shot					No. of misses	Total	Grand total
			1	2	3	4	5			
v. Hohenthal.....	Russia.....	1	10	10	9	9	8		46	159 points
		2	10	10	9	9	9	*	47	
		3	9	9	7	7	—	*	32	
		4	10	9	9	6	—	*	34	
Godfree	Great Britain	1	10	10	10	10	9		49	166 points
		2	10	9	9	8	—	*	36	
		3	10	9	9	9	8	*	45	
		4	10	10	8	8	—	*	36	
de Mas Latrie ..	France	1	10	9	9	8	7		43	161 points
		2	10	9	8	7	7	*	41	
		3	9	8	8	7	—	*	32	
		4	10	10	9	8	8	*	45	
Grönhagen.....	Sweden	1	10	10	9	8	8		45	158 points
		2	9	9	8	8	—	*	34	
		3	9	8	8	8	—	*	33	
		4	10	10	10	8	8	*	46	
Carlberg.....	Sweden	1	10	9	9	8	8		44	185 points
		2	10	10	10	9	8		47	
		3	10	10	10	9	9		48	
		4	10	10	9	9	8		46	
Lilliehöök	Sweden	1	10	10	10	10	8		48	192 points
		2	10	10	9	9	9		47	
		3	10	10	10	10	9		49	
		4	10	10	10	10	8		48	
Bernhardt	Austria	1	10	9	8	7	5		39	135 points
		2	10	10	10	8	7		45	
		3	10	9	8	—	—	**	27	
		4	9	8	7	—	—	**	24	
Brule	France	1	8	8	—	—	—	***	16	100 points
		2	10	9	8	—	—	**	27	
		3	8	8	7	—	—	**	23	
		4	9	9	9	7	—	*	34	
Pauen	Germany.....	1	10	10	10	9	—		39	102 points
		2	10	5	—	—	—	***	15	
		3	8	7	7	—	—	**	22	
		4	10	8	8	—	—	**	26	
Stranne	Sweden	1	9	9	9	8	7		42	176 points
		2	10	10	9	9	8		46	
		3	9	9	8	8	8		42	
		4	10	10	10	8	8		46	
Haeggström	Sweden	1	10	10	9	9	8		46	180 points
		2	10	10	10	10	—	*	40	
		3	10	10	10	9	8		47	
		4	10	10	10	9	8		47	
Wilkman	Russia.....	1	9	9	9	8	8		43	176 points
		2	10	10	9	9	7		45	
		3	10	9	9	9	8		45	
		4	10	9	9	8	7		43	

Name	Nation	Series	Points per shot					No. of misses	Total	Grand total
			1	2	3	4	5			
Laybourn	Denmark	1	9	8	8	—	—	**	25	140 points
		2	9	9	9	9	—	*	36	
		3	9	9	9	9	8		44	
		4	10	9	8	8	—	*	35	

All the competitors having thus fired, the ties were shot off, the final result being as follows, as entered in the report of the judges:

Name	Nation	Series	Points per shot					No. of misses	Total	Grand total
			1	2	3	4	5			
Nepokouptnoi) ... (185 points)	Russia	1	10	10	9	9	8		46	191 points:
		2	10	10	10	9	9		48	
		3	10	10	9	9	9		47	
		4	10	10	10	10	10		50	
E. de Laval..... (185 points)	Sweden	1	10	10	10	10	9		49	189 points'
		2	10	10	10	10	9		49	
		3	10	10	9	9	8		46	
		4	10	9	9	9	8		45	
Stranne	Sweden	1	9	9	8	7	—	*	33	150 points
		2	10	9	9	9	8		45	
		3	10	9	9	9	8		45	
		4	10	9	8	—	—	**	27	
Wilkman..... (176 points)	Russia	1	10	10	9	8	—	*	37	165 points
		2	10	9	9	9	—	*	37	
		3	9	9	9	9	8		44	
		4	10	10	9	9	9		47	
E. Carlberg..... (185 points)	Sweden	1	10	10	9	9	8		46	185 points
		2	10	9	9	9	9		46	
		3	10	10	9	9	9		47	
		4	10	9	9	9	9		46	
Lilliehöök ... (192 points)	Sweden	1	10	10	9	8	8		45	183 points
		2	10	10	10	9	9		48	
		3	10	10	9	8	8		45	
		4	10	10	9	9	7		45	
G. de Laval..... (192 points)	Sweden	1	10	10	9	9	8		46	188 points
		2	10	10	10	10	8		48	
		3	10	10	10	9	8		47	
		4	10	10	9	9	9		47	

The relative positions of the competitors is shown by the table on page 656, with Åsbrink, G. de Laval and Lilliehöök, all Swedish representatives, occupying the 1st, and and 3rd places.

Swimming.

This competition took place in a swimming stadium, specially made for the Olympic Games, which was 100 metres in length, three lengths thus having to be swum.

The starts took place in heats, which were chosen by lots. As any style of swimming was allowed, most employed the trud-geon stroke, although some used the breast stroke.

The result was as follows:

Heat	Name	Nation	Time
I	Aejmelaens	Russia	8.59 ⁴ / ₅
	Paaske	Norway	6.49 ¹ / ₅
	Stranne	Sweden	6.00 ⁴ / ₅
	Zeilau	Denmark	7.59 ² / ₅
	Lilliehöök	Sweden	6.05 ⁴ / ₅
II	von Hohenthal	Russia	7.38 ⁴ / ₅
	Åsbrink	Sweden	5.46
III	Norrby	Norway	7.48 ³ / ₅
	de Mas Latrie	France	10.03
	Durant	Great Britain	10.07
	G. de Laval	Sweden	5.28
IV	Wersäll	Sweden	5.56 ¹ / ₅
	Almkvist	Russia	6.06
	Clilverd	Great Britain	4.58 ² / ₅
	E. de Laval	Sweden	6.20
V	Mannström	Sweden	6.28 ⁴ / ₅
	Patton	U. S. A.	5.55 ² / ₅
	Grönhagen	Sweden	5.49 ³ / ₅
	Laybourn	Denmark	12.09 ³ / ₅
	Wilkman	Russia	8.11 ³ / ₅
VI	Lewenhaupt	Sweden	6.10 ² / ₅
	Nepokoupnoi	Russia	8.16 ³ / ₅
	P. de Laval	Sweden	6.54 ² / ₅
	Brulé	France	7.04 ² / ₅
	Bernhardt	Austria	5.03 ³ / ₅
VII	Ussing	Denmark	7.40 ³ / ₅
	Godfree	Great Britain	5.54
	Hægström	Sweden	6.35 ⁴ / ₅
	Jölver	Denmark	9.32 ³ / ₅

The placing is shown by the above table, with Clilverd (Great Britain), Bernhardt (Austria) and G. de Laval (Sweden) as 1st, 2nd and 3rd men, respectively.

Doorman (Holland) and Pauen (Germany) had retired from the competition after the shooting.

Fencing.

The fencing event was one of pretty long duration, as it went on for nearly the whole of two successive days. This was occasioned by the fact that there were no less than 351 assaults, in which 27 competitors took part.

Among these fencers, Grönhagen, Sweden, and Patton, U. S. A., distinguished themselves by the calm skill and rapidity they showed in the use of their weapon, as well as for the immediate advantage they took of the weak points of their opponents. Another Swede,

Table showing the result of the Fencing in the Modern Pentathlon.

Name	Nation	Comp.- n:r	3	4	6	9	10	13	14	15	16	17	18	19	20	21	24	25	27	29	30	32	33	34	36	37	38	41	42	N:r of Wins	N:r of Touches	Place figure.
Jølver	Denmark	3	○	○	○	○	×	×	○	×	×	×	×	○	×	×	×	×	×	×	×	○	○	×	×	×	×	×	×	7	13	22
Brulé	France	4	×	○	○	○	○	×	○	×	×	○	○	○	○	○	○	×	○	○	×	○	×	○	○	○	○	○	×	16	13	8
Grönhagen	Sweden	6	×	○	○	○	○	○	○	○	○	×	○	○	○	○	○	○	○	○	○	○	○	○	○	○	○	○	○	24	—	1
Almquist	Russia	9	×	×	×	○	×	×	○	×	×	×	×	×	×	×	×	×	×	○	×	×	×	×	○	×	×	×	3	—	27	
Hægström	Sweden	10	○	×	×	○	○	×	○	×	×	×	×	○	×	○	×	×	○	○	○	×	○	○	×	○	×	×	11	4	18	
Bernhardt	Austria	13	○	○	×	○	○	○	○	×	×	○	×	○	○	○	○	×	○	○	×	○	○	×	×	○	×	○	17	18	6	
Laybourn	Denmark	14	×	×	×	×	×	×	○	×	×	×	×	×	×	○	×	×	○	○	×	×	×	○	○	×	×	×	6	10	24	
Mas Latrie	France	15	○	○	○	○	○	○	○	○	×	○	○	○	○	○	○	○	○	○	×	○	○	○	×	○	○	○	23	25	2	
Patton	U. S. A.	16	○	○	×	○	○	○	○	○	○	×	○	○	○	○	○	○	○	×	×	○	○	○	×	○	×	○	20	26	4	
P. de Laval	Sweden	17	×	○	×	○	○	×	○	×	○	○	○	×	×	○	×	×	×	×	○	○	×	○	×	○	○	×	13	10	13	
Paaske	Norway	18	×	○	×	×	○	○	○	×	×	○	○	○	×	○	×	○	○	×	○	○	×	×	○	○	×	×	13	15	14	
Wilkmar	Russia	19	×	×	×	○	×	×	○	×	×	×	×	○	×	○	×	×	○	×	○	×	×	×	○	×	×	×	7	7	20	
G. de Laval	Sweden	20	○	×	×	○	○	×	○	×	×	○	○	○	○	○	×	×	○	○	×	○	○	×	×	○	○	○	15	12	10	
Ussing	Denmark	21	○	×	×	○	×	×	×	×	×	×	×	×	×	○	×	×	×	×	○	○	×	×	×	×	○	○	6	8	23	
E. de Laval	Sweden	24	○	×	×	○	○	×	○	×	×	○	○	○	○	○	○	×	○	○	○	○	○	×	×	○	×	×	15	16	11	
Ciliverd	Great Britain	25	○	○	×	○	○	○	○	×	×	○	×	○	○	○	×	○	○	○	×	×	×	○	×	○	×	○	16	16	9	
Lewenhaupt	Sweden	27	○	×	×	○	○	×	×	×	×	○	×	×	×	○	×	×	○	×	○	○	×	×	×	×	×	×	8	—	19	
v. Hohenthal	Russia	29	○	×	×	×	×	×	×	×	×	○	○	×	×	○	×	×	×	×	×	×	×	×	×	×	×	×	5	7	25	
Lilliehöök	Sweden	30	○	○	×	○	×	○	○	○	○	×	×	○	○	×	×	×	○	○	○	○	×	×	○	○	○	○	17	12	5	
Zeilau	Denmark	32	×	×	×	○	×	×	○	×	×	×	×	×	×	×	×	○	×	○	×	○	×	×	×	×	×	×	4	7	26	
Mannström	Sweden	33	×	○	○	×	○	×	○	×	×	○	○	○	×	○	×	○	×	○	○	○	○	×	×	○	×	×	12	10	16	
Norby	Norway	34	○	×	×	○	×	×	×	×	×	×	○	○	×	○	×	○	○	○	○	○	○	○	○	○	○	○	14	17	12	
Stranne	Sweden	36	○	○	×	○	×	○	×	×	○	○	○	○	○	○	○	×	○	○	○	○	○	○	○	○	○	○	21	21	3	
Godfree	Great Britain	37	○	×	×	×	○	○	○	×	×	×	×	×	○	×	○	○	○	○	×	○	×	×	○	○	○	○	12	15	17	
Wersäll	Sweden	38	○	×	×	○	×	×	×	×	×	×	×	○	×	○	×	×	○	○	×	×	×	×	×	○	×	○	7	11	21	
Durant	Great Britain	41	×	×	○	○	○	×	○	×	○	×	○	○	×	○	○	○	○	○	×	○	○	○	×	○	○	○	17	19	7	
Åsbrink	Sweden	42	×	○	○	○	○	×	×	×	×	○	○	○	×	×	○	×	○	○	×	○	○	×	×	×	×	○	12	8	15	

Rem. ○ = win (the dots show number of hits received).
 × = lost.

Lieutenant Stranne, and, in a still higher degree, a French representative, Comte de Mas Latrie, were more aggressive and lively in their work, yet without being wanting in watchfulness and in attention to the carriage of their weapon. After the first assaults, these 4 competitors became the favourites, a choice which was confirmed by the result of the competition, when Lieutenant Grönhagen (Sweden) was placed first with 24 victories, the Comte de Mas Latrie, second with 23, Lieutenant Stranne (Sweden) third with 21, and Captain Patton (U. S. A.), fourth with 20. Lieutenants Lilliehöök and Lewenhaupt also made a good show against their opponents, and displayed great skill, the same being the case with the second French representative, Lieutenant C. Brulé.

The result can be seen from the protocol on pages 652—653.

Riding.

The start for the cross-country ride, the length of which was 5,000 metres, was in the neighbourhood of Barkarby (north of Stockholm), from which point the course lay over country of varying character, south of the main road to Stockholm, past Hjulsta and Spånga Church, east of which a bridge had to be crossed close to the winning post.

The obstacles (17 in number) were of varying character: Swedish and other fences, and ditches of different kinds. A very interesting obstacle was that consisting of two fences in close vicinity to each other, on the way down a pretty steep hill, after passing through a thinly timbered wood.

In general, most of the competitors rode the course excellently, and as 13 of the 27 competitors covered the course without any fault, and without any touch on clearing the obstacles, the time taken had to decide the placing of these 13 riders.

In this event, the first four places fell to Swedes, viz., Lieutenants Grönhagen, Mannström, G. de Laval and Lilliehöök, in the order given.

It proved that those competitors who rode horses which had been provided for them by the Committee from the number at its disposal, attained results which were as good as those obtained by competitors riding their own horses. The report of the judges was as follows.

	Name	Nation	Deduction of points for course-section No.												Total pts. deducted	Time taken: min. sec.	Deduct. for time	Final points		
			1	2	3	4	5	6	7	8	9	10	11	12						
1	Jölver	Denmark.....											12			2	14	10.49 ⁵ / ₁₀	—	86
2	Laybourn ...	„	10	10				2	flt.	2						7	31	12.41 ⁶ / ₁₀	—	79
4	de Mas Latrie	France															—	11.26	—	100
6	Godfree	Great Britain															—	11.43 ⁸ / ₁₀	—	100
7	Grönhagen ...	Sweden															—	9. 4 ² / ₁₀	—	100
10	Clilverd	Great Britain							57	2						2	61	15.46 ⁶ / ₁₀	20	19
11	Almkvist.....	Russia.....															—	12.03 ⁴ / ₁₀	—	100
14	Mannström...	Sweden															—	9.36	—	100
15	E. de Laval...	„							flt.								—	9.59 ⁴ / ₁₀	—	100
16	P. de Laval...	„								2							2	13.15	—	98
17	Brulé	France						17	17	2						2	38	14.44 ⁶ / ₁₀	—	62
20	Lilliehöök ...	Sweden															—	9.45 ⁵ / ₁₀	—	100

	Name	Nation	Deduction of points for course-section No.												Total pts. deducted	Time taken: min. sec.	Deduct for time	Final points
			1	2	3	4	5	6	7	8	9	10	11	12				
21	Wilkman	Russia.....													—	10.34 ² / ₁₀	—	100
22	Paaske	Norway							flt.						flt.	12.33	—	100
23	Patton	U. S. A.													—	10.42	—	100
25	Ussing	Denmark													—	11.21	—	100
26	Durant	Great Britain		5											5	10.00 ⁴ / ₁₀	—	95
27	Åbrink	Sweden													—	11.12 ⁴ / ₁₀	—	100
30	Bernhardt ..	Austria													—	12. 1 ⁶ / ₁₀	—	100
33	Norrby	Norway							flt.						—	13.10	—	100
34	v. Hohenthal	Russia.....								2					2	11.11 ⁸ / ₁₀	—	98
35	Lewenhaupt...	Sweden								2					2	11.00	—	98
36	G. de Laval...	»													—	9.39 ⁴ / ₁₀	—	100
37	Haeggström...	»			5				2						7	13.26	—	93
40	Wersäll	»		5						2					7	9.44	—	93
42	Stranne	»													—	11.14 ⁶ / ₁₀	—	100

* In accordance with the decision of the Committee, was allowed to finish the running event.
Remark. Laybourn, Zeilau, Nepokoupoi and Aejmelaens retired.
The start took place with intervals of 5 minutes between the competitors.
Flt. = fault.

Cross=Country Run.

The fifth and last event in the Modern Pentathlon had its start in the Stadium, from which place, the course, which was ca. 4,000 metres long, ran in a curve north-east and north of the Stadium, over broken country varying rather greatly in character, the winning-post being in the Stadium, after three-quarters of a lap round along the running-track there had been covered.

The start took place with intervals of 1 minute between the men.

While the last few competitors were being sent off, a French representative, Lieutenant Brulé, who had started first, came in at a good speed, followed by Captain Godfree (G. Britain) and E. Bernhardt (Austria), who, while on the track in the Stadium, was seriously threatened by Lieutenant Stranne (Sweden). Then came, close behind each other, two Swedes, Hæggström and Wersäll, in good form. After a moment's waiting came Patton (U. S. A.), who had started like a 100 yards sprinter, but it was only by the employment of an incredible degree of energy that he managed to stagger past the tape, beaten by half a metre at that point by Åbrink (Sweden), who made a brilliant final spurt and thus won the first place in cross-country running. After a long interval, the post was passed by a Dane, Jølver, with Mannström, a Swede, half a lap behind him. Lilliehöök, another Swede, was at the heels of von Hohenthal (Russia); he passed him when they reached the track in the Stadium, but was beaten by him in the final spurt. Almkvist (Russia), came into the Stadium a few metres ahead of G. de Laval (Sweden), who tried to pass him but did not succeed in doing so until just before reaching the tape, and then only by means of a powerful final spurt. Paaske (Norway),

was a few metres behind de Laval. Then the two Swedes, Lewenhaupt and Grönhagen, had a struggle to see who would break the tap first. They were followed very closely by de Mas Latrie (France), who passed the post with determination marked on every feature. Clilverd (G. Britain), was the last to arrive, just as he had been the last to start.

The times are shown by the following table.

Name	Nation	Time taken: min. sec.
Brulé	France	20.48 ³ / ₅
Godfree	Great Britain	22. 3 ⁴ / ₅
Bernhardt.....	Austria	22.34
Stranne	Sweden	21.45 ¹ / ₁₀
Durant.....	Great Britain	24.37 ⁹ / ₁₀
Hægström	Sweden	19. 4
Jölver	Denmark	26. 8 ³ / ₅
Wersäll	Sweden	20.36
Patton	U. S. A.	20. 1 ⁹ / ₁₀
Åsbrink	Sweden	19.00 ⁹ / ₁₀
P. de Laval.....	»	24.19 ³ / ₅
von Hohenthal	Russia	23.28 ⁸ / ₅
Mannström	Sweden	21.21 ⁹ / ₁₀
Wilkman	Russia	22.57 ⁴ / ₅
Lilliehöök	Sweden	20.32 ⁹ / ₁₀
Almkvist	Russia	23.16 ¹ / ₁₀
G. de Laval	Sweden	21.56 ¹ / ₅
Paaske	Norway	21.19 ³ / ₅
de Mas Latrie.....	France	24.17 ² / ₅
Grönhagen	Sweden	21.41 ⁸ / ₅
Lewenhaupt.....	»	20.16 ⁷ / ₁₀
Clilverd	Great Britain	24. 6 ¹ / ₅

Ussing, Denmark, retired on account of an injury.

FINAL RESULT.

The placing of the competitors, with the points obtained in each of the 5 events and in the competition as a whole, is shown by the following table:

Name	Nation	Points					Total
		Shoot- ing	Swim- ming	Fenc- ing	Riding	Run- ning	
Lilliehöök, G. M. ...	Sweden	3	10	5	4	5	27
Åsbrink, K. G.	»	1	4	15	7	1	28
de Laval, G. P. F. ...	»	2	3	10	3	12	30
Grönhagen, Å. E. ...	»	18	5	1	1	10	35
Patton Jr, G. S.	U. S. A.	21	7	4	6	3	41
Stranne, J. S. M.....	Sweden	11	9	3	8	11	42
Mannström, B. K. A. .	»	14	14	16	2	9	55
Bernhardt, E.	Austria	26	2	6	12	14	60
Clilverd, R. E.	Great Britain ...	12	1	9	23	18	63
Wersäll, E. G.	Sweden	9	8	21	19	6	63
Godfree, D. W.	Great Britain ...	16	6	17	11	13	63
Hægström, N. I. ...	Sweden	13	15	18	20	2	68

Name	Nation	Points					Total
		Shoot- ing	Swim- ming	Fenc- ing	Riding	Run- ning	
Paaske, C.	Norway	19	16	14	14	8	71
de Laval, C. P. G. ...	Sweden	5	17	13	17	20	72
de Mas Latrie, J. ...	France	15	27	2	10	19	73
Wilkman, O.	Russia	10	23	20	5	15	73
Lewenhaupt, C. G. S.	Sweden	24	12	19	15	4	74
Durant, H.	Great Britain ...	4	28	7	18	21	78
Brulé, G.	France	28	18	8	22	7	83
Almkvist, A. A.	Russia	23	11	27	13	16	90
von Hohenthal, V. G.	»	17	19	25	16	17	94
Jölver, K. A. V.	Denmark	32	26	22	21	22	123

Winners.

1. G. LILLIEHÖÖK..... Sweden..... **27** points.
2. K. G. ÅSBRINK..... Sweden..... **28** »
3. G. DE LAVAL..... Sweden..... **30** »



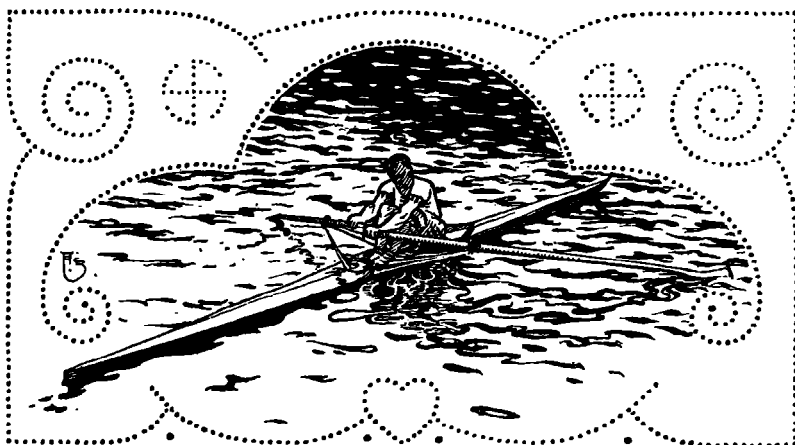

THE ROWING COMPETITIONS OF THE OLYMPIC GAMES.

ORGANIZATION AND PREPARATIONS.

It was a source of great satisfaction to all friends of rowing, both at home and abroad, to learn that rowing had at length been placed on the programme of the Olympic Games of 1912. In Sweden this decision had been preceded by a lively agitation, carried on, to a great extent, in the form of articles in the Press.

The Swedish Rowing Association took steps to appoint an Olympic Rowing Committee, the members of which were as follows:

<i>Hon. President:</i> ...	FRED. LÖWENADLER, Esq.	
<i>President:</i>	NILS LJUNGGREN, Esq.,	Stockholm.
<i>Secretary:</i>	ULRICH SALCHOW, Esq.,	»
<i>Treasurer:</i>	PER O. S. FJÄSTAD, Esq.,	»
<i>Boat-house Chief:</i>	W. CLEMENS, Esq.,	»
<i>Other Members:</i> ..	OTTO ANDERSSON, Esq., ...	»
	T. MAGNUSSON, Esq.,	»
	V. ZETTERLUND, Esq.,	»
	K. K. STAMSJÖ, Esq.,	Malmö.

The first thing the Committee took in hand was the drawing up of the programme, a task somewhat difficult of execution, for the list of events had to be such as, without altogether excluding any type of boat in general use in any country, and, at the same time, without being too comprehensive, would give the competing nations an opportunity of meeting each other in types of boats common to them all.

THE PROGRAMME.

The programme was at length arranged by the Committee and embraced three events for outriggers and one for inriggers.

The outriggers were for eights and fours with coxswain, and single sculls, while the inrigger event was for fours. This programme was ready early in 1910 and was approved of by the Meeting of the International Olympic Committee at Buda-Pesth in 1911. The Swedish rowing experts had, consequently, included in their programme neither coxswainless fours, nor double sculls, nor outriggered pair oars.

The Rowing Committee was reproached very frequently during the first six months after the Buda-Pesth meeting, for having excluded the above-mentioned types of boats. Energetic arguments were raised, both in Great Britain and in Germany, to show that just these boats produced the best rowing, and that in no other type was the art of rowing so well developed as in these. Consequently, it was said, it would be unjust to exclude these boats from a World's Championship for Amateurs; the competition would lose its real sporting character, and there would be no opportunity of properly measuring the development of the art of rowing. The Swedish Rowing Committee, however, was of the opinion that racing with coxswainless fours and pair oar boats in strange waters, would occasion too many possible or actual fouls, with the resulting protests and loss of time, and that these inconveniences would not be balanced by the advantages to be gained by the presence of the types of boat in question. As the Committee, in the summer of 1911, and in consequence of many excellent reasons, had determined to hold the Olympic Rowing Regatta in Djurgårdsbrunnsviken and Nybroviken, with the start at Lido and the finish opposite Torstensongatan, i. e., over a course which had the misfortune not to be a straight one, it was absolutely impossible to make any alteration in the programme accepted at Buda-Pesth. Even if the course in question offers but few difficulties to the coxswain of a four or an eight, the Olympic sculls racing proved very plainly that it would have been a fatal mistake to include coxswainless fours and pair oar boats on the waters chosen.

In addition to this, experience from regattas held in other countries had often shown that the results obtained with these types of boats have depended, in far too great a degree, on good or faulty steering, another circumstance which also spoke against the inclusion of the boats in question, the legitimacy of whose presence at regattas held on certain waters, the Committee has no desire to question, however.

THE COURSE.

As regards the course, there were several stretches of water in or near Stockholm that could have been chosen, such as Kyrkviken, where the Stockholm Rowing Club has frequently held its races; Tyringe Sound, just outside Vaxholm — of classic memory — and Vaxholm Fiord; all offering good, straight courses for the necessary

2,000 metres ($1\frac{1}{4}$ mile). In other respects, however, the waters mentioned were not at all satisfactory, for they were distant from the city, and the communications would have caused the crowd of foreign competitors altogether too much trouble when going out to the daily row over the course. With the wind in certain quarters, too, little or no shelter could be had by the oarsmen, and, in the event of a fresh summer breeze springing up, the efforts of the crews of the outriggers would have been frustrated or, at the very least, made of little avail. And even if these waters had been perfectly satisfactory from a technical point of view, the Committee would have still been unable to choose any of them, in consequence of the scarcity of accommodation in each case, as the erection of boat-houses, etc., for an active rowing contingent amounting to a couple of hundred men, either at Vaxholm or at Kyrkviken, would have been altogether too great a task. At the beginning of May, 1911, the Committee chartered a steamer and made a special trip in order to settle the matter satisfactorily, and the members decided unanimously to choose Djurgårdsbrunnsviken for the regatta.

One great advantage possessed by the course chosen was its convenient situation, which allowed, not only the other competitors and the spectators at the Olympic Games but also the general public, to attend the Rowing Competitions without the least trouble, the events in question thus being brought into closer connection, so to say, with the other sections of the Games.

Djurgårdsbrunnsviken offers, first, a straight course, with deep water, 1,500 metres in length, and of ample width for two boats, from Lido towards and right past the Military Baths. Not before these are reached is there a bend, but then the course sheers first to starboard and afterwards to port, so that the boat -on the Ladugårdsland side must take the middle arch of the Djurgård Bridge, while the boat with the Djurgård station has to steer through the southern arch.

It can be considered an advantage for the boats to pass the bridge under different arches, as these served to show the course very clearly for the three hundred metres before the bridge was cleared, while, after passing the bridge, the boats were certain to keep a sufficient width of water between them.

The Rowing Committee had to choose a course affording sheltered water even in windy weather, and one that could be reached quickly and conveniently both by the competitors and the public, and in the vicinity of which there were opportunities of finding accommodation, and establishing training-quarters, for the crews.

The Djurgårdsbrunnsviken waters satisfied all these conditions, but the course had the disadvantage of not being a perfectly straight one. The other places previously mentioned, satisfied none of the conditions but that of a straight course, and so it will be easy to understand and approve of the Committee's choice of Djurgårdsbrunnsviken for the races.

THE HOUSING OF THE BOATS.

The only place at the disposal of the Committee was the boat-house belonging to the Stockholm Rowing Club, with the little plot of ground attached, but, by raising a marquee in a line with the boat-house, 30 metres long, and deep enough to house the big eights, as well as the numerous fours and sculls expected to take part in the Regatta, it was found possible to shelter 16 eights, 23 fours and 14 single sculls.

A large tent was erected for the crews on the grounds just south of the boat-house, with separate dressing rooms, each intended for 14 men and marked with the flag of the nation for which it was reserved.

Among other important arrangements made may be mentioned the erection of a Grand Stand close to the winning post at Strandvägen, for the thousands of spectators expected by the Committee.

THE OLYMPIC REGATTA AT STOCKHOLM.

The foreign crews began to arrive in the early part of July, the first to make an appearance being the Hungarian eight and the two single sculls, Leviczky and Mészáros. There was an old acquaintance of Stockholmers in the eight — M. Miltiades Manno, one of Hungary's best racing skaters, in which character he appeared here in 1905, when he took part in the Northern Games.

The crews arrived one after another, and when, two days before the beginning of the Regatta, the Belgians and Frenchmen came, all the nations and crews entered on the lists were present in Stockholm. This enabled the Olympic Regatta of 1912 to set a record which it may prove difficult to beat, for, both as regards the number of nations taking part in the contest and the quality of the oarsmen, these Olympic Rowing Competitions were far and away superior to any preceding events of the kind.

In consequence of the enormous number of entries, the Rowing Committee found it necessary to have three days for the races instead of two; the length of the programme, indeed, making the alteration quite indispensable. The Committee sent a circular to this effect at the beginning of June to all the nations taking part in the various contests, but Australasia and France entered protests against the proposed alteration — according to which, racing would take place on July 17 as well as on the 18 and 19 — and so the Committee was obliged to delay the alteration until all the crews, those from Australasia and France, too, had arrived in Stockholm, so as to be able to arrange the matter in the most suitable way. A formal protest was raised, however, by the representatives of Great Britain, against *not* beginning the Regatta on the 17 July, it being considered as offending against the proper spirit of sport to row twice on two days in succession — an expression of opinion that the Swedish Committee was quite able to agree with. At the invitation of the Committee, and after the arrival of the French crews, therefore, there was a meeting of representatives of each country, at 3 p. m., Monday, July 15, at the Offices of the Olympic Games, for the purpose of trying to persuade

the crews to agree to an alteration being made. The Swedish Rowing Committee was represented on this occasion by Messrs. Fjästad and Salchow, the latter of whom, as representing the body that called the meeting, was appointed chairman.

All those present agreeing to row on the 17 July too, the Rowing Committee, at a meeting held on the evening of the 15 July, determined to begin the Regatta on the day chosen, the first race to come off at 10 a. m.

The heats and the positions were both determined by lots.

The first day of the races was favoured with warm, calm weather. The course was in excellent order, and had been inspected the evening before by all the coxswains.

The second day, Thursday, July 18, was a lovely day, too, the sky being covered with fleecy clouds, and a light easterly breeze blowing, just strong enough to curl the surface of the water. The last day of the races was favoured with the same delightful weather.

The Harbour Authorities were kind enough to close Djurgårdsbrunnns viken to traffic, so that there was no possibility of a collision occurring with foreign craft. Axel Hultman, Esq., acted as starter. The start was marked by two barges anchored just off Lido. The umpires, Messrs. Hans T. Naess, Arvid Höök, Otto Andersson and C. J. Appeltoft, accompanied the races in steam launches lent by the Naval Authorities.

The leaders of the Regatta were Messrs. U. Salchow and P. Fjästad.

The boats marked below by the letter L. are those that had the Ladugårdsland (northern) station; those marked by D. are those that took the Djurgård or southern, side.

EIGHTS, OUTRIGGERS.

First Round.

Wednesday, 17 July.

Heat 1. 12 noon.

GERMANY (Sport Borussia)	FRANCE (Soc. Nautique de Bayonne)
Carl Eichhorn	Jean Arne
Ludwig Weinacht	Gabriel St Laurent
Richard Friesicke	Marius Lenjeune
Andreas Wegener	Louis Lafitte
Fritz Eggebrecht	Jean Elichagaray
Heinrich Landrock	Joseph Campot
Egbert Reinsfeld	Etienne Lesbats
Gottfried Gelfort, stroke	Pierre Alvarez, stroke
Otto Charlet, cox.	François Elichagaray, cox.
L.	D.

The boats kept in company as far as to Stenudden, where the Germans began to show in front, their stroke spurting directly afterwards. The Frenchmen made no response and were soon a length behind. Half way up the course, however, they showed signs of attempting an answering spurt, but went to pieces — in parts. Their opponents rowed as if they meant to win, and as regards style, muscle

and training, were quite superior to the Frenchmen, a fact they displayed still more during the last half of the race.

The Germans rowed a stroke varying between 32 – 38 to the minute. The French, rowing from 40 — 28 per minute, never seriously threatened their opponents, who won by about 4 lengths. Time 6 min. 45 sec.

Heat 2. 12.20 p. m.

AUSTRALASIA	SWEDEN (Göteborgs Roddklubb)
John A. Ryrie	E. Amundén
Simon Frazer	R. Bergstedt
Hugh K. Ward	G. Broberg
Thomas Chas Parker	S. Ericsson
Henry Hauenstein	I. Rydberg
Sydney A. Middleton	A. Almqvist
Harry Ross-Boden	A. Svendel
R. B. Fitzhardinge, stroke	Leif Sörvik, stroke
Robert G. K. Waley, cox.	G. Ahlberg, cox.

D.

L.

Australia started at 44 for the first half minute, the Swedes keeping to 40. The perfectly trained visitors, who rowed like one man, took the lead after 200 metres and never lost it again. When about half the distance was covered, the Swedish boat showed signs of creeping up the Australians, but the latter increased the pace and passed the boat-house 2 clear lengths ahead of their opponents, who showed evident signs of fatigue and were beginning to go to pieces. The Australians rowed the whole time at a great pace, with only a slight swing, while the style employed by the Swedes bore greater resemblance to English methods. The home-crew was beaten by more than 3 lengths. Time 6 m. 57 sec.

Heat 3. 12.40 p. m.

GERMANY (B. R. G.)	HUNGARY
Otto Liebing	Stefan Szebeny
Max Broeske	Arthur Baján
Max Vetter	Miltiades Manno
Willi Bartholomae	Stefan Jeney
Fritz Bartholomae	Ludwig Graf
Werner Dehn	Nikolaus Szebeny
Rudolf Keichelt	Anton Szebeny
Hans Mathiae, stroke	Georg Szebeny, stroke
Kurt Runge, cox.	Koloman Vasko, cox.

D.

L.

The German crew, which formed Germany's best eight, n-as in front all the time. The Hungarians rowed at a slower pace than their opponents during the whole of the race; they had a nice recovery but could get no good grip of the water and used the slide incorrectly, pushing it before the body. The Germans, on the other hand, rowed in clean English style, even if they had not the same extraordinarily rapid grip of the water and the swift, easy recovery possessed by their models. The Germans, too, were physically the superior of their opponents, and, before any long time had elapsed, their energetic efforts gave them such a lead that, at the boat-house, more than 2 lengths separated the boats. All the

efforts of the Hungarians were in vain and the Germans won quite easily. Time 6 m. 57 sec.

Heat 4. 1 p. m.

GREAT BRITAIN (New College)	NORWAY
William Guy Fison	Einar Sommerfelt
Sir William Lorenzo Parker, Bt.	Thomas Høie
Thorn. Cunningham Gillespie	Harald Herlofson
Beaufort Burdekin	Olaf Solberg
Fred. Archibald Hugo Pitman	Gustaf Haere
Arthur Fred. Regin. Wiggins	Hannibal Fegth
Charles W. Berry Littlejohn	Gunnar Grantz
Robert Croft Bourne, stroke	O. T. Krogh, stroke
John Drummond Walker, cox.	John Björnstad, cox.
D.	L.

The Norwegian eight, who were considerably heavier and more powerfully built than their English rivals, got away first, and kept the lead for about 150 met. rowing as much as 40 while New kept to 38 for the first minute. Both crews rowed excellently, with a long swing and a powerful grip of the water, but the recovery of the Norwegians was not so quiet as that of the Englishmen, neither was the finish all that could be desired. These two faults, or rather, the fact that the Norwegian crew had not reached the same degree of perfection as the English, probably contributed in very great measure to New taking the lead when half the course had been covered, rowing a quiet effective stroke of c:a 32 to the minute. New won by about 2 lengths. Time 6.42¹/₆.

Heat 5. 1.20 p. m.

GREAT BRITAIN (Leander Club)	CANADA
E. R. Burgess	C. Riddy
Sidney Ernest Swarm	P. E. Boyd
Leslie Graham Wormald	A. H. E. Kent
Ewart Douglas Horsfall	W. E. G. Murphy
James Angus Gillan	A. Sinclair
Arthur Stanley Garton	B. R. Gale
Alister Graham Kirby	B. J. Gregory
Philip Fleming, stroke	G. B. Taylor, stroke
Henry Bensley Wells, cox.	W. O. Mc Cleary, cox.
D.	L.

The Canadians started at 46, while Leander kept to 40, this falling after a minute first to 38 and then to 36, the representatives of the Maple rowing 40—42 during the whole of the race.

The two boats kept side by side for a long time, and the pace, in consequence of the terrific time kept up by Canada, was a most amazing one. At the boat-house, Leander spurted and succeeded in creeping half a length in front, but Canada answered with an immensely long, desperate effort and the issue was doubtful until Djurgård Bridge was passed, when Fleming gathered Leander for a final effort which gave the victory to Great Britain by about half a length.

Leander rowed in orthodox English style, with a long swing, quiet, finished

recovery, a powerful grip of the water and a stroke that was drawn out to the last inch. Canada relied more on muscle, and the tremendous rate at which they rowed prevented a proper recovery. The crew, although beaten, fought like heroes, and lost after the pluckiest struggle imaginable. Time 6.19.

Heat 6. 1.40 p. m.

SWEDEN (Roddklubben af 1912)	W. O. Time 7.05
Gust. Brunkman	
Per Mattson	
Sebastian Tamm	
Schering Wachtmeister	
Conrad Brunkman	
W. Bruhn-Möller	
Ture Rosvall	
Herman Dahlbäck, stroke	
Willie Wilkens, cox.	

L.

Second Round.

Thursday, 18 July.

Heat 1. 3.40 p. m.

GREAT BRITAIN (New College)	SWEDEN (R. K. 1912)
L.	D.

Both boats got off beautifully and kept side by side for the first 400 met., the Swedish crew rowing a quicker stroke than New (36 to 32). By degrees, however, Bourne pushed his boat half a length in front and had this lead on reaching the inner curve at the bath-house, where he spurred in order to make use of the advantage afforded by the position, and the Swedish stroke answered too late. The result was, that at Djurgård Bridge Great Britain led by a length and Dahlbäck, when on reaching the inner curve of his side of the course, he did begin a spurt, could not get his men to respond to his efforts. In the finish the Swedes regained a little of their lost ground, but they could not prevent New from winning by a length in 6 min. 19 sec. It was chiefly Bourne's cleverness that decided the race, the manner in which he gathered his crew for the final burst being simply masterly.

Heat 2. 4 p. m.

GERMANY (Berliner R. G.)	GERMANY (Sp. Borussia)
L.	D.

B. R. G. rowed in brilliant style with a long stroke, a fine swing and powerful grip of the water, followed by a quiet recovery. The other crew showed the same good qualities but not to an equal degree, and B. R. G., which was leading by a length at the halfway point, won by nearly $2\frac{1}{2}$ lengths in 6 min. 22 sec.

Heat 3. 4.20 p. m.

GREAT BRITAIN (Leander C.)	AUSTRALASIA
D.	L.

Both crews started very well, Australia retaining its speed of about 40 for the whole of the race, while Leander was content with 36—34, the figures sometimes

falling to 32. Australia put all its weight into its strokes and led by $\frac{1}{2}$ length at the 1,000 metres mark. The time for half distance was 3 min. 2 sec.; these figures showing the speed at which the boats were moving. At the boat-house Australia led and took the inner curve a clear length ahead. At this point, however, Fleming began a terrific spurt, which resulted in his opponents' lead being diminished at the bridge to only half a length. The Australian eight now began to row somewhat raggedly and showed other signs of fatigue; Leander, on the contrary, beginning another magnificent spurt which lasted until the winning post was passed. Fitzhardinge was not sufficiently supported by his men, so that the half length by which Australia led at the bridge was snatched out of its hands. The two boats lay side by side 100 metres from the finish, but Leander stayed better, and the English style allowed of more being got out of the spurt, so that the British boat won by about 3 metres.

Those that had the pleasure of seeing this race will probably never forget it. From beginning to end, the scene was a most imposing one; the driving power distinguishing the excellent English style of rowing, and the tremendous energy shown, being qualities that must have made the deepest impression on all with any knowledge of rowing. The two strokes, especially, deserve all praise for the energy and coolness they exhibited, even when the struggle was hottest. The race was rowed in 6 min. 10, sec. the shortest time yet noted for this distance in tideless waters.

Fleming's spurt from the bath-house up to the bridge, at a time when the general belief was that Leander was quite out of the race, was probably the most memorable episode in this remarkable race.

Semi-Finals.

Friday, 19 July.

Heat 1. 11.30 a. m.

GREAT BRITAIN (New College)

W. O.

Bourne took his men over the course, without any effort, in 7.47, but the W. O. gave the spectators a good opportunity of seeing the pure English style of rowing, with its firm grip of the water and the quiet, almost stealthy recovery.

Heat 2. 12 noon.

GREAT BRITAIN (Leander C.) GERMANY (Berliner Ruder G..)

D.

L.

At the very start, Leander managed to get a couple of metres' lead, but the German crew soon recovered itself, and at the 500 met. mark was leading by about half a length. As seen from the shore, the English eight seemed to take the race very quietly, rowing scarcely more than 34 to their opponents' 38, and at the 1,000 metres mark the Germans were leading by nearly a length. Both crews were rowing in excellent style, both clearly after the same model. Berlin were wonderfully quick, and the crew now proved that it possessed a lot of endurance, too. It was a very homogenous eight, with big, very muscular men who gave evidence of having been well trained. Germany has the greater honour of this crew, as all its members had only had their free afternoons or evenings for practice, the time at each man's disposal depending on the business or other work at which he was engaged during the greater part of the day. It is evidence

of clear-sighted, energetic work that, under such circumstances, it was found possible to bring together such a crew as that of the B. R. G., which has probably very few rivals.

After these reflections we can return to the race. Just before reaching the boat-house, Leander, which had the outside curve, spurted and managed to pick up about half a length, while the Germans, in our opinion, committed the fault of not making use of the advantage given by the possession of the inner curve, and making an extra exertion which would have certainly increased the distance between them and the English crew, or, in any case, would have kept them at their previous distance in the rear. Fleming put his men to a severe test from the bath-house to the bridge, and the determination and speed by means of which Leander drew level with their opponents after one minute's rapid spurt, were simply unique. The German crew was not rowed out, however, and a desperate struggle took place all the way from the bridge to the finish, the result being that Leander won by about half a length in 6 min. $16\frac{2}{5}$ sec.

A careful observer could not but note that it was in consequence of faulty tactics the German crew lost, and not because it was physically inferior to its opponents. That was the impression we gained, at all events, and on the supposition that the crews were physically equal to each other, the faults committed by the losers were the following.

After having gained the decided lead he had, the German stroke did not defend this advantage energetically, for, at the bath-house in the inner curve, he should have spurted with all his power and then with equal energy have defended his position against Leander, which, it could safely be calculated, would make its strongest spurt from the bath-house and under the bridge, where the British crew had the advantage of position.

Instead, however, of defending his hard-won lead to the utmost, the German stroke allowed Leander to come up, and thus let the victory depend on the result of the last minute along the finish, where Leander was superior to its rival.

Final.

Friday, 19 July.

6 p. m.

GREAT BRITAIN (Leander C.)	GREAT BRITAIN (New College)
D.	L.

The two boats rowed side by side until the 1,000 metres mark was passed, when Leander spurted in order to neutralize Bourne's efforts at the bath-house, where New had the inner curve. Then Fleming pressed his men from the bath-house to the bridge, so that Leander led by a clear length at the latter place, all Bourne's efforts being unable to prevent New from falling behind. Leander won by about a length in the good time of 6.15.

FOURS, OUTRIGGERS.

First Round.

Wednesday, 17 July.

Heat 1. 6.20 p. m.

DENMARK (Polytechnic R. C.)	W. O.
Time 7.20.	

Heat 2. 6.40 p. m.

FRANCE	FINLAND
Andre Mirambeau	Johan Waldemar Nyholm
L. H. Thomaturge	Oskar Edvin Forsman
R. P. Saintongey	Edvin Lönnberg
Pierre Allibert, stroke	Emil Nylund, stroke
François Elichagaray, cox.	Valdemar Henriksson, cox.
L.	D.

For a long time the two boats kept side by side, both crews rowing in good style, the Frenchmen at 38—32, the Finlanders at 40—32. During the last 500 met., however, the last named crew went away from its opponents, which seemed unable to make any effective spurt. Time 7.18.

Heat 3. 7 p. m.

NORWAY (Christiania R. C.)	AUSTRIA (Leibnitz)
Henry Larsen	Richard Mayer
Mattias Torstensen	Hugo Cuzna
Theodor Klem	Georg Kröder
Haakon Tönsager, stroke	Fritz Kromholz, stroke
Ejnar Tönsager, cox.	Emil Jand, cox.
L.	D.

The Norwegian crew took the lead with much resolution, rowing in excellent style with a well-pronounced swing and a good grip of the water. The Austrians, too, rowed in good style but used the slide too early in the stroke, while their grip of the water was not quite so good as that of their opponents.

The Norwegians went right away from their rivals and were the only ones to finish, Austria giving up the fight at the bridge. Time 7.15.

Heat 4. 7.20 p. m.

NORWAY (Studenternes R. C.)	AUSTRIA (Donau)
Öyvin Davidsen	did not start
Leif S. Rode	
Tommy Schjöth	
Olaf Dahl, stroke	
Einar Eriksen, cox.	
L.	

The Norwegian undergraduates rowed over the course in good style. Time 7.27.

Heat 5. 7.40 p. m.

DENMARK (K. R. C.)	BELGIUM
Hans Jörgensen	Guillaeume Visser
Knud Christian Götke	Georges van den Bossche
J. V. T. Praem	Edmond van Waes
Th. H. Ch. Eyrich, stroke	Georges Willems, stroke
Silva Smedberg, cox.	Leonard Nuytens, cox.
D.	L.

Both boats started well, and kept together at an even speed until the 1,000 metres mark was reached. At this point the Danes delayed their response to the spurt made by the Belgians, and all the endeavours the former made during the remainder

of the race to make up the two clear lengths lost at this point were in vain, the Belgians winning pretty easily in 7.15.

Heat 6. 8 p. m.

GERMANY (Ludwigshafen)	SWEDEN (Vaxholm)
Albert Arnheiter	John Lager
Herman Wilker	Axel Erikson
Rudolf Fickeisen	Ernst Wetterstrand
Otto Fickeisen, stroke	Gunner Lager, stroke
Karl Leister, cox.	Karl Sundholm, cox.

D.

L.

Both crews began with a quick stroke and lay side by side for some distance, but after the one kilometre's (1,000 met.) mark, the Germans, without any exertion, led by about half a length, the same distance separating the boats when the boat-house was passed. In the finish, the Germans put themselves 2 lengths in front of their rivals, and won with the greatest ease. Time 7.06.

Heat 7. 8.20 p. m.

GREAT BRITAIN (Thames R. C.)	GERMANY (Mainz)
Julius Beresford	did not start
Karl Vernon	
Charles Gardner Rought	
Bruce Logan, stroke	
Geoffrey Carr, cox.	

D.

The British boat rowed over the course in a resolute but far from beautiful style. Time 7.27.

Second Round.

Thursday, 18 July.

Heat 1. 12.20 p. m.

DENMARK (Polyteknik R. C.)	FINLAND
----------------------------	---------

L.

D.

(nr 3 replaced by M. Simonsen)

Half the course was covered with the boats side by side, the Finnish crew rowing 40 to the 32—34 of the Danes. The rapid stroke of the Finlanders was gained, however, at the expense of length, while the Danes rowed in beautiful style with a pronounced swing of the body and long, powerful strokes. At the bath-house the Danes, who had spurred after the half-distance, had a lead of about $1\frac{1}{2}$ length, which was increased at the finish to nearly 3 lengths. Time 7.09.

Heat 2. 12.40 p. m.

GREAT BRITAIN (Thames R. C.)	NORWAY (Stud. R. C.)
------------------------------	----------------------

D.

L.

After rowing 600 met., the British crew had a lead of about half a length which, during the remainder of the race, was gradually increased to some $2\frac{1}{2}$ lengths. Time 7.14.

1 p. m. Heat 3.

NORWAY (Christiania R. C.)	BELGIUM
----------------------------	---------

L.

D.

This was one of the most exciting heats in the round. Both crews rowed well from the start at 40 and 44 respectively, this speed afterwards falling to 32—36. The boats moved along rapidly side by side, but, in spite of the calls made by the strokes, neither crew showed any unevenness. Belgium led by about half a length at the boathouse, but the Norwegians had a lot in reserve and, after a brilliant finish, where the four rowed like one man, the last-named crew passed the post a clear length in front. Time 7.05.

Heat 4. 1.20 p. m. GERMANY rowed alone over the course. Time 7.14.

Semi=Finals.

Friday, 19 July.

Heat 1. 1.30 p. m.

GERMANY (Ludwigshafen) DENMARK (Polyteknik R. C.)
D. L.

The Danes rowed very energetically from the start and led by about half a length at the 500 met. mark. Here, however, the Germans came on with a short, powerful spurt, which gave them a lead that was afterwards retained, apparently without any great effort, and was gradually increased to ca $2\frac{1}{2}$ lengths, the distance separating the boats at the finish. The German crew possessed great physical power and was of a comparatively mature average age, features also characteristic of the English four representing the Thames Rowing Club. Ludwigshafen rowed, it is true, a pretty short stroke forwards, but, backwards, it was of a good length, with a quiet, finished recovery, and a powerful pull through the water. N:r 3, with his billowing Germanic beard, reminded one of a Viking, and his appearance contrasted strangely with that of the other oarsmen, most of whom were clean shaven or had only small moustaches. Time 6.59.

Heat 2. 2 p. m.

GREAT BRITAIN (Thames R. C.) NORWAY (Christiania R. C.)
D. L.

With an energetic spurt, Thames took the lead from the very start, and 500 metres later the Norwegian boat was nearly a length behind. Thames kept its same rapid stroke even when the 1,000 met. mark was passed, rowing in good style from 34-36 to the Norwegians' 32—34. The last-named crew, however, pulled itself together for a spurt when close to the bath-house, so that at the bridge there was only a length between the boats.

In the finish, the Norwegians showed such energy, and rowed in such fine style, that their effort will be remembered as one of the most noteworthy episodes of the regatta. Inch by inch they crept up to the leaders, so that, in spite of the energetic, really desperate strokes of the Thames crew, the two boats passed the post almost simultaneously. The Norwegians, however, were about 3 met. behind their opponents whose time was $7.04\frac{4}{5}$. The Norwegians did the distance in $\frac{2}{5}$ sec. more.

Final.

Friday, 19 July.

5.30 p. m.

GERMANY (Ludwigshafen) GREAT BRITAIN (Thames
R. C.)
L. D.

After a very energetic race up to the 500 met. mark, where the two boats still lay side by side, the Germans began to take the lead and, at the kilometre mark, Ludwigshafen were about one length ahead. Thames fought pluckily, however, and Mr. Logan deserves every credit for the courageous way in which he challenged the leader. But at the Englishmen's last spurt between the bath-house and the bridge, it was clear that the crew was done for, while the Germans, on the other hand, rowed with still greater energy than before. Ludwigshafen won brilliantly by a good 2 lengths, and passed the post in excellent condition. Time $6.59\frac{2}{5}$.

FOURS, INRIGGERS.

First Round.

Wednesday, 17 July.

Heat 1. 11 a. m.

SWEDEN (Roddklubben af 1912)	NORWAY (Christiania Roklub)
Ture Rosvall	Claus Höyer
W. Bruhn-Möller	Reidar Durie Holter
Conrad Brunkman	Magnus Herseth
H. Dahlbäck, stroke	Frithiof Olstad, stroke
Willie Wilkens, cox.	Olof Björnstad, cox.

L.

D.

Both boats got well away, the Norwegians leading for the first hundred metres or so. Then the Swedes, who were rowing a somewhat quicker stroke, began to creep up, and soon passed their opponents, obtaining a lead which they retained for the rest of the race. The winning crew pulling from 32—38 a minute, the Norwegian stroke varying between 28 and 38. Both boats were very well rowed, and it was physical strength that gave Sweden the victory. Time $7.51\frac{5}{10}$.

Heat 2. 11.20 a. m.

DENMARK (Nykjøbings paa Falster Roklub)	SWEDEN (Göteborgs Roddför- ening)
E. A. E. Allert	Tage Johnson
Jörgen Ch. Hansen	A. Johansson
C. M. A. Möller	Axel Gabrielsson
C. F. Petersen, stroke	Charles Gabrielsson, stroke
P. R. Hartman, cox.	F. W. Brandes, cox.

L.

D.

At the start, Sweden led with an energetic stroke of 36, while the Danes rowed a longer but very effective stroke, which they used to perfection. The forward half of the stroke was one of extraordinary length, with a fine finish and excellent carriage of the hands. The way the crew rowed like one man was beyond all praise, and the four showed that it fully deserved its great reputation. The Swedish crew also made a very good impression and was only a little worse than its Danish rival; most noteworthy, perhaps, was the energetic stubbornness with which the Swedes defended the lead they succeeded in gaining at the start. The Danish crew was in better training, however, and the Swedes were not able to maintain their position when the Danes — who had the inner curve at the bath-house — began their spurt. Surely and irresistibly the

Danish boat came up to, and passed, the Swedish, which, although at Djurgård Bridge, it had the advantage of an inner curve, could make no use of its position, but was beaten by $1\frac{1}{2}$ length. Time 7.52.

Heat 3. 11.40 a. m.

NORWAY (Ormsunds Roklub)	FRANCE
Gunnar Grantz	Charles Gamier
Olaf Salberg	Alphonse Meignant
Gustaf Hæhre	Auguste Richard
Hannibal Feght, stroke	Gabriel Poix, stroke
John Björnstad, cox.	François Elichagaray, cox.
L.	D.

The two crews kept side by side for only 100 met., the Norwegians then taking the lead and keeping it, without once being challenged by their rivals. Time 8.03.

Second Round.

Wednesday, 17 July.

Heat 1. 5.40 p. m.

SWEDEN (R. K. 1912)	NORWAY (Orsmund).
D.	L.

The Norwegians at once took the lead, which they kept for the first half of the course, rowing 32—36 to the 34 of the Swedes. Halfway, the Swedish boat crept up to its rival and, from the bath-house to the post, there was a most desperate struggle for victory, which was decided in favour of the home-crew by an energetic spurt at the very last moment. Time 7.39.

6 p. m. Heat 2.

DENMARK (Nykjøbings p. F. R. C.)

L.

The crew rowed over in beautiful style. Time 7.39. W. O.

Final.

Friday, 18 July.

7.30 p. m.

DENMARK (N. p. F. R. C.)	SWEDEN
L.	D.

Both crews rowed nicely and evenly, keeping side by side, until the 1,000 met. mark was reached, when the Danish crew, exhibiting perfect style and great physical power, began to take the lead. The Swedish crew was somewhat handicapped by the circumstance that some of the men had taken part in a punishing race against New College the same day, and Nr 3 was not at all in form, owing to a bad boil on one of his legs. Consequently they had little hope of winning when, before the bridge was reached, the Danes began a final spurt, which gave them the race by a clear length. The Danish crew can be taken as the model of perfect rowing in inriggers, and its well deserved

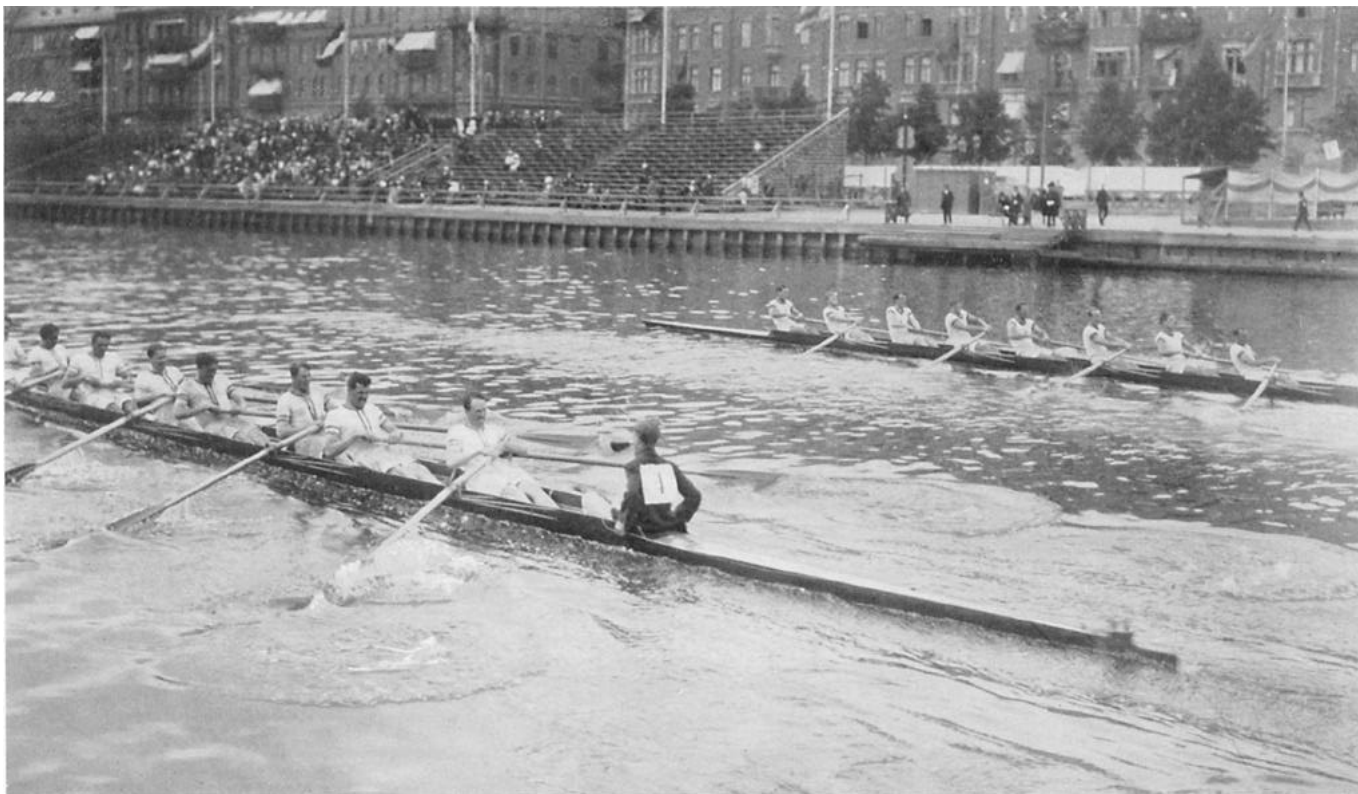

EIGHTS, OUTRIGGERS, SEMI-FINAL. LEANDER R.C.(to right), BEATING AUSTRALASIA

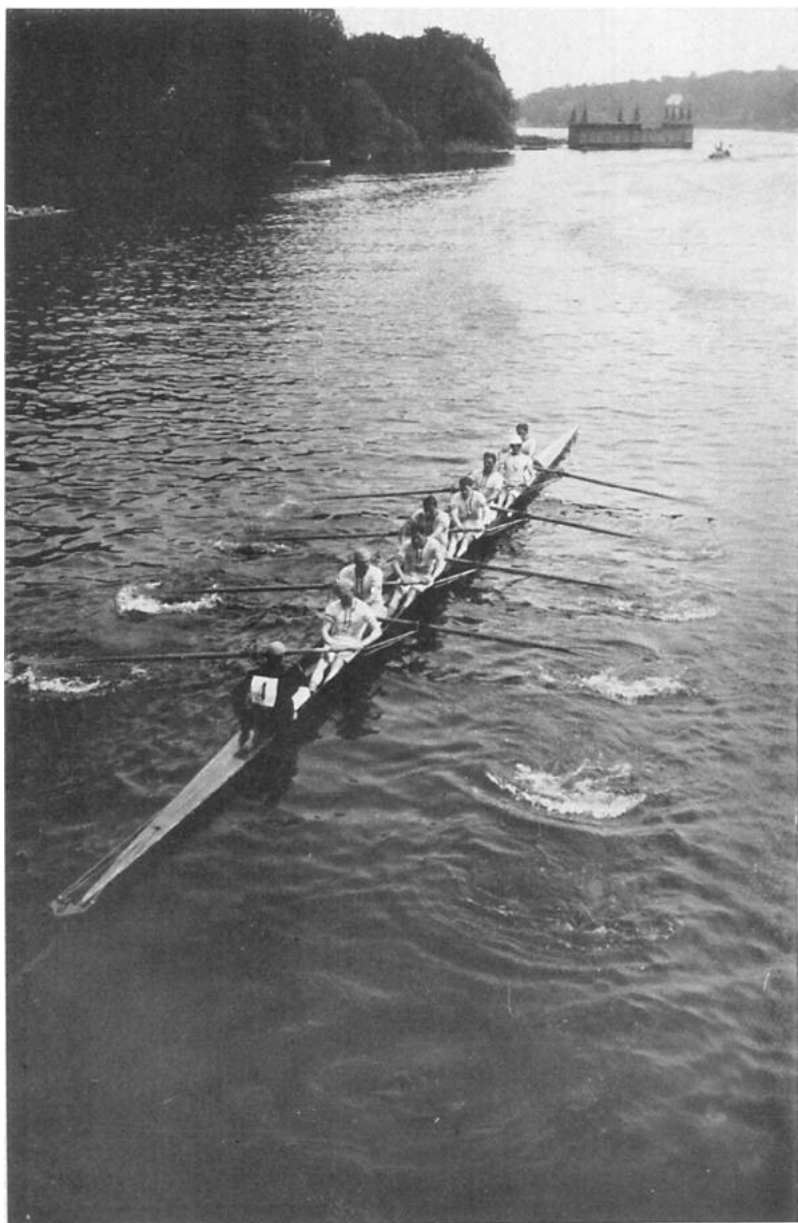

LEANDER ROWING CLUBS EIGHT.

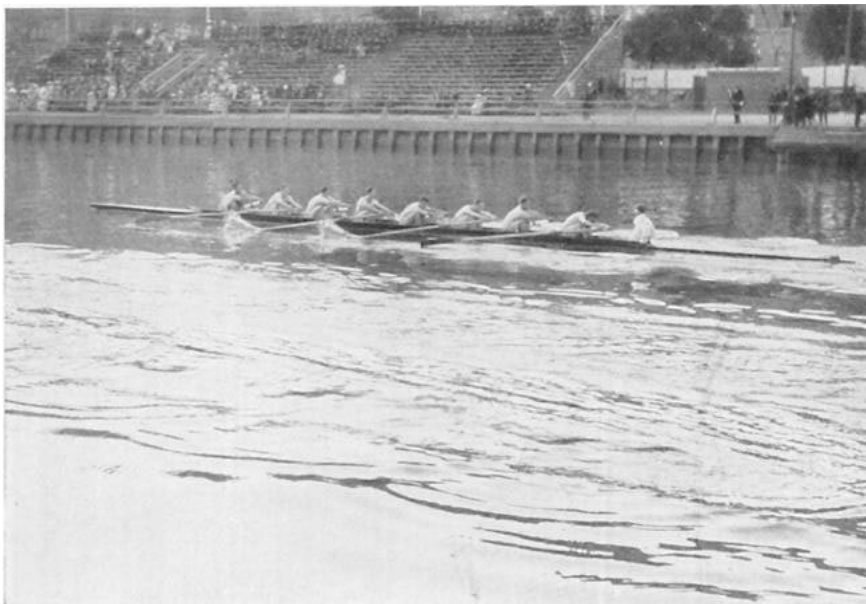

EIGHTS, OUTRIGGERS. NEW COLLEGE, Great Britain, 2:nd prize,
View From final V. Leander R. C., Whose 'wash' can be seen in the foreground.

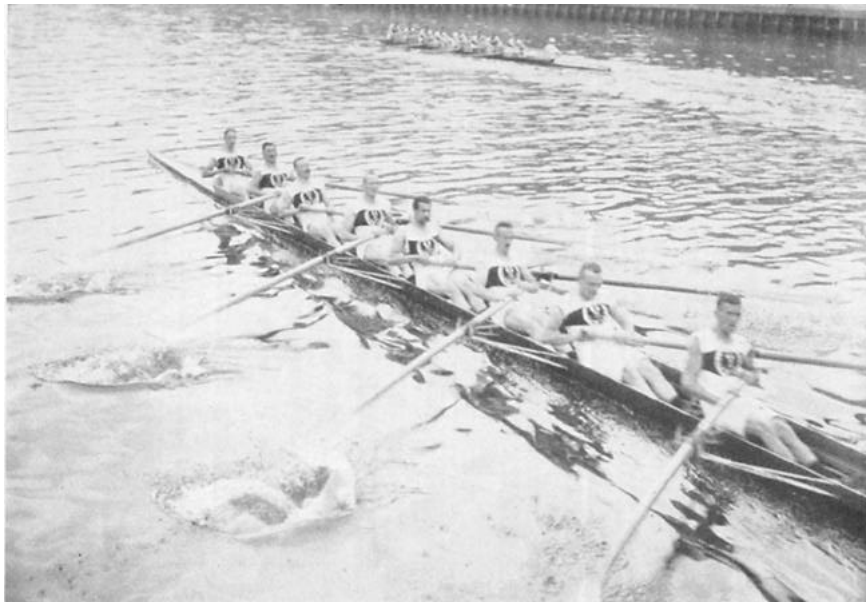

EIGHTS, OUTRIGGERS.
BERLINER RUDERGESLLSCHAFT, in background, beating SPORT BORUSSIA in 2:nd round.



EIGHTS, OUTRIGGERS. SWEDEN beating NORWAY.

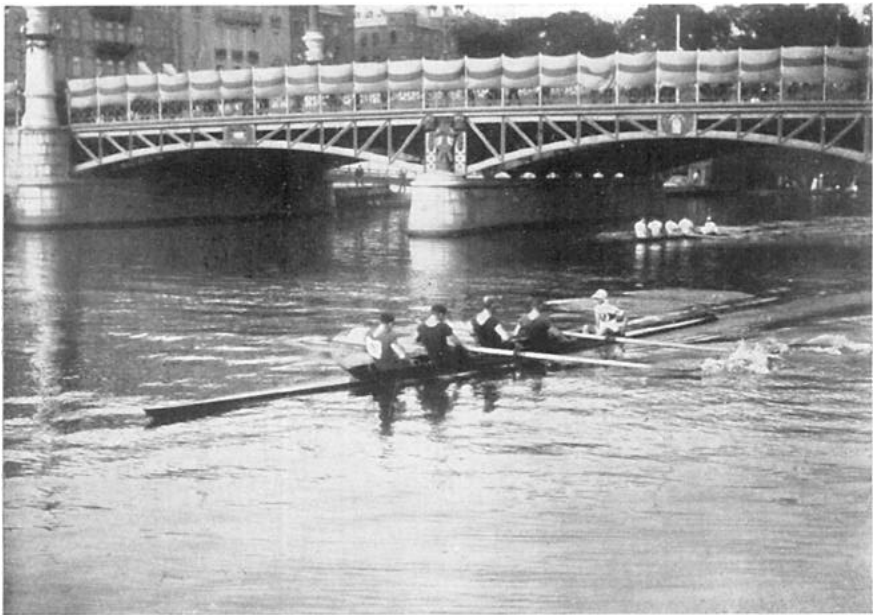

FOURS, OUTRIGGERS. FINAL. GERMANY 1:st prize.
Under the bridge: THAMES R. C.

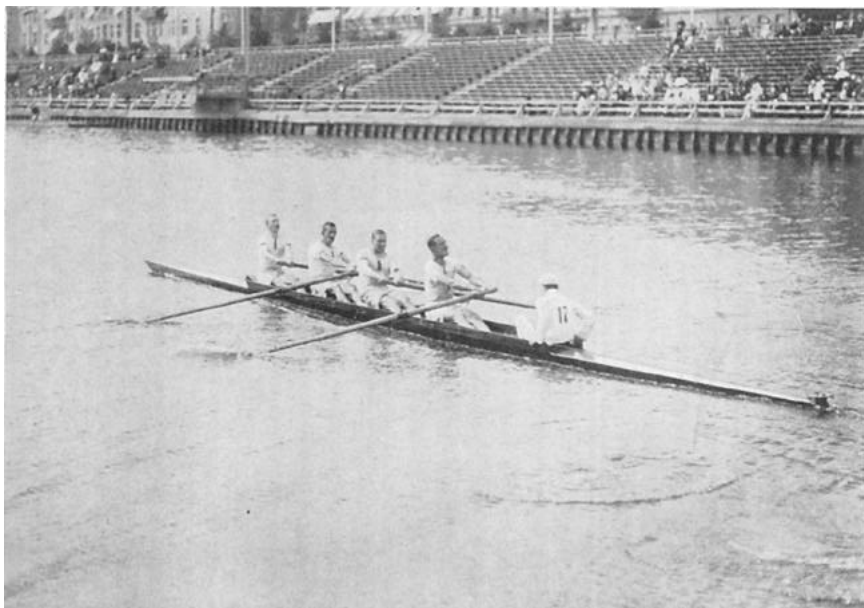

FOUR SOUTRIGGERS. THAMES ROWING CLUB, 2:nd prize.



FOURS, INRIGGERS. DENMARK leading.



FOURS, INRIGGERS. SWEDEN beating ORMSUND, NORWAY.

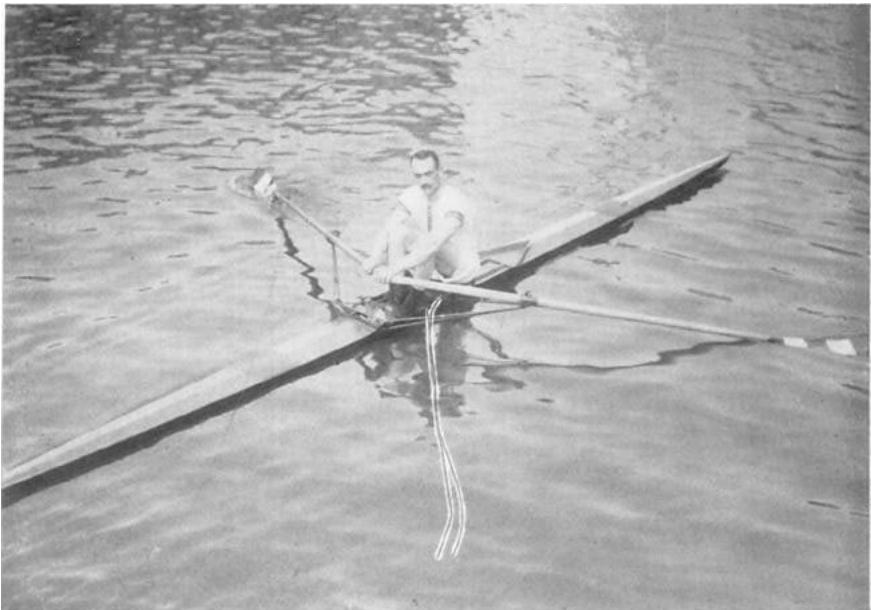

SINGLE SCULLS. P. VEIRMAN, Belgium, 2:nd prize winner.

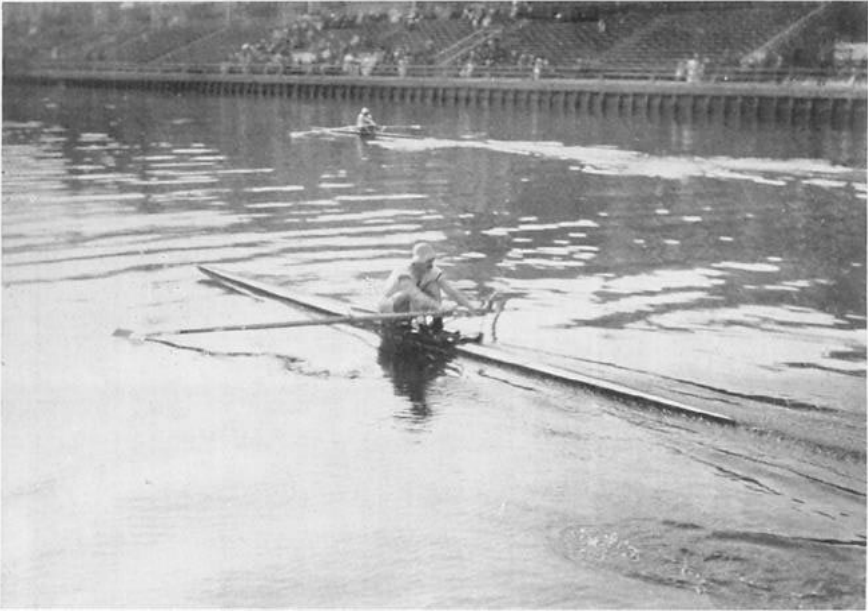

SINGLE SCULLS. W. D. KINNEAR, Great Britain (leading) v. P. V EIRMAN, Belgium.

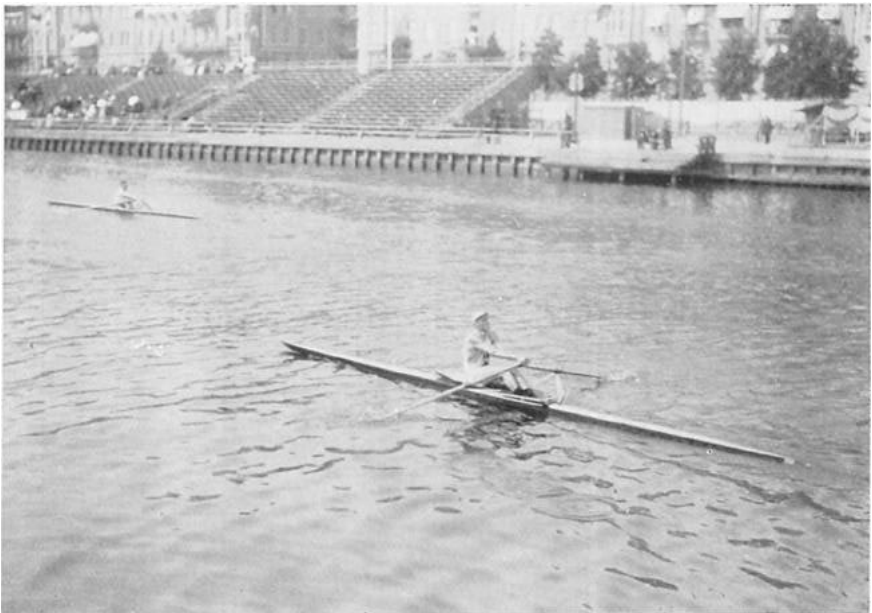

SINGLE SCULLS. W. D. KINNEAR (leading) v. E. B. BUTLER, Canada.

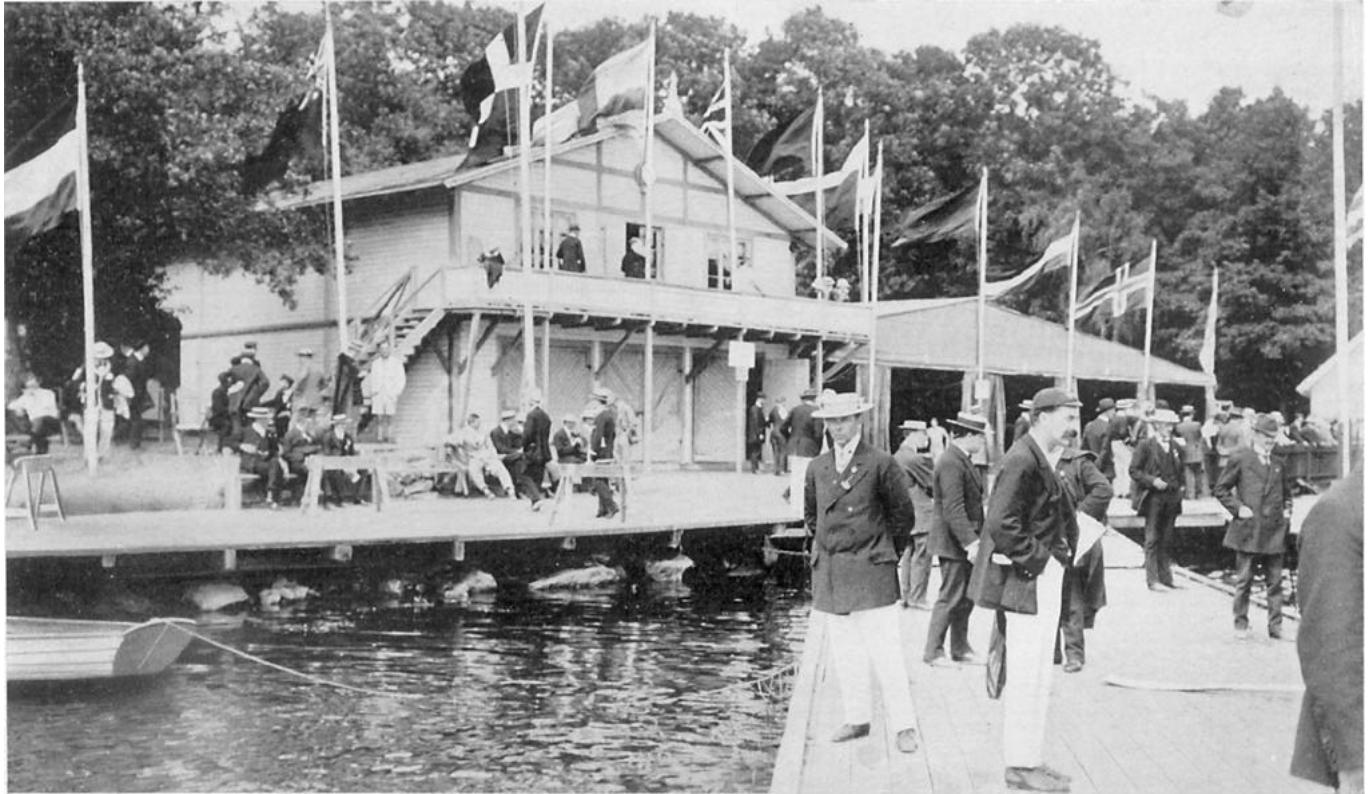

STOCKHOLM ROWING CLUB'S BOAT-HOUSE.

victory was greeted by everyone — not least by its Swedish opponents — with hearty cheers. Time 7.47.

This closed the second day's programme.

SINGLE SCULLS.

First Round.

Wednesday, 17 July

Heat 1. 3 p.m.

	RUSSIA		AUSTRIA
M. Kusik		A. Heinrich	
	D.		L.

The Russian led at the start, but after the 300 met. mark he crossed over and took Heinrich's water without being a clear length ahead, and a collision was only hindered by the Austrian ceasing to row for a moment. Heinrich went on with the race, however, but finished several lengths behind Kusik. A protest being entered by the Austrian, the referees decided that the race should be re-rowed the following forenoon.

Heat 2. 3.20 p.m.

	GERMANY		AUSTRALASIA
M. Stahnke		C. MC Villy	
	L.		D.

The Australian took the lead, but steered a course that brought his boat into collision with Stahnke's. The German stopped rowing for a moment, but continued the race. MC Villy finished several lengths in front of his opponent, but was disqualified on the foul. Time 8.05.

Heat 3. 3.40 p.m.

	CANADA.		FINLAND
E. B. Butler		A. M. Haglund	
	L.		D.

The Canadian at once went away from his opponent and, rowing the course in good style, won by several lengths. Time 7.55.

Heat 4. 4 p.m.

	GREAT BRITAIN		GERMANY
W. D. Kinnear		K. Hoffman	
	L.		D.

Both men rowed side by side, the German at a little quicker stroke than the Englishman, the latter, however, not beginning to show his real form until he reached the bath-house. At this point, Kinnear went ahead and kept his lead, which, at the finish, amounted to about $1\frac{1}{2}$ length. Hoffman rowed very energetically and fought out the race to a finish. Time 7.44.

Heat 5. 4.20 p. m.

	BOHEMIA		HUNGARY
Ivan Schweiser		Joseph Mészáros	
	L.		D.

The Hungarian was quite the better man, and won as he liked. Time 8.29.

Heat 6. 4.40 p.m.

DENMARK		BOHEMIA	
M. Simonsen	L.	J. Sourek	D.

The Dane was of higher class than his opponent, whom he distanced so thoroughly that the latter found it best to retire at Djurgård Bridge. Time 8.14.

Heat 7. 5 p. m.

HUNGARY			
K. Leviczky	L.	W. O.	

Leviczky covered the course alone, Mc Culloch (Gr. Britain) not starting. Time 8.05.

Heat 8. 5.20 p. m.

BELGIUM			
Polydor Veirman		W. O.	

The Belgian rowed in beautiful style. Time 7.59.

Second Round.

Thursday, 18 July.

Heat 1. 11 a. m.

BELGIUM		HUNGARY	
Polydor Veirman	D.	Joseph Mészáros	L.

About 300 met. after the start, the Hungarian crossed over and, on Veirman's protest, the race was re-rowed from the beginning, Mészáros finishing alone in 8 min. 23 sec. Mr. Appeltoft, the umpire, took steps to have the race re-rowed in the evening at 7.50. On this occasion Veirman took the lead and at the 500 met. mark, was 2 lengths ahead, this lead being increased to 3 lengths at the kilometre mark. Mészáros increased his pace during the latter part of the race, but was never dangerous. Time 7.52.

Heat 2. 11.20 a. m.

CANADA			
E. B. Butler.		W. O.	

Butler covered the course alone, M. Simonsen (Denmark) not starting. Time 7.39.

At 11.40 a. m. M. Kusik, Russia and A. Heinrich, Austria, re-rowed their heat. The first named was very energetic from the start and, at the 500 met. mark was a length ahead, but at the bath-house Heinrich had drawn level. Kusik then spurted and Heinrich was unable to respond, and soon after retired from the race, after the Russian had left him a couple of lengths behind. Time 7.56.

Heat 3. 12 noon.

GERMANY		GREAT BRITAIN	
M. Stahnke	D.	V. D. Kinnear	

Kinnear took the lead and kept it all the way. At 1,500 met. he was 4 lengths in front, and won easily in 7.49. Kinnear's style was vastly superior to

that of any of his opponents, his long, powerful strokes and elegant recovery being greatly admired.

Heat 4. 7. p. m.

	RUSSIA		HUNGARY
M. Kusik		K. Leviczky	
	D.		L.

Kusik gave an example of beautiful rowing and got a length's lead at the very start, his opponent seeming unable to use his slide properly. At 500 met. the Russian led by a couple of lengths, which had increased to three at the finish. Time 7.45.

Semi-Finals.

Friday, 19, July.

Heat 1. 12.30 p. m.

	BELGIUM		RUSSIA
Polydor Veirman		M. Kusik	
	L.		D.

Both oarsmen were very high class, Veirman being a trained, powerful rower, while the Russian has a beautiful style and great energy.

The two men kept very close together, rowing from 26-28, and there was nothing to choose between them when half the course had been covered. Veirman's long powerful strokes and good finish, gave him a speed, however, which the Russian was able to follow only with very great exertion, although he succeeded in keeping up with his opponent. At the bath-house the result was still uncertain and, going under the bridge, Veirman, was only half a length in front. All Kusik's efforts in the finish were of no avail, however, against the Belgian's greater physical resources, which, at this point, were of great service to the winner, who came in about $1\frac{1}{2}$ length in front of the Russian. Time 7.41.

Heat 2. 1 p. m.

	CANADA		GREAT BRITAIN
E. B. Butler		W. D. Kinnear	
	L.		D.

This was the most exciting of all the single sculls heats. After the start, when the Canadian rowed a somewhat quicker stroke than his opponent, the two men kept together all the way to the bath-house when both began to spurt, Kinnear in order to get away from his rival, and the latter, who had the outside curve, so as not to be distanced and thus lose the advantage given by his position at Djurgård Bridge. The result was that both men, rowing at a great rate, passed under the bridge simultaneously, but Kinnear's greater physical power did him yeoman's service in the finish and he won by about a length. Time 7.37.

Final.

Friday, 19, July.

5 p. m.		GREAT BRITAIN		BELGIUM
	W. D. Kinnear		Polydore Veirman	
		L.		D.

Veirman started with a long, energetic spurt and, at the 500 met. mark, led by about half a length. Kinnear's long stroke, with its masterly recovery, brought the representative of Great Britain level with the Belgian oarsmen at the kilometre mark, and very soon afterwards Kinnear was a length ahead. All the efforts of the Belgian were fruitless, and Kinnear won safely in $7.47\frac{3}{5}$.

* * *

Unfortunately, little attention was paid by the public to the Olympic Rowing competitions, which, however, were the best of their kind hitherto seen. The reason of this is probably to be found in the fact, that the many preceding days of the Olympic Games, crowded as they were with exciting events, had fatigued the public, which, at the period when the rowing competitions began, had been filled to repletion with first-class sporting events.

There was a very pleasant conclusion to the Olympic Rowing Regatta at Hasselbacken on the 20 July, when all the oarsmen and representatives of clubs from abroad, together with all the Swedish competitors and officials taking part in the Regatta, were invited to a banquet given by the Olympic Rowing Committee.

* * *

According to the official system of counting points, the relative position of the nations taking part in the rowing competitions was as follows :

Nation	1:st Prize	2:nd Prize	Points
Great Britain	2	2	10
Germany	1	—	3
Denmark ..	1	—	3
Sweden	—	1	2
Belgium	—	1	2

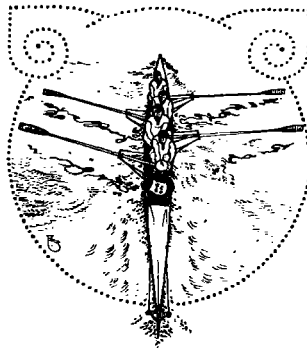

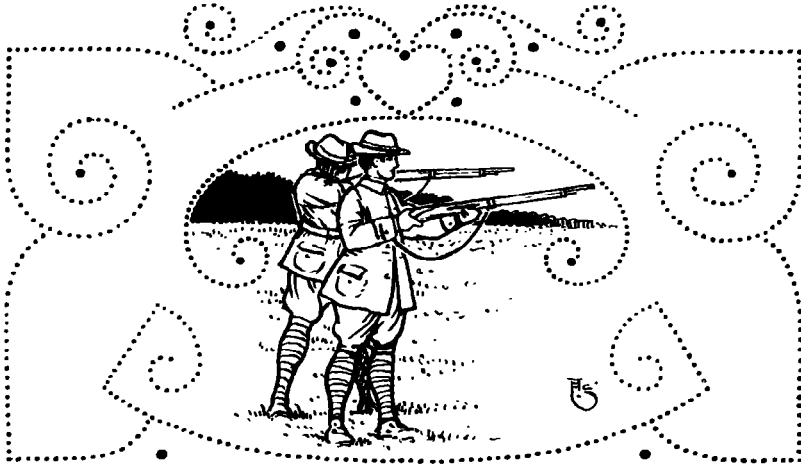

SHOOTING.

SHOOTING COMMITTEE.

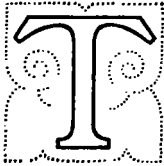

he Olympic Games' Sub-Committee for Shooting was elected in May, 1910. Altogether, it held 21 official meetings, in addition to which, several sub-committees were entrusted with the carrying out of a considerable amount of work, chiefly of a preparatory and investigatory nature. The composition of the chief Shooting Committee was as follows:

- President:* Colonel, Count C. E. TAUBE.
- Vice-President:* F. BJÖRKENSTAM, Esq., Master of the Hounds
to His Majesty.
- Secretary:* G. C. BOIVIE, Esq.
- Other members:* ... P. O. ARVIDSSON, Esq.,
E. BENEDICKS, Esq.,
Lieut. E. CARLBERG,
F. FAGRELL, Esq.,
M. N. HALLMAN, Esq.,
E. W. LINDEWALD, Esq.,
E. MELIN, Esq.,
Captain, Baron S. RÅLAMB,
Major O. SJÖGREEN,
A. SWAHN, Esq.,
O. G. SWAHN, Esq.,
- Deputy members:* ... J. E. EKMAN, Esq.
Baron AXEL KLINCKOWSTRÖM.

PROGRAMME AND RULES FOR THE COMPETITION.

The chief work of the Shooting Committee was the drafting of the programme of the shooting competitions — a task which proved to be by no means one easy of solution, for it was necessary to make a list which, without being too heavy, did everything possible to satisfy the various wishes and tastes of the nations taking part in the competition; the requirements just mentioned being, necessarily, widely different both as regards their nature and character.

However, after the Committee had determined to follow, in the main, the arrangements made for the English Shooting-Programme at the Olympic Games of London 1908, which had, with honour, stood the test they were then put to, and had proved capable of satisfying all reasonable claims, it was felt that firm ground, so to say, had been reached. In accordance with this principle, then, the Shooting programme was divided into the 3 following principal groups:

- I. *Shooting with army rifle, and shooting with any rifle;*
- II. *Miniature-rifle shooting; revolver and pistol-shooting;*
- III. *Clay Bird shooting and Running Deer shooting.*

There still remained, however, a great deal to do before the programme, as a whole, with all the rules for the competitions and other detailed regulations, could be fully drawn up, in consequence of the desire, briefly mentioned above, to satisfy, as far as possible all the various wishes and points of view which the shooting clubs, etc., abroad, kept sending in to the Committee, and which gave rise to very extensive correspondence. The work progressed in spite of all this, however, and so quickly that, in December 1910, it was possible to issue the programme, printed in Swedish, English, German and French.

SPECIAL ARRANGEMENTS FOR SHOOTING RANGES, ETC.

Besides this, the Shooting Committee had a great number of other tasks, of the character of which it is not necessary to give any detailed account here. It will be enough to state that various arrangements, repairs and work of various kinds were carried out at the ranges at Kaknäs, for the competitions in shooting with army rifles of any type, at distances from 200-600 metres. The Committee was also obliged to procure a suitable place for the competitions in miniature-rifle shooting, and revolver and pistol-shooting, as there existed no range for these types of competition. After a spot, excellently suited for the purpose, had been chosen at Brunsängen in the north part of the Kaknäs district, and permission to use the place in question having been obtained, it was then necessary to enclose the ground

and to take all other needful steps, such as the construction of shooting-butts, the erection of target holders and protected huts for the markers, etc.

What has been said above respecting the preparations for shooting with miniature-rifles and pistols, holds good, too, for the clay-bird and running-deer shooting, and the Committee was obliged to put in order grounds close to Råsunda, one of the northern suburbs of Stockholm.

THE COMPETITIONS.

Shooting with Army-Rifle.

The Chief Committee of the Swedish Shooting Association and the Shooting Competitions of the Olympic Games.

In consequence of a communication received from the Swedish Olympic Committee for the Olympic Games of Stockholm, 1912, the Chief Committee of the Swedish Shooting Association, at its annual spring meeting, 29—30 April, 1910, determined that the Volunteer Shooting Association should take part in the competitions in army-rifle shooting at the Olympic Games, and commissioned its Executive to appoint a special committee for the purpose of drawing up a plan for a shooting-programme, which the Chief Committee was then to discuss at its autumn meeting.

The Chief Committee of the Shooting Association stated that it was desirable to have the international competitions arranged as much as possible in accordance with the conditions obtaining in Sweden, and that Swedish national competitions should also be held.

At its autumn meeting in 1910, the Chief Committee of the Shooting Association approved of the sub-committee's scheme for the programme for the army-rifle shooting competitions at the Olympic Games of 1912, and commissioned its Executive to take measures for the selection of the members of the Association to represent Sweden in the events in question.

In addition to this, it was proposed that a petition should be presented to the King-in-Council, begging for a government-grant to cover the expenses of the practice-shooting.

Rifle-Shooting Committee.

The Executive Committee of the Shooting Association appointed the following gentlemen to be members of the sub-committee which was to draw up the scheme for a programme for the army rifle shooting competitions at the Olympic Games, 1912:

President: Colonel, Count C. E. TAUBE,
Lieut-Col. E. O. ALMQUIST, Esq.,
P. O. ARVIDSSON, Esq.,
G. BOISVIE, Esq.,
Lieut. E. CARLBERG,
F. FAGRELL, Esq.,
Major C. P. O. K. SJÖGREEN.

On 3 Nov, 1910, the sub-committee sent in to the Chief Committee the scheme it had drawn up for a shooting programme, and this, as mentioned above, was approved of by the Chief Committee at its autumn meeting, 1910.

This programme differed in some essentials from those of the shooting competitions of former Olympic Games. Thus, for example, the longest range was to be only 600 metres, and, in the team competitions, great weight was placed on the use of weapons the construction of which was in agreement with the regulation model of each nation competing. In addition to this, there was to be an event which, hitherto, had been an exclusively Swedish competition.

The above-mentioned members of the sub-committee, strengthened by representatives for running deer shooting and shooting with miniature rifles and with revolvers, constituted the Shooting Committee for the Olympic Games, and, as such, had the superintendence of the shooting competitions.

Shooting Ranges.

The ranges at Stora Skuggan, near Stockholm, were available for practice before the beginning of the competitions, as were those at Kaknäs from 25 — 28 June.

The competitors took full advantage of this circumstance, especially during the days last mentioned, when, from morning till evening, the ranges at Kaknäs were occupied by competitors practising there, both Swedes and foreigners.

For the competitions, the ranges at Kaknäs had been provided with new sets of holders suitable for the international targets, and they had also been provided with new numbered targets and extra telephone communications. New butts were made at the 200 and 500 metres' ranges.

The shooting pavilion at the 300 metres' range was placed at the disposal of the Olympic Shooting Committee by the Swedish Shooting Clubs, and the store-rooms there were placed at the service of the competitors from abroad, by the same Clubs. A secretary's office was opened in a building in the neighbourhood of the large blindage.

A public telephone- and telegraph office was opened in the non-commissioned officers' quarters at Kaknäs.

During the whole of the time the competitions went on, the ranges were decorated with flags.



GROUP OF ALL THE FOREIGN AND SWEDISH OFFICIALS FOR SHOOTING.



RIFLE COMPETITIONS, KANKNÄS.



RIFLE COMPETITIONS, KAKANÄS



U. S. A. RIFLE-TEAM COMPETING.

As the ranges at Kaknäs had only 62 target holders, as compared with about 250 at Bisley Camp in 1908, the grouping of the competitors and of the various competitions had been a matter of considerable difficulty, but, by means of alternate firing, and with the assistance of sketches showing the details of the plan adopted, this difficulty was got over, so that the competitions were finished in the calculated time. Each group of competitors had its own telephone-communications.

The Arrangements for the Shooting.

Special, detailed instructions had been drawn up for the officials and competitors, stating what each one had to observe, and how the marking and registration of the results, etc., were to be carried out. These instructions were printed in English, French, German and Swedish. Each of the competitors and officials was given a copy of these instructions, thus making it possible for them to follow the course of all the competitions.

In all the events the arrangement was made, that each competitor had his own target and figure, which he had the right to claim after his results had been registered and verified.

All registration of results took place at the secretary's office. During the shooting itself, nothing else was marked but the position of the hits.

Every day, before the beginning of the shooting, lots were drawn at the office by the nations, to decide in which groups they should shoot, and then the leader of every nation, either himself alone, or after consultation with the members of his team, had to decide at which target, of those allotted to them, the individual competitors should fire their series. On the drawing of lots, each individual competitor received a card, printed in the language of his nation and stating the number of the group, of the target-stand, and of the target where the firing was to take place. By this means the leaders and the competitors could follow the course of the whole of the competition without interruption, a measure which was, naturally, calculated to inspire confidence.

The Shooting in the Competitions.

Major C. P. O. K. Sjögreen, of the First Royal Grenadier Guards, had been appointed leader of the army-rifle-shooting competitions by the Olympic Shooting Committee. Captain W. Unander, of the same regiment, acted as Major Sjögreen's adjutant. The work in the secretary's office was in charge of V. Wahlquist, Esq., Secretary of the Swedish Shooting Association, assisted by V. T. Hoffman, Esq., one of the Executive of the Shooting Committee.

The officials at the shooting ranges consisted of officers, non-commissioned officers and men, belonging to the regiments forming the garrison of Stockholm.

a) TEAM COMPETITION. DISTANCE 200, 400, 500
AND 600 METRES.

The competition was open to one team of 6 men from each nation.
2 sighters and 15 shots at each distance.

Teams from the following nations had been entered for this competition, which took place on June 29:

Denmark	France
Great Britain	Greece
Hungary	Norway
Russia	South Africa
Sweden	U. S. A.

Plac- ing	Nation	Name	200 m.	400 m.	500 m.	600 m.	Total points
1	U. S. A. 1:st prize. Gold medal.	Burdette, C. L.	74	73	71	70	288
		Briggs, A. L.	72	75	70	66	283
		Adams, H.	74	74	73	62	283
		Jackson, J. E.	71	73	69	66	279
		Osburn, C. T.	73	75	72	58	278
		Sprout, W. A.	74	74	69	59	276
		Total	438	444	424	381	1,687
2	GREAT BRITAIN ... 2:nd prize. Silver Medal.	Ommundsen, H.	74	75	69	58	276
		Burr, H. G.	70	68	68	60	266
		Skilton, E.	73	66	66	61	266
		Reid, J.	70	70	63	63	266
		Parnell, E. L.	68	70	62	66	266
		Fulton, A. G.	73	61	63	65	262
		Total	428	410	391	373	1,602
3	SWEDEN 3:rd prize. Bronze Medal.	Eriksson, M.	69	69	71	57	266
		Jemström, V.	72	68	58	64	262
		Björkman C.	71	68	64	58	261
		Björkman, T.	70	71	62	58	261
		Larsson, B.	68	70	62	61	261
		Johansson, H.	67	70	67	55	259
		Total	417	416	384	353	1,570
4	South Africa ...	Harvey, G. H.	67	65	70	56	258
		Bodley, R.	74	64	66	52	256
		Smith, A. A.	67	66	59	64	256
		Keeley, E. J.	68	69	63	55	255
		Jeffreys, C. A.	71	64	63	56	254
		Patterson, R.	68	59	72	53	252
		Total	415	387	393	336	1,531

Plac- ing	Nation	Name	200 m.	400 m.	500 m.	600 m.	Total points
5	France	Percy, L.	69	69	66	59	263
		Colas, P. R.	67	71	62	62	262
		de Boigne, G.	71	65	66	60	262
		Gentil, P.	69	70	67	51	257
		Johnson, L.	68	68	62	42	240
		Lardin, M.	61	64	54	52	231
		Total	405	407	377	326	1,515
6	Norway	Degnes, O. C. ...	70	69	64	65	268
		Sunde, A. T.	70	65	62	56	253
		Jensen O. A.	68	61	60	59	248
		Nordvik, H.	67	64	63	48	242
		Husby, O.	67	61	61	44	233
		Glommes, M.	66	58	48	57	229
		Total	408	378	358	329	1,473
7	Greece	Mavrommatis, F. D.	71	67	62	61	261
		Théophilakis A. ...	67	67	60	64	258
		Théophilakis, J. ...	67	64	65	53	249
		Levidis, N. M. ...	66	61	56	48	231
		Théophilas, J. A.	67	65	55	42	229
		Mostras, S. D. ...	52	61	58	46	217
		Total	390	385	356	314	1,445
8	Denmark	Andersen, N.	69	70	61	50	250
		Madsen, L. J. ...	70	65	63	49	247
		Friis, R.	60	59	52	47	218
		Schultz, H. K. ...	62	64	59	59	244
		Larsen, N. H. D.	69	61	55	52	237
		Haislund, J. M. ...	68	61	48	46	223
		Total	398	380	338	303	1,419
9	Russia	de Waldeine, P. ...	68	64	56	63	251
		de Kouskoff, D. ...	66	66	67	47	246
		de Lébédeff, T. ...	60	68	56	53	237
		de Waysse, D. ...	64	67	54	41	226
		de Tillo, A.	65	64	52	45	226
		de Davidoff, G. ...	62	60	60	35	217
		Total	385	389	345	284	1,403
10	Hungary.	Bömches, E. R. v. B.	63	59	59	56	237
		Prihoda, S.	70	58	57	42	227
		Velez, R.	64	63	60	39	226
		Hauler, L.	67	61	50	41	219
		Mészoly, G. v. S.	61	58	57	41	217
		v. Farkas, A.	54	54	55	44	207
		Total	379	353	338	263	1,333

b) INDIVIDUAL COMPETITION. DISTANCE 600 METRES.

5 sighters and 20 shots.

85 men from 12 nations took part in this competition, which was held on the 1 July:

Placing	Name	Nation	Points
1	COLAS, P. R. 1:st prize, Gold Medal.	FRANCE	94
2	OSBURN, C. T. 2:nd prize, Silver Medal.	U. S. A.	94
3	JACKSON, J. E. 3:rd prize, Bronze Medal.	U. S. A.	93
4	Briggs, A. L.	»	93
5	Plater, P. E.	Great Britain	90
6	Jernström, V.	Sweden	88
7	Ommundsen, H.	Great Britain	88
8	Burdette, C. L.	U. S. A.	87
9	Fulton, A. G.	Great Britain	87
10	Burr, H. G.	»	87
11	Wallenborg, C.	Sweden	87
12	Adams, H.	U. S. A.	86
13	Reid, J.	Great Britain	86
14	Sprout, W. A.	U. S. A.	85
15	Gustafsson, E.	Sweden	85
16	Skilton, E.	Great Britain	85
17	Degnes, O. C.	Norway	84
18	Parnell, E. L.	Great Britain	84
19	Bartlett, H. T.	U. S. A.	83
20	Percy, L.	France	83
21	Harvey, G. H.	South Africa	83
22	Mavrommatis, F.	Greece	82
23	Johansson, C. H.	Sweden	82
24	Sund, C. J.	»	82
25	Björkman, T.	»	81
26	Hird, L. L.	U. S. A.	81
27	Varley, F. E.	Great Britain	81
28	Ohlsson, E.	Sweden	81
29	Lagerlöf, L.	»	81
30	Sunde, A. T.	Norway	80
31	Sedgewick, J.	Great Britain	80
32	MC Donell, W. N.	U. S. A.	80
33	Richardson, P. W.	Great Britain	79
34	Théophilakis, J.	Greece	79
35	Nordvik, H.	Norway	79
36	Jonsson, R.	Sweden	79
37	Davies, R. F.	Great Britain	78
38	Eriksson, M.	Sweden	77
39	de Kalinine, C.	Russia	77
40	Skatteboe, C. G.	Norway	77
41	Refsum, T.	»	76
42	Jeffreys, C. A.	South Africa	76
43	Johnstone, F.	»	75
44	Schultz, H. K.	Denmark	75
45	de Waldaine, P.	Russia	75
46	Somers, J. P.	Great Britain	74

Placing	Name	Nation	Points
47	Helgerud, A.	Norway	74
48	Friis, R.	Denmark	74
49	Örtegren, R.	Sweden	74
50	de Boigne, R.	France	73
51	de Weyse, D.	Russia	73
52	Levidis, N.	Greece	73
53	Patterson, R.	South Africa	73
54	Bodley, R.	»	73
55	Maseng, R.	Norway	73
56	Jensen, O. A.	»	73
57	Vighals, P.	»	72
58	de Rechké, O.	Russia	71
59	de Kouskoff, D.	»	71
60	Sæther, Ole	Norway	70
61	de Davidoff, G.	Russia	70
62	de Tillo, A.	»	70
63	Marion, A.	France	69
64	Mérrillon, D.	»	69
65	de Belinsky, B.	Russia	69
66	Nyström, T. E.	Sweden	69
67	Ekwall, H. K.	Chili	67
68	Théophilakis, A.	Greece	66
69	Gentil, P.	France	65
70	de Lesche, P.	Russia	62
71	de Dobrjansky, A.	»	61
72	Alegria, F.	Chili	61
73	Velez, R.	Hungary	60
74	de Lébédéff, T.	Russia	59
75	Thielemann, L.	Norway	57
76	Farkas, A.	Hungary	56
77	de Wischniakoff, G.	Russia	56
78	von Jelenffy, Z.	Hungary	54
79	von Meszoly, G.	»	54
80	von Bömches, E. R.	»	51
81	Dulnig, J.	Austria	41
82	Bough, S. C.	Norway	40
83	Hauler, L.	Hungary	35
84	Sartori, A.	France	32
85	Théophilas, J.	Greece	13

c) INDIVIDUAL COMPETITION. DISTANCE 300 METRES.

20 shots in 2 series:

I series of 10 shots (4 lying down, 4 kneeling, and 2 standing), at precision target, 140 X 170 centimetres (54,6 + 66,3 inches) divided into 5 zones. Time limit, 3 min. 2 sighters.

I series of 10 shots (5 lying down, and 5 kneeling) at a half-figure. Time limit, 3 min. No sighters.

91 men from 12 nations competed in this event, which took place on the 1 July.

Placing	Name	Nation	Series		Total points
			prec.	Added pts.	
1	PROKOPP, A.....	HUNGARY	47	50	97
	1:st prize, Gold Medal				
2	OSBURN, C. T.	U. S. A.	45	50	95
	2:nd prize, Silver Medal				
3	SKOGEN, E. E.	NORWAY	45	50	95
	3:rd prize, Bronze Medal				
4	Levidis, N. M.	Greece	45	50	95
5	Romander, N.	Sweden	49	45	94
6	Fulton, A. G.	Great Britain	42	50	92
7	Velez, R.	Hungary	42	50	92
8	Flodström, C. E.	Sweden	46	45	91
9	Bartlett, H. T.	U. S. A.	45	45	90
10	Harvey, G. H.	South Africa	45	45	90
11	de Waldaine, P.	Russia	45	45	90
12	Adams, H.	U. S. A.	44	45	89
13	Keeley, E. J.	South Africa	44	45	89
14	Björkman, T.	Sweden	43	45	88
15	Braathé, J.	Norway	48	40	88
16	Jonsson, G. A.	Sweden	48	40	88
17	Mavrommatis, F. D.	Greece	37	50	87
18	Arvidsson, P. O.	Sweden	42	45	87
19	Jonsson, R.	»	46	40	86
20	Stridfeldt, P. A.	»	46	40	86
21	Ohlsson, E.	»	46	40	86
22	Colas, P. R.	France	46	40	86
23	Percy, L.	»	40	45	85
24	von Farkas, A.	Hungary	40	45	85
25	Briggs, A. L.	U. S. A.	45	40	85
26	de Wischniakoff, G.	Russia	39	45	84
27	Hauler, L.	Hungary	39	45	84
28	Hird, F. L.	U. S. A.	49	35	84
29	von Mészoly, G.	Hungary	43	40	83
30	de Lésche, P.	Russia	48	35	83
31	Mc Donnell, W. N.	U. S. A.	42	40	82
32	Dulnig, J.	Austria	42	40	82
33	Jackson, J. E.	U. S. A.	42	40	82
34	Jeffreys, C. A.	South Africa	47	35	82
35	Glomnes, M.	Norway	47	35	82
36	Schultz, H. K.	Denmark	47	35	82
37	Sprout, W. A.	U. S. A.	41	40	81
38	Sedgewick, J.	Great Britain	41	40	81
39	Davies, R. F.	»	41	40	81
40	Nyström, T. E.	Sweden	46	35	81
41	Jordell, J. O.	Norway	35	45	80
42	de Lébédeff, T.	Russia	40	40	80
43	Ekwall, H. K.	Chili	45	35	80
44	Sunde, A. T.	Norway	45	35	80
45	Bodley, R.	South Africa	38	40	78
46	de Belinsky, B.	Russia	38	40	78
47	de Rechké, O.	»	43	35	78
48	Alegria, F.	Chili	42	35	77
49	de Kouskoff, D.	Russia	42	35	77
50	Varley, F. E.	Great Britain	31	45	76
51	de Tillo, A.	Russia	46	30	76
52	Burdette, C. L.	U. S. A.	40	35	75

Placing	Name	Nation	Series		Total points
			prec.	Added pts.	
53	Jernström, V.	Sweden	40	35	75
54	Somers, J. P.	Great Britain	40	35	75
55	Helgerud, A.	Norway	45	30	75
56	Parnell, E. L.	Great Britain	45	30	75
57	Lloyd, L. N.	»	39	35	74
58	de Boigne, R.	France	28	45	73
59	Patterson, R.	South Africa	37	35	72
60	de Weyse, D.	Russia	42	30	72
61	Gentil, P.	France	36	35	71
62	Skjerven, H. N.	Norway	41	30	71
63	Larsen, N. H. D.	Denmark	35	35	70
64	Hoflund, J. A.	Sweden	40	30	70
65	Richardson, P. W.	Great Britain	34	35	69
66	von Bömches, E.	Hungary	39	30	69
67	Théophilakis A.	Greece	39	30	69
68	de Davidoff, G.	Russia	38	30	68
69	MC Clure, W.	Great Britain	38	30	68
70	Lardin, M.	France	42	25	67
71	de Dobrjansky, A.	Russia	31	35	66
72	Théophilas, J. A.	Greece	41	25	66
73	Whelan, G.	South Africa	34	30	64
74	Gerlow, P.	Denmark	44	20	64
75	Théophilakis, J.	Greece	33	30	63
76	Thielemann, L.	Norway	32	30	62
77	Johnstone, A. E.	South Africa	37	25	62
78	Mérillon, D.	France	37	25	62
79	de Kalinine, C.	Russia	42	20	62
80	Bjerke, O. G.	Norway	41	20	61
81	Espelund, J.	»	30	30	60
82	Lie, B.	»	44	15	59
83	Wallenborg, C.	Sweden	36	20	56
84	Smith, A. A.	South Africa	36	20	56
85	Prihoda, S.	Hungary	29	20	49
86	Plater, P. E.	Great Britain	34	15	49
87	von Jelenffy, Z.	Hungary	33	15	48
88	Mostras, S. D.	Greece	19	25	44
89	Weydahl, C.	Norway	25	15	40
90	Sartori, A.	France	23	15	38
91	von Daranyi, A.	Hungary	7	5	12

d) TEAM COMPETITION. DISTANCE 300 METRES.

International Target,

Teams of 6, with max. 3 reserves. 120 shots (40 standing, 40 kneeling, and 40 lying down). 10 sighters in each position.

The following nations took part in this competition, which was held on the 4 July:

Denmark	Finland
France	Norway
Russia	Sweden
South Africa.	

Placing	Nation	Name	Stand- ing	Kneel- ing	Lying	Total points
1	SWEDEN 1:st prize, Gold Medal.	Eriksson, M.	291	339	346	976
		Johansson, C. H.	294	335	346	975
		Blomqvist, E.	274	345	343	962
		Björkman, C.	306	308	340	954
		Larsson, B.	277	298	339	914
		Jonsson, G. A.	286	288	300	874
		Total	1,728	1,913	2,014	5,655
2	NORWAY 2:nd prize, Silver Medal.	Skatteboe, G.	283	315	347	945
		Sæther, Ole	278	325	342	945
		Östensen, Ö.	278	322	340	940
		Helgerud, A.	296	312	330	938
		Sæther, Olof	291	316	328	935
		Liberg, E.	271	295	336	902
		Total	1,697	1,885	2,023	5,605
3	DENMARK 3:rd prize, Bronze Medal.	Olsen, O.	301	329	353	983
		Madsen, L. J.	327	335	311	973
		Larsen, N. H. D. ...	295	319	317	931
		Andersen N.	281	302	313	896
		Larsen, L. T. K.	280	282	328	890
		Haislund, J. M.	286	278	292	856
		Total	1,770	1,845	1,914	5,529
4	France	Colas, P.	308	331	365	1,004
		Percy, L.	267	313	351	931
		Johnson, L.	303	305	300	908
		Gentil, P.	278	301	320	899
		de Boigne, R.	239	309	326	874
		Marion, A.	255	280	320	855
		Total	1,650	1,839	1,982	5,471
5	Finland	Kolho, V. V.	306	308	337	951
		Huttunen, H.	287	321	338	946
		Nyman, G. R.	287	306	304	897
		Holm, E.	248	270	327	845
		Tuiskunen, Hj.	273	267	304	844
		Vauhkonen, V.	250	279	311	840
		Total	1,651	1,751	1,921	5,323
6	South Africa ...	Harvey, G. H.	229	309	349	887
		Bodley, R.	225	290	342	857
		Patterson, R.	223	271	345	839
		Smith, A. A.	219	270	332	821
		Keeley, E. J.	207	305	300	812
		Whelan, G.	135	234	312	681
		Total	1,238	1,679	1,980	4,897

Placing	Nation	Name	Stand- ing	Kneel- ing	Lying	Total points
7	Russia	de Waldaine, P.	260	288	312	860
		de Lébédéff, Th.....	254	256	317	827
		de Tillo, A.	261	264	297	822
		de Kalinine, C.	252	265	286	803
		de Kouskoff, D.	236	280	295	811
		de Lesche, P.	242	259	268	769
Total			1,505	1,612	1,775	4,892

e) INDIVIDUAL COMPETITION. DISTANCE 300 METRES AT INTERNATIONAL TARGET.

120 shots (40 standing, 40 kneeling and 40 lying down). 10 sighters in each position.

The competition was held on the 2 July. 84 men from 9 nations competed.

Placing	Name	Nation	Stand- ing	Kneel- ing	Lying	Total points
1	COLAS, P. R. 1.st prize, Gold Medal.	FRANCE	283	342	362	987
2	MADSEN, L. J. 2.nd prize, Silver Medal.	DENMARK	318	333	330	981
3	LARSEN, N. H. D. 3.rd prize, Bronze Medal.	DENMARK	273	334	355	962
4	Johansson, C. H.	Sweden	292	326	341	959
5	Skatteboe, C. G.	Norway	305	308	343	956
6	Larsson, B.	Sweden	274	339	341	954
7	Helgerud, A.	Norway	281	317	354	952
8	Björkman, T.	Sweden	285	322	340	947
9	Sæther, Ole.	Norway	276	316	349	941
10	Blomqvist, E.	Sweden	269	326	337	932
11	Jonsson, G. A.	»	275	316	337	928
12	Olsen, O.	Denmark	315	291	320	926
13	Kolho, V. V.	Finland	290	313	320	923
14	Eriksson, M.	Sweden	276	316	330	922
15	Liberg, E.	Norway	275	316	330	921
16	Tauson, H. C.	Denmark	263	324	334	921
17	Osbum, C. T.	U. S. A.	278	300	337	915
18	Sæther, Olof.	Norway	304	299	311	914
19	Nyman, G. R.	Finland	302	289	322	913
20	Jernström, V.	Sweden	265	315	332	912
21	Burdette, C. L.	U. S. A.	263	300	349	912
22	Vighals, P.	Norway	264	318	329	911
23	Östensen, O.	»	270	308	333	911
24	Johnson, L.	France	270	298	340	908
25	Huttunen, H.	Finland	290	298	318	906
26	Refsum, Th.	Norway	294	306	305	905
27	Husby, Olof.	»	263	307	335	905
28	Adams, H.	U. S. A.	246	297	360	903
29	Braate, J.	Norway	289	292	319	900

Placing	Name	Nation	Stand- ing	Kneel- ing	Lying	Total points
30	Sunde, A. T.	Norway	282	304	314	900
31	Skogen, E. E.	»	279	286	334	899
32	Sprout, W. A.	U. S. A.	270	299	327	896
33	Larsen, L. T. K.	Denmark	300	277	317	894
34	Björkman, C.	Sweden	239	308	341	888
45	Briggs, A. L.	U. S. A.	239	308	341	888
36	Bartlett, H. T.	»	238	293	353	884
37	Jonsson, R.	Sweden	260	290	325	875
38	Hird, F. L.	U. S. A.	227	326	322	875
39	Tuiskunen, H. H. ...	Finland	264	322	289	875
40	Harvey, G. H.	South Africa ...	240	288	346	874
41	Vauhkonen, V.	Finland	281	285	304	870
42	Wikström, O. A.	Sweden	266	291	313	870
43	Skog, N. J.	»	225	315	329	869
44	Percy, L.	France	245	314	309	868
45	Marion, A.	»	254	303	311	868
46	Nielsen, F.	Denmark	268	290	293	851
47	Nielsen, A. P.	»	244	292	313	849
48	Arvedsson, P. O.	Sweden	245	279	315	839
49	Holm, E.	Finland	243	280	312	835
50	Bömches, E. R.	Hungary	220	282	326	828
51	Patterson, R.	South Africa ...	205	277	328	810
52	Schultz, H. K.	Denmark	236	296	276	808
53	de Boigne, R.	France	203	285	318	806
54	de Lébédoff, Th.	Russia	243	274	289	806
55	Bodley, R.	South Africa ...	150	310	346	806
56	Keeley, E.	»	188	289	323	800
57	Kolho, L.	Finland	238	265	284	787
58	de Kouskoff, D.	Russia	228	269	283	780
59	Autonen, I. U.	Finland	211	279	286	776
60	Gerlow, P.	Denmark	233	256	283	772
61	Whelan, G.	South Africa ...	185	242	335	762
62	de Waldaine, P.	Russia	204	260	294	758
63	Sartori, A.	France	193	258	303	754
64	Smith, A. A.	South Africa ...	176	252	324	752
65	de Belinsky, B.	Russia	201	261	284	746
66	de Tillo, A.	»	251	232	261	744
67	Johnstone, A.	South Africa ...	181	228	332	741
68	de Kalinine, C.	Russia	231	254	251	736
69	Jelenffy, Z.	Hungary	187	241	290	718
70	Jeffreys, C. A.	South Africa ...	166	207	342	715
71	de Lésche, P.	Russia	186	254	273	713
72	Velez, R.	Hungary	183	240	289	712
73	de Reschke, O.	Russia	170	252	277	699
74	Hauler, L.	Hungary	162	250	265	677
75	von Farkas, A.	»	154	238	261	653
76	de Davidoff, G.	Russia	177	207	251	635
77	de Weyse, D.	»	181	293	249	623
78	de Dobrjansky, A.	»	149	199	165	463
79	Denver, H. P. C. ...	Denmark	277	265	—	Retired
80	Toivonen, N.	Finland	252	207	—	»
81	Prihoda, S.	Hungary	134	—	—	»
82	Gentil, P.	France	231	—	—	»
83	Haislund, J. M.	Denmark	226	—	—	»
84	von Mészoly, G.	Hungary	84	—	—	»

It was, undeniably, with a certain amount of hesitation that Sweden entered into competition with the chosen marksmen from nations that, for many years had been accustomed to take part in international shooting competitions.

The results showed, however, that, on the whole, these fears were groundless, the Swedish competitors going through the trial with honour. This was especially, the case, in the great trial of skill in the international shooting d), where the Swedish group was successful.

When permitted, the competitors from abroad employed rifles of varying models, specially constructed for shooting at stationary targets, and even in the cases when the army model of the respective countries was prescribed, rifles were employed with arrangements which could not be described as service ones. The Swedish competitors, in *every* competition, used the regulation military arm of their country. As a rule, they shot very evenly and, consequently, in the greater number of the competitions they had the highest average points.

It may be pointed out that, as shooting-practice with the national military rifle has for its chief object the creation of good marksmen for national defence, it would be desirable in coming international shooting competitions for such events as those in question to be held exclusively with the regulation army rifles of the various countries, which should be used without any alteration or addition. As these shooting competitions are arranged at present, they appear to be of very little importance for the training of a nation in shooting, aiming as they do at deciding championships of the world, and at exhibition shooting.

As regards the Swedish Volunteer Shooting Movement, it was a great pleasure to find that the competitors from our country, by their level shooting, and by the skill with which they employed their national army weapon under very varying conditions during the competitions, show that they can be considered as good exponents of the way in which the shooting movement in Sweden is carried on, a circumstance that attracted the attention of visitors from abroad.

Shooting with miniature-rifles, revolvers and pistols.

These competitions took place at a shooting-ground specially arranged for the purpose in the northern part of the Kaknäs field, just to the east of Stockholm. The leader of the competitions was Captain, Baron Stig Rålamb, who was assisted by Second Lieutenants, N. G. K. Bildt and C. H. Adelborg.

The greater number of the competitors from abroad had arrived some days before June 29, on which date the competitions began, this giving them a welcome opportunity of practising at the ranges, a fact that proved to be of great service to the men, especially in the case of the competitors in the duel-shooting event.

For the purpose of making certain changes for the better in the arrangements, the order of the events, as given in the programme of the competitions, was reversed, so that the revolver and pistol shooting came first, viz., on the 29 June and July 1 and 2, after which came the shooting with miniature rifles, on the 3, 4 and July. On the whole, the meeting was favoured with beautiful weather, it being only on the first two days that the competitors were troubled a little by rain and wind.

f) TEAM COMPETITION, MINIATURE=RIFLE
SHOOTING, DISTANCE 50 METRES.

Wednesday, 3 July.

Rifle: Any breech-loading rifle, with calibre not exceeding 6 mm., using miniature ammunition intended for competition. Any back- and fore-sight, except magnifying or telescopic.

Position: Any, without artificial rest.

Target: white with black centre.

Number of shots: 40 shots in 8 series, with 5 shots in each series. 4 sighters.

The competition was open to one team of four men from each nation.

The highest possible number of points for the individual competitor was 200 and, thus, for the team, 800.

When the entries closed, 8 nations had signified their intention of taking part in the competition. Of these, two (Russia and Hungary) withdrew, so that six teams took part in the event, the placing being as follows:

Nation	N a m e	Ind points scored by compe- titor	Ind points scored by team	Remarks
GREAT BRITAIN	W. E. Pimm	193	762	1st prize Gold medal
»	E. I. Lessimore	192		
»	I. Pepe	189		
»	W. Cf. Murray	188		
SWEDEN	G. Nordensvan	190	748	2nd prize Silver medal
»	E. Carlberg	189		
»	R. Ortegren	185		
»	W. Carlberg	184		
U. S. A.	V. A. Sprout	193	744	3rd prize Bronze medal
»	V. T. Leushner	188		
»	F. S. Hird	185		
»	C. T. Osburn	178		
France	L. Johnson	189	714	
»	P. Gentil	183		
»	A. Regaud	180		
»	M. Lardin	162		

Nation	N a m e	Tot. points scored by competitor	Tot. points scored by team	Remarks
Denmark	F. Gerlow	185		
»	L. J. Madsen	180		
»	Fr. Nielsen	177		
»	H. P. C. Denver	166	708	
Greece	J. Théophilakis	184		
»	J. Théophilas	177		
»	Fr. Mavrommatis	174		
»	N. Levidis	173	708	

Both on this and the following days of the competitions there prevailed the finest weather imaginable; almost too fine, one is tempted to say, for the sunshine was quite blinding in its brilliancy, a fact that could hardly have been to the benefit of the shooting. The victory of the British team might almost have been anticipated, for this sort of shooting has long been popular in England. The British team shot very evenly and well, the members of the team having an average of

There was a long and interesting struggle between the U. S. A. and Sweden for second place. The result was long in doubt, but the Swedish team won at last, though by a very narrow majority.

g) INDIVIDUAL COMPETITION WITH MINIATURE=RIFLE. DISTANCE 50 METRES.

Thursday, 4 July.

The regulations for the competition were the same as in the preceding event.

Entries had been made by 11 nations, the names of 83 competitors having been sent in, of which number 41 took part in the competition. They were placed as follows:

N a m e	Nation	Tot. points reached by competitor	Remarks
1. F. S. HIRD	U. S. A.	194	1st prize Gold medal
2. W. MILNE.....	Great Britain..	193	2nd » Silver medal
3. H. BURT.....	Great Britain..	192	3rd » Bronze medal
4. L. E. Lessimore	»	192	
5. T. W. Kemp.....	»	190	
6. R. C. Murray.....	»	190	
7. W. F. Leushner	U. S. A.	189	
8. E. Boström.....	Sweden	189	
9. H. von Holst.....	»	189	
10. W. J. Pimm	Great Britain.	189	
11. A. Wahlstedt.....	Sweden	187	
12. W. A. Sprout	U. S. A.	187	
13. C. T. Osburn	»	187	

N a m e	Nation	Total points reached by compe- titor	Remarks
14. I. Pepé	Great Britain...	187	
15. F. Nyström	Sweden	187	
16. A. Nordensvan	»	186	
17. E. Carlberg	»	186	
18. W. N. Mc Donell	U. S. A.	186	
19. R. Ortegren	Sweden	186	
20. E. A. Johansson	»	185	
21. W. Carlberg	»	185	
22. R. Löfman	»	185	
23. E. L. Andersson	U. S. A.	185	
24. D. J. Griffiths	Great Britain...	184	
25. N. Levidis	Greece	181	
26. F. Nielsen	Denmark	180	
27. W. W. Styles	Great Britain...	179	
28. E. A. Odelberg.....	Sweden	179	
29. L. Hauber	Hungary.....	178	
30. H. T. Sunde	Norway	176	
31. A. T. Török von Mura	Hungary.....	174	
32. J. Théophilakis	Greece	173	
33. A. Dobrjansky	Russia	172	
34. Fr. D. Mavrommatis...	Greece	172	
35. J. O. Jordell	Norway	172	
36. V. de Potékine	Russia	170	
37. J. A. Théophilas	Greece	167	
38. P. Gerlow	Denmark	167	
39. G. Ericsson	Sweden	157	
40. R. Maseng.....	Norway	156	
41. A. Regaud	France	125	

In this competition, too, the palm must, unconditionally, be given to the British team. It is true that an American, Hird, succeeded in placing himself first, with 194 points, but then followed a compact majority of five Englishmen in succession, with 193, 192, 192, 190 and 190 — undeniably a very good piece of work. In connection with this competition, some words should be said with regard to the target used for the miniature-rifle shooting events at 50 metres (Fig. 6 in Rules for Shooting Competitions).

The model was obtained from England, and was the same as that used at the Olympic shooting competitions in London, in 1908. As can be seen by the figure, the distance between the zones is very irregular, the result of which is, that the calculation of the points does not give a perfectly fair idea of the real value of the hits. When it is a question of determining the value of the hits in shooting at a stationary target in general, care should be taken, of course, to have the mean distance of the hits from the centre given as exactly as possible, and, as a rule, this is done best by calculating in centimetres. In the competitions now in question, it would have been preferable to have employed a target that was measured off in centimetres, when, in order to obtain the exactest valuation possible of the hits, a calculation should have been made in millimetres of the

total distance of all the hits from the centre, a procedure that would not have taken any great length of time, nor have caused any great amount of trouble.

**h) TEAM COMPETITION WITH MINIATURE=RIFLE.
DISTANCE 25 METRES.**

3 p. m. Friday, 5 July.

The regulations were as in the preceding event.

The competition was open to one team of four men from each nation.

Seven nations had entered a team, Denmark, France and Hungary withdrawing from the competition, however. The remaining teams were placed as follows:

Nation	Name	Total points scored by competitor	Total points scored by team	Remarks
SWEDEN	H. von Holst	238	925	1st prize Gold medal
»	E. Carlberg	238		
»	W. Carlberg	229		
»	G. Boivie.....	220		
GREAT BRITAIN	W. E. Pimm	237	917	2nd prize Silver medal
»	J. Pepé... ..	235		
»	W. Milne.....	226		
»	W. K. Styles	219		
U. S. A.	T. S. Hird	227	881	3rd prize Bronze medal
»	W. A. Sprout.....	221		
»	Mc Donell	217		
»	N. T. Leushner	216		
Greece	J. Théophilakis	211	716	
»	T. Mavrommatis	187		
»	N. Levidis	185		
»	J. Théophilas	133		

This competition gave rise to a very sharp struggle between the three winning teams, and the nerves, both of the marksmen and lookers-on, were put to a severe test lasting till the very last minute. The British team shot first, scoring 1917 with 99 hits, thus missing the target only once. Then came the Swedish team. Everything went very well at first, but then came a piece of bad luck; one of the competitors, by some means or another, not having time to discharge one of his shots, so that the team had a miss put down to its account, as the regulations prescribed that a shot not fired was to be counted as a miss. The Swedes made 925 points, however, and thus beat Great Britain's score, in any case.

The U. S. A. team came next. If the team could shoot without making a miss, it would carry off the first prize, even though the score made might be lower than those of their rivals. Series after series was fired without a miss, and everyone, almost, began to think that the American team would perform the task set and so carry off the gold medal. But, on marking the last series it was found, however, that one of the team had made a miss. The shot had struck the target just above the right shoulder of the figure, and so near, that, for a moment, there was an animated discussion on the question, "Hit, or no hit?" The teams, the leaders of the competition, experts, and newspaper-correspondents of all nationalities, all examined the "corpus delicti" with critical eyes. But it was found to be a clear miss, and this decided the placing of the three teams in question, the U. S. A., which scored 881 points, coming N:o 3, after Sweden and Great Britain, which were N:os 1 and 2 respectively.

j) INDIVIDUAL COMPETITION WITH MINIATURE=
RIFLE. DISTANCE 25 METRES.

10 a.m. Friday, 5 July.

Rifle: Any breech-loading rifle with calibre not exceeding 6 mm., using miniature ammunition intended for competition. Any back-and fore-sight, except magnifying or telescopic.

Position: Any, without artificial rest.

Target: (disappearing): reduced whole-figure, in zones (see fig. 00). The figure, 12 cm. high, appeared 25 times, each time for 3 seconds, with intervals of 5 seconds between each appearance. After each series of 5 shots, a pause was made for changing the figure.

Number of shots: 25 shots in 5 series, with 5 shots in each series. 2 sighters.

The highest possible number of points a competitor could score was 250.

Of the total of 66 competitors entered by 10 nations, 36 took part in the shooting, the placing being as follows:

N a m e	Nation	Total points scored by competitor.	Remarks
1. W. CARLBERG	Sweden	242	1st prize Gold medal 2nd prize Silver medal 3rd prize Bronze medal
2. J. H. v. HOLST	Sweden	233	
3. G. ERICSSON	Sweden	231	
4. J. Pepé	Great Britain	231	25 hits
5. R. C. Murray	"	228	
6. A. Gyllenkrok	Sweden	227	
7. W. E. Pimm	Great Britain	225	
8. F. S. Hird	U. S. A.	221	

N a m e	Nation	Total points scored by competitor	Remarks	
9. H. Burt	Great Britain ...	222	24 hits	
10. R. Löfman	Sweden	221		
11. E. Odelberg	»	219		
12. R. J. Lessimore	Great Britain ...	218		
13. N. K. Styles	»	216		
14. W. N. Mc Donnell	U. S. A.	212		
15. G. C. Boivie	Sweden	212		
16. E. L. Andersson	U. S. A.	208		
17. W. A. Sprout	»	205		
18. F. Mavrommatis	Greece	204		
19. L. Johnson	France	203		
20. E. Carlberg	Sweden	219		23 hits
21. Jean Théophilakis	Greece	214		
22. W. Milne	Great Britain...	212		
23. J. W. Kemp	»	206		
24. V. T. Leushner	U. S. A.	206		
25. A. J. G. Wahlstedt	Sweden	200		
26. A. Dobrejansky	Russia	190		
27. P. Gentil	France	176		
28. A. G. Nordensvan	Sweden	200	} 22 hits	
29. D. J. Griffiths	Great Britain...	192		
30. N. Leviois	Greece	192		
31. P. Gerlow	Denmark	174		21 »
32. W. de Potékin	Russia	171		20 »
33. Graf A. Török v. Mura	Hungary	146		18 »
34. C. T. Osborn	U. S. A.	146		18 »
35. R. Johnson	Sweden	143		17 »
36. J. Théophilas	Greece	116		14 »

In this competition the Swedish competitors succeeded beyond all expectations, and placed themselves first, second and third. The first man, W. Carlberg, scored 242 — a very good result. That G. Eriksson was awarded the bronze medal, although the British representative, Pépe, had scored the same number of points, was owing to the former having more centres than the latter.

j.) TEAM COMPETITION WITH REVOLVER AND PISTOL. DISTANCE 50 METRES.

Tuesday, 2 July.

This competition was open to one team of four men from each nation; the other regulations were the same as those for the individual competition. The highest possible number of points one competitor could make was 600, and for the team 2,400. Nine nations had each entered a team, but of these, Denmark, France, Hungary and South Africa withdrew from the competition. The result of the shooting was as follows.

Nation	Name	Total points scored by competitors	Total points scored by team	Remarks
U. S. A.	A. P. Lane	509	1916	1st prize Gold medal
»	Harry E. Sears	474		
»	P. J. Dolfen	467		
»	John A. Dietz	466		
SWEDEN	G. de Laval	475	1849	2nd prize Silver medal
»	E. Carlberg	472		
»	W. Carlberg	459		
»	E. Boström	443		
GREAT BRITAIN	H. O. Poulter	461	1804	3rd prize Bronze medal
»	H. Durant	456		
»	A. J. Kempster	452		
»	C. E. Stewart	435		
Russia	N. Kolomenkin	469	1801	IV.
»	G. de Schesterikoff	448		
»	P. Woylochnikoff	447		
»	N. Melnitsky	437		
Greece	F. Mavrommatis	454	1731	V.
»	Jean Théophilakis	442		
»	C. Scarlatos	429		
»	A. Théophilakis	406		

This competition closed the revolver- and pistol shooting. In duel shooting, the Swedish team fired the most evenly, but the representatives of the U. S. A. were prominently to the fore in the 50 metres competitions. America's best man, Mr. A. P. Lane, especially, showed himself to be a very safe and cool marksman with the pistol, as his results, which are, in every respect, excellent, bear witness.

k) INDIVIDUAL COMPETITION WITH REVOLVER AND PISTOL. DISTANCE 50 METRES.

Monday, 1 July.

Any revolver or pistol with open fore- and back-sights. Ammunition with metal cartridge case. The use of hair trigger not permitted.

Number of shots: 60 shots in series, with 6 shots in each series.
2 sighters.

Time: 4 minutes for a series of 6 shots.

Target: white, 50 cm. in diameter. The target divided into 10 zones each; $2\frac{1}{2}$ cm. in breadth. Centre, black; 20 cm. in diameter; The highest possible number of points was 600.

There were 88 competitors, from 14 different nations, entered for this competition. Of these, 54 competitors, from 12 nations, took part in the event, the placing being as follows:

N a m e	Nation	Total points	Remarks
1. A. P. LAKE	U. S. A.	499	1st prize Gold medal
2. P. J. DOLFEN	U. S. A.	474	2nd » Silver medal
3. G. E. STEWART	Great Britain ...	470	3rd » Bronze medal
4. G. de Laval.....	Sweden	470	
5. E. Boström	»	468	
6. H. O. Poulter	Great Britain ...	461	
7. H. E. Sears	U. S. A.	459	
8. N. Kolomtenkin	Russia	457	
9. J. A. Diez	U. S. A.	454	
10. L. Johnson	France	454	
11. C. I. Törnmark	Sweden	453	
12. E. Carlberg	»	452	
13. R. H. Sayre.....	U. S. A.	452	
14. L. J. Madsen	Denmark	452	
15. A. Regaud	France	447	
16. W. Carlberg.....	Sweden	446	
17. G. de Panteleymonoff..	Russia	442	
18. J. Théophilakis.....	Greece	441	
19. D. de Kouskoff ..	Russia	438	
20. E. Durant.....	Great Britain ...	433	
21. L. P. K. Larsen	Denmark	432	
22. H. Roedder.....	U. S. A.	431	
23. H. K. Ekvall	Chili.....	430	
24. A. J. Kempster	Great Britain ...	426	
25. J. F. Nyström	Sweden	426	
26. F. Mavrommatis	Greece	425	
27. Graf A. Török von Mura	Hungary	424	
28. H. Huttunen.....	Finland	424	
29. R. Löfman	Sweden	423	
30. C. Scarlatos.....	Greece	420	
31. G. de Schesterikoff.....	Russia	420	
32. F. H. Jones	Great Britain ...	417	
33. N. de Melnitsky.....	Russia	414	
34. P. de Weylochnikoff ...	»	413	
35. W. Mc Clure	Great Britain ...	411	
36. P. Palén	Sweden	410	
37. G. Eriksson.....	»	408	
38. F. Alegria	Chili.....	406	
39. A. Schmal Jun.	Austria.....	406	
40. F. Nielsen	Denmark.....	406	
41. A. H. Larsen	»	405	
42. G. E. Boivie	Sweden ..	401	
43. S. P. Nielsen	Denmark.....	397	
44. G. Bock	Germany.....	395	
45. E. J. Tickell	Great Britain ...	387	
46. A. de Kache	Russia.....	384	
47. A. Théophilakis	Greece	369	
48. G. E. Stjernspets.....	Sweden	357	
49. W. Winans.....	U. S. A.	356	
50. A. P. Nielsen	Denmark	355	
51. H. Cederschiöld.....	Sweden	352	
52. Jelenffy-Toth v. Csejthe	Hungary	348	
53. E. Bernhardt	Austria.....	245	
54. H. Hoffman.....	Germany.....	189	

G. de Laval, a Swede, had the same number of points as the winner of the third prize Stewart, (G. Britain), but the latter took precedence, having made the greater number of "centres" (tens).

1) TEAM COMPETITION WITH REVOLVER AND PISTOL. DISTANCE 30 METRES (DUEL SHOOTING).

3 p. m. Saturday, 29 June.

The competition was open to one team of four men from each nation; the regulations being the same as for the preceding competition. The highest possible number of points for each man in the group was 300 and, for the team 1,200.

Seven nations had entered a team, and all the competitors were present. As all the teams had not an opportunity of shooting on Saturday, it was not before Wednesday, 3 July, that the competition could be concluded.

The result of the shooting was as follows:

Nation	Name	Total points reached by competitor	Total points of team	Remarks
SWEDEN	1. W. Carlberg	290	1145	120 hits no miss 1st prize; gold medal.
"	2. E. Carlberg	287		
"	3. H. von Holst	284		
"	4. P. Palén	284		
RUSSIA	5. A. de Kache	281	1091	118 hits 2 misses 2nd prize; silver medal.
"	6. N. de Milnitsky	273		
"	7. P. de Woyloschnikoff	270		
"	8. G. de Panteleymonoff	267		
GREAT BRITAIN	9. H. Durant	289	1107	117 hits 3 misses 3rd prize; bronze medal.
"	10. A. J. Kempster	285		
"	11. G. E. Stewart	284		
"	12. H. O. Poulter	249		
U. S. A.	13. A. P. Lane	292	1097	117 hits 3 misses.
"	14. R. H. Sayre	273		
"	15. W. Winans	271		
"	16. J. A. Dietz	261		
Greece	17. K. Scarlatos	283	1057	115 hits 5 misses.
"	18. J. Théophilakis	275		
"	19. F. Mavrommatis	273		
"	20. G. Petropoulos	226		
France	21. E. Sandoz	285	1041	113 hits 7 misses.
"	22. Baron de Jaubert	275		
"	23. Marquis d. Crequi-Montfort	259		
"	24. M. Faure	222		
Germany	25. B. Wandelleck	256	890	102 hits 18 misses.
"	26. G. Bock	233		
"	27. G. Meyer	216		
"	28. H. Hoffman	195		

The Swedish duel-shooting team deserves praise for the confidence and accuracy with which it shot. The various phrases of its firing — loading, taking up position, sighting and discharging the pistol — were all performed simultaneously, and, so to say, with automatic precision, showing that the team had trained conscientiously, not only individually, but also collectively, and that this latter system of training is, undoubtedly to be recommended for team-shooting in general, at a disappearing target.

m) INDIVIDUAL COMPETITION WITH REVOLVER AND PISTOL. DISTANCE 30 METRES (DUEL SHOOTING).

9 a. m. Saturday, 29 June.

Any revolver or pistol, with open fore- and back-sights.

Number of shots: 30 shots in 6 series, with 5 shots in each series.

Two sighters.

Target: Whole-figure (in zones), 1.7 metres high.

Highest possible number of points, 300.

76 competitors, representing 10 nations, had been entered for this competition and, of this number, 42 men from 10 nations actually competed, the result of their shooting being as follows:

N a m e	Nation	Total points	R e m a r k s
1. A. P. LANE	U. S. A.	287	1st prize: gold medal 2nd prize; silver medal 3rd prize; bronze medal
2. A. P. PALÉN	Sweden	286	
3. H. von HOLST	Sweden	283	
4. J. A. Dietz	U. S. A.	283	} 30 hits.
5. C. J. Törnmark	Sweden	280	
6. E. Carlberg	"	278	
7. G. de Laval	"	277	
8. W. Winans	U. S. A.	276	
9. Graf A. Török v. Mura	Hungary.....	275	
10. H. Roedder	U. S. A.	275	
11. G. C. Boivie	Sweden	272	
12. E. Sandoz.....	France	272	
13. P. de Laval	Sweden	268	
14. G. de Panteleymonoff...	Russia	265	
15. W. Carlberg	Sweden	274	
16. P. J. Dolfen	U. S. A.	274	
17. E. Boström	Sweden	274	
18. F. A. Schartau	"	270	
19. R. H. Sayre.....	U. S. A.	268	} 29 hits.
20. A. Schmal Jun.	Austria	267	
21. H. E. Sears.....	U. S. A.	266	
22. N. de Melnitsky	Russia	254	
23. J. Théophilakis	Greece	263	
24. P. de Woylochnikoff ...	Russia	260	
25. F. Alegria	Chili	259	

N a m e	Nation	Total points	R e m a r k s
26. Marquis de Crequi-Montfort	France	263	} 28 hits.
27. C. Scarlatos	Greece	261	
28. A. de Kache	Russia	260	} 27 hits.
29. F. Mavrommatis	Greece	256	
30. A. Gyllenkrook	Sweden	255	} 26 hits.
31. M. Faure	France	250	
32. G. de Schesterikoff	Russia	250	} 25 hits.
33. A. Théophilakis	Greece	242	
34. N. Levidis	"	231	} 23 hits.
35. A. Metaxas	"	232	
36. Baron de Jaubert	France	229	} 17 hits.
37. H. Cederschiald	Sweden	225	
38. H. K. Ekwall	Chili	217	
39. G. H. Meyer	Germany	207	
40. E. Bernhardt	Austria	194	
41. W. Mc Clure	Great Britain	180	
42. Baron H. de Castex	France	140	

As E. von Holst and J. A. Dietz both reached 283 points, the tie was shot off, when von Holst won with 284 to Dietz' 282, the bronze medal thus falling to von Holtz.

As regards the result of the competition as a whole, it cannot be said that it was very good, a fact that ought, probably to chiefly be ascribed to the nervousness everywhere prevailing. Sweden, however, was well to the fore, as, of the 14 competitors who hit the target every time, 7 were Swedes.

This closed the pistol and revolver competitions. In the duel shooting the Swedes were those that shot most evenly, but at 50 metres the U. S. A. were easily first. Mr. A. P. Lane, the best man in the team, proving himself a very safe and cool marksman, witness to the fact being borne by the excellent results he obtained.

* * *

As far as Sweden is concerned, the competitions in pistol-, revolver- and miniature-rifle shooting were both interesting and instructive, at the same time that the results were quite a surprise, as this part of the shooting competitions was, on the whole, a novelty for us, the explanation of this being probably the following.

The leading motive for the volunteer shooting movement in Sweden has always been national defence, and, in consequence, practice has always been restricted to rifle-shooting. It is with the army-model rifle in hand that our marksmen frequent the ranges, or go up into the hills, or elsewhere, to practise field-shooting. The result has been, that there has existed no interest in other kinds of shooting, except, perhaps, in game-shooting, an ancient form of sport in Sweden.

It is a great pity, however, that this should be the case, and it would not diminish the interest in army-rifle shooting if some atten-

tion were also paid to miniature-rifle, pistol- and revolver-shooting, all of which forms of sport can, from several points of view, be considered as well worthy of attention.

Apart from the circumstance that our prospects of coming to the fore in these kinds of competitions at international meetings have already been proved to be quite good, there are other points of view that should recommend these forms of shooting to the greater attention of our marksmen.

Shooting with miniature-rifles at targets placed at distances of from 50 to 100 metres away is, therefore, an excellent means of practising careful firing at stationary targets. As a matter of fact, the marksman learns to aim and fire each time with the greatest care and exactness, so that this form of shooting really forms a very good preparatory course for army-rifle shooting at longer ranges.

In the same way, practice in rapid firing at disappearing targets is a most suitable preparatory exercise for field-shooting, where the marksman is required, above all, to aim and fire with the speed of lightning, so to say. It was, perhaps, the fact that the Swedes are accustomed to field-shooting that decided the competition at 25 metres in their favour.

Another circumstance that speaks in favour of miniature-rifle shooting is, that the marksman himself can, with the aid of a field-glass, ascertain the position of each hit made. By this means, he is soon enabled to judge with precision of the effect of light, temperature and wind on the result of his firing, and this makes this form of shooting a very pleasant and, at the same time, a most instructive one. In addition to this, miniature rifle shooting is cheap, and easy of arrangement.

Shooting with revolver or pistol should, rightly, be placed in a category by itself, as it cannot be considered as having anything in common with rifle-shooting. This circumstance, however, should not prevent it from having much more attention paid to it in Sweden than has hitherto been the case.

Revolver- and pistol-shooting at a stationary target, especially at long ranges, is, undoubtedly, one of the most difficult forms of shooting there is; for a sure hand and eye, and nerves of steel, are requisite in the very highest degree. This fact, however, gives ever increasing interest and pleasure to this kind of shooting, the more it is practised. From a sporting point of view, it is the finest of all forms of fire-arm exercise, and is, therefore, one to be specially recommended.

Rapid firing with revolver or pistol is a form of shooting that, in a certain degree, can speak for itself. Every body — even the one that otherwise never thinks of practising shooting in any form — should be anxious, merely as a matter of self-defence, to learn how to handle a revolver — a fire-arm which, in untrained hands, is apt to be a somewhat dangerously innocent weapon.

It has already been said that the competitions in revolver-, pistol-, and miniature-rifle shooting were, on the whole, something new to the Swedish marksmen. This part of the shooting programme was adopt-

ed principally so as to satisfy, in the best way, the wishes of competitors from abroad, for we ourselves could have but very slight hopes of success in such events as those in question. Characteristic of the situation, too, is the fact that, for the try outs, which took place about a month before the Olympic Games began, there were only about 20 competitors who entered, of which number it was evident that many really had no very clear idea of the nature of the competitions. For example, in the try outs for the shooting with miniature-rifles at 50 metres, a great many of the marksmen used ordinary saloon-rifles, with open sights.

The more surprising, therefore, was the result of these competitions, which were so very favourable for Sweden. The marksmen who so successfully defended the Swedish colours, were, with but one or two exceptions, members of the Stockholm Pistol-shooting Club. This club was founded in January 1909, for the purpose of promoting interest in revolver- and pistol-shooting, and also, but not least, in order to be able to form a Swedish team for pistol-shooting at the Olympic Games of 1912.

It is clear, that the success that has been won at the Games in these, as in the other competitions, will powerfully contribute to more determined, more clear-sighted work on the part of the nation as a whole, for the promotion of athletics. We have, therefore, every reason to hope that, when the signal next time calls the nations to these peaceful competitions, Sweden will be able to enter the arena well trained, and prepared to take part in every branch of athletics included in the programme, and determined to once again fight for the dear old blue and yellow flag.

Clay Bird and Running Deer Shooting.

The arrangements for the competitions in Clay Bird- and Running Deer shooting at the Olympic Games of Stockholm, 1912, were entrusted to the Stockholm division of the Svenska Jägarförbundet (the Swedish Sportsmen's Association), which appointed a committee for the purpose in question, consisting of Captain Fr. Björkenstam, Master of the Hounds;, and Messrs. E. W. Lindewald, M. N. Hallman, Alf. Swahn, and Edv. Benedicks, while Joh. E. Ekman, Esq. and Baron Axel Klinckowström were elected deputy members. After the 'Committee had met and elected Captain Björkenstam as President and E. W. Lindewald as Vice-President, two additional members were called in; E. Melin, Esq., who was appointed secretary, and O. G. Swahn, Esq., chosen as adjoined member.

The first care of the Committee was to find a suitable place for the ranges in the immediate neighbourhood of Stockholm and having good communications with the capital, and, after several proposals had been discussed, it was determined to have both ranges out at Ellenhill, close to Lake Råstasjön, where ground for the purpose was offered by the Råsunda Suburbs C:o. and the Crown Prince's Golf Club, the latter kindly allowing the Committee to make use of such part of its golf-links as might be required.



U. S. A. MARSKMAN AT KAKNÄS



U.S.A. ARMY-RIFLE SHOWN TO H.M. THE KING.

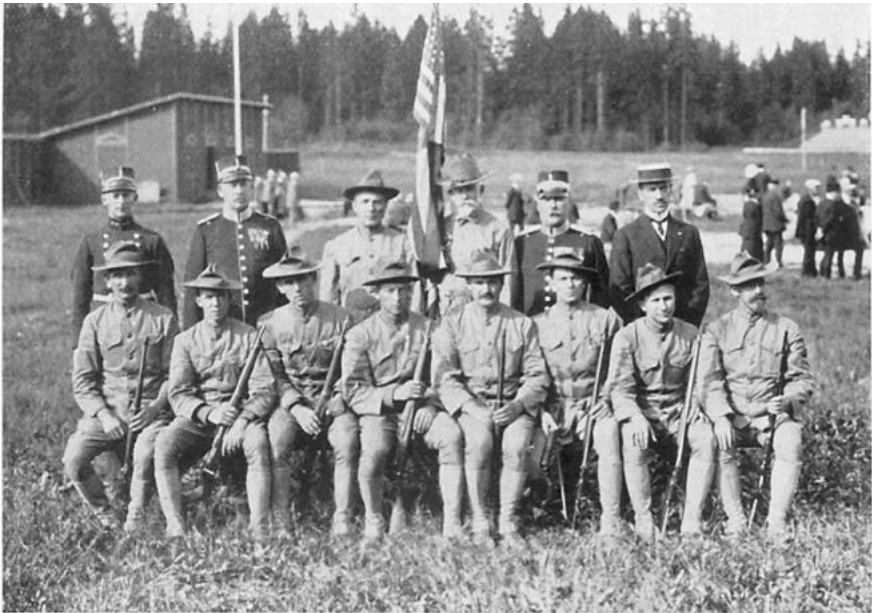

U. S. A. RIFLE-TEAM.



DENMARK'S RIFLE-TEAM.



RIFLE-TEAM OF FRANCE.



NORWAY'S RIFLE-TEAM.



SOUTH AFRICA'S RIFLE-TEAM.



SWEDEN'S RIFLE-TEAM.

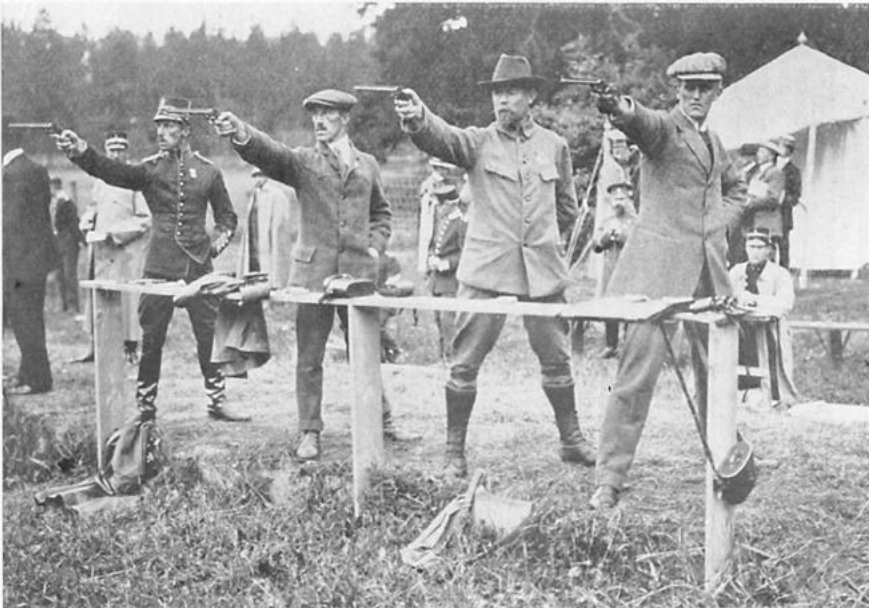

SWEDEN'S PISTOL-SHOOTING-TEAM, Team Competition j.



A PISTOL-SHOOTING COMPETITION.

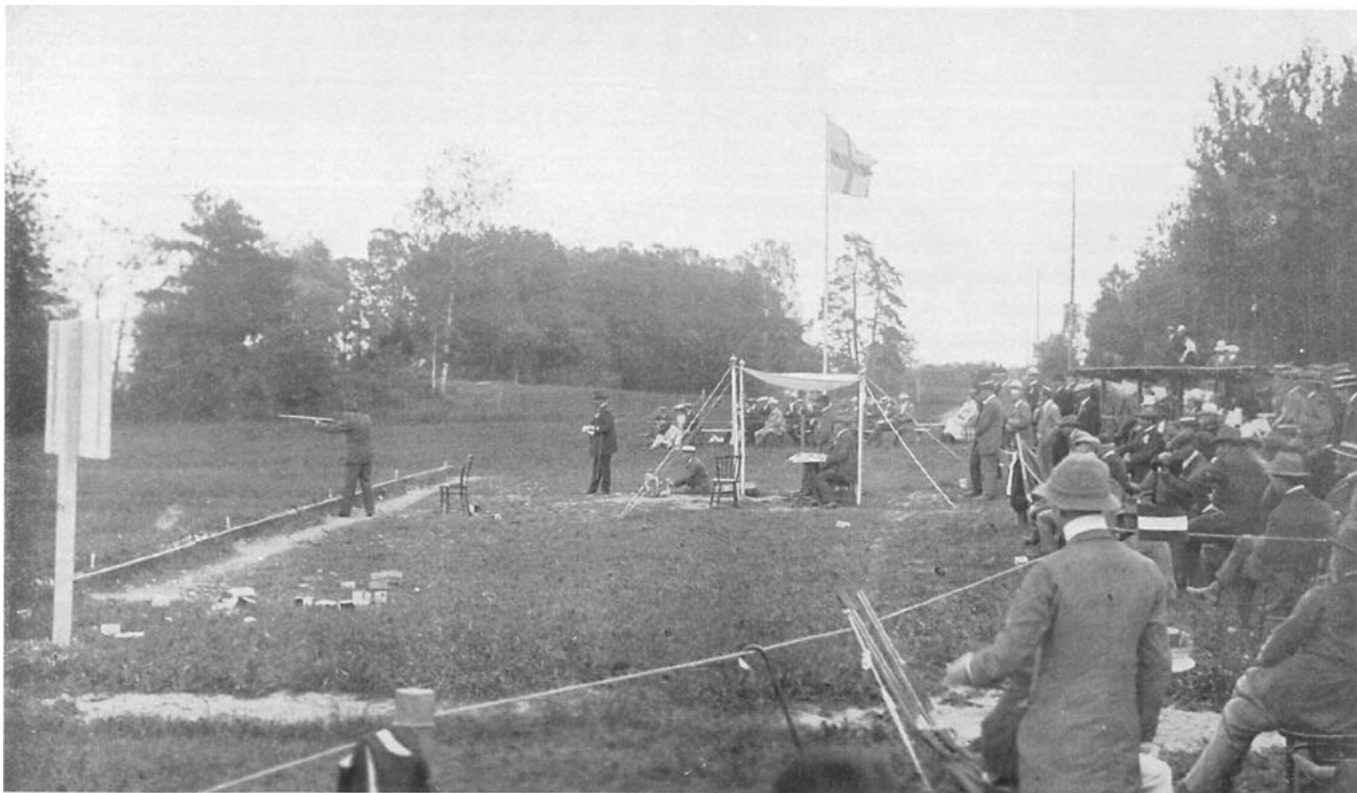

A CLAY BIRD SHOOTING COMPETITION AT RÅSUNDA.



SPECTATORS AT CLAY BIRD SHOOTING, RÅSUNDA.

It will be seen by the rules of the competitions, which can be found in the latter part of this book, that considerable changes have been made in the regulations in force at the Olympic Games of London, 1908, the reason of this being a desire to give the competitions, as much as possible, the nature of a sporting event.

On the proposal of the Committee the following gentlemen were elected to act as officials at the competitions:

For Clay Bird Shooting:

Judge: Count Claes Lewenhaupt, Secretary to the Cabinet;
Controllers: N. Krook, J:mr., Esq., and B. Lindroth, Esq.
Deputy Member: Carl Kjellberg, Esq.

For Running Deer Shooting.

Judge: Lieut T. Kroplien;
Controllers: Wilh. Schumacher, Esq., and G. Mossberg, Esq.
Deputy Member: Lieut. E. Helling.

Captain Fr. Björkenstam acted as leader of the competitions.

n) CLAY BIRD SHOOTING. TEAM COMPETITION.

Teams of 6, with max. 3 reserves.

3 stages.

1st stage: Teams shoot at 20 birds per man in 2 rounds
 2nd » » » » 30 » » » » 2 »
 3rd » » » » 50 » » » » 3 »

For the team competition, which took place on the 29 June and the 1 July, there were entries from seven nations:

Finland	France	Germany
Great Britain	Russia	Sweden
	U. S. A.	

The Russian team did not compete and, in accordance with the regulations in force, the French team retired after the first round, and the Swedish and Finnish teams after the second round. Of the three teams left, that representing the U. S. A. was placed first, with 532 points, Great Britain coming second with a score of 511, and Germany third with 510 points.

U. S. A. Gold Medal.

	1st. round:	2nd rd:	3rd rd:	Total.
Charles W. Billings	20	29	44	= 93
Ralph L. Spotts	18	28	44	= 90
John H. Hendrickson	18	26	45	= 89
James R. Graham	16	30	48	= 94
Edward F. Gleason	18	23	39	= 80
Frank Hall	18	25	43	= 86
	108	161	263	= 532

GREAT BRITAIN..... *Silver Medal.*

John Hurst Butt	16	24	39	=	79
William Percy Grosvenor	17	29	43	=	89
Harry Robinson Humby	19	26	46	=	91
Alexander Maunder.....	18	27	44	=	89
Charles Palmer	17	27	35	=	79
George Whitaker	17	27	40	=	84
	<u>104</u>	<u>160</u>	<u>247</u>	=	<u>511</u>

GERMANY *Bronze Medal.*

Graf Erich Bernstorff.....	18	24	45	=	87
Freiherr von Zeidlitz u. Leipe	19	28	44	=	91
Horst Goedel	18	27	43	=	88
Albert Preuss	18	25	38	=	81
Koch	17	26	39	=	82
Alfred Goedel	17	26	38	=	81
	<u>107</u>	<u>156</u>	<u>247</u>	=	<u>510</u>

Sweden.

C. Wollert	14	17	=	31
Alfred G. A. Swahn	18	27	=	45
Joh. E. Ekman	16	25	=	41
E. Hjalmar Frisell	13	25	=	38
Åke Lundeberg	19	29	=	48
Victor Wallenberg	15	25	=	40
	<u>95</u>	<u>148</u>	=	<u>243</u>

Finland:

Edvard Bacher.....	17	27	=	44
Karl Fazer	15	21	=	36
Robert Valdemar Huber.....	18	25	=	43
Gustaf Adolt Schnitt	18	23	=	41
Emil Johannes Collan.....	16	21	=	37
Axel Fredrik Londen.....	11	21	=	32
	<u>95</u>	<u>138</u>	=	<u>233</u>

France.

Baron Henri de Castes	15
Marquis de Crequi-Montfort	15
Edouard Creuzé de Lesser ..	14
André Fleury	16
Baron Charles Jaubert	15
René Texier	<u>15</u>
	90

o) CLAY BIRD SHOOTING. INDIVIDUAL COMPETITION.

3 stages.

1st round: Shooting at 20 birds per man in 2 rounds
2nd » » » 30 » » » » 2 »
3rd » » » 50 » » » » 4 »

There were 83 entries, from 13 nations, for the individual competition which took place on July 2, 3 and 4 July. Of these 83, only 61 took part in the event; 21 marksmen had to retire after the first round and 12 after the second round.

The result is shown by the following list:

	<i>Name</i>	<i>Nation</i>	<i>Round</i>	<i>1</i>	<i>2</i>	<i>3</i>	<i>Total</i>
1.	James R. Graham	U. S. A.	19	28	49	=	96
2.	Alfred Goeldel	Germany	18	28	48	=	94
3.	Harry Blau	Russia	15	27	49	=	91
4.	Harry Robinson Humby ...	Great Britain ...	18	24	46	=	88
5.	Albert Preuss	Germany	17	25	46	=	88
6.	Anastasius Metaxas	Greece	18	26	44	=	88
7.	Freiherr von Zeidlitz und Leipe	Germany	19	23	46	=	88
8.	Gustaf Adolf Schmitt	Finland	18	26	44	=	88
9.	Emile Jurgens	Holland	17	27	43	=	87
10.	Ralph Louis Spotts	U. S. A.	16	24	47	=	87
11.	Edward Francis Gleason ...	»	19	28	40	=	87
12.	Koch	Germany	18	23	45	=	86
13.	Karl Fazer	Finland	16	25	43	=	86
14.	Horst Goeldel	Germany	19	23	44	=	86
15.	Frank Hall	U. S. A.	16	26	44	=	86
16.	William Percy Grosvenor ...	Great Britain ...	17	24	44	=	85
17.	Rob. Bennet Hutcheson.....	Canada.....	15	26	43	=	84
18.	Graf Erich Bernstorff.....	Germany	17	24	43	=	84
19.	John Hurst Butt	Great Britain ...	18	24	42	=	84
20.	Åke Lundeberg	Sweden	17	24	43	=	84
21.	Charles Palmer	Great Britain ...	15	24	43	=	82
22.	Alfred G. A. Swahn	Sweden	17	25	40	=	82
23.	Léon Syttine	Russia	15	24	42	=	81
24.	Frantz Rosenberg	Norway	15	24	42	=	81
25.	H. F. Lüttich	Germany	16	23	38	=	77
26.	Baron Charles Jaubert	France	15	25	37	=	77
27.	André Fleury	»	16	23	35	=	74
28.	Carsten Henrik Bruun	Norway	16	24	34	=	74
29.	Baron Henri de Castex	France	17	21			
30.	Robert Waldemar Huber ...	Finland	15	23			
31.	E. Hjalmar Frisell	Sweden	15	23			
32.	Emil Johannes Collan	Finland	15	23			
33.	George Whitaker	Great Britain ...	16	22			
34.	Victor Wallenberg	Sweden	17	20			
35.	Marquis de Crequi-Montfort ..	France	15	21			
36.	Walter Bodneck	Russia	15	21			
37.	Daniel Francis Mc Mahon ...	U. S. A.	15	21			
38.	Edv. Benedicks	Sweden	15	19			
39.	George Ernest Pinchard ...	Great Britain ...	15	18			
40.	Joh. E. Ekman	Sweden	15	16			
41.	Edouard Creuze de Lesser...	France	14				
42.	Charles W. Billings	U. S. A.	14				
43.	H. A. Erikson	Sweden	14				
44.	John H. Hendrickson.....	U. S. A.	14				
45.	James H. Kenyon	Canada.....	13				
46.	William R. Davies	»	13				
47.	Edvard Bacher	Finland	13				
48.	René Texier	France	13				
49.	Alexander Maunder ..	Great Britain ...	13				
50.	Herman Nyberg	Sweden	13				
51.	Henri le Marié	France	12				

	<i>Name</i>	<i>Nation</i>	<i>Round 1</i>	
52.	Paul Lieth	Russia		12
53.	Alfred William Black.....	Great Britain ...		11
54.	Emil Ernst Fabritius	Finland		11
55.	Boris Pertel	Russia		11
46.	John Morris Goodwin	Great Britain ...		10
57.	O. G. Swahn	Sweden		10
58.	O. Bökman	»		10
59.	C. Wollert	»		10
60.	N. Klein	»		7
61.	Alfred Stabell	Norway		3

1. JAMES R. GRAHAM..... U. S. A. *Gold Medal.*
2. ALFRED GOELDEL..... Germany *Silver Medal.*
3. HARRY BLAU..... Russia *Bronze Medal.*

Lord Westbury's Challenge Cup, which was held by W. H. Ewing, Canada, was won by James R. Graham, U. S. A.

p) RUNNING DEER SHOOTING. TEAM COMPETITION.
DISTANCE 100 METRES. SINGLE SHOTS.

Teams of 4, with max. 2 reserves. 10 shots, one at each run.
2 sighters. Any position.

Eight nations entered for the team competition, but of these France, Germany and South Africa did not compete. The result is shown by the following list of scores:

SWEDEN: 151 points. *Gold Medal.*

Alfred G. A. Swahn	4	4	5	3	4	3	3	3	3	5	=	37
O. G. Swahn	4	5	5	4	5	3	4	5	3	5	=	43
Åke Lundeberg	4	4	4	5	2	4	5	4	3	4	=	39
P. O. Arvidson	2	4	3	3	4	3	2	5	3	3	=	32
	Total											151

U. S. A.: 132 points. *Silver Medal.*

W. Neill Mc Donell	—	5	1	3	—	4	—	2	—	3	=	18
Walter Winans	4	5	1	4	4	4	4	5	4	4	=	39
William F. Leushner	4	5	4	4	5	4	2	2	5	3	=	38
William Libbey	4	5	5	4	3	4	1	3	5	3	=	37
	Total											132

FINLAND: 123 points. *Bronze Medal.*

Axel Fredrik Londen	3	5	—	3	3	4	2	3	3	3	=	29
Nestor Toivonen	3	3	5	4	5	4	3	3	5	3	=	38
Tivo Wäänänen	5	4	—	3	3	3	4	2	3	3	=	30
Ernst Edvard Rosenquist	5	—	—	1	5	4	5	3	3	—	=	26
	Total											123

Austria: 115 points.

Adolf Michel	4	—	3	3	5	3	4	2	5	4	=	33
Eberhard Steinböck	—	—	—	—	3	3	2	4	5	2	=	19
Peter Paternelli	2	3	5	3	3	3	3	3	4	5	=	34
Heinrich Elbogen	3	3	2	3	3	3	2	5	1	4	=	29
	Total											115

Russia: 108 points.

Harry Blau	—	2	4	3	2	2	1	3	3	3	=	23
Basile de Skrotsky	—	3	3	5	3	5	5	3	4	5	=	36
Dimitry de Barkoff	4	3	2	4	5	2	3	—	3	—	=	26
Alexandre de Dobrjansky	1	2	1	3	3	3	2	3	2	3	=	23
											Total	108

q) RUNNING DEER. INDIVIDUAL COMPETITION.
DISTANCE 100 METRES. SINGLE SHOTS .

For this competition, which began on 29 June, there were 66 entries from 12 nations. Of this number only 34 competitors took part in the event, the result of the shooting being shown by the following table.

Name	Nation	1	2	3	4	5	6	7	8	9	10	T:1
1. Alfred G. A. Swahn	Sweden	3	5	4	5	4	3	3	5	5	4	41
2. Åke Lundeberg	"	4	4	3	4	5	4	4	4	4	5	41
3. Nestor Toivonen	Finland	5	3	4	4	5	4	4	4	5	3	41
4. K. Larsson	Sweden	4	5	3	4	5	3	4	4	4	3	39
5. O. G. Swahn	"	4	4	3	3	5	5	2	5	4	4	39
6. S. A. Lindskog	"	4	2	4	5	5	5	5	3	2	4	39
7. Heinrich Elbogen	Austria	5	4	3	4	4	5	3	3	3	4	38
8. A. F. Ture Cederström	Sweden	5	5	3	3	3	3	3	4	5	3	37
9. William F. Leushner	U. S. A.	4	4	3	3	5	5	3	3	5	2	37
10. Adolf Michel	Austria	3	3	4	4	4	5	4	5	1	3	36
11. Joh. E. Ekman	Sweden	4	2	—	3	5	5	4	3	4	4	34
12. E. Sökjer-Petersen	"	3	3	—	3	3	4	3	5	5	5	34
13. Koch	Germany	3	3	4	2	3	4	3	3	5	3	33
14. E. E. Rosenquist	Finland	4	3	3	2	4	2	3	4	4	3	32
15. G. Lyman	Sweden	3	4	3	3	2	4	2	3	3	4	31
16. Basile de Skrotsky	Russia	3	3	1	5	3	4	4	3	5	—	31
17. Peter Paternelli	Austria	5	3	3	3	—	4	3	4	2	4	31
18. Axel Fredrik Londen	Finland	2	3	3	4	3	4	3	3	3	3	31
19. Nicolas M. Lividis	Greece	3	3	3	3	3	3	3	3	4	3	31
20. Harry Blau	Russia	2	4	2	3	2	3	2	4	4	3	29
21. Huvi Hjalmar Tuiskunen	Finland	2	3	4	1	5	2	2	3	3	3	28
22. Iivo Wäänänen	"	3	3	3	—	4	4	2	3	3	3	28
23. A. Preuss	Germany	5	3	2	—	3	4	—	4	3	4	28
24. Horst Goedel	"	3	4	2	4	4	3	3	2	—	2	27
25. E. W. Lindewald	Sweden	3	3	3	3	—	3	5	2	3	4	27
26. P. O. Arvidson	"	5	3	—	2	3	—	5	2	3	3	26
27. Karl Henrik Lorenz Reilin	Finland	—	3	4	2	2	3	3	3	3	3	26
28. Edv. Benedicks	Sweden	3	2	2	4	4	4	—	3	—	4	26
29. Walter Winans	U. S. A.	4	—	4	—	2	2	4	5	—	3	24
30. Jean Théophilakis	Greece	4	3	4	—	—	3	3	—	3	4	24
31. Dimitry de Barkoff	Russia	3	3	2	1	1	1	3	3	3	3	23
32. Eberhard Steinböck	Austria	—	3	3	—	3	3	3	5	—	3	23
33. Alexandre de Dobrjansky	Russia	3	—	3	1	3	3	3	2	1	3	22
34. Paul Lieth	"	2	—	—	1	—	3	—	3	—	1	10

As three competitors tied for the first place, the tie, in accordance with the regulations, had to be shot off by means of a series of 5

shots. The order of firing was decided by drawing lots, the result of this being as follows: Nestor Toivonen, Finland, Alfred G. A.: Swahn, Sweden, Åke Lundeberg, Sweden.

On the tie being shot off, the following result was come to:

	1	2	3	4	5	T:1
1. ALFRED G. A. SWAHN, ... Sweden ... <i>Gold Medal</i>	5	5	3	2	5	20
2. ÅKE LUNDEBERG Sweden ... <i>Silver Medal</i> ...	3	4	4	3	3	17
3. NESTOR TOIVONEN Finland ... <i>Bronze Medal</i> ...	4	3	4	—	—	11

r) RUNNING DEER. INDIVIDUAL COMPETITION. DISTANCE 100 METRES. DOUBLE SHOTS.

There were 45 entries by 10 nations. Of these, 25 men did not appear, and the result of the competition is shown by the following table.

N a m e	Nation	1	2	3	4	5	6	7	8	9	10	T:1								
Åke Lundeberg	Sweden ...	3	4	3	5	3	5	4	4	3	4	3	3	5	5	3	5	4	5	79
Edv. Benedicks	» ...	3	4	4	5	3	3	4	4	3	5	3	4	2	3	4	5	3	5	74
O. G. Swahn	» ...	4	4	3	5	2	2	5	5	3	4	3	5	2	4	3	4	3	4	72
Alfred G. A. Swahn ...	» ...	3	5	4	5	5	5	2	5	3	5	—	3	2	3	—	3	2	4	68
P. O. Arwidson	» ...	4	5	4	5	—	5	4	5	3	4	4	5	—	3	—	2	3	3	68
A. Lindskog.....	» ...	3	4	3	4	3	4	3	4	2	4	1	4	4	5	2	3	2	4	67
E. Sökjer-Petersen ..	» ...	2	5	3	4	2	4	3	4	3	4	—	—	5	5	4	4	3	4	65
E. W. Lindewald	» ...	—	3	2	4	4	4	3	4	4	4	—	3	3	4	5	3	3	3	64
G. Lyman.....	» ...	2	3	2	4	3	5	3	4	3	3	3	4	—	2	3	4	3	3	61
Baron Charles Jaubert	France ...	—	5	2	3	2	3	4	4	2	4	3	3	2	4	4	3	—	5	60
Walter Winans	U. S. A....	3	4	3	3	2	2	2	4	2	4	—	3	4	4	2	3	3	5	59
E. Hjalmar Frisell ..	Sweden ...	2	4	3	5	4	5	—	3	2	3	—	3	3	5	3	4	4	5	58
John E. Ekman	» ...	2	3	—	3	3	5	3	3	3	3	—	4	3	4	—	3	3	4	58
C. W. Dybeck	» ...	—	3	2	3	—	3	3	3	—	3	1	3	3	3	4	5	5	5	57
William F. Leushner...	U. S. A....	2	3	3	3	3	4	3	3	3	4	5	3	3	2	2	—	—	—	49
Heinrich Elbogen.....	Austria ...	3	3	—	5	3	3	—	5	2	3	1	3	2	3	1	3	4	4	48
Koch	Germany	2	3	—	3	—	3	4	4	—	5	2	3	3	5	—	2	—	3	47
A. Preuss	» ...	—	3	3	3	—	3	3	4	—	3	—	3	3	4	—	4	1	4	47
Dimitry de Barkoff ...	Russia ...	1	2	—	2	—	2	—	3	3	3	4	4	—	—	—	4	1	4	39
Basile de Skrotsky ...	» ...	—	3	—	1	—	3	1	1	2	3	1	1	3	3	—	1	2	3	32

1. ÅKE LUNDEBERG Sweden *Gold Medal*.
2. EDV. BENEDICKS Sweden *Silver Medal*.
3. O. G. SWAHN Sweden *Bronze Medal*.

At the Olympic Games of London, in 1908, there were not as many clay birds used, either for the team or the individual competitions, as in Stockholm, 1912, neither was the calculation of points in the Running Deer competition the same in London as in Stockholm, so that, for the purpose of comparison, the results of all these events, at both places, are given below in per-centages of possibles.

Comparative list of results (given in % of best possibles) of the Clay Bird= and Running Deer Shooting in London, 1908, and in Stockholm 1912.

Clay Bird Shooting.

<i>Team Competition.</i>	<i>Gold Medal:</i>	<i>Silver Medal:</i>	<i>Bronze Medal:</i>
London 1908	64.6 %	64.3 %	59 %
Stockholm 1912	88.66 %	85.16 %	85 %

Individual Competition.

London 1908	90 %	75 %	71.25 %
Stockholm 1912	96 %	94 %	91 %

Running Deer Shooting.

<i>Team Competition.</i>	<i>Gold Medal:</i>	<i>Silver Medal:</i>	<i>Bronze Medal:</i>
London 1908	53.75 %	53.125 %	
Stockholm 1912	75.5 %	66 %	61.5 %

Individual Competition. Single shot.

London 1908	62.5 %	60 %	60 %
Stockholm 1912	82 %	82 %	82 %

Individual Competition. Double shots.

London 1908	57.5 %	57.5 %	47.5 %
Stockholm 1912	79 %	74 %	72 %

A summary of the results of the shooting competitions (a 1:st prize counting 3 points, a 2:nd prize 2 points, and a 3:rd prize 1 point), gives the following figures:

N a t i o n	1:st prizes	2:nd prizes	3:rd prizes	Points
Sweden	7	6	4	37
U. S. A.	7	4	3	32
Great Britain	1	4	4	15
France	2	—	—	6
Denmark	—	1	2	4
Hungary	1	—	—	3
Norway	—	1	1	3
Germany	—	1	1	3
Russia	—	1	1	3
Finland	—	—	2	2

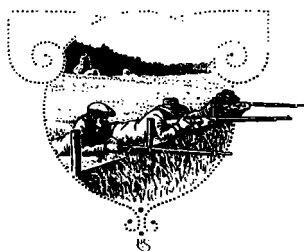

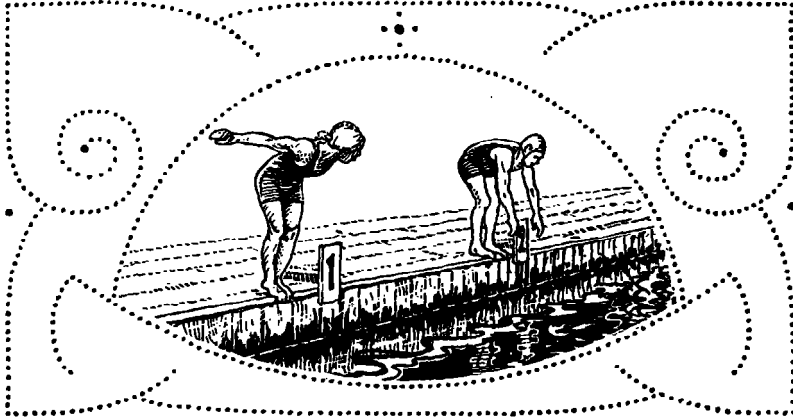

SWIMMING.

GENERAL ORGANIZATION.

In accordance with the regulations fixed for the organization of the work of arranging the competitions of the Fifth Olympiad, the Swedish Swimming Association, at the close of 1909, appointed a special Olympic Swimming Committee, which was commissioned to carry out all the preliminary technical- and other arrangements for the swimming competitions of the Olympic Games. This Committee — which met for the first time on the 7 January, 1910 — after several additions to its numbers, was composed as follows:

<i>President.</i>	ERIK BERGVALL, Esq., Editor of the "Nordiskt Idrottslif"	Stockholm.
<i>Vice-President:</i>	..	Major N. D. EDLUND	Umeå.
<i>Secretary:</i>	KRISTIAN HELLSTRÖM, Esq.	Stockholm.
<i>Treasurer:</i>	JOHN G. ANDERSSON, Esq.	»
<i>Other Members:</i>		CARL BLIDBERG, Esq.	Gothenburg.
		PER FJÄSTAD, Esq.	Stockholm.
		THOR FRIMAN, Esq.	Södertälje
		ANTON JOHANSON, Esq.	Stockholm.
		TORSTEN KUMFELDT, Esq.	»
		SIGFRID D. LARSSON, Esq.	»
		KONRAD LITTORIN, Esq.	Örebro.
		EMIL LUNDBERG, Esq. ..	Stockholm.
		J. A. LÖNNEGREN	Berlin.
		A. ULRICH, Esq., Mayor ..	Säter.
		GUSTAF WRETMAN, Esq.	Stockholm.

Later on, the Committee appointed a special Building Committee, for carrying out the building arrangements necessary for the erection of a Swimming Stadium at Djurgårdsbrunnsviken. This Building Committee consisted of Messrs. E. Bergvall (President), S. D. Lars-

son and Th. Kumfeldt. A special Training Committee was also appointed, the members of which were Messrs. E. Bergvall (President), John G. Andersson and Th. Kumfeldt. Other sub-committees were elected during the course of the next few months, for the arrangement of special questions in connection with the Olympic Swimming Competitions.

Altogether, the chief Committee held 22 meetings.

THE PROGRAMME.

The first business that the Olympic Swimming Committee had to take in hand was the selection of the branches of swimming and diving that ought to be represented on the programme of the Fifth Olympiad. As early as at its meeting held on the 9 April, 1910, the Committee determined to propose the adoption of the programme recommended by the International Swimming Federation. This 'first draft programme included the following branches:

Racing: 100, 400 and 1,500 metres free style; 200 and 400 metres breast stroke, and 100 metres back stroke.

Team racing: 800 metres (4 x 200 met.)

Spring-board diving and high diving, the last named branch to be on the same principles as those adopted for the high diving at the Games in London, 1908.

Water Polo.

After the wish had been expressed at the Meeting of the International Olympic Committee at Luxemburg, in June, 1910, for the inclusion of competitions for Ladies, too, the Swimming Committee recommended the addition to the programme of a 100 met. free style, race, and of plain diving, both for Ladies.

But Great Britain, at the meeting of the International Olympic Committee, Buda-Pesth, May, 1911, and at the Congress of the International Swimming Federation in Brussels, 1910, had asked for the addition to the Swedish programme of a team race for Ladies — 400 met. (4 x 100), and, as both the Bodies mentioned seconded the proposal, the competition in question was accepted by the Swimming Committee. Plain diving for men was also included, in accordance with a wish expressed by the International Swimming Federation.

The final programme was, consequently, as follows:

Men.

100 met. free style.

100 " back stroke.

200 " breast stroke.

400 " free style.

400 " breast stroke.

1500 met. free style.

High diving. Plain diving from heights of 5 and 10 met.

High diving. Plain and variety diving combined, from heights of 5 and 10 met.

Spring-board diving.
800 met. team race.
Water Polo.

Ladies.

100 met. free style.
High plain diving from heights of 5 and 10 met.
400 met. team race.

DRAWING UP THE RULES AND REGULATIONS.

In drawing up the rules for the swimming competitions of the Fifth Olympiad, the Swimming Committee determined that the regulations fixed by the International Swimming Federation should be those now adopted. For the racing and water polo there existed rules that could be taken by the Committee, but no rules for diving competitions had yet been fixed by the International Federation. As, however, the Federation, at its congress in Paris in 1909, had entrusted the Swedish Swimming Association, among others, to draw up draft rules for such competitions, the question of rules for the Olympic Diving competitions could be arranged in fullest agreement with the Federation. It was on the basis of the draft rules for diving which were laid before the congress of the Federation, in Brussels, in 1910, that the rules for the Olympic Diving competitions were drawn up and enforced.

These rules were subsequently supplemented, at the time when the competitions were being arranged, by special "Instructions for Officials", from which extracts were made for the competitors and printed separately in English, French and German. These specially printed leaflets also contained information for competitors, respecting such details of which special mention was not made in the rules; such as, for example, the detailed principles fixing the method to be adopted in their work by the judges of the diving, etc.

As regards the elimination of the competitors before the finals, a number of new principles were applied, in order that the competitions might be carried out with the greatest possible fairness. For example, in the races, the first and second men in each heat, and the "best third" of all the heats, were entitled to take part in the next round or in the final. But, to prevent this rule necessitating the holding of too many rounds, it was also determined, that if, in any heat in the first round, not more than three competitors presented themselves at the starting place, the starter was to let these three, or fewer, swimmers form part of the next heat whose numbers were not complete. In the 100 met. race, where the competitors were, as yet, unaccustomed to this system, the application of the rules occasioned some difficulty, which was soon overcome, however.

In the diving competitions the principle was adopted, that not only should the winner in each trial heat be entitled to take part in the final, but that other competitors who reached a certain number of points should also be qualified to take part in the last round.

The water polo competition, too, was so arranged that all the teams had the same chance of winning the second or third prize. For example, a team that had been beaten only once, had the right to play for the second and third prizes against another team which was also qualified to play for these prizes. The principle was adhered to, however, that a team which had beaten another team was considered to have thereby defeated all the teams beaten, direct or indirectly, by the conquered team in question, so that a team which had been twice beaten would, in nearly every case, be definitely eliminated from the contest.

The division of the competitors into the various trial heats took place by means of drawing lots, which was carried out publicly.

The drawing of lots for the diving competitions took place at once, and the figure drawn for each competitor showed the order in which he was to start in the competitions. In drawing lots for the races, the competitors were grouped according to the nations to which they belonged. Lots were drawn between the nations, after which lots were drawn between the individual representatives of these nations, so that there should be as few as possible of the same nation in the same trial heat. The drawing of lots for the intermediate heats, after the trials had been decided, was quite individual, i. e. irrespective of whether several competitors belonging to the same nation came in the same heat or not. The drawing of lots for the starting places in the races took place just before each start. The drawing of lots for the water polo took place, first of all, within two chief groups, or pools, on the Cup Tie (elimination) system, so that a team from each group met in the final.

The whole of the Rules and Regulations for the Officials will be found in the section entitled "Rules and Regulations for the Competitions", at the end of the book, and also under the heading "Instructions for Officials", on page 128.

ARRANGEMENTS IN THE SWIMMING STADIUM.

In consequence of the regulation of the International Rules for Swimming Competitions which prescribes a course of not less than 100 metres in length for the long distance races, a special Swimming Stadium had to be arranged for the Olympic Swimming Competitions. The spot was chosen at Djurgårdsbrunnsviken, close to the town, and it proved an ideal one for its purpose. A detailed account of the building- and other arrangements made will be found on pp. 211—217 of this Report.

For the convenience of the public, special arrangements were made for the announcement of the results of the competitions at the Swimming Stadium. For example, notice-boards, visible from all the seats, were erected on the diving platform, and on these were shown the results of the various events; in addition to which, the results were called out in English, German and Swedish. Every competitor had to wear a cap of the colour fixed for his or her nation, and, in some cases, the caps bore the competitor's starting-number. At the starting-

and turning ends, respectively, of the course, there were also shown, by means of large figures, the order of each competitor in each start, in addition to which, the starting-number of each competitor was placed on two lofty notice-boards behind each man, where the number remained during the progress of the event. When the results of a competition were announced, the flags of the nations winning or placed, were at once hoisted on three flag-staffs standing at one end of the course.

The swimming course itself and the necessary dressing-rooms were in readiness in such good time before the beginning of the competitions, that the swimmers from abroad who came to Stockholm some days before the date fixed, could pursue their training there. An account of the measures taken for the preparation and training of the Swedish competitors will be found on pp. 299—300 of this Report.

THE COMPETITIONS.

The Swimming Races.

100 METRES, FREE STYLE.

First Round.

7 p.m., Saturday, 6 July.

Heat 1. 1. LADISLAUS BELESNEY, Hungary, 1 min. 8 secs. 2. ROBERT ANDERSSON, Sweden, 1 min. $9\frac{1}{8}$ secs. 3. André Assimacopulo, Greece, 1 min. $15\frac{2}{8}$ secs. 4. Herbert von Kuhlberg, Russia. The Hungarian won without difficulty.

Heat 2. 1. KURT BRETTEING, Germany, 1 min. 7 s. 2. PAUL RADMILOVIC, Great Britain, 1 m. $10\frac{2}{8}$ s. 3. Theodore Tartakover, Australasia, 1 m. $12\frac{1}{8}$ s. 4. Jules Wuyts, Belgium 1 m. $13\frac{8}{8}$ s. Won easily.

Heat 3. 1. LESLIE BOARDMAN, Australasia, 1 m. 6 s. 2. NICHOLAS T. NERICH, U. S. A., 1 m. $7\frac{3}{8}$ s. 3. John Henry Derbyshire, Great Britain, 1 m. $9\frac{1}{8}$ s. Not placed: David Baiardo, Italy; Walther Binner, Germany; Alois Kenyery, Hungary. Won without difficulty.

Heat 4. 1. PERRY Mc GILLIVRAY, U. S. A., 1 m $4\frac{4}{8}$ s. 2. CECIL HEALY, Australasia, 1 m. $5\frac{1}{8}$ s. 3. KENNETH HUSZAGH, U. S A., 1 m. $6\frac{1}{8}$ s. Not placed: Eric Andersson, Sweden; Georg Kunisch, Germany. A hard struggle between the first three. As best third man in the first round, Huszagh qualified for the second round.

Heat 5. 1. DUKE PAOA KAHANAMOKU, U. S. A., 1 m. $2\frac{3}{8}$ s. *World's record.* 2. WILLIAM LONGWORTH, Australasia, 1 m. $5\frac{1}{8}$ s., 3. Harry J. Hebner, U. S. A. 1 m. $10\frac{3}{8}$ s., 4. Gerard Meister, France $1.16\frac{8}{8}$. Won easily. The performance of the phenomenal Kanaka quite came up to expectations. He employs a special kind of crawl, with the motor-power derived from the ankles alone, and not from the hip- or knee-joints. The soles of his feet work up and down; both the upper- and under sides of his feet pressing backwards against the surface of the water.

Heat 6. 1. HAROLD H. HARDWICK, Australasia, 1 m. $5\frac{4}{8}$ s. 2. MAX RITTER, Germany, 1 m. 8 s. 3. Herman Meyboom, Belgium, 1 m. $15\frac{2}{8}$ s. 4. James H. Reilly, U. S. A. Won easily.

Heat 7. 1. WALTHER RAMME, Germany, 1 m. $10\frac{1}{8}$ s. 2. MARIO MASSA, Italy, and Harald Julin, Sweden, 1 m. $11\frac{4}{8}$ s. 3. John Haakon Johnsen, Norway, 1 m. $19\frac{1}{10}$. Ramme won without any exertion, and Julin, who was in bad form in consequence of illness, could only manage to make a dead heat with Massa.

Heat 8. 1. ERIC BERGQVIST, Sweden, 1 m. $13\frac{2}{5}$ s. 2. GEORGES RIGAL,, France, 1 m. $17\frac{4}{5}$. Not placed: Ladislaus Szentgróthy, Hungary.

As may be seen, the very first round gave some extraordinary results, a fresh world's record being set by Kahanamoku, while, in addition, no less than five other men swam the 100 metres in 1 m. 6 s., or less.

Second Round.

1.30 p.m., Sunday, 7 July.

Heat 1. 1. K. BRETTING, Germany, 1 m. $4\frac{1}{5}$ s. 2. W. LONGWORTH, Australasia, 1 m. $5\frac{1}{5}$ s. 3. H. H. HARDWICK, Australasia, 1 m. 6 s. 4. R. ANDERSSON, Sweden, 1 m. $9\frac{5}{10}$ s. There was a long struggle for first place between Longworth and Bretting, but at length the latter went to the front and won by a second.

Heat 2. 1. DUKE KAHANAMOKU, U. S. A., 1 m. $3\frac{4}{5}$ s. 2. W. RAMME, Germany) 1 m. $7\frac{4}{5}$ s. 3. M. RITTER, Germany, and N. NERICH, U. S. A, 1 m. $8\frac{4}{5}$ s. Kahanamoku made a magnificent spurt 30 metres from the finish, and won with comparative ease. A dead heat for third place.

Heat 3. 1. K. HUSZAGH, U. S. A., 1 m. $4\frac{1}{5}$ s. 2. P. MC. GILLIVRAY, U. S. A., 1 m. $4\frac{2}{5}$ s. 3. C. HEALY, Australasia, 1 m. $4\frac{4}{5}$ s. 4. L. BOARDMAN, Australasia, 1 m. $5\frac{2}{5}$ s. 5. P. RADMILOVIC, Great Britain, 1 m. 19 s. M. MASSA, Italy, was also entitled to start in this heat, but from some misunderstanding, he did not put in an appearance. There was a very hard struggle between the first three men, all of whom did the distance under 1 m. 5 s. As best third in the second round, C. Healy became entitled to take part in the semi-finals. Boardman, too, swam finely and had the excellent time of 1 m. $5\frac{2}{5}$ s.

Semi=Finals.

8 p. m., Sunday, 7 July.

Notice was given that the semi-finals would be decided the same day at 8 p. m. but, owing to some misapprehension, the three representatives of the U. S. A. did not put in an appearance, from their belief that all the seven men who qualified in the second round would swim in the final on the Monday. The semi-finals were started, however, in spite of the absence of the three men, and with the following results:

Heat 1: 1. C. HEALY, Australasia, 1 m. $5\frac{9}{5}$ s., 2. W. RAMME, Germany, 1 m. $5\frac{4}{5}$ s, 3. W. LONGWORTH, Australasia, 1 m. $6\frac{1}{5}$ s. A hard struggle for first honours. Longworth, even now, was suffering from the affection — suppuration in the head, — for which, on the following day, he had to submit to an operation.

Heat 2: 1. K. BRETTING, Germany, 1 m. $4\frac{8}{5}$ s., W. O.

At a meeting of the International Swimming Jury, it was declared that no mistake had been committed by the leaders of the competition, but that the three representatives of the U. S. A. should be allowed to swim in a special heat to qualify for the final, the first man in this extra heat having to swim the distance in better time than the third man in Heat 1 of the semi-final, while, in the event of this being done, the second man in the extra heat would also be allowed to swim in the final, which was put off until Wednesday, July 10. The extra heat in question took place on Tuesday, July 9, when M. Massa (Italy), who, in consequence of a misunderstanding, had not swum in the second round, was also given permission to start. The result was as follows:

Heat 3. 1. Duke Kahanamoku, U. S. A., 1 m. $2\frac{2}{5}$ s., *World's record.* 2. K.

Huszagh, U. S. A., 1 m. $6\frac{1}{8}$ s., 3. P. MC Gillivray, U. S. A., 1 m. $6\frac{1}{8}$ s. Kahana-moku beat his own record in the first round by $\frac{1}{8}$ second. There was only a hand's breadth between Huszagh and Gillivray. M. Massa retired.

Final.

Wednesday, 10 July.

- | | | |
|-------------------------------|-----------------------------|------------------------|
| 1. DUKE PAOA KAHANAMOKU | U. S. A. | 1 m. $3\frac{2}{5}$ s. |
| 2. CECIL HEALY | Australasia ... | 1 m. $4\frac{3}{5}$ s. |
| 3. KENNETH HUSZAGH..... | U. S. A. | 1 m. $5\frac{3}{5}$ s. |
| Not placed: | | |
| Kurt Bretting | Germany | 1 m. $5\frac{4}{5}$ s. |
| Walther Ramme | » | |
| William Longworth..... | Australasia, did not start. | |

Bretting seemed very nervous, and the start had to be made over again on his account. The struggle was severest during the first half of the race and it was not before 50 met. had been covered that Kahanamoku showed in front. Huszagh and the two Germans then lay side by side, with Healy a couple of metres in the rear. In the finish, Healy made a extraordinary spurt and made himself a safe second. Only a decimetre separated Huszagh and Bretting. It was a grand race between the swiftest swimmers in the world, only Longworth being unfortunately absent in consequence of illness.

400 METRES, FREE STYLE.

First Round.

12,10 p.m., Thursday, 11 July.

Heat 1 1. HAROLD H. HARDWICK, Australasia, 5 m. 36 s., 2. MALCOLM CHAMPION, Australasia, 5 m. 37 s., 3. James Reilly, U. S. A., 6 m. $10\frac{1}{8}$ s., 4. Nils Erik Haglund, Sweden, 6 m. $23\frac{3}{8}$ s., 5. David Baiardo, Italy. Mario Massa, Italy, retired. The swimmers got away at the second attempt, Hardwick then taking the lead, followed by his countryman, Champion. During the last 100 met. Champoin lessened the distance between himself and Hardwick, but without seriously threatening the latter. The American lay more than a quarter of a length behind.

Heat 2: 1. THOMAS SYDNEY BATTERSBY, Great Britain, 6 m. $3\frac{3}{8}$ s., 2. JOHN HAAKON JOHNSEN, Norway, 6 m. $14\frac{2}{8}$ s., 3. Johan Eskil Wedholm, Sweden, 6 m. $29\frac{4}{8}$ s. Parell Awksentjeff, Russia, retired. Battersby led the whole way, and won as he liked.

Heat 3: 1. MAX RITTER, Germany, 5 m. $44\frac{9}{8}$ s., 2. ALOIS KENYERY, Hungary, 5 m. 46 s., 3. NICHOLAS T. NERICH, U. S. A., 5 m. $50\frac{2}{8}$ s., B. D. Teander, Sweden, retired. Theodore Tartakover, Australasia, retired. There was a hot struggle between Ritter and Kenyery, until the German won in the spurt. Nerich, as best third man, qualified for the second round.

Heat 4: 1. BÉLA VON LAS-TORRES, Hungary, 5 m. $36\frac{1}{8}$ s., 2. HENRY TAYLOR, Great Britain, 5 m. $48\frac{2}{8}$ s., Nicolas Woronkoff, Russia, retired. The Hungarian led from the start, and went away from Taylor during the last 100 met.

Heat 5: 1. CECIL HEALY, Australasia, 5 m. 34 s. *World's record.* 2. JOHN GATENBY HATFIELD, Great Britain, 5 m. $35\frac{3}{8}$ s., 3. Franz Schuh, Austria, 6 m. $9\frac{3}{8}$ s. At the first turn, Healy and Hatfield were level, with Schuh a good way behind. At the second, Healy had gained a little, this lead being increased to 4 metres at the third turn. During the last length, however, Hatfield came on rapidly and

pressed the leader hard, but the Australian kept his place and covered the distance in record-time.

Heat 6: 1. GEORGE RITCHIE HODGSON, Canada, 5 m. $50\frac{3}{5}$ s., 2. WILLIE FOSTER, Great Britain, 5 m. $52\frac{2}{5}$ s., 3. Oscar Schiele, Germany, 5 m. 57 s., 4. George A. Godfrey, South Africa, 6 m. $30\frac{3}{5}$ s., 5. Harry Christian Hedegaard, Denmark, 7 m. $7\frac{4}{5}$ s. The men got away after a false start, Hodgson leading from the very first, with Foster next behind him. Godfrey and Schiele lay side by side. In the second length Foster tried to get in front, but the Canadian kept the lead without difficulty. Godfrey fell somewhat behind Schiele. Hodgson won without any effort.

Semi=Finals.

7 p. m. Saturday, 13 July.

Heat 1: G. R. HODGSON, Canada, 5 m. $25\frac{2}{5}$ s., *World's record*, 2. J. G. HATFIELD, Great Britain, 5 m. $25\frac{3}{5}$ s., 3. W. Foster, Great Britain, 5 m. 49 s., 4. N. T. Nerich, U. S. A., 5 m. 51 s., 5. T. S. Battersby, Great Britain, 5 m. $51\frac{1}{5}$ s., 6. J. H. Johnsen, Norway. Nerich at once took the lead, but he had to resign his place to Hodgson at the first turn. Then Hatfield drew level with Nerich, who was obliged to relax his efforts and fall behind, being passed soon after by Foster. At 200 metres, Hatfield was almost level with Hodgson, who was pressed very closely by the young Englishman during the last length, the Canadian beating Hatfield only by $\frac{1}{5}$ s. The winner beat Cecil Healy's record, made in the first round, by almost 9 s.

Heat 2: 1. H. H. HARDWICK, Australasia, 5 m. 31 s., 2. BÉLA VON LAS-TORRES, Hungary, 5 m. $34\frac{4}{5}$ s., 3. C. HEALY, Australasia, 5 m. $37\frac{4}{5}$ s., 4. M. Champion, Australasia, 5 m. 38 s., 5. H. Taylor, Great Britain, 5 m. $48\frac{1}{5}$ s. Hardwick took the lead, with Healy and Las-Torres as his nearest men. After the second turn Champion took third place. In the middle of the third length Hardwick was leading Bela von Las-Torres, who was now second man, with Champion and Healy level a little way behind. During the sixth length, the Hungarian made an energetic attempt to pass Hardwick and the pace increased considerably. The Australian succeeded in shaking off his rival, however, and won in the final spurt without much effort. Healy only tried to get third place and, beating Champion by a powerful spurt, qualified for the final, as best third man.

Final.

7 p. m. Sunday 14 July.

1. GEORGE RITCHIE HODGSON.....	Canada	5 m. $24\frac{2}{5}$ s.
	World's record.	
2. JOHN GATENBY HATFIELD	Great Britain.....	5 m. $25\frac{4}{5}$ s.
3. HAROLD H. HARDWICK	Australasia	5 m. $31\frac{1}{5}$ s.
	Not placed:	
Cecil Healy	Australasia	5 m. $37\frac{4}{5}$ s.
Béla von Las-Torres	Hungary	5 m. 42 s.

Hodgson took the lead from the first, closely followed by Hardwick, the two men turning almost simultaneously at the 200 met. mark. Hatfield now increased his pace and, at the last turn, had almost caught up the Australian; he soon passed him and then threatened Hodgson, who won, but not with much to spare. Hardwick finished with a grand spurt, but he could not manage to catch Hatfield. Healy and Las-Torres did not appear to be in good form.

1,500 METRES, FREE STYLE.

First Round.

7 p.m., Saturday 6 July.

Heat 1: 1. WILHELM ANDERSSON, Sweden, 23 m. $12\frac{1}{5}$ s., 2. MALCOLM CHAMPION, Australasia, 23 m. 34 s., 2. B. Henry Taylor, Great Britain, 24 m. $6\frac{2}{5}$ s., Herbert Mauritz Wetter, Norway, retired. The three first-named kept together until the 7th turn, when the Swede began to leave the others. At half distance the Swede was 15 met. in front of Champion, who, in his turn, had gone away from Taylor, who qualified, however, as best third, for the semi-final.

Heat 2: 1. BÉLA VON LAS-TORRES, Hungary, 22 m. 58 s., 2. JOHN GATENBY HATFIELD, Great Britain, 23 m. $16\frac{3}{5}$ s., 3. Auguste Caby, France, retired. The Hungarian led the whole way.

Heat 3: 1. GEORGE RITCHIE HODGSON, Canada, 22 m. 23 s. *World's record*, 2. WILLIAM LONGWORTH, Australasia, 23 m. $3\frac{3}{5}$ s., 3. Harry Christian Hedegaard, Denmark, 28 m. $32\frac{3}{5}$ s. Hodgson won as he liked.

8.20 p. m., Sunday, 7 July.

Heat 4: 1. THOMAS SYDNEY BATTERSBY, Great Britain, 23 m. 58 s., 2. FRANZ SCHUH, Austria, 25 m. $19\frac{4}{5}$ s., 3. Johan Eskil Wedholm, Sweden, 27 m. 38 s. Mario Massa, Italy, retired. Battersby won as he liked.

Heat 5: 1. HAROLD H. HARDWICK, Australasia, 23 m. $23\frac{1}{5}$ s., 2. WILLIE FOSTER, Great Britain, 23 m. $52\frac{1}{5}$ s., 3. John Haakon Johnsen, Norway, 25 m. $45\frac{3}{5}$ s., 4. Karl Gustaf A. Collin, Sweden, 27 m. $5\frac{1}{5}$ s. Parell Awksentjef, Russia, retired.

Semi-Finals.

12.35, Tuesday, 9 July.

Heat 1: G. R. HOUGSON, Canada, 22 m. 26 s., 2. J. G. HATFIELD, Great Britain, 22 m. $33\frac{3}{5}$ s., 3. H. H. HARDWICK, Australasia, 23 m. 14 s., 4 W. Andersson, Sweden, 23 m. $14\frac{2}{5}$ s.; Henry Taylor, Great Britain, retired. Franz Schuh, Austria, did not start. In this heat, the best four men in the competition met. After 200 metres had been covered, the four foreigners lay abreast, with Andersson about 10 metres in the rear. After the second turn, Hodgson began to leave the other swimmers, Hatfield being second man. The Swede, who was still last, then passed Taylor, who thereupon retired. At the 800 metres mark, the position of the men was as follows: Hodgson first, with Hatfield, Hardwick and Andersson, 10, 20 and 40 metres behind the leader. At the twelfth turn, Hatfield was 25 metres behind the Canadian, and the Australian was another 40 met. behind the Englishman. Andersson now came on and, at the last turn, succeeded in passing Hardwick, who, however, in the spurt, by means of a murdering crawl, succeeded in throwing himself in front and placing himself third, thereby qualifying for the final.

Heat 2: 1. BÉLA VON LAS-TORRES, Hungary, 23 m. $9\frac{4}{5}$ s., 2. M. CHAMPION Australasia, 23 m. $24\frac{1}{5}$ s., 3. W. Foster, Great Britain, 23 m. $32\frac{1}{5}$ s., 4. T. S. Battersby, Great Britain. W. Longworth, Australasia, did not start. After the third turn, the Hungarian left the others behind him, and led all the way to the finish. There was a long struggle for second place which was finally decided in favour of Champion who put himself in front at the finish.

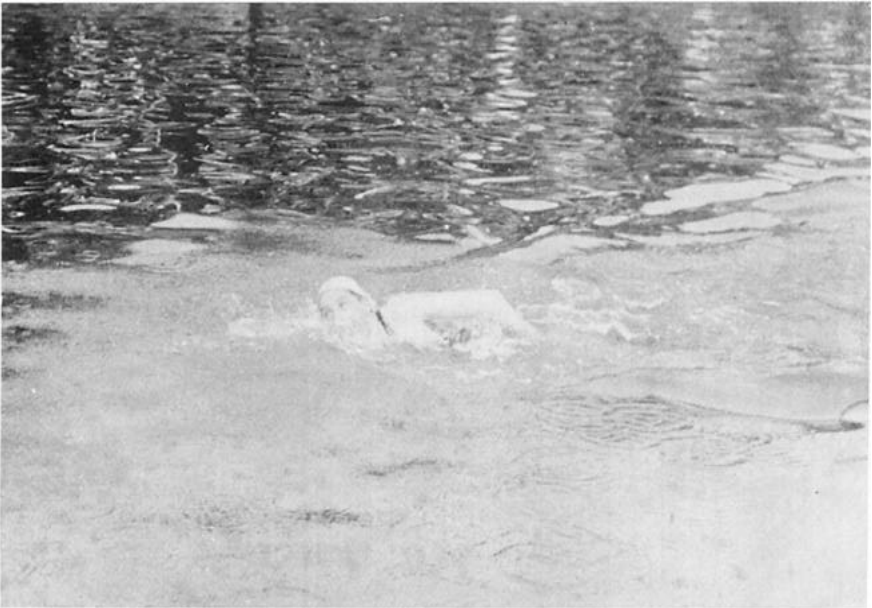

LONG DISTANCE SWIMMING. G. HODGSON (Canada).

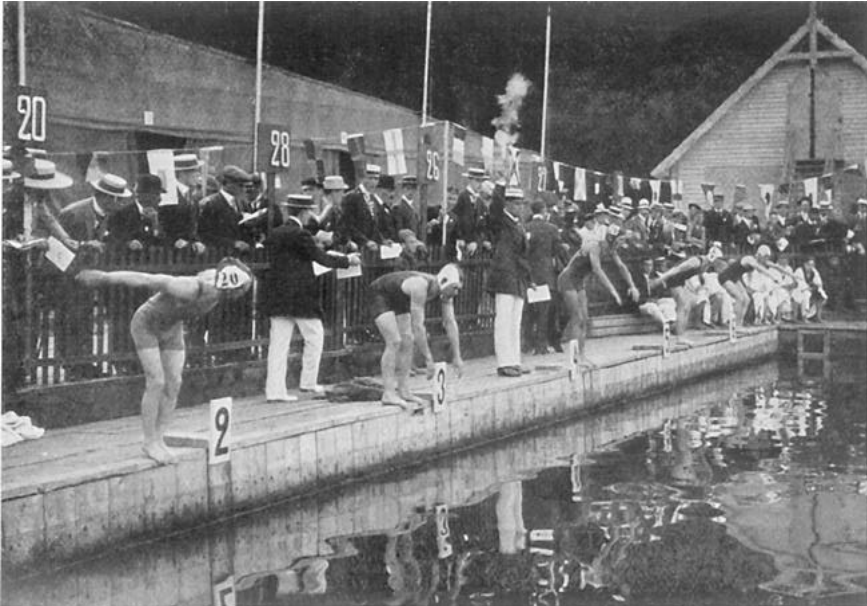

START FOR SWIMMING RACE.

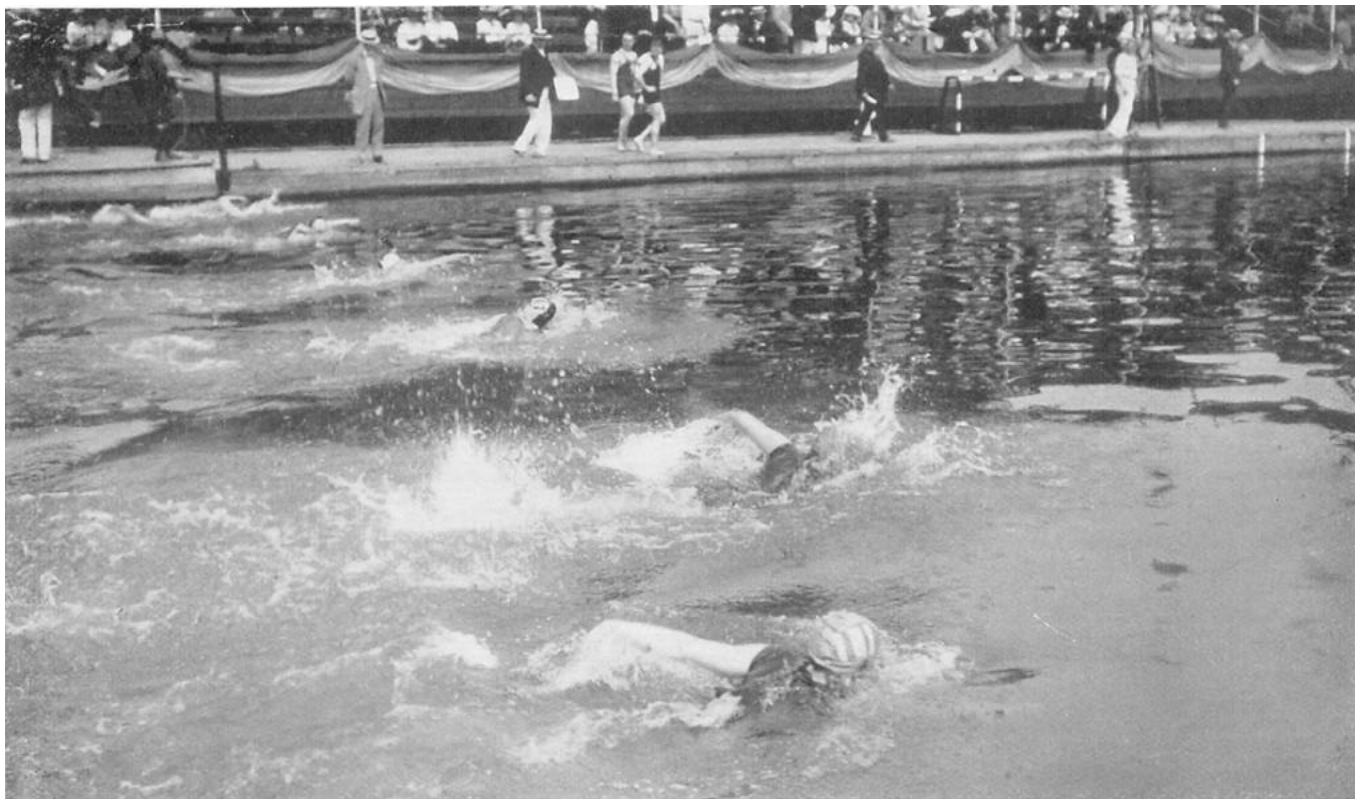

100 M. FREE STYLE. LADIES. FINAL.

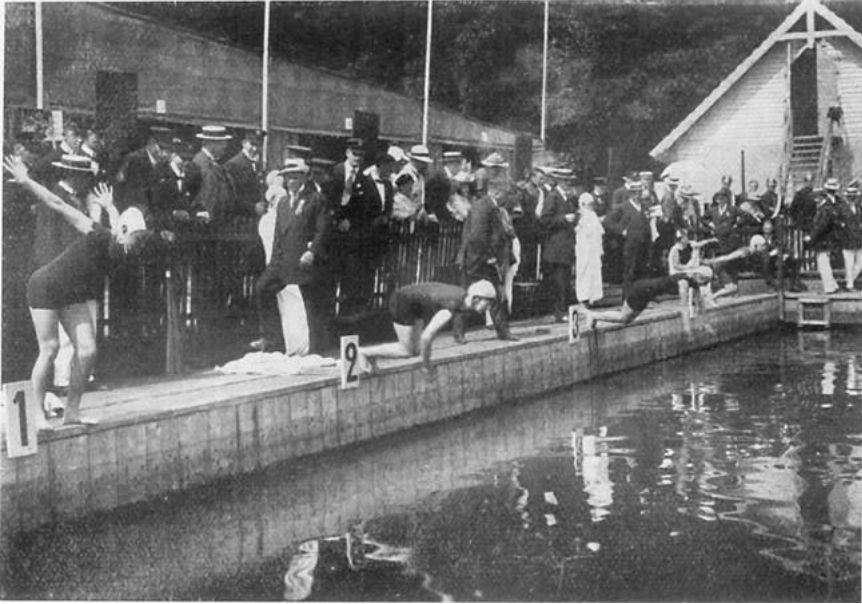

START FOR TEAM RACE, LADIES, 400 METRES.

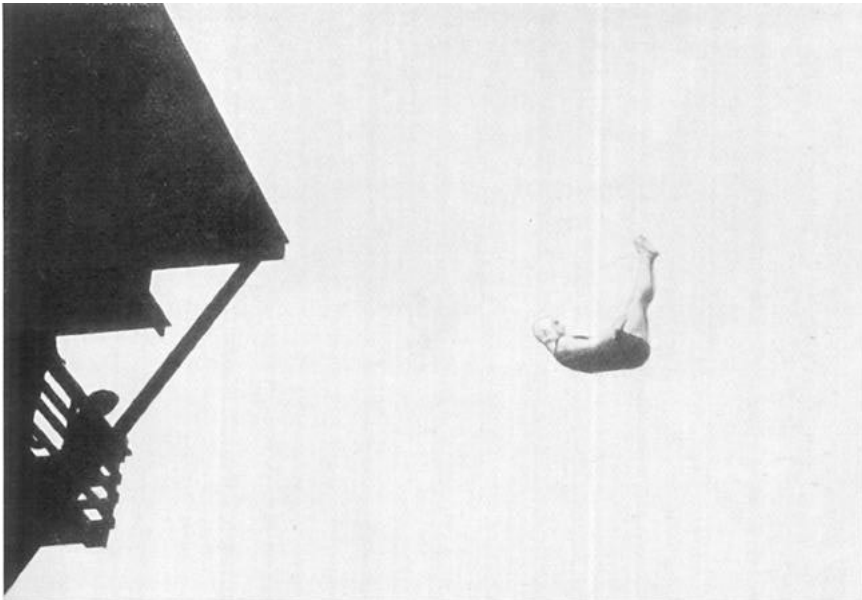

PLAIN AND VARIETY DIVING. ALBERT ZÜRNER (Germany), 2:nd prize.

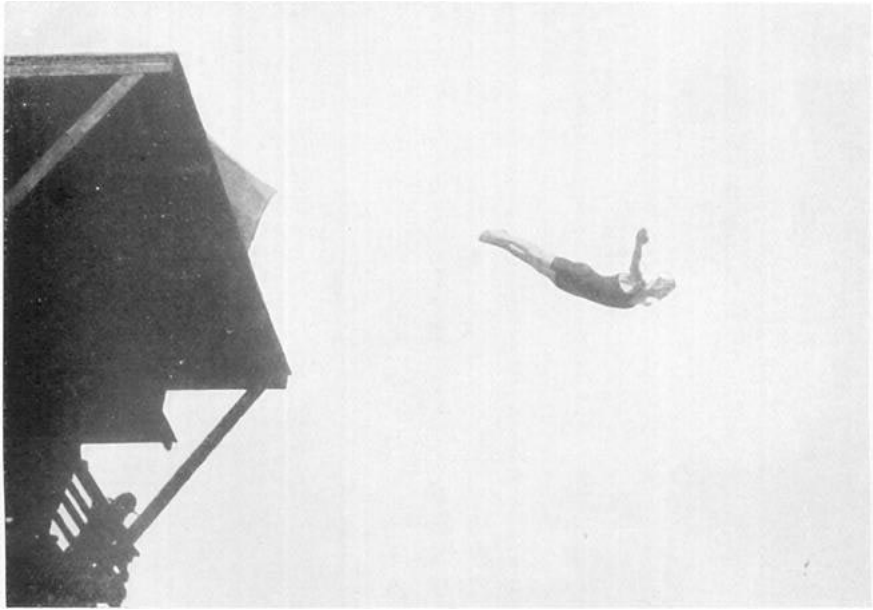

PLAIN DIVING, MEN. ERIK ADLERZ (Sweden), 1:st. prize.

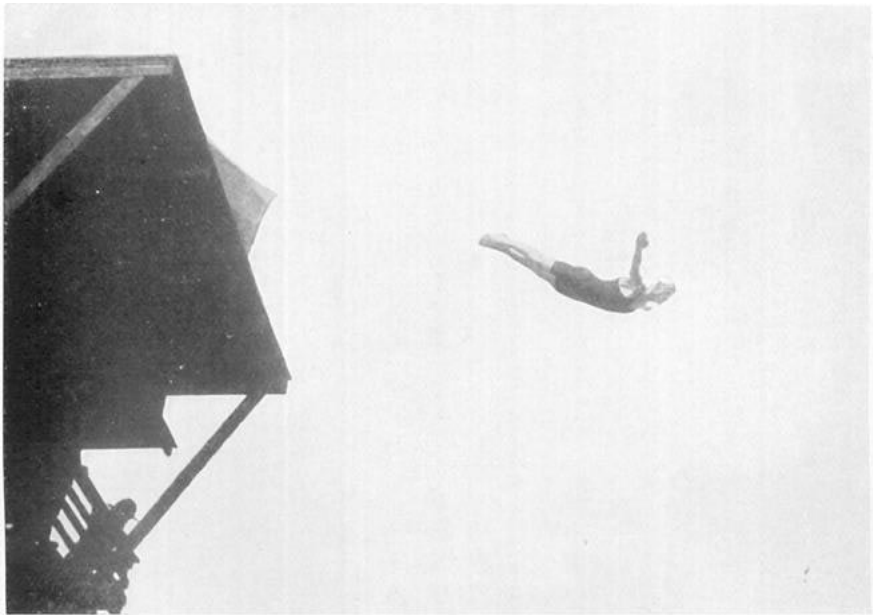

PLAIN DIVING, MEN. TOIVO ARO (FINLAND).

Final.

7:40 p.m. Wednesday, 10 July.

- | | | | |
|----|--------------------------|--------------------|---|
| 1. | G. R. HODGSON | Canada..... | 22 m. |
| | <i>World's Record.</i> | | |
| 2. | J. G. HATFIELD | Great Britain..... | 22 m. 39 s. |
| 3. | HAROLD H. HARDWICK | Australasia | 23 m. 15 ² / ₅ s. |

Not placed.

Malcolm Champion..... Australasia, retired.

Béla von Las-Torres Hungary, retired.

The Canadian at once took the lead at a great pace, and, at the very first turn, was 10 met. in front of the nearest man, Hardwick (Australasia). At 500 met. this lead had been increased to 25 met., and Hatfield had passed Hardwick. Las-Torres retired at 500 met. and was followed by Champion at 600 met. Hatfield swam finely, leaving Hardwick more and more in the rear. Hodgson's time for the 1,000 met. was 14 m. 37 s., a new world's record. At the last turn Hodgson had increased the interval between himself and Hatfield to 40 met., while Hardwick lay another 50 met. behind the latter. The Canadian's time for the 1,500 met. was 22 m. exactly, forming a World's Record, and he went on with the race to try and beat the mile record, which he succeeded in doing, his time for the distance being 23 m. 34¹/₂ s.

BACK STROKE, 100 METRES.

First Round.

12.15 p. m., Tuesday, 9 July.

Heat 1: 1. HARRY HEBNER, U. S. A., 1 m. 21 s., 2. OTTO GROSS, Germany, 1 m. 24 s., 3. Åke Bergman, Sweden, 1 m. 33⁴/₅ s. O. Schiele, Germany, disqualified. Won easily. Hebner swam alternately with arm stroke and a leg crawl.

Heat 2: 1. OTTO FAHR, Germany, 1 m. 22 s., 2. GEORGE HENRY WEBSTER, Great Britain, 1 m. 29²/₅ s., 3. K. Lundevall, Sweden, 1 m. 46⁴/₅ s., Johann Wenk, Hungary, (1 m. 28⁹/₅ s.) disqualified. Fahr led from the start and won as he liked.

Heat 3: 1. ANDRÉAS BARONYI, Hungary, 1 m. 22 s., 2. PAUL KELLNER, Germany, 1 m. 26 s., 3. O. Gregoire, Belgium, 1 m. 29⁴/₅ s., 4. Harry Svendsen, Norway, 1 m. 47¹/₅ s. Won easily.

7 p. m. Tuesday, 9 July.

Heat 4: 1. HERBERT N. HARENAPE, Great Britain, 1 m. 27 s., 2. ERIC SCHULTZE, Germany, 1 m. 27¹/₅ s., 3. GUNNAR SUNDMAN, Sweden, 1 m. 31¹/₅ s., 4. John Haakon Johnsen, Norway, 1 m. 34¹/₅ s. A hard struggle for first place.

Heat 5: 1. LADIKAUS SZENTGRÓTHY, Hungary, 1 m. 26⁹/₅ s., 2. FRANK SANDON, Great Britain, 1 m. 31⁴/₅ s. Won easily.

Semi-Finals.

7 p. m., Wednesday, 10 July.

Heat 1: 1. H. HEBNER, U. S. A., 1 m. 20⁴/₅ s., 2. OTTO FAHR, Germany, 1 m. 21⁴/₅ s., 3. A. BARONYI, Hungary, 1 m. 26¹/₅ s., 4. L. Szengróthy, Hungary, 1 m. 26²/₅ s., 5. E. Schultze, Germany, 6. G. H. Webster, Great Britain. A pretty hard struggle for first place, which Hebner won without any great difficulty after a spurt. Baronyi, by beating his fellow-countryman, Szentgróthy, succeeded in qualifying for the final as best third man.

Heat 2: 1. O. GROSS, Germany, 1 m. 26 s., 2. P. KELLNER, Germany, 1 m. $20\frac{7}{5}$ s., 3. H. N. Haresnape, Great Britain, 1 m. $26\frac{7}{5}$ s., 4. F. Sandon, Great Britain, 1 m. $33\frac{2}{5}$ s., 5. G. Sundman, Sweden, 1 m. $35\frac{5}{8}$ s. A very hard struggle between the first three men.

Final.

7.40 p. m., Saturday, 13 July.

1. HARRY HEBNER	U. S. A.	1 m. $21\frac{1}{5}$ s.
2. OTTO FAHR	Germany	1 m. $22\frac{2}{5}$ s.
3. PAUL KELLNER.....	Germany	1 m. 24 s.
Andréot placed.		
as Baronyi.....	Hungary	1 m. $25\frac{1}{5}$ s.
Otto Gross.....	Germany	1 m. $25\frac{4}{5}$ s.

After a false start, all the men got away together, but Hebner at once took the lead and kept it to the finish. Fahr lay second, with Baronyi nearest behind him. Gross came on at the right-hand side of the course and drew level with the Hungarian, and a hard struggle ensued between these two, but, while this was going on, Kellner, who lay on the outside left, spurted and took third place. Hebner, who kept his head well out of the water and was able to observe his opponents during the whole of the race, won without any difficulty.

BREAST STROKE, 200 METRES.

First Round.

1.50 p. m., Sunday, 7 July.

Heat 1: WILLY LÜTZOW, (Germany, 3 m. $7\frac{2}{5}$ s., 2. TOR HENNING, Sweden, 3 m. 14 s., 3. KARL GUSTAF L. LINDROOS, Finland 3 m. $16\frac{2}{5}$ s., 4. Frank Schryver, Australasia, 3 m. 24 s., Lützow and Henning lay side by side for 150 met., when the German went ahead in a hard spurt and won easily.

Heat 2: PAUL MALISCH, Germany, 3 m. $8\frac{4}{5}$ s., 2. ARVO OSSIAN AALTONEN, Finland, 3 m. 13 s., 3. Nils Gustaf Andersson, Sweden, 3 m. $20\frac{3}{5}$ s., 4. Josef Wastl, Austria, 3 m. $25\frac{3}{5}$ s., 4., George Bajmakoff, Russia, 3 m. 29 s. Malisch swam excellently, and got in much before the Finlander, who swam very powerfully, however.

Heat 3: 1. CARLYLE ATKINSON, Great Britain, 3 m. 12 s. W. O.

Heat 4: 1. WALTER BATHE, Germany, 3 m. $3\frac{2}{5}$ s., 2. PERCY COURTMAN, Great Britain, 3 m. $9\frac{4}{5}$ s., 3., Fredrik Löwenadler, Sweden, 3 m. $2\frac{1}{5}$ s. Michal Mc Dermott, U. S. A., 3 m. $18\frac{1}{5}$ s., disqualified.

Heat 5: 1. FÉLICIEN COURBET, Belgium, 3 m. $12\frac{2}{5}$ s., 2. PONTUS HANSSON, Sweden, 3 m. $14\frac{1}{5}$ s., George Innocent, Great Britain, 3 m. 16 s. Audun Rusten, Norway, 3 m. $30\frac{4}{5}$ s., disqualified. There was a hard battle between Courbet and Hansson. The latter led at first but, after the turn, Courbet went to the front and won in the spurt, Hansson being threatened very seriously towards the finish by Innocent.

Heat 6: OSCAR DEMJAN, Hungary, 3 m. $7\frac{1}{5}$ s., 2. HARALD JULIN, Sweden, 3 m. $12\frac{4}{5}$ s., 3. Herman Cederberg, Finland, 3 m. $18\frac{3}{5}$ s., 4. Wilhelm Lindgren, Finland, 3 m. $21\frac{1}{5}$ s., 5. Sven Hansson, Sweden, 3 m. $24\frac{2}{5}$ s., 6. Oscar Bror Emanuel Hamrén, Sweden. Won easily.

Semi=Finals.

8.15 p. m., Tuesday, 9 July.

Heat 1: 1. P. MALISCH, Germany, 3 m. $9\frac{3}{5}$ s., 2. T. HENNING, Sweden, 3 m. $10\frac{2}{5}$ s., 3. H. Julin, Sweden, 3 m. $10\frac{3}{5}$ s. 4. K. G. Lindroos, Finland, 3 m. $11\frac{1}{5}$ s.

5. C. Atkinson, Great Britain, 3 m. $15\frac{1}{5}$ s., 6. A. O. Aaltonen, Finland, 3 m. 17 s. Henning led at the first turn but, in the last length, Malisch came to the front and won in the spurt. Julin tried hard for second place.

Heat 2: 1. WALTER BATHE, Germany, 3 m. $2\frac{1}{5}$ s., 2. W. LÜTZOW, Germany, 3 m. $4\frac{3}{5}$ s., 3. P. COURTMAN, Great Britain, 3 m. $9\frac{2}{5}$ s., 4. O. Demján, Hungary, 3 m. $11\frac{1}{5}$ s., 5. F. Courbet, Belgium, 3 m. $11\frac{8}{5}$ s. P. Hansson, Sweden, retired. Bathe led from start to finish, closely followed by his fellow-countryman, Lützow.

Final.

7.30 p. m., Wednesday, 10 July.

1. WALTER BATHE	Germany	3 m. $1\frac{4}{5}$ s.
2. WILLY LÜTZOW	Germany	3 m. 5 s.
3. PAUL MALISCH.....	Germany	3 m. 8 s.
Not placed:		
Percy Courtman	Great Britain	3 m. $8\frac{4}{5}$ s.
Tor Henning	Sweden,.....	retired.

Bathe at once took the lead, with Lützow close behind him. At 50 met. Malisch and Henning lay side by side, with Courtman a little in the rear. Henning (Sweden), who was in poor condition, retired after the turn, and a hard struggle began between Malisch and Courtman for third place, which resulted in favour of the first-named. Bathe won safely in the spurt after an excellent piece of work. The Germans took all three places in this competition.

BREAST STROKE, 400 METRES.

First Round.

12 noon, Monday, 8 July.

Heat 1: 1. TOR HENNING, Sweden, 6 m. $52\frac{2}{5}$ s., 2. GEORGE INNOCENT, Great Britain, 7 m. $7\frac{4}{5}$ s., Josef Wastl, Austria, retired; Oscar Demján, Hungary, 6 m. $35\frac{4}{5}$ s., disqualified as, at the second turn he touched the wall with only one hand. After 200 met. the Hungarian went in front of Henning, who was in poor form.

Heat 2: 1. PAUL MALISCH, Germany, 6 m. 47 s., 2. KARL GUSTAF L. LINDROOS, Finland, 7 m., 3. Nils Andersson, Sweden, 7 m. 17 s. Mical MC Dermott, U. S. A., (7 m. 7 s.), disqualified.

Heat 3: 1. WILLY LÜTZOW, Germany, 6 m. $49\frac{4}{5}$ s., 2. FÉLICIEN COURBET, Belgium, 6 m. $52\frac{3}{5}$ s., 3. ZENO VON SIENGALEWICZ, Austria, 7 m. 4 s., 4. Frank Schryver, Australasia, 7 m. $7\frac{4}{5}$ s.

The men were very well matched. At 300 met., the German and the Belgian still lay side by side but, during the last length, Lützow went ahead and won safely.

Heat 4: 1. PERCY COURTMAN, Great Britain, 6 m. $43\frac{4}{5}$ s., 3. ARVO OSSIAN AALTONEN, Finland, 6 m. $48\frac{4}{5}$ s., 3. Wilhelm Lindgren, Finland, 7 m. $12\frac{3}{5}$ s. Aaltonen led at the first turn. At the second and third turns, Courtman was level with him, but after this the Englishman went in front and won without difficulty.

Heat 5: 1. WALTER BATHE, Germany, 6 m. $34\frac{3}{5}$ s., 2. GEORGE BAJMAKOFF, Russia, 7 m. $28\frac{3}{5}$ s., Bathe did this excellent time without being at all pressed.

Semi-Finals.

7.30 p. m., Thursday, 11 July.

Heat 1: 1. W. BATHE, Germany, 6 m. 32 s., 2. T. HENNING, Sweden, 6 m. 32 s., 3. P. COURTMAN, Great Britain, 6 m. $36\frac{3}{5}$ s., 4. Félicien Courbet, Belgium,

6 m. $59\frac{4}{6}$ s., Zeno von Siengalewicz, Austria, retired. Bajmakoff did not start. It was only at the third attempt that the men got away. Henning lost a little at the start and Bathe once took the lead. After the last turn Henning drew level with Bathe, who won by inches in the least fraction of a second. Courtman was close behind. The final spurt was a very hard one.

Heat 2: 1. WILLY LÜTZOW, Germany, 6 m. $44\frac{8}{6}$ s., 2. P. MALISCH, Germany 6 m. $47\frac{3}{6}$ s., 3. A. O. Aaltonen, Finland, 6. m. $56\frac{4}{6}$ s., 4. G. Lindroos, Finland, 7 m. $0\frac{2}{6}$ s., G. Innocent, Great Britain, retired. Aaltonen led at first, with Lützow and Malisch as his nearest men. After the second turn the last-named took the lead, but, in the final length he was passed by Lützow, who won easily.

Final.

7:35 p. m., Friday, 12 July.

- | | | |
|-------------------------|----------------|-------------------------|
| 1. WALTER BATHE | Germany | 6 m. $29\frac{3}{6}$ s. |
| 2. TOR HENNING..... | Sweden | 6 m. $35\frac{2}{6}$ s. |
| 3. PERCY COURTMAN | Great Britain. | 6 m. $36\frac{2}{6}$ s. |

Not placed:

- | | |
|--------------------|----------|
| Paul Malisch | Germany. |
| Willy Lützow | retired. |

Bathe at once took the lead, Malisch being second man and Henning third. After 100 met. Bathe was already 4 met. in front of the two men mentioned, who turned together, with Courtman and Lützow a little behind them. At half distance Henning began to leave Malisch behind him and, after 250 met., Bathe lay 10 met. in front of Henning, who was $\frac{1}{2}$ met. ahead of Malisch. In the last turn, Henning missed and turned badly, while Courtman turned beautifully and drew level with Henning and Malisch. The Swede, however, went ahead again and began to lessen the distance separating him from Bathe. The last-mentioned won, however, without being seriously threatened, but there was a very hard struggle between Henning and Courtman for second place, the Englishman having passed Malisch and lying close behind Henning. Lützow retired on being left behind in the hard spurt.

TEAM RACE, 800 METRES.

First Round.

7 p. m., Friday, 12 July.

Heat 1: 1. U. S. A., (Kenneth Huszagh, Duke Paoa Kahanamoku, Harry Hebner, Percy MC Gillivray) 10m. $26\frac{2}{6}$ s. 2. HUNGARY, (Ladialaus Belesnay, Emmirich Zachár, Alois Kenyery, Béla von Las-Torres) 10 m. $34\frac{3}{6}$ s., 3. GREAT BRITAIN (Willie Foster, Thomas Sydney Battersby, John Gatenby Hatfield, Henry Taylor), 10 m. $39\frac{2}{6}$ s. Huszagh at once took the lead from Belesnay and Foster, and this advantage was still further increased by Kahanamoku. At 300 met. the U. S. A., team lay 8 met. ahead, with Hungary 3 met. in front of Great Britain. In the long stretch of the race, however, Battersby caught up Zachár, so that the third men of the Hungarian and British teams started simultaneously. Gillivray (U. S. A.) increased the distance between himself and Hatfield and Kenyery, who lay abreast at 500 met. At 550 met. the U. S. A. was 20. met. in front of Great Britain, which led Hungary by 1 met. At the last pass, Taylor was able to start a little in front of Las-Torres, and both these men lessened the lead held by Hebner (U. S. A.). Las-Torres, who

swam beautifully, beat Taylor for second place, but he was a good distance behind Hebner at the finish.

Heat 2 : 1. AUSTRALASIA (Harold H. Hardwick, Malcolm Champion, Leslie Boardman and Cecil Healy) 10 m. 14 s. *World's record*. 2. GERMANY (Oscar Schiele, George Kunisch, Kurt Bretting and Max Ritter) 10 m. $42\frac{1}{5}$ s. Australasia won without any difficulty. Hardwick was in front of Schiele at the very first turn, and the distance between the teams was increased by each man of the Australasia four.

Final.

12.45 p. m., Monday, 15 July.

1. AUSTRALASIA 10 m. $11\frac{3}{5}$ s.
World's record.
(Cecil Healy, Malcolm Champion, Leslie Boardman, Harold H. Hardwick).
 2. U. S. A. 10 m. $20\frac{1}{5}$ s.
(Kenneth Huszagh, Harry Hebner, Percy MC Gillivray, Duke Paoa Kahanamoku).
 3. GREAT BRITAIN 10 m. $28\frac{1}{5}$ s.
(Willie Foster, Thomas Sydney Battersby, John Gatenby Hatfield, Henry Taylor.)
- Not placed:
Germany 10 m. 37 s.

The same swimmers started as in the trial heats, but the Australasians altered the order in which their men swam, and placed them: Cecil Healy, Malcolm Champion, Leslie Boardman, Harold H. Hardwick. There was a good start and, at the first pass, Australasia and the U. S. A. lay side by side, with Germany third. The second men of the two leading teams kept together, too, until 300 met. were covered, when Champion succeeded in getting a slight lead for his team. Boardman was able to start 10 met. in front of Hebner and the third man in Great Britain's team, after swimming 50 met., succeeded in passing his German rival. When the fourth distance was begun, Australasia was 15 met. in front of the U. S. A., which, in its turn, was 10 met. before Great Britain, the last man of the British team being 5 met. in front of the German swimmer. Kahanamoku was the fourth man in the U. S. A. team, but he could make no impression on Hardwick, and Australasia won without any difficulty. Great Britain was a safe third. Hungary did not start.

100 METRES, FREE STYLE. LADIES.

First Round.

7.30 p. m., Monday, 8 July.

Heat 1 : 1. BELLA MOORE, Great Britain, 1 m. $29\frac{4}{5}$ s., 2. LOUISE OTTO, Germany, 1 m. $34\frac{2}{5}$ s., 3. Klara Milch, Austria, 1 m. $37\frac{1}{5}$ s., 4. Greta Johansson, Sweden, 1 m. $41\frac{3}{5}$ s., 5. Tyyne Maria Järvi, Finland, 1 m. $42\frac{3}{5}$ s. Aagot Normann, Norway, retired. Bella Moore led at a good pace, and won without being threatened.

Heat 2 : 2. DAISY CURWEN, Great Britain, 1 m. $23\frac{8}{5}$ s., 2. JENNIE FLETCHER, Great Britain, 1 m. $26\frac{1}{5}$ s., 3. Bertha Zahourek, Austria, 1 m. $38\frac{3}{5}$ s., 4. Pepi

Kellner, Austria, 1 m. $41\frac{1}{5}$ s., 5. Karin Lundgren, Sweden, 1 m. $44\frac{4}{5}$ s., Sonja Johnsson, Sweden. Jennie Fletcher got away best, but was soon passed by Daisy Curwen, who won in excellent time.

12 noon, Tuesday, 9 July.

Heat 3: 1. WILHELMINA WYLIE, Australasia, 1 m. $26\frac{4}{5}$ s., 2. MARY LANGFORD, Great Britain, 1 m. 28 s., 3. Hermine Stindt, Germany, 1 m. $29\frac{1}{5}$ s., 4. Josefine Sticker Austria, 1 m. $31\frac{4}{5}$ s., Madame Guttentsteln, Belgium, 6. Elsa Björklund, Sweden. Won without difficulty.

Heat 4: 1. FANNY DURACK, Australasia, 1 m. $19\frac{4}{5}$ S. *World's record.* 2. IRENE STEER, Great Britain, 1 m. $27\frac{1}{5}$ s., 3. WALLY DRESSEL, Germany, 1 m. $28\frac{8}{5}$ s., 4. Margarete Adler Austria, 1 m. $34\frac{2}{5}$ s., 5. Greta Carlsson, Sweden, 6. Regina Kari, Finland. F. Durack won as she liked.

Heat 5: 1. GRETE ROSENBERG, Germany, 1 m. 25 s., 2. ANNIE SPEIRS, Great Britain, 1 m. $25\frac{8}{5}$ s., 3. Vera Thulin, Sweden, 1 m. 44 s. Annie Speirs was left behind at the start, and never succeeded in making up lost ground, although she made a fine attempt to do so.

Semi=Finals.

12 noon, Thursday, 11 July.

Heat 1: 1. F. DURACK, Australasia, 1 m. $20\frac{1}{5}$ s., 2. D. CURWEN, Great Britain, 1 m. $26\frac{4}{5}$ s., 3. A. SPEIRS, Great Britain, 1 m. 27 s., 4. B. Moore, Great Britain 1 m. $27\frac{2}{5}$ s., 5. M. Langford, Great Britain, 1 m. $29\frac{1}{5}$ s., 6. L. Otto, Germany, 1 m. 32 s., Miss Durack, who swims a distinctively Australian crawl, w-on as she liked. There was a very hard fight for second place.

Heat 2: 1. W. WYLIE, Australasia, 1 m. 27 s., 2. J. FLETCHER, Great Britain, 1 m. $27\frac{1}{5}$ s., 3. G. ROSENBERG, Germany, 1 m. $29\frac{1}{5}$ s., 4. V. Dressel, Germany, 1 m. $33\frac{2}{5}$ s., I. Steer, Great Britain (1 m. 29 s.), disqualified. All the swimmers got away together after a false start. Miss Wylie was threatened seriously by Miss Fletcher.

Final.

7.30 p. m., Friday, 12 July..

- | | | |
|---------------------------|----------------------|-------------------------|
| 1. FANNY DURACK | Australasia | 1 m. $22\frac{1}{5}$ s. |
| 2. WILHELMINA WYLIE | Australasia | 1 m. $25\frac{2}{5}$ s. |
| 3. JENNY FLETCHER | Great Britain | 1 m. 27 s. |
| Not placed. | | |
| Grete Rosenberg | Germany | 1 m. $27\frac{1}{5}$ s. |
| Annie Spiers | Great Britain | 1 m. $27\frac{2}{5}$ s. |

Daisy Curwen, who had undergone an operation for appendicitis since the Thursday, could not start. Miss Durack led from start to finish. There was a hard struggle for third place between Miss Fletcher and Frln. Rosenberg.

TEAM RACE, 400 METRES, LADIES.

12 noon., Monday, 15 July.

- | | |
|---|-------------------------|
| 1. GREAT BRITAIN | 5 m. $52\frac{4}{5}$ s. |
| (Bella Moore, Jennie Fletcher, Annie Speirs, Irene Steer.) | |
| 2. GERMANY | 6 m. $4\frac{3}{5}$ s. |
| (Wally Dressel, Luise Otto, Hermine Stindt, Grete Rosenberg.) | |
| 3. AUSTRIA..... | 6 m. 17 s. |
| (Margarete Adler, Klara Milch, Josefine Sticker, C. Zahouch.) | |

Not placed:

Sweden.....

(G. I. Carlsson, A. T. M. Johansson, Sonja Jonsson, V. Thulin.)

As only 4 teams started, nothing but a "Final" was swum. Great Britain showed its superiority from the first moment, and the race never became exciting, as the team mentioned led all the way, while Germany, from beginning to end, was an equally safe second. Great Britain won easily.

Diving Competitions.

HIGH DIVING.

HIGH DIVING FOR MEN.

First Round.

Saturday, 6 July.

Heat 1: PAUL GÜNTHER, Germany, placing, 8, points 36.1. 2. Torsten Eriksson, Sweden pl. 11, p. 35.8. 3. Tauno Hmoniemi, Finland, pl.13. p. 35. 4. Alfred Johansson, Sweden, pl. 14, p. 34.7. 5. Nils Tvedt, Norway, pl. 25, p. 31.7. 6. Sven Elis Holmer, Sweden, pl. 31, p. 30.2. 7. Sigvard Andersen, Norway, pl. 32, p. 28.6. Victor Baranoff, Russia, retired. Tvedt, the Norwegian champion had the task of beginning the Olympic diving competitions. He had an easy, pretty style, though the details were not sufficiently elaborated. Günther dived in a perfectly correct and distinctively German style, but his start was altogether too weak. Alfred Johansson who, perhaps, had the best chances of winning this heat, turned over badly in the first dive from the greatest height and quite ruined his chances.

Heat 2: 1. JOHN JANSSON, Sweden, pl. 5, p. 38.3. 2. (George Wm. Gaidzick, U. S. A., pl. 13, p. 36.2. 3. George Yvon, Great Britain, pl. 17, p. 35.2. 4. G. Ekstrand, Sweden, pl. 18, p. 35.3. 5. Arthur Mc Aleenan, U. S. A., pl. 20, p. 34.9. 6. Carlo Bonfanti, Italy, pl. 32, p. 28.5. 7. Alfred Engelsen, Norway, pl. 33, p. 28.3. Jansson was everyone's superior in this heat and was unanimously placed first by the judges. Gaidzick (U. S. A.) had plenty of power and pace in his dive, together with a careful style, but in one of his attempts he took too hard a start, which he had to rectify by means of a sharp bend. Ekstrand, too, failed in one of his dives. Yvon (Great Britain) dived in good style, taking the greatest height excellently, although his start could have been a quicker one.

Sunday, 7 July.

Heat 3: 1. HJALMAR JOHANSSON, Sweden, pl. 7, p. 40.1. 2. TOIVO NESTORI ARO, Finland, pl. 10, 39.4. 3. AXEL RUNSTRÖM, Sweden, pl. 15, p. 39.3. 4. ERNST MAGNUS BRANDSTEN, Sweden, pl. 19 p. 37.7. 5. VICTOR GUSTAF CRONDAHL, Sweden, pl. 22, p. 37. 6. Hans Lubber, Germany, pl. 27, p. 36.2. 7. Kurt Behrens, Germany, pl. 31, p. 35.1. 8. J. P. Lyons, Canada, pl. 40, p. 32.5. 9. Jens Harald Stefenson, Sweden, pl. 44, p. 31.2. An extraordinarily severe heat, out of which no less than 5 qualified for the final, in which the competitors were entitled to take part only on the points reached. Hjalmar Johansson showed excellent power, speed and elegance, and reached as much as 40.1 points of 50 possible. Aro (Finland) had also a very successful day. He dives in the same style as Hjalmar Johansson, and there was very little between the two men. Aro's running dive from the lowest height was a little weak. Runström, the Swedish champion, was third, with such different placing-figures given by the judges as 2 +1+ 7+ 2 + 3. He jumped in uneven, somewhat stiff style, but with much speed and power. Brandsten jumped excellently, but

General protocol of the competition in High (plain) Diving.

Start N ^o	Name	Nation	Names and decisions of the judges										Total Points	Final points (total points divided by number of judges)	Total Place-figs.	Placing	Rem.
			1. Blid-berg		2. Kihl-mark		3. Asp-lund		4. S. Jo-hansson		5. J.G.An-dersson						
			Points	Place-figure	Points	Place-figure	Points	Place-figure	Points	Place-figure	Points	Place-figure					
<i>Heat I (6 July, 1912).</i>																	
1	Nils Tvedt.....	Norway.....	35.5	5	32	5	28.5	5	30	5	32.5	5	158.5	31.7	25	5	did not start.
2	F. A. Bornamann	U. S. A.....	—	—	—	—	—	—	—	—	—	—	—	—	—	—	»
3	S. E. Holmér ...	Sweden.....	33	6	32	5	27.5	6	28.5	7	30	7	151	30.2	31	6	retired.
4	L. Valentich.....	Austria.....	—	—	—	—	—	—	—	—	—	—	—	—	—	—	»
5	W. Baranoff.....	Russia.....	—	—	—	—	—	—	—	—	—	—	—	—	—	—	»
6	T. Hmoniemi.....	Finland.....	38.5	1	35	4	30.5	4	35.5	1	35.5	3	175	35	13	3	
7	Paul Günther ...	Germany.....	37.5	2	38	2	32.5	2	35.5	1	37	1	180.5	36.1	8	1	
8	T. Eriksson.....	Sweden.....	37.5	2	41.5	1	33.5	1	33.5	3	33	4	179	35.8	11	2	
9	A. Johansson.....	».....	36	4	36	3	31	3	33.5	3	37	1	173.5	34.7	14	4	
10	S. Andersen.....	Norway.....	31.5	7	30	7	20	7	30	5	31.5	6	143	28.6	32	7	
<i>Heat II (6 July, 1912).</i>																	
11	L. Boardman.....	Australasia.....	—	—	—	—	—	—	—	—	—	—	—	—	—	—	did not start.
12	A. Assimacopoulo	Greece.....	—	—	—	—	—	—	—	—	—	—	—	—	—	—	»
13	John Jansson.....	Sweden.....	40	1	40	1	35	1	38.5	1	38	1	191.5	38.3	5	1	
14	C. Bonfanti.....	Italy.....	29.5	6	30	7	21	7	31.5	6	30.5	6	142.5	28.5	32	6	
15	G. Ekstrand.....	Sweden.....	35	5	39	2	31.5	2	36	4	35	5	176.5	35.3	18	4	
16	A. Mc Aleenan...	U.S.A.....	38.5	3	34	5	30	4	36	4	36	4	174.5	34.9	20	5	
17	Walter Weber.....	Germany.....	—	—	—	—	—	—	—	—	—	—	—	—	—	—	»
18	A. Engelsen.....	Norway.....	29	7	32	6	22.5	6	29.5	7	28.5	7	141.5	28.3	33	7	
19	George Yvon ...	Great Britain...	36.5	4	36	4	28.5	5	37	3	38	1	176	35.2	17	3	
20	G. W. Gaidzik...	U. S. A.....	39	2	37	3	31	3	37.5	2	36.5	3	181	36.2	13	2	
<i>Heat III (7 July, 1912).</i>																	
21	J. H. Stefenson..	Sweden.....	33.5	9	30	5	29	9	33.5	9	30	9	156	31.2	44	9	
22	V. G. Crondahl..	».....	37.5	5	36	8	37	2	38	5	36.5	5	185	37	22	5	
23	A. Runström.....	».....	40	2	40	1	31.5	7	42.5	2	37.5	3	191.5	38.3	15	3	
24	Kurt Behrens ...	Germany.....	36	7	33	7	34	5	38	5	34.5	7	175.5	35.2	31	7	
25	Hans Lubert.....	».....	37	6	36	5	34	5	38	5	36	6	181	36.2	27	6	
26	Toivo N. Aro.....	Finland.....	39	3	38	3	37.5	1	42.5	2	40	1	197	39.4	10	2	
27	J. P. Lyons.....	Canada.....	34	8	30	8	29.5	8	35.5	8	33.5	8	162.5	32.5	40	8	
28	R. Zimmerman ...	».....	—	—	—	—	—	—	—	—	—	—	—	—	—	—	»
29	E. M. Brandsten	Sweden.....	39	3	37	4	36.5	4	39	4	37	4	188.5	37.7	19	4	
30	Hj. Johansson ...	».....	41	1	39	2	37	2	43.5	1	40	1	200.5	40.1	7	1	
<i>Heat IV (9 July, 1912).</i>																	
31	Leo O. Suni.....	Finland.....	34	4	30	4	27	7	36.5	3	33	4	160.5	32.1	22	5	
32	Elias Arnesen...	Norway.....	—	—	—	—	—	—	—	—	—	—	—	—	—	—	»
33	G. A. Godfrey...	South Africa.....	—	—	—	—	—	—	—	—	—	—	—	—	—	—	»
34	A. M. Nyman.....	Finland.....	32.5	6	30	4	29	5	34.5	4	34	2	160	32	21	4	
35	K. Kainuvaara ..	».....	35	3	32	2	31	2	34.5	4	33.5	3	166	33.2	14	3	
36	S. M. Montan.....	Sweden.....	32.5	6	27	7	29.5	4	30.5	7	31.5	7	151	30.2	31	7	
37	A. Zümer.....	Germany.....	33.5	5	29	6	29	5	34	6	33	4	158.5	31.7	26	6	
38	Eric Adlerz.....	Sweden.....	40	1	37	1	40	1	41.5	1	41	1	199.5	39.9	5	1	
39	O. W. Wetzell...	Finland.....	36	2	32	2	30	3	38	2	33	4	169	33.8	13	2	
<i>FINAL (11 July, 1912).</i>																	
7	Paul Günther ...	Germany.....	—	—	—	—	—	—	—	—	—	—	—	—	—	—	retired.
13	J. Jansson.....	Sweden.....	39.5	4	38	3	40.5	2	39.5	2	38	1	195.5	39.1	12	III	
22	V. G. Crondahl..	».....	41	2	38	3	34.5	7	37	4	35	6	185.5	37.1	22	4	
23	A. Runström.....	».....	37	6	38	3	35	6	37	4	33	7	180	36	26	6	
26	Toivo N. Aro.....	Finland.....	38	5	35	7	38.5	4	33.5	7	37.5	3	182.5	36.5	26	5	
29	E. M. Brandsten	Sweden.....	37	6	36	6	37.5	5	35	6	35.5	5	181	36.2	28	7	
30	Hj. Johansson ...	».....	40	3	40.5	1	39.5	3	40	1	36.5	4	196.5	39.3	12	II	
38	Eric Adlerz.....	».....	42.5	1	40.5	1	41	1	38	3	38	1	200	40	7	I	

his style was not so clean as that of the three men already mentioned. Crondahl, who was the last in this heat to qualify for the final, had a beautifully finished style, with the speed of an athlete in the start, but he did poorly in the running dive from the lowest height. The Germans in this heat were pretty good but started too tamely, and had too little speed and power in the dive to be placed.

Heat 4: 1. ERIC ADLERZ, Sweden, pl. 5, p. 39.9. 2. Oskar W. Wetzell, Finland, pl. 13, p. 33.8. 3. Kalle Kainuvaara, Finland, pl. 14, p. 33.2. 4. Albert Mikael Nyman, Finland, pl. 21, p. 32. 5. Leo Olavi Suni, Finland, pl. 22, p. 32.1. 6. Albert Zürner, Germany, pl. 26, p. 31.7. 7. Sven Magnus Montan, Sweden, pl. 31, p. 30.2. Adlerz was in a class by himself, and was the only man that qualified for the final. He came very near to Hjalmar Johansson's figures, although he had to rectify his first dive from the greatest height by a slight bend, and he went a little too far over in his last dive from the same height, too. The Finlanders were pretty good, but were very uncertain. Zürner (Germany), who was much feared, had a bad day, and failed altogether in his dive from the greatest height.

Final.

Thursday 11 July.

		Place-figures	Points
1.	ERIK ADLERZ	Sweden..... 7	40
2.	HJALMAR JOHANSSON	Sweden	12 39.3
3.	JOHN JANSSON,	Sweden	12 39.1
	Not placed:		
	G. V. Crondahl,	Sweden	22 37.1
	Toivi N. Aro	Finland	26 36.5
	A. Runström,	Sweden	26 36
	E. M. Brandsten.....	»	28 36.2
	Paul Günther, Germany, ... retired.		

Adlerz jumped evenly and in good style, and obtained 40 points, being placed 1 + 1 + 1 + 1 + 3 by the judges. His pace and power in the dive were extraordinary and, in each dive, he went at such a speed that no little twisting of the body arose, this lowering his points considerably. Hjalmar Johansson, whom two of the judges placed as n:r 1 (one of them setting him equal with Adlerz), two n:r 3 and one as n:r 4, had not a such a good day as in the trial on Sunday. His last dive from the greatest height was very successful, however, and carried him in front of Jansson, who with the place-figures 1 + 2 + 2 + 3 + 4 was a good aspirant for second honours. Both gained the same place-figures and there was a difference of only $\frac{1}{5}$ of a point between them. Jansson dives confidently, although his style is a little stiff, and he has plenty of pace. Crondahl dived excellently from the greatest height, while Aro, the Finlander, who was in front after the diving at the lowest height, quite spoiled his chances by an unsuccessful dive from the highest platform. Runström, who also failed in a dive from the greatest height, was very close to Aro, obtaining the same place-figures as the latter. In his first dive from the greatest height, Günther (Germany) struck one arm against his head in the entry into the water, causing a sprain which prevented him from taking further part in the competition.

PLAIN AND VARIETY DIVING COMBINED.

First Round.

Friday, 12 July.

Heat 1: HJALMAR JOHANSSON, Sweden, pl. 9, p. 68.06. 2. ALBERT ZÜRNER, Germany, pl. 14, p. 65.04. 3. Hans Lubber, Germany, pl. 23, p. 61.66. 4. Gösta Sjöberg, Sweden, pl. 24, p. 62.08. 5. Ernst Magnus Brandsten, Sweden, pl. 24, p. 61.42. 6. George W. Gaidzick, U. S. A., pl. 25, p. 62.56. 7. John Jansson, Sweden, pl. 27, p. 59.75. 8. Kurt Behrens, Germany, p. 33, p. 58.35. 9. Leo Olavi Suni, Finland, pl. 45, p. 48.93. Although this was the heat that, beforehand, everybody had expected would be the most hotly contested, no one dived in first class style. Gaidzick (U. S. A.) dived best, and would probably had won the heat if he had executed his flying somersault in accordance with the rules. In the programme he had chosen ordinary somersault and flying somersault, but he executed both of the dives in much the same way. Three of the judges considered that there was no principal difference between his two dives, and as the rules prescribe that the voluntary dives must be of a different nature, they gave him 0 for his flying somersault. Two of the judges accepted the dive, however, and one of these judges placed Gaidzick first, while the other placed him second on the list. Hjalmar Johansson, who had been the victor at the Olympic Games of London in 1908, had no good day, but his confident style put him first in the heat. Brandsten dived evenly and well, while Sjöberg, who had plenty of pace and good bearing in the air, quite spoiled his chances by a wretched entry into the water. Jansson's prospects were spoiled by failures in the voluntary dives. Zürner was best among the Germans, but did not show really good form, while Lubber was put out of the running by a totally unsuccessful "Isander". Only Hjalmar Johansson and Zürner qualified for the final.

Heat 2: 1. ERIC ADLERZ, Sweden, pl. 6, pl. 74.76. 2. GUSTAF BLOMGREN, Sweden, pl. 9, p. 68.5. 3. HARALD ARBIN, Sweden, pl. 15, p. 62.75. 4. Ernst Eklund, Sweden, pl. 20, p. 59.9. 5. Sigvard Andersen, Norway, pl. 25, p. 56.4. 6. Oskar Wilhelm Wetzell, Finland, pl. 32, p. 50.46. 7. Kalle Kainuvaara, Finland, pl. 33, p. 48.1. A. Mc Aleenan, U. S. A., retired. Adlerz and Blomgren were the only competitors of real class in this heat. Although Adlerz was placed after Blomgren by one of the judges, he was indisputably the better man. He did not quite succeed, however, in his plain dive from the highest platform; the running dive especially was very mediocre. Arbin succeeded in getting $\frac{7}{10}$ point more than Sjöberg, and thus qualified for the final. Kainuvaara (Finland) dived very unevenly, and gave specimens both of excellent and bad diving. Mc Aleenan (U. S. A.) injured himself in the $1\frac{1}{2}$ somersault from the greatest height and retired from the contest.

Heat 3: ALVIN CARLSSON, Sweden, pl. 7, p. 66.98. 2. GEORGE YVON, Great Britain, pl. 9, p. 65.7. 3. TOIVO N. ARO, Finland, pl. 16, p. 62.75. 4. Robert Andersson, Sweden, pl. 18, p. 60.59. 5. Jens Harald Stefenson, Sweden, pl. 25, p. 41.54. J. P. Lyons, Canada, retired. Carlsson had an uncommonly good day and dived with great confidence and in fairly good form. He was placed first by three of the judges, and second by two, while Yvon (Great Britain), who also dived well, was placed first by two of the judges. Robert Andersson, who was fourth man in the London competitions in 1908, came very near Aro, but did not threaten him seriously.

General protocol of the competition in Plain and Variety Diving combined.

Start N ^o	Name	Nation	Names and decisions of the judges										Total Points	Final points (total points divided by number of judges)	Total Place-fgs.	Placing	Rem.
			1. Kihlmark		2. S. Johansson		3. Malmström		4. Wennerström		5. J.G. Andersson						
			Points	Place-figure	Points	Place-figure	Points	Place-figure	Points	Place-figure	Points	Place-figure					
<i>Heat I (12 July, 1912).</i>																	
1	Albert Zürner ...	Germany	66.6	2	58.1	5	63.6	2	67.5	4	69.4	1	325.2	65.04	14	2	
2	Hj. Johansson ...	Sweden	65.5	3	66.8	1	69.3	1	73.2	1	65.5	3	340.3	68.06	9	1	
3	E. Brandsten	"	59.2	5	58.85	4	62.55	4	67.1	5	59.4	6	307.1	61.42	24	5	
4	John Jansson	"	56.5	7	60.75	2	55.3	8	68.95	3	57.25	7	298.75	59.75	27	7	
5	F. R. Bornamann..	U. S. A.	—	—	—	—	—	—	—	—	—	—	—	—	—	—	did not start.
6	G. W. Gaidzik ...	"	71.4	1	53.45	8	60.6	6	72.6	2	54.75	8	312.8	62.56	25	6	
7	Hans Lubber	Germany	59.2	5	57.7	6	62.8	3	62.8	7	65.8	2	308.3	61.66	23	3	
8	G. Sjöberg	Sweden	62.6	4	59.5	3	60.5	7	62.9	6	64.9	4	310.4	62.08	24	4	
9	A. Engelsen	Norway	—	—	—	—	—	—	—	—	—	—	—	—	—	—	»
10	Kurt Behrens ...	Germany	55.6	8	54.3	7	61.5	5	60.5	8	59.85	5	291.75	58.35	33	8	
11	Leo O. Sumi	Finland	50.8	9	47.9	9	46.5	9	50.55	9	48.9	9	244.65	48.93	45	9	
<i>Heat II (12 July, 1912).</i>																	
12	O. W. Wetzell ...	Finland	42.2	7	49.8	6	48.8	7	58.6	6	52.9	6	252.3	50.46	32	6	
13	G. A. Godfrey ...	South Africa	—	—	—	—	—	—	—	—	—	—	—	—	—	—	»
14	A. Mc Aleenan...	U. S. A.	—	—	—	—	—	—	—	—	—	—	—	—	—	—	retired.
15	Harald Arbin ...	Sweden	56.8	3	65.65	3	60.6	3	68.65	3	62.05	3	313.75	62.75	15	3	
16	K. Kainuvaara ...	Finland	42.4	6	46.8	7	50.6	6	49.8	7	50.9	7	240.5	48.1	33	7	
17	H. E. Burton ...	U. S. A.	—	—	—	—	—	—	—	—	—	—	—	—	—	—	did not start.
18	G. Blomgren	Sweden	65.8	1	66.75	2	68.9	2	73.25	2	67.8	2	342.5	68.5	9	2	
19	Ernst Eklund ...	"	56.6	4	62.3	4	58.8	4	63	4	59	4	299.7	59.94	20	4	
20	Eric Adlerz	"	63.6	2	76.8	1	75.3	1	81.1	1	77	1	373.8	74.76	6	1	
21	S. Andersen	Norway	48.6	5	56.3	5	58.3	5	62	5	56.8	5	282	56.4	25	5	
<i>Heat III (12 July, 1912)</i>																	
22	A. Carlson	Sweden	63	1	68.1	2	64.7	2	72.9	1	66.2	1	334.9	66.98	7	1	
23	R. Andersson ...	"	55.7	4	63.05	3	59.25	4	69.8	3	55.15	4	302.95	60.59	18	4	
24	Paul Günther	Germany	—	—	—	—	—	—	—	—	—	—	—	—	—	—	»
25	T. Eriksson	Sweden	—	—	—	—	—	—	—	—	—	—	—	—	—	—	»
26	George Yvon ...	Great Britain.....	59.4	3	69.1	1	66.3	1	72	2	61.7	2	328.5	65.7	9	2	
27	Toivo N. Aro ...	Finland	61.2	2	61.45	4	62.05	3	69.45	4	59.6	3	313.75	62.75	16	3	
28	J. P. Lyons	Canada	—	—	—	—	—	—	—	—	—	—	—	—	—	—	retired.
29	Nils Tvedt.....	Norway	—	—	—	—	—	—	—	—	—	—	—	—	—	—	did not start.
30	J. Stefenson	Sweden	51.8	5	56.25	5	51.9	5	59.6	5	48.15	5	207.7	41.54	25	5	
31	E. G. Schaal.....	U. S. A.	—	—	—	—	—	—	—	—	—	—	—	—	—	—	»
32	L. Valentich	Austria	—	—	—	—	—	—	—	—	—	—	—	—	—	—	»
<i>FINAL (15 July, 1912).</i>																	
1	Albert Zürner ...	Germany	71.4	1	67.6	4	74.4	1	78.7	2	70.9	2	363	72.6	10	II	
2	Hj. Johansson ...	Sweden	67.2	5	71	2	64.9	5	73.3	5	62.6	5	339	67.8	22	4	
15	Harald Arbin ...	"	61.8	6	64.85	5	59.7	6	66.35	7	60.4	7	313.1	62.62	31	6	
18	G. Blomgren.....	"	68.7	3	69.95	3	67.9	3	73.35	4	67.9	3	347.8	69.56	16	III	
20	Eric Adlerz	"	70.3	2	77.6	1	69.1	2	79.2	1	73.5	1	369.7	73.94	7	I	
22	A. Carlson.....	"	60.5	7	63.8	6	57.8	7	67.2	6	62	6	315.8	63.16	32	7	
26	George Yvon.....	Great Britain.....	67.8	4	60.3	7	66.8	4	76.3	3	67.1	4	338.3	67.66	22	5	
27	Toivo N. Aro ...	Finland	59.6	8	53.25	8	56.2	8	61	8	55.2	8	285.25	57.05	40	8	

General protocol of the competition in High (plain) Diving for Ladies.

Start N ^o .	Name	Nation	Names and decisions of the judges										Total points	Final points (total points divided by number of judges)	Total Place-fgs.	Placing	Rem.	
			1. J.G. Andersson		2. A. Ulrich		3. M. Kihlmark		4. Malmström		5. S. Johansson							
			Points	Place-figure	Points	Place-figure	Points	Place-figure	Points	Place-figure	Points	Place-figure						
<i>Heat I (10 July, 1912).</i>																		
1	Fanny Durack ...	Australasia.....	—	—	—	—	—	—	—	—	—	—	—	—	—	—	—	did not start.
2	Greta Johansson..	Sweden	38.5	1	33	1	33	1	36	1	40.5	1	181	36.2	5	1		
3	Fama Elda	Italy	—	—	—	—	—	—	—	—	—	—	—	—	—	—		
4	Lisa Regnell.....	Sweden	38.5	1	29	3	30	4	34	3	39	2	170.5	34.1	13	2		
5	Willy Thulin.....	»	29	7	20.5	7	23	7	24.5	7	28	7	125	25	35	7		
6	Märta Adlerz.....	»	25	8	18	8	23	7	21.5	8	22	8	109.5	21.9	39	8		
7	I. White.....	Great Britain.....	35.5	3	32.5	2	30	4	34.5	2	37	3	169.5	33.9	14	3		
8	Tora Larsson ...	Sweden	32	6	28	4	31	2	31.5	4	32.5	5	155	31	21	4		
9	Selma Andersson	»	34.5	5	25.5	5	31	2	31	5	31	6	153	30.6	23	5		
10	Elsa Andersson..	»	35.5	3	21.5	6	27	6	30.5	6	34	4	148.5	29.7	25	6		
<i>Heat II (10 July, 1912).</i>																		
11	Hermine Thum..	Austria	—	—	—	—	—	—	—	—	—	—	—	—	—	—	»	
12	Gerda Johansson	Sweden.....	28.5	3	26	3	31	3	27	4	31	3	143.5	28.7	16	3		
13	Dagmar Nilsson..	»	28.5	3	26	3	26	5	27.5	3	28.5	5	136.5	27.5	19	4		
14	Jessie Kerr	Australasia.....	—	—	—	—	—	—	—	—	—	—	—	—	—	—	»	
15	A. Garpestad....	Norway.....	—	—	—	—	—	—	—	—	—	—	—	—	—	—	»	
16	Hanny Kellner ...	Austria	—	—	—	—	—	—	—	—	—	—	—	—	—	—	retired.	
17	W. Wylie	Australasia	—	—	—	—	—	—	—	—	—	—	—	—	—	—	»	
18	Ella Eklund	Sweden	36	1	33.5	1	33	2	31.5	2	38	1	172	34.4	7	1		
19	Elsa Regnell	»	35	2	31.5	2	37	1	34	1	37	2	174.5	34.9	8	2		
20	Ester Edström ...	»	26.5	5	24	5	28	4	24	5	29	4	131.5	26.3	23	5		

734

Start N ^o .	Name	Nation	Names and decisions of the judges										Total points	Final points (total points divided by number of judges)	Total Place-fgs.	Placing	Rem.
			1. Kihlmark		2. Ulrich		3. Malmström		4. S. Johansson		5. J.G. Andersson						
			Points	Place-figure	Points	Place-figure	Points	Place-figure	Points	Place-figure	Points	Place-figure					
<i>FINAL (13 July, 1912).</i>																	
2	Greta Johansson..	Sweden	40.5	1	35	1	39	1	44	1	41	1	199.5	39.9	5	I	
4	Lisa Regnell.....	»	37.5	2	32.5	3	34	2	39.5	2	36.5	2	180	36	11	II	
7	I. White.....	Great Britain.....	35.5	3	33.5	2	31	4	34.5	5	35.5	3	170	34	17	III	
8	Tora Larsson ...	Sweden	29.5	7	23	8	25	8	31.5	8	25	8	134	26.8	39	8	
9	Selma Andersson	»	28	8	25.5	7	27.5	7	32.5	7	28	7	141.5	28.3	36	7	
10	Elsa Andersson..	»	30.5	6	28	4	31	4	34	6	33	5	156.5	31.3	25	6	
18	Ella Eklund... ..	»	32	5	28	4	31	4	36	3	32.5	6	159.5	31.9	22	5	
19	Elsa Regnell.....	»	35.5	3	27.5	6	33.5	3	35	4	34.5	4	166	33.2	20	4	

735

General protocol of the competition in Spring-board Diving.

Start N ^o :	Name	Nation	Names and decisions of the judges										Total Points	Final points (total points divided by number of judges)	Total Place-figs.	Placing	Rem.
			1. Johansson		2. Wennerström		3. Blidberg		4. Malmström		5. Lundberg						
			Points	Place-figure	Points	Place-figure	Points	Place-figure	Points	Place-figure	Points	Place-figure					
Heat I (8 July, 1912).																	
1	T. Nylund.....	Sweden	60.3	6	66.4	5	66.4	5	61.2	6	58.7	6	313	62.6	28	5	did not start.
2	W. Wetzell	Finland	60.65	5	64.2	7	60.25	7	53.95	7	54.45	7	293.50	58.7	33	7	
3	Paul Güther	Germany	73.5	2	79.9	2	82.85	1	78.95	2	75.5	2	390.70	78.14	9	2	
4	A. M. Nyman	Finland	—	—	—	—	—	—	—	—	—	—	—	—	—	—	
5	Kurt Behrens	Germany	74.95	1	80.35	1	80.85	2	83.3	1	81.25	1	400.70	80.14	6	1	
6	E. Brodd	Sweden	57.6	7	66.3	6	64.4	6	65.4	5	59.4	5	313.1	62.62	29	6	
7	A. Mc Aleenan jr.	U. S. A.	63.7	3	69.65	3	71.55	3	70.5	3	64.7	3	340.1	68.02	15	3	
8	Julius Stern	Germany	—	—	—	—	—	—	—	—	—	—	—	—	—	—	
9	E. Brandsten.....	Sweden	61.05	4	67.8	4	68.3	4	67	4	60.9	4	325.05	65.01	20	4	
Heat II (8 July, 1912).																	
10	Carlo Bonfanti ...	Italy	48	4	53.75	3	54.8	4	45	4	32.5	4	234.05	46.81	19	4	" "
11	John Jansson	Sweden	75.4	1	81.45	1	77.3	1	77.8	1	76.9	1	388.85	77.77	5	1	
12	G. A. Godfrey ...	South Africa	—	—	—	—	—	—	—	—	—	—	—	—	—	—	
13	Aug. Müller	Germany	—	—	—	—	—	—	—	—	—	—	—	—	—	—	
14	E. Eklund	Sweden	53.05	3	53.60	4	59.3	3	54	3	45.15	3	265.10	53.02	16	3	
15	H. E. Burton ...	U. S. A.	—	—	—	—	—	—	—	—	—	—	—	—	—	—	
16	Ludv. Valentich...	Austria	—	—	—	—	—	—	—	—	—	—	—	—	—	—	
17	Albert Zürner ...	Germany	70.4	2	77.65	2	75.7	2	72.75	2	76.7	2	373.20	74.64	10	2	
Heat III (8 July, 1912).																	
18	Herbert E. Pott...	Great Britain.....	67.4	4	75.1	4	72.6	4	77.5	3	77.1	2	369.7	73.94	17	4	" "
19	Fr. A. Bornamann	U. S. A.	—	—	—	—	—	—	—	—	—	—	—	—	—	—	
20	E. Apelqvist	Sweden	63.1	5	66.85	5	64	5	62.4	5	56.7	5	313.05	62.61	25	5	
21	G. W. Gaidzick...	U. S. A.	70.05	3	75.4	3	74.45	2	75.35	4	74.9	4	370.15	74.03	16	3	
22	Axel Runström ...	Sweden	59.9	6	62.7	6	62.60	6	53.20	6	53.7	6	292.1	58.42	30	6	
23	Hans Lubner	Germany	73.65	1	80.5	1	77.55	1	78.05	2	78.05	1	387.8	77.5	6	1	
24	R. M. Zimmermann	Canada	72.5	2	79.35	2	73.95	3	80.8	1	76.4	3	383	76.6	11	2	
25	E. Tjäder	Sweden	50.8	7	54.7	7	60.90	7	50.10	7	51.3	7	267.8	53.56	35	7	

736

47 Fifth Olympiad.

Start N ^o :	Name	Nation	Names and decisions of the judges										Total points	Final points (total points divided by number of judges)	Total Place-figs.	Placing	Rem.
			1. Blidberg		2. Malmström		3. Wennerström		4. Lundberg		5. Johansson						
			Points	Place-figure	Points	Place-figure	Points	Place-figure	Points	Place-figure	Points	Place-figure					
FINAL (9 July, 1912).																	
3	Paul Günther ...	Germany	77.95	2	79.95	1	82.9	1	82.35	1	73	1	396.15	79.23	6	I	" "
5	Kurt Behrens ...	"	77.9	3	74.05	5	74	5	76	5	66.7	4	368.65	73.73	22	III	
11	John Jansson	Sweden	71.45	7	66.95	8	72.55	6	67.75	8	69.5	3	348.20	69.64	32	7	
17	Albert Zürner ...	Germany	75.7	4	75.25	4	74.85	4	77.60	4	63.25	7	366.65	73.33	23	4	
18	H. E. Pott.....	Great Britain.....	71.15	8	71.2	6	75	3	73.95	6	65.95	5	357.25	71.45	28	6	
21	G. M. Gaidzick...	U. S. A.	71.6	6	68.7	7	68.2	8	70.15	7	61.4	8	340.05	68.01	36	8	
23	Hans Lubner	Germany	78.1	1	79	2	77.5	2	79	2	70.3	2	383.90	76.78	9	II	
24	R. Zimmermann ...	Canada	72	5	76	3	71.5	7	77.9	3	65.3	6	362.70	72.54	24	5	

737

Final.

Monday 15 July.

		Place-figures.	Points
1.	ERIC ADLERZ Sweden.....	7	73.94
2.	ALBERT ZÜRNER Germany	10	72.6
3.	GUSTAF BLOMGREN Sweden.....	16	69.56

Not placed :

		Place-figures.	Points.
	Hjalmar Johansson Sweden.....	22	67.8
	George Yvon Great Britain.....	22	67.66
	Harald Arbin..... Sweden... ..	31	62.62
	Alvin Carlsson »	32	63.16
	Toivo N. Aro Finland.....	40	57.05

The struggle in the final was between Adlerz, Zürner, Blomgren, Hjalmar Johansson and Yvon. Adlerz dived with extraordinary speed and power, and with great confidence. Zürner had a most successful day, diving in most beautiful style and with an excellent entry into the water, but speed and power were altogether absent. The judges were actually doubtful if his start could be accepted, as he only made a couple of steps before the take-off. In consequence of these faults he ought not, really, to have been dangerous for Adlerz, but the latter failed in his last dive — the flying somersault — from the greatest height, whereby he lost very considerably and was placed after the German by two of the judges. Blomgren dived evenly and in good style, and was considerably superior to Zürner as far as pace and power are concerned. Hjalmar Johansson had a very bad day, failing, among other things, in the running dive from the greatest height. Yvon (Great Britain) dived in a fine easy style, but spoiled his chances by an unsuccessful backward somersault. Aro had chosen altogether too easy dives, with low points for difficulty of execution, to be thought of in the placing.

PLAIN DIVING FOR LADIES.

First Round.

Wednesday, 10 July.

Heat 1: 1. GRETA JOHANSSON, Sweden, pl. 5, p. 36.2. LISA REGNELL, Sweden, pl. 13, p. 34.1. 3. Isabelle White, Great Britain, pl. 14, p. 33.9. 4. TORA LARSON, Sweden, pl. 21, p. 31. 5. SELMA ANDERSSON, Sweden, pl. 23, p. 30.6. 6. ELSA ANDERSSON, Sweden, pl. 25, p. 29.7. 7. Villy Thulin, Sweden, pl. 35, p. 25. 8. Märta Adlerz, pl. 39, p. 21.9. Greta Johansson dived in very superior style, and with the greatest confidence. This was the best of the heats, no less than 6 competitors qualifying for the final, all diving in good style and with plenty of pace. Miss White (Great Britain) has great speed, but is too "back-swanked" during her passage through the air, this giving an unfavourable impression.

Heat 2: ELLA EKLUND, Sweden, pl. 7, p. 34.4. 2. ELSA REGNELL, Sweden, Pl. 8, p. 34.9. 3. Gerda Johansson, pl. 16, p. 28.7. 4. Dagmar Nilsson, Sweden,

pl. 19, p. 27.3. 5. Ester Edström, Sweden, pl. 23, p. 26.3. Hanny Kellner, Austria, retired. There was a very hard struggle between Ella Eklund and Elsa Regnell, both diving in first class style and with plenty of speed.

Final.

Saturday, 13 July.

		Place-figures.	Points.
1.	GRETA JOHANSSON..... Sweden	5	39.9
2.	LISA REGNELL Sweden	11	36
3.	ISABELLE WHITE Great Britain	17	34
Not placed:			
	Elsa Regnell Sweden.....	20	33.2
	Ella Eklund, »	22	31.9
	Elsa Andersson,..... »	25	31.3
	Selma Andersson,..... »	36	28.3
	Tora Larsson,..... »	39	26.8

Greta Johansson had a very successful day, and dived in the very finest style. Lisa Regnell, too, was very good and was, almost unanimously, placed by the judges next to Greta Johansson. She came too much over, however, in a running dive from the greatest height, and so lost points. Miss White dived, as usual, with lots of power, but her entry into the water was very poor and she carried her arms incorrectly during the passage through the air. Neither Elsa Regnell nor Ella Eklund succeeded in getting placed, in consequence of some accidental mistakes. Selma Andersson dived at a good speed and, at one part of the proceedings, looked a possible prize-winner.

SPRING-BOARD DIVING.

First Round.

7 p. m., Monday, 8 July.

Heat 1: 1. KURT BEHRENS, Germany, place-figure 6, points 80,14, 2. PAUL GÜNTHER, Germany, pl. 9, p. 78,14, 3. A. MC ALEENAN, U. S. A., pl. 15, p. 68,02, 4. E. Brandsten, Sweden, pl. 20, p. 65,01, 5. S. Nylund, Sweden, pl. 28, p. 62,6, 6. E. Brodd, Sweden, pl- 29, p. 62,62, 7. Oscar W. Wetzell, Finland, pl. 33, p. 58,7. This was a pretty strong heat, but the two representatives of Germany dominated the whole entirely. Günther was best man in the compulsory part of the programme, but Behrens was exceedingly good in the voluntary dives, and four of the judges placed him first. Mc Aleenan (U. S. A.), was given third place by all the judges, although he was seriously threatened by Brandsten, who was decidedly the better man in the compulsory dives, but failed altogether in his last voluntary dive (One and a half somersault forwards, with the hands close to the sides).

Heat 2: 1. JOHN JANSSON, Sweden, pl. 5, p. 77,77, 2. ALBERT ZÜRNER, Germany, pl. 10, p. 76,64, 3. E. EKLUND, Sweden, pl. 16, p. 53,02, 4. Carlo Bonfanti, Italy, pl. 19, p. 46,81. Jansson (Sweden) had a very successful day, and the judges unanimously placed him before Zürner, the victor in the spring-board diving at the Olympic Games of London, in 1908, who did not do everything he could

with the last of his voluntary dives, although, in the compulsory half of the programme, he was placed as high as the Swedish representative.

Heat 3: 1. HANS LUBER, Germany, pl. 6, p. 77,5, 2. R. M. ZIMMERMAN, Canada, pl. 11, p. 76,6, 3. GEORGE V. GAIDZICK, U. S. A. pl. 16, p. 74,03, 4. Herbert E. Pott, Great Britain, pl. 17, p. 73,94, 5. E. Apelqvist, Sweden, pl. 25, p. 62,61, 6. Axel Runström, Sweden, pl. 30, p. 58,42, 7. Erik Tjäder, Sweden, pl. 35, p. 53,56. Herr Lubber dived very finely, and was placed, by the judges, almost unanimously, as first man in this heat. Zimmerman was very close to him, however, and one of the judges had even placed him first. It was thanks chiefly to the good result he obtained in the compulsory division that Lubber gained his place. Gaidzick (U. S. A.), the third man at the Olympic Games of London, in 1908, had a bad day. He was nearly equal to Lubber in the compulsory diving, and, after the first two voluntary dives, was in front of the German, even, but he failed in his last dive, n:r 18 (Pike dive with backward spring, turning inwards and 1 1/2 somersault). Pott (Great Britain), ran him very close, one of the judges placing him second. Axel Runström (Sweden) dived very well, too, until he reached the last number on his programme, but here he failed and lost all chance of getting into the final.

Final.

7,40 p. m., *Tuesday, 9 July*

		Place-figure	Points
1.	PAUL GÜNTHER Germany	6	79,23
2.	HANS LUBER... .. Germany	9	76,78
3.	KURT BEHRENS Germany ..	22	73,73

Not placed:

4.	Albert Zürner..... .. Germany	23	73,33
5.	R. M. Zimmerman	24	72,54
6.	Herbert E. Pott	28	71,45
7.	John Jansson,..... .. Sweden	32	69,64
8.	George W. Gaidzick U. S. A.	36	68,01

This was the first final that took place in the Swimming Stadium. Günther and Lubber, both German representatives, did excellently. Günther was best, but one of the judges placed Lubber 0.15 points before his rival, so that the latter did not reach the highest possible place-figure. There was a hard fight for third place between Behrens (the second man at the Games of London), Zürner and Zimmerman, who reached the place-figures of 22, 23 and 24, respectively. Zürner and Günther were the best men in the compulsory division, with Jansson close behind them. In his first voluntary dive, however (the screw dive, with a whole turn), Zürner was unsuccessful, and Jansson was weak in his flying somersault, these faults robbing the competitors in question of all hope of being among the first three. Behrens dived very confidently, but did not show the form he had displayed in the trial heat. Lubber, who gave an excellent display the whole way through, fell behind a little in his last voluntary dive, n:r 18 (Pike dive with backward spring, turning inwards and 1 1/2 somersault).

Zimmerman and Potts lay side by side for a long time, but both of them lost a great deal by their last effort (Pike dive with backward spring, turning inwards and $1\frac{1}{2}$ somersault). The first three places fell to representatives of Germany, and the first of the "not placed" men was also a German, Zürner. This gave the nation in question a very good start in regard to points for the final placing of the competing nations, and one that it managed to retain pretty safely throughout the whole of the Swimming Competitions.

Water Polo.

The competitions in Water Polo were arranged on the Cup Tie (elimination) system, but in such a way that the necessary number of matches had to be played for the second and third prizes between the teams qualified to take part in these rounds. The principle was adopted, that a team which had not been beaten, direct or indirect, by a team that was qualified to fight for the second or third prize, should have the right to play against the team last-mentioned, even if it (the first-named) had already been beaten by some other team. The teams entered were drawn in pairs for the first round, after which the order in which they were to meet in the second round was determined by drawing lots, so that the order in which the games were to be played, right up to the final, was fixed before the games began. The drawing of lots took place within two groups or pools, within which the elimination took place, so that a team from each group met in the final. In order to save time, and in order that the award of the second and third prizes should be made with perfect fairness, the rounds qualifying for these prizes were fought out after the ordinary ones, the principle being applied, however, that a team which defeated another was thereby considered to have beaten all the teams previously conquered by the second team.

As 6 teams had been entered for the competition, the order of play, as decided by the drawing of lots, was as follows:

<i>1:st Round:</i>	<i>2:nd Round:</i>	<i>Final:</i>
a) Great Britain	} Winner (Great Britain)	} Winner (Great Britain)
Belgium		
b) Sweden	} Winner (Sweden)	} Winner (Great Britain)
France		
c) Austria	} Winner	(Austria)
Hungary		

In the first round, therefore, there were three matches; in the second, only one, the winner of match c) playing in the final. As Great Britain and Austria were the victors in matches a) and c) respectively, Belgium and Hungary met in match d), and, Belgium winning this match, the latter country and France met in match f), France having been beaten in match b) by Sweden. As, again, Sweden had been beaten by Great Britain in the semi-final, and Austria had been beaten by

Great Britain in the final, Sweden and Austria met in match h) for the second prize. Sweden won this match, so that Belgium and Austria played match i) for the third prize, the team that won this match qualifying for third prize. As Belgium won this match, another game, match k), had to be played between Sweden and Belgium for second prize. Altogether, ten matches were played, the greatest number possible according to the system employed, when 6 teams competed. Belgium, which had been beaten in the very first round by Great Britain, could, as is shown above, in spite of this fact, meet Austria, which was not beaten by Great Britain before the final for first prize was played, and Belgium, by beating its rival, robbed it of its chance of getting even a third prize.

The result of the matches was as follows:

a)	Great Britain v. Belgium.....	7—5.	
b)	Sweden v. France	7—2.	
c)	Austria v. Hungary... ..	5—4.	
d)	Belgium v. Hungary	6---5.	
e)	Great Britain v. Sweden	6—3.	<i>Semi-final.</i>
f)	Belgium v. France	4—1.	
g)	Great Britain v. Austria	8—0.	<i>Final.</i>
h)	Sweden v. Austria	8—1.	
i)	Belgium v. Austria	5—4.	
k)	Sweden v. Belgium	4—2.	<i>Second and Third prizes.</i>

First Round.

Match a). GREAT BRITAIN-BELGIUM. 7—5.

3.15 p. m., Sunday, 7 July

This match, which was originally intended to be played on Saturday evening, but which, on account of the increasing darkness, had to be put off until Sunday afternoon, was a very lively one. Great Britain attacked first, but Belgium defended brilliantly, and it was Belgium that made the first goal, obtained after 5 minutes' play. Another assault from Great Britain resulted in a hard shot from the left forward, but the ball went the wrong side of the net, and Belgium took an early opportunity of increasing its lead to two goals. Immediately afterwards, Belgium's left forward was ordered out of the water on account of being within the two-metre line, and this opportunity was at once seized by Great Britain, who made its first point. Directly after this, each side made another goal, and when the whistle blew for half-time, Belgium led by three goals to two.

Belgium played a very strenuous game, and immediately after the game was renewed, it made a fresh addition to its score, and thus stood 4 goals to 2, and it was only in consequence of the wonderful speedy and energetic play of Radmilovic, Great Britain's centre forward, that the latter country was able to draw level, 4—4, just before time was called. Radmilovic swam forward time after time with the ball, and shot from every possible position.

In accordance with the rules, the game was continued in periods of 6 minutes, 3 in each half, the result of the extra-time play being that Great Britain made 3

additional goals and Belgium 1, so that the final result of the match was that Great Britain won by 7—5 (2—3, 2—1, 3—1).

Referee: G. Wennerström, Sweden.

The players were:

Great Britain: Charles Sydney Smith (goal), George Thomson Cornet and Charles Bugbee (backs), Arthur Edwin Hill (centre half-back), George Wilkinson, Paul Radmilovic and Isaac Bentham (forwards).

Belgium: Albert Durant (goal), Herman Donners and Victor Boin (backs), Joseph Pletinez (centre half-back), Oscar Grégoire, Herman Meyboom and Félicien Courbet (forwards).

Match b). SWEDEN—FRANCE. 7—2.

1.30 p. m., Monday, 8 July.

The Swedes who, in the first half, played with the sun in their faces, were completely masters of the situation, being vastly superior, both as regards handling of the ball and speed. After 4 minutes, Robert Andersson, their centre forward, made the first goal for Sweden, Bergqvist, the right forward, making the second immediately afterwards. Innumerable shots at goal were made by the Swedes, the ball going above, or by the side, of the goal. One of the French team being ordered out in consequence of "off-side", Bergqvist made a third goal, the total being added to directly afterwards by Robert Andersson. Then Julin, the Swedish right back, swam forward with the ball, but the instant before he placed it in the net, the whistle for half time was heard, and the result for the first period of the game remained at 4—0, in favour of Sweden.

After changing sides, the French left back swam forward and made the first goal for his side, but, directly afterwards, Bergqvist and Robert Andersson each made another point for Sweden. France repeated its manoeuvre, and with the same success, but on this occasion it was the right back who made the goal. The match ended in favour of Sweden by 7 goals to 2 (4—0, 3—2).

Referee: J. Hurd, Great Britain.

The players were:

Sweden: Thorsten Kumfeldt (goal), Harald Julin and Max Gumpel (backs), Pontus Andersson (centre half-back), Wilhelm Andersson, Robert Andersson and Eric Bergqvist (forwards).

France: Jean Thoraille, Henri Decotu, Gustave Prouvost, Paul Vasseur, Paul Louis Beulque, Georges Rigal, Gaston Vanlaere.

Match c). AUSTRIA—HUNGARY. 5—4.

1.35 p. m., Tuesday, 9 July.

At the beginning of the match Hungary played most energetically, and after an interval, during which the ball went from one side to the other, the team succeeded in making its first goal, Austria equalizing soon afterwards, however, by means of a penalty throw. The game was continued, both teams playing roughly, and the referee's whistle was heard very frequently. Towards the close of the first half, Austria neglected a fine chance, when its left back swam forward with the ball. He was robbed of it and, as the Hungarian forward was unmarked, it was Hungary that made the goal instead, so that when the whistle sounded for half time the latter team led by 2—1.

During the second half the game grew still rougher, and lost in character more and more. Austria made the first goal; then Hungary made one, and both teams followed with another goal, so that the game stood 4—3 in favour of Hungary. The players seemed to lose all self control, and one of the Hungarians was ordered out of the water by the referee, but, instead of making use of this opportunity and by means of quiet play making sure of a goal, the Austrians became still more heated and broke the rules so openly that one of their team, too, was ordered out. At last four of the players, two from each team, were watching the game from the side of the bath, and as the Austrian team was awarded a penalty throw, it was able to draw level at 4—4. In the last moments of the match, Scheff made the fifth and deciding goal for Austria, which consequently won by 5—4 (1—2, 4—2).

Referee: G. Wennerström, Sweden.

The players were:

Austria: Rudolf Ruckfelder, Richard Manuel, Walter Schachtitz, Otto Sheff-Sochaczewski, Josef Wagner, Ernst Kovács, Herman Buchfelder.

Hungary: Arthur von Kankovszky, Josef Onody, Emmerich Zachár, Eugen Hegner, Tibor Fridmann, Alexandor Adám, Ladislaus Beleznay.

Match d). Qualifying match. BELGIUM—HUNGARY. 6—5.

2.30 p. m., Wednesday, 10 July.

Belgium, which played the better game, made its first goal from a free throw immediately after the game began, but one of the team had to leave the water soon afterwards for taking up his position within the two metre line. The Hungarian forwards, however, did not know how to employ their advantage and quite a long time elapsed before their centre, hotly attacked, made a fine goal that brought his side level. Matters were changed when the game was restarted, an Hungarian being ordered out and Belgium making a goal immediately afterwards, but just before half time Hungary again succeeded in obtaining the lead, after their goalkeeper had brilliantly cleared a succession of attacks on the part of Belgium. The result at half time was, consequently, 3—2 in favour of Hungary.

The second half, from beginning to end, was entirely Belgium's. It soon succeeded in drawing level, the left forward taking the ball from the Hungarian goalkeeper, who had swum out to save. Belgium pressed more and more, and soon took the lead with a fifth goal, its sixth being made with all the Belgium players, with the exception of their goalkeeper, in front of the Hungarian net. Immediately before time was called, however, Hungary managed to add another goal to its total, but the final result was 6—5 in favour of Belgium (2—3, 4—2).

Referee: G. Wennerström, Sweden.

Semi-final.

Match e). GREAT BRITAIN—SWEDEN. 6—3.

8 p. m., Thursday, 11 July.

Sweden at once took the lead and before a single Englishman had had the ball in his hands Robert Andersson succeeded in making the first goal. After this the game became very rough and the referee lost the direction of affairs. After Julin, the Swedish back had been twice ordered out of the water for some unaccountable reason, the game at half time stood at 2—1 in favour of Great Britain.

The beginning of the second half was marked by Bergqvist being ordered out of the water for taking up a position within the two-metre line, and Great Bri-



PLAIN AND VARIETY DIVING. HJALMAR JOHANSSON (Sweden).



PLAIN AND VARIETY DIVING. GEORGE YVON (Great Britain),



PLAIN DIVING, MEN. German style.



PLAIN DIVING, LADIES. GRETA JOHANSSON (Sweden), 1:st prize.



PLAIN DIVING, LADIES. LISA REGNELL (Sweden), 2:nd prize.



PLAIN DIVING, LADIES. ISABELLE WHITE (Great Britain), 3:rd prize.

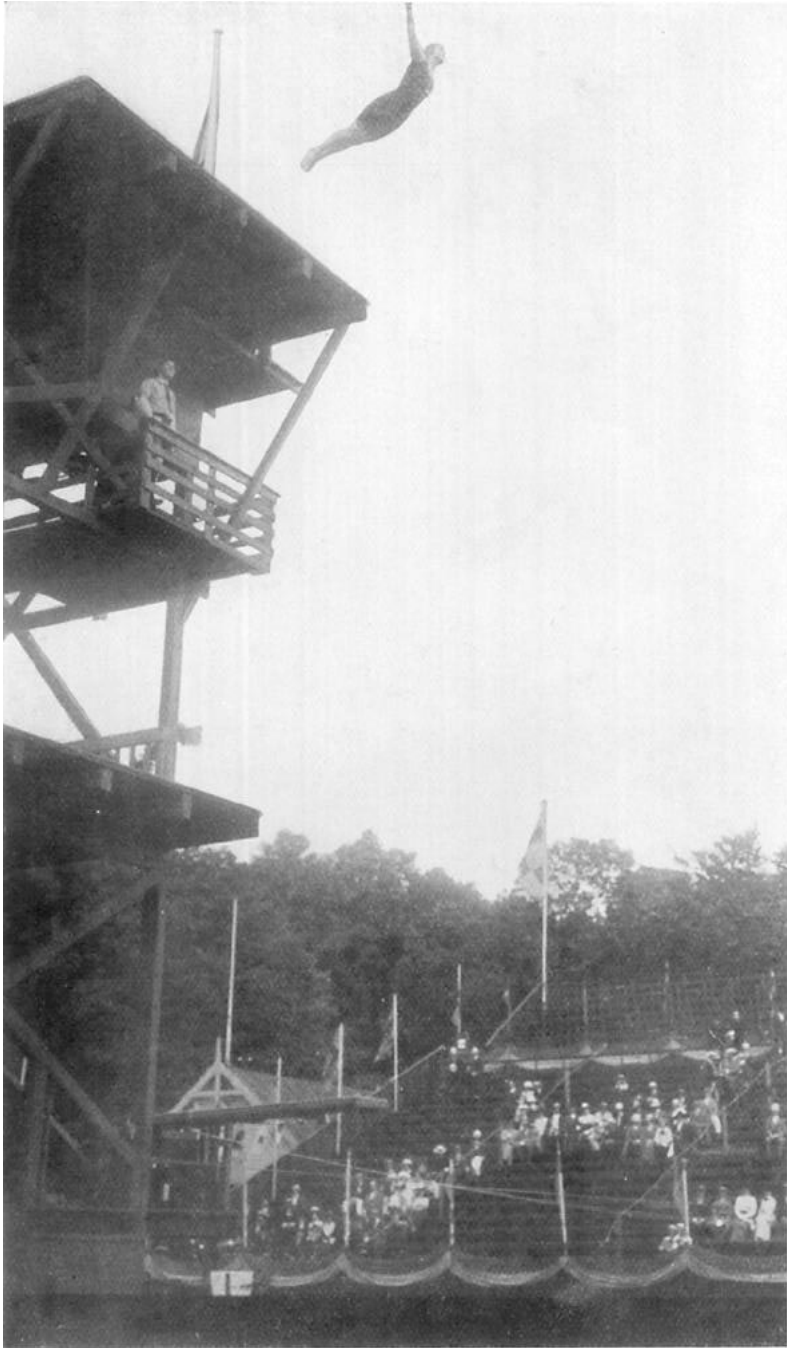

PLAIN DIVING, LADIES. TORA LARSSON (Sweden).

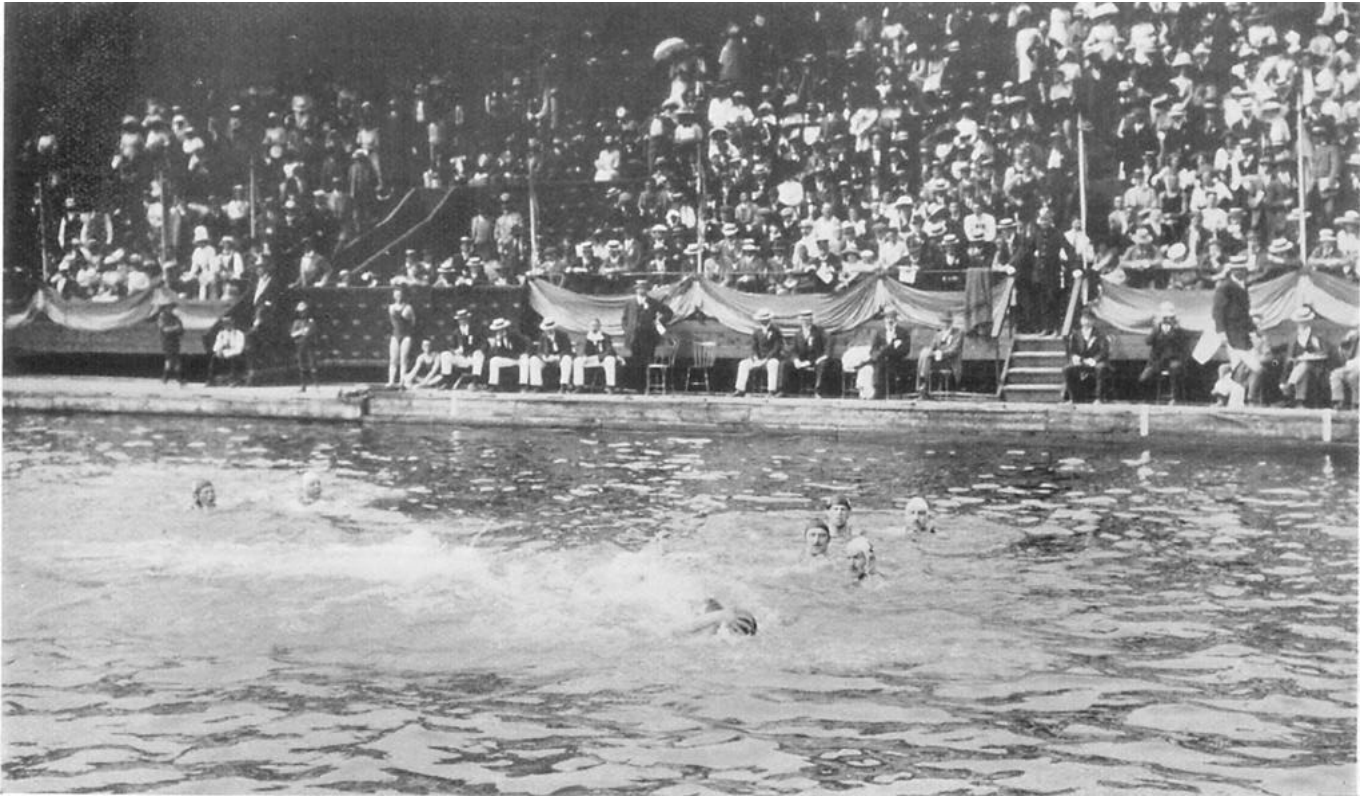

WATER POLO. FRANCE v. SWEDEN.

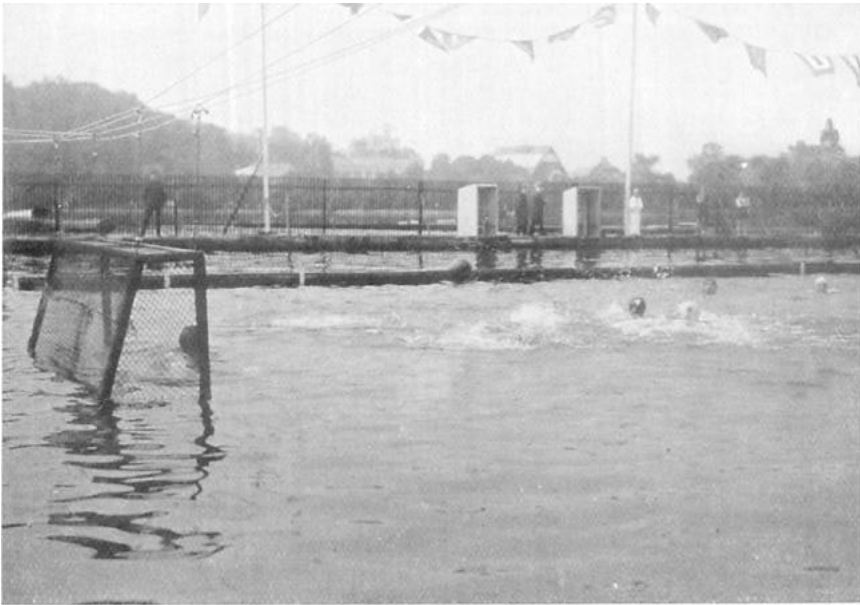

WATER POLO. BELGIUM v. HUNGARY. In front of Hungary's goal.



WATER POLO. BELGIUM v. HUNGARY. In front of Belgium's goal.

tain had no difficulty in increasing its goal-total by another point, although a fluke had almost given Robert Andersson a chance of making a goal for Sweden. The last-named country gained a point soon after, however, made by W. Audersson from a pass by Robert Andersson, the latter player adding a goal on his own account after a fine swim forwards. Great Britain put on three more points, however, and won by 6—3 (2—1, 4—2) the goals having been made for them as follows: Wilkinson, 3; Radmilovic, 1; Bentham, 1 and Hill, 1.

Referee: Van der Heyden, Belgium.

Both teams played the same men as in the first round.

Match f). Qualifying Round. BELGIUM—FRANCE. 4—1.

11.30 a. m., Thursday, 11 July.

This match, which was to have been played on Friday, July 12 was, at the request of the French representatives, played on Thursday, 11 July. In consequence of the result of the match between Sweden and France, an easy Belgian victory was expected, but the French team played uncommonly well, especially during the first half, and made the first goal, but the Belgians soon equalized. The French goalkeeper was in his very best form and cleared quite a number of difficult shots, so that it was not until just before half time that Belgium managed to secure the lead by making another goal. Result at half time, Belgium 2—1.

During the second half the Belgians succeeded in making two additional goals, and the match finished in favour of Belgium by 4—1 (2—1, 2—0).

Referee: G. Wennerström, Sweden.

Final.

GREAT BRITAIN—AUSTRIA. 8—0.

7.50 p. m. Saturday, 13 July,

The final had not excited the interest that it should, considering that an Olympic Gold Medal was to be played for, but everyone felt pretty sure, of course, that Great Britain must win, for the Austrian team had altogether too many weak points to be able to offer any serious resistance. Great Britain at once took possession of the ball, but the attack was repulsed by the Austrian goalkeeper and the ball carried to the opposite side of the course. This, like other, later, attacks on the part of Austria were never dangerous, as their forwards seemed to be quite unable to shoot, well watched as they were by the British defence. Great Britain made a close succession of attacks, Radmilovic and Wilkinson playing exceedingly well together, the result being that the team made 4 goals in the first half, which finished with the goal-total 4—0 against Austria.

The second half was a duplicate of the first. Great Britain made some brilliant attacks and gave quite a nice exhibition of tricky play against the comparatively weak backs opposed to them. The team made 4 goals in this half too, the final result being that Great Britain won by 8—0 (4—0, 4—0).

Referee: E. Bergvall, Sweden.

Match h). Qualifying Match for second prize. SWEDEN—AUSTRIA. 8—1

8 p. m., Sunday, 14 July.

As in the semi-final, the Swedes took the initiative at the start, and the ball was passed from the centre forward to the right, who was attacked so vehemently by the defending back that a free throw was awarded. This resulted in the left forward obtaining the first goal for Sweden. In the next bout the Austrians were never allowed to touch the ball and it soon lay in their net again, matters beginning to look very dark for them. The Austrian goalkeeper succeeded, however, in repulsing the third attack, and the ball was thrown out to Scheff who swam forward grandly and placed it in the Swedish net. Immediately afterwards, the Swedish left forward again succeeded in making a goal, and as the opposing back was ordered out of the water a moment later on account of rough play, Sweden made its fourth goal from a penalty throw. Wilhelm Andersson, the Swedish left forward, worked with extraordinary energy, and after a beautiful piece of combined play between him, Robert Andersson (centre forward) and Bergqvist (right forward), the last-named made the fifth goal. The next minute the Swedish centre made another fine swim towards the Austrian goal, but came too near the goal-line, so that the defending goalkeeper was able to cover the whole of the goal-opening, and the shot was unsuccessful. A corner throw resulted, however, but the attack was repulsed by the Austrians. Julin, the Swedish back, finished off half-time by a fine swim forwards, which was interrupted by the timekeeper's whistle. Result at half time, Sweden 5—1.

During the second half, the Swedes relaxed their efforts and played somewhat nonchalantly. Their first attack resulted in a corner which came to nothing, but after a piece of good individual play the left forward made the sixth goal for Sweden. Immediately afterwards, the Swedish goalkeeper cleared a hard back-throw from the left, and a piece of combined play enabled Sweden to obtain its seventh goal, made by Bergqvist. A free throw from Bergqvist was returned by Wilhelm Andersson, and the ball found the Austrian net for the eighth time. A dangerous attack by Austria, immediately afterwards, was cleared brilliantly by the Swedish goalkeeper. Bergqvist was ordered out of the water soon afterwards, but before the Austrians could take any advantage of the event, the whistle blew for full time. Result 8—1 (5—1, 3—0) in favour of Sweden.

Referee: George W. Hearn, Great Britain.

Match i). Qualifying Match for third prize. BELGUIM—AUSTRIA. 5—4.

1 p. m., Monday, 15 July.

The general opinion was that Belgium was going to win pretty easily but, partly as the result of bad luck, and partly in consequence of their careless play, the Belgians almost lost the match.

Directly after the start, the Belgian centre forward carelessly threw away a safe goal, but soon afterwards the ball found the Austrian net twice. The Belgians played roughly and made many fouls, and one of the team was at last ordered out of the water for being within the 2-metre line. Scheff employed the opportunity to make a goal for Austria, and the remainder of the half saw no change in the total, which remained at 2—1 in favour of Belgium.

Immediately after the game was re-started, another Belgian player placed himself within the two metre line and as, in consequence, Belgium had to play with 6

men only, the figures were soon brought to 2—2. An almost certain goal was converted by the cleverness of the Austrian goalkeeper into a corner throw, from which, however, Meyboom made an easy goal for the Belgians. For the third time a Belgian had to watch the proceedings from the side of the bath in consequence of offending against the two-metre line rule but, on this occasion, the Belgian team, in spite of playing one man short, succeeded in making a goal and thus had a safe lead of 4—2. But instead of quietly keeping this lead the Belgians let their play degenerate more and more, and when, for the fourth time, the referee was obliged to order a Belgian player out of the water for taking up a position within the 2-metre line and Austria succeeded in making a goal, the Belgian players lost all self-possession and the game ended in a semi-riot. Two Belgian players were ordered out of the water, one of them being forbidden to take any further part in the game, but in spite of this, Belgium succeeded in retaining its advantage and the match concluded in favour of the last named country by 5—4 (2—1, 3—3).

Referee: E. Bergvall, Sweden.

The number of goals does not give a correct idea of the relative skill of the two teams. The Belgians, who were decidedly the cleverer men, had only their players' want of self-possession to thank that their victory was not a more decisive one, but the Austrian team, too, was also guilty of exceedingly rough play and the referee had the greatest difficulty in restraining the excesses threatened by both sides.

Match k). Deciding Match for the Second and Third prizes.

SWEDEN-BELGIUM. 4—2.

9 a. m., Tuesday, 9 July.

Belgium attacked first but was repulsed, and the Swedes followed up with a succession of attempts against their opponents' goal. These were unsuccessful, however, the ball striking the cross-bar twice and the others being cleared very cleverly by the Belgian goalkeeper who showed excellent form throughout the whole of the match. At last, however, Robert Andersson, the Swedish centre forward, succeeded in making the first goal for his side, but this was almost immediately neutralized by the Belgians, one of their forwards being left unmarked. Just before half time Wilhelm Andersson put a ball hard against the cross-bar, and the first half finished with the game at "one all".

When the game began again, the Swedish players seemed somewhat excited and nervous, but they soon gained the lead by means of a goal obtained by Wilhelm Andersson, after a corner-throw by Bergqvist. After Kumfeldt had brilliantly cleared a hard shot from the left-hand corner of goal, the Swedish forwards were once more able to make a goal, from a pass by Julin. The game was now entirely in the hands of the Swedes, and their well-combined play made their attacks more dangerous than ever. Julin left the opposing forward, and, on being met by the Belgian right back, passed to W. Andersson, who carried the ball onwards until he was threatened by the opposing left back. Bergqvist, being free, received the ball from W. Andersson, and, by means of a lightning shot, increased the Swedish lead to 4—1. Immediately before time was called, however, the Belgians, by means of a fine attack, succeeded in obtaining another goal, but the game finished in favour of Sweden by 4—2 (1—1, 3—1).

Referee: J. Hurd, Great Britain.

Table showing the Results of the Olympic Water Polo Competition.

Great Britain 7	}	Great Britain 6	}	Great Britain 8	}	<i>Great Britain</i> 1:st Prize.		
Belgium 5								
Sweden 7	}	Sweden 3	}					
France 2								
Austria 5	}	Austria 0	}					
Hungary 4								
Belgium 6	}	Belgium 4	}	Sweden 4			}	<i>Sweden</i> 2:nd Prize. <i>Belgium</i> 3:rd Prize.
Hungary 5		France 1						
		Austria 4	Belgium 2					

Table showing the number of matches played and goals made in the Water Polo Competitions of the Fifth Olympiad.

Nation	Nr. of matches played.	Nr. of matches won.	Nr. of matches lost.	Nr. of Goals.		Difference between nr. of goals won and lost.	Prize	Points
				Made	Lost.			
Great Britain.....	3	3	—	21	8	+ 13	I	3
Sweden	4	3	1	22	11	+ 11	II	2
Belgium	5	3	2	22	21	+ 1	III	1
Austria	4	1	3	10	25	— 15	—	—
Hungary	2	—	2	9	11	— 2	—	—
France	2	—	2	3	11	— 8	—	—
Total	10	10	10	87	87	25—25	—	—

Concluding Words.

The Swimming Competitions of the Fifth Olympiad were the greatest hitherto held anywhere in the world. Never before have so many fine swimmers from so many nations been gathered together to compete against each other, and the result showed an enormous increase in interest, and results obtained, in the art of swimming. There was not a race but gave a new Olympic record, and in swimming, free style, the world's records for all distances were broken. More need not be said to characterize the competitions, while, to the swimming expert, the two phenomenal racing champions, Kahanamoku and Hodgson, presented most interesting studies. By means of its excellent representatives in breast stroke and back stroke, Germany succeeded in obtaining first place in the races, but in the free styles the Anglo-Saxon races were pre-eminent, and thanks, to the results of the Ladies' races, Australasia and Great Britain come first here, with the U. S. A. and Canada as their nearest rivals.

In the diving competitions the struggle took place chiefly between Sweden and Germany, with Great Britain and the U. S. A. next to

them. In the high diving, Sweden was first, just as she was at the Games of London, but Germany easily took pride of place in the spring-board diving.

The Water Polo Tournament, too, showed that this branch of sport has made considerable progress in several countries. In London, in 1908, Great Britain was undisputably the champion, while Belgium and Sweden had no one to challenge their rights to second and third positions. The relative positions of the two countries last mentioned was now reversed, and it was only after a severe struggle that Great Britain was able to retain its position at the head of the list, Belgium, in the first match, succeeding in making a draw until extra time was played. Belgium's struggle for third prize was also characterized by some hard matches, both Austria and Hungary sending good teams to Stockholm.

* * *

If a summary is made of the lessons learned by these competitions, it must, first and foremost, be pointed out, that the fact of the existence of an International Swimming Federation, whose principles for the arrangement of the races were strictly followed, considerably facilitated the management of the competitions.

Some inconvenience was experienced when making the preparations, in consequence of there being no standard programme for the Swimming Competitions of the Olympic Games, and such a programme should most certainly be drawn up. Another thing to be desired is, that the privilege of making entries for the competitions should be so far restricted, that no nation may have the right to enter so many as 12 competitors for the individual events. It can hardly be imagined that there are so many absolutely first-class swimmers in any nation, that it is not possible to make a selection of, say, 6 or 8 representatives for each event, before making entries for the Olympic Games. Only in the Diving Competitions can there be any real reason for retaining the present number of entries for each event, as, in such competitions, accidental circumstances play such an important role. As far as the races are concerned, however, the proposed restriction ought certainly to be made, and this so much the more as it would thereby be possible to retain the principle adopted at the Fifth Olympiad when dividing the competitors into heats — that of allowing the second man in each heat and the best third to take part in the next round — for it can never be fair, when it is a question of both the second and third prizes, to allow only the winners of the several heats to take part in the following round. That is; there is nothing to exclude the possibility of the absolutely best three men in a competition being drawn together in the very first heat, or in one of the intermediate rounds. Of this, a very good example was given by the results of the Water Polo Tournament, as compared with what would have been obtained had the elimination system, pure and simple, been applied, and as long as the competitions in water polo, football, tennis, etc., are for more than one prize, the elimination system employed at the Water

Polo Competitions of the Fifth Olympiad ought, unconditionally, to be adopted in future trials of skill in the events mentioned.

In this connection a word may be said respecting a circumstance that could hardly have escaped the observation of a great many people, with regard to the system adopted for awarding points in the Games as a whole, and for instituting a comparison between the nations taking part in the Fifth Olympiad. Throughout the whole of the Games, the same points were awarded for the team competitions as for the individual events, so that a nation whose representatives won a team event did not obtain more points than one whose representative won an individual competition. The very fact that a nation cannot enter more than one team for a team competition, and thus cannot gain more than one prize, while — granting sufficient skill — nothing can prevent a nation from carrying off all three prizes in an individual event, is certainly a great injustice, being so much to the disadvantage of the teams. But, apart from this point of view, a team competition ought, per se, to count for more than an individual competition, as it represents more directly a struggle for supremacy between the nations, and there is, thus, every reason to ask whether an alteration in this respect should not be made for future Olympiads.

According to the official method of calculating points, the relative position of the Nations in the Swimming- and Diving competitions was :

Nation	1:st Prize	2:nd Prize	3:rd Prize	Points
Germany	3	5	3	22
Sweden	3	4	2	19
Great Britain	2	2	4	14
Australasia	2	2	2	12
U. S. A.	2	1	1	9
Canada.....	2	—	—	6
Belgium	—	—	1	1
Austria	—	—	1	1

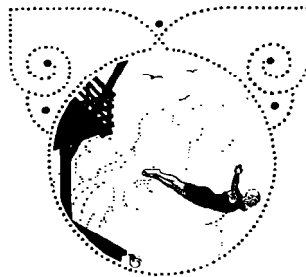

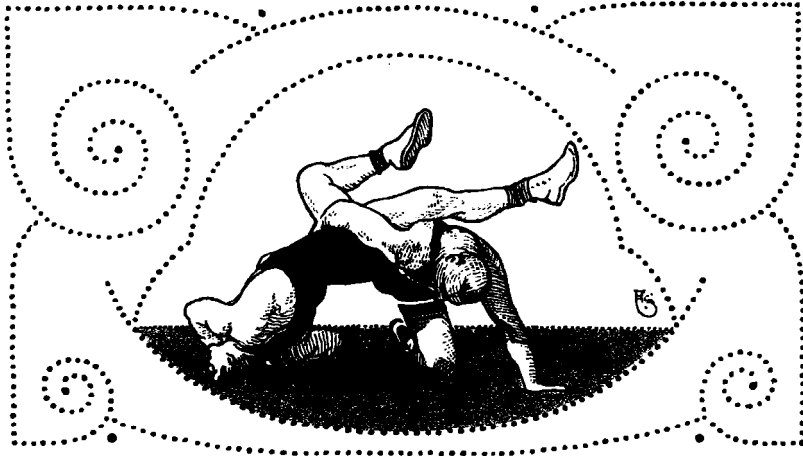

WRESTLING.

ORGANISATION.

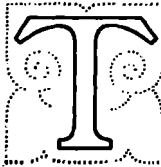

he Committee that had in hand the preparatory work for drawing up the rules of the Wrestling Competitions that were to form part of the Olympic Games, consisted of the following members, after the vacancies caused by the retirement of one or two of the persons chosen had been filled, and some additional representatives elected:

President:..... CARL HELGESSON, Esq., Gothenburg
Other Members: CARL ANDERSSON, Esq., Malmö.
 A. V. BJÖRKGREN, Esq., »
 JAMES BORG, Esq., »
 HJ. JOHANSSON, Esq., Stockholm.
 JOHN OLSSON, Esq., Malmö.
 CARL SANDBERG, Esq., Gothenburg.
 STELLAN WARELIUS, Esq., Stockholm.

The meetings of the Committee have been held at various places, chiefly at Gothenburg and Malmö.

RULES AND REGULATIONS.

One thing that gave the Committee a great deal of work was the drawing of the rules for the competition, for in no other branch of athletics are there so many varying regulations in force as in wrestling. Each country has its own peculiar rules, and the greatest differences can often be found. It was, therefore, necessary for the Committee to choose from amongst the material at its disposal those regulations which, it was thought, might be of use in drawing up the proposed rules for the competition, and, after a careful examination of

various schemes, one was at length agreed on which proved to satisfy all the requirements that could be demanded. These rules were printed, ready for distribution, several months before the Games began.

THE QUESTION OF OFFICIALS.

The choice of officials was another thing to which the Committee paid the greatest attention. In almost every other branch of athletics, the judge, or referee, has merely to state an actual result, although, on one or two occasions, as for example in the case of a dead heat in a race, this may be a matter of some little difficulty. With regard to wrestling, however, things are quite different. The situation here varies incessantly, and an attention, a watchfulness, is demanded, which puts the judge to a most severe test. By means of exercising the greatest care in its choice, however, the Committee succeeded in obtaining the services, as officials, of persons who, for many years had devoted much time to wrestling as a branch of athletics.

THE NUMBER OF ENTRIES.

After the close of entries on the 6 June, when it became known that no fewer than 267 representatives had been entered by the various nations, some serious doubts began to be entertained whether the competitions could be concluded within the time allotted to them, and steps were at once taken to meet this eventuality. For example, an agreement was made with the owners of the Riding School in the neighbourhood of the Stadium, by which this establishment could, if necessary, be used for the purposes of the competitions. As, however, only 171 of the 267 competitors were present on the day when the wrestling began, not much use was made of this arrangement.

The entries in the different classes and the numbers that actually competed were as follows:

Feather Weight	65	and	38
Light Weight	66	»	48
Middle Weight, A	57	»	38
Middle Weight, B.....	50	»	29
Heavy Weight.....	29	»	18

THE COMPETITIONS.

The competitions, which went on simultaneously on 3 wrestling-mats were, as far as possible, so arranged that, on each day, two classes were free from wrestling, in order to give the competitors an opportunity of resting for at least one day between the events.

This arrangement proved to be an excellent one, for, with such a large number of competitors, and with the principle in force that two defeats excluded, it was necessary for a wrestler to appear in quite a number of rounds in order to reach the final.

It would, of course, take too much space to give an account of all the wrestling that took place, the total number of bouts reaching the respectable number of 303; we shall, therefore restrict ourselves to mentioning only some few names.

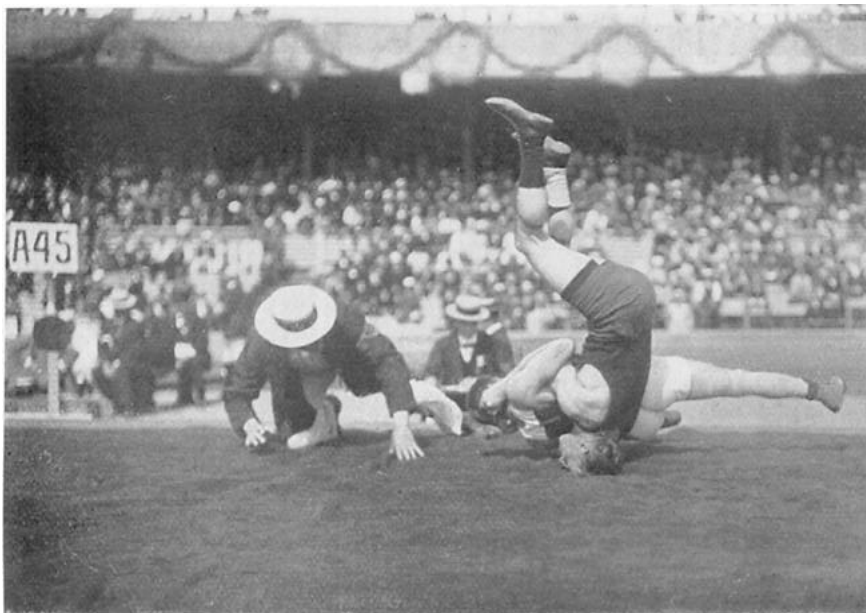

WRESTLING. FEATHER WEIGHT. STEIN (Germany) v. LARSSON (Sweden).
A double-nelson by Larsson parried by Stein.

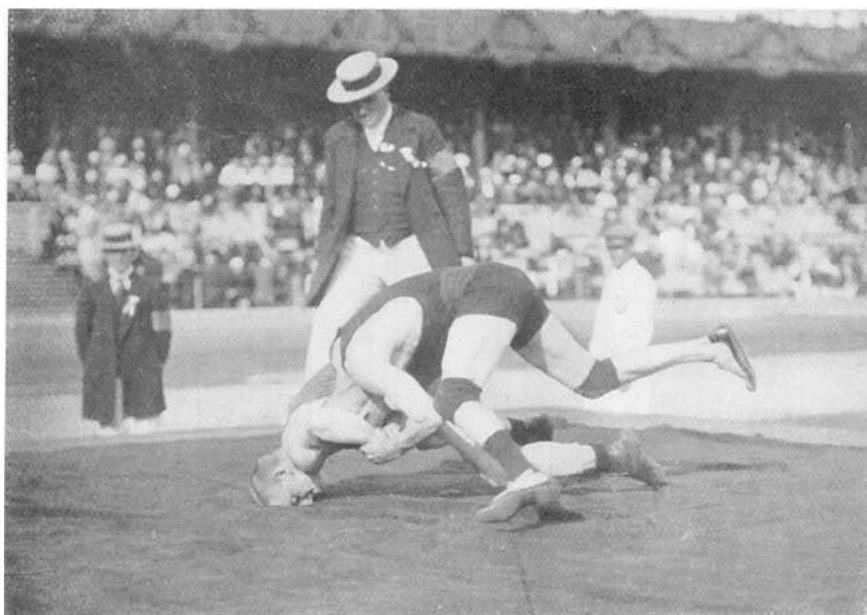

WRESTLING. FEATHER WEIGHT. HANSEN (Denmark) v. ANDERSSON (Sweden).
A chancery-hold by Hansen parried by Andersson.

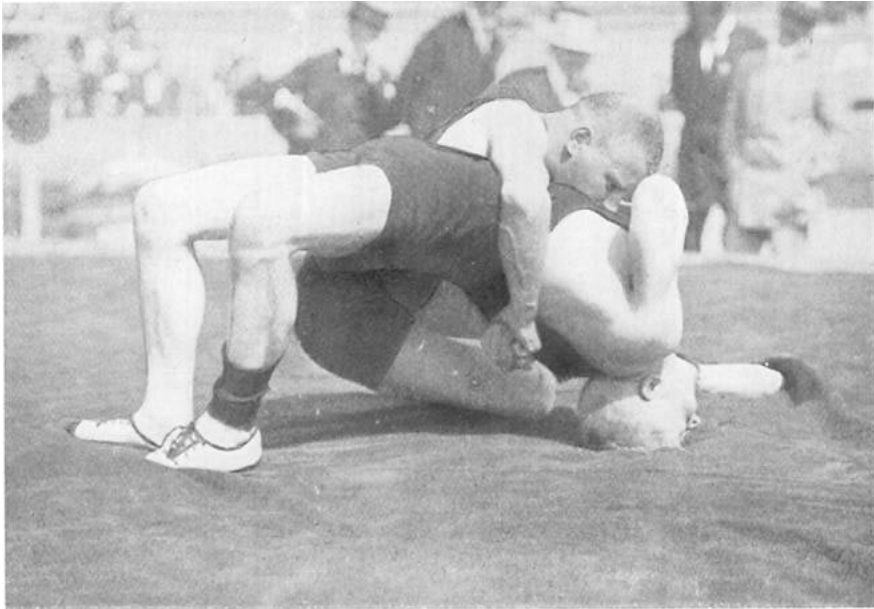

WRESTLING. FEATHER WEIGHT. GULLAKSEN (Norway) v. PERSSON (Sweden).
Persson has been compelled to bridge, in consequence of Gullaksen's powerful attack.

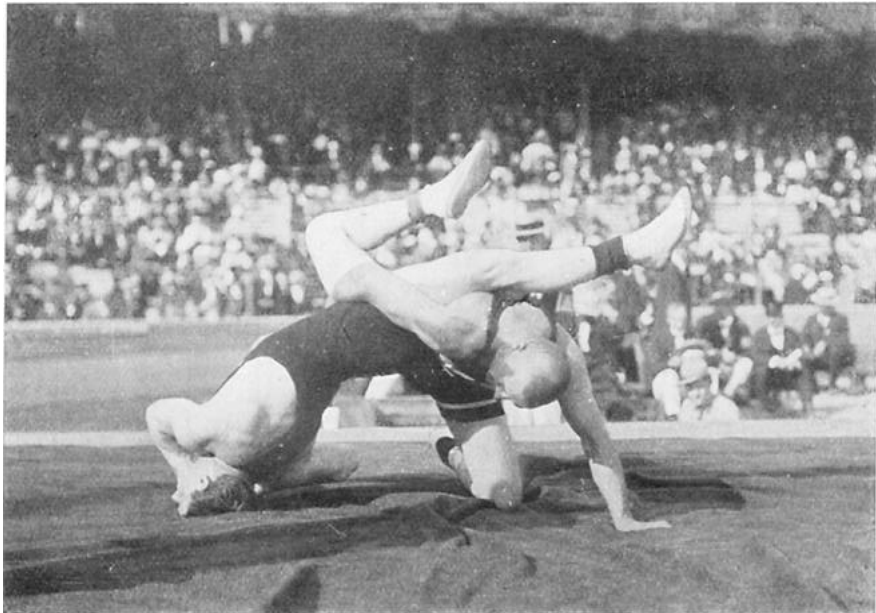

WRESTLING. MIDDLE WEIGHT B. FOGELMARK (Sweden) V. SALILA (Finland).

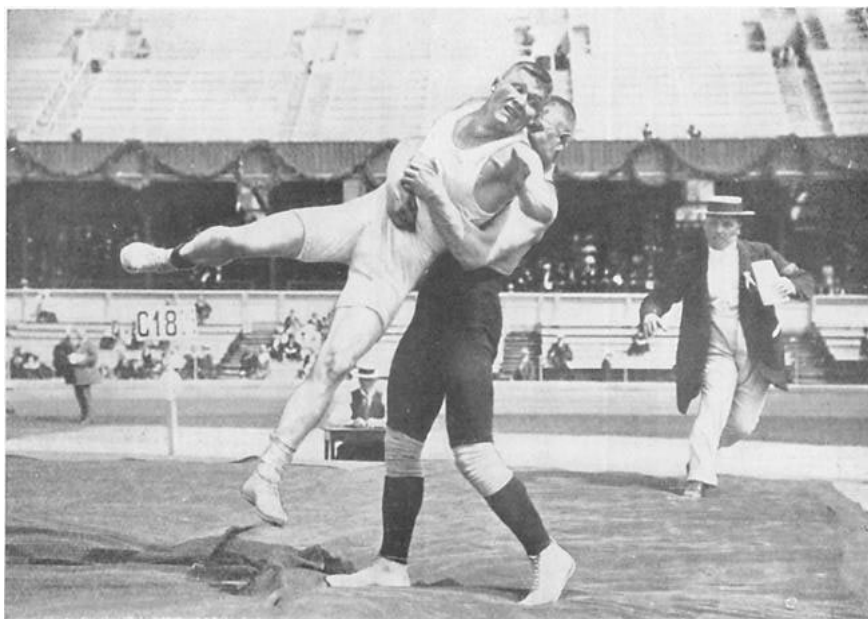

WRESTLING. MIDDLE WEIGHT. A. KLEIN (Russia) v. ASIKAINEN (Finland).
A typical illustration of the unconquerable energy of these two opponents.

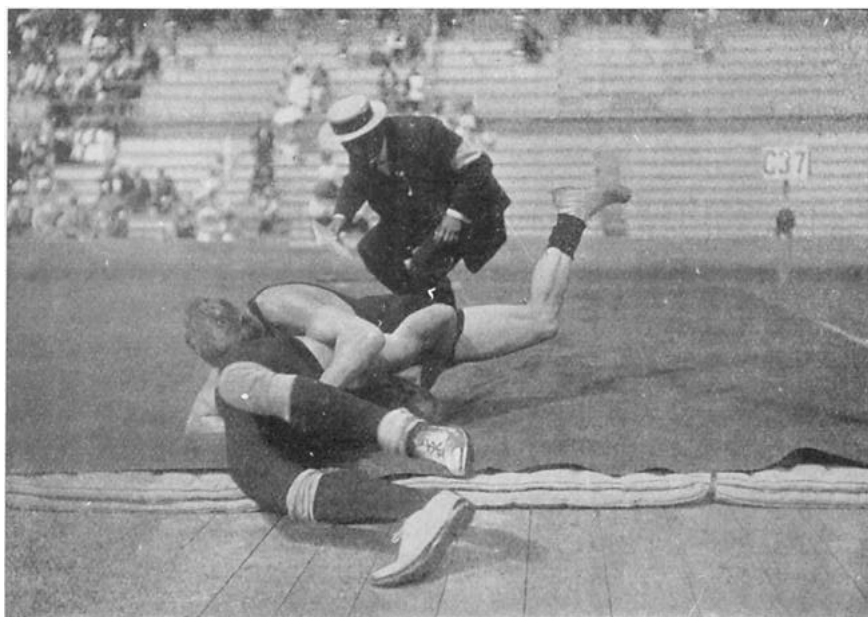

WRESTLING. MIDDLE WEIGHT A.
CLAS JOHANSSON (Sweden), at work.

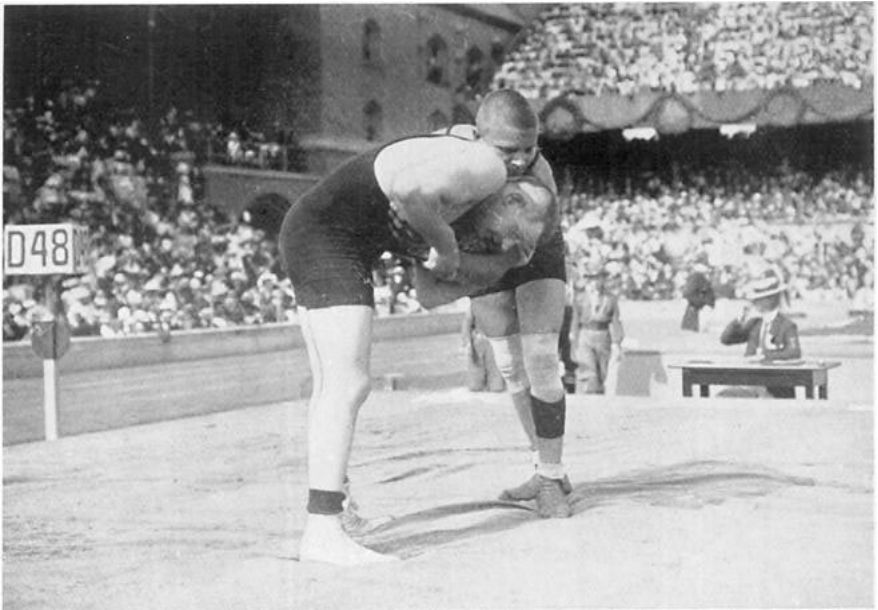

WRESTLING. MIDDLE WEIGHT B. AHLGREN (Sweden) v. BÉLA VARGA (Hungary).

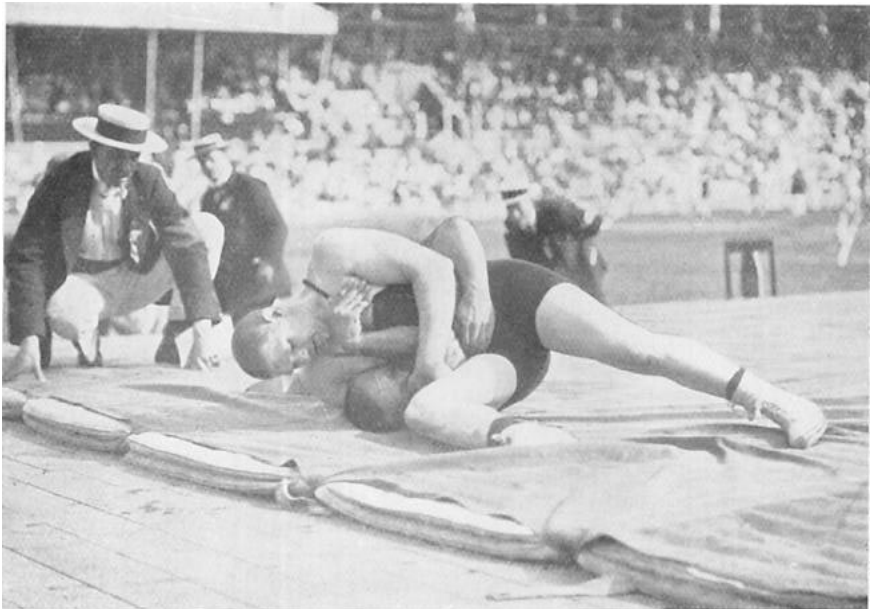

WRESTLING. MIDDLE WEIGHT B. AHLGREN (Sweden) v. BÉLA VARGA (Hungary).
A threatening position for Varga, from which he twice succeeded in saving himself,
the third time proving fatal.

FEATHER WEIGHT.

1. K. KOSKELO Finland
2. G. GERSTACKER Germany
3. O. LASANEN Finland.

To begin with the feather weights, it can be said at once that the representatives of Finland had the superiority in this class, for nearly all the Finlanders taking part here showed such skill in wrestling that it far exceeded what has ever been witnessed in Sweden, as far as agility is concerned. The two prize-winners especially, O. Lasanen and K. Koskelo, of whom Lasanen is intentionally mentioned first in spite of the fact that, in the final, he was beaten by Koskelo, stood far above the other competitors. K. Leivonen, J. Lehmuswirta and L. Haapanen are also deserving of mention. The German competitor, G. Gerstacker, was an athlete to his very finger-tips, and the suppleness of his movements, combined with unconquerable energy, gained him the second place amongst the prize-winners. Amongst the Swedish competitors the most prominent was E. Öberg, who had to be contented, however, with the not very enviable distinction of being the last man eliminated in this class. Both Harry Larsson, a Swedish-American, and Hugo Johansson, Swedish wrestling-champion, who had long been accustomed to win his matches, had to acknowledge defeat at the hands of a couple of the men already mentioned.

LIGHT WEIGHT.

1. E. WÄRE..... Finland
2. G. MALMSTRÖM Sweden
3. E. MATIASON Sweden

The light weight class is, undoubtedly, the one for which the public has the greatest interest and that with reason, for it is in that division one finds the best developed wrestlers, both as regards build and technical skill, while in no other class is the struggle for the title of champion so sternly contested. This was the case in the meeting at the Fifth Olympiad, too. Every name of distinction in the wrestling world was to be found among the entries, and the exhibitions given were of a superlative class, and, under such circumstances, it could not but awaken the greatest satisfaction in Sweden that it was just in this class their men were best represented. But here, too, it was a Finlander who came out on top; that prominent wrestler, E. Wäre, taking first prize. This athlete, who must, unconditionally, be regarded as a phenomenon in the wrestling world, defeated all his opponents out and out by pressing their shoulders against the mat; not on a single occasion was he declared winner on points. One of his severest struggles was his bout with the Swede, G. Malmström, and the meeting of these two men in the final, when Malmström was defeated after exactly one hour's combat, was, undoubtedly, the finest ever witnessed in this country. The winner of the third prize was E. Matiason, Sweden, while E. Lund and J. Nilsson were other Swedes that

Feather Weight.

Name	Nation	Comp. n.r.	28	27	33	16	36	19	35	44	60	18	41	24	37	39	32	20	30	22	42	45	63	5	47	38	46	61	26	31	2	21	25	34	1	40	29	6	54	48		
Jalmari Wilhelm Lebmuswirta	Finland	28	/	2.5 +	7 +		5 +		60 -																	57 -														60 +		
Kalle Leivonen	"	27	/	12 +	3.5 +				60 +	1.5 +																60 -																
Percy Horatius Cockings	Great Britain	33	2.5 -	12 -	/																																					
Mariano Ciaï	Italy	16	7 -	3.5 -	/																																					
Bruno Vincent Åkesson ¹	Sweden	36				/	60 -	60 +																																		
Mikael Hestdal	Norway	19	5 -			60 +	/		60 -																																	
Alfred William Taylor	Great Britain	35				60 -	/		9 -																																	
Erik Öberg	Sweden	44	60 +	60 -			60 +	9 +	/						0 +																											
Josef Beranek	Bohemia	60		1.5 -					/	10 -	0 +	60 +																														
Kristian Arnesen	Norway	18							10 +	/		12 -	2 -																													
Karl Karlsson	Sweden	41							0 -	/		34 -																														
Paul Pawlowitch	Russia	24							0 -	60 -	12 +	34 +	/																													
Arvid Magnus Beckman	Sweden	37								2 +			/																													
Ewald Persson	"	39																																								
Otto Aapraham Lasanen	Finland	32		3 +					50 +						30 +																											
Ragnvald Gullaksen	Norway	20													6 -																											
Arvo Kangas	Finland	30													0 +																											
Alexandre Ankondinoff	Russia	22																																								
Harry Larsson	Sweden	42		49 -																																						
Conrad Stein	Germany	45																																								
József Pongrácz	Hungary	63																																								
William Jones Lyshon	U. S. A.	5																																								
Jonny Anderson	Germany	47																																								
Hugo Sigfrid Johansson	Sweden	38																																								
Georg Gerstacker	Germany	46	57 +	60 +																																						
Andreas Szoszki	Hungary	61																																								
Risto Mustonen	Finland	26																																								
Lauri Haapanen	"	31							90 -																																	
Verner Edmund Hetmar	Denmark	2																																								
Antonio Pereira	Portugal	21																																								
Alexandre Meesit	Russia	25																																								
George Mackenzie ¹	Great Britain	34																																								
Carl Christian Hansen	Denmark	1																																								
Carl Georg Anderson	Sweden	40																																								
Kalle Koselo	Finland	29																																								
George St. Retzer	U. S. A.	6																																								
H. Rauss	Austria	54	60 -																																							
Friedr. Scharer	"	48																																								

¹ Retired. + = won, - = lost. The figures above these marks show the time the match lasted.

Middle Weight A.

Name	Nation	Comp. nr.	9	38	7	46	19	28	13	24	27	29	34	23	11	16	31	3	36	32	20	37	26	45	21	30	4	39	2	35	54	33	58	18	1	25	42	40	41	22		
Anast. Antonopoulos.....	Greece	A 9	\	5	1																																					
Daniel Fältström	Sweden.....	38	5	\	2	17				10																															3	
Andrea Gargano	Italy.....	7	1	2	\	10																																			0	
Peter Kokotowitsch	Austria.....	46	17	10	\	23				21																																
Jean Pohlis	Russia.....	19			23	\	22			6																																
Stanley Vivian Bacon	Great Britain..	28				22	\			0																																
Alfred Gundersen ¹	Norway	13								3	\																															
August Jokinen.....	Finland.....	24	10	21	6			3	\						2																											
Alfred Asikainen	»	27				0					21	\																														
Edgar Hugh Bacon	Great Britain..	29								21	\				0																											
Victor Mellin ¹	Sweden.....	34												46	\																											
Fridolf Lundsten	Finland.....	23								0	46	\																														
Zavirre Carcereri	Italy.....	11							2	\																																
Joaquim Victal.....	Portugal	16								3					4	\																										
Mauritz Andersson	Sweden.....	31								0			60	11	\																											
Adrien Barrier	France	3																																								
Axel Frank	Sweden.....	36																																								
Theodor Dahlberg.....	»	32																																								
Alexandre Seweroff	Russia.....	20																																								
Cl. Johansson	Sweden.....	37							50	60				30	\																											
Emil Westerlund	Finland.....	26																																								
Alois Totuscek	Austria.....	45																																								
Theodor Tirkkonen	Finland.....	21																																								
Noel Raymond Rhys	Great Britain..	30																																								
Jan Sint	Holland	4								4	\			0																												
Sven Olsson	Sweden.....	39																																								
Hvitfeldt Hansen	Denmark	2																																								
Fritz Johansson	Sweden.....	35																																								
Arpád Miskey	Hungary	54																																								
Theodor Bergqvist.....	Sweden.....	33																																								
Rezső Somogzi.....	Hungary	58																																								
Max Klein	Russia.....	18							90	\																																
Anders Peter Andersen.....	Denmark	1																																								
Mikko Holm.....	Finland.....	25																																								
Adolf Kurz	Germany	42																																								
Joseph Merkle	»	40	3	\																																						
Wilhelm Steputat.....	»	41		0	\																																					
Karl Konrad Åberg	Finland.....	22																																								

¹ Retired. + = won, — = lost. The figures above these marks show the time the match lasted.

Middle Weight B.

Name	Nation	Comp. n.r	5	23	24	36	4	34	20	27	22	8	1	29	3	26	48	32	21	35	41	12	25	18	43	19	28	31	47	33	2	
Edouard Martin	France	5	45																												0	
Ivar Theodor Böling	Finland	23	45+			4+		43+				0+								60+											60+	
August Rajala	»	24			60+	60+						1+	2		29.5+	60																
Karl Gross	Germany	36		4	60																											
Otto Nagel	Denmark	4			60				35																							
Peter Oehler	Germany	34		43				35+		0+																						
Oscar Wiljami Kumpu	Finland	20							0			10																				
Gustaf Lennart Lind	»	27										3	35																			
Johan Kustaa Salila	»	22										1	40+	10																		
Oreste Arpe	Italy	8		0	1				10+	3+																						
Sigurjon Pjetursson	Iceland	1			2+					35+	1+					90	4.5															
Ragnar Fogelmark	Sweden	29													5.5																	
Johannes Thorvald Eriksen	Denmark	3			29.5			7+			10+																					
Oscar Wiklund ¹	Finland	26										90+		11+		42					0											
Béla Varga	Hungary	48			60+							4.5+			42		37+	55+									7+					
Karl Sanfrid Ekman	Sweden	32														37		0														
Knut Lindberg	Finland	21														55		0		13+								60+		35		
Fritz Lange	Germany	35		60													0+			13		29+					4+					
Johann Trestler	Austria	41																			29		2									
Renato Gardini	Italy	12																			2+		4.5+					17		4.5		
Karl Gustaf Lind	Finland	25																					4.5		29+						3	
Ansgar Løvold	Norway	18																						29		0						
Karl Barl	Austria	43																						0+		19					10	
August Pikker ²	Russia	19																							19+		8.5					
Johan Andersson	Sweden	28														7				4						8.5+			6.5+			
Ernst Nilsson	»	31																	60			17+									12.5	
Frant Kopriva	Bohemia	47																								6.5	53					
Anders Oscar Ahlgren	Sweden	33		0+																35+		4.5+	3+									20+
Harald Christensen	Denmark	2			60																				10+			12.5+		20		

¹ Injured ; retired. ² Unanimously disqualified. Judges: Olsson (Sweden); Schindler (Bohemia); Nielsen (Denmark). + = won, — = lost. The figures above these marks show the time the match lasted.

Heavy Weight.

Name	Nation	Comp. nr																	
			11	7	9	15	19	3	17	1	8	4	18	5	13	2	6	10	14
Urvö Erik Mikael Saarela.....	Finland	11	\		6 --	32 +	0 +		6 +				6 +			3 +			
Kalle A. Wiljamaa	»	7		\	1/2 +		78 +	0 +				60 -	60 -						
Johan Fredrik Olin	»	9	6 +	1/2 -	\			30 +	44 +				32 +						
David Karlsson.....	Sweden	15	32 -			\												60 -	
Jean Hauptmanns.....	Germany	19	0 -	78 -			\												
Raoul Lucien Paoli	France	3		0 -	30 -			\											
Frans Gustaf Lindstrand	Sweden.....	17	6 -		44 -			\	14 +										
Laurent Gerstmans	Belgium	1						14 -	\	20 -									
Emil Isidor Backenius	Finland.....	8							20 +	\	90 -			0 +	90 -		0 +		
Barend Bonneveld	Holland	4		60 -						90 +	\	25 -							
Jacob Nesar	Germany	18	6 -	60 +	32 -						25 +	\	60 +				2 +		
Nicolai Famest.....	Russia	5										60 -	\	0 -					
Edward Barrett	Great Britain ..	13								0 -			0 +	\	46 -				
Sören Marius Jensen	Denmark	2	3 -							90 +			46 +	\	60 +	60 +			
Adolf Valentin Lindfors	Finland.....	6										2 -		60 -	\				8 +
Gustaf Uno Pelander	»	10				60 +				0 -				60 -	\				60 +
Frederick Humphreys ¹	Great Britain ..	14																	\
Alrik Sandberg.....	Sweden.....	16														8 -	60 -		\

¹ Retired. + = won, — = lost. The figures above these marks show the time the match lasted.

distinguished themselves in this event. Amongst the competitors from abroad, Wäre, who has already been mentioned, and Ö Radvány, from Hungary, were the most prominent. This latter wrestler was the victim of an unceasing run of bad luck, which was the only thing that prevented him from fighting his way through to the final. In addition to these, there were many other quite good men in this class, such as T. Kolehmainen and V. Wikström, Finland; O. Kaplur, Russia; H. Lofthus, Norway; F. O. Hansen, Denmark, and Jan Balej, Bohemia.

MIDDLE WEIGHT A.

1. CL. JOHANSSON Sweden
2. MAX KLEIN..... Russia
3. A. ASIKAINEN ... Finland

The Middle Weight A class was the only one in which Sweden managed to secure a gold medal, but this was all the more remarkable as, before the Games began, it was considered that the Swedes would be worst represented just in this section. The first man here was that honest, open-hearted wrestler, Cl. Johansson, and the fact that no one stood up to him in the final, the other men retiring from the bout, must not be taken as detracting in any way from the merit of his victory, as, during the course of the competition, he had proved himself quite the equal of any of his opponents. The second and third men were Max Klein, Russia and A. Asikainen, Finland. The struggle between these two showed what the prospect of winning an Olympic gold medal can do, and a wrestling contest lasting no less than 11 hours, and carried on under a burning sun, with a short pause for refreshments every half hour, must be considered as a proof of unconquerable energy, so that one cannot censure either of the opponents. The struggle taught us, however, that some alteration must be made in the rules, in order to provide against a repetition of such lengthy contests which are altogether too wearying for the public. The Finnish representatives, K. Åberg, A. Jokinen and E. Westerlund; the Swedish wrestler, D. Fältström, and Jan Sint, Holland, all showed that it was not without reason they had been chosen to represent their various nations in this contest for Olympic honours.

MIDDLE WEIGHT B.

2. { A. AHLGREN..... Sweden
- { J. BÖLING Finland
3. BÉLA VARGA Hungary

Regrettably enough, the competition for Middle Weights B had the result that no gold medal was awarded, for the two men left in for the final, J. Böling, Finland and A. Ahlgren, Sweden, proved to be such masters of technique, and possessed such abnormal bodily strength that, after the contest had been carried on for no less than nine hours, and after the fruitless application of the special regulations made for such cases, the match had to be declared a draw. As, however the rules of the Olympic Competition stated that it was necessary for

the victor to have beaten his opponent, and as neither man would give in to his adversary, there was nothing else to be done than to declare both men winners of a second prize, a result which, after such fine work, could not but be regretted. The third man was the well-known Hungarian wrestler, Béla Varga, who had been beaten in the semi-final by Ahigren. Among the other competitors in this class may be mentioned: A. Rajaala and K. Lindberg, Finland; F. Lange, Germany, and S. Pjetursson, Iceland.

HEAVY WEIGHT.

1. U. SAARELA Finland
2. J. OLIN..... Finland
3. S. M. JENSEN Denmark

The Heavy Weights had fewest representatives, but, in spite of this fact, the competition was a most interesting one, there being such men on the list as S. M. Jensen and U. Saarela, victors at previous Olympic Games. No Swede managed to come to the fore in this event, G. Lindstrand, the Swedish champion, who, otherwise, must be considered a good man, being beaten at a comparatively early stage of the proceedings. The winner of the gold medal was Saarela, Finland, who beat his most redoubtable opponent, S. M. Jensen, Denmark, in the final. The result might easily have been quite different, had not the Dane found the heat too much for him, as, during the struggle with the Finnish representative, he showed himself to be the better man of the two. Half-broiled by the sun, however, Jensen had to retire from the contest after the lapse of a couple of hours, and, for the same reason, he took no further part in the competition, so that the second prize went to J. Olin, Finland. J. Nesper, Germany, proved a stumbling block to many aspirants, but he was defeated in the last round by Saarela.

REFLECTIONS.

It can be seen by the above lists that Finland was pre-eminent in the Wrestling Competitions of the Olympic Games. There is one Finlander, at least, as a prize-winner in each class, and half the total number of prizes fell to the share of that nation, a result that must be termed a most brilliant one, and one that will probably never be surpassed by any country in future Olympic meetings. Sweden was a good second, with four prizes; a very fine performance taking into consideration the large number of first-class men among the competitors. Hungary did not succeed in gaining more than a third prize, but it showed itself to be the nation that best appreciates wrestling as a branch of athletics. Its representatives competed with a perfect absence of the brutality that is, unfortunately, sometimes displayed in such contests, and they accepted the decisions of the judges with an equanimity displaying the spirit of the true sportsman. There were many, apart from their own partisans, that would willingly have seen Hungary placed higher on the list of prize-winners.

It can easily be understood that many misunderstandings were sure to arise during the lengthy progress of the Olympic Competitions in

such a branch of athletics as wrestling, where the decision, in many cases, rests on the personal opinion of the judge presiding over a contest. Very often, the defeated candidate feels that he has a grievance, and if there is the least possibility in the world of being able to enter a protest, the opportunity is seldom neglected.

In order to make the judging at the wrestling competitions of the Olympic Games as fair as possible, the rules prescribed that points should be awarded only in the event of the three judges being unanimous. Further, a bout could not be declared as having been decided by the defeat of one of the parties, unless two, at least, of the judges decided that a fall had been gained by the victor. In addition to this, and in order to avoid the possibility of any partiality being shown, it was determined that the judges, in each contest, should always belong to other nations than those represented by the wrestlers.

One would think, then, that the rules intended to safeguard the competitors from unfair decisions on the part of the judges were quite ample for the purpose, but, in spite of this, the leaders of some of the wrestlings teams were at once ready with a protest, as soon as any of the representatives of their nations were defeated. This being the case, it is clear that the greatest firmness had to be displayed from the very beginning by the leaders of the competitions. All interference with the work of the officials met with a firm although polite rebuff, at the same time that any information asked for was very willingly given. One or two very strong protests were entered, but these were met by satisfactory explanations. It is to be regretted that a number of the judges from abroad retired towards the close of the competitions, their absence making the rules as to the nationality of the judges in the various contests of lesser effectivity, but as this took place towards the close of the events, the step did not cause the leaders of the competition any difficulties worth mentioning.

There can be no doubt but the Wrestling Competitions of the Fifth Olympiad taught several lessons well worthy of remembrance on future, similar occasions. The most important question — that of the rules — will, however, most probably be taken in hand by the proposed International Amateur Wrestling Federation, and solved in agreement with what has been learned at the Olympic Games of Stockholm.

The finals are not included in the tables.

Relative positions of the Nations in the Wrestling Competitions.

N a t i o n	1:st prize	2:nd prize	3:rd prize	Points
Finland	3	2	2	15
Sweden	1	2	1	8
Germany	—	1	—	2
Russia	—	1	—	2
Hungary	—	—	1	1
Denmark	—	—	1	1

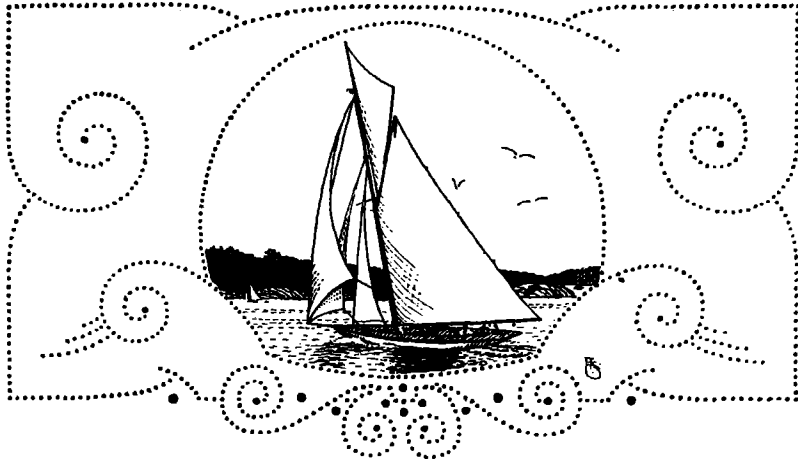

YACHT RACING.

THE ORIGIN OF THE REGATTA.



At its meeting in Berlin, 27 May, 1909, the International Olympic Committee expressed the desire that Yacht Racing should also be included among the other items of the programme for 1912, although not as an independent event, but in connection with the rest of the Games, as the case was at the Fourth Olympiad, in 1908. At the same time, however, the desirability was emphasized of arranging the Yacht Racing in more direct connection with the other Olympic competitions, both as regards time and place, than had been the case in England.

In Swedish yachting circles, too, the opinion was general that sailing matches ought to form part of the Olympic Games, but the same unanimity by no means prevailed respecting the place where the competition should be held, and the manner in which it should be arranged.

Yachtsmen from the west coast of Sweden considered that Gothenburg would be the most suitable place, both as regards position — it being considerably nearer for competitors from abroad — and from the greater interest shown there, as they thought, in the matter of the international rule. On the Baltic coast of Sweden, again, yachtsmen were equally convinced of the advantages offered by the vicinity of Stockholm, as, of course, the other competitions in the Games were to be held there and, consequently, a considerably greater number of spectators could be expected at the races. The Swedish Olympic Committee, too, thought that Stockholm was the most suitable place and so, in a letter dated 24 February, 1910, it approached the Royal Swedish Yacht Club, asking that body whether it would be willing to organize international yacht races, in connection with the Olympic Games, to take place immediately after the Olympic Week proper.



VESSELS WITH SPECTATORS, NYNÄSHAMN HARBOUR.



JOURNALISTS ON STEAM-YACHT "SAGA".

Another body that might otherwise have been thought of in connection with the arrangement of the Olympic sailing competitions, the Swedish Yachtsmen's Association, considered that its organization and aims did not allow of its drawing up a plan for the races in question. The Yachtsmen's Association, a union of members of Swedish yachting clubs, has for its object the introduction of uniform regulations in yacht racing, while it acts as referee and advisory body in cases submitted to its judgment.

The experience gained at the Olympic racing at Ryde in 1908, however, convinced the Swedish Committee that a regatta devoted merely to Olympic competitions and, thus, with a small and limited number of yachts, would not awaken sufficient interest in the general public, so that it was found necessary to arrange open races in addition to the Olympic yachting events. The Royal Swedish Yacht Club determined, therefore, at a meeting held 2 April, 1910, to have its annual racing week in 1912 near the date of the Olympic Yacht Racing, and also to organize "special Olympic Races", during the Olympic Regatta week, in accordance with rules and regulations that the Club was to draw up in co-operation with the Swedish Yachtsmen's Association.

PREPARATIONS.

At its meeting on the 14 April, 1910, the Committee of the Royal Swedish Yacht Club nominated a Yacht Racing Committee, consisting of the President of the Club, Capt. O. Holtermann, Gentleman of the Bedchamber; its Secretary, K. Bovin, Esq., Bank Director, and the following members of the Club Committee; Messrs. K. J. Ljungberg, B. A. Hjorth, and S. Hydén, this Racing Committee being instructed to draw up a scheme for the organization of the Olympic Yacht Racing in 1912. Hugo Andersson, Esq., Assistant Secretary of the Royal Yacht Club, was afterwards elected a member of the committee in question.

As the races did not directly form part of the Olympic Games, but were arranged in connection with them, the Royal Yacht Club did not ask the Swedish Olympic Committee for any pecuniary aid, the Committee in question having merely to provide the Yacht Club with the requisite number of prize medals to be awarded at the Olympic Yacht Races in 1912.

Regarding the place where the races in question were to be held, the Yacht Club Committee determined, after discussing the matter very thoroughly at a meeting held on the 27 October, 1910, that Nynäshamn would be the most suitable for the purpose. Under ordinary conditions, Sandhamn offers sufficient anchorage for yachts, and accommodation for the crews and the spectators, but as, on this occasion, there would probably be a great number, both of competitors and spectators, some place had to be chosen possessing good communications, and plenty of hotel or other accommodation. These facts contributed to the choice of the Committee falling on Nynäshamn, a place that had the additional advantage of permitting the greater part of the racing to be viewed from the land.

Preparatory work of the Yacht Racing Committee.

The programme of the races at the Fourth Olympiad, in 1908, was taken as the guide for the Yacht Racing Committee's plan for the Olympic Races in 1912, although certain essential alterations were made in the regulations, etc., in question. As regards the classes of boats that were to compete, the Committee proposed that 6-, 8-, 10- and 12-metre R-classes should be chosen instead of the 6-, 7-, 8-, 12- and 15-metre classes on the Ryde programme. The Committee based its proposal on the fact that the 7-metre class numbered far less than the 10-metres, while the 15-metre class was excluded on account of the great difficulty in having such large boats manned exclusively by amateurs. The system of counting points was also altered; the Ryde figures, 3, 2 and 1, for 1:st, 2:nd and 3:rd places, being changed to 7, 3 and 1 point respectively, for the same places. The view was taken that a first place was better than two second, and one second place better than two third. This method of calculation possessed the additional advantage of reducing the number of ties that had to be re-sailed.¹

When the plan had been drawn up in detail, it was submitted to the Yacht Club Committee, whose approval it gained, the scheme being afterwards sent to the Committee of the Yachtsmen's Association.

The last-mentioned Committee held a meeting in Stockholm, on the 4 December, 1910, when it discussed two questions; first the request, made by the Royal Swedish Yacht Club, that the Association should nominate some members of the Olympic Yacht Racing Committee and, secondly, the above-mentioned plan for the Olympic Races. The Committee of the Association considered that, as the said plan had also to be discussed, it would be more suitable not to nominate any members of the Yacht Club's Olympic Committee, but to consider at once the programme of the races now placed before them. The days for the races (which, in part, were predetermined by the necessity of arranging dates that did not clash with the other competitions in the Games) were approved of, and the Committee of the Association expressed its approval of the Olympic Yacht Racing being for boats of the 6-, 8-, 10- and 12-metre R-classes, and of the number of the entries in each class from each country being restricted to two yachts.

The first part of the labours of the Yacht Racing Committee was thus concluded, and the programme of the Olympic Yacht Racing was handed over to the Swedish Olympic Committee. The plan was afterwards discussed by the International Olympic Committee at its meeting at Buda-Pesth in May, 1911, when the programme in question was approved of without any alteration.

Another matter of great importance that had to be arranged, was the fixing of the racing-dates for the regatta as a whole, and, starting from the days already approved of for the Olympic Races, the Committee of the Royal Swedish Yacht Club drew up the following programme, which received the approval of the Club at a meeting held on the 23 May, 1911.

¹ *In calculating the points for the Olympic Competitions as a whole, however, the official figures, 3, 2, 1 were employed.*



VIEW OF STARTING-PLACE FOR OLYMPIC YACHT RACING.



"ERNA-SIGNE" (Sweden), 2:nd prize-winner, 12-m. class.

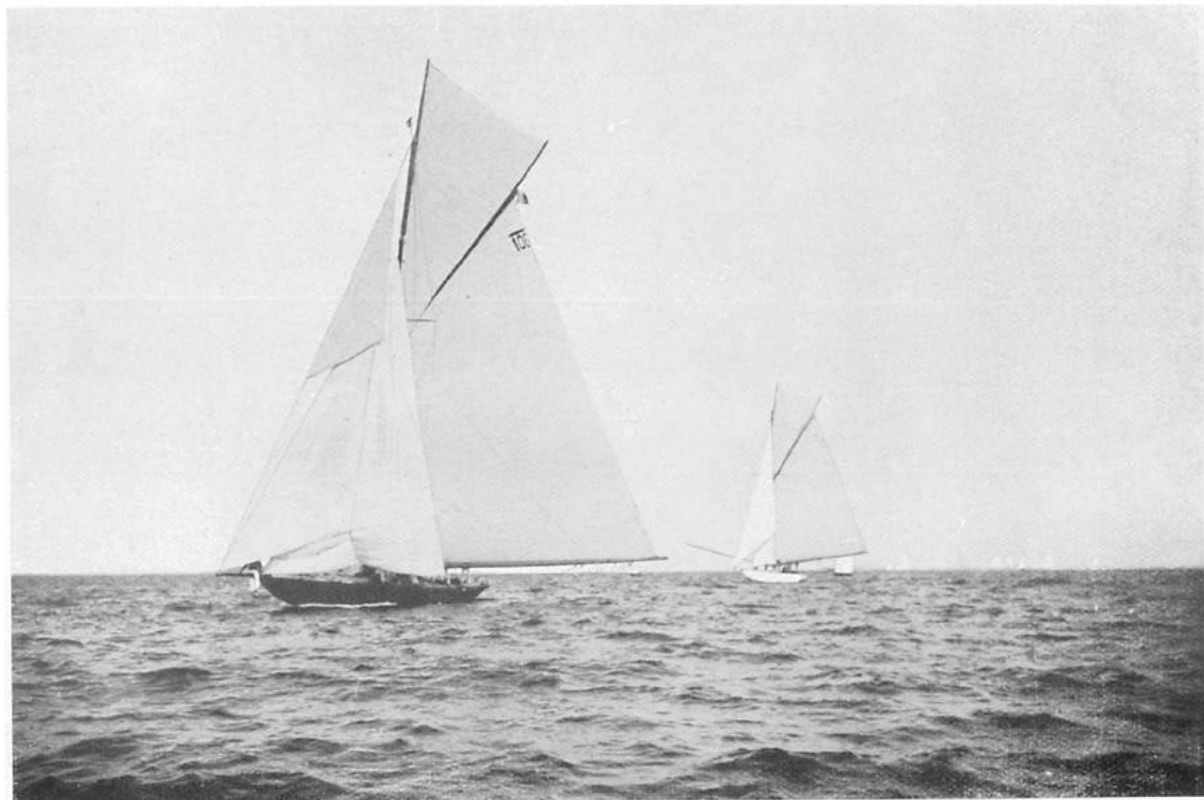

"ERNA-SIGNE" (Sweden) and "HEATHERBELL" (Finland), 2:nd and 3:rd prize-winners, 12-m. class.



"NINA" (Finland). 2:nd prize-winner, 10-m. class.



"SANS ATOUT" (Sweden) 2:nd prize-winner, 8-m. class.



"LUCKY GIRL" (Finland) 3:rd prize-winner, 8-m. class.

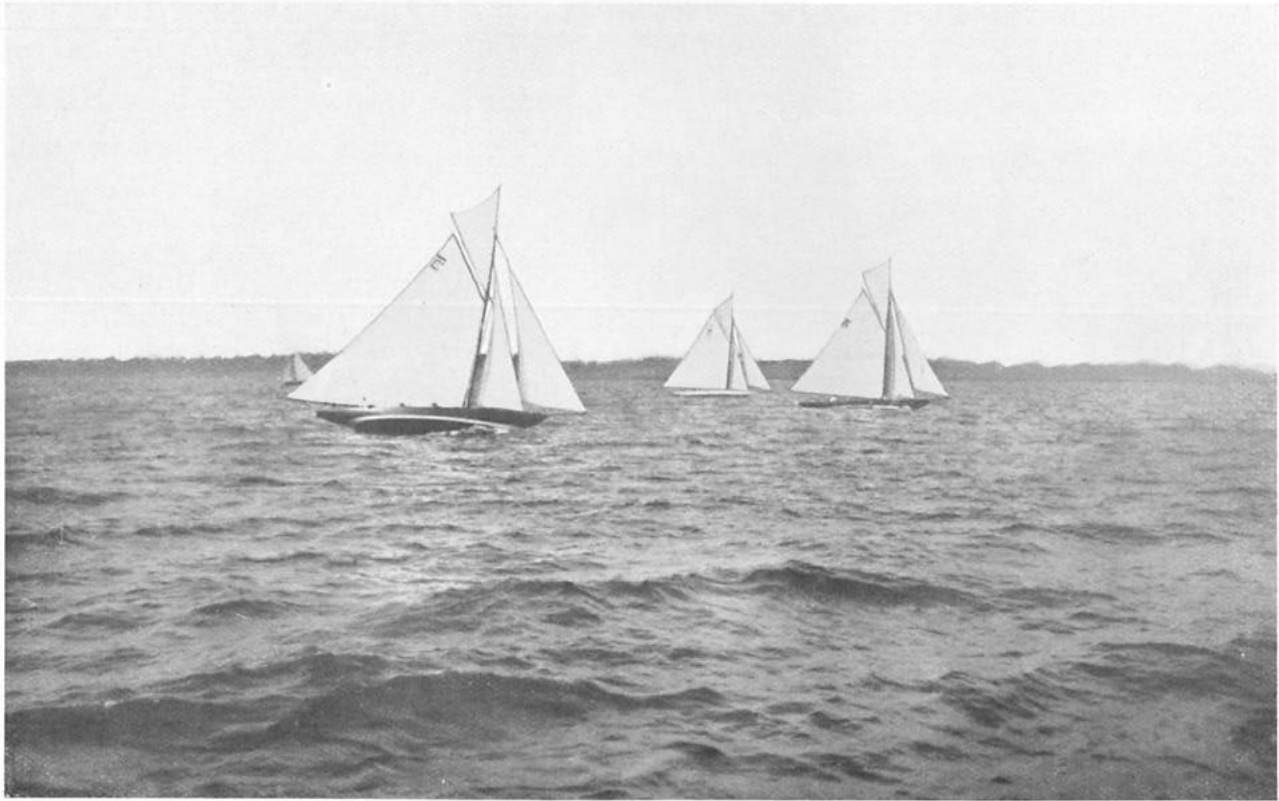

"TAIFUN" (Norway); "NORNAN" (Russia) and "ÖRN" (Finland) 8-m. class.



"NURDUG II" (Denmark). 2:nd prize-winner, 6-m. class.

- Friday, 19 July: Yachts assemble at Nynäshamn.
 Saturday, 20 » The first Olympic Race and general International racing at Nynäshamn.
 Sunday, 21 » Second Olympic Race and general International racing at Nynäshamn.
 Monday, 22 » Eventual re-sailing of ties in the Olympic Races.
 Tuesday, 23 » General International long distance racing inside the skerries, from Nynäshamn to Sandhamn.
 Wednesday, 24 » No racing.
 Thursday, 25 » General International race in Kanholm Firth.
 Friday, 26 » Cup Races and general International racing at Sandhamn.
 Saturday, 27 » Sailing in to Stockholm. Farewell banquet and distribution of prizes, 7 p. m.

On the 31 August, 1911, the Club Committee assembled again for the purpose of drawing up a plan for the arrangement of the approaching regatta as a whole. In addition to the sailing- and finance-committees, the following sub-committees were also appointed: a traffic- and accommodation committee; a Press committee; a reception- and entertainments committee, and an advertising committee. The President and Secretary of the Yacht Club were, *ex-officio*, members of all these sub-committees.

The question was discussed at the same time of the position of the Finnish yachts at the Regatta, and the Committee determined to invite the 6-, 7-, 8- and 9-metres classes (measured in accordance with the American rule) to take part in the meeting.

The Regatta had thus received its organisation, and the best description of the work carried out will be an account of what was done by the various committees. It should be mentioned beforehand, however, that the Yacht Club Committee, in order to render the work of organization less involved, determined at a later meeting, to dissolve the Yacht Racing Committee and to replace it by an executive, which should take in hand the preparatory work for the racing. The following gentlemen were elected members of this executive: Capt. O. Holtermann, Ed. Cederlund, Esq., J:nr., and R. Bovin, Esq., (President, Vice-President and Secretary of the Club, respectively), K. J. Ljungberg, Esq., and Hugo Andersson, Esq. With the same aim in view, it was also determined that the President and Secretary should decide which of the measures of the different sub-committees were to be submitted to discussion by the Club Committee before being put into execution, while the President, Vice-president, Secretary and Treasurer, collectively, were empowered to settle all financial questions concerning the Olympic Races.

The Finance Committee and its work.

After one or two resignations and fresh elections, the composition of the Finance Committee was finally as follows: Messrs. Ed. Cederlund, J:nr.; K. Bovin, J. Sjö Dahl, G. Steinwall, F. Nyberg, Hjalmar Andersson, C. F. Tranchell, G. Settervall and C. Frisk.

Detailed calculations were made respecting the cost of the Regatta, and subscription lists were issued for the purpose of obtaining money to cover the expenses. The appeal thus made in the name of the Club to the friends and votaries of yacht racing in Stockholm was not fruitless, for when, after the conclusion of its labours, the Finance Committee dissolved in December 1911, it was able to hand over to the Club a sum of no less than £ 2,800 (\$ 14,000).

The Advertisement Committee and its work.

K. J. Ljungberg, Esq.; Lieut. R. von Heidenstam; Hugo Andersson, Esq.; Thore Blanche, Esq., and Ch. Cahier, Esq., were elected members of this Committee. As early as in the spring of 1911, in consequence of the approaching Regatta, Mr. Blanche, at the request of the Club Committee, had kindly written an account of the Club, its development and work, intended for distribution to persons believed to be interested in the matter. The pamphlet, which had a wealth of illustrations, contained, in addition to some historical data respecting the Club and the races it had held, a lively and elucidatory account of the archipelago of Stockholm, and a description of the types of boat best suited to its waters. Successful photographs were also given of the Challenge Cups presented by the Club. The little book was published in Swedish, English and German, and the first thing the Committee had to do was to take measures for its general distribution. Lists were made of Swedish and foreign yacht clubs, newspapers and journals, copies of the booklet being then forwarded to the clubs and publications in question. At the same time the Club Committee confirmed the proposal, made by the sub-committee, to send a copy of the pamphlet, together with the annual report, to every member of the Club.

The Committee also took measures to have various articles written and published, intended to attract the attention of the public to the Regatta. The secretaries of the various yacht clubs at home and abroad were requested to inform the owners of yachts of the date of the Regatta, and to send the Committee information respecting those yacht-owners who intended to compete, besides which, special attention was drawn to the International racing events which were to be held at the same time as the Olympic Races. The yacht-owners who were members of the Club were also requested to enter as many of their boats as possible for the International events.

The Work of the Traffic- and Accommodation Committee.

Whenever a great regatta is held in the archipelago of Stockholm, the existing local conditions always necessitate extensive preparations as regards communications, accommodation, etc. On the occasion of this Regatta, the work in question was doubled, as races were to be held both at Nynäshamn and at Sandhamn. This made it necessary to have a special sub-committee for each place. That for Nynäshamn consisted of Messrs. G. Norström, E. A. af Eken-

stam; E. Sterner, L. Widberg, A. Ljunggren and O. Lindeberg, while the members of that at Sandhamn were Messrs. T. Öhlin, G. Eklund and T. Sjöblom. Captain E. Frestadius was elected a member of both committees. The Nynäshamn committee elected from its members an executive consisting of Messrs. E. A. af Ekenstam, E. Sterner and L. Widberg.

This was the first time that Nynäshamn had been chosen as the scene of a great regatta, and this fact rendered the task of the committee more laborious, although the place was better off than Sandhamn in so far as that, thanks to good railway communications, yachtsmen and spectators could, if necessary, have rooms in Stockholm, while the three hotels at Nynäshamn were easily able to satisfy the daily wants of all the visitors.

Sandhamn, on the other hand, could not be reached so conveniently, and the principal place where meals could be had was the Club-house, so that it was necessary to make special arrangements to supply deficiencies in these respects. The Club Committee, therefore, hired the S/S "Ångermanland", of the Svea S/S Co., for the racing out at Sandhamn, and the Committee of the Stockholm Yacht Club was kind enough to allow the Royal Yacht Club to use its Club-house at Sandhamn during the same period. These measures greatly increased the possibilities of providing visitors with sleeping accommodation and meals during the Regatta.

The first step of the chief Committee was to issue a circular, accompanying the invitation to take part in the Regatta, containing directions for procuring rooms at Nynäshamn and Sandhamn. That of the local committees was to ascertain the number of beds that could be had at Nynäshamn and Sandhamn, both at the hotels and in private houses. This inquiry soon showed, as was to be expected, that the accommodation in question by no means corresponded to the expected demand for rooms, so that the Yacht Club, on the recommendation of the Committee, obtained permission from the Royal Naval Board to borrow 300 bedsteads, with 1 mattress, 1 pillow, 2 sheets and 2 blankets for each, from the Vaxholm Coast Artillery's depot, if the supplies there permitted, in consideration of a fixed payment, and on the Club's undertaking to make good all damages, and to observe all the other conditions stated in the regulations.

When, in July, 1912, the supplies in question were going to be taken from the depot, it proved that the demand for beds was less than had been calculated, so that only 200 bedsteads were borrowed, 100 for each place. Some of these beds were supplied to private houses, whilst others were sent to the schools at Nynäshamn and to the premises belonging to the Stockholm Yacht Club at Sandhamn.

Accommodation inquiry-offices were opened at both places, the local committees supplying them with all necessary information respecting the rooms, etc., available for visitors.

Arrangements for meals for visitors to Nynäshamn were also made, by agreements respecting prices being entered into with the Strand Hotel and the Railway Hotel there. In addition to this, the Railway Hotel

undertook to cater for the crews of the yachts, at stated hours and fixed prices, and large tents were erected at this house and at the Bath Hotel, for the convenience of the guests expected.

An agreement respecting charges was made with the landlord of the restaurant at the Sandhamn Club-house, and the local committee also succeeded in making arrangements for the catering for the yacht crews at this place too.

One important detail that the Regatta Committee had to arrange, was that of the communications. The Stockholm—Nynäs Rly. Co. was good enough to run special through trains all the time the Regatta lasted, the hours of departure and arrival being so fixed that both competitors and sightseers could be out at Nynäshamn in good time every morning, and return to Stockholm in the evening after the racing was over.

In order to give the representatives of the Press, the members of the Club and their guests an opportunity of seeing all the races, the Club Committee hired the steam-yacht "Saga" for the Regatta week, and the S/S "Sandhamns Express" kept up communications between Stockholm and Sandhamn, running extra trips on Regatta days, this making it possible to leave the city in the morning to take part in, or view, the racing, and then to return to Stockholm in the evening.

The work of the Press Committee.

The members of the Press Committee were Messrs. F. Nyberg, H. van Rijswijk, A. Lilja, Th. Blanche, and E. Pallin. The task of this Committee was to make the necessary arrangements for facilitating the work of the Press during the Regatta. It was with a thought to this that the Club Committee had hired the "Saga", and reserved 40 places on board for the Press. The Press Committee sent inquiries to the yachting journals at home and abroad, asking whether it was their intention to send any special correspondents to the Regatta. On the receipt of the replies, Press cards were at once sent to the representatives in question, admitting them to the Saga. The remaining places on board the vessel, some 30 in number, were then handed over to the Press Commissioner of the Olympic Games, for distribution among other newspaper correspondents present at the Games.

The work of the Reception and Entertainments Committee.

The composition of the Regatta Reception and Entertainments Committee was as follows:

H. R. H. Prince Wilhelm; Edw. Cederlund, Esq., J.nr.; F. Nyberg, Esq.; Captain E. Frestadius; Lieut. R. von Heidenstam; Admiral J. Hagg; H. Granholm, Esq.; J. Jahnsson, Esq., Consul General; G. Norstrom, Esq.; Count C. Lagerberg, Gentleman-in-Waiting; Professor Hj. Sjögren; Messrs. Ch. Cahier, B. Clarino, H. Hansen, Gustaf Steinwall, K. A. Lagergren, H. van Rijswijk, N. Lundgren, Captain J. Lagerkrantz and E. Hallin, Gentleman-in-Waiting.

This "Committee of Honour of the Regatta elected from among its members an executive, consisting of Messrs. Nyberg, Frestadius, van Rijswijk, Lundgren, Lagerkrantz and B. Clarino, whose task it was to make all the necessary preparations for the entertainments that were to take place during the Regatta, viz., the reception festival and the farewell banquet.

At one of its meetings, the Committee determined to give its reception entertainment at the Nynäshamn Bath Hotel, and the farewell banquet at Hasselbacken, in Stockholm. The Nynäshamn Bath Hotel proved a most suitable place for the first entertainment, although it was found necessary to take special measures for seating the great number of guests expected to be present.

A report of these entertainments and of the speeches made on both occasions will be found in the section of this book entitled "Official Festivities".

The work of the Special Yacht Racing Committee.

The special committee for the races had, first of all, to draw up a form of invitation to the Olympic and International yacht racing and, in connection with the first of these, to give a definition of the word "amateur" as applied to yachtsmen, this definition to be approved of by the Committee of the Swedish Yachtsmen's Association for the Olympic Yachting Races in 1912. The invitation was issued, in Swedish, English and German, after a list had been drawn up of home- and foreign yacht-clubs and owners. The next thing was to arrange the various courses. At Sandhamn there were the old ones ready to hand, but at Nynäshamn it was necessary to buoy off no less than 5 different courses; 2 for the Olympic Races, 2 for the International events, and 1 foul weather course.

The Committee visited the place and fixed the position of the starting line, the way in which it should be marked, and the length of the various legs of the triangular courses. The chart of the waters was enlarged to twice the scale, and the courses were marked out on this, giving the starting-line and all rounding flags, as well as all the special flag-marks that had to be laid out to distinguish dangerous shallows. In addition to this, harbour- and entrance charts of Nynäshamn and Sandhamn were drawn, on which were given the positions of the extra flag-marks that had been laid out in order to mark the shallows.

One thing that took a long time to arrange was the drawing up of the programme for the starts, a very comprehensive publication, and an early beginning was made with writing it in both Swedish and English. There afterwards being but very few entries from England and Germany, it was found unnecessary to publish this programme in English, but some type-written copies of the description of the course were made in that language, and these were distributed to the competitors from abroad.

A very important matter was the stationing and mooring of all the yachts, both the competing vessels and those that were only spectators. At Nynäshamn, this question was settled by the building of a

long pier which the Club Committee decided to have made, and by laying out the necessary number of buoys. At Sandhamn, the yachts had to lie at their own anchors, and no other measures were taken but to increase the number of warping-buoys, and make a number of land-moorings.

Finally, the Sailing Committee took the necessary steps to discover a number of suitable officials to act at the Regatta, as it would be necessary to strengthen the ordinary staff on such an important occasion as the approaching Olympic Regatta. The Committee drew up a list which was submitted for the approval of the Club Committee.

Meanwhile the Committee of the Royal Yacht Club had a number of other matters in hand, such as the rebuilding of the club-house at Sandhamn, the erection of piers at Nynäshamn and Sandhamn, etc.

According to the rules, the prizes for the Olympic Yacht Racing were to consist exclusively of medals, to be awarded to the steersmen and crews of the winning boats. But in order to be able to reward the owner of the winning yacht, too, the club had a sketch made for a commemorative plaque, and rules were drawn up for its award, these steps afterwards receiving the approval of the Club.

At the close of entries it proved that the names of no less than 144 yachts had been sent in, a figure that certainly constituted a world's-record. For the Olympic Races there were 24 yachts entered from 6 different nations, and belonging to the following classes.

	Sweden	Finland	Norway	Russia	France	Denmark	Total
12-Metre class	1	1	1	—	—	—	3
10- " "	2	1	—	1	—	—	4
8- " "	2	2	2	2	—	—	8
6- " "	2	1	1	1	2	2	9
	7	5	4	4	2	2	24

After the close of entries, the number of competitors being then known, the Committee began the work of arranging the start-programme. The available space was measured on the various harbour-charts and reproduced on original charts on a greatly enlarged scale, and on these were marked the positions assigned to each class and every yacht, after which, this placing was reproduced on the smaller harbour-charts, a copy of which was given to each boat.

THE THREE OLYMPIC DAYS AT NYNÄS.

On Friday, the 19 July, the yachts that were to take part in the Olympic Regatta and in the International Races arranged in connection with it, assembled at Nynäs.

The vast flotilla, consisting of no less than 130 racers and about as many other yachts and pleasure steamers, was at length anchored

at Nynäshamn. Some lay outside the harbour, some in the inner bay, and 50 of the smaller boats lay alongside of a quay specially built just outside the Club House. In the afternoon all the boats had their pennants hoisted, and the scene presented was a most festive one, which was heightened by the presence of half-a-dozen steam yachts at anchor in the harbour.

The Reception festivities arranged by the Committee took place at 8 p. m. at the Bath Hotel, and went off very successfully indeed.

THE RACING ON JULY 20.

The Olympic Yacht racing began at Nynäs on Saturday, 20 July.

It was beautiful weather with a light easterly breeze, the velocity varying between 3—5 metres. The courses were arranged out to sea, south of Nynäs, the first side of the triangle having to be passed with a half-wind on a starboard tack, the second close-hauled and the third with the wind free. The first start, that for the 12-metre class, was made at 11 a. m., after which came the other classes at intervals of a quarter of an hour.

12-Metre class.

In the 12-metre class, the order of starting was as follows: Heatherbell, representing Finland; Erna-Signe, Sweden, and Magda, Norway.

The start was a good one, and the Swedish boat lying best to windward and running quickest, at once began to draw away from the other competitors.

Erna-Signe kept its lead the whole way up the half-wind side, and rounded the first flag a good number one. During the tacking-bout that succeeded, the Heatherbell left the other two boats and tried its fortunes out to sea beneath Norrskär. A sharp struggle ensued between the Swedish boat and the Norwegian. Magda soon crept nearer and nearer to the Erna-Signe and, about half way on the tacking leg, passed the Swedish boat and then kept the whole time between the buoy and Erna-Signe, lying on the same tacks as the latter. The Magda proved itself a good cruiser and lay very close to the wind. By degrees Heatherbell came back from seawards; but it proved to be behind its rivals.

The order mentioned was retained until the flag-ship was reached.

10-Metre class.

The order of the 10-metre yachts on starting was: Marga, representing Sweden; Kitty, Sweden; Nina, Finland, and Gallia II, Russia.

Kitty lay very well, but its balloon was yarned too tight and could not be got out for a couple of minutes, this causing the boat to fall off a little, but when the sail filled, the boat rapidly made up lost ground and was soon leading. Nina took second place and the race was finished without any alteration in the relative positions of the boats. The Russian, Gallia, II was close behind the Finnish boat at the flag-ship, Marga being last.

8-Metre class.

In the start for the 8-metre yachts, Sans Atout (Sweden) crossed the line first, but Taifun (Norway) also had a good position and soon took the lead in this division.

At the beginning of the tacking-leg, Taifun led, followed by the Sans Atout, the Finnish boat, Örn, the Russian representative, Norman, Lucky Girl (Finland), and Bylina (Russia). During the latter part of the course, the Sans Atout ran up beautifully and, taking the lead, rounded the yellow flag and started the run before the wind one minute before the Taifun. A good distance behind came the two Finnish boats, Örn and Lucky Girl, and Norman. Then came the run with the wind from starboard. Sans Atout at once set its spinnaker sheeted well forward, while Taifun was doing its best with the balloon alone; after a couple of minutes, however, the Norwegian boat found it more advantageous to follow the example of its Swedish rival, and got its spinnaker up, too.

During the run in, the Taifun managed to creep past the Swedish boat, and came in a narrow winner.

6-Metre class.

The start in the 6-metre class was a good one, all the boats being well together, with the Kerstin a little in front. On the half-wind leg the Frenchman, Mac Miche, took the lead, but the Kerstin was close up, with Nurdug II in the same group, while the other three boats, Sass, Finn and Sonja, formed a bunch by themselves in the rear.

The struggle between the Frenchman and the Dane continued the whole time. During the cruise, Mac Miche succeeded in retaining its little advantage and rounded the yellow flag at the beginning of the third side 25 seconds before the Nurdug II.

Sass lay 4 minutes behind. During the cruise, its main-sail had lain very badly, the boom almost trailing through the water, and it was remarkable, under the circumstances, that it could keep third place. It was evident that Herr Mark did all that he could with the boat, such as it was.

During the run free the Dane proved the better sailer, and was soon in front, and defended its position successfully to the end against all the attempts of its rivals to pass it.

The order in which the yachts passed the flag-ship was, therefore; Nurdug II, Mac Miche, Sass.

Results on Saturday, 20 July, 1912.

Wind: E. N. E. Velocity of wind: 3.6—4 metres per sec.

Start I. (Course 1.)

12-Metre class.

	<i>Elapsed and corrected Time:</i>	<i>Points:</i>
Erna Signe	3'24'13	3
Magda IX	3'17'17	7
Heatherbell	3'25'45	1

Start II. (Course 2.)

10-Metre class.

	Elapsed and corrected Time:	Points:
Gallia II	3'59'20	1
Nina	3'59'07	3
Marga	4'01'11	
Kitty	3'46'04	7

Start II. (Course 3.)

8-Metre Class

Sans Atout	2'16'40	3
R. S. Y. C. 1912 (lottery boat)	2'23'46	
Taifun	2'15'59	7
Lucie IV	Did not start.	
Lucky Girl	2'21'03	
Örn	2'17'28	1
Norman	2'18'52	
Bylina	2'27'59	

Start IV. (Course 2.)

6-Metre class.

Kerstin	2'44'54	
Sass	2'37'01	1
Finn II.....	2'39'33	
Nurdug	Did not start.	
Nurdug II	2'34.41	7
Sonja III	2'39'48	
Mac Miche	2'35'20	3
Phoebé.....	Did not start.	
Schkitz.....	Did not start.	

THE RACING ON JULY 21.

On Sunday, the second Olympic race took place out to sea off Nynäs, and was of course a very exciting one, for on the results of this day's competition depended whether Sweden was to be first or not among the nations that had taken part in the Olympic Games. The position appeared to be a very promising one but, on the other hand, one knows how disappointing a race may prove.

The Swedes grew very uneasy in the morning when they saw how the wind was, for there was only a light breeze blowing which, about 10 o'clock was scarcely stronger than 2 metres per second, and many of the boats which, it was hoped, would be able to get a place, such as Sans Atout and Sass, were in every respect lively weather boats.

The courses for Sunday's races were the same as those for Saturday, with a light wind the first side, a close-hauled bout for the second, and a wind-aft run for the third. The result of the racing was as follows:

12-Metre class.

In the 12-metre class, the Erna-Signe (Sweden) had a clear lead of Magda (Norway) and Heatherbell (Finland), but before very long Magda went ahead and remained there for the rest of the race. The struggle between the Swede and the Finlander was a severer one. For a long time Erna-Signe was in front but, during the tack down the second

leg, Heatherbell overtook her, and when two-thirds of this side had been run, the Finnish boat showed just ahead for a little while. The Erna-Signe ran better wind-free, however, caught up her rival, passed her, and so came in second.

10-Metre class.

In the 10-metre class, the Russian yacht, Gallia II, started very well, but Kitty soon took the lead and was never afterwards threatened. The two Swedish representatives separated, the Kitty, from Stockholm, keeping well out to sea in the tacking-bout, while Marga went inshore, the Gothenburg boat losing by this manoeuvre, although she was sailed very well.

8-Metre class.

In the 8-metre class Taifun (Norway) got a very good start, passing the line a few seconds after the gun was fired, and closely followed by Lucky Girl and Örn, all three well up under the land, while, in a bunch at the other end of the starting line came Sans Atout, the "lottery boat" and Norman.

It was evident that the light winds suited the Norman (Russia), to perfection, and on the close-hauled side she went ahead and obtained a good lead. Rounding the yellow flag for the last part of the course, however, she had a man overboard in setting the spinnaker, in consequence of the sheet not being loosened forwards and, lashing back, knocking the man over-board. Before he was got on board again — a very quick piece of work, a buoy being thrown out instantaneously — the yacht was hopelessly in the rear.

Taifun now went in front and won, Sans Atout being outpaced in the light winds that prevailed.

6-Metre class.

There was a beautiful start in the 6-metre class, all the boats crossing the line in a cluster and at a very good speed, Sonja III, which went ahead like an arrow, being the first, closely followed by Mac Miche, Kerstin, Sass and Nurdug II.

The Norwegian boat had to leave its front place very soon, however, Mac Miche relieving it there, while the Kerstin and Nurdug did very well indeed in the light airs.

Along the second leg the Frenchman increased his lead, and was soon sufficiently ahead to be certain of obtaining first place, and Mac Miche rounded the flag for the wind free run, a very good first. Then came the Nurdug and Kerstin close together, with Sass and Sonja in company behind. There was a hard struggle between the Nurdug and Kerstin for second place, but, in the weather that prevailed, the Dane was the better boat and, in spite of skilful handling, the Kerstin could not pass her rival. During this duel, both the boats, in consequence of continual luffing, came a good way in shore on the starboard side.

The result of the struggle between Sass and Sonja was, that the former kept the little lead it had — a result to be expected of a skipper of Herr Mark's ability.

The positions in the various classes after Sunday's racing were, therefore, as follows.

12-metre class: 1:st prize, Magda, Norway, two wins. 2:nd prize, Erna-Signe, Sweden, two second places. 3:rd prize, Heatherbell, Finland, two third places.

10-metre class: 1:st prize Kitty, Sweden, two wins. Nina, Finland, and Gallia II, Russia, tied, each having a second and third place, so that these two boats had to sail off the tie for the second and third prizes.

8-metre class: 1:st prize Taifun, Norway. Sans Atout, Sweden, and Lucky Girl, Finland, had each a second and third place, and had to sail off the tie for the second and third prizes.

6-metre class: 1:st prize, not yet decided. Mac Miche, France, and Nurdug II, Denmark, had each won a first and a second place, and had to sail off the tie for the 1:st and 2:nd prizes. Sass, Sweden, and Kerstin, Sweden, had to resail for the third prize.

Results on Sunday, 21 July 1912.

Wind: N. E. by N. Velocity of w.: 3.9—4 metres.

Barometer: 760 mm. Clear.

Start I. (Course 1.)

12-Metre Class

	<i>Elapsed and corrected Time:</i>	<i>Points:</i>
Erna-Signe	3'48'06	3
Magda IX.....	3'32'00	7
Heatherbell	3'48'55	1

Start II. (Course 1.)

10-Metre class.

Gallia II	3'45'38	3
Nina	3'50'09	1
Marga	3'50'30	
Kitty	3'43'51	7

Start III. (Course 2.)

8-Metre class.

Sans Atout	2'16'04	
R. S. Y. C. 1912 (lottery boat)	2'16'33	
Taifun	2'12'59	7
Lucie IV	Did not start.	
Lucky Girl	2'14'50	3
Örn	2'14'54	1
Norman	2'16'15	
Bylina	2'21'43	

Start IV. (Course 2.)

6-Metre class.

Kerstin	2'26'44	1
Sass	2'30'24	
Sonja III	2'30'39	
Finn II	2'31'02	
Mac Miche	2'23'44	7

	<i>Elapsed and corrected Time:</i>	<i>Points:</i>
Phoebé.....	Did not start.	
Nurdug	Did not start.	
Nurdug II	2-26-07	3
Schkitz.....	Did not start.	

Result of Saturday's and Sunday's Olympic Yacht Racing.

12-Metre class.

	<i>1st Points:</i>	<i>2^d Points:</i>	<i>Total Points:</i>	<i>Place accord. to cor. time.</i>
Magda IX	7	7	14	I
Erna-Signe	3	3	6	II
Heatherbell	*	1	*	III

The number of points depended on the result of a protest made by Heatherbell against Erna Signe, and which was not yet decided.

In the 12-metre class there was no tie to be re-sailed.

10-Metre class.

Gallia II	1	3	4	III
Nina	3	1	4	II
Kitty	7	7	14	I
Marga	—	—	—	

Gallia II and Nina had to re-sail the tie for second and third prizes.

8-Metre class.

Sans Atout.....	3	—	3	II
R. S. Y. C.'s lottery bt., 1912 ...	—	—	—	
Taifun	7	7	14	I
Lucky Girl	—	3	3	III
Örn	1	1	2	
Norman	—	—	—	
Bylina	—	—	—	

Sans Atout and Lucky Girl had to re-sail the tie for second and third prizes.

6-Metre class.

Kerstin	—	1	1	III
Sass	1	—	1	
Finn II	—	—	—	
Nurdug II.....	7	3	10	II
Sonja II.....	—	—	—	
Mac Miche	3	7	10	I

Mac Miche and Nurdug II had to re-sail the tie for 1:st and 2:nd prizes, and Kerstin and Sass that for the 3:rd prize.

RE-SAILINGS OF THE TIES, MONDAY, 22 JULY.

Monday was the last day of the Olympic Yachting races at Nynäs. The result of the matches was, that Sweden gained 8 points in the Olympic competitions as a whole, obtained in the following way: Kitty, 1:st prize in the 10-metre class (3 points); Erna-Signe, 2:nd prize in the 12-metre class (2 points); Sans Atout, 2:nd prize in the 8-metre class (2 points) and Kerstin, 3:rd prize in the 6-metre class (1 point).

The weather was still as beautiful as could be, with very light easterly winds which, as before, varied from 4—3 metres.

The first start took place at 11 a. m. for the two 10-metre boats, Nina and Gallia II, which had to re-sail the tie for the 2:nd and 3:rd

prizes, after which, 5 minutes later, came the race between Sans Atout and Lucky Girl for the 2:nd and 3:rd prizes in the 8-metre class. After a similar interval, Mac Miche and Nurdug II started for the gold medal for the 6-metre yachts, the Sass and Kerstin, both Swedish boats, sailing off a tie for the 3:rd prize in the same class.

Of the big boats, the Finlander, Nina, crossed the line 3 lengths in front of the Russian, Gallia II, and kept its lead, passing the flag-ship an easy winner, 2 minutes in front.

The Sans Atout and the Lucky Girl started a good way from each other, the Swedish boat more in shore and the Finnish boat farther out, a position which seemed to be rather an advantageous one. On the close-hauled leg, however, the Sans Atout went ahead and rounded the flag for the wind-aft run, 25 seconds ahead of the Finlander. Then ensued a sharp struggle between the two boats. The Sans Atout got its balloon set very handily and prettily to port, while the Lucky Girl set her spinnaker to starboard and managed to get it to stand. Then the Swede also tried its luck with the spinnaker, but had not luffed sufficiently while running with the balloon, the consequence of which was that the spinnaker lay very clumsily, so that the boat was nearly blanketed by the Finlander. Mr Heyman extricated himself very cleverly, however, and succeeded in rounding the Erlandsgrund mark two lengths in front of his rival. The Sans Atout kept ahead from this point to the flag-ship, the distance being run with scarcely half wind, and even managed to increase its lead to 57 seconds.

Mac Miche (France), and Nurdug II (Denmark), which had to re-sail a tie for the gold medal in the 6-metre class, had a sharp struggle for the windward position just before the gun was fired. About 20 seconds before the signal was heard, the Frenchman luffed, however, and ran down the line, across which he swung when the gun was fired. He seemed to have got some advantage from his position, too, as he escaped coming under the lee of the high land to port.

During the sail to the Erlandsgrund shoal, however, the boats came close together, and a sharp and interesting luffing match began. They had little more than half wind but kept on luffing incessantly, and soon lay almost perfectly still, right in the eye of the wind, a long way inside the flag-mark at the shoal. The Nurdug II was leading, with the Frenchman pushing on from behind. At last the boats had come so far up, that they could not only run free down to the mark, but even set their spinnakers. At the shoal there happened to be both the flag and an ordinary broom-mark, and, owing to the hurry of the exciting match, and the long luff away from the course, the Dane went the wrong side of the sea-mark, and so was out of the running.

It continued the race, however, but, in the weather that prevailed, the Frenchman was the better boat, and on the tacking-course left Nurdug II well behind. At the flag marking the end of this leg, Mac Miche was two minutes ahead, a lead that it increased by another minute during the wind-free run.

France had thus triumphed in the Olympic 6-metre race, Denmark taking second prize.

The Stockholm boat, *Sass*, and the *Kerstin*, from Gothenburg, started for the third prize in the same class. The struggle for the lead at the start was a very sharp one, and the *Sass* lay to windward when the gun was fired, but, crossing a fraction of a second too soon, was called back and had to re-cross the line. It could never make up the time thus lost, and was always a minute behind, so that *Kerstin* won the Olympic bronze medal.

Result of the re-sailing of the ties in the Olympic Races.

Monday, 22 July, 1912.

Wind: E. N. E. Velocity of w.: 4.6—5.1 metres.

10-Metre class.

	<i>Elapsed and corrected Time:</i>	<i>Points:</i>
Gallia II.....	4'23'17	3
Nina	4'21'41	2

8-Metre class.

Sans Atout.....	2'26'44	2
Lucky Girl.....	2'27'41	3

6-Metre class.

Mac Miche.....	2'38'48	1
Nurdug II	2'41'40	2
Kerstin	2'42'32	3
Sass.....	2'44'11	

FINAL RESULTS OF THE OLYMPIC YACHT RACING.

12-Metre class.

1. MAGDA IX ... Alfred Larsen	<i>Norway</i>	Olympic	Gold Medal.
2. ERNA-SIGNE ... N. Person & N. Asp ...	<i>Sweden</i>	»	Silver »
3. HEATHERBELL E. Krogius	<i>Finland</i>	»	Bronze »

10-Metre class.

1. KITTY	N. Asp	<i>Sweden</i>	»	Gold	»
2. NINA.....	Harry Wahl	<i>Finland</i>	»	Silver	»
3. GALLIA II ...	Alex. Wischnegradsky ...	<i>Russia</i>	»	Bronze	»

8-Metre class.

1. TAIFUN ..	Thoralf Glad	<i>Norway</i>	»	Gold	»
2. SANS ATOUT ..	B. Heyman	<i>Sweden</i>	»	Silver	»
3. LUCKY GIRL ..	Bertil & Gunnar Tall- berg	<i>Finland</i>	»	Bronze	»

6-Metre class.

1. MAC MICHE G. Thubé & G. Fitau,, *France** Olympic Gold Medal.
2. NURDUG II ... Otto Reedz Thott *Denmark* » Silver »
3. KERSTIN Dan Broström *Sweden* » Bronze »

* Also won the Challenge Cup presented by the French Government.

The Commemorative Plaque of the Royal Swedish Yacht Club was given in:

Silver-gilt..... to the 1:st boat
 Silver » » 2:nd »
 Bronze » » 3:rd »

The relative positions of the nations, according to the Swedish Olympic Committee's official calculation of points, was as follows:

Nation	1:st prize	2:nd prize	3:rd prize	Points
Sweden	1	2	1	3
Norway	2	—	—	6
Finland	—	1	2	4
France	1	—	—	3
Denmark	—	1	—	2
Russia	—	—	1	1

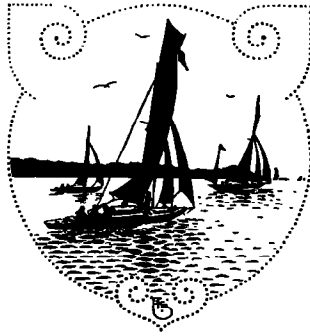

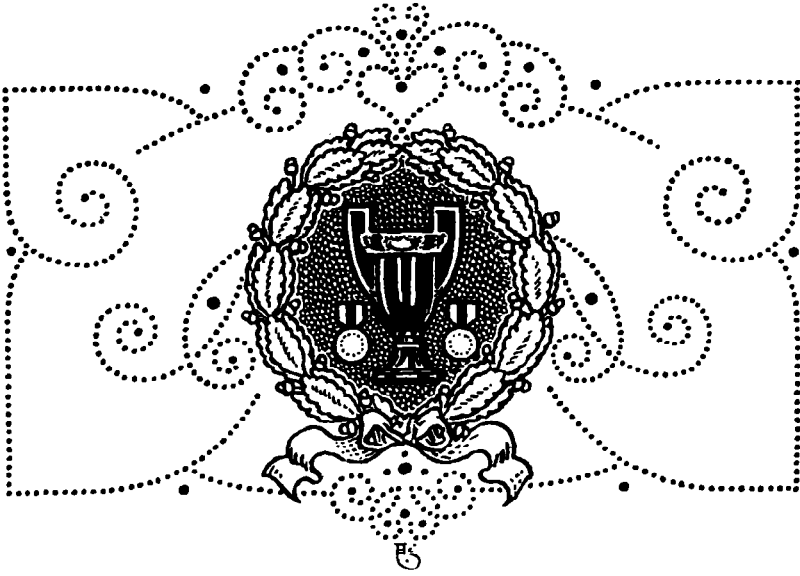

PRESENTATION OF THE PRIZES.

The solemn presentation of the prizes took place at the Stadium at 5 p. m., Monday, 15 July. Immediately after the close of the competitions, all the prize-winners assembled at the north-west entrance, and entered the arena in three columns, the winners of first prizes marching in the middle, those that had won second prizes, to the left, and the winners of third prizes to the right.

This arrangement was adopted, as the presentation of prizes was to take place for all three columns simultaneously, as follows:

In the first group, the prizes were presented by H. M. The King, from a tribune situated below the Royal Box and near the running track. His Majesty gave the winners of first prizes an oak-wreath, the Olympic Gold Medal and the Challenge Prize of the Olympic Games, in the order mentioned.

In the second group, the prizes were given away by H. R. H. the Crown Prince, whose tribune was near the running track and to the right of that occupied by H. M. The King. H. R. H. presented the Olympic Silver Medal to those competitors in the Games who had won a second prize.

In the third group, the prizes were presented by H. R. H. Prince Carl, whose tribune was situated to the left of that of His Majesty. H. R. H. Prince Carl presented the Olympic Bronze Medal to those competitors in the Games who had won a third prize.

The three groups having marched into the arena, were drawn up

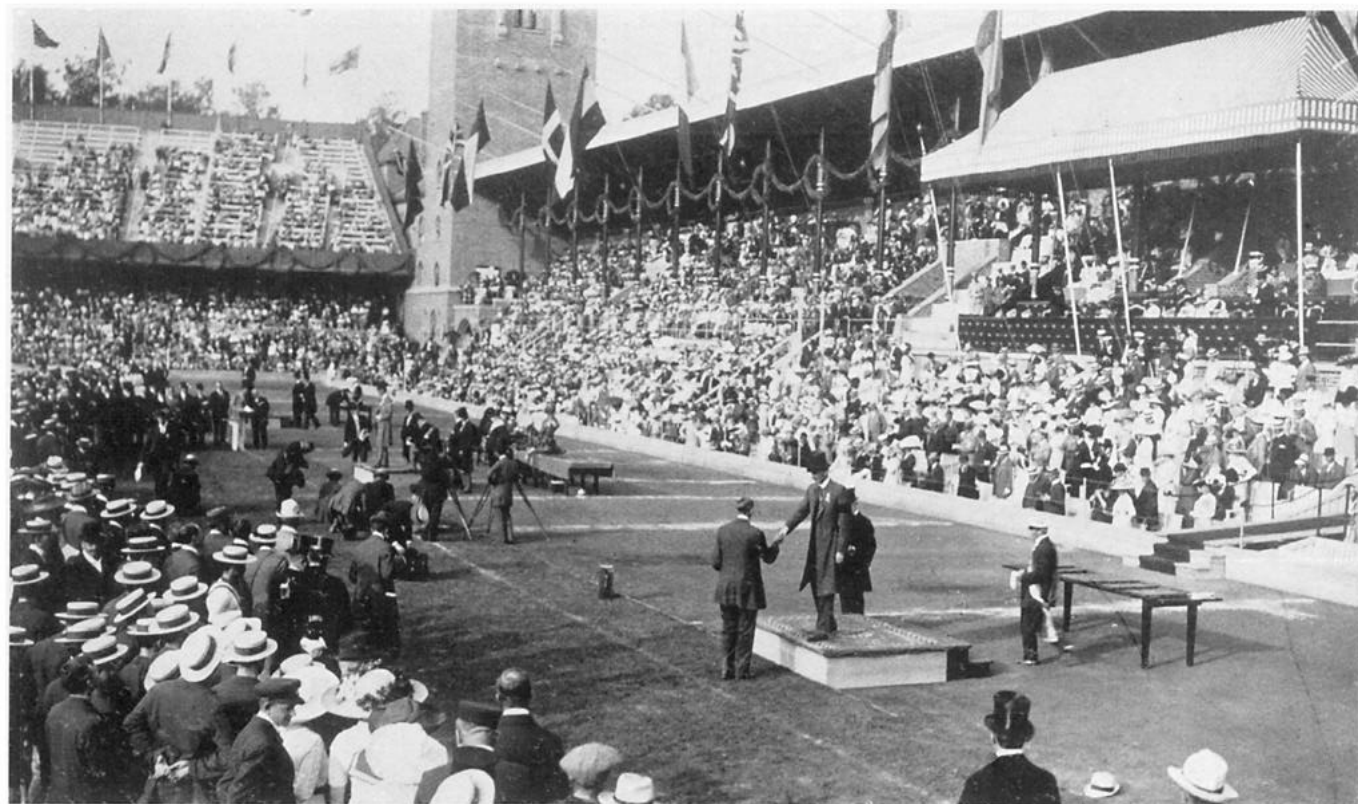

DISTRIBUTION OF PRIZES AT THE OLYMPIC GAMES OF 1912.



CHALLENGE PRIZES AND OAK-WREATHS.

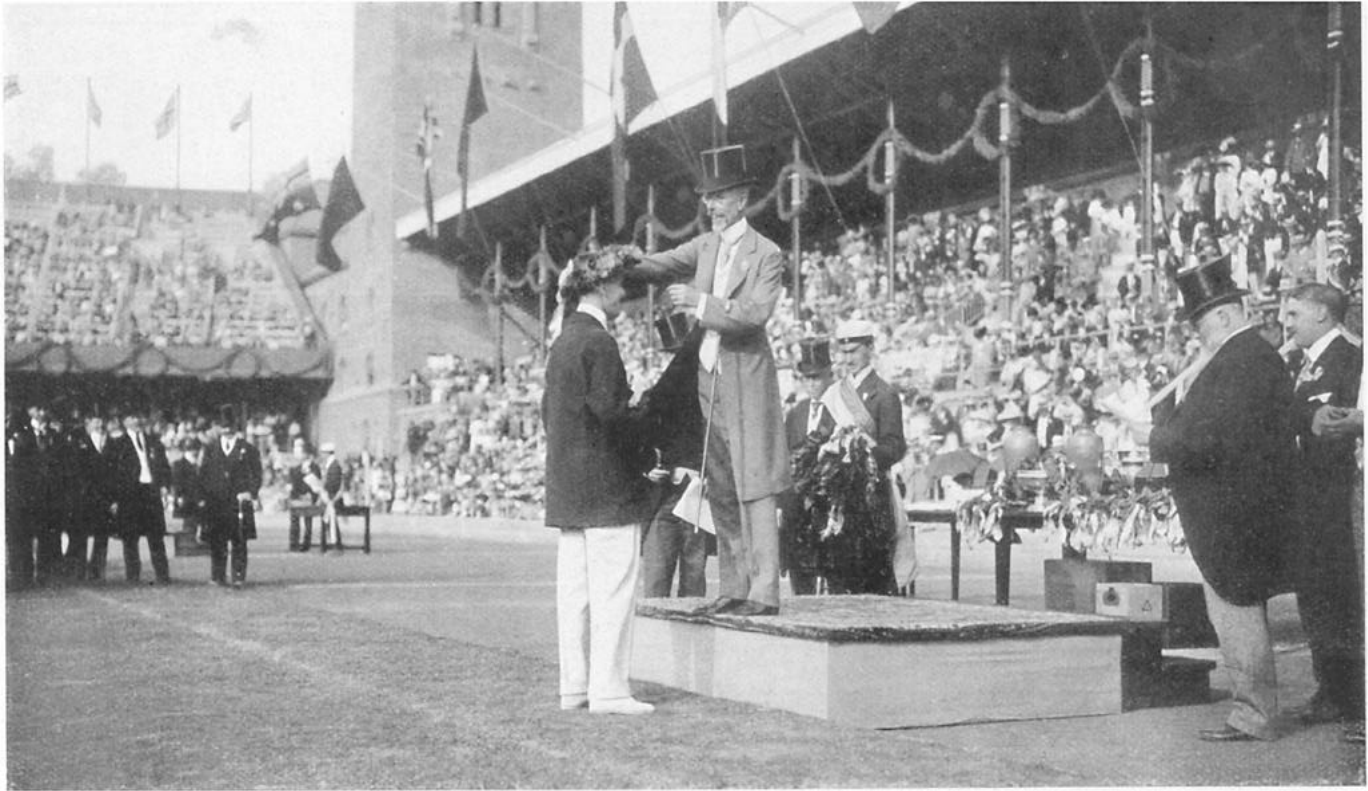

H. M. THE KING CROWNING THE WINNER OF THE 100 M. FLAT.

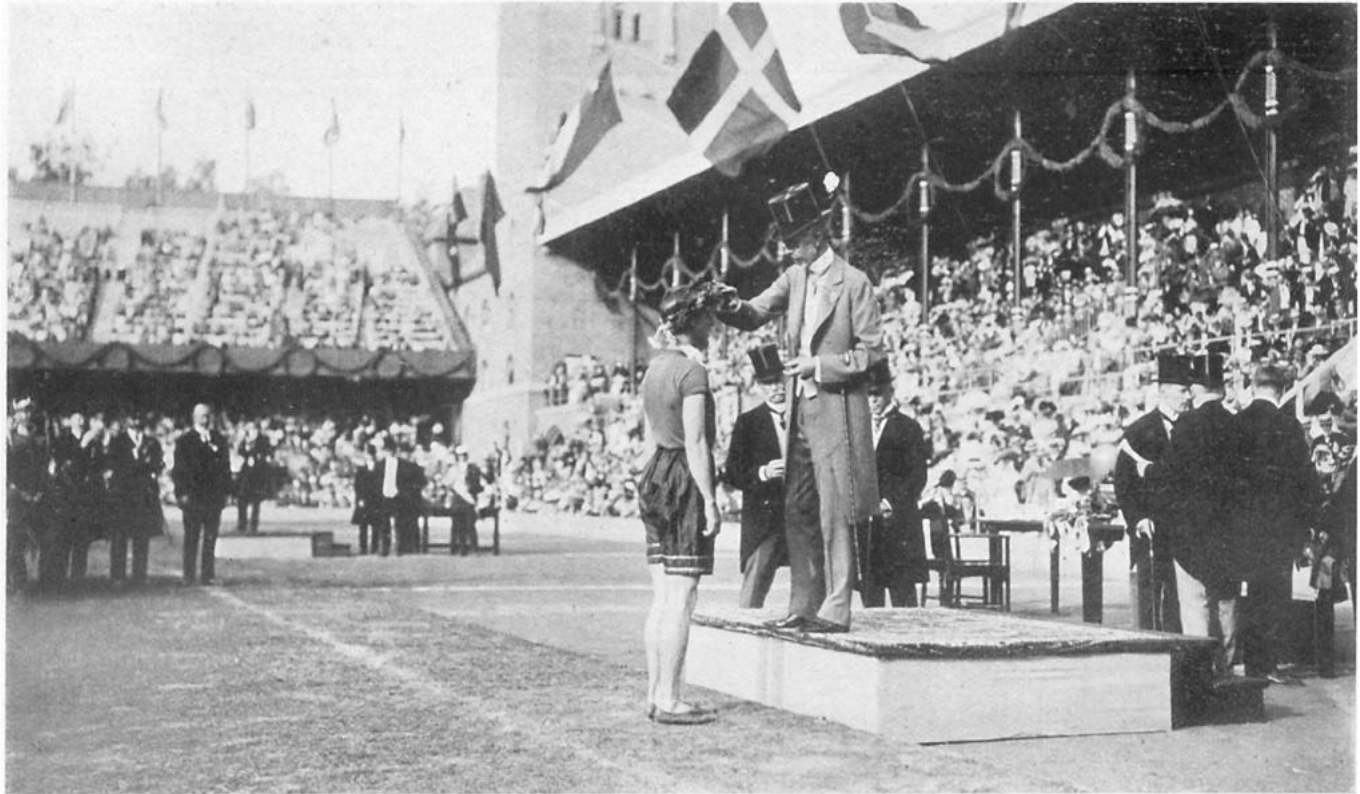

H. M. THE KING CROWNING THE WINNER OF THE MARATHON RACE.



H. KOLEHMAINEN AT THE DISTRIBUTION OF PRIZES.



THE WINNER IN SWIMMING, 100 M., LADIES, RECEIVING HER PRIZE.



H. R. H. THE CROWN PRINCE PRESENTING THE 2:ND PRIZE FOR THE MODERN PENTATHLON.

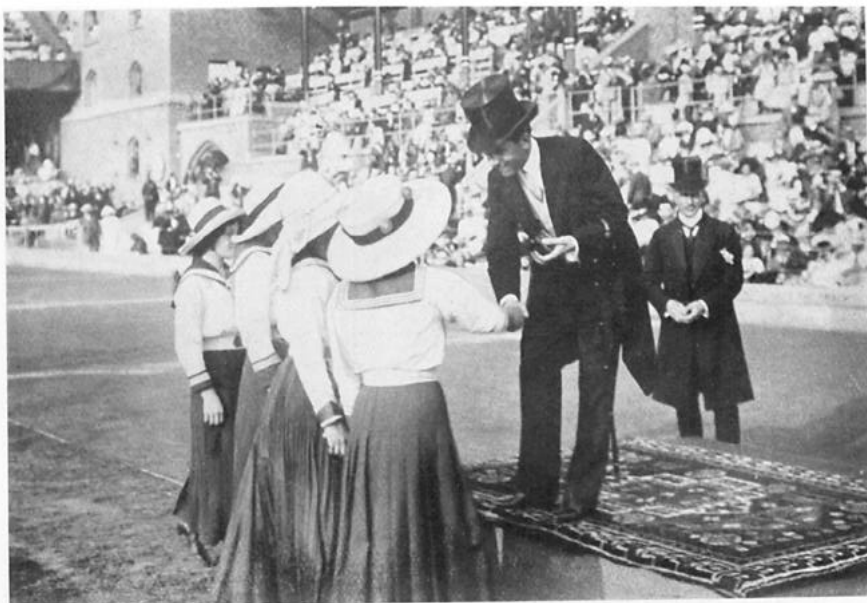

H. R. H. THE CROWN PRINCE PRESENTING THE 2:ND PRIZE FOR TEAM SWIMMING RACE, 400 MET., LADIES.



H. R. H. PRINCE CARL PRESENTING THE 3:RD PRIZE FOR THROWING THE DISCUS.

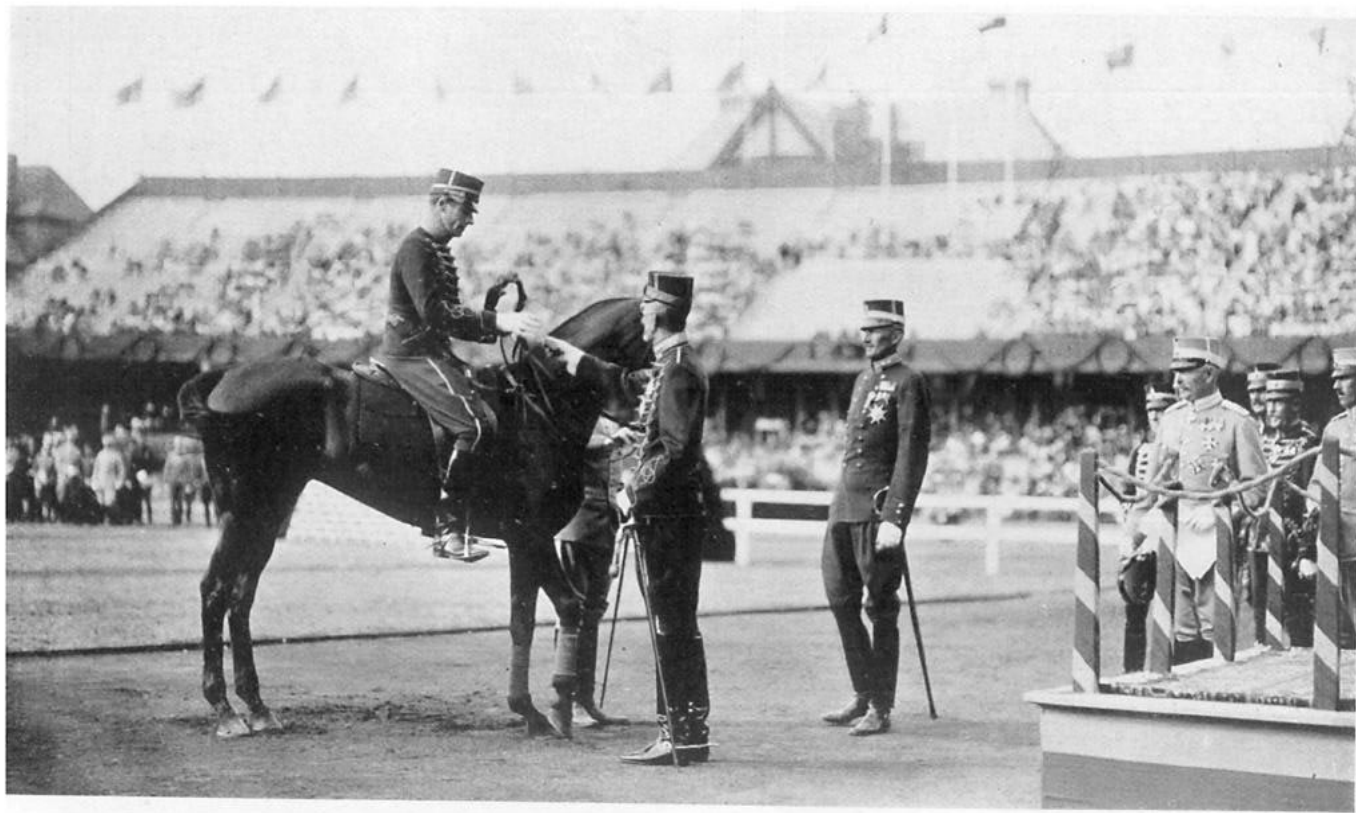

H. M. THE KING PRESENTING THE 1:ST PRIZE IN THE "MILITARY".

in front of the three tribunes. In each group the prize-winners were arranged in accordance with the following list:

ATHLETICS (Field and Track events).

TUG-OF-WAR.

WRESTLING.

FENCING.

MODERN PENTATHLON.

SWIMMING.

SHOOTING.

GYMNASTICS.

The prize-winners having entered, H. R. H. the Crown Prince went forward to the Royal Box, and begged H. M. The King and H. R. H. Prince Carl, to graciously perform the task of presenting the prizes.

H. M. The King then stepped on to the centre tribune, H. R. H. the Crown Prince occupying that to the right of His Majesty's, and H. R. H. Prince Carl that to the left.

A herald called out the name of the prize-winners in each branch of the competitions. The first, second and third men then went forward simultaneously to receive their prizes.

The first competition taken was the 100 metres Flat, so that the first to receive an Olympic Gold Medal was Ralph Craig (U. S. A.). Then came the prize-winners in the other events, in the order in which they were mentioned in the programme.

At the close of the ceremony, Colonel V. G. Balck thanked His Majesty and Their Royal Highnesses on the part of the Swedish Olympic Committee, and called for cheers for H. M. The King. H. R. H. the Crown Prince concluded the proceedings by calling for three cheers for the prize-winners.

The presentation of the prizes in the events which were held before or after the Olympic Week, as it was called (July 6—15) — Football, the Horse-Riding competitions, Lawn Tennis, Rowing, Shooting, Swimming and Yacht Racing — took place at the scenes of the competitions immediately after their close.

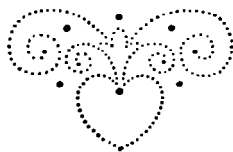

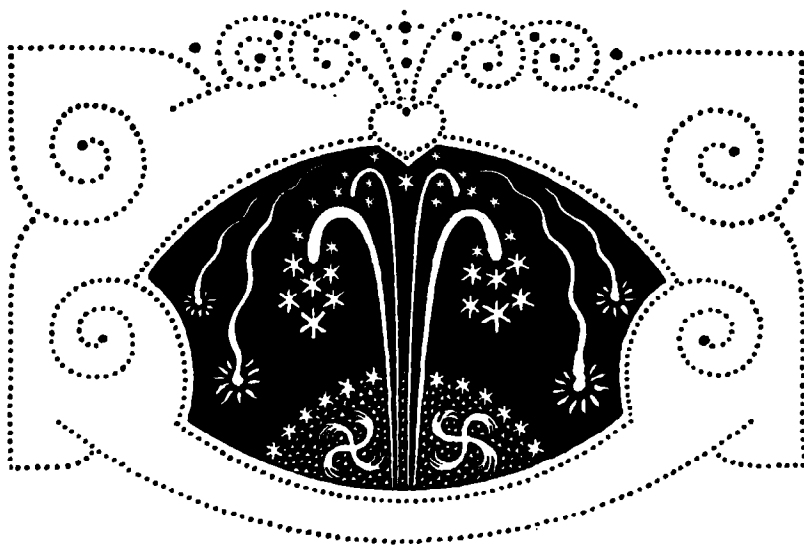

OFFICIAL FESTIVITIES.

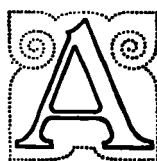

number of entertainments were given in connection with the Olympic Games of Stockholm, 1912.

On Saturday, 6 July, Their Majesties The King and Queen gave a Garden Party at Logården, the gardens of the Palace. Their Majesties also gave a dinner at the Palace on Tuesday, 16 July.

On Tuesday, 9 July and Thursday, 11 July, H. R. H. the Crown Prince gave a dinner at the Palace. On Thursday, 18 July, H. R. H. Prince Wilhelm gave a dinner at his palace at Djurgården, and on Saturday, 27 July, H. R. H. gave a Garden Party at the same place.

Festivities organized by the Swedish Olympic Committee.

On Thursday, 4 July, a reception lunch was given at Hasselbacken, to which were invited the members of the International Olympic Committee and the Swedish Olympic Committee, together with their ladies, to a total number of about 70 persons.

On Sunday, 7 July, the Swedish Olympic Committee gave its grand reception banquet at the Grand Hotel Royal. The feast was honoured by the presence of H. R. H. the Crown Prince, H. R. H. Prince Wilhelm and H. R. H. Prince Carl, all of whom graciously acted as hosts. Swedish and foreign honoratiorees and higher officials were invited, to a total of 396 persons.

Speeches were made, on proposing the healths of:

H. M. The King

by Colonel V. G. Balck;

The Heads of Foreign States

by H. Excellence, the Minister for Foreign Affairs;

The Guests

by H. R. H. the Crown Prince;

The Swedish Olympic Committee,

by Baron Pierre de Coubertin.

During the course of the banquet, there was a vocal performance by a double quartette of men's-voices, led by Herr Gentzel, Mus. D. At the close of the dinner, the guests were conducted to the Operaterassen Restaurant, which had been reserved for their accommodation, and the remainder of the evening was spent there, enlivened with instrumental music and song.

Speech made by Colonel V. G. Balck at the dinner given by the Swedish Olympic Committee at the Grand Hotel Royal, 7 July, 1912.

When Swedish men meet at a national banquet it is, quite naturally, our duty, and in accordance with a good old custom, to pay honour to our country's king.

This evening we are gathered at an international feast at which there are representatives of most civilized countries, and it is a pleasure, as well as a duty for us, to give expression on such an occasion to the feelings of devotion, reverence and fidelity to our king which animate us, and we feel assured that our guests from abroad will gladly unite with us in the voicing of these sentiments.

On such an occasion as this, when the leading men in the world of athletics are assembled here, we are filled with a most special desire to give King Gustaf our very heartiest thanks for all the care and support he has bestowed on athletics, for Swedes have the inestimable good fortune to see in His Majesty, not only a promoter and protector of all good sport, but also one of our foremost pioneers in several branches of athletics.

Speech made by His Excellence the Minister for Foreign Affairs, at the dinner given by the Swedish Olympic Committee at the Grand Hotel Royal, July 7, 1912.

C'est avec le plus grand plaisir que la Suède entière voit se réunir dans sa capitale tant de personnages distingués de toutes les nations, et je ne saurais mieux exprimer les sentiments qui nous animent pour nos hôtes et leurs patries qu'en levant très respectueusement mon verre en l'honneur de tous les Souverains et Chefs d'Etat si brillamment représentés ici non seulement par les représentants officiels qui honorent en grand nombre notre assemblée de leur précieuse présence mais aussi par la jeunesse de leurs pays, jeunesse si brave, enthousiaste et énergique.

Altesses Royales! Messieurs! Aussi respectueusement que sincèrement je bois à la santé de tous les Souverains et Chefs d'Etat ici représentés!

Speech made by H. R. H. the Crown Prince at the banquet given by the Swedish Olympic Committee at the Grand Hotel Royal, 7 July, 1912.

Gentlemen,

I rise to propose the health of all our distinguished guests present here this evening, and, on behalf of the Swedish Olympic Committee, have great pleasure in welcoming them to our capital.

The modern Olympic Games, instituted nearly 26 years ago by one of our illustrious guests, have, as we all know, developed into the greatest athletic event of our day. Nearly 30 nations, represented by a total of some 4,000 active competitors, are taking part in the present Games, and the Swedish organizers of this Olympiad are filled with justifiable pride that the peoples of the world have so magnificently responded to their invitation. Quite naturally, such an enormous number of competitors necessitates a vast and comprehensive organization, not only in this country, but in most other countries as well. It is, therefore, a great pleasure for us to be able to receive here as our guests so many of our colleagues from abroad, each of whom in his own place has promoted the interests of the Olympic Games, and also of games and sport in general.

We therefore welcome, first of all, the honoured members of the International Olympic Committee, to whom we are greatly indebted for having placed in our hands the organization of the Fifth Olympiad. We welcome the official representatives of many countries and corporations, as well as the Olympic Committees of the various nations taking part in the Games. It is also a source of great pleasure to us that so many foreign jurymen have come here to fulfil tasks which, very often, are of a difficult as well as delicate nature. Finally, on the part of the Swedish Olympic Committee, I beg to welcome all our other guests who, for one reason or another, have come here to witness the Olympic Games. We hope that you will all enjoy your stay in our country and that you will take back pleasant and favourable memories of the Fifth Olympiad and of the city where it was held.

(His Royal Highness then continued in Swedish):

The Swedish Olympic Committee is also very happy to receive here as its guests this evening so many of the Swedes who, as members of one or other of the various Committees, or in any other way, have laboured for the successful celebration of the Olympic Games of Stockholm, and we now beg to thank them most heartily for their kind co-operation.

I have the honour to propose the health of our guests from abroad, and I call on the Swedes here present to give a hearty cheer in their honour.

On Sunday, 14 July, the Swedish Olympic Committee gave a farewell entertainment at the Stadium, to which were invited the Swedish and foreign honorees, officials and active competitors, to a number of some 4,000 persons.

The guests were seated at tables arranged in rows in the arena. Non-intoxicating liquors were the only beverages served. A men's choir, 2,500 strong, gave a concert after the banquet, the festivities being concluded by a grand display of fireworks on the summits of the two towers.

Speeches were made by H. R. H., the Crown Prince, Baron de Coubertin and Colonel Balck.

The public were allowed to be present during the concert and firework display, on the payment of a small fee, and the Stadium was filled to the last seat.

Speech made by Baron Pierre de Coubertin, at the farewell entertainment of the Olympic Games, given at the Stadium on July 14, 1912.

Your Royal Highness, Gentlemen,

I am like a father who has many daughters. The moment he has succeeded in getting one of them married, he thinks of nothing else but of having the next one married too. The Olympiads are my daughters, and now that the Fifth Olympiad has been so successfully celebrated, I turn with heart and soul towards the Sixth Olympiad, which, as you know, Gentlemen, will be celebrated in Berlin in 1916. And, on behalf of the International Olympic Committee, I beg to say that we hope you will attend, whilst I feel sure that I can be allowed to add, on behalf of our German friends, that all of you, Gentlemen, will be very welcome there.

We shall never forget Sweden, the Royal Family, or the Swedish people. We leave with them a part of our hearts. When the bleak season of the year has come, my dear Swedish friends, and everything is dark and cold, remember that everywhere in the wide world, there are friends who are looking back to the glory of this Olympic summer, and who unite with you in grieving that it should ever depart.

I thank you once again, and call on you all for a cheer for Sweden. (*The latter half of this speech was made in Swedish and elicited loud cheers.*)

Entertainment given by Skansen for the competitors and officials.

On Tuesday, 9 July, all the Swedish and foreign honorees and officials, with their ladies, and all the active competitors, were invited by the Directors of the Open Air Museum of Skansen to visit this renowned spot, and afterwards to partake of some plain refreshments there. About 4,000 persons availed themselves of this invitation. In addition to instrumental and vocal music, several speeches were made; one in French, in honour of Sweden and the Fifth Olympiad, by Major General J. F. Lilliehöök; one in English, by His Excellence, H. Lagercrantz, formerly Swedish Minister at Washington; a third in German,

by Professor O. Montelius, State Antiquary, and a fourth, in Swedish, by H. Sohlman, Esq., Editor of the Aftonbladet.

Speech made by Major General J. Lilliehöök, to the French-speaking group of athletes, etc., at Skansen's Olympic Entertainment, 9 July, 1912.

Nobles citoyens et étrangers de distinction, amis des exercices physiques et des sports,

J'ai l'honneur de vous souhaiter la bienvenue de la part des Comités d'Organisation des Jeux Olympiques à cette fête à Skansen, et je puis l'affirmer sans conteste, de la part de tous les Suédois qui portent intérêt à la Vème Olympiade, c'est-à-dire de la très grande majorité de mes compatriotes.

Nous vous sommes cordialement reconnaissants d'avoir entrepris un long voyage et même traversé les mers pour venir prendre part à ces luttes olympiques, qui exigent une grande vigueur de corps et d'esprit, et pour remporter les prix disputés par tant de concurrents d'élite accourus de presque tous les pays du monde.

Nous souhaitons également la bienvenue aux nombreux voyageurs et touristes que les solennités de la Vème Olympiade ont attirés parmi nous et qui veulent mettre à profit cette occasion pour apprendre à mieux connaître notre pays, ce qui, nous osons l'espérer sans forfanterie, équivaldra à l'aimer davantage.

La Vème Olympiade est placée sous l'auguste patronage de Sa Majesté le Roi Gustave V, la présidence d'honneur est confiée au Prince Royal, et le Colonel Victor Balck, qui a servi dans le régiment que je commandais jadis — pardonnez ce souvenir personnel — préside le Comité d'Organisation.

Le Stade est l'œuvre d'un architecte suédois, M. T. Grut, et le désir ardent de montrer au monde ce que nous pouvons faire dans le Nord, nous a fourni les moyens d'ériger ce monument grandiose, où la majeure partie des concours a lieu.

Le sol que nous foulons ici aux pieds, Messieurs, est, je puis le dire, un sol sacré. En effet, Skansen est une Suède en miniature avec sa faune et sa flore; nos diverses provinces ont fourni ici les habitations rustiques telles qu'elles étaient dans le passé, avec les meubles et les ustensiles en usage alors, ce qui permet de se faire une idée de la vie populaire dans des temps qui sont déjà loin de nous.

Au milieu de ce parc national, vous voyez aussi des huttes de Lapons, les cabanes que se font les charbonniers au fond de nos immenses forêts, une maisonnette de pierre qui reçoit sa lumière par le toit, des campaniles en bois dont les cloches sonnent en l'honneur des gloires de la patrie, et cent autres choses caractéristiques de notre pays.

Ici, vous verrez exécuter en costumes nationaux les danses anciennes du pays, défiler des cortèges historiques tels qu'ils étaient en usage aux époques importantes de notre glorieux passé, et tout cela, non par esprit d'orgueil ou de vanité, mais en vue de fortifier le sentiment national et d'élever les cœurs en haut, au-dessus des questions mesquines du jour.

Cet ensemble forme un musée national en plein air, que nous estimons à une haute valeur et qui est bien fait pour captiver l'attention de l'étranger. C'est avec le Musée du Nord l'œuvre géniale d'un ardent patriote, le Docteur Artur Hazelius, trop tôt enlevé à la science pour voir son rêve réalisé.

Nous sommes heureux et fiers à la fois de vous recevoir ici, Messieurs et chers hôtes. Vous appartenez à des nations bien diverses, sans doute, mais toutes

elles ont plus ou moins contribué — chacune à son heure et dans son domaine particulier — à répandre, par des voies pacifiques ou le glaive à la main, les bienfaits de la civilisation sur tous les points de notre globe, et cela parfois au prix de privations et de sacrifices sans nombre. Par là ces nations ont affranchi les peuples de la tyrannie pour faire régner sur la terre la justice et la paix.

Mais pour atteindre ce but, il faut des hommes aux bras d'acier et au cœur d'or, et c'est justement les sports et les divers exercices corporels bien réglés qui doivent nous aider à remplir notre mission.

Au moment du péril — croyez-en ma vieille expérience sur les champs de bataille — nos facultés sont soumises à une rude épreuve, et celui-là seul qui sait conserver son calme, son sang-froid, sa présence d'esprit et garder la maîtrise de son propre corps, est capable de faire ce que la patrie attend de lui.

Tous ceux qu'anime un pareil esprit sont des pionniers qui frayent la voie où notre génération doit marcher de l'avant. Et, pour terminer, vous voudrez bien permettre au vieillard qui a l'honneur de vous parler — pour la première et probablement pour la dernière fois — de formuler le vœu que chacun de vous soit un de ces vaillants pionniers, et, dans cet espoir, je souhaite que la joie et le succès vous accompagnent, et que le Très-Haut vous garde tous sous sa paternelle protection!

*Resumé of the speech made by His
Excellence, H. L. F. Lagercrantz, formerly
Swedish Minister at Washington, to the
English-speaking athletes, at the Olympic
Festival at Skansen, 9 July, 1912.*

Ladies and Gentlemen,

It is my pleasant duty to wish you, our English-speaking guests, a most hearty welcome, and a more suitable spot could not have been chosen for that purpose than this memorial-place of the culture of times past, of times that bred hardy men and women; for, in those days, the very struggle for existence and for liberty was severe enough to steel both the will and the arm of all.

We Swedes look upon you as our distant kinsmen. Some of you, if not all, have Swedish blood in your veins; some of you are the descendants of our Vikings, of men who paid not always the most friendly of visits to England's coast; were charmed by your beautiful land; married your country's daughters and so became your forefathers. Some of you from the great Republic of the west, are our brothers and sisters, our uncles and aunts — poor, indeed, is the Swede that has not a rich uncle in America! — some of you may even remember the time when you yourselves were lulled to sleep by the rippling murmur of our streams, by winds that went whispering through Swedish forests. Do we not know, old friends, how strong the ties are that knit us all together!

Yes, hard were the conditions under which our forefathers lived; when they held with one hand the plough that furrowed their fields and, with the other, the sword that defended them; when these cottages we see around us were their only comfort, and bark was often mingled with the bread they ate. We can understand that such a life must have brought forth hardy men, hardy heroes.

The higher culture of which we are so proud, is all too easily accompanied by effeminacy and moral decadence; but you, leaders in the realm of athletics, have, consciously or unconsciously, become a power that counteracts these treacherous

dangers which in the form of epicurism, love of pleasure and desire of gain, are ever lying in wait to destroy us.

May the noble spirit of emulation that the Olympic Games is endeavouring to introduce into our athletic grounds and our gymnasiums, spread upwards and downwards, and I beg, on this occasion, to acknowledge, and with admiration, that this spirit of emulation, which has awakened millions of youth from anæmic effeminacy to a life filled with health and gladness, originated with you. And one result of this has been that your language has spread the whole world round.

Just as Ling's serious, methodic system of gymnastics has Sweden for its native country, so has athletics been cradled by an English hearth. Fortunate it is that, nowadays, the nations meet oftener in emulous but friendly strife for Olympic laurels, than with bloody sword for earthly power.

The motto that our Crown Prince gave the Fifth Olympiad, is, my friends, a great and, for all of us, a vivifying truth — not for this part of human life alone: "May the best win!"

God bless you all!

Resumé of the speech made by Professor O. Montelius, to the German-speaking athletes at Skansen's Olympic Entertainment, 9 July, 1912.

At the farther end of Skansen, the German-speaking group of athletes were welcomed by Professor Montelius, who began his speech by saying a few words about Skansen and its genial creator, Artur Hazelius. Skansen's task was to show how Swedes in olden times had lived "the simple life" in lowly, yet pleasant dwellings. As late as the middle of the nineteenth century, said the speaker, the peasants in certain parts of Västergötland seldom saw rye-bread even. Such a life produced a sturdy race, and it was from such homes that the ancient Vikings had come, and, at a later day, the warriors who fought beneath Gustavus Adolphus and Charles XII. The word "sport" did not exist at that time in Sweden, but, in any case, our forefathers showed that the thing itself was not unknown to them. From these homes, however, there issued, not only soldiers, but also Swedish men and women who had won a name in intellectual and cultural spheres. The speaker would mention only *one* name, that of Carolus Linnæus, who was born and received his first rudiments of instruction at a poor parsonage. The historical collections at Skansen and the Northern Museum pointed to a very ancient culture. If a nation possessed culture, ancient, yet vigorous, it would find there the best security for its independence.

Professor Montelius thanked the guests for the confidence that had been reposed in Sweden by allowing her to organize the Olympic Games, and concluded his speech, which was received with loud applause, by calling for a four-fold Swedish cheer for the Olympic Games.

Speech made by Harald Sohlman, Editor of the Aftonbladet, to the group of Scandinavian athletes, at Skansen's Olympic Entertainment, 9 July, 1912.

Northern Athletes, both Men and Women,

Athletic life and out-of-door life; athletic festivals and out-of-door festivals, are two things that must necessarily accompany each other. This is not the least of

the reasons that has impelled the Swedish hosts at this International Entertainment for Athletes, to ask for, and hospitably receive, permission to make just this place the scene of the festival, for there can be nothing nearer to an athlete's, or a rifleman's spirit, than a landscape, breathing of liberty, such as the one that surrounds us here.

It is a Swedish landscape that here meets our gaze; it is the most distinctively Swedish place that can be found in this part of our country and, what is more, it is not only a piece of Swedish scenery, but also a fragment of Swedish culture — living scenery; primeval culture. This is a place of which, and where, one can most rightly quote the ancient thought:

“Listen to that fir-tree's whisper,
At whose foot thy dwelling's rooted.”

With joy, and not without a certain pride, we have thought that to this place, we should lead you, too, our Northern kinsmen, whose native-lands and whose culture has so much in common with ours, although each possesses its own distinctive features.

Dr. Artur Hazelius, the creator of this Open Air Museum, intended to give new life to the past, that it might serve as a reminder and an impulse to this and coming generations. Folk-dances and melodies; folk-games and ancient Swedish humour — all live again on the dancing-platforms and in the cottages, on the paths and in the meadows of Skansen.

This is a place that, we believe, ought to appeal to an athlete, both to his thoughts and his feelings; both to his soul and his heart, by the impressions which an unconfined landscape and ancient culture in union, ought to make on a healthy and receptive mind.

Athletic sports are of ancient date in the life of the Scandinavian nations. In Northern mythology, what prominence is not given to the story of Thor's driving his pair of he-goats, to say nothing of the hammer-throwing of the gigantic charioteer — he who has just passed above us and cleansed the air with his lightning-bolts — or of his mighty bow and spear.

And athletics has been a custom of our peoples, and has been cherished by them, from the earliest childhood of each nation until the present day. Athletics has presented both serious and humorous forms, from the combats of “belt-wrestlers” and the rivalry of knightly tournaments, down to “knocking the cat out of the barrel” and climbing the greasy pole, but it has always been warmly cherished and, sometimes, has found expression in forms which, in strength and agility, if not in grandeur, could well compare with the displays of the classic Olympic Games.

When, then, at the present moment, all the athletes of the world have met in friendly competition in the capital of the ancient land of Sweden, we regard it as a recognition of what has been done during the course of many ages, and of what is still being done at the present day, in the sphere of athletics.

Our country has experienced varying fortunes, not only in the field of athletics, but in other respects too.

To-day, on the 9 of July, about two hundred years ago, the glorious sun of our temporal power set for ever in a sea of blood, in a battle widely renowned in history. But over our land another sun has since risen — the sun of peace and labour, of mental and material labour. While still honouring our nation and its flag above everything else in the world, we see that in peace, justice, co-operation

and fraternization lies the way to our goal — the prosperous, happy future of Sweden and of other nations, not least that of the kindred Scandinavian peoples.

It is in the arena of peaceful rivalry that we now strive for our victories — or suffer defeat. It is such a festival of peaceful competition and international fraternization of which, just now, the capital of Sweden has the honour to be the centre and thus has fastened on it the gaze of the whole world. It is a very great pleasure for us to meet personally, individually, here, in this beautiful place so close to our city, comrades from various nations now competing in friendly rivalry. And in the warm hope, the inspiring belief, that this branch, too, of the many efforts made nowadays to promote international aims and connections, may contribute to universal fraternization, to bring about the co-operation of separate, differing forces for good and useful ends — let us unite in giving a cheer for that sign under which we are now gathered, and which is called the Fifth Olympiad.

Festivities arranged by the Special Committees.

In addition to the entertainments already mentioned, special festivities were arranged by the Committees for cycling, fencing, football, horse-riding, rowing, swimming, and yacht racing.

On Friday, 28 June, the Football Committee had a grand reception at the Strand Hotel for all those taking part in the Olympic Football Competitions, and on Sunday, June 30, the same Committee gave a dinner for the honoratiorees.

On Friday, 5 July, the Shooting Committee gave a farewell feast at Hasselbacken, and on the same day the Cycling Committee gave a grand reception at the Grand Hotel Royal for the honoratiorees and officials.

On Monday, 8 July, the Cycling Committee gave a farewell entertainment at Hasselbacken for the honoratiorees, competitors and officials in the Cycling Race round Lake Mälär.

On Thursday, 11 July, the Fencing Committee gave a dinner at Hasselbacken.

On Saturday, 13 July, the Horse Riding Committee had its reception banquet at Hasselbacken.

On Sunday, 14 July, a dinner was given at Hasselbacken in honour of the competitors in the Modern Pentathlon.

On Tuesday, 16 July, the Swimming Committee arranged a steamboat excursion out to Sandhamn, the guests being the officials and competitors in the Olympic Swimming Events. Lunch was taken during the return trip.

On Wednesday, 17 July, the Rowing Committee gave a reception feast at Hasselbacken.

On Friday, 19 July, the Rowing Committee gave its farewell entertainment.

On Friday, 19 July, the Royal Swedish Yacht Club had a grand reception at the Hotel at Nynäs. A speech was made on the occasion by H. R. H. Prince Wilhelm.

*Speech made by H. R. H. Prince Wilhelm
at the Reception Banquet given by the Royal
Swedish Yacht Club at Nynäs, 19 July, 1912.*

From far and near there have assembled in this spot to-day, interested and sport-loving yachtsmen who have come to take part in Swedish waters in the great struggle over the Olympic course, or in the competition for first place in the International Yacht Racing. In the name of the Royal Swedish Yacht Club, I bid you all, both yachtsmen and our other guests, a most hearty and sincere welcome. We thank you for your response to our invitation in coming to us from far-off seas, and you may rest assured that the good wishes now offered, are of the real, old-fashioned Swedish sort.

It is, too, my lively hope that, during the next few days, new bonds of friendship may be knitted between the representatives of the various countries, and that this may lead to mutual confidence and good-understanding, and contribute to elevate and improve yachting. We all love the sea. Everyone here, has, at one time or other, experienced the delight derived from a lively sail over the blue, foaming waters, or that feeling of pride and daring which irresistibly comes over us when, breakers boiling on all sides, the hand firmly grasps the tiller and the sailor looks death and danger in the face without blenching. It is this feeling, this love of the sea, that binds us all together. On the sea a *Man* is needed, and we know that when ever we meet a good yachtsman, we meet, too, a real man.

Finally, I beg you to be assured that everything will be done to make your stay here as pleasant a one as possible, and that if, in addition to a prize which may possibly become yours, you carry away some sunny and pleasant memories of the Swedish skerries, it will be our best and dearest recompense.

Mesdames et Messieurs!

Telle que la Métropole hellénique voyait arriver, de rivages lointains, pour les Olympiades de jadis ses parents de langue et de race; telle la Société royale nautique de Suède souhaite ici la bienvenue la plus cordiale et la plus sincère à ses hôtes olympiques et internationaux. L'unité de langue et de race semblerait aujourd'hui perdue. Mais en est-il bien ainsi, Messieurs? Aimer, c'est comprendre, et n'y a-t-il pas une langue que nous aimons tous, celle des grands vents libres, la voix puissante de l'Océan? Malgré la différente latitude des pays où furent nos berceaux, nous autres marins et yachtsmen n'avons-nous pas tous, en outre, une patrie commune, l'onde salée et la crête écumante?

Au nom de la Société royale nautique de Suède, je vous souhaite la bienvenue aux rives de la Baltique, au milieu d'un peuple qui, de tout temps, a aimé la mer et les voiles. C'est notre vif désir que vous vous trouviez ici en plein pays d'amitié, que vous sentiez qu'ici on essaiera de ne perdre aucune occasion pour rendre votre séjour agréable et de bon souvenir.

J'exprime les vœux que les concours de voile qui vont se réaliser contribueront à développer ce sport antique et noble qui est cher à nous tous, et -- qu'ici se formeront entre les yachtsmen de cordiales relations qui tendront à accentuer la fraternité de tous les véritables sportsmen. Jamais encore une main peureuse ne tint avec succès le gouvernail, là, c'est l'oeil certain, la main intrépide, le cœur vaillant qui réussissent. Et les cœurs vaillants partout où ils se rencontrent, ne se reconnaissent-ils pas, ne sont-ils pas frères?

Messieurs nos hôtes, soyez chaleureusement les bienvenus!

On Saturday, 26 July, the Royal Swedish Yacht Club gave its farewell banquet at Hasselbacken. During the course of the dinner, H. R. H. Prince Wilhelm, who presided, proposed the health of H. M. The King. His Royal Highness also drank to the health of the Heads of the foreign nations represented at the Games. The health of the guests was proposed by Captain O. Holtermann, who spoke in French, German and Swedish, as follows:

*Speech made by Captain O. Holtermann,
at the Farewell Banquet given by the Royal
Swedish Yacht Cl&b, at Hasselbacken, 26
July, 1912.*

YOUR ROYAL HIGHNESSES.

Ladies and Gentlemen.

The Olympic and International Regattas of 1912 are now ended, and the Royal Swedish Yachting Club begs to offer its warmest thanks to those who came to Sweden to take part in these events. For many of you the journey was both long and difficult, and for many, too, it was a matter of great difficulty to bring the yachts here. But there is a Swedish proverb that says "the way to a friend's house is not long." I can assure you that you have found real friends here and so we hope that friendship, our beautiful capital and the cruise through our archipelago will attract you here many times.

If I do not make a mistake, this is the first time that the Royal Swedish Yacht Club has had the pleasure of seeing the beautiful tricolor of France waving above a yacht taking part in our regattas. We are enchanted to have had the opportunity of seeing this lovely, well-rigged French boat, and we are full of admiration for the manner in which it has been handled. We beg to congratulate our French guests most heartily on their success in winning the Olympic Gold Medal at the regatta, and on the many other prizes they have succeeded in gaining.

I also wish to express the pleasure the Club feels at seeing amongst its French guests here this evening Baron de Coubertin, the president of the International Olympic Committee.

From Germany there came only one yacht, "one — but a lion". We are very glad to have had the opportunity of admiring the beautiful "Sophie-Elisabeth" when it was sailed by its skilful and cheery steerman.

We have had, too, the honour of welcoming many friends of yachting from the other side of the Baltic, from St Petersburg, Riga and Reval. Last year, at Helsingfors, we had the pleasure of becoming most pleasantly acquainted with many of you, and we are very grateful to the Finns that they gave us the opportunity of meeting you then. We are sincerely pleased that you have come here in such numbers, and hope to see you here very often in the future.

The memory of many a hard fight for glorious prizes, of fraternization and the formation of life-long friendships, all unite us to the Finns. We cannot thank them enough for the hearty and magnificent reception they gave us last year, and that they have repaid our visit by a most excellent attendance at our Regattas. It was a stately sight, and one not soon to be forgotten, when Commodore Krogius sailed into Nynäshamn at the head of a squadron of 30 boats.

Of course, it would be a most desirable thing if the various yacht clubs of the Baltic could agree on a uniform type of boat, but, until that takes place, we have,

by means of our rules as to "comparison-race prizes", found a way of arranging races between boats constructed according to our various rules, which will most certainly be of advantage to the sport that is so dear to all of us — yachting.

From Denmark we have the pleasure of seeing a most distinguished and celebrated yachtsman, who sailed his boat most brilliantly.

Although Norway is our nearest neighbour, it is a very distant one as far as yachting is concerned, for sea-communications between Christiania and Stockholm are very long ones, for sailing yachts, that is to say. We thank you with all our hearts, gentlemen from Norway, for having come here with three such charming boats, and for venturing to expose them to the difficulties attendant on railway-transport. We congratulate you most heartily on having won 2 of the 4 Olympic Gold Medals, and your success is the greater that your yachts have been designed by a Norwegian and built in Norwegian dockyards. We shall be most happy to meet you here again in noble rivalry on the blue Baltic.

Last of all, we give our warmest thanks to the home Clubs that were so kind as to accept our invitation to the Regattas.

Amongst our guests we have the great pleasure to see many persons who, during the last few years, have contributed to the development and improvement of our Club, by means of highly appreciated work or generous gifts. We are exceedingly glad to see so many of the honorary members of the Royal Swedish Yacht Club among our guests to-day, and we thank them sincerely for the interest they continue to take in the Club and its aims.

I beg to drink the health of the guests of the Royal Swedish Yacht Club.

Admiral Hägg proposed the health of the Hon. President, H. R. H. Prince Wilhelm; of the Club Committee, and of the Sub-Committees which had the chief credit of the success that had attended the Regatta.

Baron Pierre de Coubertin responded on behalf of the foreign guests, and thanked Prince and Princess Wilhelm, and the Royal Swedish Yacht Club for their hospitable and hearty reception.

Baron de Coubertin also proposed the health of the Swedes, and spoke as follows:

Altesses Royales,

Mesdames, Messieurs,

i/heure a sonné où vont se clore ces fêtes magnifiques qui marqueront si profondément dans l'histoire olympique. Encore quelques instants et la célébration de la Vème Olympiade aura pris fin.

Elle nous laisse un souvenir ensoleillé, non pas seulement parce que la terre et l'eau suédoises se sont parées pour nous de tous les enchantements d'un été radieux" mais parce que l'art du spectacle et le souci de la perfection technique ont été combinés par vous, Messieurs les membres du Comité Suédois, de la façon la plus ingénieuse et la plus réussie.

Pour faire une Olympiade, la puissance et l'argent sont bien loin de suffire, il faut de la persévérance, de la patience et de la tolérance. Il faut surtout une conception haute et sereine du double rôle auquel le sport peut et doit aspirer au sein des grandes démocraties modernes- rôle d'équilibreur humain hérité de l'athlétisme antique, rôle d'éducateur social, hérité de la Chevalerie. Ce n'est pas seulement

vers le gymnase d'Olympie que nous devons tourner nos regards, Messieurs, mais aussi vers ces tournois du moyen-âge trop oubliés ou trop méconnus, dont le seul tort fut de pousser parfois jusqu'au delà du raisonnable le culte élégant de l'honneur, du stoïcisme et de la générosité.

Je ne puis rendre de plus grand hommage à la nation suédoise, Monseigneur, que de dire à ceux qui la représentent ici que maintes fois dans l'histoire, on l'a vue avec admiration s'inspirer de ce double idéal.

Et maintenant. Messieurs, voici qu'un grand peuple a, par notre entremise, reçu de vos mains le flambeau des Olympiades et s'est engagé par là à en préserver, et, si possible, à en aviver la flamme précieuse.

Une coutume s'est établie que la dernière parole dite au soir des Jeux Olympiques fut pour saluer l'aurore des Jeux suivants. C'est pourquoi je vais vous proposer au nom du Comité International Olympique, gardien suprême et stable de l'institution renouée, de lever nos verres en l'honneur de la VIème Olympiade.

Puisse-t-elle contribuer comme ses illustres devancières au bien général, au perfectionnement de l'humanité! Puisse-t-elle se préparer dans le labeur fécond des périodes pacifiques! Puisse-t-elle, le jour venu, être célébrée par tous les peuples de l'univers dans l'allégresse et la concorde!

Admiral Palander thanked the Royal Swedish Yacht Club for all the hospitality experienced by the Swedish guests, and concluded by calling for a cheer for the Club, and wishing it a prosperous future.

Other Festivities and Receptions.

Among other festivities and receptions may be mentioned the following:

The Reception given on Monday, 8 July, by His Excellence, the Minister for Foreign Affairs, at the Foreign Minister's Hotel.

The 5 o'clock tea, on Friday, 12 July, given by Baron Pierre de Coubertin, President of the International Olympic Committee.

The dinner given on Friday, 5 July, by Colonel V. G. Balck, for the members of the International Olympic Committee.

Colonel V. G. Balck's reception, Wednesday, 10 July.

The banquet given on 10 July, at Saltsjöbaden, by the Publicistklubben (Association of Swedish Journalists) for the representatives of the Foreign Press.

The dinner given on Saturday, 20 July, by the President of the Royal Swedish Yacht Club, Captain O. Holtermann, and Mrs. Holtermann, for the Club Committee and the foreign competitors in the Yacht Racing, and their ladies, to a total of 120 persons. Among those present may be mentioned, the Duke and Duchess of Södermanland (Prince and Princess Wilhelm), the Grand Duke and Duchess Kyrrill, the Duke and Duchess of Somerset, etc.

The Farewell Festivities arranged at Saltsjöbaden, on Friday, 17 July, by the officers of the Garrison of Stockholm, for those taking part in the Horse Riding Competitions.

The Subscription Ball at Hasselbacken, on Saturday, 18 July, arranged by the Stockholm Field Riding Club.

The dinner, given on Wednesday, 3 July, by Colonel Robert M. Thompson, the President of the U. S. A. Olympic Committee, on board his yacht Catania, for the members of the International Olympic Committee and the Presidents of the National Olympic Committees.

The reception given on Thursday, 4 July, by the U. S. A. contingent, on board the steamer Finland, in honour of the officials and competitors in the Games.

The dinner given at Hasselbacken on Monday, 8 July, for the Delegates to the Congress of the International Swimming Federation.

The dinner given at Hasselbacken on Wednesday, 17 July, by the Swedish Athletic Association in honour of the Delegates to the Congress for the formation of an International Amateur Athletic Federation.

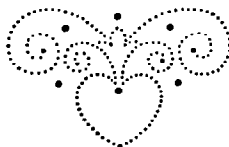

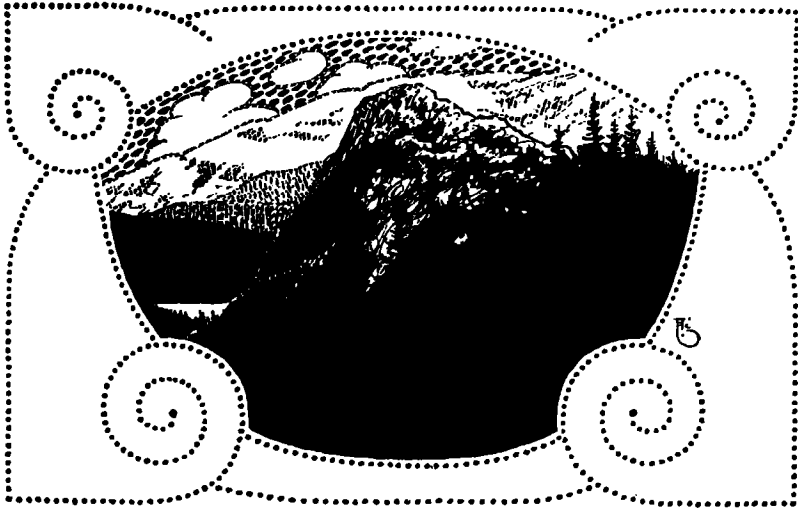

THE PROPOSED PRIZE FOR MOUNTAIN ASCENTS.

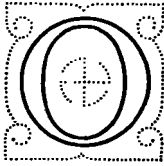

One part of the programme for The Fifth Olympiad was, that an Olympic gold medal should be awarded for "the finest performance in mountain ascents during the years 1908—1911".

Consequently, in September 1911, the Swedish Olympic Committee issued a circular to the various Alpine clubs and organisations in, as well as outside, Europe — not even far-off China being forgotten — asking them to propose candidates for the prize, and in January 1912, Mr. Erik Ullén was entrusted with the task of examining, and reporting on, the answers and entries received.

Even before accepting this mandate, Mr. Ullén had expressed the strongest doubts as to the possibility, as well as the desirability, of awarding such a prize — an opinion fully shared by the prominent foreign mountain-climbers with whom he had had an opportunity of discussing the matter — and the answers received only confirmed and strengthened this opinion. As was to be expected, nearly all the leading clubs had declared against awarding the prize, while those candidates that could at all be thought of in a competition of this kind, based their claims, as a rule, more on a series of more or less meritorious ascents than, as was intended, on a really "Olympic" mountaineering feat.

On May 31 Mr. Ullén sent in the following memorandum:

To

The Swedish Olympic Committee for the Olympic Games of Stockholm, 1912.

Gentlemen,

In accordance with the mandate received by the Committee for Mountain Ascents, the said Committee now begs to state:

that, in the opinion of the Committee, none of the ascents which have been proposed for the prize, and the merits of which could, according to the stipulations of the competition, be taken into consideration, is of that exceptional importance which one has the right, as well as the duty, to demand for the award of an Olympic Gold Medal;

that the Committee is strongly of the opinion that there exists no satisfactory common basis for a comparison between different ascents, and that, consequently, a just award is impossible.

The reasons on which the Committee bases this opinion are:

1. The frequent use of paid, professional guides in mountaineering, which makes it inevitable that the jury will run the risk of rewarding amateurs for what, in reality, is due to professionals, while it also makes it impossible to compare ascents carried out with, and without, assistance received from such guides.
2. The impossibility of comparing ascents of different character, such as, for instance, a Dolomite rock-climb, a snow- and ice-climb in the Oberland, and an ascent in the Himalayas.
3. The impossibility of judging the conditions of weather and snow existing at the time of the ascent, factors which are of vital importance on every occasion.
4. The impossibility of correctly estimating the degree of safety with which an ascent has been made, it being evident that the sporting value of a climb must be considered very much diminished if the climber has exposed himself to dangers that could have been lessened, or altogether avoided, by better judgment and greater skill.
5. The fact that the jury's chief knowledge of an ascent must be obtained from the account given by the climber, i. e. the competitor himself.

On these grounds the Committee begs to propose:

that the Olympic Gold Medal for "the finest performance in mountain ascents during the years 1908—1911" *shall not be awarded*, and

that the Swedish Olympic Committee should propose that, for the future, this competition shall not form part of the programme of the Olympic Games.

For THE COMMITTEE FOR MOUNTAIN ASCENTS

Erik Ullén.

On July 2 the Swedish Olympic Committee decided *that the prize for mountain ascents should not be awarded.*

It is, for obvious reasons, only the *possibility* of awarding the prize that is discussed in this memorandum, but it is evident that the awarding of such a prize, even if it were possible, would be anything but desirable. The hope of accomplishing an ascent that has been considered impossible, is a strong temptation for the young and ambitious mountaineer to expose himself to unwarrantable risks, and a good many fatal accidents can, undoubtedly be ascribed to this cause. How much stronger would not the temptation be to overstep the limits between the justifiable and the unjustifiable, if there also existed the possibility of gaining an Olympic medal, with the glory it entails both for the winner and for his country? There is no doubt but that an Olympic mountaineering prize would lead to the loss of many human lives.

There is still another side of the question that must not be overlooked.

The mountaineer makes his ascents in places far from public observation, and, as a rule, his feats are known only to a small circle of people with similar interests.

As a matter of fact, this has put its stamp on climbing as a sport, and on alpine literature. When the mountaineer describes his ascents in the journal of his club, he does so with an accuracy, and a care and moderation in the choice of expressions, that contrast sharply with the exaggerations, self-assertion, and big words, that so often characterize his false imitator when the latter tries to draw attention to his person in the daily or weekly papers. Were mountaineering feats to be rewarded with Olympic medals, it is greatly to be feared that some candidates, in order to make an impression on the minds of the jurors, and to add to their chances of obtaining the coveted prize, would be tempted to forget this honourable tradition. Indications of this have not been wanting in the list of merits sent to the Committee for Mountain Ascents.

The inevitable result of awarding such a prize as the one in question would be, that the standard of mountaineering as a sport would decline.

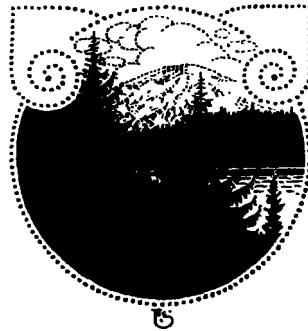

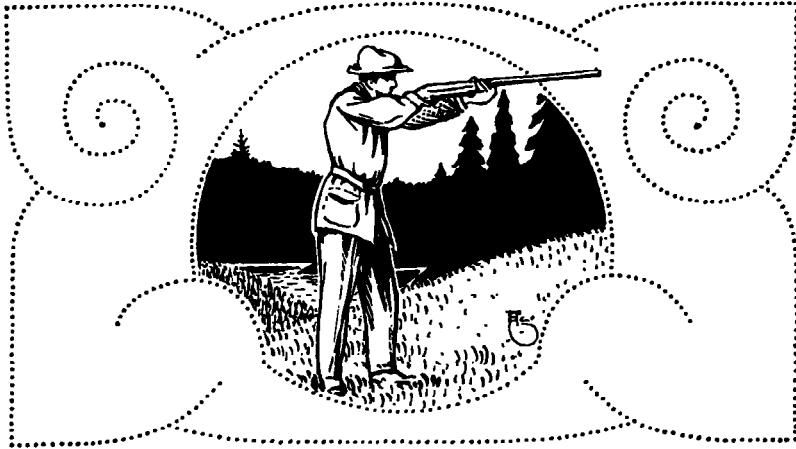

REPORT ISSUED BY THE JURY FOR AWARDING THE OLYMPIC PRIZE FOR GAME SHOOTING.

In consequence of a request made by Baron Pierre de Coubertin, the Swedish Olympic Committee for the Olympic Games of Stockholm, 1912, determined to give an Olympic gold medal for the best Game Shooting feat during the period 1908—1911. This determination, however, was come to only after much hesitation, for the difficulties were clearly seen that lay in the way of giving proper effect to the resolution. Not wishing to reject the proposal, it was thought preferable to investigate the practicability of the idea, both for this occasion and for future Olympic meetings. This resolution, however, introduced quite a new feature into the Olympic Games. In the Games already held, the competitors themselves had been present and, by their feats in the arena, had shown that they were worthier of Olympic laurels than their rivals. Performances elsewhere had no validity for the judges at the Games. But in this particular branch of sport, on the other hand, there would be brought before the judges, feats performed anywhere during the period fixed. Under these circumstances, the competition for the Olympic game shooting prize would depend essentially on the entries, and it was very uncertain, of course, if the most deserving candidate would be entered, for, in spite of all public notification of the matter, a great part of the human race, especially in other parts of the world, would remain ignorant of the prize to be awarded. Another point that rendered it a matter of infinite difficulty for the judges to award the medal justly would be the fact that, in this case, the judges would have no opportunity of

gaining any direct and personal knowledge of the feat in question, but would be obliged to rely entirely on the statements and ideas of those making the entry, and these again would, perhaps, not be based on personal knowledge of the facts. Still, the Swedish Olympic Committee resolved to refer the matter to the further investigation of the judges. The following were chosen as judges and members of the jury in question: *President*; Count Claes Lewenhaupt, Lord of the Bedchamber, Fr. Björkenstam, Esq., Master of the Hounds, E. von Eckermann, Esq., Master of the Hounds, Professor Einar Lönnberg, Professor A. G. Nathorst.

In order to obtain a more precise definition of the phrase "the best game shooting feat", many expressions of opinion were asked for, and the definition given by the proposer of the award, Baron de Coubertin himself, viz., "— — — — qualities of manliness and courage and energy — — — — displayed on one or several occasions", is probably the most satisfactory one. For it cannot be the intention of the proposer or any one else, to reward the shooting of a great number of head of game, as, irrespective of other points of view which need not be discussed here, this signifies chiefly a plentiful supply of game and skill in shooting, and the last factor is a thing that is submitted to the decision of judges during the course of several different competitions in the ordinary Olympic Games. Neither can there be a question of awarding a medal such as the one in question for a feat, for which the sportsman has good-luck to thank, more than anything else, and yet there were entries that could best be referred to such a category.

After having carefully deliberated on what had been laid before them in the matter, the jury determined to make the following report:

"We, the undersigned, who have been commissioned to act as judges for the award of the Olympic Gold Medal for the best game shooting feat during the period 1908—1911, beg herewith to state as follows:

Under any circumstance, it would be difficult to give a just and definite decision in such a matter as this, as we should then proclaim that a certain person had, in such a wide sphere as the one in question, surpassed all his contemporaries in "qualities of manliness and courage and energy — — — — displayed on one or several occasions", as Baron Pierre de Coubertin, in the opinion of the judges, correctly defines the demands that should be made of the recipient of this medal.

As we, the judges, from the documents which have been placed before us in the matter, have not been able to come to the conclusion that any of the few candidates who have been proposed can be considered as having fulfilled such great claims in a higher degree than all other persons, we find ourselves obliged to propose that the medal in question shall not be awarded on this occasion.

Stockholm, 15 June, 1912.

CLAES LEWENHAUPT.

FREDRIK BJÖRKENSTAM.

E. v. ECKERMANN.

EINAR LÖNNBERG.

A. G. NATHORST.

In consequence of this report, the question of an Olympic Medal for Game Shooting was decided negatively for this occasion, and this

most certainly in agreement with the opinion of the-majority of those that had gone the most carefully into this delicate matter, and who entertained every desire to consider game shooting as sport. Even before any decision had been come to in the one direction or the other, articles appeared in leading sporting journals, hinting that the award of the prize in question would not be in agreement with the sporting ideal of game shooting. Another proof that such an opinion was very generally held is the fact, that no entries at all were made by nations that, otherwise, could, most certainly, have sent in the names of very prominent candidates. Under these circumstances, and as it is as good as impossible to choose, at a certain period, the most deserving candidate, and as the award of such a prize seems to clash with the character of the other Olympic competitions, it would probably be most suitable and fortunate if, for the future, there should arise no question of giving an Olympic medal for game shooting.



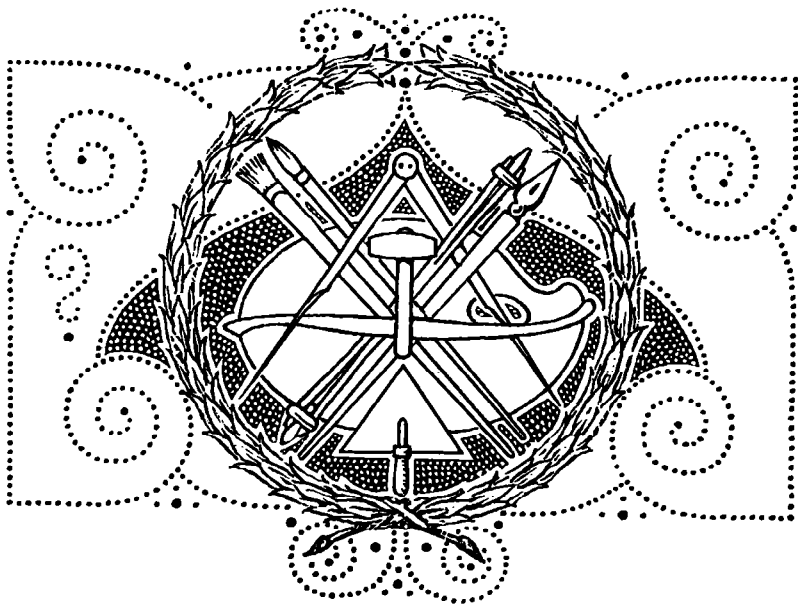

CONCOURS D'ART.

It was, of course, quite natural, that, when the Olympic Games were revived in our days, a wish should be strongly expressed to also include the thought entertained by the ancients, and unite intellectual feats to the physical displays at Olympic Competitions.

In connection with this idea, Baron Pierre de Coubertin, President of the International Olympic Committee has been a very ardent champion for the establishment of art competitions in connection with the modern Olympic Games and, on his initiative, it was determined by the International Olympic Committee as early as 1906 that, from the year 1908, the Olympiads recurring regularly each fourth year, should also include a "Concours d'Art". The short time at the disposal of the organizers of the Olympic Games of London, 1908, did not permit of the execution of this design, so that nothing came of the matter at the Fourth Olympiad. The question was discussed again, however, after the London Games, and, at the Meetings of the International Olympic Committee at Berlin, 1909, and at Luxemburg, 1910, the decided opinion was expressed that, in connection with the Olympic Games of 1912, an announcement should be made of an art competition in architecture, sculpture, painting, music, and literature, to embrace works directly inspired by athletic sports.

In consequence of this definite demand for an art competition in connection with the Fifth Olympiad, the Swedish Olympic Committee applied to the Swedish Art Institutions and Associations, asking their

opinion in the matter. These artistic circles advised great caution, however, in respect to the organizing of such a competition.

The Royal Academy gave it as its decided opinion that, if an art-competition was arranged, with the limitations fixed by the International Olympic Committee, it could hardly embrace anything but architecture, while, on the other hand, works of sculpture and painting would, in such a competition, be considered principally in the light of illustrations, calculated to glorify athletic life, and therefore presupposing in the artist, in the first place, a knowledge of the technics of athletics. The works in question, consequently, would not be judged merely as works of art, and, the competition, from an artistic point of view, would, therefore, be without meaning. The Royal Academy also pointed out the difficulty of obtaining any suitable exhibition premises in Stockholm, and also the absence of means of erecting such a place in the vicinity of the scene of the Olympic Games. The Academy, therefore, advised the Swedish Olympic Committee not to organize such a competition as the one in question.

The Swedish Society of Arts pointed out that, while no serious remarks could be made against the plan as far as architecture was concerned, the case was quite different in respect to the regulations for painting and sculpture. Unlike the other arts, architecture always serves a more or less practical end. With regard to a competition in painting or sculpture, on the other hand, it must always be an indispensable condition that the principal motive of the competition is, purely and simply — art. This seemed not to be so in the present case, and as the successful works of art in question were not to be awarded the Olympic prizes, merely, or even principally, on account of their artistic merits, the competitions at once became purposeless. The Society, however, advised the holding of an Art Exhibition in connection with the Olympic Games.

The Section for Architecture of the Swedish Technological Society replied, that, even if it fully perceived the attractiveness of the proposal to fashion the modern Olympic Games, with the aid of art, in accordance with their classic prototypes, it was not able to advise the holding of the proposed competition, chiefly on account of the vast machinery and great expense necessary for its organization, and of the comparatively small results that could be expected. The Section wished to suggest, however, that, of the alternatives — a competition or an exhibition — an international competition in architecture should be chosen, in accordance with a definite programme.

The Artists' Association decided both against a competition and an exhibition, while the Artists' Union expressed itself sympathetically as far as an exhibition was concerned.

"The Free Artists" Society pointed out in its reply that, although the proposal to awaken artistic interest in healthful athletic sport appeared a most attractive one, still, it was impossible to realize the idea in the form of an art competition. On the other hand, the Society thought that an Art Exhibition in connection with the Olympic Games of 1912, would be a very suitable measure to adopt.

In consequence of these expressions of opinion, the Swedish Olympic Committee, at a meeting held on the 6 February, 1912, resolved *not* to include the Concours d'Art in the programme of the Games, as the consensus of opinion in artistic circles in Sweden was against such a competition being held, and as, without the assistance of the leading artists of the country, the organization of such a competition would be associated with insuperable difficulties. A sum not exceeding 5,000 francs was granted, however, to be placed at the disposal of the International Olympic Committee, in the event of that body, in accordance with an alternative proposal made by Baron Pierre de Coubertin, determining to organize such a competition itself.

As a matter of fact, the International Olympic Committee afterwards determined to arrange such a competition as the one in question, and the following notice, with the propositions for the competition, was issued through the Swedish Olympic Committee:

1. The Fifth Olympiad will include: competitions in Architecture, Sculpture, Painting, Music, and Literature.
2. The Jury can only consider subjects not previously published, exhibited or performed, and having some direct connection with sport.
3. The winner of each of the five competitions will be awarded the Gold Olympic Medal. The exhibits selected will, as far as possible, be published, exhibited or performed during the Olympic Games of 1912.
4. Competitors must notify their intention of entering for one or more of these competitions before the 15 January, 1912, and the exhibits themselves must be in the hands of the Jury before the 1 March, 1912.
5. No limitations as to size or form are laid down for manuscripts, plans, drawings or canvases, but sculptors are required to send in clay models, not exceeding 80 centimetres in height, length or width.
6. For further information, application should be made to M. le Président du Comité International Olympique, 20, Rue Oudinot, Paris.

Various essays, musical compositions, paintings, works of sculpture and architecture were sent in within the time fixed, and were submitted to examination by the jury appointed by the International Olympic Committee.

The prizes were awarded as follows:

Literature:

Gold Medal: GEORGES HOHROD *et* M. ESCHBACH, Germany. "*Ode to Sport.*"

Sculpture:

Gold Medal: WALTER WINANS, U. S. A. *Bronze statuette, "An American trotter."*

Silver Medal: GEORGES DUBOIS, France. *Model of the entrance to a modern Stadium.*

Painting:

Gold Medal: G. PELLIGRINI, Italy. Three connected friezes representing "Winter Sports".

Architecture:

Gold Medal. EUG. MONOD et LAVERRIÈRE, Switzerland. *Building-plan of a modern Stadium.*

Music:

Gold Medal: RICARDO BARTHELEMY, Italy. "Olympic *Triumphal March*".

All the objects that gained a prize were sent to Stockholm and exhibited in special premises at 10, Karlavägen, to which the public was admitted.

The work of sculpture — "An American Trotter" — executed by Mr. Walter Winans, and which had gained the gold medal, was presented by the sculptor to the Swedish Olympic Committee, to be added to the new Swedish Museum of Athletics at the Stadium.

At the expense of the sculptor, a bronze cast was made of the medallion — "The Joy of Effort" — executed for the competition by Professor Tait McKenzie, of the University of Philadelphia, and was inserted in the outer wall of the Stadium. In accordance with a wish expressed by the President of the International Olympic Committee, a bronze plaque has been placed in the wall, as a pendant to the above-named work. It carries the following inscription:

Dans ce Stade, la Vème Olympiade de l'ère
moderne a été glorieusement célébrée par
tous les peuples de l'univers sous le règne
de S. M. Gustave V. — Juillet 1912.

The medallion and the plaque have been placed on opposite sides of the grand entrance to the Stadium.

The "Ode to Sport", written by Georges Hohrod and M. Eschbath, Germany, and which received the Olympic Gold Medal for Literature, was as follows:

I.

O Sport, Du Göttergabe, Du Lebenselixier!
Der fröhlichen Lichtstrahl wirft in die arbeitsschwere Zeit,
Der du ein Bote bist der längst vergangenen Tage.
Wo die Menschheit lächelte in Jugendlust,
Wo der aufsteigende Sonnengotte die Gipfel der Berge rötete
Und scheidend den Hochwald in leuchtende Farben tauchte.

II.

O Sport, Du bist die Schönheit!
Du formst den Körper zu edler Gestalt,
Hältst fern von ihm zerstörende Leidenschaft
Und stählst ihn durch dauernde Übung.
Gibst schöne Harmonie seinen Gliedern.
Und gefälligen Rythmus seinen Bewegungen.

Du verbindest Grazie mit Kraft.
Und Geschmeidigkeit mit Stärke.

III.

O Sport, Du bist die Gerechtigkeit!
Vergeblich ringt der Mensch nach Billigkeit und Recht
In allen sozialen Einrichtungen;
Er findet beide nur bei Dir.
Um keinen Zoll vermag der Springer seinen Sprung zu höhen,
Nicht um Minuten die Dauer seines Laufs.
Die Kraft des Leibes und des Willens Spannung ganz allein
Bestimmen die Grenzen seiner Leistung.

IV.

O Sport, Du bist der Mut!
Es gibt nur eine Losung für die Kraft der Muskeln und des Willens
Und die heisst: wagen!
Der wahre Mut is nicht tolkühne unbesonnene Verwegenheit
Ist nur Vertrauen auf die erworb'ne Kraft,
Dem Zufall überlässt sich nur der freche Spieler;
Dein Wagen ist Berechnung, ist Verdienst!

V.

O Sport, Du bist die Ehre!
Von Dir gespendet hat Lob und Zeugnis vollen Wert,
Weil nur in wahrer Redlichkeit gewonnen.
Unlautrer Wettbewerb und unerlaubter Kunstgriff
Sind streng verpönt.
Und mit Verachtung würde der bestraft,
Der nur mit List und Täuschung die Palme sich erringen wollte.

VI.

O Sport, Du bist die Freude!
Sobald Dein Ruf ertönt, erbebt der Leib in Wonne,
Das Auge glänzt und stürmisch Blut durchströmt die Adern.
Klar fliegen die Gedanken ätherwärts
Die Seele ist gelöst von jedem Druck
Und jubelt laut im Vollgenuss des Lebens.

VII.

O Sport, Du bist die Fruchtbarkeit!
Auf zielbewussten Wegen veredelst Du des Menschen Rasse,
Weisst kranke Keime zu ersticken und Flecken auszuwischen,
Die ihre Reinheit zu vergiften drohen.
Und kraftgeschwellt hegt der Athlet Verlangen,
Sich Söhne zu erzeugen, die fähig sind wie er,
Ruhmvollen Lorbeer zu erringen.

VIII.

O Sport, Du bist der Fortschritt!
Wer Deinem Dienste würdig sich will zeigen,

Muss fortgesetzt an Leib und Seele sich verbessern
 Muss jedes Übermass vermeiden;
 Und seine Leistungen zu steigern stets bestrebt sein,
 Und doch das höchste Gut, Gesundheit sich bewahren.
 Des alten Spruches eingedenk
 "Gesunde Seele will in gesundem Körper wohnen".

IX.

O Sport, Du bist der Friede!
 Du schlingst ein Band um Völker,
 Die sich Als Brüder fühlen in gemeinsamer Pflege
 Der Kraft, der Ordnung und der Selbstbeherrschung
 Durch Dich lernt Jugend selbst sich achten,
 Und auch Charakter Eigenschaften anderer Völker
 Schätzen und bewerten.
 Sich gegenseitig messen, übertreffen, das ist das Ziel
 Ein Wettstreit in dem Frieden.

* * *

The relative positions — according to the official method of calculating points — of the nations taking part in the Concours d'Art was as follows:

Nation	Gold Medal	Silver Medal	Points.
Italy	2	—	6
U. S. A.	1	—	3
Switzerland	1	—	3
Germany	1	—	3
France	—	1	2



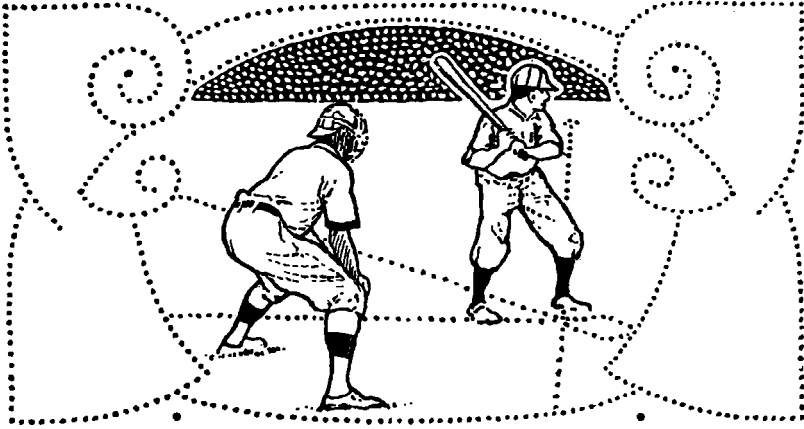

DISPLAYS, ETC., IN CONNECTION WITH THE OLYMPIC GAMES.

The Swedish Olympic Committee received from many quarters proposals for displays and competitions, outside the Olympic Games but in connection with them. There may be mentioned, for example, the proposal of the Knickerbocker Whist Club, of New York, for a competition in whist; one from Canada for a Lacrosse display and a third, from the Olympic Committee of France, for Aeronautic competitions. But on the 27 June, 1911, the Swedish Olympic Committee adopted the principle that competitions outside the Games ought to be avoided as much as possible during the progress of the Olympiad. None the less, the Committee considered that, in certain cases, exceptions should be made from this rule, and this was done as regards the Display of Boy Scouts, the Flat Racing and Trotting Races at Lindarängen, the display of Gottland games, the Icelandic "Glima"-Wrestling, Baseball, and the Swimming displays in connection with the illuminations at Djurgårdsbrunnsviken. In addition to this, there were several displays in gymnastics, of which an account is given elsewhere in this book, in connection with the report of the Gymnastic competitions.

The Co-operation of, and Display by, Boy Scouts.

The co-operation of the Boy Scouts was not meant to be restricted merely to displays, but it was also the intention to carry out a propaganda for the boy scout movement by means of allowing the lads to undertake easier duties (as attendants, etc.), at the Games, this work, at the

same time, affording a good opportunity for a number of boys to catch a glimpse of the great international event in the sphere of athletics.

The initiative to the participation of the boy scouts in the Games was taken by Captain B. E. Littorin, Chief of the Stockholm's Scout Corps, and Vice-President of the Scout Federation of Sweden. Captain Littorin laid his proposal before the Executive Committee of the last-named body, and the Committee, finding it a most attractive one, communicated with the Swedish Olympic Committee, which approved of, and accepted, the plan. The financial side of the question was discussed and arranged, and the two organizations drew up a programme in common for the participation of the scouts in the Games.

According to this plan, the scouts were to undertake, and be responsible for, all the sale of programmes inside the Stadium. In addition to this, they were to be ready to assist the officials of the Games at all the places where competitions were going on, and where it was thought that they could be of any use. Finally, they were to have the disposal of the Stadium for one evening, for the purpose of giving a display *en masse*, in gymnastics and in suitable boy scout exercises.

The following Committee was appointed for the purpose of organizing the participation of the boy scouts in the Games:

Camp-Chief and President:	Captain B. E. LITTORIN.
Manager and Secretary:	Lieut. RAGNAR EHRNFELT.
Treasurer:	KURT GELLNER, Esq.
Chief of scout contingent in Stadium:	C. EDELSTAM, Esq.
Manager for sale of programmes: ...	Lieut. TORSTEN AXELSSON.
Reception-Marshall:	J. PAULUS PALM, Esq.
Camp-Doctor:	Dr. A. G. GRÖNBERGER.
Intendant:	Lieut. C. G. M. HUMBLE.
Intendant:	Lieut. V. LIND.
Kitchen-master:	Sergeant-Major P. BRUNNBERG.

In order that as many scouts as possible might be given the opportunity of taking part in the movement, an invitation was extended to all the boy-scout corps affiliated to the Boy Scout Federation of Sweden. Invitations were also sent to the British, Danish, Norwegian, French and German Scout organizations, asking them to send small contingents. The following corps from abroad responded to the invitation: "Det Danske Spejdercorps" represented by some 50 scouts under the leadership of Captain F. Zeeman; "Norske Gutters Spejdercorps" and one or two other Norwegian Boy Scout Associations, which sent a total of 50 scouts under Lieutenant N. R. Östgaard, and "Jung-Deutschland" with about 40 scouts, led by Dr. Keller. As the Stockholm corps had an acquaintanceship of long standing with "Danske Drengene", this boys' association was also represented, and sent about 20 lads under the leadership of Mr. V. Hansen.

The Swedish boy scout corps that came into camp were the following:

Bodens Scoutförening.
 Borås Scoutkår.
 Djursholms Spanare.
 Enköpings Scoutkår.
 Eskiltuna, Sörmlandspojkar.
 Falköpings Riddargossar.
 Falu Scoutkår.
 Gothenburg Riddarpojkar.
 Karlshamns Riddarpojkar.
 Karlskrona Scoutkår.
 Kristianstads Scoutkår.
 Leufsta Bruks Scoutkår.
 Linköpings Scoutkår.
 Luleå Scoutkår.
 Norrköping, Östgötapojkarna.
 Sala Scoutkår.
 Skara Scoutkår.
 Sköfde Scoutkår.
 Stockholms Scoutkår.
 Strömstads Riddarpojkar.
 Uddevalla Riddarpojkar.
 Umeå Scoutförening.
 Vallentuna Spanarkår.
 Varbergs Scoutförening.
 Visby Scoutkår.
 Västerås, Arospojkar.
 Vänersborgs Spejarkår.
 Åmåls Riddarpojkar.
 Örebro Scoutkår.
 K. F. U. M. (Y. M. C. A.) Scoutkår.

As the scouts practice open-air- and camp-life on a large scale, it was considered that the best form of quartering this numerous assemblage would be to arrange a large camp somewhere in the immediate neighbourhood of the city, and the Royal Djurgård Park Authorities were kind enough to assign the scouts a suitable spot for their camp in the neighbourhood of Manilla, not far from the Djurgårdsbrunn Canal.

Altogether there were some 1,200 boy scouts in this Olympic camp.

As soon as the exact numbers were known of those that intended to be present, all necessary measures were taken for making the camp in readiness. The Royal Naval Dockyard was good enough to lend about 100 large or small tents, to be used by those corps that did not bring their own. Another important question, of course, was that of commissariat, but this question was solved by an intendant-school in the city kindly placing two officers and some 20 of the pupils at the disposal of the Committee. Rector Prawitz, of the Manilla Deaf and Dumb School, permitted the use of the fine kitchens there, and allotted a wing of the building to be used as an Office,

The result of all these kind services was that the payment made by each scout in the camp did not exceed 75 öre (10 d.; 20 cents) per day.

The various contingents of scouts began to arrive on the last days of June and, during the next few days, the remainder of the boys came into camp from all parts of the country. Those from abroad were received by their Swedish comrades with banners and martial music, and were then taken, amid songs and instrumental music, through the leafy promenades of Djurgården out to the camp near the Canal. As the members arrived they were divided into bodies, each 50 strong, with one of the elder scouts as divisional chief. A special order of the day had been drawn up, so that the camp-routine should be conducted properly, and of this the following details may be of interest. Reveille, 6 o'clock. Washing, dressing and tidying-up had to be finished in half an hour, after which, some early refreshments were taken. At 7 o'clock the Swedish flag was hoisted and saluted in proper boy-scout way, gymnastic exercises following. After breakfast there was a free interval of some hours, the time being used to view the sights of the town. Dinner was taken at 2 o'clock, the dining-room for the hundreds of boys consisting of the green slopes round Manilla, and, as beautiful sunshiny weather prevailed during the whole time the camp lasted, the dining-room did excellent service. After a couple of hours' rest after dinner, free exercises in gymnastics were taken, or the boys were allowed to play and amuse themselves under the superintendence of the leaders. The level ground at the foot of the camp swarmed with boys, and one could see, for example, how the lads imitated the tug-of-war competitions at the Stadium by forming tug-of-war teams, often with as many as 200 boys on each side of the red, central ribbon of the rope. Supper was taken at 7 p.m., and after that time the public came to visit the camp in great crowds. The scouts' own band provided the musical entertainment, and afforded the visitors great pleasure. The day concluded with solemn evening prayers, after which the Swedish flag was lowered with a proper boy scout salute.

As regards the assistance given by the scouts at the competitions, the various officials applied each day for the number of boys considered necessary for the several competitions, on the supposition, of course, that the scouts could be of any use in each special case. At the Stadium, for example, two reliefs of boy scouts were on duty every day, the first body arriving in the morning and staying on duty until 1 p.m., when it was relieved by the second division. The Stadium needed about 600 scouts for each day's service. On the day of the Marathon Race, scouts were posted all along the route, in order, in case of need, to signal orders from one to the other of the officials posted at various spots. At the Swimming Stadium, too, there were scouts on duty daily, and they also did service on the occasions of the Cycle Road Race, the Shooting Competitions, etc. Every body remembers from the "Stadium-days" how the little, sun-burned, blue and grey boys ran about, selling programmes and fans, letting out cushions, procuring water, wiping the perspiration from the bodies of the wrestlers, recalling fainting ladies to consciousness, or going home

to the dwellings of private individuals, in order, in accordance with the directions of the owners, to find pocket-books or a bunch of keys lying in the depths of some secret drawer, the position of which had been told them. Each one had his sphere of action given him beforehand, and received his instructions from the Scout-chief, E. Edelstam, the Chief Leader of the boy-scouts in the Stadium, after an application from the officials for a scout.

Then came the boy scouts' own display in the Stadium on Friday, the 12 July. The first item of the programme was a gymnastic display by the assembled scouts, under the leadership of Captain B. E. Littorin. The display began with a stately march into the arena of all the scouts to the tones of a lively quick step played by the Band of the Kungsholm Boys' Club's Scout Corps. The head of the long column consisted of the foreign contingents, preceded by the standards of their respective countries. Then came thousands of Swedish scouts, corps after corps, with some 20 banners at their head. The long train of lads, that stretched all the way round the running track of the Stadium, was greeted with loud applause by the spectators.

The scouts marched out again through the two tower-gateways in order to dress for the gymnastic display. After some minutes a sharp signal was heard and, at the same moment, the scouts rushed into the arena like one vast billowing wave. With their white shirts and blue collars and cuffs, they looked like a flight of thousands of swallows, moving forwards in "much-admired disorder". But the disorder was only apparent, for, the next minute, the turf was dotted with 1,000 boys in perfectly parallel straight lines, ready, at the leader's command, to give an exhibition of the Swedish gymnastics which, to these youths of a newer time, has given the harmonious, beautiful forms of classic physique. The exhibition commenced with a few free exercises followed by a game, after which came marching and movements in the ranks. Then came free jumping and vaulting over each other's bodies. The programme was concluded with a few simple trunk- and respiration movements. Everything went beautifully and with the greatest precision, not a single fault being made, and then amid the liveliest applause, they disappeared from the arena as swiftly as they had entered it.

After the gymnastics came a display of some special boy scout exercises, tug-of-war, relay-racing, etc. Then came a display of "first aid", the scouts giving an example of the way in which various injuries should be treated, and finally transporting an injured person from the ground on a cycle-ambulance.

After the Swedish scouts had been dismissed, the Danish boys marched in and gave an attractive display, among other things, of a kind of staff-play which is very popular in Denmark and goes by the name of "stokkeslag". Finally, the Danish boys threw themselves on the grass and began to roll about in all directions, apparently without any plan or order. But the final effect was a very pleasing one and resulted, too, in a beautiful greeting to Sweden, for the Danish boy scouts had rolled into long letters forming the words



A CORNER OF BOY SCOUTS' CAMP, DJURGÅRDEN.



BOY SCOUTS SALUTING THE SWEDISH FLAG

BOY SCOUTS'
CAMP.



ONE OF
THE FOREIGN
ENSIGNS
CHAIRIED.



GYMNASTICS IN BOY SCOUTS' CAMP.

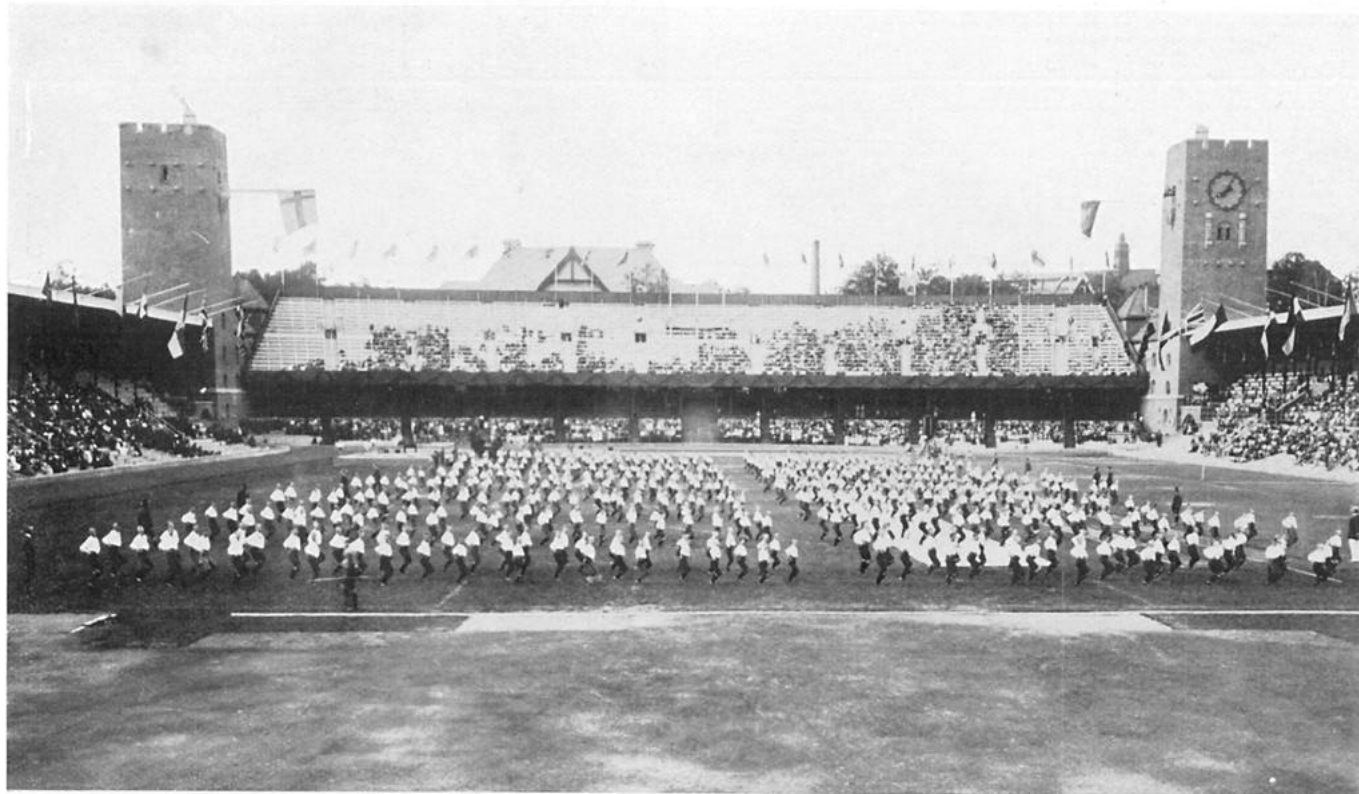

GYMNASTIC DISPLAY BY BOY SCOUTS IN THE STADIUM.

“SVEA LEVE” (Long live Sweden). First-Lieutenant Höijer had all honour of his lads from “Det Danske Spejderkorps.”

After the close of the display, all the boy scouts formed in lines of columns. Captain Littorin went to the front and thanked the public for the interest it had shown in the lads. After this there was sung in unison the song to Sweden beginning: “Du Gamla, du Fria” (“Thou ancient, thou fell-crowned, free land of the North”); then a cheer for Sweden was called for, the answer being a thundering fourfold cheer in Swedish fashion, and, with the band of the Gothenburg “Rid-darpojkar” at its head, the army of boy scouts marched out of the arena and the display was ended.

Displays of Gottland Games and Icelandic “Glima”.

Even now-a-days, very ancient, popular games are played in the Swedish island of Gottland. From old documents we know with certainty that such sports were practised at the beginning of the 17th century, and that then they were known to have been long customary in the island of the Goths. In all probability they are as old as the days of paganism, and have been handed down from generation to generation without suffering any kind of deterioration. People of all ages, from boys to old men, take part in them, and it is almost counted as a shame for a Gottlander not to have practised these ancient games. They are, thus, deeply rooted in the hearts of the people of the island, and the time will hardly come when they will be forgotten in the place that saw their birth.

There are three of these games that deserve special mention, and the Swedish Olympic Committee for the Olympic Games of Stockholm 1912 thought it only right to arrange exhibition games of “Pärkspel”, “Varpkastning” and “Stångstörtning”, for those who happened to feel an interest in the matter.

These displays, which were given in the Stadium at 7.30 p.m., Sunday, the 7 July, attracted a small but interested public, and the various exhibitions, which were finely performed, were greeted with lively applause.

The first to make their appearance were 16 stately, gigantic Gottlanders, bronzed by the sun of their native island. They were under the command of Lieutenant Lindvall. The men marched in step to the “pärk”-field in the southern half of the Stadium, and the game began. It was a little difficult for the uninitiated, perhaps, to follow all the intricacies of the game, but one could not but admire the lively yet lithe movements of the players, who used both hands and feet, as occasion required, to return the ball in fine curves to opponents who were equally on the watch to receive it.

The match was between a Blue team, of Visby men, and a Yellow, the members of which were from the country districts of Gottland. After an hour's contest the Yellows had won the two “pärks” played, and so claimed a well-deserved victory.

Simultaneously, at the other end of the arena, a display was being given of Icelandic “Glima”-wrestling, a form of athletics that de-

mands skill, elegance and litheness. After a friendly hand-shake, the opponents grasped each other firmly by the "handles" in the leather girdles they wore. Then began a lithe, dance-like wrestling, in the course of which the men were as often being swung in the air as they were on terra firma, and some vigorous bouts were fought before a proper fall could be gained.

After the close of the "Pärk" and "Glima" there was given a simultaneous display of two ancient Gottland games: "Kasta varpa" (quoits) and "Stångstörtning" (tossing the caber). The quoits, thrown with sure hand and eye, went spinning close to the pins, and often touched the hobs.

An account of these sports may interest the reader, "pärk", especially, being a game worth adoption in other lands.

PÄRK SPEL.

Sketch of the "Field".

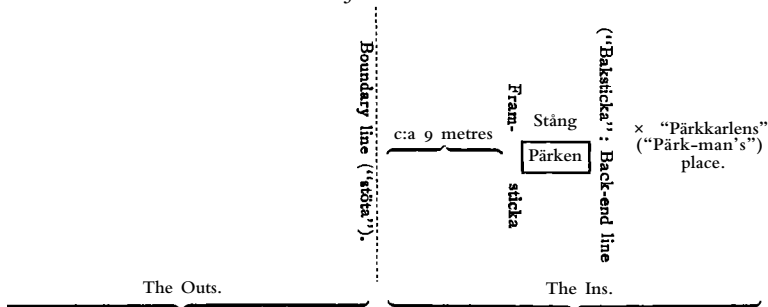

The game takes its title from a rectangle of narrow laths or of rope, laid on the ground and called the "pärk". The dimensions of the "pärk" are 230 centimetres \times 80 centimetres (92 inches \times 32 inches); the sides are called "stång" and the ends "sticka" — "framsticka" and "baksticka" respectively.

The field is divided by a boundary line, or "stöta" (lying about 9 metres from the "pärk") into two parts, called "ute" and "inne" (outs and ins): see the above sketch.

The game is played with a fairly light, but hard, leather-covered ball, about 10 centimetres (4 inches) in diameter. The ball can be struck either with the hand or the foot. The chief rule is, that the ball may only bounce once on the ground before it is struck, if it does not happen to be struck while in the air before bouncing. If the ball bounces more than once before the stroke, it is dead; the ball is also dead, if, while it is in play, it is touched twice in succession by the same player, or even if only once by several players in succession who are on the same side.

The games, like most others, consist of periods of attack and defence. The aim of the attacking side is, to get the ball dead in that part of the field belonging to the "ins", while the last-named side must endeavour to prevent this. The end in question is attained by striking the ball so hard, or so far, into the opponent's part of the

field, that the players there are unable to strike it back before it is dead.

The number of the players, as a rule, is 14, there being 7 on each side. The number can be less, but hardly larger.

The captains of the different side, who are the only men that receive the serve, are called "pärk-karlar" ("pärk-men"), and they are usually the best players.

The points or "vunsterna" are four in number, viz: 10, 20, 30 ("fullt" or set ball) and 40 ("vunnet" or game).

The Play.

The captains toss for innings. We can call the sides, the "Blues" and the "Yellows". The Blues win the toss and the players take up their respective places. The placing of the men of each side is arbitrary, but the "pärkkarlen" of the "Ins" has his place behind the "backsticka" (back end) of the pärk. See the sketch.

The Yellows, who are the outs, attack first, and endeavour to get a so-called "kas", i. e., to get the ball dead, (i. e., so that it stops rolling), at a spot as far inside the defender's part of the field as possible. If the Outs can get a "kas" behind the "bakstickan" or an imaginary continuation of this back end of the "pärk", they have got what is called "kas i baken" (dead ball at the back), the best that can be had and the two sides at once change places. If the Outs cannot succeed in getting any "kas" at all in their opponents' territory, then the boundary line ("stötan": see sketch) is "kas" or dead-ball line. Each man, in turn, of the Outs, must, if necessary, (i. e. unless a "kas i baken" is previously made), serve ("slå in"— strike in) the ball with a stroke of the hand; i. e., he must endeavour to serve the ball from the boundary-line just in front of the "pärk", so that it bounces the first time in the "pärk" without touching the sides of the same. All the first serves must be made from the "stöta", or boundary line, in front of the "pärk". If, when the ball is served, it should bounce outside the "pärk", or touch the side, the stroke ("hugget") is a fault, and the player that has made the fault cannot repeat the serve, but the next man on his side takes his place. The harder the serve is given, the more difficult it is to get the ball to bounce in the "pärk", but, on the other hand, a hard ("snarvt") serve is always more difficult for the opponents' "pärkkarl" to take. If the serve succeed, then the "pärkkarl" of the Blues (the Ins, or defenders), *and he alone*, endeavours with hand or foot to return this first serve, after it has bounced once, as far as he can, back into the territory of the Yellow (attacking) party which, in its turn, tries to get the ball back into that part of the field belonging to the Blues. Should he not succeed and the ball, after bouncing, becomes dead behind the "backsticka", then "kas i baken" has been won by the Yellows and the two sides at once change places. (See below.)

In this way the ball is struck backwards and forwards until it is dead on one side or the other. After the serve, the ball may be taken in the air or on the hop, after one bounce. The spot where the

ball becomes dead (stops) on the defenders' territory (i. e. where one of the defenders misses) is the "kasen" (dead ball) and it is marked with a peg or the like. If the "kas" happens to be between the "stöta" (serving-line) and the "backsticka", or back- end line, some two or three of the attacking force may advance so much nearer into the defenders' territory. In this way the Yellow (attacking) side makes its: serves (hugg), either until it has got a "kas i baken" (dead ball at the back of the "pärk"; see the foregoing), or until each man on that side has served. When the ball becomes dead in the attackers' half of the field, then their next man must serve. When all the "Yellows" have served, the two sides change places, the Yellows becoming the Ins, and the Blues the Outs; i. e., the first-named become the defenders and the last-named the attackers, Now begins the attempt to get what is called "kula" or "vunst"; i. e., the Yellow party must endeavour to defend the "kas" (dead ball) it gained when it was the attacking party. (The best "kas" is, of course, "kas i baken": if the Yellows — the first attacking side — has not won such a "kas" but has several "kasar", or dead balls in front of that line, then, on changing sides, the Yellow shall defend that "kas" which lies nearest the "backsticka", or back- end line, this one being the most advantageous for them). *This it does by hindering the ball, when the Blues begin to serve, from becoming dead (i. e. stopping) behind that "kas".* Each man of the Blues, if necessary, must try to serve the ball into the pärk, and the pärkkarlen (the striker-out) of the Yellows must try to return the serve, the ball being then cast backwards and forwards from the one side to the other, as described above, until it is dead. If the Yellows succeed in defending their kas, then they count one point = 10; if they do not, then the Blues count 10 and one "innings" has been completed on each side. After the play for "kula" or "vunst" has been decided, another innings begins. The sides stay on that side of the "stöta", or boundary line, where they are, and then the Blues, who in their turn begin the attack, must try to get a kas (dead ball) in the territory of the Yellows, and, if they succeed, the sides change places, as above, and the Blues must defend their kas.

If no "kas" is won by the attacking side, then, of course, a second innings is begun at once by the other side taking up the offensive and trying to win a "kas".

The game goes on in this way, each side alternately becoming the Outs (Ins), until one of them has got four points = 40 (vunnet) and thereby won a game (a "pärk"). As a rule, three "pärk" are played, that side finally winning which gets two of them.

"VARPKASTNING."

(Quoits).

This game can hardly be called a form of athletics in the modern sense of the word, as it requires neither special strength nor agility, but merely sureness of eye and a skilful hand. The game is, thus, one



ICELANDIC "GLIMA"-WRESTLING.

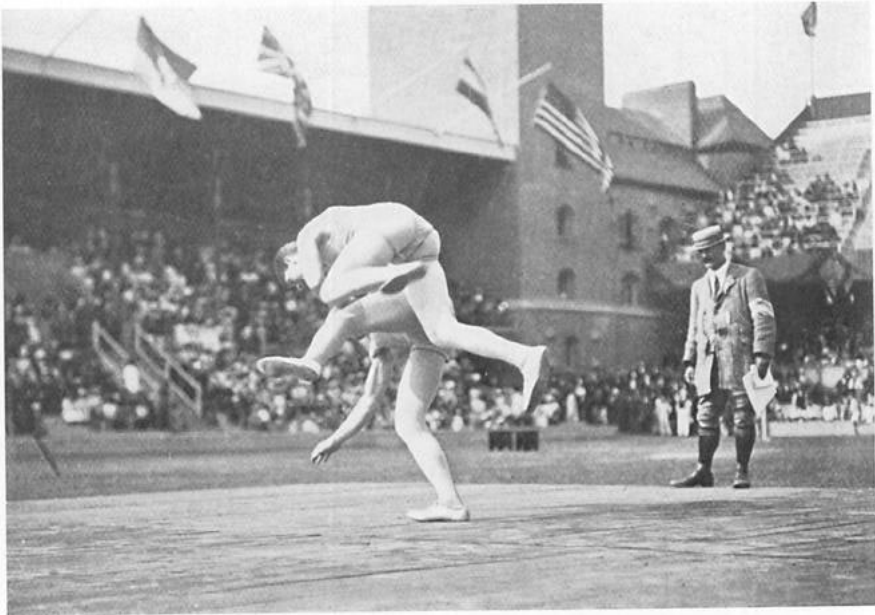

ICELANDIC "GLIMA"-WRESTLING.



ICELANDIC "GLIMA"-WRESTLING.

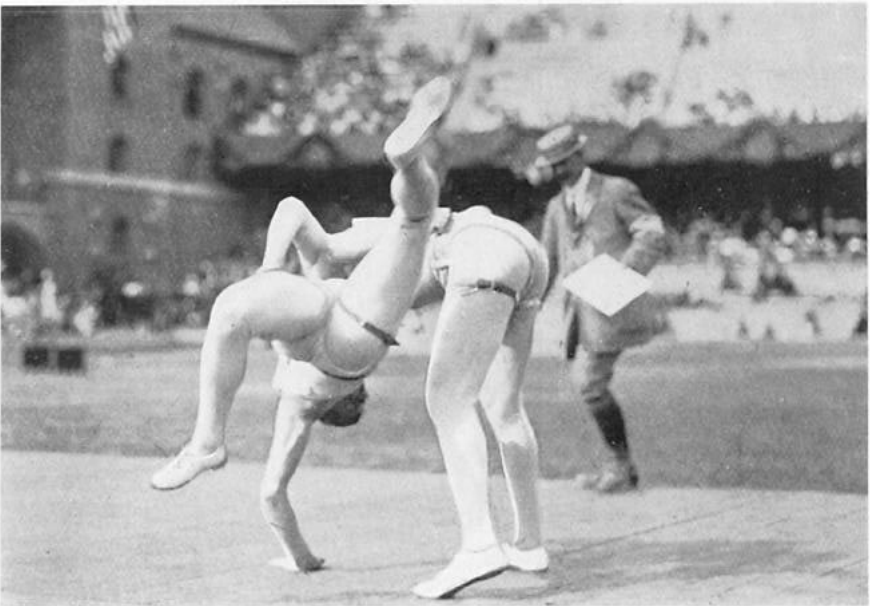

ICELANDIC "GLIMA"-WRESTLING.

that is held in special favour by elderly men, and is a somewhat unique "Old man's game".

The "varpan" (quoit) consists of a flat, nearly round, and somewhat thick stone, 15 centimetres (6 inches) or a little less in diameter. The quoit is held in the right hand so that the forefinger rests along the rounded edge of the stone, with the other fingers on the under side of the quoit. When the stone is thrown forward, it is given a slight rotary movement in order to get it to move steadily through the air and to remain on the spot where it strikes the ground. After having learned to throw the quoit in this manner, the game is, to throw at a mark at a certain distance, usually about 20 metres. The marks consist of pins, or *hobs*, fastened in the ground. The players stand by the one pin and throw at the other. When everyone has thrown his quoit, the players go to the mark, and the one whose stone lies nearest to the pin gains one point. Each player now casts his quoit at the pin where he was standing when he began the game, and the casts are continued from each hob alternately, until one of the players gains 12 points, when he becomes the victor.

The game can be played by two or three persons, but also by more; in the latter case the players divide themselves into two parties, the best throw of each side deciding the point.

"STÅNGSTÖRTNING"

(Tossing the Caber)

is a sport that presupposes an amount of bodily strength somewhat surpassing the ordinary.

The caber, which is of timber, should have a length of about 5 metres, with a bottom diameter of 13 centimetres ($5\frac{1}{2}$ inches) and a top diameter of about 7 cm. (3 inches). The caber must first be lifted from the ground with one hand round the thin end, the pole being then grasped by the other hand, at a distance of about $\frac{2}{3}$ of a metre (26 inches) higher up. Then, supporting the caber on the bended knee, and with the body bent somewhat backwards, the player must try to heave up the pole, so that the thick end is lifted upwards, until the caber stands almost perpendicular, supported somewhat against the shoulder. Both hands now grasp the thin end of the pole. With the caber in this position, a slight run is permitted up to a certain mark and then, when this is reached, the thick end of the pole is allowed to fall slowly forwards, and, at the same time, the caber is thrown forcibly upwards and forwards, so as to get the pole to turn over. The thick end of the caber touches the ground first, and it ought to pitch over with the thin end foremost. In order to count a point, the thin end must fall forwards at right angles to the throwing point, and the thrower must not step past the mark. The one who throw farthest and who gets the caber to turn over properly, is the winner.

ICELANDIC "GLIMA"—WRESTLING.

THE RULES.

The wrestlers shall stand erect. They grasp each other with the *right* hand on the opponent's *left* hip (the players wear trunks),

and with the *left* hand somewhat above the middle of the opponent's *right* thigh. Heels together; toes turned out.

The hands must never be employed to obtain any special hold. A wrestler may make use of them only to prevent himself from falling, so that his body will not touch the ground.

It is not permitted to strike with the feet (on the calf, or elsewhere, where an opponent can be hurt), elsewhere than near the ground (as, for example, in a "vadtag", or "calf", leg-hold), and then only with the sole of the foot.

Defeated is the one that touches the ground with:

- The whole body.
- The trunk.
- The hip.
- The upper arm.
- The thigh.

Not defeated is the one that touches the ground with:

- The hand or hands.
- The knee or knees.

A *Brother-fall* is the term given when both wrestlers fall at the same time. When this happens, the "glima" shall be begun again from the beginning.

In the course of an ordinary "*competition-glima*" all the opponents meet each other. The one that wins oftenest is the victor.

Example.

	Arni	Björn	Gunnar	Jón	Wins
Arni	o	+	—	+	2
Björn	—	o	—	+	1
Gunnar	+	+	o	+	3
Jón	—	—	—	o	o

Explanation: Arni wrestles with Björn and beats him; a + sign is then placed to Arni's credit underneath Björn's name, and a — sign to Björn beneath Arni's name, and so on. (+ = win; — = defeat.) According to the table given above, Gunnar has beaten all his rivals and so is the victor.

Each "glima" lasts three minutes. If, during this time neither competitor wins, there is a pause of two minutes, after which a fresh "glima" begins.

If a competitor gives up a "glima", and does not fight it out to the end, it is reckoned as a defeat to him and a win to his opponent.

If a competitor makes use of a "nidtag" (foul), during the course of a "glima", and if the judges agree that it has been done willfully, the offender is warned. If a competitor is warned twice during the course of the same glima, he loses the right to take any further part in the competition.

A *nidtag* (foul) is the term applied if one of the wrestlers come down on his hands and feet, or is in any other dangerous position, and his opponent rushes up to him and presses him to the ground by sheer weight, and without having the prescribed hold. All "nidtag" (fouls) are forbidden.

* * *

At 3 p.m., on Monday, the 15 July, competitions in Icelandic Glima-Wrestling were held at the Stadium, for a Cup presented to the Swedish Olympic Committee by Icelanders living in Denmark.

The following Icelanders took part in the competition: Sigurjón Pjetursson, Hallgrimuá Benidiktsson, Magnús Tomasson, Axel Kristjánsson, Gudmundar Kristinu Gudmundsson and Kári Arngrimsson, Halldór Hanssen acting as judge. The display was one of the most delightful of all the competitions in the Games.

Baseball.

The game of baseball is one of no very ancient date in Sweden, Vesterås, in 1910, being the birthplace of the first club formed for the practice of the game that is so very popular in America.

When, in the spring of 1912, the Vesterås Baseball Club received a communication from the Swedish Olympic Committee, inquiring whether the Club would be willing to take part in an exhibition game one evening during the Games, the question awakened both pleasure and doubt in the hearts of the members, for, though the highest wish a Swedish athlete could entertain was that of being able to take any part in the Olympic Games, there were doubts if the Club could get a team of good players. Many of the most prominent members of the Club had left the district, and this loss seemed a difficult one to make good. However, by means of continual practice, carried on three times a week, the Club managed to get together a team sufficiently skilful to be able to give their opponents a fairly good game.

The American Olympic team in Stockholm had the idea of giving an exhibition of baseball in the Swedish capital, and had therefore brought baseball outfits, together with a description of the game, printed in America.

According to the original Olympic programme, the evening of July 10 had been reserved for the exhibition game in the Stadium, but as the American Olympic Committee would not allow the members of the team to take part in the game before the end of the other competitions, the baseball match was put off until Monday, July 17, when the game was played at the Östermalm Athletic Grounds, the Stadium at that date being needed for the Horse Riding competitions.

As, in baseball, a great deal depends on the "battery", i e. the ability of the pitcher and catcher, and as, compared with their opponents, the Swedish team was pretty weak just in this respect, the captain of the American team was begged to allow two of his men to act as the battery for the home side. The visitors were kind enough



VÄSTERÅS BASEBALL-CLUB TEAM.



BASEBALL MATCH, U. S. A. v. SWEDEN.
AXELL, Sweden, batsman: DAVENPORT, U. S. A., pitcher.

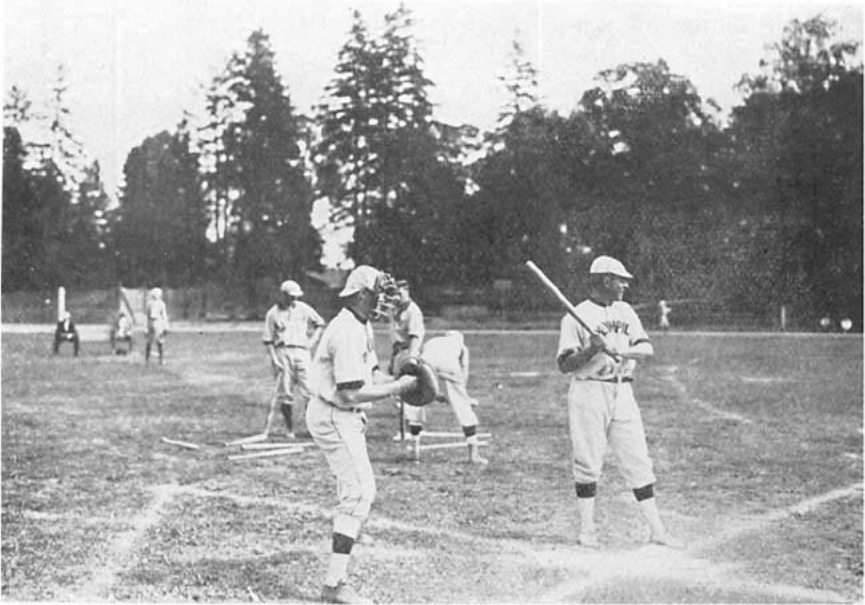

BASEBALL MATCH, U.S.A. V. SWEDEN
Practice before game. DAVENPORT catcher, HOLDAN batsman



BASEBALL MATCH, U.S.A. v. SWEDEN
WICKMAN, Sweden, making a two-base-hit to centre field. DAVENPORT catcher.

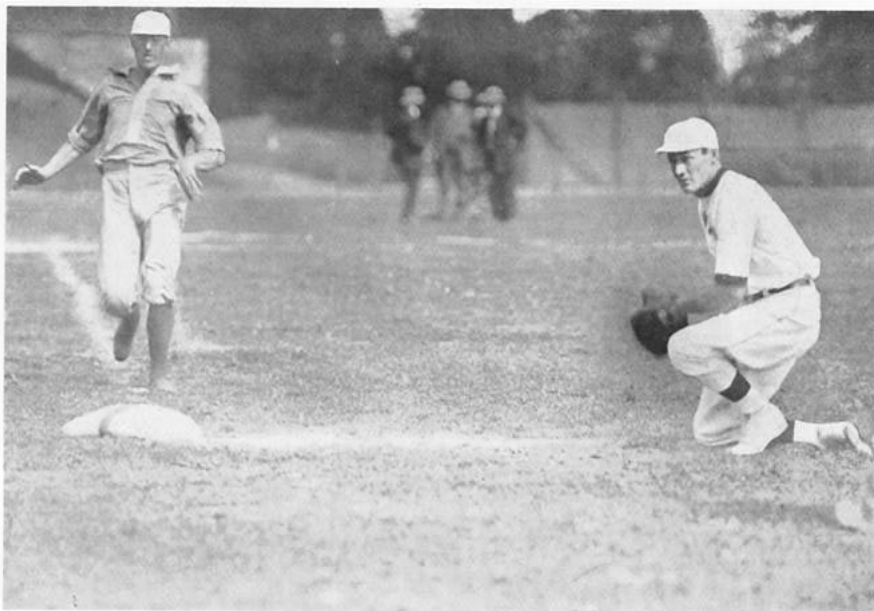

BASEBALL MATCH, U. S. A. v. SWEDEN.
WELIN, Sweden, racing to 1:st base after a short hit. BLANCHARD at 1:st base.



BASEBALL MATCH, U. S. A. v. SWEDEN.
SWEDEN in. U. S. A. fielding. ADAMS batting. DAVENPORT catcher.



CHORAL FESTIVAL IN THE STADIUM, 13 JULY, 1912

As may be seen by the above report of the game, six innings were played, the final result being America 13, Sweden 3. As the game began at a comparatively early hour, 10 a.m., there was no great crowd of spectators, and those that were present were mostly Americans or Swedish-Americans.

REPORT OF THE ENTERTAINMENTS COMMITTEE.

On October 30:th, 1911, the Swedish Olympic Committee appointed an "Entertainments Committee", as it was felt that some measures ought to be taken for the comfort and pleasure of those who were expected to visit Stockholm during the Games. It seemed specially desirable to make every effort to organize some public entertainments, in consideration of the fact that the long, light, northern summer evenings usually entice people to remain out of doors until a very late hour. The Committee, therefore, was empowered to take all steps necessary with regard to the decoration of the city, excursions and interurban communications, public amusements, evening entertainments at the Stadium, and publications in connection with these matters.

The composition of the Committee was as follows:

President: A. LILJA, ESQ.,
Vice-President: FRITHIOF AHLSELL, ESQ.,
Secretary: D. BLOMBERG, ESQ.,
Other Members: B. F. BURMAN, ESQ.,
BEYRON CARLSON, ESQ.,
CAPTAIN E. FRESTADIUS.,
TORBEN GRUT, ESQ.,
KRISTIAN HELLSTRÖM, ESQ.,
OLLE HJORTZBERG, ESQ.,
C. RAMSTRÖM, ESQ.

The Decoration of the City.

The decoration of the city during the summer was a matter of great public interest, the Artists' Club, among other bodies, devoting attention to the matter, and discussing it at a special meeting.

A number of proposals were made for the decoration of the streets and public places; plans for triumphal arches in central positions, bonfires on the southern heights of the town, decorative arrangements along the quays, etc., being sent in to the Entertainments Committee. This body finally came to the conclusion, however, that the city would appear most dignified adorned in native beauty, its charms enhanced merely by a wealth of flags, that is to say, Stockholm was to be itself, but in its best attire.

In accordance with this decision, a letter was addressed to the Civic Financial Board which, with the greatest willingness, agreed to carry out the wishes of the Committee as expressed in its communication,

this leading to the decoration of the streets and squares of the town with flags.

Flag-staffs, displaying the colours of the nations taking part in the Olympic Games, were erected in the following streets and public places: Skeppsbron (the Great Quay), Norrbro Bridge, Strömgatan along Norrström to Skeppsholmen, Arsenalsgatan, Birgejarlsgatan, Sturegatan, Valhallavägen, Sturevägen as far as to the Olympian Gardens, and along Strandvägen up to the Swimming Stadium.

The festive appearance of the town was enhanced by the masses of flags and bunting that adorned many private houses and public buildings, while balconies were more generally decorated with flowers than in other years.

Excursions in the vicinity of Stockholm.

By means of circulars to the various steamboat companies whose vessels keep up communications between Stockholm and its environs, the Committee endeavoured to awaken an interest in the arrangement of excursions to various places.

During the time the Games went on, a great number of boats, among them the steamships "*Brevik*" and "*Saga*", made pleasure trips at different hours, the midnight excursions being much liked, as they gave visitors an opportunity of finishing the day in a most pleasant way before going to rest after the restaurants were closed. On a couple of these boats there were "hosts", speaking several languages, and the decorative arrangements and the preparations to satisfy more material desires were made with a special view to the guests from abroad and to upholding the reputation of Swedish hospitality.

The harbour authorities, too, displayed the greatest willingness in the matter of arranging special anchorages for motor-boats, a step that greatly facilitated an advantageous placing of these vessels for excursions to various places.

Experimental taxi-cab drives were made through the town, for the purpose of determining times, distances and fares, the results being afterwards published in the official guide.

Publications for the guidance of visitors.

By means of circulars to the theatres, art-exhibitions, museums, concert halls, and steamboat companies of the city, an appeal was made to supply the Committee with information respecting their intended special arrangements for the summer, these particulars afterwards being published in the two organs of the Committee, "*Stockholm*", and the "*Guide Programme*".

A contract was made with the firm of Hasse W. Tullberg & Co. for the due publication of these guides.

"*Stockholm, The Official Guide to the Olympic Games*" was a book of more than 300 pages, and cost 1 krona (c:a 1 sh. 1 d.). It contained a full description of the sights of the city and its environs, and a list of the communications, as well as plans of the various

Olympic arenas, a general programme of the Games, a list of the entertainments, etc., in Swedish, English, German, French and Russian.

"*The Official Guide and Programme*" was a daily sheet, costing 10 öre (1½ d.), with a list of amusements and entertainments for the day.

Both of these publications were edited by Mr. Gustaf Åsbrink.

Gala, and other Theatrical Performances.

At the request of the Committee, the *Royal Opera* re-opened between July 2 and July 15, during which time there were given: *Carmen*, *Romeo and Juliet*, *Tosca*, *Lohengrin*, the *Adventures of Hoffman*, and *Bohème*. On July 6, at the same house, there was given a Swedish Ballad Concert, with Mr. John Forsell, Court singer, as soloist. Swedish orchestral compositions were also played on this occasion.

On July 11 and 14 at the request of the Entertainment Committee, the club called the "Friends of Swedish National Dances", gave *gala performances* at the Opera House, the programme on both occasions being most successfully carried out. A specially chosen choir of Uppsala undergraduates sang a selection of Swedish part-songs and then came two scenes, one representing an old-fashioned cottage interior, and the other a fell-landscape bathed in the light of a northern summer night; old-fashioned dances and herd-girl songs were then given with these poetical back-grounds.

On July 15, on the occasion of the Horse-Riding competitions, there was given *another gala representation* at the Opera, when *Izeyl* was performed, the Royal family and their Imperial and Royal guests being present.

Of the other Stockholm houses, the *Svenska Theatre*, the *Oscar Theatre* and the *Djurgård Theatre* also gave performances. At the *Intima Theatre* an amateur company of undergraduates, from the Universities of Uppsala and Stockholm, gave a classical comedy that ran for some few evenings. At the *Svenska Theatre*, Einar Fröberg's company played "A Midsummer Night's Dream" from June 27 to July 1. At the *Oscar Theatre*, the operettas, "The Count of Luxemburg", "The Merry Widow", and "Chaste Susanna", were played from July 1—15. The *Djurgård Theatre* was open all the summer, according to custom.

As was mentioned above, a company of undergraduates gave a classical comedy, "Mostellaria" written by Plautus Titus, and dating back some 2,000 years. It was the intention of those that gave the initiative to this enterprise, to offer the public classical plays during the course of the classical Olympic Games. As on a former occasion in Stockholm, and as was the custom during the early part of the 17:th century, all the roles, those of the women too, were played by men. The attendance here, as at the other theatres, was not all that could have been expected, but the performances were continued, with the exception of some few nights, until the 12 July.

All the concert halls, restaurants and music halls did their best to make as favourable an impression as possible, by engaging good bands, etc.

By the efforts of the Entertainment Committee, a concert was given at the Stadium on the evening of July 6, by the massed military bands of the city, in which 300 performers from twelve different bands took part. The arrangements were made by the Stockholm division of the Swedish Musicians' Association, under the patronage of H. R. H. the Crown Prince. Swedish composers alone were represented on the programme. The audience was a very good one, and warmly applauded the performance.

This concert, the success of which was due in no small degree to the excellent acoustic properties of the Stadium, was the greatest of its kind that had ever been held in Sweden.

On the evening of July 9, the band of the Royal Grenadier Guards played at the Stadium, Sub-lieutenant Gustaf Björkquist being the conductor. The reason of this concert being given was to allow people who had no opportunity of visiting the athletic grounds during the day, to see the place at their ease on the payment of a very small sum.

On Friday, 12 July, there was a *grand review of Swedish Boy Scouts* at the Stadium. At 7.30 p.m., Swedish, Danish, Norwegian and German boy scouts marched past amid the lively applause of the sightseers, the review following immediately afterwards.

Open Air Entertainments.

Following the traditions with regard to the arrangements made to amuse the public on the occasion of exhibitions, rifle meetings, etc., the Committee made it an item of its programme to arrange pleasure gardens, etc., in the neighbourhood of the Stadium. It can easily be understood that, for the short time that the Games lasted, there could be no possibility of any extensive or expensive arrangements being made anything like the immense and costly establishments on the continent, but everything was to be of a provisional character, the principal features being a dancing platform, roundabouts, etc.

Through the complaisance of the military authorities and the Djurgård Park Board, it was found possible to arrange the gardens in question at a suitable spot near the harbour of Värtan. After the place had been drained and covered with gravel, there were erected a large restaurant, dancing platforms, a marionette theatre, switch-backs and other simple attractions, the whole being given the title of "Olympia". The price of admission was 3 d. (c:a 6 cents).

There were crowds of sightseers the whole of the time the place was open and, during the short period of its existence, it was visited by about 30,000 persons.

A considerable part of the receipts was paid over to the Swedish Committee for the Olympic Games.

Special arrangements made by Public Institutions.

A number of public institutions made special arrangements in connection with the great event in the world of athletics.

For example, the Royal Library exhibited a number of books dealing with athletics, the exhibition including an interesting collection of manuscripts (some dating from the 16:th century, these latter embracing chiefly riding and fencing), and the rich literature of our days in the field of sport and athletics.

At the open-air museum of Skansen, the various Provincial Associations for the promotion of home-sloyd (domestic handiwork), exhibited, for the purpose of sale, products of Swedish home labour — Scanian tapestry and lace, linen from Västergötland and Ångermanland, and leather, bone and mazer work from Lapland. The objects sold formed a pleasing contrast with the ordinary souvenirs sold at industrial exhibitions.

At the open-air theatre at Skansen there was given a "folk-play" called "The Värmlanders", and at the lower theatre, which is also an out-of-doors establishment, Topelius' play, "The Whirligig", was given during the whole of the summer.

The Northern Museum allowed the Östergötland Association for the Promotion of Home Sloyd to use two of its rooms, for the purpose of exhibiting the fine old lace, hemstitch and tapestry made in the peasant homes, etc., of the province.

The Swedish Artists' Association, the Swedish Artists' Union, an artist, Mr. G. Fjaestad, and the Sloyd Association called "Handarbetets Vänner", had very interesting exhibitions of work during the summer, and it was everywhere evident that the intention was to make the very best possible impression on an occasion like that of the Olympic Games, the holding of which was such an honour to the country.

* * *

On casting a glance back at the efforts made by the Entertainments Committee to arrange public amusements during the course of the Games, it will be found that the indoor-entertainments offered to our visitors and which (as, for example, in the case of those at the Royal Opera House) were of a very high class, could not compete, as far as the attendance of the public was concerned, with the out-of-door amusements, even if these were of the very simplest description.

A long evening spent in the open air amid the witchery of the Northern summer twilight that, during June and July, forms our night here, seemed to be the natural continuation of the exciting out-door life of the daytime, and the Terrace Café at the Stadium and all the other open-air establishments of the kind were, as a rule, quite full, while the theatres were playing to half-empty houses. It would be difficult to say, however, whether this experience should be a guide for places in more southern latitudes, where artificial lighting replaces, though it cannot vie with, the natural beauty of a northern summer eve.

It should also be added that, in many cases, the expectations of those who went to great extra expense and made sacrifices in order to be able to offer the public increased opportunities of enjoying themselves during the course of the summer of 1912 here in Stockholm, were not fulfilled. In consequence of the vast scale on which the

Olympic Games were advertised and the lengthy preparations made, economical expectations were raised to the very highest pitch, and the result was disappointing to the more sanguine of the speculators.

As a result of the contracts which the Entertainments Committee had been empowered to make, the body in question was able, however, to hand over to the Swedish Olympic Committee, at the conclusion of the Games, the sum of a little more than £ 2,000(\$ 10,000), as shown in the Report of the Finance Committee.

The great Swedish Choral Festival at the Olympic Games of Stockholm, 1912.

The Swedish Choral Association, which embraces singers from every part of Sweden, and the object of which is to create an interest in the execution of four-part songs for men's voices, and also to increase patriotism in Sweden, organized a grand Choral Festival in connection with the Olympic Games of Stockholm, in 1912.

More than 4,400 singers from the whole country took part in this music festival. A temporary concert hall was erected for the occasion, seating 8,000 persons, in addition to the singers. The festival lasted three days, during which time two concerts were given at the hall, an open-air performance took place at Skansen, and one was held at the Stadium. At the concerts, which were attended, at Skansen, by an enormous crowd, and at the other places by full houses, the songs were rendered, in part, by the grand choir of 4,400 men, and, in part, by smaller choirs from the provinces, each numbering from 200 to 800 singers. The concert at the Stadium, which was attended by an audience numbering 27,000, was preceded by an immense choral procession, in which 6,000 persons took part. In the cortege there were allegorical groups representing "Patriotic Songs", "War Songs", "Church Choral Music", and "Ballads", besides which there were groups from each province of Sweden illustrating some peculiar feature of the district represented. A most imposing sight was presented this lovely summer evening by the entrance into the Stadium of the enormous procession of 4,400 singers, in their white corps-caps and with their banners, and preceded by the allegorical groups — whose gigantic platforms were drawn by teams of six horses — the heralds and horsemen, the thousand schoolboys and the thousand boy-scouts with little Swedish flags in their hands, which marched into the arena amid the applause of nearly three times ten thousand expectant sightseers. It made an impression which can be imagined, but hardly described.

After the singers had taken up their station in the middle of the arena and Mr. Hultquist, principal conductor of the Association and sole arranger of the festival, had mounted the tribune, the concert began with a special greeting to Their Majesties the King and Queen, consisting of a feeling speech by H. R. H. the Crown Prince, Chairman of the Swedish Choral Association, followed by a song of homage composed for the occasion and dedicated to their Majesties. Then

came the concert proper, consisting of patriotic songs alone, which were rendered most brilliantly. It was simply astounding to hear such perfect ensemble, such precision of intonation, with variations in fullness of tone that allowed the vast volume of harmony to roll in thunder across the Stadium, or to die away in the faintest pianissimo. Each number was greeted with great applause, and after the last song — “Hear us, Svea!” — which was heard by the audience standing with uncovered heads, there was no end to the cheering. There was a clapping of thirty thousand pairs of hands; people hurrahed and shouted, they waved handkerchiefs and parasols and, the ‘encore’ not coming quickly enough to please the public, bursts of applause were heard arising from section after section of the audience, followed by the cry “Hear us, Svea! Hear us, Svea!” Although the concert was now at an end, the public would not quit the Stadium, but continued to ask for fresh numbers, which were heard with an undiminished enthusiasm, seldom, or never before, witnessed among the slowly-moved dwellers in the high north.

As may be imagined, the concerts in the great hall were of greater musical value, as it was possible to arrange the programmes there in better accordance with the demands of art, and as songs by smaller choirs and soloists, given in addition to the performances by the large choir, lent variety to the whole. The ideal acoustic properties of the concert hall also added to the effect, for seldom has a temporary erection better served its purpose in this respect than was now the case.



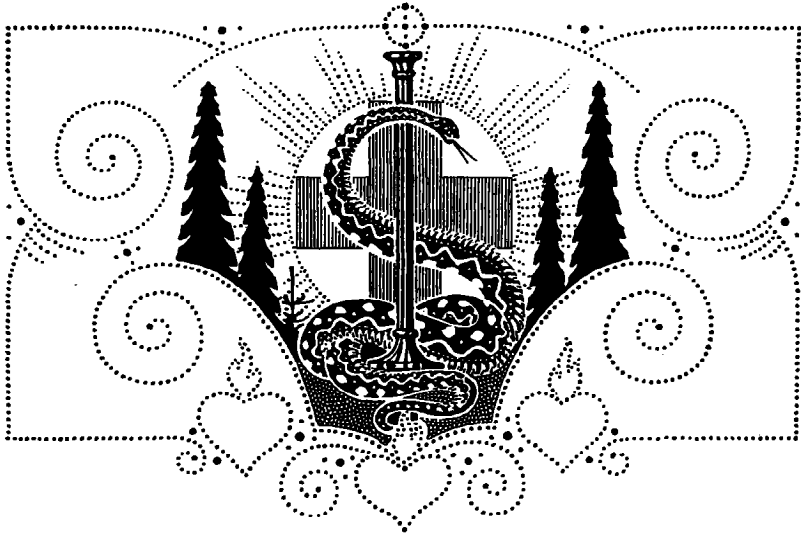

MEDICAL AID DURING THE GAMES.

The arrangements for providing medical aid at the various places for the competitions in athletics, swimming, rowing, cycling, fencing and horse riding were made by the special committees for each of these branches. For the fencing competitions, which were held in the lawn-tennis pavilion at the Östermalm Athletic Grounds, in the immediate neighbourhood of the Stadium, the provision was made that, in the case of help being required, those in charge could apply to the medical staff on duty at the Stadium, which would be in readiness, in the event of a severe case of illness or an accident occurring during the course of the competitions at the scene of the fencing in the lawn-tennis pavilion, to give assistance there too. For the horse riding competitions, which took place on July 16 and 17, after the conclusion of the competitions in athletics at the Stadium, the medical men and their staff who had been on duty at this place, stayed there until the conclusion of these events as well.

A. THE COMPETITIONS IN THE STADIUM.

I. The organization of the medical staff.

The following doctors, who had been chosen by the Committee for Athletics, attended for the purpose of giving any necessary medical aid at the competitions that took place at the Stadium from the 6:th to the 15:th July, and on July 16:th and 17:th, as well as during the fencing competitions:

FRIES, K. A. E., surgeon-lieutenant, Army Medical Corps Reserve; assistant physician at the Garrison Hospital, Stockholm;

JOSEFSON, A. R., lecturer on internal diseases at the Carolean Institute;

LEVIN, E. I., lecturer in bacteriology at the Carolean Institute;

NICKLASSON, G. W., assistant physician at the Stockholm Union Infirmary;

NYSTRÖM, E. G., lecturer in surgery at the Carolean Institute;

WAHLSTEDT, A. J. G., surgeon-captain, attached to the Royal Field Telegraph Corps; assistant at the Public Medical Institution;

ÅHMAN, C. G., surgeon-captain, Army Medical Corps Reserve; in practice at Gothenburg.

The Queen Sophia Association placed trained members of the Stockholm Volunteer Aid Corps at the disposal of the medical staff at the Stadium, for the purpose of rendering assistance there, and there were also present two Sisters from the Swedish Nursing "Red Cross" Association, for the purpose of giving aid in the case of any of the public being attacked by illness. After application to the proper quarters, the doctors, nurses and members of the Voluntary Medical Aid Columns were granted permission to wear, while on duty during the Olympic Games, the white arm-band with the Geneva Cross, which is known throughout the civilized world.

A little room on the ground floor of the Stadium, with direct communication with the stands and the principal entrance, was placed at the disposal of the doctors for the purpose of operations, the dressing of injured limbs, etc. There was direct Riks-telephone communication with this room. In addition to this, there were two rooms on the second floor, with an entrance from the staircase in the north-west tower, which were used as store-rooms for appliances which it was not necessary always to have at hand in the doctors' room. These rooms were also intended to be used as reserve sick-rooms, and were used on one occasion, when a bed was made there for a boy-scout who had been attacked in the Stadium with acute gastritis and who was not able to return at once to the boy-scout camp in Djurgården Park.

The Stille-Werner Co. Ltd. had placed all necessary medical and surgical appliances, and other articles for the care of the sick, at the disposal of the doctors on duty at the Stadium competitions. In this way, the operation-room at the Stadium, from the beginning of the Games, was so well furnished that, had there been any necessity, very serious cases could very well have been treated there. The Volunteer Aid Corps, the "Red Cross" and the Army Medical Department had sent blankets and other requisites for two beds, the necessary linen, bandages, ambulance litters and other appliances.

The work of the medical staff at the Stadium during the competitions was organized in the following way. At the times when the competitions were going on, there were always present at least 2 doctors, 5 attendants and 2 sick-nurses. Of the doctors, one was always in the arena, as a rule in the vicinity of the place where such a competition was going on as gave reason to suppose that an acci-

dent might happen to a competitor or an official. It was the duty of this doctor to be always at hand in the event of an accident, or a case of sickness of any kind, occurring among those present in the arena. The other doctors on duty were stationed either in the operation-room or on the balcony above, where two seats with a good view both of the arena and of the stands were always reserved for the doctors on duty. The nurses too, were on the same balcony, when they were not on duty in the operation-room, and two of the sick-attendants also had seats there. Another attendant was placed as an outlook on the balcony from which the flags of the winning nations were hoisted on the flag-staffs. If he observed anything that he thought required the attention of any of the medical staff, he communicated by telephone with the operation-room. One attendant was stationed at the gate admitting to the arena, in front of the west grand entrance. His task was to be at hand if his aid should be required by the doctor on duty in the arena. The remaining attendant had always to be either inside, or in the immediate neighbourhood of, the operation-room. All these attendants were instructed to pay very careful attention to everything that took place in the arena or in the stands, which could be easily seen from the spots where they were stationed. By this means, any accident or case of illness, not only among the competitors and officials, but also among the public, could easily be observed and reported with the least possible loss of time to that doctor that was nearest. At the same time, however, these attendants, especially those on the balcony, had to have their attention directed on the doctor or doctors that happened to be in the arena. These latter, by means of a specially arranged system of signalling could, in case of necessity, call one or two attendants either with or without a supply of bandages or an ambulance-litter.

II. Medical Aid given in the Stadium.

During the period when the competitions were going on in the Stadium, there were treated altogether by the medical staff on duty there, 149 cases, of which 132 were men and 17 women. From the following tables may be seen the nationality of these persons, the branches of athletics represented and the officials treated, together with the character of the complaints and injuries. Tables No 1 & 2 embrace the men; Nos. 3 & 4, the women, treated.

The two cases of sunstroke which occurred during the Marathon race are not included in the tables, as both the men were taken direct to the Royal Seraphim Hospital and, consequently, were not treated at all at the Stadium. These two cases will be treated of later on.

A few remarks may be made respecting a couple of the cases treated.

During one of the football matches, a Danish player happened to fall and put his elbow out of joint. On examination it was found that the upper ends of both the ulna and the radius were displaced backwards and outwards (*luxatio cubiti posterior et lateralis*). The injured

Table I. Nationality of the Men Patients.

Nation	Branch of Athletics, or Office												Total		
	Officials at competitions	Gymnasts	Runners	Jumpers	Throwers	All-round men (Mod. Pentathlon)	Wrestlers	Football players	Cyclists	Fencers	Riders	Boy Scouts		Police, attendants and workmen	Men among the public
Austria	—	—	—	—	—	—	3	—	—	—	—	—	—	—	3
Canada	—	—	—	1	—	—	—	—	1	—	—	—	—	—	2
Denmark	—	1	3	—	—	—	8	2	3	—	—	—	—	—	17
Finland	—	1	1	—	—	—	14	—	—	—	—	—	—	—	16
France	—	—	3	—	—	—	1	—	2	—	1	—	—	—	7
Germany	—	—	3	—	—	—	9	—	2	2	—	—	—	1	17
Great Britain	—	—	4	—	—	—	—	—	2	—	—	—	—	1	7
Greece	—	—	1	—	—	—	—	—	—	—	—	—	—	—	1
Holland	—	1	—	—	—	—	—	—	—	—	—	—	—	—	1
Hungary	—	—	—	—	—	—	4	—	—	—	—	—	—	—	4
Italy	—	1	—	—	—	—	3	—	—	—	—	—	—	—	4
Luxemburg	—	—	—	—	—	1	—	—	—	—	—	—	—	—	1
Norway	—	1	—	—	—	—	2	—	—	—	—	—	—	—	3
Russia	—	—	—	—	—	—	2	—	—	—	1	—	—	—	3
Sweden	4	—	3	2	2	—	13	—	—	—	—	5	7	2	38
Turkey.....	—	—	2	—	—	—	—	—	—	—	—	—	—	—	2
U. S. A.	—	—	2	—	—	—	1	—	2	—	—	—	—	1	6
Total	4	5	22	3	2	1	60	2	12	2	2	5	7	5	132

Table II. Complaints and bodily injuries of the Men Patients.

Name of the complaints and bodily injuries	Branch of Athletics, or Office												Total		
	Officials at competitions	Gymnasts	Runners	Jumpers	Throwers	All-round men (Mod. Pentathlon)	Wrestlers	Football players	Cyclists	Fencers	Riders	Boy scouts		Police, attendants and workmen	Men among the public
Fainting (Syncope)	—	—	—	—	—	—	—	—	—	—	—	1	1	1	3
Epilepsy (Epilepsia)	—	—	1	—	—	—	—	—	—	—	—	—	—	—	1
Acute enlargement of the heart (Dilatatio cordis acuta) ..	—	—	1	—	—	—	—	—	—	—	—	—	—	—	1
Inflammation of the veins (Phlebitis)	—	—	—	—	—	—	1	—	—	—	—	—	—	—	1
Bleeding at the nose (Epistaxis)	—	—	—	—	—	—	1	—	—	—	—	—	—	1	2
Acute bronchitis (Bronchitis acuta)	—	—	—	—	—	1	1	—	—	—	—	—	—	—	2
Sore throat (Angina tonsillaris)	—	—	1	—	—	—	—	—	—	—	—	—	—	1	2
Acute gastric catarrh (Gastritis acuta)	—	—	—	—	—	—	—	—	—	—	1	—	—	—	1
Acute intestinal catarrh (Enteritis acuta)	1	—	—	—	—	—	—	—	—	—	—	—	—	—	1
Carried forward	1	—	3	—	—	1	3	—	—	—	—	2	1	3	14

Name of the complaints and bodily injuries	Branch of Athletics, or Office												Total		
	Officials at competitions	Gymnasts	Runners	Jumpers	Throwers	All round men (Mod. Pentathlon)	Wrestlers	Football players	Cyclists	Fencers	Riders	Boy scouts		Police, attendants and workmen	Men among the public
Brought forward	1	—	3	—	—	1	3	—	—	—	—	2	1	3	14
Toothache (Odontalgia)	—	—	1	—	—	—	1	—	—	—	—	—	—	—	2
Acute inflammation of the joints (Arthritis Hydrops)	—	1	1	—	—	—	—	—	—	—	—	—	—	—	2
Sunburn (Erythema Solare)	—	—	—	—	—	—	4	—	—	—	—	—	—	—	4
Shingles (Herpes zoster)	1	—	—	—	—	—	—	—	—	—	—	—	—	—	1
Sore on the horny membrane of the eye (Ulcus comæ)	—	1	—	—	—	—	—	—	—	—	—	—	—	—	1
Abscess (Abscessus)	—	—	—	—	—	—	1	—	—	1	—	—	—	—	2
Boil (Carbunculus)	—	—	—	—	—	—	1	—	—	—	—	1	—	—	2
Cyst on sebaceous gland (Atheroma infectum)	—	1	—	—	—	—	—	—	—	—	—	—	—	—	1
Sting of insect (Morsus insect.)	—	—	—	—	—	—	—	—	—	—	—	—	1	—	1
Fracture (fracturæ) of collar-bone (fr. claviculæ)	—	—	—	—	—	—	1	—	—	—	—	—	—	—	1
Fracture of ribs (fr. costarum)	—	—	—	—	—	—	5	—	—	—	—	—	—	—	5
Broken fibula (fr. fibulæ)	—	—	1	—	—	—	—	—	—	—	—	—	—	—	1
Dislocation of elbow joint (Lux. cubiti)	—	—	—	—	—	—	—	1	—	—	—	—	—	—	1
Dislocation of the collar-bone (Sublux. claviculæ)	—	—	—	—	—	—	—	—	—	1	—	—	—	—	1
Ankle sprain (Distorsio pedis)	—	—	—	—	—	—	—	—	—	—	—	—	1	—	1
Rupture of muscle (Ruptura muscularis)	—	—	4	1	—	—	3	—	—	—	—	1	—	—	9
Strain (Distorsio tendinum)	—	—	1	1	—	—	1	—	—	—	—	—	—	—	3
Concussion of the brain (Commotio cerebri)	—	—	—	—	—	—	—	—	—	1	—	—	—	—	1
Thrombus (Hæmatoma)	—	1	—	—	—	—	1	—	—	—	—	—	—	—	2
Contusion (Contusio)	1	—	—	1	1	—	13	1	7	—	—	2	—	—	26
Bruise (Vulnera contusa)	1	1	1	—	—	—	6	5	1	—	1	—	—	—	16
Cut (Vulnera incisa)	—	—	1	—	—	—	—	—	—	—	1	1	—	—	3
Graze (Vulnera trita, v. contusa)	—	—	3	1	—	—	18	—	—	—	1	1	—	—	24
Foot-gall (Vulnera trita pedum)	—	—	5	—	—	—	1	—	—	—	—	—	—	—	6
Foreign body (Corpus alienum)	—	—	—	—	—	—	1	—	—	—	—	—	—	—	1
For. body in the eye (Corp. alien. oculi)	—	1	—	—	—	—	—	—	—	—	—	—	—	—	1
Total	4	5	22	3	2	1	60	2	12	2	2	5	7	5	132

Table III. Nationality of the Women Patients.

Nation	Branch of Athletics, or Office			
	Gymnasts	Women officials and Attendants	Women from among the public	Total
Finland	1	—	—	1
Sweden	1	3	12	16
Total	2	3	12	17

Table IV. Complaints and injuries of the Women Patients.

Name of the complaints and injuries	Branch of Athletics, or Office			
	Gymnasts	Women Officials and Attendants	Women from among the public	Total
Fainting (Syncope)	1	—	6	7
Hysteria (Hysteria)	—	—	1	1
Bleeding at the nose (Epistaxis)	—	—	1	1
Toothache (Odontalgia)	—	1	—	1
Wound caused by hat-pin (Vulnus)	1	—	—	1
Contusion (Contusiones)	—	—	2	2
Bruise (Vulnera contusa)... ..	—	—	1	1
Foreign body (Corpus alienum)	—	1	—	1
Foreign body in the eye (Corpus alien. oculi)	—	1	1	2
Total	2	3	12	17

man was taken to the operation-room where the elbow was put into joint again, the patient being under the influence of ether.

This was the first case that had to be treated in the operation-room, and it was, too, the only instance during the whole of the Olympic Games, when it was found necessary to perform an operation while the patient was under the influence of an anaesthetic. During the Stadium week proper, between the 6 and 15 July, there was not a single serious accident in the Stadium. This very satisfactory state of things is to be ascribed, in no small degree, to the excellent arrangements made there, by means of which every measure had been taken on the part of the management in order to avoid accidents of any kind.

A Russian officer, a competitor in the individual competition in prize-jumping, happened, after having cleared the obstacles very cleverly, to fall with his horse at the last one, the wide ditch. He was up in his saddle again at once, and rode out of the Stadium as if nothing serious had happened, but, as he went at a walk along the road outside the Stadium on the way to the saddling place, he was suddenly seen to fall from his saddle to the ground. He was carried to the operation room, where the doctors immediately took him in hand. On an examination, which was at once made, nothing else could be observed than a concussion of the brain, which, however,

was not of a very serious nature, so that, after suitable treatment, he regained consciousness in a comparatively short time. He complained, however, of great tenderness to pressure on the left side of the upper part of the abdomen (over regio hypochondrica sin.), and as this symptom seemed gradually to increase, it was suspected that there was some internal injury to one of the abdominal organs, probably the spleen. In order that a surgical operation might be performed in good time in the event of its being necessary, the injured man was conveyed in an ambulance carriage to the "Red Cross" Hospital where, during the next 24 hours, careful attention was paid to his case. The symptoms vanished by degrees, however, so that, after a stay of 2 days at the hospital, he was able to leave the establishment fully cured, without any operation having been required.

The lists of the cases of illness treated as shown in tables Nos. 2 and 4, show a great diversity of internal and external complaints, with exterior injuries, most of them of a very slight description. Of the 5 cases of broken ribs that were treated, 3 of them were merely infractions of one or several ribs, without any break in the continuity of the bone in question. The diagnosis was made supported by the intense tenderness to pressure experienced by the sufferers at a certain part of the ribs.

It is, of course, self-evident that a number of cases of illness would occur during a period of 10 days amongst such a great number of people as the competitors and officials amounted to, and, as is shown by the above tables, the competitors and the other persons who had business of one kind or another inside the Stadium made very full use of the medical aid that could be had there, even for such affections as had nothing to do with the competitions nor had arisen while the patients were inside the Stadium. On the other hand, it proved that the number of cases of illness or accidents amongst the very numerous public in the stands at the Stadium was far less than had been expected. Thus, among the public, there were only 7 cases of fainting, in spite of the intense heat that prevailed during the Stadium week. Care had been taken, however, that plenty of fresh water could easily be had in all the stands, while the scout-boys posted there, were always ready, active and obliging as they were, to fetch water whenever it was required.

III. The Marathon Race.

The medical examination of the competitors in the Marathon race had taken place the day before the event came off. In every case, the competitor's heart was examined most carefully and, if there was any possible reason for doing so, the examination was extended to other organs as well. Most of the Swedish doctors on duty at the Stadium took part in the examination. Many foreign doctors were also present, for longer or shorter periods, during the examination. Not one of the competitors was found to be in such a condition that his abstention from the race was considered necessary.

The most comprehensive measures of security were taken along the whole of the course, so that medical help could always be had close at hand, in the case of any accident or illness occurring amongst the competitors during this trying event. Medical stations were arranged at Sollentuna, Tureberg, Silfverdal, Stocksund and Söderbrunn. At each of these stations there was a physician with his assistant, and a group of from 2—5 men belonging to the Stockholm Volunteer Aid Corps. At all of these stations, with the exception of that at Söderbrunn, there were arranged sick-rooms with beds; at Söderbrunn, which lies scarcely $1\frac{1}{4}$ mile from Stockholm, there was a sick-tent. At all the medical stations there were ambulance litters, bandages, instruments for giving injections, a motor-car, and stimulants, such as camphor, digalén, etc. At the control stations — Tureberg and Stocksund — and at Silfverdal and at the turn, sterilized drinking water, and refreshments (tea, coffee, lemons and oranges) were provided for the competitors. At the turning point (in the neighbourhood of Sollentuna) there was a doctor with assistants, the station being provided with a motor-car, ambulance-litters, etc., as at the other medical stations. At 9 different places along the course there were patrols of boy-scouts, provided with flags for signalling and with drinking-flasks containing fresh water. Certain of these patrols had cyclists among their number. In the motor car carrying the leader of the competition there was a doctor, provided with an injection case, stimulants and bandages, etc. At the Stadium, on Marathon day, there were 6 doctors, of whom one was stationed at the entrance to the Stadium, two at the winning post, and three in the operation room or in the seats reserved for the medical men on the balcony over the western grand entrance. In addition to the sick-attendants usually on duty, there were 10 extra men (belonging to the Volunteer Aid Corps) posted at different places inside the Stadium. In all, there were 11 doctors, 7 medical assistants, 30 sick-attendants and 2 sick-nurses on duty on Marathon day, in the Stadium and along the course.

To the best of our knowledge, there has never before been a Marathon race so minutely arranged, nor with so many imaginable measures taken with such great care for the purpose of assisting the competitors who might be in need of help. But, in spite of all this the Marathon race of Stockholm, on July 14, 1912, was to cost a human life.

All the competitors that passed the tape came in in perfect condition. But, on the other hand, a great number of the runners, while still on the course, had to be taken up by motor cars sent out from the medical stations. The sick-rooms arranged at these stations soon became crowded with men who had retired from the race, and who now, absolutely worn out, sought for rest and quiet.

At the hill at Öfver-Järfva, a Portuguese athlete, Francesco Lazaro, on the return journey to the Stadium, had been seen to stagger as he ran, fall a couple of times, rise again and continue the race, only finally to fall and remain lying on the ground. Almost immediately after

this had happened, he was taken in hand by a Swedish physician, Dr C. R. Torell, who happened to be on the spot. A few minutes later, Dr G. Liljenroth, the physician on duty at the medical station at Silfverdal, came to the place, followed in a short time by Dr K. A. Fries, the medical man who was in the motor-car driven by the leader of the competition. The proper measures had at once been begun in order to restore Lazaro to consciousness, but without any result, and the matter was reported to the Stadium by means of the telephone. As the steps which were taken to recall the sick man to his senses, still seemed to be without result, he was placed in one of the motor cars at the disposal of the doctors and carried to the Royal Seraphim Hospital, whither he was accompanied by Dr Fries. He arrived at the hospital about 5,30 p. m. On his arrival there he was still senseless, had violent attacks of cramp and convulsions of the whole body, and became delirious; his temperature was 41.2° Cent. (106° Fah.), and all the symptoms pointed to sunstroke. Dr Arnold Josefson, lecturer on internal medicine, who, during the summer, was temporarily chief physician at the clinical surgery of the hospital infirmary, went, as soon as the news of Lazaro's illness reached him, to the hospital from the medical station at Stocksund where he had been on duty during the Marathon Race. As soon as he had examined the patient, Dr Josefson saw that the case was a very serious one and that it would probably prove fatal. The treatment of the invalid was continued without a moment's intermission, and with the greatest attention, but it was impossible to save Lazaros' life, and he died at 6 a. m., the following day, July 15.

The post-mortem examination was carried out by Dr Folke Henschen, experimenter pro tem., and the clinical diagnosis was fully confirmed by the examination.

A Bohemian competitor who, it was stated, was found lying senseless on the road, was taken in a motor car to the medical station at Stocksund. On his arrival there he was found to be suffering from giddiness; his pulse was slow, and he complained of an insufferable headache. Continuous treatment with cold appliances gradually brought him to his senses, but Dr Josefson thought it wisest to take him to the Royal Seraphim Hospital, which he left the following day, however, quite restored. This was, most certainly, another case of sunstroke.

Two other competitors in the Marathon race came to the medical station at Stocksund, complaining of a severe headache, both of them being among the youngest of the competitors. One of them, who was led to the station by a boy-scout, suffered somewhat from giddiness as well as from headache. There is a possibility that both of these cases, too, were sunstroke.

A couple of days after the Marathon race, the 7 doctors who had been on duty at the Stadium competitions, sent in a document to the International Olympic Committee with reference to Lazaro's death, stating that, if it is thought that the Marathon race in its present form ought to be retained on the programme of the Games in future Olym-

piads, it ought to be run during the coolest part of the day. The doctors on duty at the Games were of the unanimous opinion that the Marathon race, as an athletic feat, is not of such value as to counter-balance the risk that attends it.

B. THE CYCLING ROAD RACE ROUND LAKE MÄLAR.

The medical examination of the competitors in the cycling race round Lake Mälär, took place on July 6 at midday, in one of the rooms of the Engelbrekt primary school, Valhallavägen. As, however, a number of the competitors were not present at the examination, Drs E. Levin and K. A. Fries went to the start at Liljeholmen and there examined those competitors who had not previously been seen by the doctors.

An accident that could easily have been a most serious one, happened to a Swedish cyclist, K. J. Landsberg, who, immediately after starting, at 5 a. m. on July 7, came into a collision with a carelessly driven motor car and fell. He was at once carried back in the car to the starting place, where the examination that was at once made showed that he was suffering from a slight concussion of the brain and that he had also received several somewhat severe contusions. After the injured man had been temporarily bandaged and had been given an injection of morphine, he was taken in an ambulance carriage to St. Mary's hospital, which he left a week afterwards, quite restored to health.

After having completed the race, a number of the cyclists were treated at the doctor's room in the Stadium for contusions and other slight injuries, got by falling or other accidents on the way. A report of these is given elsewhere together with that respecting the work of the doctors at the Stadium. Apart from these unimportant injuries, all the competitors that completed the course passed the tape in perfect condition.

C. THE ROWING COMPETITIONS.

The measures for giving medical aid at the rowing competitions of the Olympic Games were entrusted to Dr Gustaf Wigh, surgeon-captain, attached to the Royal Uppland Infantry.

The competitors in the rowing matches were all young men, 18—24 years of age, well built and well developed. When half the period of training was over, the competitors in the Swedish teams were examined by Dr Wigh, when their condition in every respect was found satisfactory in the case of all but one man, who was discovered to have a somewhat irregular action of the heart, with the cardiac murmurs not quite distinct. The same man was examined again after another fortnight's training, and was then found to be plainly suffering from enlargement of the heart, with irregular action of the heart, and albumin in the urine. He was advised to leave off training at once and take a thorough rest, the result of which was, that after little more than a week, he was free from these symptoms and felt quite well again.

Dr. Wigh's assistance was not once asked for by any of the foreign competitors in the rowing matches, neither did there occur anything during the matches themselves that necessitated his interference.

Dr. Wigh points out that all the rowers, after ceasing rowing on reaching the winning post, showed signs of excessive exhaustion, sometimes in a most alarming degree. All of the men, however recovered from this in an astonishingly short time. Dr. Wigh considers it indisputable, however, that the presence of a medical man at rowing matches is most desirable, as there always exists a possibility of this exhaustion taking a dangerous form.

D. THE SWIMMING COMPETITIONS.

The medical arrangements at the swimming competitions of the Olympic Games were in the hands of Drs. K. A. Fries, A. Franzén and N. Granér. A doctor's room had been specially arranged as near to the swimming course as possible, and one medical man at least, and, as a rule, two, were constantly present at the Swimming Stadium when the competitions took place. Compared with the work of the physicians and the rest of the medical staff at the Stadium proper, the doctors at the swimming competitions had but little to do. The cases treated were few in number and of little interest. Narrow escapes from somewhat serious accidents were not wanting, however, so that the constant presence of the doctors at the swimming competitions need by no means be considered as an exaggerated measure of precaution.

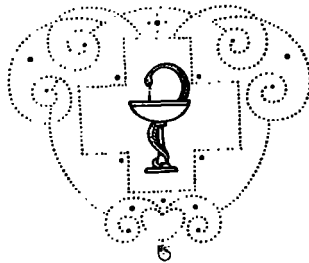

**STATISTICS, LIST OF OFFI=
CIALS AND COMPETITORS.**

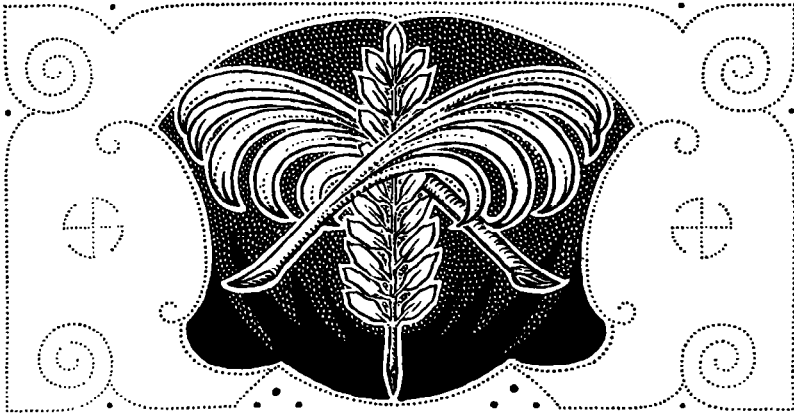

THE OLYMPIC GAMES OF TO-DAY.

A SHORT REVIEW.



he wave of interest in, and appreciation of, physical culture and hygiene which, towards the close of the 19:th century, swept over the whole of Europe, found a perfectly logical expression in the establishment of the modern Olympic Games. In nearly every country of the civilized world, clear-sighted patriots directed their endeavours towards the employment of physical exercises as a means of elevating the vitality and the capacity for work of the individual, and, thereby, of the entire nation. What, then, was more natural than that, after antiquarian zeal and study had shed their light on the classic Olympic Games and their influence on the culture of their times, the world should unite in a desire to revive these Games which, in all truth, form a worthy example of the steps that should be taken to train mankind to-day to manliness and strength.

It is France and a Frenchman that have the honour of originating this thought. It was Baron Pierre de Coubertin who, in the spring of 1893, made the first proposal to re-establish the Olympic Games and, on his initiative, representatives of the athletic organizations of various countries assembled on the 16 July, 1894, in the Grand Hall of the Sorbonne University, in Paris. The meeting discussed the possibility of instituting the Games, and the greatest interest was displayed in every quarter. The International Olympic Committee was formed at this initial meeting, and was entrusted with the task of arranging Olympic Games at regular intervals, and at various places in the civilized world.

It must be acknowledged, however, that the Anglo-Saxon race had specially and most thoroughly prepared the way for these modern Olympic Games, for, long before their establishment, the athletic life of England had been taken as the model on which most other nations fashioned theirs.

Classic soil was chosen as the scene of the first modern Olympiad — an honour legitimately demanded by the home of the classic Olympic Games. Athens, in 1896, saw the first Olympic meeting of the athletics of the modern world; four years later the turn came to Paris. The third was held in St. Louis, in 1904; the fourth in London, 1908 and the fifth in Stockholm, in 1912. In Greece, a wish arose to have the permanent home of the Games in that country, and, as an expression of that desire, a special Olympic Committee organized Olympic Games in Athens, in 1906, intended to be repeated every fourth year, i. e., between the official, International Games. The International Olympic Committee, however, insists on the Games taking place at the proper interval, at different places in the civilized world.

The Olympiads hitherto held bear witness, by the interest they have excited among the athletes of the world and by the results hitherto attained, to the unheard-of, rapid development of the International athletic movement.

Athens 1896.

A great deal was done to publish to the world the holding of the first Modern Olympic Games in Athens in 1896, and quite a large number of competitors were entered — especially if judged by the then existing conditions, and the Games were, without doubt, the greatest athletic festival hitherto held in our times. The United States of America, especially, sent a very representative team which gained many brilliant victories, and Great Britain, too, was represented by some skilful athletes. France was victorious in the cycle races and in fencing; Germany easily won the gymnastic competition. Hungary's wreaths were gained by clever swimmers, and the names of other countries, too, can be found in the list of winners. Switzerland, Austria, Denmark, each took a prize in the shooting competitions. Sweden was victorious in the high jump, and Denmark in the weight-lifting competitions, while Greece itself won a brilliant victory in the Marathon Race.

The thoughts of carrying out the first modern Olympic Games on classic ground at Athens, was an exceedingly happy thought. It gave the Games a certain stamp, and the Greeks heartily appreciated the respect thus paid to their ancient glories, and showed an enthusiasm and an energy that were simply unique. Greece fulfilled with honour its task of arranging the first Modern Olympic Games.

Paris 1900.

The second Olympiad, in Paris, 1900, was somewhat quieter, for the French did not show all the interest in the Games that might have been expected. Not enough was done to attract the athletes of foreign nations to the competitions, and not so many were present as at Athens four years previously. A first class team from the U. S. A. took part in the Games however, and won nearly every competition.

St Louis 1904.

In consequence of the Olympic Games of 1904 taking place in one of the western states of the New World, the third Olympiad, too, did not enjoy the same international stamp as the Games of 1896,

as far as regards the number of competitors present, at least. Several European nations sent representatives, but most of the athletes taking part in the Games were from the U. S. A. It is stated that no less than 390 competitions were held, of which only 14 were won by others than representatives of the U. S. A.

Athens 1906.

At the Games of Paris and St Louis the mistake had been committed of holding the competitions through the course of an entire summer. In Athens, in 1906, on the other hand, they were given a very concentrated form, all the competitions taking place within the limit of 14 days, and an attempt had been made to so arrange the competitions that those wishing to do so could attend everyone of them, and so that, while a competition was going on in the Stadium, no other event should be held anywhere else. The rowing-, swimming-, shooting-, fencing-, lawn tennis-, and football competitions, however, had to be arranged at various places within and outside the city.

The Athenian meeting of 1906 had that festive stamp which, among all the modern Games hitherto held, had marked none but those celebrated at the capital of Greece; ten years before. It was estimated that, during the Games, the ordinary population of Athens was increased by 100,000 souls, the total number of foreigners being about 40,000. The Stadium, which can contain 50,000 spectators, was occupied to the last place, and outside the doors stood tens of thousands of persons, wishing, but unable, to obtain admission. These Games of Athens mark the beginning of the outburst of enthusiasm for the athletic movement which found such perfect expression in the Games of London, in 1908, and of Stockholm, in 1912.

The order of merit in the field and track events, as decided by the number of prizes won at the Games of Athens, in 1906 was:

U. S. A., 21; Sweden, 11; Great Britain, 9; Greece, 4; Hungary, 4; Australia, 2; Canada, 2; Germany 2; Belgium 1; Finland, 1; France 1.

London 1908.

The Fourth Olympiad, held in London in 1908, embraced 109 competitions, divided into two classes: "Summer Sports and Winter Sports".

These Games showed an enormous increase in the number of active competitors, no less than 2,666 athletes taking part in the various events; 2,184 in the summer competitions, and 482 in the winter sports, these numbers representing 22 nations.

The best ten nations in the Fourth Olympiad were: Great Britain, 13 $\frac{1}{6}$; U. S. A., 44 $\frac{1}{3}$; Sweden, 23 $\frac{1}{3}$; France, 16 $\frac{1}{3}$; Canada, 12 $\frac{1}{3}$; Germany, 9 $\frac{1}{2}$; Hungary 7 $\frac{1}{3}$; Norway, 8; Italy, 4; Belgium 6 points.

It is now impossible to obtain complete lists of results of the preceding Olympiads, so that, for the sake of comparison, the following table of results obtained at previous Olympic Games includes merely field and track events (pure athletics), and the competitions most nearly allied to them, and of which reliable lists of results still exist, while a second table is appended, giving the present Olympic Records.

Results obtained in the preceding Olympic Games in the so-called "Stadium=events".

Competition	Athens 1896		Paris 1900		St Louis 1904.		London 1908.		Athens 1906.	
60 m. Flat	— —	—	Kraenzlein, U. S. A.	7 s.	Hahn, U. S. A.	7 s.	— —	—	— —	—
100 » »	Burke, U. S. A.	12 s.	Jarvis, »	10.8 s.	Hahn, »	11 s.	Walker, South Afr.	10.8 s.	Hahn, U. S. A.	11.2 s.
200 » »	— —	—	Tewksbury, »	22.2 s.	Hahn, »	21.6 s.	Kerr, Canada	22.4 s.	— —	—
400 » »	Burke, U. S. A.	54.2 s.	Long, »	49.4 s.	Hillman, »	49.2 s.	Halswell, G. Britain	50 s.	Pilgrim, U. S. A.	53.2 s.
800 » »	Flack, G. Britain	2 m. 11 s.	Tysoe, G. Britain	2 m. 1.4 s.	Lightbody, »	1 m. 56 s.	Sheppard, U. S. A.	1 m. 52.8 s.	Pilgrim, »	2 m. 1.2 s.
1,500 » »	Flack, »	4 m. 33.2 s.	Bennet, »	4 m. 6 s.	Lightbody, »	4 m. 5.4 s.	Sheppard, »	4 m. 03.4 s.	Lightbody »	4 m. 12 s.
Hurdle race 110 m.	Curtis, U. S. A.	17.6 s.	Kraenzlein, U. S. A.	15.4 s.	Schule, »	16 s.	Smithson, »	15 s.	Leavitt, »	16.2 s.
» 200 m.	— —	—	Kraenzlein, »	25.4 s.	Hillman, »	24.6 s.	— —	—	— —	—
» 400 m.	— —	—	Tewksbury, »	57.6 s.	Hillman, »	53 s.	Bacon, U. S. A.	55 s.	— —	—
Steeple-chase 2,500 m.	— —	—	Orton, »	7 m. 34 s.	Lightbody »	7 m. 39.6 s.	— —	—	— —	—
» 3,200 »	— —	—	— —	—	— —	—	Russel, G. Britain.	10 m. 47.8 s.	— —	—
» 4,000 »	— —	—	Rimmer, G. Britain	12 m. 5 s.	— —	—	— —	—	— —	—
Marathon race	Louis. Greece.	2h. 55 m. 20 s.	Teato, France	2h. 59 m.	Hicks, U. S. A.	3 h. 28 m. 53 s.	Hayes, U. S. A.	2h 55 m. 18 4 s	Sherring, Canada	2h. 51 m. 23 6 s.
Broad jump	Clark, U. S. A.	634 cm.	Kraenzlein, U. S. A.	718 cm.	Prinstein, »	735 cm.	Irons, »	748 cm.	Prinstein, U. S. A.	720 cm.
High jump	Clark, »	181.2 cm.	Baxter, »	190 cm.	Jones, »	180 cm.	Porter, »	190 cm.	Leahy, G. Britain	177.5 cm.
Hop, step and jump	Conolly, G. Britain	13.73 m.	Prinstein, »	14.47 m.	Prinstein, »	14.34 m.	Ahearne, G. Britain	14.92 m.	O'Connor, »	14.075 m.
Standing broad jump	— —	—	Ewry, »	3.22 m.	Ewry, »	3.47 m.	Ewry, U. S. A.	3.33 m.	Ewry, U. S. A.	330 cm.
» high »	— —	—	Ewry, »	1.65 m.	Ewry, »	1.497 m.	Ewry, »	1.57 m.	Ewry, »	12.325 m.
» hop, step and jump ...	— —	—	Ewry, »	10.578 m.	Ewry, »	10.546 m.	— —	—	— —	—
Pole jump.	Hoyt, U. S. A.	330 cm.	Baxter, »	330 cm.	Dvorak, »	350 cm.	Gilbert, U. S. A.	3.71 m.	Gonder, France	350 cm.
Putting the weight	Garret, »	11.49 m.	Sheldon, »	14.10 m.	Rose, »	14.80 m.	Rose, »	14.20 m.	Sheridan, U. S. A.	12.325 m.
Throwing the discus	Garret, »	29.15 m.	Baur, Hungary	36.04 m.	Sheridan, »	39.30 m.	Sheridan, »	37.99 m.	Sheridan, »	41.46 m.
» » » , Greek style	— —	—	— —	—	— —	—	— —	—	Jaervinen, Finland	35.17 m.
Throwing the hammer	— —	—	Flanagan, U. S. A.	50.90 m.	Flanagan, U. S. A.	51 23 m.	Flanagan, U. S. A.	51.915 m.	— —	—
» » weight (56 lb) ...	— —	—	— —	—	Desmarteau, Canada	10.45 m.	— —	—	— —	—
Weight lifting, one hand	Elliot, G. Britain	—	— —	—	Osthoff, »	70 kg.	— —	—	Steinbach, Austria	76.55 kg.
» » two hands	Jensen, Denmark	111 kg.	— —	—	Kakousis, Greece	112 »	— —	—	Toffalos, Greece	142.08 »
Tug-of-War	— —	—	— —	—	Milwaukee, U. S. A.	—	Great Britain	—	Germany	—
Team race	— —	—	— —	—	New York A. C., U. S. A.	—	Great Britain	—	— —	—
5 Engl. miles Flat.....	— —	—	— —	—	— —	—	— —	—	Hawtrey, G. Britain	26.26.2
Throwing the stone	— —	—	— —	—	— —	—	— —	—	Georgantas, Greece	19.94 m.
Throwing javelin, held in middle	— —	—	— —	—	— —	—	Lemming, Sweden	54.82 m.	Lemming, Sweden	53.90 m.
» » free style	— —	—	— —	—	— —	—	Lemming, »	54.43 m.	— —	—
Pentathlon	— —	—	— —	—	— —	—	— —	—	Mellander, Sweden	24 p.
Walking race 1,500 m.	— —	—	— —	—	— —	—	— —	—	Bonbag, U. S. A.	7 m. 12.6 s.

OLYMPIC RECORDS.

Competition	Holder	Record	Made at the Olympic Games of
Athletics.			
100 metres Flat	D.F.Lippincott, U.S.A.	10 ³ / ₅ s.	Stockholm 1912.
200 » »	A. Hahn, U. S. A. ...	21 ⁸ / ₅ s.	St. Louis 1904.
400 » »	C. D. Reidpath, U.S.A.	48 ¹ / ₅ s.	Stockholm 1912.
800 » »	J. E. Meredith, U.S.A.	1 m. 51 ⁹ / ₁₀ s.	» 1912.
1,500 » »	A. N. S. Jackson, Great Britain	3 m. 56 ⁴ / ₅ s.	» 1912.
3,000 » »	H. Kolehmainen, Finland	8 m. 36 ⁹ / ₁₀ s.	» 1912.
5,000 » »	H. Kolehmainen, Finland	14 m. 36 ³ / ₅ s.	» 1912.
5 miles Race	E. R. Voigt, Great Britain	25 m. 11 ¹ / ₅ s.	London 1908.
10,000 metres Flat	H. Kolehmainen, Finland	31 m. 20 ⁴ / ₅ s.	Stockholm 1908.
Marathon Race	K. K. Mc Arthur, Syd-Africa	2 h. 36 m. 54 ⁴ / ₅ s.	» 1912.
Hurdle Race 110 meters...	F. C. Smithson, U.S.A.	15 s.	London 1908.
Hurdle Race 200 » ...	H. L. Hillman, U. S. A.	24 ⁸ / ₅ s.	St. Louis 1904.
Hurdle Race 400 » ...	H. L. Hillman, U. S. A.	53 s.	» 1904.
Walking Race 3,500 met.	G. E. Lamer, Great Britain	14 m. 55 s.	London 1908.
Walking Race 10,000 »	G.H.Goulding, Canada	46 m. 28 ² / ₅ s.	Stockholm 1908.
Walking Race 10 miles...	G. E. Lamer, Great Britain	1 h. 15 m. 57 ² / ₅ s.	London 1908.
Running High Jump	A.W. Richards, U.S.A.	193 cm.	Stockholm 1912.
Standing High Jump	R. C. Ewry, U.S. A....	165 »	Paris 1900.
Running Broad Jump.....	A.L. Gutterson, U.S.A.	760 »	Stockholm 1912.
Standing Broad Jump.....	R. C. Ewry, U.S. A....	348 »	St. Louis 1904.
Hop, Step and Jump	T. J. Ahearne, Great Britain	14,92 mtr.	London 1908.
Pole Jump	H. S. Babcock, U.S.A.	395 cm.	Stockholm 1912.
Throwing the Javelin, b. h.	J. Saaristo, Finland ...	61 mtr.	» 1912.
Throwing the Javelin. r. & l. h.	J. Saaristo, Finland ...	61 + 48,42 = 109,42 mtr.	» 1912.
Throwing the Discus, b. h.	A. R. Taipale, Finland	45,22 mtr.	» 1912.
Throwing the Discus, r. & l. h.	A. R. Taipale, Finland	44,68 + 38,18 = 82,86 mtr.	» 1912.
Putting the Weight, b. h	P. Mc Donald, U. S. A.	15,34 mtr.	» 1912.
Putting the Weight, r. & l. h.	Ralph W. Rose, U.S.A.	15,23 + 12,47 = 27,70 mtr.	» 1912.
Throwing the Hammer ...	M. J. McGrath, U. S. A.	54,74 mtr.	» 1912.

Competition	Holder	Record	Made at the Olympic Games of
Relay Race, 400 metres, (4 x 100 m.).....	Germany	42 ³ / ₁₀ s.	Stockholm 1912.
Relay Race, 1,600 metres, (4 x 400 m.).....	U. S. A.	3 m. 16 ³ / ₅ s.	» 1912.
Relay Race, 1,600 metres, (200, 200, 400, 800 m.)	U. S. A.	3 m. 27 ¹ / ₅ s.	London 1908.
Swimming.			
100 metres, free style...	Duke P. Kahanamoku, U. S. A.	1 m. 2 ² / ₅ s.	Stockholm 1912.
100 » , back stroke	H. Hebner, U. S. A....	1 m. 20 ⁴ / ₅ s.	» 1912.
200 » , breast stroke	W. Bathe, Germany...	3 m. 1 ⁴ / ₅ s.	» 1912.
400 » , free style...	G.R. Hodgson, Canada	5 m. 24 ² / ₅ s.	» 1912.
400 » , breast stroke	W. Bathe, Germany...	6 m. 29 ³ / ₅ s.	» 1912.
1,500 » , free style ..	G.R. Hodgson, Canada	22 m.	» 1912.
Team Race, 800 metres, (4 x 200 m.).....	Australasia	10 m. 11 ¹ / ₆ s.	» 1912.
100 metres, free style, ladies	Fanny Durack, Austral- asia	1 m. 19 ⁴ / ₅ s.	» 1912.
Team Race, 400 metres, ladies (4 x 100 m.).....	Great Britain	5 m. 52 ⁴ / ₅ s.	» 1912.

**PRIZE=WINNERS AT THE OLYMPIC GAMES
OF STOCKHOLM, 1912.**

Field and Track Athletics.

100 m. Flat.

I. R. C. CRAIG	U. S. A.	10 ⁴ / ₅ s.
II. A. MEYER	U. S. A.	+ 60 cm.
III. D. F. LIPPINCOTT	U. S. A.	+ 15 cm.

200 m. Flat.

I. R. C. CRAIG	U. S. A.	21 ⁷ / ₁₀ s.
II. D. F. LIPPINCOTT	U. S. A.	21 ⁸ / ₁₀ »
III. W. R. APPLGARTH	Great Britain	+ hand s-br.

400 m. Flat.

I. C. D. REIDPATH	U. S. A.	48 ² / ₁₀ s.
II. H. BRAUN	Germany	48 ³ / ₁₀ »
III. E. F. J. LINDBERG	U. S. A.	48 ⁴ / ₁₀ »

800 m. Flat.

I. J. MEREDITH	U. S. A.	1 m. 51 ⁹ / ₁₀ s.
II. M. W. SHEPPARD	U. S. A.	1 » 52 »
III. I. N. DAVENPORT	U. S. A.	1 » 52 »

1,500 m. Flat.

I. A. N. S. JACKSON	Great Britain	3 m. 56 ⁸ / ₁₀ s.
II. A. R. KIVIAT	U. S. A.	3 » 56 ⁹ / ₁₀ »
III. N. S. TABER	U. S. A.	3 » 56 ⁹ / ₁₀ »

5,000 m. Flat.

I. H. KOLEHMAINEN	Finland	14 m. 36 ⁶ / ₁₀ s.
II. J. BOUIN	France	14 » 36 ⁷ / ₁₀ »
III. G. W. HUTSON	Great Britain	15 » 7 ⁶ / ₁₀ »

10,000 m. Flat.

I. H. KOLEHMAINEN	Finland	31 m. 20 ⁴ / ₅ s.
II. L. TEWANIMA	U. S. A.	32 » 6 ³ / ₅ »
III. A. STENROOS	Finland	32 » 21 ⁴ / ₅ »

Marathon Race 40,200 m.

I. K. K. MC ARTHUR	South Africa	2 h. 36 m. 54 ⁴ / ₅ s.
II. C. W. GITSHAM	South Africa	2 » 37 » 52 »
III. G. STROBINO	U. S. A.	2 » 38 » 42 ³ / ₅ »

Hurdle Race 110 m.

I. F. W. KELLY	U. S. A.	15 ¹ / ₁₀ s.
II. J. WENDELL	U. S. A.	15 ² / ₁₀ »
III. W. M. HAWKINS	U. S. A.	15 ⁸ / ₁₀ »

Walking Race 10,000 m.

I. G. H. GOULDING	Canada	46 m. 28 ⁴ / ₁₀ s.
II. E. J. WEBB	Great Britain	46 » 50 ⁴ / ₁₀ »
III. F. ALTIMANI	Italy	47 » 37 ⁶ / ₁₀ »

Running High Jump.

I. A. W. RICHARDS	U. S. A.	193 cm.
II. H. LIESCHE	Germany	191 »
III. G. L. HORINE	U. S. A.	189 »

Standing High Jump.

I. PLATT ADAMS	U. S. A.	163 cm.
II. BEN ADAMS	U. S. A.	160 »
III. C. TSICLITIRAS	Greece	155 »

Running Broad Jump.

I. A. L. GUTTERSON	U. S. A.	760 cm.
II. C. D. BRICKER	Canada	721 »
III. G. ÅBERG	Sweden	718 »

Standing Broad Jump.

I. C. TSICLITIRAS	Greece	337 cm.
II. PLATT ADAMS	U. S. A.	336 »
III. BEN ADAMS	U. S. A.	328 »

Hop, step and jump.

I. G. LINDBLOM	Sweden	14.76 m.
II. G. ÅBERG	Sweden	14.51 »
III. E. ALMLÖF	Sweden	14.17 »

Pole Jump.

I. H. S. BABCOCK	U. S. A.	395 cm.
II. FR. TH. NELSON	U. S. A.	385 »
II. M. S. WRIGHT	U. S. A.	385 »
III. F. D. MURPHY	U. S. A.	380 »
III. B. UGGLA	Sweden	380 »
III. W. HAPPENNY	Canada	380 »

Throwing the Javelin, best hand.

I. E. LEMMING	Sweden	60.64 m.
II. J. J. SAARISTO	Finland	58.66 »
III. M. KOVÁCS	Hungary	55.50 »

Throwing the Javelin, right and left hand.

I. J. J. SAARISTO	Finland	109.42 m.
II. W. SIIKANIEMI	Finland	101.13 »
III. U. PELTONEN	Finland	100.24 »

Throwing the Discus, best hand.

I. A. R. TAIPALE	Finland	45.21 m.
II. R. L. BYRD	U. S. A.	42.32 »
III. J. H. DUNCAN	U. S. A.	42.28 »

Throwing the Discus, right and left hand.

I. A. R. TAIPALE	Finland	82,86 m.
II. E. NIKLANDER	Finland	77,96 »
III. E. MAGNUSSON	Sweden.....	77,37 »

Putting the Weight, best hand.

I. P. Mc DONALD	U. S. A.	15,34 m.
II. R. W. ROSE	U. S. A.	15,25 »
III. L. A. WHITNEY.....	U. S. A.	13,93 »

Putting the Weight, right and left hand.

I. R. W. ROSE	U. S. A.	27,70 m.
II. P. Mc DONALD	U. S. A.	27,53 »
III. E. NIKLANDER	Finland	27,14 »

Throwing the Hammer.

I. M. J. McGRATH	U. S. A.	54,74 m.
II. D. GILLIS	Canada.....	48,39 »
III. C. CH. CHILDS	U. S. A.	48,17 »

Pentathlon.

I. F. R. BIE	Norway	21 points
II. J. J. DONAHUE	U. S. A.	29 »
III. F. L. LUKEMAN.....	Canada.....	29 »

Decathlon.

I. H. WIESLANDER.....	Sweden	7,724.495 points.
II. C. LOMBERG	Sweden	7,413.510 »
III. G. HOLMÉR.....	Sweden	7,347.855 »

Relay Race 400 m.

I. GREAT BRITAIN	42 ⁴ / ₁₀ s.
II. SWEDEN.....	42 ⁶ / ₁₀ »

Relay Race 1,600 m.

I. U. S. A.	3 m. 16 ⁶ / ₁₀ s.
II. FRANCE	3 » 20 ⁷ / ₁₀ »
III. GREAT BRITAIN.....	3 » 23 ² / ₁₀ »

Team Race 3,000 m.

I. U. S. A.	9 points.
II. SWEDEN.....	13 »
III. GREAT BRITAIN.....	23 »

Tug-of-War.

- I. SWEDEN.
II. GREAT BRITAIN.

Cross-Country Race: 8,000 m., ind. comp.

I. H. KOLEHMAINEN.....	Finland	45 m. 11 ³ / ₅ s.
II. HJ. AKDERSSON.....	Sweden	45 » 44 ⁴ / ₅ »
III. J. EKÉ.....	Sweden	46 » 37 ³ / ₅ »

Cross-Country Race: 8,000 m., team comp.

I. SWEDEN.....	10 points.
II. FINLAND.....	11 »
III. GREAT BRITAIN.....	49 »

Cycling Road Race round Lake Mälär.

Individual Competition.

I. R. LEWIS	South Africa	10 h. 42 m. 39 s.
II. F. H. GRUBB	Great Britain	10 » 51 » 24 ³ / ₁₀ »
III. C. O. SCHUTTE	U. S. A.	10 » 52 » 38 ⁸ / ₁₀ »

Team Competition.

I. SWEDEN	44 h. 35 m. 33 ⁶ / ₁₀ s.
II. GREAT BRITAIN	44 » 44 » 39 ² / ₁₀ »
III. U. S. A.	44 » 47 » 55 ⁶ / ₁₀ »

Fencing.

Ind. Competition with foils

I. N. NADI	Italy
II. P. SPECIALE	Italy
III. R. VERDERBER	Austria

Épée team Competition.

- I. BELGIUM.
- II. GREAT BRITAIN.
- III. HOLLAND.

Ind. Épée Competition.

I. P. ANSPACH	Belgium
II. I. OSSIER	Denmark
III. P. LE HARDY DE BEAULIEU	Belgium

Sabre Team Competition.

- I. HUNGARY.
- II. AUSTRIA.
- III. HOLLAND.

Ind. Sabre Competition.

I. J. FUCHS	Hungary
II. B. BÉKESSY	Hungary
III. E. MESZAROS	Hungary

Football.

- I. GREAT BRITAIN.
- II. DENMARK.
- III. HOLLAND.

Gymnastics.

Team Competition I.

I. SWEDEN	937.46	points.
II. DENMARK	898.84	»
III. NORWAY	857.21	»

Team Competition II.

I. ITALY	53.15	points.
II. HUNGARY	45.45	»
III. GREAT BRITAIN ...	36.90	»

Team Competition 111

I. NORWAY.....	22.85	points.
II. FINLAND.....	21.85	»
III. DENMARK.....	21.25	»

Ind. Competition.

I. A. BRAGLIA	Italy	135	points.
II. L. SÉGURA	France	132.50	»
III. A. TUNESI	Italy	131.50	»

Horse Riding Competitions.

Military, Team Competition.

- I. SWEDEN.
- II. GERMANY.
- III. U. S. A.

Military, Ind. Competition.

I. Lieutenant A. NORDLANDER.....	Sweden
II. Oberleutnant VON ROCHOW	Germany
III. Capitaine J. CARIOU	France

Prize Riding.

I. Captain, Count C. BONDE	Sweden
II. Major G. A. BOLTENSTERN.....	Sweden
III. Lieutenant, Baron H. VON BLIXEN-FINECKE	Sweden

Prize Jumping, Ind. Competition.

I. Capitaine J. CARIOU	France
II. Oberleutnant VON KRÖCHER.....	Germany
III. Capitaine E. DE BLOMMAERT	Belgium

Prize Jumping, Team Competition.

- I. SWEDEN.
- II. FRANCE.
- III. GERMANY.

Lawn Tennis.

Covered Courts.

Gentlemen's Singles.

I. A. GOBERT.....	France
II. C. P. DIXON	Great Britain
III. A. F. WILDING	Australasia

Ladies' Singles.

I. E. M. HANNAM.....	Great Britain
II. T. G. S. CASTENSCHILD.....	Denmark
III. M. B. PARTON.....	Great Britain

Gentlemen's Doubles.

I. A. GOBERT—M. GERMOT.....	France
II. G. SETTERWALL—G. KEMPE.....	Sweden
III. C. P. DIXON—A. E. BEAMISH.....	Great Britain

Mixed Doubles.

- I. E. M. HANNAM—C. P. DIXON..... Great Britain
- II. F. H. AITCHISON—H. ROP.-BARKETT Great Britain
- III. S. FICK—G. SETTERWALL Sweden

Out-of-door Courts.

Gentlemen's Singles.

- I. C. L. WINSLOW .. South Africa
- II. H. A. KITSON..... South Africa
- III. O. KREUZER Germany

Ladies' Singles.

- I. M. BROQUEDIS..... France
- II. D. KÖRING Germany
- III. M. BJURSTEDT..... Norway

Gentlemen's Doubles.

- I. H. A. KITSON—C. L. WINSLOW.. South Africa
- II. A. ZBORZIL—F. PIPES Austria
- III. A. CANET—M. MÉNY France

Mixed Doubles.

- I. D. KÖRING—H. SCHOMBURGK..... Germany
- II. S. FICK—G. SETTERWALL..... Sweden
- III. M. BROQUEDIS—A. CANET France

Modern Pentathlon.

- I. G. LILLIEHÖÖK Sweden
- II. G. ÅSBRINK..... Sweden
- III. G. DE LAVAL Sweden

Rowing.

Eights, outriggers.

- I. LEANDER CLUB..... Great Britain
- II. NEW COLLEGE..... Great Britain

Fours, outriggers.

- I. LUDWIGSHAFEN RUDER GES..... Germany
- II. THAMES ROWING CLUB Great Britain

Fours, inriggers.

- I. DENMARK.
- II. SWEDEN.

Single Sculls.

- I. W. D. KINNEAR Great Britain
- II. P. VEIRMAN..... Belgium

Shooting.

I. Army Rifle Shooting

a. *Team Competition.*

- I. U. S. A..... 1,687 points.
- II. GREAT BRITAIN..... 1,602 »
- III. SWEDEN..... 1,570 »

b. *Ind. Competition.*

I. P. R. COLAS	France	94	points.
II. C. T. OSBURN	U. S. A	94	»
III. J. E. JACKSON	U. S. A	93	»

c. *Ind. Competition.*

I. A. PROKOPP.....	Hungary	97	points.
II. C. F. OSBURN.....	U. S. A.....	95	»
III. E. E. SKOGEN.....	Norway	95	»

II. Shooting with any Rifle.

d. *Team Competition.*

I. SWEDEN	5,655	points.
II. NORWAY.....	5,605	»
III. DENMARK	5,529	»

e. *Ind. Competition.*

I. P. R. COLAS	France.....	987	points.
II. J. L. MADSEN.....	Denmark.....	981	»
III. N. H. D. LARSEK.....	Denmark.....	962	»

III. Miniature-Rifle Shooting.

f. *Team Competition.*

I. GREAT BRITAIN	762	points.
II. SWEDEN.....	748	»
III. U. S. A.	744	»

g. *Ind. Competition.*

I. F. S. HIRD.....	U. S. A.....	194	points.
II. W. MILNE	Great Britain.....	193	»
III. H. BURT.....	Great Britain.....	192	»

h. *Team Competition.*

I. SWEDEN	925	points.
II. GREAT BRITAIN.....	917	»
III. U. S. A.....	881	»

i. *Ind. Competition.*

I. W. CARLBERG.....	Sweden.....	242	points.
II. J. H. VON HOLST	Sweden.....	233	»
III. G. ERICSSON	Sweden.....	231	»

IV. Revolver and Pistol Shooting.

j. *Team Competition.*

I U. S. A.....	1,916	points.
II SWEDEN	1,849	»
III. GREAT BRITAIN	1,804	»

k. *Ind. Competition.*

I. A. P. LANE.....	U. S. A.....	499	points.
II. P. J. DOLFEN	U. S. A.....	474	»
III. G. E. STEWARD.....	Great Britain	470	»

l. *Team Competition.*

I. SWEDEN	1,145 points.
II. RUSSIA	1,091 »
III. GREAT BRITAIN	1,107 »

m. *Ind. Competition.*

I. A. P. LANE	U. S. A.	287 points.
II. P. PALEN	Sweden	286 »
III. H. VON HOLST	Sweden	283 »

V. *Clay Bird Shooting.*

n. *Team competition.*

I. U. S. A.	532 points.
II. GREAT BRITAIN	511 »
III. GERMANY	510 »

o. *Ind. Competition.*

I. J. R. GRAHAM	U. S. A.	96 points.
II. A. GOEDEL	Germany	94 »
III. H. BLAU	Russia	91 »

VI. *Running Deer Shooting.*

p. *Team Competition.*

I. SWEDEN	151 points.
II. U. S. A.	132 »
III. FINLAND	123 »

q. *Ind. Competition, single shots.*

I. A. SWAHN	Sweden	41 points.
II. Å. LUNDEBERG	Sweden	41 »
III. N. TOIVONEN	Finland	41 »

r. *Ind. Competition, double shots.*

I. Å. LUNDEBERG	Sweden	79 points.
II. E. BENEDICKS	Sweden	74 »
III. O. G. SWAHN	Sweden	72 »

Swimming.

100 m. *free style.*

I. DUKE PAOA KAHANAMOKU	U. S. A.	1 m. 3²/₅ s.
II. C. HEALY	Australasia	1 » 4³/₅ »
III. K. HUSZAGH	U. S. A.	1 » 5³/₅ »

100 m. *back stroke.*

I. H. HEBNER	U. S. A.	1 m. 21¹/₅ s.
II. O. FAHR	Germany	1 » 22²/₅ »
III. P. KELLNER	Germany	1 » 24 »

200 m. *breast stroke.*

I. W. BATHE	Germany	3 m. 1⁴/₅ s.
II. W. LÜTZOW	Germany	3 » 5 »
III. P. MALISH	Germany	3 » 8 »

400 m. free style.

I. G. HODGSON	Canada	5 m. 24 ² / ₅ s.
II. J. HATFIELD	Great Britain	5 » 25 ⁴ / ₅ »
III. H. HARDWICK	Australasia	5 » 31 ¹ / ₅ »

400 m. breast stroke.

I. W. BATHE	Germany	6 m. 29 ³ / ₅ s.
II. T. HENNING	Sweden	6 » 35 ³ / ₅ »
III. Y. COURTMAN	Great Britain	6 » 36 ² / ₅ »

1,500 m. free style.

I. G. HODGSON	Canada	22 m. 00 s.
II. J. HATFIELD	Great Britain	22 » 39 »
III. H. HARDWICK	Australasia	23 » 15 ² / ₅ »

High Diving.

I. E. ADLERZ	Sweden	40 points.
II. HJ. JOHANSSON	Sweden	39.3 »
III. J. JANSSON	Sweden	39.1 »

Plain and Variety Diving.

I. E. ADLERZ	Sweden	73.94 points.
II. A. ZÜRNER	Germany	72.6 »
III. G. BLOMGREN	Sweden	69.56 »

Spring-board Diving.

I. P. GÜNTHER	Germany	79.23 points.
II. H. LUBER	Germany	76.78 »
III. K. BEHRENS	Germany	73.73 »

100 m. free style, for Ladies.

I. FANNY DURACK	Australasia	1 m. 22 ¹ / ₅ s.
II. WILHELMINA WYLIE	Australasia	1 » 25 ² / ₅ »
III. JENNIE FLETCHER	Great Britain	1 » 27 »

High Plain Diving, for Ladies.

I. GRETA JOHANSSON	Sweden	39.9 points.
II. LISA REGNELL	Sweden	36 »
III. ISABELLE WHITE	Great Britain	34 »

800 m. Team Race.

I. AUSTRALASIA	10 m. 11 ³ / ₅ s.
II. U. S. A.	10 » 20 ¹ / ₅ »
III. GREAT BRITAIN	10 » 28 ¹ / ₅ »

Water Polo.

- I. GREAT BRITAIN.
- II. SWEDEN.
- III. BELGIUM.

400 m. Team Race, for Ladies.

I. GREAT BRITAIN	5 m. 52 ¹ / ₅ s.
II. GERMANY	6 » 4 ³ / ₅ »
III. AUSTRIA	6 » 17 »

Wrestling.

Feather Weight.

I. KALLE KOSKELO	Finland
II. GEORG GERSTACKER	Germany
III. O. A. LASANEN.....	Finland

Light Weight.

I. E. E. WÄRE	Finland
II. C. H. MALMSTRÖM	Sweden
III. E. MATIASSON	Finland

Middle Weight A.

I. C. E. JOHANSSON	Sweden
II. M. KLEIN	Russia
III. A. ASIKAINEN	Finland

Middle Weight B.

I. A. O. AHLGREN.....	Sweden
II. I. T. BOLING.....	Finland
III. B. VARGA	Hungary

Heavy Weight.

I. U. SAARELA	Finland
II. J. OLIN	Finland
III. S. M. JENSEN.....	Denmark

Yacht Racing.

12-M. class.

I. MAGDA IX	Norway
II. ERNA-SIGNE	Sweden
III. HEATHERBELL.....	Finland

10-M. class.

I. KITTY	Sweden
II. NINA	Finland
III. GALLIA II	Russia

8-M. class.

I. TAUFIN	Norway
II. SANS ATOUT	Sweden
III. LUCKY GIRL	Finland

6-M. class.

I. MAC MICHE.....	France
II. NURDUG II.....	Denmark
III. KERSTIN.....	Sweden

WINNERS OF THE OLYMPIC CHALLENGE PRIZES.

Competition	Presented by	Won by
Pentathlon	H. M. the King of Sweden	F. R. Bie, Norway
Decathlon	H. M. the Emperor of Russia	H. Wieslander, Sweden
Marathon Race	H. M. the King of Greece	K. K. Mc Arthur, South Africa
Throwing the Discus, best hand	M:me G. de Montgomery ...	A. R. Taipale, Finland
Fencing, team comp., Épée	The British Fencers	Belgium
» » » Sabre	The City of Buda-Pesth	Hungary
Football	The Football Association ...	Great Britain
Gymnastics, ind. competition	The City of Prague	G. A. Braglia, Italy
Military	H. M. the Emperor of Germany	Sweden
Prize Riding	H. M. the Emperor of Austria	Count C. Bonde, Sweden
Prize Jumping, ind. comp.	Count Géza Andrassy	Captain J. Cariou, France
» » team comp.	H. M. the King of Italy ...	Sweden
Horse Riding Comps. ...	The Swedish Cavalry.....	Sweden
Modern Pentathlon	Baron P. de Coubertin	G. Lilliehöök, Sweden
Rowing, eights	Count Brunetta d'Usseaux ...	Great Britain
Clay Bird Shooting, ind. competition	Lord Westbury	J. R. Graham, United States
Swimming, 1,500 metres	Count Brunetta d'Usseaux ...	G. Hodgson, Canada
» Ladies' High		
Diving	Countess de Casa Miranda ...	Greta Johansson, Sweden
Wrestling, heavy weight	The Gold & Silversmiths Co.	U. Saarela, Finland
Yacht Racing, 6-metre class	The French Government ...	G. Thubé and G. Fitau, France

LIST OF COMPETITORS WHO WON THREE 1:ST PRIZES.

Name	Nation	Competition
H. KOLEHMAINEN ...	Finland	5,000 m. Flat. 10,000 m. Flat. Cross Country Race, 8,000 m.
W. CARLBERG	Sweden	Miniature-Rifle Shooting, team competition, 25 metres. Miniature-Rifle Shooting, ind. competition, 25 metres. Revolver and Pistol Shooting, team competition, 30 metres.
A. P. LANE	U. S. A.	Revolver and Pistol Shooting, team competition, 50 metres. Revolver and Pistol Shooting, ind. competition, 50 metres. Revolver and Pistol Shooting, ind. competition, 30 metres.

LIST OF COMPETITORS, WHO WON TWO 1:ST PRIZES.

Name	Nation	Competition
R. C. CRAIG	U. S. A.	100 m. Flat. 200 » »
C. D. REIDPATH	»	400 m. Flat. Relay Race 1,600 m.
J. MEREDITH	»	800 m. Flat. Relay Race 1,600 m.
J. R. GRAHAM	»	Clay Bird Shooting, team competition. » » » , ind. »
A. NORDLANDER	Sweden	Horse Riding Competitions, Military, team competition. Horse Riding Competitions, Military, ind. competition.
E. ADLERZ	»	High Diving. Plain and Variety Diving.
A. SWAHN	»	Running Deer Shooting, team comp. » » » , ind. comp., single shots.
ÅKE LUNDEBERG	»	Running Deer Shooting, team comp. » » » ind. comp., double shots.
A. GOBERT	France	Lawn Tennis (covered courts) Gentle- men's Singles. Lawn Tennis (covered courts), Gentle- men's Doubles.
P. R. COLAS	»	Army Rifle Shooting, ind. competition 600 m. Shooting with any Rifle, ind. competi- tion 300 m.
P. ANSPACH	Belgium	Fencing, Épée team competition. » , Ind. Épée competition.
G. HODGSON	Canada	Swimming, 400 m. free style. » 1,500 » » »
A. R. TAIPALE	Finland	Throwing the Discus, best hand. » » » , right & left hand.
G. A. BRAGLIA	Italy	Gymnastics, Team Competition II. » , ind. competition.
Mrs. E. M. HANNAM	Great Britain ..	Lawn Tennis (covered courts), Ladies' Singles. Lawn Tennis (covered courts) Mixed Doubles.
C. L. WINSLOW	South Africa	Lawn Tennis (out-of-door courts) Gent- lemen's Singles. Lawn Tennis (out-of-door courts) Gent- lemen's Doubles.
J. FUCHS	Hungary	Fencing, Sabre team competition. » , Ind. Sabre competition.

OFFICIAL CALCULATION OF POINTS.

(1:st prize = 3 points; 2:nd prize = 2 points; 3:rd prize = 1 point.

Nation	Number of points	Number of 1:st prizes	Number of 2:nd prizes	Number of 3:rd prizes	Total number of prize	Number of times placed fourth*	Number of times placed fifth*	Total of placings
Sweden	136	24	24	16	64	22	15	101
U. S. A.	124	23	18	19	60	14	15	89
Great Britain	76	10	15	16	41	9	6	56
Finland	52	9	8	9	26	5	5	36
Germany	47	5	13	6	24	9	7	40
France	32	7	4	3	14	3	1	18
Denmark	19	1	6	4	11	1	2	14
Norway	17	4	1	3	8	2	2	12
South Africa	16	4	2	—	6	2	—	8
Hungary	16	3	2	3	8	3	1	12
Canada	14	3	2	1	6	3	3	12
Italy	13	3	1	2	6	1	4	11
Australasia	13	2	2	3	7	1	—	8
Belgium	11	2	1	3	6	1	—	7
Russia	6	—	2	2	4	1	2	7
Austria	6	—	2	2	4	1	1	6
Greece	4	1	—	1	2	2	2	6
Holland	3	—	—	3	3	—	—	3
Bohemia	—	—	—	—	—	3	—	3
Luxemburg	—	—	—	—	—	1	1	2
		101	103	96	300	84	67	451

* In such competitions where it was possible to place 4 or 5 men or a team.

CALCULATION OF POINTS FOR THE CONCOURS D'ART.

Nation	1st prize	2nd prize	Points
Italy	2	—	6
U. S. A.	1	—	3
Switzerland	1	—	3
Germany	1	—	3
France	—	1	2

**COMPARISON BETWEEN THE SWEDISH OFFICIAL
CALCULATION OF POINTS**

(1:st prize = 3 points; 2:nd prize = 2 points; 3:rd prize = 1 point)

AND THE "ENGLISH" METHOD OF CALCULATING POINTS.

(1:st prize = 5 points; 2:nd prize = 3 points; 3:rd prize = 1 point)

Nation	1:st prizes			2:nd prizes			3:rd prizes		Total Points	
	Total	Points = 3	Points = 5	Total	Points = 2	Points = 3	Total	Points = 1	Accord to princ. 3, 2, 1	Accord to princ. 5, 3, 1
Sweden	24	72	120	24	48	72	16	16	136	208
U. S. A.	23	69	115	18	36	54	19	19	124	188
Great Britain	10	30	50	15	30	45	16	16	76	111
Finland	9	27	45	8	16	24	9	9	52	78
Germany	5	15	25	13	26	39	6	6	47	70
France	7	21	35	4	8	12	3	3	32	50
Denmark	1	3	5	6	12	18	4	4	19	27
Norway	4	12	20	1	2	3	3	3	17	26
South Africa	4	12	20	2	4	6	—	—	16	26
Hungary	3	9	15	2	4	6	3	3	16	24
Canada	3	9	15	2	4	6	1	1	14	22
Italy	3	9	15	1	2	3	2	2	13	20
Australasia	2	6	10	2	4	6	3	3	13	19
Belgium	2	6	10	1	2	3	3	3	11	16
Russia	—	—	—	2	4	6	2	2	6	8
Austria	—	—	—	2	4	6	2	2	6	8
Greece	1	3	5	—	—	—	1	1	4	6
Holland	—	—	—	—	—	—	3	3	3	3
	101	303	505	103	206	309	96	96	605	910

LIST OF THE PRIZES WON BY THE DIFFERENT NATIONS AT THE OLYMPIC GAMES OF STOCKHOLM, 1912.

SWEDEN.

- 24 1:st prizes, 72 points: Field and Track Athletics: Hop, Step and Jump.
 » » » » Throwing the Javelin, best hand.
 » » » » Decathlon.
 » » » » Cross-country Race, team competition.

Tug-of-War.

Cycling road race round Lake Mälär, team competition.

Gymnastics, team competition according to the Swedish system.

Horse Riding Competitions, Military, team competition.

- » » » » ind. »
 » » » » Prize Riding.
 » » » » Prize Jumping, team comp.

Modern Pentathlon.

Shooting with any rifle, team competition.

- » Miniature Rifle, team competition, 25 metres.
 » » » ind. » , 25 »
 » Revolver and Pistol, team comp., 30 metres.
 » Running Deer Comp., team competition.
 » » » » ind. comp., single shots.
 » » » » » » » , double »

Swimming: Plain Diving.

- » Plain and Variety Diving.
 » Plain Diving, Ladies.

Wrestling, Middle weight A.

Yacht Racing, 10-metre class.

- 24 2:nd prizes 48 points: Field and Track Athletics: Hop, Step and Jump.
 » » » » Decathlon.
 » » » » Relay race 400 metres.
 » » » » Team race, 3,000 metres.
 » » » » Cross-country race, ind. competition.

Horse Riding Competitions, Prize Riding.

Lawn Tennis (covered courts), Gentlemen's Doubles.

- » » (out-of-door courts), Mixed Doubles.

Modern Pentathlon.

Rowing, Fours, inriggers.

Shooting with Miniature Rifle, team comp., 50 metres.

Shooting with Miniature Rifle, ind. comp., 25 metres.
 » Revolver and Pistol, team » 50 »
 » » » » ind. » 30 »
 » Running Deer Comp., ind. comp., single shots.
 » » » » » » double »

Swimming; 400 metres breast stroke.

» Plain Diving.

» » » Ladies.

» Water Polo.

Wrestling, Light weight.

» , Middle weight A.

Yacht Racing, 12-metre class.

» » 8 - » »

16 3:rd prizes, 16 points: Field and Track Athletics: Running Broad Jump.

» » » » Hop, Step and Jump.

» » » » Throwing the Discus, right
and left hand.

» » » » Decathlon.

» » » » Cross-country Race, ind.
competition.

Horse Riding Competitions, Prize Riding.

Lawn Tennis (covered courts), Mixed Doubles.

Modern Pentathlon.

Shooting with Army Rifle, team competition.

» Miniature Rifle, ind competition, 25 metres.

» Revolver and Pistol, ind. comp., 30 metres.

» Running Deer Comp., ind. comp., double shots.

Swimming: Plain Diving.

» Plain and Variety Diving.

Wrestling, Light weight.

Yacht Racing, 6-metre class.

Total 136 points.

THE UNITED STATES OF AMERICA.

23 1:st prizes, 69 points: Field and Track Athletics: 100 metres flat.

» » » » 200 » »

» » » » 400 » »

» » » » 800 » »

» » » » Hurdle race, 110 metres.

» » » » Running High Jump.

» » » » Standing » »

» » » » Running Broad Jump.

» » » » Pole Jump.

» » » » Putting the weight, best hand.

» » » » » » » , right and
left hand.

» » » » Throwing the Hammer.

» » » » Relay Race, 1,600 metres.

» » » » Team Race, 3,000 »

Shooting with Army Rifle, team competition.
 » » Miniature Rifle, ind. comp. 50 metres.
 » » Revolver and Pistol, team comp., 50 m.
 » » » » » , ind. » 50 »
 » » » » » , » » 30 »
 » Clay Bird Competition, team competition.
 » » » » ind. »

Swimming: 100 metres Free style.
 » 100 » Back stroke.

18 2:nd prizes, 36 points: Field and Track Athletics: 100 metres flat.
 » » » » 200 » »
 » » » » 800 » »
 » » » » 1,500 » »
 » » » » 10,000 » »
 » » » » Hurdle race, 110 metres.
 » » » » Standing High Jump.
 » » » » Standing Broad Jump.
 » » » » Pole Jump.
 » » » » Throwing the Discus, b. h.
 » » » » Putting the weight, best hand.
 » » » » » » » , right and
 left hand.
 » » » » Pentathlon.

Shooting with Army Rifle, ind. comp., 600 metres.
 » » » » » » 300 »
 » » Revolver and Pistol, ind. comp., 50 metres.
 » Running Deer Comp., team competition.

Swimming, 800 metres team race.

19 3:rd prizes, 19 points: Field and Track Athletics: 100 metres flat.
 » » » » 400 » »
 » » » » 800 » »
 » » » » 1,500 » »
 » » » » Marathon Race.
 » » » » Hurdle race, 110 metres.
 » » » » Running High Jump.
 » » » » Standing Broad Jump.
 » » » » Pole Jump.
 » » » » Throwing the Discus, b. h.
 » » » » Putting the Weight, b. h.
 » » » » Throwing the Hammer.

Cycling road race round Lake Mälär, ind. competition.
 » » » » » » » , team »

Horse Riding competitions, Military, team competition.
 Shooting with Army Rifle, ind. competition, 600 metres.
 » » Miniature rifle, team comp., 50 metres.
 » » » » » » » , 25 »

Swimming, 100 metres free style.

Total 124 points.

GREAT BRITAIN.

- 10 1:st prizes, 30 points: Field and Track Athletics: 1,500 metres flat.
 » » » » Relay race 400 metres.
 Football.
 Lawn Tennis (covered courts), Ladies' Singles,
 » » (» »), Mixed Doubles.
 Rowing, Eights.
 » Single Sculls.
 Shooting with Miniature Rifle, team comp, 50 metres.
 Swimming: Water Polo.
 » 400 metres team race, ladies.
- 15 2:nd prizes, 30 points Field and Track Athletics: Walking race 10,000 metres.
 » » » » Tug-of-War.
 Cycling road race round Lake Mälär, ind. competition.
 » » » » » » team »
 Fencing: Épée team competition.
 Lawn Tennis (covered courts), Gentlemen's Singles.
 » » (» »), Mixed Doubles.
 Rowing, Eights.
 » Fours, outriggers.
 Shooting with Army Rifle, team competition.
 » » Miniature Rifle, ind. comp., 50 metres.
 » » » » team » 25 »
 » Clay Bird Competition, team competition.
 Swimming: 400 metres free style.
 » 1,500 » » »
- 16 3:rd prizes, 16 points: Field and Track Athletics: 200 metres flat.
 » » » » 5,000 » »
 » » » » Relay race 1,600 metres.
 » » » » Team race 3,000 »
 » » » » Cross-country Race, team
 competition.
 Gymnastics, team comp. according to special regulations.
 Lawn Tennis (covered courts), Ladies' Singles.
 » » (» »), Gentlemen's Doubles.
 Shooting with Miniature Rifle, ind. comp., 50 metres.
 » » Revolver and Pistol, team comp., 50 m.
 » » » » » , ind. » 50 »
 » » » » » , team » 30 »
 Swimming, 400 metres breast stroke.
 » , 100 » free style, ladies.
 » , Plain Diving, ladies.
 » , 800 metres, team race.

Total 76 points.

FINLAND.

- 9 1:st prizes, 27 points: Field and Track Athletics: 5,000 metres flat.
 » » » » 10,000 » »

- Field and Track Athletics: Throwing the Javelin, right and left hand.
 » » » » Throwing the Discus, b. h.
 » » » » » » » , right and left hand.
 » » » » Cross-country Race, ind. competition.
- Wrestling, Feather weight.
 » , Light »
 » , Heavy »
- 8 2:nd prizes, 16 points: Field and Track Athletics: Throwing the Javelin, b. h.
 » » » » » » » , right and left hand.
 » » » » Throwing the Discus, right and left hand.
 » » » » Cross-country Race, team competition.
- Gymnastics, team competition, with free choice of movements and apparatus.
 Wrestling, Middle weight B.
 » , Heavy weight.
 Yacht Racing, 10-metre class.
- 9 3:rd prizes, 9 points: Field and Track Athletics: 10,000 metres flat.
 » » » » Throwing the Javelin, right and left hand.
 » » » » Putting the Weight, right and left hand.
- Shooting: Running Deer Competition, team competition.
 » » » » ind. »
- Wrestling, Feather weight.
 » , Middle weight A.
 single shots.
- Yacht Racing, 12-metre class.
 » » 8- » »
- Total 52 points.*

GERMANY.

- 5 1:st prizes, 15 points: Lawn Tennis (out-of-door courts) Mixed Doubles.
 Rowing, Fours, outriggers.
 Swimming, 200 metres breast stroke.
 » , 400 » » »
 » , Spring-board Plain Diving.
- 13 2:nd prizes, 26 points: Field and Track Athletics: 400 metres flat.
 » » » » Running High Jump.
 Horse Riding Competitions, Military, team competition.
 » » » » , ind.
 » » » » , Prize Jumping, ind. » comp.
 Lawn Tennis (out-of-door courts) Ladies' Singles.

Shooting: Clay Bird Competition, ind. competition.
 Swimming, 100 metres back stroke.
 » , 200 » breast stroke.
 » , Plain and Variety Diving.
 » , Spring-board Diving.
 » , 400 metres team race, ladies.

Wrestling, Feather weight.

- 6 3:rd prizes, 6 points: Horse Riding competitions, Prize Jumping, team race.
 Lawn Tennis (out-of-door courts), Gentlemen's Singles.
 Shooting: Clay Bird Competition, team competition.
 Swimming, 100 metres back stroke.
 » , 200 metres breast stroke.
 » , Spring-board Diving.

Total 47 points.

FRANCE.

- 7 1:st prizes, 21 points: Horse Riding Competitions, Prize Jumping, ind. competition.
 Lawn Tennis (covered courts), Gentlemen's Singles.
 » » (» »), » Doubles.
 » » (out-of-door courts), Ladies' Singles.
 Shooting with Army Rifle, ind. competition, 600 metres.
 » » any rifle, » »
 Yacht Racing, 6-metre class.
 4 2:nd prizes, 8 points: Field and Track Athletics: 5,000 metres flat.
 » » » » Relay race 1,600 metres,
 Gymnastics, ind. competition.
 Horse Riding Competition. Prize Jumping, team competition.
 3 3:rd prizes, 3 points: Horse Riding competition, Military, ind. competition.
 Lawn Tennis (out-of-door courts), Gentlemen's Doubles.
 » » (» »), Mixed Doubles.

Total 32 points.

DENMARK.

- 1 1:st prize, 3 points: Rowing, Fours, inriggers.
 6 2:nd prizes, 12 points: Football.
 Fencing: Épée ind. competition.
 Gymnastics, team competition according to Swedish system.
 Lawn Tennis (covered courts) Ladies' Singles.
 Shooting with any rifle, ind. competition.
 Yacht Racing, 6-metre class.
 4 3:rd prizes, 4 points: Wrestling, Heavy weight.
 Gymnastics, team competition, with free choice of movements and apparatus.
 Shooting with any rifle, team competition.
 » » » » , ind. »

Total 19 points.

NORWAY.

- 4 1:st prizes, 12 points: Field and Track Athletics: Pentathlon.
 Gymnastics, team competition, with free choice of movements and apparatus.

Yacht Racing, 12-metre class.

» » 8 - » »

- 1 2:nd prize, 2 points: Shooting with any rifle, team competition.
3 3:rd prizes, 3 points: Gymnastics, team competition according to Swedish system.
Lawn Tennis (out-of-door courts) Ladies' Singles.
Shooting with Army Rifle, ind. competition, 300 metres.

Total 17 points.

HUNGARY.

- 3 1:st prizes, 9 points: Fencing: Sabre team competition.
» » ind. »
Shooting with Army Rifle, ind. competition, 300 metres.
2 2:nd prizes, 4 points: Fencing: Sabre ind. competition.
Gymnastics, team competition according to special regulations.
3 3:rd prizes, 3 points: Field and Track Athletics: Throwing the Javelin, best hand.
Fencing: Sabre ind. competition.
Wrestling, Middle weight B.

Total 16 points.

SOUTH AFRICA.

- 4 1:st prizes, 12 points: Field and Track Athletics: Marathon Race.
Cycling road race round Lake Mälär, ind. competition.
Lawn Tennis (out-of-door courts), Gentlemen's Singles.
» » (» »), » Doubles.
2 2:nd prizes, 4 points: Field and Track Athletics: Marathon Race.
Lawn Tennis (out-of-door courts) Gentlemen's Singles.

Total 16 points.

CANADA.

- 3 1:st prizes, 9 points: Field and Track Athletics: Walking race, 10,000 metres.
Swimming, 400 metres free style.
» , 1,500 » » »
2 2:nd prizes, 4 points: Field and Track Athletics: Running Broad Jump.
» » » » Throwing the Hammer.
1 3:rd prize, 1 point: Field and Track Athletics: Pentathlon.

Total 14 points.

ITALY.

- 3 1:st prizes, 9 points: Fencing: Ind. competition with foils.
Gymnastics, team competition according to special regulations.
» ind. competition.
1 2:nd prize, 2 points: Fencing: Ind. competition with foils.
2 3:rd prizes, 2 points: Field and Track Athletics: Walking race 10,000 metres.
Gymnastics, ind. competition.

Total 13 points.

AUSTRALASIA.

- 2 1:st. prizes, 6 points: Swimming: 100 metres free style, ladies.
» 800 » team race.

- 2 2:nd prizes, 4 points: Swimming: 100 metres free style.
 » 100 » » » ladies.
 3 3:rd prizes, 3 points: Lawn Tennis (covered courts), Gentlemen's Singles.
 Swimming: 400 metres free style.
 » 1,500 » » »
- Total 13 points.*

BELGIUM.

- 2 1:st prizes, 6 points: Fencing: Épée team competition.
 » » ind. »
 1 2:nd prize, 2 points: Rowing: Single Sculls.
 3 3:rd prizes, 3 points: Fencing: Épée ind. competition.
 Horse Riding competitions, Prize Jumping, ind. competition.
 Water Polo.
- Total 11 points.*

RUSSIA.

- 2 2:nd prizes, 4 points: Shooting with Revolver and Pistol, team comp., 30 metres.
 Wrestling, Middle weight A.
 2 3:rd prizes, 2 points: Shooting: Clay Bird Competition, ind. competition.
 Yacht Racing, 10-metre class.
- Total 6 points.*

AUSTRIA.

- 2 2:nd prizes, 4 points: Fencing: Sabre team competition.
 Lawn Tennis (out-of-door courts), Gentlemen's Doubles.
 2 3:rd prizes, 2 points: Fencing: Ind. competition with foils.
 Swimming: 400 metres team race, ladies.
- Total 6 points.*

GREECE.

- 1 1:st prize, 3 points: Field and Track Athletics; Standing Broad Jump.
 1 3:rd prize, 1 point: Field and Track Athletics: Standing High Jump.
- Total 4 points.*

HOLLAND.

- 3 3:rd prizes, 3 points:
 Fencing: Épée team competition.
 » Sabre » »
 Football.
- Total 3 points.*

TABLE SHOWING THE N:R OF PRIZES WON BY THE NATIONS IN THE VARIOUS BRANCHES OF ATHLETICS.

Nation		Athletics			Cycling			Fencing			Football			Gymnastics			Horse Riding			Lawn Tennis			Modern Pentathlon			Rowing			Shooting			Swimming			Wrestling			Yacht Racing			Total points					
		1st prize	2nd prize	3rd prize	1st prize	2nd prize	3rd prize	1st prize	2nd prize	3rd prize	1st prize	2nd prize	3rd prize	1st prize	2nd prize	3rd prize	1st prize	2nd prize	3rd prize	1st prize	2nd prize	3rd prize	1st prize	2nd prize	3rd prize	1st prize	2nd prize	3rd prize	1st prize	2nd prize	3rd prize	1st prize	2nd prize	3rd prize	1st prize	2nd prize	3rd prize									
Sweden	N:r of prizes	5	5	5	1	—	—	—	—	—	—	—	—	1	—	—	4	1	1	—	2	1	1	1	1	—	1	—	7	6	4	3	4	2	1	2	1	1	2	1	136					
	Points	30			3			—			—			3			15			5			6			2			37			19			8			8								
U. S. A.	N:r of prizes	14	13	12	—	—	2	—	—	—	—	—	—	—	—	—	—	—	1	—	—	—	—	—	—	—	—	—	7	4	3	2	1	1	—	—	—	—	—	—	124					
	Points	80			2			—			—			—			1			—			—			—			32			9			—			—								
Great Britain	N:r of prizes	2	2	5	—	2	—	—	1	—	1	—	—	—	—	1	—	—	—	—	—	—	—	—	—	2	2	—	1	4	4	2	2	4	—	—	—	—	—	—	76					
	Points	15			4			2			3			1			—			12			—			10			15			14			—			—								
Finland	N:r of prizes	6	4	3	—	—	—	—	—	—	—	—	—	—	1	—	—	—	—	—	—	—	—	—	—	—	—	—	—	—	2	—	—	—	3	2	2	—	1	2	52					
	Points	29			—			—			—			2			—			—			—			2			—			15			4			—								
Germany	N:r of prizes	—	2	—	—	—	—	—	—	—	—	—	—	—	—	—	—	—	—	—	—	—	—	—	—	1	—	—	—	1	1	3	5	3	—	1	—	—	—	—	47					
	Points	4			—			—			—			—			—			7			6			—			3			3			22			2				—				
France	N:r of prizes	—	2	—	—	—	—	—	—	—	—	—	—	—	1	—	1	1	1	3	2	—	—	—	—	—	—	—	2	—	—	—	—	—	—	—	—	—	—	—	1	—	—	32		
	Points	4			—			—			—			2			6			11			—			—			6			—			—			3			—					
Denmark	N:r of prizes	—	—	—	—	—	—	—	1	—	—	1	—	—	1	1	—	—	—	—	—	—	—	—	—	1	—	—	—	1	2	—	—	—	—	—	1	—	1	—	19					
	Points	—			—			2			2			3			—			2			—			3			—			4			—			1				2			—	
Norway	N:r of prizes	1	—	—	—	—	—	—	—	—	—	—	—	1	—	1	—	—	—	—	—	—	—	—	—	—	—	—	—	1	1	—	—	—	—	—	—	2	—	—	17					
	Points	3			—			—			—			4			—			—			1			—			—			3			—			6				—				
Hungary	N:r of prizes	—	—	1	—	—	—	2	1	1	—	—	—	—	1	—	—	—	—	—	—	—	—	—	—	—	—	—	1	—	—	—	—	—	—	—	1	—	—	—	16					
	Points	1			—			9			—			2			—			—			—			—			3			—			1			—				—				
South Africa	N:r of prizes	1	1	—	1	—	—	—	—	—	—	—	—	—	—	—	—	—	—	2	1	—	—	—	—	—	—	—	—	—	—	—	—	—	—	—	—	—	—	—	16					
	Points	5			3			—			—			—			—			8			—			—			—			—			—			—				—				
Canada	N:r of prizes	1	2	1	—	—	—	—	—	—	—	—	—	—	—	—	—	—	—	—	—	—	—	—	—	—	—	—	—	—	—	2	—	—	—	—	—	—	—	—	14					
	Points	8			—			—			—			—			—			—			—			—			—			6			—			—				—				
Italy	N:r of prizes	—	—	1	—	—	—	1	1	—	—	—	—	2	—	1	—	—	—	—	—	—	—	—	—	—	—	—	—	—	—	—	—	—	—	—	—	—	—	—	13					
	Points	1			—			5			—			7			—			—			—			—			—			—			—			—				—				
Australasia	N:r of prizes	—	—	—	—	—	—	—	—	—	—	—	—	—	—	—	—	—	1	—	—	—	—	—	—	—	—	—	—	—	—	2	2	2	—	—	—	—	—	—	13					
	Points	—			—			—			—			—			—			1			—			—			—			12			—			—				—				
Belgium	N:r of prizes	—	—	—	—	—	—	2	—	1	—	—	—	—	—	—	—	—	—	—	—	—	—	—	—	—	—	—	—	—	—	—	—	1	—	—	—	—	—	—	11					
	Points	—			—			7			—			—			—			1			—			—			2			—			1			—				—				
Russia	N:r of prizes	—	—	—	—	—	—	—	—	—	—	—	—	—	—	—	—	—	—	—	—	—	—	—	—	—	—	—	—	1	1	—	—	—	—	—	—	—	1	—	—	—	1	6		
	Points	—			—			—			—			—			—			—			—			—			—			3			—			2			1				—	
Austria	N:r of prizes	—	—	—	—	—	—	—	1	1	—	—	—	—	—	—	—	—	—	—	—	—	—	—	—	—	—	—	—	—	—	—	—	—	—	—	—	—	—	—	6					
	Points	—			—			3			—			—			—			—			—			—			—			—			1			—				—				
Greece	N:r of prizes	1	—	1	—	—	—	—	—	—	—	—	—	—	—	—	—	—	—	—	—	—	—	—	—	—	—	—	—	—	—	—	—	—	—	—	—	—	—	—	4					
	Points	4			—			—			—			—			—			—			—			—			—			—			—			—				—				
Holland	N:r of prizes	—	—	—	—	—	—	—	—	2	—	—	1	—	—	—	—	—	—	—	—	—	—	—	—	—	—	—	—	—	—	—	—	—	—	—	—	—	—	—	3					
	Points	—			—			2			1			—			—			—			—			—			—			—			—			—				—				

**LIST OF DIPLOMAS OF MERIT AWARDED AT
THE OLYMPIC GAMES 1912.**

Athletics.

100 m. Flat.

BELOTE, F. V.....	U. S. A.
DREW, H. P.	»
PATCHING, G. H.	South Africa

200 m. Flat:

RAU, R.	Germany
REIDPATH, C. D.	U. S. A.
YOUNG, D. B.	»

400 m. Flat:

HAFF, C. B.....	U. S. A.
MEREDITH, J. E.....	»

800 m. Flat:

BRAUN, H.	Germany
BROCK, G. M.....	Canada
CALDWELL, D.....	U. S. A.

1,500 m. Flat:

JONES, J. P.....	U. S. A.
WIDE, E.....	Sweden

5,000 m. Flat:

BERNA, T. L.....	U. S. A.
BONHAG, G. V.....	»
CARLSSON, M.....	Sweden
DECOUTEAU, A.....	Canada

10,000 m. Flat:

KEEPER, T.....	Canada
----------------	--------

Hurdle Race: 110 m.

CASE, J. R.....	U. S. A.
NICHOLSON, J. P.	»
POWELL, K.....	Great Britain

Walking Race 10,000 m.

RASMUSSEN A.	Denmark
-------------------	---------

Running High Jump:

ERICKSON, E. R.	U. S. A.
GRUMPELT, H. J.	»
JOHNSTONE J. O.	»
KULLERSTRAND, K.	Sweden
THORPE, J.	U. S. A.

Standing High Jump:

BYRD, R. L.	U. S. A.
GOEHRING, L.	»
MÖLLER, E.	Sweden

Running Broad Jump:

ALLEN, F.	U. S. A.
MERCER, E.	»
WORTHINGTON, H.	»

Standing Broad Jump:

GOEHRING, L.	U. S. A.
MALMSTEN G.	Sweden
MÖLLER, E.	»

Pole Jump:

BELLAH, S. H.	U. S. A.
--------------------	----------

Hop, Step and Jump:

ADAMS, PLATT	U. S. A.
LARSÉN, E.	Norway
OHLSSON, HJ.	Sweden
WINNE, E.	Norway

Pentathlon:

BRUNDAGE, A.	U. S. A.
LUKEMAN, F. L.	Canada
MENAU, J. A.	U. S. A.
WIESLANDER, H.	Sweden

Decathlon:

DONAHUE, J. J.	U. S. A.
HALT, K.	Germany
HOLMÉR, G.	Sweden
KUGELBERG, E.	»
MERCER, E. L. R.	U. S. A.
WICKHOLM, W.	Finland

Throwing the Javelin, best hand:

HALME, J.	Finland
SIKANIEMI, W.	»
ÅBRINK, R.	Sweden

Throwing the Javelin, right and left hand:

HALSE, A.	Norway
JOHANSEN, D. V.	»
LEMMING, E.	Sweden
NILSSON, O.	»
ÅBRINK, R.	»

Throwing the Discus, best hand:

MUCKS, A. M.	U. S. A.
NIKLANDER, E.	Finland
PHILBROOK, G. W.	U. S. A.
TRONNER, H.	Austria

Throwing the Discus, right and left hand:

DUNCAN, J. H.	U. S. A.
FLEETWOOD, F.	Sweden
LIND, C. J.	»
MULLER, E. J.	U. S. A.
NILSSON, E.	Sweden

Throwing the Hammer:

CAREY, D.	Great Britain
JANZON, G.	Sweden
LIND C. J.	»
LINDE, N.	»
OHLSSON, C. R.	»

Putting the Weight, best hand:

MUDIN, I.	Hungary
NIKLANDER, E.	Finland
NILSSON, E.	Sweden
PHILBROOK, G. W.	U. S. A.

Putting the Weight, right and left hand:

AHO, P.	Finland
NILSSON, E.	Sweden
WHITNEY, L. A.	U. S. A.

Cross-Country Race 8,000 m.:

HELLAWELL, H. H.	U. S. A.
JOHANSSON, F. W.	Finland
KYRÖNEN, J. W.	»
LARSSON, B.	Sweden
RICHARDSON, L.	South Africa
SUNDQVIST, J.	Sweden

Marathon Race:

ANDERSSON, C.	Sweden
BOISSIÈRE	France
DAHLBERG, HJ.	Sweden
DUFFY, J.	Canada
ERXLEBEN, J.	U. S. A.
FABRE, E.	Canada
FORSHAW, Jr J.	U. S. A.
FORSYTH, W. C. H.	Canada
GALLAGHER, Jr J. J.	U. S. A.
GREEN, H.	Great Britain
JACOBSSON, S.	Sweden
KWIETON, F.	Austria
LLOYD, E. W.	Great Britain
LORD, F.
LILLEY, T. H.	U. S. A.
LUNDBERG, I.	Sweden
DE MAR, C. H.	U. S. A.
PIGGOT, R. F.	»

SAKELLAROPOULOS, H. P.	Greece
SIMONSEN, A.	Norway
SMITH, H.	U. S. A.
SOCKALEXIS, A.	»
TEWANIMA, L.	»
TOWNSEND, A.	Great Britain
WESTBERG, J.	Sweden

Cycling.

ANDREASEN, B. M.	Norway	MEISSNER I. A.	U. S. A.
APSIT, A.	Russia	MERCREDY, R. J. R.	Ireland
BAIER, P. R.	Germany	MERLIN, E. A.	England
BECHT, J.	U. S. A.	MEYLAND-SMITH, O.	Denmark
BIRKER, R.	Germany	MILLER, J.	Scotland
BJÖRK, G.	Sweden	MORÉN, H.	Sweden
BROWN, F. R.	Canada	MÜLLER, I.	Hungary
CAPELLE, A.	France	MÄNNEL, O.	Germany
DAVEY, C. F.	England	NIELSEN, V.	Denmark
DOWNY, A.	Chili	OLSEN, G.	»
EKSTRÖM, A.	Sweden	PIKE, J. K.	U. S. A.
FRIEDEMANN, A.	Chili	RABE, W.	Germany
GANGET, R.	France	RACINE, J.	France
GAYLER H. H.	England	RAITA, A.	Finland
GIBBON, A. W.	»	RAMES, B.	Bohemia
GUY, F.	Ireland	RAMMER, R.	Austria
HANSEN, A. L.	Norway	RATHMAN, O.	Germany
HANSEN, CH.	Denmark	REIDER, J.	»
HELLENSTEINER, J.	Austria	REINVALD, J. F.	Denmark
HENRIKSEN, P. G. E.	Norway	SMIEL, H.	Germany
HENSZELY, J.	Hungary	STEINERT, J.	U. S. A.
HIGGINS, F. C.	England	STEVENSEN, J.	Scotland
HILL, CH.	Scotland	STEVENSON, D. M.	»
JONES, S. L.	England	THOMSON, R.	»
KANKONEN, J. W.	Finland	TILKANEN, V. O.	Finland
KARLSSON, W.	Sweden	TORRES, J. P.	Chili
KOCH, M.	Germany	VÄRE, F. A. H.	Finland
KOFLER, A.	Austria	WACHA, A.	Austria
KOLLER, C. V.	Chili	WALKER, J.	Ireland
KOPSKY, J. G.	U. S. A.	WALKER, M.	»
KRAMER, R.	Austria	WARROW, G.	Germany
LEMNITZ, F.	Germany	WATSON, G.	Canada
LÜTHJE, C.	»	WILSON, J.	Scotland
MAZUR, G.	Hungary	ZILKER, J.	Austria

Fencing.

Épée Team Competition:

SWEDEN.

Ind. competition with foils:

ALAJMO, E.	Italy
BÉKESSY, B.	Hungary
BERTI, L.	»
MONTGOMERIE R.	Great Britain
SELIGMAN, E.	»

Ind. Épée competition:

BOIN, V.	Belgium
HOLT, M.	Great Britain
SELIGMANN, E.	»
SØRENSEN, E.	Sweden
TOM, L.	Belgium

Ind. Sabre competition:

ANDRÉEFF, W.	Russia
FÓLDES, D.	Hungary
NADI, N.	Italy
SCHENKER, Z.	Hungary
TOTH, P.	Hungary
WERKNER, L.	»

Gymnastics.

Individual competition:

GIORGIO, ZAMPORI	Italy
GUIDO, BONI	»
GUIDO, ROMANO	»
LALU, MARCEL	France
PIETRO, BIANCHI	Italy
TORRES, MARCUS	France

Display:

RUSSIA.

Lawn Tennis (covered courts):

BOSTRÖM, W.	Sweden
GRÖNFORS, T.	»
LARSEN, E.	Denmark
LEFFLER, H.	Sweden
LOWE, F. G.	Great Britain
MÖLLER, F.	Sweden
NYLÉN, C. O.	»

Lawn Tennis (out-of-door courts):

INGERSLEV, V.	Denmark
HEYDEN, A. M.	Germany
SAUMAROKOFF-ELSTON, Count M.	Russia
TAPSCOTT, L. E.	South Africa
THAYSSSEN, A.	Denmark
WENNERGREN, C.	Sweden
ZEMLA, L.	Bohemia

Modern Pentathlon.

BERNHARDT, E.	Austria
GRÖNHAGEN, Å. E.	Sweden
MANNSTRÖM, B. K. A.	»
PATTON J:r, G. S.	U. S. A.
STRANNE, J. S. M.	Sweden

Rowing.

Eights:

AUSTRALASIA.
CANADA.
GERMANY.

Fours, outriggers:

DENMARK.
NORWAY.

Single Sculls:

BUTLER, E. B. Canada

Shooting.

Comp. a)	SOUTH AFRICA:	
Comp. b)	BRIGGS, A. L.	U. S. A.
	BURDETTE, C. L.	»
	BURR, H. G.	Great Britain
	FULTON, A. G.	»
	JERNSTRÖM, V.	Sweden
	OMMUNDSEN, H.	Great Britain
	PLATER, P. E.	»
	WALLENBERG, C.	Sweden
Comp. c)	BARTLETT, H. T.	U. S. A.
	FLODSTRÖM, C. E.	Sweden
	FULTON, A. G.	Great Britain
	HARVEY, G. H.	South Africa
	LEVIDIS, N. M.	Greece
	ROMANDER, N.	Sweden
	VELEZ, R.	Hungary
	WALDAINE, P. DE	Russia
Comp. d)	FRANCE.	
Comp. e)	BJÖRKMAN, T.	Sweden
	HELGERUD, A.	Norway
	JOHANSSON, G. H.	Sweden
	LARSSON, B.	»
	SKATTEBOE, G. G.	Norway
Comp. g)	BOSTRÖM, E.	Sweden
	v. HOLST, H.	»
	KEMP, F. W.	Great Britain
	LESSIMORE, L. E.	»
	LEUSHNER, W. F.	U. S. A.
	MURRAY, R. C.	Great Britain
	PIMM, W. J.	»
Comp. i)	GYLLENKROK, A.	Sweden
	MURRAY, R. C.	Great Britain
	PEPÉ J.	»
Comp. j)	RUSSIA.	
Comp. k)	BOSTRÖM, E.	Sweden
	DE LAVAL, G.	»
	POULTER, H. O.	Great Britain
Comp. m)	CARLBERG, E.	Sweden
	DIETZ, J. A.	U. S. A.
	DE LAVAL, G.	Sweden
	ROEDDER, H.	U. S. A.
	TÖRNMARK, C. J.	Sweden
	TÖRÖK, A., Graf.	Hungary
	WINANS, W.	U. S. A.
Comp. o)	METAXAS, A.	Greece
	PREUSS, A.	Germany
	ROBINSON, HUMBY H.	Great Britain
	SCHNITT, G. A.	Finland
	v. ZEDLITZ UND LEIPE, Freih.	Germany

Comp. q)	CEDERSTRÖM, F.	Sweden
	EKMAN, J. E.	»
	ELBOGEN, H.	Austria
	LARSSON, K. A.	Sweden
	LEUSHNER, W. F.	U. S. A.
	LINDSKOG, S. A.	Sweden
	MICHEL, A.	Austria
Comp. r)	LINDEWALD, E. V.	Sweden
	SÖKJER-PETERSÉN, E.	»

Swimming.

100 m., free style:

BOARDMAN, L.	Australasia
BRETTING, K.	Germany
MC GILLIVRAY, P.	U. S. A.
LONGWORTH W.	Australasia
RAMME, W.	Germany

100 m., back stroke:

BARONYI, A.	Hungary
GROSS, O.	Germany

200 m., breast stroke :

COURTMAN, P.	Great Britain
JULIN, H.	Sweden

400 m., free style:

HEALY, C.	Australasia
VON LAS-TORRES, B.	Hungary

400 m., breast stroke:

MALISCH, P.	Germany
------------------	---------

1,500 m., free style :

ANDERSSON, W.	Sweden
--------------------	--------

High, Plain Diving:

ARO, T. N.	Finland
BRANDSTEN, E. M.	Sweden
CRONDAHL, V. G.	»
RUNSTRÖM, A. W.	»

Plain and Variety Diving:

ARBIN, H.	Sweden
CARLSON, ALVIN.	»
JOHANSSON, HJ.	»
YVON, G.	Great Britain

Spring-board Diving:

GAIDZICK, G. W.	U. S. A.
JANSSON, J.	Sweden
POTT, H. E.	Great Britain
ZIMMERMAN, P. M.	Canada
ZÜRNER, A.	Germany

100 m., free style, ladies:

CURWEN, DAISY	Great Britain
ROSENBERG, GRETE	Germany
SPEIRS, ANNIE	Great Britain

High Plain Diving for ladies:

ANDERSSON, ELSA	Sweden
ANDERSSON, SELMA	»
EKLUND, ELLA	»
LARSSON, TORA	»
REGNELL, ELSA	»

800 m., Team Race:

GERMANY.

Water Polo:

AUSTRIA.

Wrestling.

Feather Weight:

HAAGPANEN, LAURI	Finland
LEIVONEN, KALLE	»
LEMUSWIRTA, JALMAR WILHELM	»
ÖBERG, ERIK	Sweden

Light Weight:

BALEJ, JAN	Bohemia
KAPLUR, OSCAR	Russia
KOLEHMAINEN, TATU	Finland
LUND, CARL ERIK	Sweden
NILSSON, JOHAN THEODOR	»
RADVANY, Ödon	Hungary
WIKSTRÖM, VOLMAR	Finland

Middle Weight A:

JOKINEN, AUGUST	Finland
SINT, JAN	Holland
ÅBERG, KARL KONRAD	Finland

Middle Weight B:

RAJALA, AUGUST	Finland
----------------------	---------

Yacht Racing.

8-m. class:

“ÖRN”	Finland
-------------	---------

6-m. class :

“SASS”	
--------------	--

TABLE SHOWING THE NUMBER OF STARTERS IN ALL THE COMPETITIONS OF THE OLYMPIC GAMES OF 1912.

Competition	Australasia	Austria	Belgium	Bohemia	Canada	Chili	Denmark	Egypt	Finland	France	Germany	Great Britain	Greece	Holland	Hungary	Italy	Japan	Luxemburg	Norway	Portugal	Russia	Servia	South Africa	Sweden	Switzerland	Turkey	U. S. A.	Total	
Athletics:																													
100 metres Flat	1	1	3	4	2	1	—	—	—	8	4	9	1	1	5	1	1	—	3	1	4	1	2	12	—	—	10	79	
200 " "	1	2	1	1	3	1	1	—	—	6	5	10	1	1	4	1	1	—	1	2	2	1	9	—	—	10	64		
400 " "	1	1	1	1	1	—	—	—	—	5	6	6	—	—	4	2	1	—	2	1	1	1	5	—	—	9	47		
800 " "	—	—	—	1	2	—	—	—	—	2	4	8	—	—	4	2	—	—	2	1	3	—	4	—	1	10	48		
1,500 " "	—	—	1	1	1	—	—	—	1	1	3	8	—	—	1	1	—	—	2	1	8	—	1	—	—	11	46		
5,000 " "	1	—	—	1	2	—	—	—	3	2	1	8	—	—	1	1	—	—	—	1	1	—	6	—	—	6	32		
10,000 " "	1	—	—	1	1	—	—	—	3	1	1	7	—	—	1	1	—	—	—	1	1	—	6	—	—	5	30		
Marathon Race	1	3	3	4	—	—	2	—	2	2	8	1	—	—	2	2	—	—	3	1	5	1	3	12	—	12	68		
Hurdle Race, 110 metres	—	—	—	1	1	—	—	—	1	2	1	3	—	—	1	2	—	—	1	—	—	—	2	—	—	9	24		
Walking Race, 10,000 metres	1	—	—	1	1	—	3	—	—	—	5	—	—	—	2	1	—	—	—	—	2	—	1	—	—	4	22		
Running High Jump	—	—	—	—	—	—	—	—	1	3	2	2	—	—	1	2	—	—	3	—	—	—	—	—	—	9	29		
Standing " "	—	—	—	—	—	—	—	—	—	1	1	1	—	—	1	—	—	—	1	—	1	—	—	—	—	6	18		
Running Broad Jump	—	2	—	2	—	—	—	—	1	1	1	3	—	—	4	3	—	—	1	—	—	—	4	—	—	7	32		
Standing " "	—	—	—	—	—	—	—	—	—	2	—	2	—	—	1	—	—	—	1	—	—	—	6	—	—	5	19		
Hop, Step and Jump	—	1	—	2	—	—	—	—	1	—	1	—	—	—	—	—	—	—	3	—	—	—	8	—	—	3	22		
Pole Jump	1	—	1	1	—	—	—	—	—	1	1	—	—	—	1	—	—	—	—	3	—	1	—	7	—	8	24		
Throwing the Javelin, best hand	1	—	—	—	—	—	—	—	6	—	3	—	—	—	1	—	—	—	2	—	2	—	10	—	—	—	25		
" " right & left hand	—	—	—	—	—	—	—	—	4	—	4	—	—	—	1	—	—	—	2	—	—	—	8	—	—	—	14		
Throwing the Discus, best hand	2	—	2	1	—	—	—	—	3	2	2	1	—	—	5	1	—	—	—	—	2	—	7	—	1	8	40		
" " right & left hand	2	—	—	—	—	—	—	—	3	—	—	—	—	—	3	—	—	—	—	—	1	—	7	—	—	4	20		
Putting the Weight, best hand	1	—	1	—	—	—	—	—	2	3	2	1	—	—	1	1	—	—	—	—	2	—	1	—	1	4	22		
" " right & left hand	—	—	—	—	—	—	—	—	2	—	—	—	—	—	—	—	—	—	—	—	—	—	1	—	1	3	7		
Throwing the Hammer	—	—	—	1	—	—	—	—	—	—	—	1	—	—	—	—	—	—	—	—	—	—	8	—	—	4	14		
Pentathlon	1	1	1	1	—	—	—	—	1	2	3	—	—	—	1	—	—	—	1	—	—	—	9	1	1	5	26		
Decathlon	1	1	1	1	—	—	—	—	1	2	3	—	—	—	2	—	—	—	1	—	2	—	8	—	1	6	29		
Relay Race 400 metres	4	—	—	4	—	—	—	—	4	4	4	4	—	—	4	—	—	—	—	—	—	—	4	—	—	4	32		
" " 1,600 "	—	—	—	4	—	—	—	—	—	4	4	4	—	—	4	—	—	—	—	—	—	—	4	—	—	4	28		
Team Race 3,000 metres	—	—	—	—	—	—	—	—	5	—	4	5	—	—	—	—	—	—	—	—	—	—	5	—	—	5	24		
Cross-country race 8,000 metres	1	—	—	—	—	7	—	8	1	1	6	—	—	—	—	—	—	—	4	—	—	1	12	—	—	5	46		
Tug-of-War	—	—	—	—	—	—	—	—	—	—	8	—	—	—	—	—	—	—	—	—	—	—	8	—	—	—	16	947	
Cycling:	6	1	5	2	4	8	—	5	12	11	26	—	—	—	5	—	—	—	6	—	10	1	12	—	—	9	123	123	
Fencing:																													
Foils	—	7	9	9	—	6	1	—	—	10	8	1	1	8	10	—	—	—	3	—	10	—	1	9	—	11	104		
Épée Team Competition	—	—	8	8	—	6	—	—	—	8	8	6	7	—	—	—	—	—	8	—	8	—	6	—	—	8	81		
Individual Épée Competition	—	4	11	12	—	6	1	—	—	12	10	8	11	2	—	—	—	—	7	1	7	—	1	7	—	12	112		
Sabre Team Competition	—	8	8	8	—	5	—	—	—	8	7	7	8	8	—	—	—	—	7	1	8	—	8	—	—	—	8	83	
Individual Sabre Competition	—	6	—	—	—	3	—	—	—	5	9	3	12	6	—	—	—	—	—	—	11	—	1	5	—	2	63	443	
Football:	22	—	—	—	—	20	—	15	—	22	18	17	19	14	—	—	—	—	22	—	19	—	33	—	—	22	221	221	
Gymnastics:																													
Team Competition I.	—	—	—	—	—	28	—	—	—	—	—	—	—	—	—	—	—	—	22	—	—	—	24	—	—	—	74		
Team Competition II	—	—	—	—	—	—	—	—	—	16	24	—	—	—	16	16	—	—	16	—	—	—	—	—	—	—	88		
Team Competition III	—	—	—	—	—	20	—	20	—	16	—	—	—	—	6	—	—	—	24	—	—	—	—	—	—	—	96		
Individual Competition	—	—	—	1	—	6	—	5	6	6	—	6	—	—	4	6	—	—	6	—	4	—	—	—	—	—	44		
Displays	—	—	—	—	—	468	—	28	—	—	—	—	—	—	16	6	—	—	22	—	18	—	240	—	—	792	1,094		
Horse Riding Competitions:																													
Military	—	—	4	—	—	3	—	—	4	4	4	—	—	—	—	—	—	—	—	—	—	—	4	—	—	4	27		
Prize Riding	—	—	1	—	—	2	—	—	3	5	—	—	—	—	—	—	—	—	1	—	1	—	6	—	—	2	21		
Prize Jumping, Individual	—	—	2	—	2	—	—	—	3	6	3	—	—	—	—	—	—	—	3	—	6	—	6	—	—	3	31		
" " Team	—	—	3	—	—	—	—	—	4	4	—	—	—	—	—	—	—	—	—	—	4	—	4	—	—	3	22	101	
Lawn Tennis:																													
Gentlemen's Singles (covered courts)	1	—	—	2	—	1	—	—	2	—	—	8	—	—	—	—	—	—	—	—	—	—	8	—	—	—	22		
Ladies' " " " "	—	—	—	—	—	1	—	—	—	—	—	3	—	—	—	—	—	—	—	—	—	—	3	—	—	—	7		
Gentlemen's Doubles " " "	—	—	—	—	—	—	—	—	2	—	—	8	—	—	—	—	—	—	—	—	—	—	6	—	—	—	18		
Mixed " " " "	—	—	—	—	—	2	—	—	—	—	—	6	—	—	—	—	—	—	—	—	—	—	8	—	—	—	16		
Gentlemen's Singles (out-of-door courts)	—	—	—	—	—	8	—	—	3	6	—	—	—	—	1	4	—	—	—	—	—	—	7	—	—	1	49		
Ladies' " " " "	—	—	—	—	—	—	—	—	1	1	—	—	—	—	—	—	—	—	—	—	—	—	5	—	—	—	8		
Gentlemen's Doubles " " "	—	2	—	6	—	8	—	—	2	4	—	—	—	—	4	—	—	—	—	—	2	—	6	—	—	—	42		
Mixed " " " "	—	—	—	—	—	—	—	—	2	2	—	—	—	—	—	—	—	—	—	—	—	—	6	—	—	—	12	174	
Carried forward	8	84	51	75	40	16	6	17	2	122	99	196	260	22	49	150	85	4	41	166	7	148	2	22	60	1	7	228	3,103

TABLE OF DIPLOMAS OF MERIT AWARDED AT THE OLYMPIC GAMES OF 1912.

	Athletics	Cycling	Fencing	Gymna- stics	Lawn Tennis	Modern Pen- tathlon	Rowing	Shooting	Swim- ming	Wrestling	Yacht Racing	Total
Australasia	—	—	—	—	—	—	9	—	3	—	—	12
Austria	2	6	—	—	—	1	—	2	7	—	—	18
Belgium	—	—	2	—	—	—	—	—	—	—	—	2
Bohemia	—	1	—	—	1	—	—	—	—	1	—	3
Canada	7	2	—	—	—	—	10	—	1	—	—	20
Chili	—	4	—	—	—	—	—	—	—	—	—	4
Denmark	1	5	—	—	3	—	5	—	—	—	—	14
Finland	8	4	—	—	—	—	—	1	1	8	6	28
France	1	3	—	2	—	—	—	6	—	—	—	12
Germany	3	11	—	—	1	—	9	2	10	—	—	36
Great Britain	6	16	4	—	1	—	—	13	5	—	—	45
Greece	1	—	—	—	—	—	—	2	—	—	—	3
Holland	—	—	—	—	—	—	—	—	—	1	—	1
Hungary	1	3	6	—	—	—	—	2	2	1	—	15
Italy	—	—	2	4	—	—	—	—	—	—	—	6
Norway	5	3	—	—	—	—	5	2	—	—	—	15
Russia	—	1	1	20	1	—	—	5	—	1	—	29
South Africa	2	—	—	—	1	—	—	7	—	—	—	10
Sweden	30	4	7	—	6	3	—	21	14	3	3	91
U. S. A.	44	5	—	—	—	1	—	8	2	—	—	60
	111	68	22	26	14	5	38	71	45	15	9	424

NUMBER OF ATHLETES ACTUALLY COMPETING IN THE VARIOUS BRANCHES OF ATHLETICS.

Nation	Athletics	Cycling	Fencing	Football	Gymnastics	Horse Riding	Lawn Tennis	Modern Pentathlon	Rowing	Shooting	Swimming	Wrestling	Yacht Racing	Total
Australasia	6	—	—	—	—	—	1	—	10	—	9	—	—	26
Austria	12	6	13	22	—	—	3	1	6	7	20	8	—	98
Belgium	3	1	12	—	—	4	—	—	6	—	12	1	—	39
Bohemia	11	5	14	—	1	—	9	—	1	—	—	4	—	45
Canada	18	2	—	—	—	—	—	—	10	3	3	—	—	36
Chili	6	4	—	—	—	2	—	—	—	2	—	—	—	14
Denmark	15	8	6	20	524	4	10	4	15	14	1	10	3	634
Egypt.....	—	—	1	—	—	—	—	—	—	—	—	—	—	1
Finland	22	5	—	15	60	—	—	—	6	19	12	37	28	204
France	24	12	—	—	6	4	6	2	9	20	10	6	3	102
Germany	24	11	18	22	18	13	7	1	25	11	21	14	—	185
Great Britain.....	71	26	24	18	31	4	11	3	24	38	30	13	—	293
Greece	5	—	12	—	—	—	—	—	—	9	2	1	—	29
Holland	1	—	14	17	—	—	1	1	—	1	—	3	—	38
Hungary.....	27	5	13	19	20	—	4	—	11	12	16	10	—	137
Italy	12	—	11	14	20	—	—	—	—	—	3	6	—	66
Japan	2	—	—	—	—	—	—	—	—	—	—	—	—	2
Luxemburg	2	—	—	—	16	—	—	—	—	—	—	—	—	18
Norway	21	6	8	22	73	3	8	2	24	28	7	9	18	229
Portugal.....	3	—	1	—	—	—	—	—	—	—	—	2	—	6
Russia	32	10	22	19	22	7	2	5	1	27	3	11	17	178
Servia	2	—	—	—	—	—	—	—	—	—	—	—	—	2
South Africa.....	7	1	1	—	—	—	3	—	—	8	1	—	—	21
Sweden	118	12	22	33	244	17	16	12	28	63	64	34	39	702
Switzerland	1	—	—	—	—	—	—	—	—	—	—	—	—	1
Turkey	2	—	—	—	—	—	—	—	—	—	—	—	—	2
U. S. A.	109	9	13	—	—	4	1	1	—	26	9	2	—	174
Totals	556	123	205	221	1,035	62	82	32	176	288	223	171	108	3,282

TABLE SHOWING PROPORTION BETWEEN THE NUMBER OF ENTRIES AND THE ACTUAL NUMBER OF ATHLETES COMPETING.

Branch of Athletics	Number of competitors entered	Actual number of Athletes competing	%	Number of entries for all the competitions*)	Actual number of starters in all the competitions	%
Athletics	841	556	66.1	1,923	947	49.2
Cycling	151	123	81.5	151	123	81.5
Fencing ..	234	205	87.6	587	443	75.5
Football	294 (12 teams)	221 (11 teams)	75.2	294 (12 teams)	221 (11 teams)	75.2
Gymnastics	1,261	1,035	82.1	1,394	1,094	78.5
Horse Riding.....	81	62	76.5	175	101	57.7
Lawn Tennis.....	105	82	78.1	243	174	71.6
Modern Pentathlon	42	32	76.2	42	32	76.2
Rowing	234 (58 boats)	176 (40 boats)	75.2	254 (58 boats)	188 (40 boats)	74
Shooting	333	288	86.5	1,292	794	61.5
Swimming	316	223	70.6	623	346	55.5
Wrestling	267	171	64	267	171	64
Yacht Racing.....	122 (24 yachts)	108 (20 yachts)	88.5	122 (24 yachts)	108 (20 yachts)	88.5
Total	4,281	3,282	76.7	7,367	4,742	64.3

*) The difference between Columns 2 and 5 is caused by the fact that in many cases, the same man was entered for two or more events.

LIST OF COMPETITORS IN THE OLYMPIC GAMES OF
STOCKHOLM, 1912.

Name	Nation	Branch of Athletics	Competition
Aaltonen, A. O.	Finland	Swimming	200 m. breast stroke, 400 m. » »
Aamdes, O. A.	Norway	Athletics	High jump.
Aas, L. T.	»	Fencing	Foils; team Épée; ind. épée.
Aas, R.	»	Football	
Aas, Th. V.	»	Yacht Racing	8 met. class.
Abraham, A. ...	Germany	Athletics	Decathlon.
Abrahams, S. S.	Great Brit.	»	Broad. Jump.
Abrahamsen, I. ..	Norway	Gymnastics	Team Competition III.
Achun, A.	Russia	»	Ind. comp.
Adám, Aladar ...	Hungary	Swimming	Water Polo.
Adam, Alex.	»	»	»
Adam, D.	Luxemburg	Gymnastics	Team Competition II. » » III.
Adam, J.	Germany	Fencing	Team, sabre.
Adams, B. W. ...	U. S. A.	Athletics	High jump; broad jump.
Adams, H.	»	Shooting	a. b. c. e.
Adams, P.	»	Athletics	High jump; broad jump; hop, step and jump.
Adler, M.	Austria	Swimming	100 m. free style. Ladies. 400 m. team. swim. race..
Adlerberg, H. von	Russia	Yacht Racing	8-met. class.
Adlercreutz, N. ..	Sweden	Horse Riding Comp.	Military; Prize jumping; individ.
Adlerz, E. W. ...	»	Swimming	High (plain) diving; plain and variety diving.
Adlerz, M. E. ...	»	»	High (plain) diving; ladies,
Aejmelaens, C. B. E.	Russia	Modern Pentathlon	
Aelter, J.	Belgium	Athletics	100 metres flat; 200 metres flat. Eights; outriggers.
Ahlberg, G.	Sweden	Rowing	Marathon Race.
Ahlgren, A.	»	Athletics	Middle weight B.
Ahlgren, A. O. .	»	Wrestling	8-met. class.
Ahnger, A.	Finland	Yacht Racing	Putting weight, b. h. and r. & l. h.
Aho, P.	»	Athletics	Ladies' Singles; Mixed Doubles.
Aitchison, F. H.	Great Britain	Lawn Tennis (covered courts)	
Akimow, A. ...	Russia	Football	Foils; team sabre; ind. sabre.
Alajmo, E.	Italy	Fencing	Cycling Road Race round Lake Mälär.
Alancourt, G. ...	France	Cycling	b. c. k. m.
Alegria, F.	Chili	Shooting	
Alenitzyn, A. ...	Russia	Lawn Tennis (out-of- door courts)	Gentlemen's Doubles.

Name	Nation	Branch of Athletics	Competition
Alexander, G. R.	Great Britain	Fencing	Ind. épée; foils.
Alfthan, M.	Finland	Yacht Racing	12 -met. class.
Allen, F. H. ...	U. S. A.	Athletics	Broad jump.
Allert, E. A. E.	Denmark	Rowing	Fours, inriggers.
Almlöf, E.	Sweden	Athletics	Hop, step and jump.
Almqvist, A. A.	Russia	Modern Pentathlon	
Almqvist, A. ...	Sweden	Rowing	Eights, outriggers.
Alsleben, A. ...	Russia	Athletics	Decathlon.
Altimani, F.	Italy	»	Walking Race.
Amberger, G. ...	Germany	»	1,500 met. flat; team race 3 000 met.
Ames, G.	Great Britain	Fencing	Ind. épée.
Amphlett, E. M.	»	»	Foils; team épée; ind. épée.
Amundgén, E. ...	Sweden	Rowing	Eights; outriggers.
Amundsen, A. ...	Norway	Gymnastics	Team competition I.
Andersen, A. P.	Denmark	Wrestling	Middle Weight A.
Andersen, A. S.	»	Gymnastics	Team competition III; ind. camp.
Andersen, G. ...	Norway	Football	
Andersen, Hj. N.	Denmark	Gymnastics	Team competition III.
Andersen, J. ...	Norway	Athletics	Cross-country Race.
Andersen, J. ...	»	Gymnastics	Team competition I.
Andersen, N. ...	Denmark	Shooting	a. d.
Andersen, S. ...	Norway	Swimming	High (plain) diving; plain and variety diving.
Anderson, A.E.D.	Great Britain	Athletics	100 met. flat; 200 met. flat.
Anderson, A. L.	Sweden	»	Tug-of-War.
Anderson, G.R.L.	Great Britain	»	Hurdle race.
Andersson, C.	Sweden	»	Marathon Race.
Andersson, C. Ä.	»	Swimming	Water Polo.
Andersson, C. G.	»	Wrestling	Feather Weight.
Andersson, E. H.	»	Swimming	High (plain) diving; Ladies.
Andersson, E. L.	U. S. A.	Shooting	g. i.
Andersson, C. E.	Sweden	Swimming	100 met. free style.
Andersson, Hj. ..	»	Athletics	Cross-country Race.
Andersson, J.	Germany	Wrestling	Feather Weight.
Andersson, J. H.	Sweden	»	Middle Weight B.
Andersson, K. E.	»	Swimming	Water Polo.
Andersson, L. R.	U. S. A.	Athletics	1,500 met. flat.
Andersson, N. G.	Sweden	Swimming	200 m. breast stroke. 400 » » »
Andersson, O. M.	»	Wrestling	Middle Weight A.
Andersson, R. ...	»	Swimming	100 met. free style; plain and variety di- ving; water polo.
Andersson, S. A. M.	»	»	High (plain) diving; Ladies.
Andersson, W. ...	»	»	1,500 met, free style water polo.
Andreassen, B. ...	Norway	Cycling	Cycling Road race round Lake Mälär.

Name	Nation	Branch of Athletics	Competition
André, G. I. ...	France	Athletics	Hurdle race, high jump, broad jump; Pentathlon; Decathlon.
Andreef, Wladimir	Russia	Fencing	Team, sabre; ind. sabre.
Andreas, J.	Austria	Football	
Andstén, C.	Finland	Yacht Racing	8-met. class.
Andstén, J.	»	»	» »
Angell, B.	Norway	Lawn Tennis (out-of-door courts)	Gentlemen's Doubles.
Anker, J.	»	Yacht Racing	12-met. class.
Ankondimoff, A.	Russia	Wrestling	Feather Weight.
Ansén, K. A. ...	Sweden	Football	
Anspach, H. ...	Belgium	Fencing	Foils; team épée; ind. épée team sabre; ind. sabre.
Anspach, P. ...	»	»	Foils; team épée; ind. épée; team sabre; ind. sabre.
Antal, J.	Hungary	Athletics	800 met. flat.
Antonopoulos, A.	Greece	Wrestling	Middle Weight A.
Apelqvist, E.O.E.	Sweden	Swimming	Spring-board diving.
Appelgren, J. ...	»	Football	
Applegarth, W. ...	Great Britain	Athletics	100 met. flat; 200 met. flat; relay race 400 m.
Apsit, A.	Russia	Cycling	Cycling Road race round Lake Mälär.
Aradi, L.	Hungary	Gymnastics	Team competition II.
Arbin, H.	Sweden	Swimming	Plain and variety diving.
d'Arcy, V. H. A.	Great Britain	Athletics	100 met. flat; 200 met. flat; relay race 400 m.
Arenholt, J.	Denmark	Lawn Tennis (out-of-door courts)	Gentlemen's Singles; Doubles.
Armgarth, G. ...	Sweden	Fencing	Foils; team sabre.
Amaud, H. A. ...	France	Athletics	1,500 met. flat; team race 3,000 m.; cross-country race.
Arnesen, K. ...	Norway	Wrestling	Feather Weight.
Amheim, E. ...	Sweden	Lawn Tennis (covered and out-of-door courts)	Ladies' Singles, Mixed Doubles.
Arnheiter, A. ...	Germany	Rowing	Fours; outriggers.
Aro, T. N.	Finland	Swimming	High (plain) diving; plain and variety diving.
Arpe, O.	Italy	Wrestling	Middle Weight B.
Arsenieff, B. ...	Russia	Fencing	Ind. sabre.
Arvidsson, P.O.	Sweden	Shooting	c. e. p. q. r.
Ashington, H. S.	Great Britain	Athletics	Hurdle race; broad jump; hop, step and jump.
Asikainen, A. ...	Finland	Wrestling	Middle Weight A.
Assimacopoulo, A.	Greece	Swimming	100 m. free style.
d' Astafort.	France	Horse Riding comp.	Military; prize riding; prize jumping, ind. & team.
Atkinson, C. ...	Great Britain	Swimming	200 m. breast stroke.
Auba, J. C.	France	Athletics	High jump.

Name	Nation	Branch of Athletics	Competition
Aust, O.	Sweden	Yacht Racing	6-met. class.
Autonen, J. U. ...	Finland	Shooting	e.
Awksentjeff, P. ...	Russia	Swimming	400 m. free style;
Ayde, A.	»	Athletics	1,500 » » » Walking race.
Baasch, U.	»	»	Pole jump; Relay race 1,600 met.
Baastad, E. F. . .	Norway	Football	
Babcock, H. S. ...	U. S. A.	Athletics	Pole jump; Pentathlon.
Babel, R.	Hungary	Gymnastics	Team competition II.
Bacher, E.	Finland	Shooting	n. o.
Backenius, E. I. .	»	Wrestling	Heavy Weight.
Bacon, E. H. ...	Great Britain	»	Middle Weight A.
Bacon, S. V. ...	»	»	» A.
Baden, H.	Denmark	Athletics	Cross country race.
Baiardo, David ..	Italy	Swimming	100 met. free style, 400 » » »
Baier, Rudolf ...	Germany	Cycling	Cycling Road race round Lake Mälär.
Bailey, H. P. ...	Great Britain	Football	
Bajan, A.	Hungary	Rowing	Eights, outriggers.
Bajmakoff, G.	Russia	Swimming	200 m. breast stroke, 400 » » »
Baker, B. H. ...	Great Britain	Athletics	High jump.
Baker, P. J.	»	»	800 m. flat; 1,500 m. flat.
Balej, J.	Bohemia	Wrestling	Light Weight.
Banikas, G.	Greece	Athletics	Pole jump.
Barath, L. von ...	Hungary	Lawn Tennis (out-of- door courts)	Gentlemen's Singles; » Doubles.
Barbesino, L. ...	Italy	Football	
Barkoff, D. de ...	Russia	Shooting	p. r.
Barl, Karl	Austria	Wrestling	Middle Weight B.
Baronyi, András	Hungary	Athletics	Broad jump.
Baronyi, Andreas	»	Swimming	100 m. back stroke.
Barret, E.	Great Britain	Athletics	Tug-of-War.
Barrett, H. F. ...	»	Wrestling	Heavy Weight.
Barrier, A.	France	Athletics	Marathon Race.
Barta, Zdenek ...	Bohemia	Wrestling	Middle Weight A.
Bartholomae, F.	Germany	Fencing	Ind. épée; team sabre.
Bartholomae, W.	»	Rowing	Eights, outriggers.
Bartlett, H. T. ...	U. S. A.	»	» »
Bathe, Walter ...	Germany	Shooting	b. c. e.
		Swimming	200 m. breast stroke, 400 » » »
Battersby, T. S.	Great Britain	»	400 m. free style; 1,500 » » »
			800 » team race.
Baumann, G. ...	Russia	Wrestling	Light Weight.
Baumann, H. ...	»	Athletics	200 m. flat.
Beale, J. G.	Great Britain	»	Marathon race.
Beasley, H. B. ...	Canada	»	100 m. flat: 200 » »
			Relay race 400 met.
Beamish, E. A. ...	Great Britain	Lawn Tennis (covered courts)	Gentlemen's Singles, » Doubles.

Name	Nation	Branch of Athletics.	Competition
Beaufort, J. D. H. de	Holland	Fencing	Team épée; ind. épée;
Becht, John	U. S. A.	Cycling	Cycling Road race round Lake Mälär.
Beckman, A. M.	Sweden	Wrestling	Feather Weight.
Behm, Charles ...	Luxemburg	Gymnastics	Team competition II. » III.
Behrens, K.	Germany	Swimming	High (plain) diving; plain and variety diving; Spring-board diving.
Békessy, Béla ...	Hungary	Fencing	Foils; ind. épée; ind. sabre.
Beleznay, Ladis- laus	»	Swimming	100 m. free style; water polo; 800 m. team race.
Belinsky, B. de	Russia	Shooting	b. c. e.
Bellah, S. H. ...	U. S. A.	Athletics	Pole jump.
Belloni, Gino ...	Italy	Fencing	Foils, team sabre.
Belote, F. V. ...	U. S. A.	Athletics	100 m. flat; High jump; Relay race 400 met.
Belvselvsky, E. ...	Russia	Yacht Racing	10-m. class.
Benckert, C. ...	Sweden	Lawn Tennis (cov- ered & out-of-door courts)	Gentlemen's Singles. » Doubles.
Benedicks, E. ...	»	Shooting	o. q. r.
Benfratello, J. ...	Italy	Fencing	Foils, team sabre, ind. sabre.
Bengtsson, G. ...	Sweden	Football	
Bengtsson, O. ...	»	»	
Bentham, Isaac ...	Great Britain	Swimming	Water Polo.
Beranek, J.	Bohemia	Wrestling	Feather Weight.
Berardo, F.	Italy	Football	
Beresford, J. ...	Great Britain	Rowing	Fours, outriggers.
Bergh, K.	Sweden	Athletics	High jump; broad jump
Bergman, A. ...	»	»	Tug-of- War.
Bergman, P. H.	»	Yacht Racing	12 m. class.
Bergman, Åke ..	»	Swimming	100 m. back stroke.
Bergqvist, A. Th.	»	Wrestling	Middle Weight A.
Bergqvist, Erik ..	»	Football	
		Swimming	100 m. free style; water polo.
Bergsland, Hans	Norway	Fencing	Team épée; ind. épée.
Bergstedt, R. ...	Sweden	Rowing	Eights, outriggers.
Bergström, E. ...	»	Football	
Bergström, K. J.	»	Yacht Racing	12-m. class.
Bergström, O. L.	»	»	»
Bergvall, T.	»	Athletics	Marathon race.
Berkes, Jozsef ...	Hungary	Gymnastics	Team competition II.
Berna, T. S. ...	U. S. A.	Athletics	5,000 m. flat; 3,000 m. team race; cross-country race.
Bernhardt, Edm.	Austria	Modern Pentathlon	
		Shooting	k. m.
Bernstorff, E. ...	Germany	»	n. o.
Berntsen, Oluf ...	Denmark	Fencing	Foils, team épée; ind. épée; ind. sabre.

Name	Nation	Branch of Athletics	Competition
Berré, Marcel ...	Belgium	Fencing	Foils; ind. épée; team sabre.
Berry, A.	Great Britain	Football	
Bertelsen, N. ...	Norway	Yacht Racing	12 -m. class.
Berth, P. L. L.	Denmark	Football	
Berthelsen, J. O. H.	,	Fencing	Foils, team épée, ind. épée, team sabre, ind. sabre.
Berti, Lázló	Hungary	,	Foils, team sabre, ind. sabre.
Bertilsson, P. D.	Sweden	Gymnastics	Team competition I.
Bertrain, Gabr.,	Russia	Fencing	Foils, team épée, ind. épée.
Bes, Louis	France	Cycling	Cycling Road race round Lake Mälär.
Betts, A. E. ...	Great Britain	Gymnastics	Team competition II.
Beulque, P. L. ...	France	Swimming	Water Polo.
Beyer, Hans A.	Norway	Gymnastics	Team competition III.
Betzén, G.	Sweden	Athletics	Broad jump.
Bianchi, Pietro ...	Italy	Gymnastics	Team competition II; Ind. competition.
Bie, F. R.	Norway	Athletics	Hurdle race, broad jump, Pentathlon, Decathlon.
Billings, C. W. ..	U. S. A.	Shooting	n. o.
Binaschi, A.	Italy	Football	
Binner, Walther	Germany	Swimming	100 m. free style.
Biró, Gyda	Hungary	Football	
Birch, Halvor ...	Denmark	Gymnastics	Team competition III.
Birker, Robert...	Germany	Cycling	Cycling Road race round Lake Mälär.
Bisgaard, E.	Denmark	Rowing	Fours, outriggers.
Bjerke, O. G. ...	Norway	Shooting	c.
Björk, E. G. ...	Sweden	Cycling	Cycling road race round Lake Mälär.
Björklund, E. ...	,	Swimming	100 m. free style; ladies.
Björklund, H. ...	Norway	Lawn Tennis (out-of-door courts)	Gentlemen's Singles, Doubles.
Björklund, H. ...	Sweden	Wrestling	Light Weight.
Björkman, C. ...	,	Shooting	a. d. e.
Björkman, T. ...	,	,	a. b. c. e.
Björksten, W. ...	Finland	Yacht racing	10 -m. class.
Björn, E.	Sweden	Athletics	800 m. flat; 1,500 m. flat.
Björnson, H. ...	Norway	Gymnastics	Team competition III.
Björnstad, J.	,	Rowing	Eights, outriggers; Fours, inriggers.
Björnstad, O. ...	,	,	Fours, inriggers.
Bjömström	Finland	Yacht Racing	10 -m. class.
Bjurstedt, M. ...	Norway	Lawn Tennis (out-of-door courts)	Ladies' Singles; Mixed Doubles.
Blaha, A.	Austria	Football	
Black, A. W. ...	Great Britain	Shooting	o.
Blake, John P. ...	,	Fencing	Team épée, ind. épée.
Blakeney, H.E.H.	,	Athletics	100 m. flat; hurdle race.
Blanchard, V. S.	U. S. A.	,	Hurdle race.
Blanchy, F. J. ...	France	Lawn Tennis (out-of-door courts)	Gentlemen's Singles.

Name	Nation	Branch of Athletics	Competition
Blau, H.	Russia	Shooting	o. p. q.
Blau, H.	Austria	Swimming	Water Polo.
Blijenburgh, W. P. H. van ...	Holland	Fencing	Team épée, ind. épée, team sabre.
Blixen-Finecke, H. von.....	Sweden	Horse Riding com- petition	Prize riding.
Blom, O.	Holland	Lawn Tennis (out-of- door courts)	Gentlemen's Singles.
Blomgren, Gust. Blommaert, E. de	Sweden Belgium	Swimming Horse Riding comp.	Plain and variety diving. Military, prize jumping, ind. & team.
Blomqvist, E. ...	Sweden	Shooting	d. e.
Blum, Zoltán ...	Hungary	Football	
Boardman, Leslie	Australasia	Swimming	100 m. free style; 800 m. team race.
Bock, G.	Germany	Shooting	k. l.
Bodley, R.	South Africa	»	a. b. c. d. e.
Bodnár, Sándor	Hungary	Football	
Bodneck, W. ...	Russia	Shooting	
Bodor, Ödön ...	Hungary	Athletics	400 & 800 m. flat; relay race 1,600 m.
Bogen, Albert ...	Austria	Fencing	Team sabre; ind. sabre.
Bohm, C.	Sweden	Football	
Boigne, R. de ...	France	Shooting	a. b. c. d. e.
Boin, Victor ...	Belgium	Fencing	Ind. épée.
Boin, V.	»	Swimming	Water Polo.
Boissière	France	Athletics	Marathon race.
Boivie, G. C. ...	Sweden	Shooting	h. i. k. m.
Bolander, G. ...	»	Athletics	Throwing the discus, b.h.
Boltenstern, G. A.	»	Horse Riding comp.	Prize riding.
Bömches von Boor, E. R.	Hungary	Shooting	a. b. c. e.
Bonde, C.	Sweden	Horse Riding comp.	Prize riding.
Bonfadini, F. ...	Italy	Football	
Bonfanti, C.	»	Swimming	High (plain) diving, spring-board diving.
Bonhag, G. V. ...	U. S. A.	Athletics	5,000 m. flat; 3,000 m. team race; cross country race.
Boni, Guido ...	Italy	Gymnastics	Team competition II; Ind. competition.
Bonneveld, B. ...	Holland	Wrestling	Heavy Weight.
Bontmy, J. W. ...	»	Football	
Bordang, Andre	Luxemburg	Gymnastics	Team competition II; » » III.
Boreischa, P. ...	Russia	Football	
Borissow, F. ...	»	Cycling	Cycling road race round Lake Mälär.
Bos, A. P. AZ' ..	Holland	Fencing	Team épée, ind. épée.
Bosch, Fr.	Russia	Cycling	Cycling road race round Lake Mälär.
Bosch, H.	Germany	Football	
Bossche, G. van den	Belgium	Rowing	Fours, outriggers.
Boström, E.	Sweden	Shooting	g. j. k. m.

Name	Nation	Branch of Athletics	Competition
Boström, W. ...	Sweden	Lawn Tennis (covered & out-of-door courts)	Gentlemen's Singles, » Doubles.
Bothén, B.	»	Yacht Racing	10-m. class.
Bothén, Björn ...	»	»	»
Bouffechoux, J. ...	France	Wrestling	Light Weight.
Bough, S. Ch. ...	Norway	Shooting	b.
Bouin, J.	France	Athletics	5,000 m. flat; cross country race.
Boullery, J.	»	»	100 m. flat.
Bouman J. R., P.	Holland	Football	
Bourne, R. C. ...	Great Britain	Rowing	Eights, outriggers.
Boutoussoff, W. P.	Russia	Football	
Bouvy, N. J. J. ...	Holland	»	
Bowman, W. L.	U. S. A.	Fencing	Foils, team épée, ind. épée.
Boyd, P. E.	Canada	Rowing	Eights, outriggers.
Braglia, Alberto	Italy	Gymnastics	Team competition II, ind. camp.
Brambeck, N. F.	Sweden	Fencing	Team sabre.
Brandes, F. W.	»	Rowing	Fours, inriggers.
Brandsten, E. M.	»	Swimming	High (plain) diving; plain and variety diving; spring-board diving.
Brandstetter, J. ...	Austria	Football	
Branting, Georg	Sweden	Fencing	Ind. épée.
Brasche,	Russia	Yacht Racing	10-m. class.
Braun, H.	Germany	Athletics	400 m. flat; 800 m. flat; relay race 1,600 m.
Braunsteiner, K.	Austria	Football	
Brauer, Th.	Sweden	Athletics	High jump.
Brebner, R. G.	Great Britain	Football	
Brecke, A. B. ...	Norway	Yacht Racing	8-m. class.
Breckinridge, S. D.	U. S. A.	Fencing	Foils; team épée; ind. épée.
Bredakolff, J. G. van	Holland	Football	
Breed, George H.	U. S. A.	Fencing	Foils, team épée; ind. épée.
Brekke, S.	Norway	Football	
Brenner, B.	Finland	Yacht Racing	10-m. class.
Bretting, Kurt ...	Germany	Swimming	100 m. free style; 800 m. team race.
Breunig, M.	»	Football	
Bricker, C. D. ...	Canada	Athletics	Broad jump; hop, step and jump.
Brickley, C.	U. S. A.	»	Hop, step and jump.
Bridge, R.	Great Britain	»	Walking race.
Briggs, A. L. ...	U. S. A.	Shooting	a. b. c. e.
Borbas, Gaspar ...	Hungary	Football	
Broberg, G.	Sweden	Rowing	Eights, outriggers.
Brock, G. M. ...	Canada	Athletics	800 m. flat; relay race 1,600 m.
Brodd, E. A. ...	Sweden	Swimming	Spring-board diving.
Brodi, Sandor ...	Hungary	Football	
Brodtkorb, B. ...	Norway	Athletics	High jump; broad jump.

Name	Nation	Branch of Athletics	Competition
Broeske, M.....	Germany	Rowing	Eights, outriggers.
Brookfield, E. W.			
Hamilton	Great Britain	Fencing	Team sabre; ind. sabre.
Broquedis, M.	France	Lawn Tennis (out-of-door courts)	Ladies' singles; Mixed doubles.
Brown, Fr. R....	Canada	Cycling	Cycling road race round Lake Mälär.
Bruhn-Möller, W.	Sweden	Rowing	Eights, outriggers; Fours, inriggers.
Brulé, Georges...	France	Modern Pentathlon	
Brundage, A. ..	U. S. A.	Athletics	Throwing the discus b. h.; Pentathlon; Decathlon.
Brunkman, C. ...	Sweden	Rowing	Eights, outriggers; Fours, inriggers.
Brunkman, G. ...	»	»	Eights, outriggers.
Brusewitz, E. ...	»	Lawn Tennis (out-of-door courts)	Ladies' Singles.
Brustad, Georg...	Norway	Gymnastics	Team competition I.
Bruun, C. H. ...	»	Shooting	
Brülle, Wilhelm	Germany	Gymnastics	Team competition II » » III.
Bräthe, J.....	Norway	Shooting	c. e.
Buchfelder, H....	Austria	Swimming	Water Polo.
Buchfelder, R. ...	»	»	»
Buchwald, C. ...	Denmark	Football	
Buder, J. E.....	Germany	Gymnastics	Team competition II » » III.
Buerkner	»	Horse Riding comp.	Prize riding.
Bugbee, Ch.....	Great Britain	Swimming	Water Polo.
Bukse, J.	Russia	Cycling	Cycling road race round Lake Mälär
Burdekin, B. ...	Great Britain	Rowing	Eights, outriggers.
Burdette, C. L.	U. S. A.	Shooting	a. b. c. e.
Burdick, J. W....	»	Athletics	High Jump.
Burger, K.	Germany	Football	
Burgess, E. R....	Great Britain	Rowing	Eights, outriggers.
Burkowitz, H. ...	Germany	Athletics	400 m. flat; relay race 1,600 m.
Burn, T. C.	Great Britain	Football	
Burr, H. G.....	»	Shooting	a. b.
Burt, H.	»	»	g. i.
Burton, R.	»	Athletics	800 m. flat.
Butler, E. B. ...	Canada	Rowing	Single Sculls.
Butt, J. H.	Great Britain	Shooting	n. o.
Butterworth, H.	»	Fencing	Team sabre, ind. sabre.
Byl, Ch. van der	»	»	Ind. épée; ind. sabre.
Byrd, R. L.....	U. S. A.	Athletics	High jump, broad jump, throwing the discus b. h., r. & l. h.
Bäuerle, O.	Germany	»	Hop, step and jump; Pentathlon.
Börjesson, E. ...	Sweden	Football	
Börjesson, J. ...	»	»	
Bökman, O.....	»	Shooting	o.
Böling, I. Th....	Finland	Wrestling	Middle Weight B.
Bönninghausen, H. von.....	Germany	Athletics.	Hurd race.

Name	Nation	Branch of Athletics	Competition
Böysen, Trygve	Norway	Gymnastics	Team competition I.
Böös, Gunnar M.	Sweden	Fencing	Foils.
Cabal, R.	France	Wrestling	Light Weight.
Caby, A.	»	Swimming	1,500 m. free style; water polo.
Caldwell, D. ...	U. S. A.	Athletics	800 m. flat.
Calvi, G.	Italy	»	800 m. flat; 1,500 m. flat.
Cambas, P. A. ...	Greece	Fencing	Ind. épée.
Campana, A. ...	France	Athletics	Broad jump.
Campelli, P. ...	Italy	Football	
Canet, A. H. ...	France	Lawn Tennis (out-of-door courts)	Gentlemen's Singles; » Doubles.
Capelle, A.	»	Cycling	Mixed » Cycling road race round Lake Mälär.
Carcereri, Z. ...	Italy	Wrestling	Middle weight A.
Carey, D.	Great Britain	Athletics	Throwing the hammer.
Caridia, G. A. ...	»	Lawn Tennis (covered courts)	Gentlemen's Singles; » Doubles.
Cariou, J.	France	Horse Riding comp.	Military, prize riding, prize jumping, ind. & team.
Carlberg, C. E.	Sweden	Gymnastics	Team competition I.
Carlberg, E. ...	»	Shooting	f. g. h. i. j. k. l. m.
Carlberg, W. ...	»	Modern Pentathlon	
Carlén, G.	»	Shooting	f. g. h. i. j. k. l. m.
Carlén, G.	»	Athletics	Cross country race.
Carlson, A.	»	Swimming	Plain and variety diving.
Carlsson, C. ...	»	Football	
Carlsson, Greta	»	Swimming	100 m. free style; ladies; 400 m. team race, ladies.
Carr., G.	Great Britain	Rowing	Fours, outriggers.
Carroll, T.	»	Athletics	High jump; hop, step and jump.
Case, J. R.	U. S. A.	»	Hurdle Race.
Casparsson, E. G.	Sweden	Horse Riding comp.	Military, prize jumping, ind.
Castella, S. A. ...	Denmark	Football	
Castenschiöld, S.	»	Lawn Tennis (covered courts)	Ladies' Singles; Mixed Doubles.
Castex, H. de ...	France	Shooting	m. n. o.
Castorina, Carlo	Italy	Fencing	Foils.
Cate, C. H.	Holland	Football	
Caulle, J.	France	Athletics	800 m. flat.
Cavallini, F. ...	Italy	Fencing	Foils; team sabre; ind. sabre.
Cederberg, H. E.	Finland	Swimming	200 m. breast stroke.
Cederschiöld, H.	Sweden	Shooting	k. m.
Cederschiöld, M.	»	Lawn Tennis (covered courts)	Ladies' Singles; Mixed Doubles.
Cederström, A. F. T. ...	»	Shooting	q.
Chaffe, W.	Great Britain	Athletics	Tug-of-War.
Chambopoulos ...	Greece	Fencing	Ind. épée; team épée.
Champion, M. ...	Australasia	Swimming	400 m. free style; 1,500 » » » 800 » team race.

Name	Nation	Branch of Athletics	Competition
Charlet, O.	Germany	Rowing	Eights, outriggers.
Childs, C. C. ...	U. S. A.	Athletics	Throwing the hammer.
Chisholm, G. A.	»	»	Hurdle race.
Chkileff, Alex....	Russia	Fencing	Team sabre; ind. sabre.
Choultz, A.	»	Athletics	Broad jump: Decathlon.
Christensen, C. ..	Norway	Gymnastics	Team competition I.
Christensen, J....	Denmark	Athletics	Marathon race.
Christensen, J. H.	»	Wrestling	Middle weight B.
Christensen, Sö- ren P.	»	Gymnastics	Team competition I.
Christiansen, E.	Norway	Yacht Racing	6-m. class.
Christiansen, H.	»	»	»
Christiansen, L.	»	Athletics	Cross country race.
Christoffersen, H. J.	Denmark	Football	
Chromoff, N. A.	Russia	»	
Ciai, Mariano ...	Italy	Wrestling	Feather weight.
Cimera, R.	Austria	Football	
Cipera, Josef ...	Bohemia	Fencing	Team sabre.
Clason, H. A. A.	Sweden	Yacht Racing	12-m. class.
Clemenz, J.	Norway	Football	
Clemmensen, E.	Denmark	Rowing	Fours, outriggers.
Clilverd, R. E....	Great Britain	Modern Pentathlon	
Cockings, P. H.	»	Wrestling	Feather weight.
Colbachini, D....	Italy	Athletics	Hurdle race.
Collan, E. J. ...	Finland	Shooting	n. o.
Colas, P. R. ...	France	»	a. b. c. d. e.
Collin, K. G. A.	Sweden	Swimming	1,500 m. free style.
Connes, E.	France	»	Water Polo.
Convert, P.	Belgium	Horse Riding comp.	Military, prize jumping, team.
Cooke, C. L. ...	U. S. A.	Athletics	200 m. flat; relay race 400 m.
Cooke, Stenson..	Great Britain	Fencing	Ind. foils; ind. épée.
Corble, A. H....	»	»	Team sabre; ind. sabre.
Corkery, J. J. ...	Canada	Athletics	Marathon race.
Comeliussen, T.	Norway	Yacht Racing	8-m. class.
Correa, Fem. ...	Portugal	Fencing	Ind. épée.
Corsar, George..	Great Britain	Cycling	Cycling road race round Lake Mälär.
Cortesao, A. Z....	Portugal	Athletics	400 m. flat: 800 m. flat.
Comett, G. Th.	Great Britain	Swimming	Water Polo.
Costa, Antoine...	France	Gymnastics	Ind. comp.
Cottrill, W.	Great Britain	Athletics	1,500 m. flat; team race 3,000 m.; cross country race.
Cotzias, C.	Greece	Fencing	Team épée; ind. épée.
Courbet, F.	Belgium	Swimming	200 m. breast stroke; 400 » » » water polo.
Courtman, P. ...	Great Britain	»	200 m. breast stroke; 400 » » »
Courtney, J. I....	U. S. A.	Athletics	100 m. flat; 200 m. flat; relay race 400 m.
Covre, A.	Italy	Wrestling	Light weight.
Cowhig, W.	Great Britain	Gymnastics	Team competition II; ind. comp.

Name	Nation	Branch of Athletics	Competition
Coyle, F. J.....	U. S. A.	Athletics	Pole jump.
Craig, R. C. ...	»	»	100 m. flat; 200 m. flat.
Crawshay, R. O.	Great Britain	Fencing	Team sabre.
Crequi-Montfort, de.....	France	Shooting	1. m. n. o.
Cron Dahl, V. G.	Sweden	Swimming	High (plain) diving.
Cross, Sidney ...	Great Britain	Gymnastics	Team competition II.
Csejthe, Z. Je- lenffy-Töth v.	Hungary	Shooting	b. c. e. k.
Curwen, Daisy...	Great Britain	Swimming	100 m. free style; ladies.
Cuzna, H.	Austria	Rowing	Fours, outriggers.
Cvetko, R.	»	Fencing	Foils, team sabre.
Dahl, J.	Sweden	Athletics	Throwing the javelin, b.h.
Dahl, N.	Norway	»	Cross-country race.
Dahlberg, Hj. ...	Sweden	»	Marathon race.
Dahlbäck, H. ...	»	Rowing	Eights, outriggers.
Dahlin, J.	»	Athletics	Fours, inriggers.
Dahll, O.	Norway	Rowing	400 m. flat; relay race
Dahlström, E. ...	Sweden	Football	1,600 m.
Dalberg, A. Th.	»	Wrestling	Fours, outriggers.
Danild, F.	Denmark	Athletics	Middle weight A.
Danitch, W. ...	Russia	Fencing	Cross-country race.
Daranyi, A. von.	Hungary	Shooting	Team sabre, ind. sabre.
Davenport, I. N.	U. S. A.	Athletics	C.
Davey, C. F. ...	Great Britain	Cycling	400 m. flat; 800 m. flat;
Davidoff, G. de.	Russia	Shooting	relay race 1,600 m.
Davidson, O. ...	Norway	Rowing	Cycling road race round
Davies, R. F. ...	Great Britain	Shooting	Lake Mälär.
Davies, W. R. ...	Canada	»	a. b. c. e.
Dauids, A.	Germany	Fencing	Fours, outriggers.
Dawson, P. M. ...	Great Britain	»	b. c.
Dawe, L. S.	»	Football	o.
Decoin, H.	France	Swimming	Foils.
Decoteau, A. ...	Canada	Athletics	Team épée, ind. épée,
Degnes, O. C. ...	Norway	Shooting	foils.
Dehn, W.	Germany	Rowing	Water Polo.
Deichler, E. ...	Chili	Horse Riding comp.	5,000 m. flat.
Delaby, M. F. L.	France	Athletics	a. b.
Deloch,	Germany	Horse Riding comp.	Shooting
Delloye, F.	Belgium	Athletics	Eights, outriggers.
Demjan, O.	Hungary	Swimming	Prize jumping; ind.
Demarchi, C. ...	Italy	Football	100 m. flat; hurdle race.
Denver, H. P. C.	Denmark	Shooting	Prize jumping, ind. and
Derbyshire, J. H.	Great Britain	Swimming	team.
Dereani, F.	Austria	Fencing	1,500 m. flat.
Déván, I.	Hungary	Athletics	200 m. breast stroke:
Devecchi, B. ...	Italy	Football	400 » » »
			e. f.
			100 m. free style.
			Foils, ind. sabre, team
			sabre.
			200 & 400 m. flat;
			relay race 1,600 m.

Name	Nation	Branch of Athletics	Competition
Diana, D.	Italy	Fencing	Foils.
Dickason, H. ...	Great Britain	Gymnastics	Team competition II.
Dietz, J. A.....	U. S. A.	Shooting	j. k. l. m.
Dines, J.	Great Britain	Football	
Dixon, C. P. ...	»	Lawn Tennis (covered courts)	Gentlemen's Singles, » Doubles, Mixed Doubles.
H. I. H. Grand Due Dmitry...	Russia	Horse Riding comp.	Prize jumping, ind. & team.
Dobrijansky, A. de	»	Shooting	b. c. e. g. i. p. q.
Dodds, J.	Great Britain	Swimming	Water Polo.
Dolfen, P. J. ...	U. S. A.	Shooting	j. k. m.
Domenichelli, G.	Italy	Gymnastics	Team competition II.
Domonkos, G. ...	Hungary	Football	
Donahue, J. J. ...	U. S. A.	Athletics	Pentathlon, Decathlon.
Donners, H. ...	Belgium	Swimming	Water Polo.
Doorman, J.	Holland	Fencing Modem Pentathlon	Team épée, team sabre.
Dorizas, M.	Greece	Athletics	Throwing the discus, b.h.; putting the weight, b.h.
Dormald, L. G.	Great Britain	Rowing	Eights, outriggers.
Doyle, B. J.	»	Cycling	Cycling road race round Lake Mälär.
Dowler, J.	»	Athletics	Tug-of-War.
Downey, V. A.	Chili	Cycling	Cycling road race round Lake Mälär.
Drescher, L. ...	Denmark	Football	
Dressel, Vally ...	Germany	Swimming	100 m free style, ladies; 400 m team race, ladies.
Drew, H. P. ...	U. S. A.	Athletics	100 m. flat; 200 m. flat
Drubina, I.	Hungary	»	Walking race.
Drury, H. J. ...	Great Britain	Gymnastics	Team competition. II.
Dubourdiou, V. ...	France	Rowing	Fours, outriggers.
Due, P.	Norway	Football	
Duffy, J.	Canada	Athletics	Marathon race.
Dukes, G. B. ...	U. S. A.	»	Pole jump.
Dulnig, J.	Austria	Shooting	b. c.
Dumbill, T. H.	Great Britain	Athletics	Walking race.
Dumrauf, A. ...	Germany	Wrestling	Light weight.
Duncan, J. H. ...	U. S. A.	Athletics	Throwing the discus, b.h. and r. & l. h.
Duncan, R. C. ...	Great Britain	»	100 m. flat, 200 m. flat.
Dunay, B.	Hungary	Fencing	Foils, ind. sabre.
Durack, Fanny...	Australasia	Swimming	100 m. free style, ladies.
Durant, A. P. ...	Belgium	»	Water Polo.
Durant, H.	Great Britain	Shooting Modem Pentathlon	j. k. l.
Dybeck, G. W.	Sweden	Shooting	r.
Dyrberg, J. A. ...	Denmark	Football	
Eck, W. M.	Holland	»	
Edman, J. V. ...	Sweden	Athletics	Tug-of- War.
Edmundson, C. ...	U. S. A.	»	400 m. flat, 800 m. flat.
Edström, E. M.	Sweden	Swimming	High(plain)diving; ladies.
Eggebrecht, F. ...	Germany	Rowing	Eights, outriggers.
Ehmreich, P. ...	Austria	Athletics	Broad jump.

Name	Nation	Branch of Athletics	Competition
Eichhorn, C. ...	Germany	Rowing	Eights, outriggers.
Eilenbrecht, P. ...	Holland	Wrestling	Light weight.
Eitel, P.	Chili	Athletics	100 m. flat; 200 m. flat; hurdle race.
Ekberg, G. M. ...	Sweden	Football	
Ekberg, R.	»	Athletics	100 m. flat; broad jump.
Ekblad, K. E. E.	»	Gymnastics	Team competition I.
Eke, J.	»	Athletics	10,000 m. flat; cross country race.
Ekholm, K. V. ...	Finland	Gymnastics	Team comp. III; ind. comp.
Ekimoff, M.	Russia	Horse Riding comp.	Prize riding.
Eklund, E. D. ...	Sweden	Swimming	High (plain) diving; ladies.
Eklund, E. R. ...	»	»	Plain and variety diving, spring-board diving.
Ekman, J. E. ...	»	Shooting	n. o. q. r.
Ekman, K. S. ...	»	Wrestling	Middle weight B.
Ekman, L.	»	Athletics	High jump.
Ekroth, H. A. ...	»	Football	
Ekstrand, G. ...	»	Swimming	High (plain) diving.
Ekström, A.	»	Cycling	Cycling road race round Lake Mälär.
Ekwall, H. K. ...	Chili	Shooting	b. c. k. m.
Elbogen, H. ...	Austria	»	p. q. r.
Elichagaray, F. ..	France	Rowing	Fours, inriggers; » outriggers.
Elizarof, A.	Russia	Athletics	800 m. flat; 1,500 m. flat.
Eller Jr., J. J. ...	U. S. A.	»	Hurdle race; Pentathlon.
Endrerud, H. ...	Norway	Football	
Enell, K. H. A.	Sweden	Fencing	Ind. épée.
Engebretsen, E.	Norway	Gymnastics	Team comp. I.
Engebretsen, K.	»	Football	
Engelmann, W.	Germany	Gymnastics	Team comp. II. » » III.
Engelsen, A. ...	Norway	Swimming	High (plain) diving,
Engelstad, O. ...	»	Gymnastics	Team comp III.
Enright, H. B. ...	U. S. A.	»	Team comp. I.
Erckrath, I. de Bary	Germany	Athletics	High jump.
Erickson, E. R.	U. S. A.	Fencing	Ind. épée, team épée, team sabre.
Ericksson, G. L.	Sweden	Athletics	High jump.
Ericksson, H. ...	»	Shooting	g. i. k.
Ericksson, F. ...	»	Athletics	Pentathlon.
Ericksson, F. ...	»	Yacht Racing	10-m. class.
Ericksson, S. ...	»	Rowing	Eights, outriggers.
Eriksen, B. G. ...	Norway	Rowing	Foils, ind. épée, team épée,
Eriksen, E.	»	Fencing	Fours, outriggers.
Eriksen, I.	Denmark	Rowing	Team comp. I.
Eriksen, J. Th. ...	»	Gymnastics	Team comp. I.
Eriksen, M. ...	»	Wrestling	Middle weight B.
Erikson, M. ...	Norway	Gymnastics	Team comp. I.
Erikson, A.	Sweden	Gymnastics	Team comp. I.
Eriksson, H. A.	»	Rowing	Fours, outriggers.
Eriksson, M. ...	»	Shooting	o.
Eriksson, T. J. ...	»	»	a. b. d. e.
Eriksson, T. J. ...	»	Swimming	High (plain) diving.
Erleben, J.	U. S. A.	Athletics	Marathon race.
Erödy, I.	Hungary	Gymnastics	Team comp. II.

Name	Nation	Branch of Athletics	Competition
Eskola, J.	Finland	Athletics	Cross-country race.
Espelund, J.	Norway	Shooting	c.
Estlander, E. ...	Finland	Yacht Racing	6 p.m. class.
Eulenberg, J. ...	Russia	Cycling	Cycling road race round Lake Mälär.
Everritt, A. F. G.	Great Britain	Fencing	Ind. épée, team épée.
Eyrich, T. H. C.	Denmark	Rowing	Fours, outriggers.
Fabre, E.	Canada	Athletics	Marathon race.
Fabritius, E. E.	Finland	Shooting	
Fagan, A. W. ...	Great Britain	Fencing	Foils
Fahr, O.	Germany	Swimming	100 m. back stroke.
Failliot, P.	France	Athletics	100 m. flat; 200 m. flat; Pentathlon; Decathlon; relay race 400 m.; relay race 1,600 m.
Falch-Lund, E. ...	Norway	Yacht Racing	12-m. class.
Falche, G.	Denmark	Gymnastics	Team competition I.
Falk, E.	Sweden	Athletics	Throwing the javelin, b.h.
Falkenberg, I. C.	Norway	Horse Riding competition	Prize riding; prize jumping, ind.
Farber, J.	Russia	Yacht Racing	8-m. class.
Farkas, A. von. ...	Hungary	Shooting	a. b. c. e.
Farnest, N.	Russia	Wrestling	Heavy weight.
Farrel, E. L. ...	U. S. A.	Athletics	Broad jump; hop, step and jump.
Faure, M.	France	Shooting	1. m.
Faworski, L. ...	Russia	Football	
Fazer, K.	Finland	Shooting	n. o.
Fegth, H.	Norway	Rowing	Eights, outriggers; fours, inriggers.
Feilmann, F. E.	Great Britain	Fencing	Team sabre.
Feith, C. W. ...	Holland	Football	
Fekete, M.	Hungary	»	
Fick, S.	Sweden	Lawn Tennis (covered & out-of-door courts)	Ladies' Singles, Mixed doubles.
Fickeisen, O. ...	Germany	Rowing	Fours, outriggers.
Fickeisen, R. ...	»	»	» »
Filatoff, P.	Russia	Fencing	Ind. sabre.
Filippoff, A. ...	»	Football	
Filippoff, S. P. ...	»	»	
Finne, S.	Norway	Fencing	Ind. épée, team épée.
Finnerud, P. ...	»	Athletics	Cross-country race.
Fischer, V.	Austria	Wrestling	Light weight.
Fischera, A. ...	»	Football	
Fison, W. G. ...	Great Britain	Rowing	Eights, outriggers.
Fitzgerald, E. J.	U. S. A.	Athletics	5,000 m. flat.
Fitzhardinger, R. B.	Australasia	Rowing	Eights, outriggers.
Fixdal, N.	Norway	Athletics	100 m. flat; broad jump; hop, step and jump; relay race 400 m.
Fjåstad, N.	Sweden	»	Pentathlon.
Fleetwood, F. ...	»	»	Throwing the discus b.h., r. & l. h.
Fleischer, F. ...	Austria	»	100 m. flat; relay race 400 m.

Name	Nation	Branch of Athletics	Competition
Fleming, Ph. ...	Great Britain	Rowing	Eights, outriggers.
Fletcher, F.....	U. S. A.	Athletics	High jump; broad jump.
Fletcher, Jennie	Great Britain	Swimming	100 m. free style, ladies.
Fleury, A.	France	Shooting	n. o.
Flodström, C. E.	Sweden	»	c.
Flotow, von	Germany	Horse Riding comp	Prize riding.
Flygare, B. E....	Sweden	Wrestling	Light weight.
Fock, B.	»	Athletics	10,000 m. flat; team race 3,000 m.; cross country race.
Fogelmark, R... »	»	Wrestling	Middle weight B.
Fonbaek, O. ...	Norway	Athletics	Marathon race.
Forgacs, F.....	Hungary	»	800 m. flat; 1,500 m. flat.
Forsberg, F. W.	Sweden	Yacht Racing	10-m. class.
Forshaw J.r. J....	U. S. A.	Athletics	Marathon race.
Forsman, O. E.	Finland	Rowing	Fours, outriggers.
Forsström, E. ... »	»	Gymnastics	Team competition III.
Forsyth, W. A.	Canada	Athletics	Marathon race.
Fortgens, G. ...	Holland	Football	
Foster, W.	Great Britain	Swimming	400 m. free style; 1,500 » » » 800 » team race.
Fothi, S.	Hungary	Athletics	Throwing the discus b.h.
Foti, S. »	»	Gymnastics	Team competition II.
Fournelle, P. ...	Luxemburg	Athletics	Broad jump.
Franck, A.	Finland	Yacht Racing	10-m. class.
Francom, S.....	Great Britain	Athletics	Marathon race.
Frandsen, R. P.	Denmark	Rowing	Fours, outriggers.
Frank, A. P. R.	Sweden	Wrestling	Middle weight A.
Franklin, B. W.	Great Britain	Gymnastics	Team competition II.
Frantzen, J. P... »	Luxemburg	»	Team competition II; III.
Franzl, V.	Austria	Athletics	Broad jump; pole jump.
Fraser, S.	Australasia	Rowing	Eights, outriggers.
Frederiksen, O.	Denmark	Lawn Tennis (out-of-door courts)	Gentlemen's Singles.
Fredriksson, E.A.	Sweden	Athletics	Tug-of-war.
Fregosi, C.	Italy	Gymnastics	Team competition II.
Freyer.....	Germany	Horse Riding comp.	Prize jumping, ind. & team.
Friberg, E.....	Sweden	Cycling	Cycling road race round Lake Mälär.
Friedemann, A.	Chili	»	Cycling road race round Lake Mälär.
Friedmann, T... »	Hungary	Swimming	Water Polo.
H. R. H. Prince Friedrich Karl	Germany	Horse Riding comp.	Prize jumping, ind. & team.
Friesicke, R. ... »	»	Rowing	Eights, outriggers.
Frigast, P.	Denmark	Lawn Tennis (out-of-door courts)	Gentlemen's Singles.
Friis, R. »	»	Shooting	a. b.
Frisell, E.	Sweden	Athletics	800 m. flat.
Frisell, Hj..... »	»	Shooting	n. o. r.
Fritz J.r. W. H.	U. S. A.	Athletics	Pole Jump.
Frydenlund, R... »	Norway	Wrestling	Light weight.
Frydenlund, Th	»	»	»

Name	Nation	Branch of Athletics	Competition
Frykberg, N.	Sweden	Athletics	1,500 m. flat; team race 3,000 m.
Frykman, G. W. A.	Sweden	Football	
Fuchs, G. E.	Germany	"	
Fuchs, J.	Hungary	Fencing	Team sabre, ind. sabre.
Fuchs, K.	Bohemia	Lawn Tennis (covered & out-of- door courts)	Gentlemen's Singles. " Doubles.
Fulton, A. G.	Great Britain	Shooting	a. b. c.
Fältström, C. E. D.	Sweden	Wrestling	Middle weight A.
Földes, D.	Hungary	Fencing	Foils, team sabre, ind. sabre.
Förderer, F.	Germany	Football	
Gabrielson, A. ...	Sweden	Rowing	Fours, inriggers.
Gabrielson, Ch.	"	"	" "
Gagnet, R.	France	Cycling	Cycling road race round Lake Mälär.
Gaidzik, G. W.	U. S. A.	Swimming	High (plain) diving; plain and variety diving; spring-board diving.
Gajeffsky, P. ...	Russia	Athletics	400 m. flat.
Gale, B. R.	Canada	Rowing	Eights, outriggers.
Gallager Jr., J. J.	U. S. A.	Athletics	Marathon race.
Gallon, T. H.	Canada	"	400 m. flat; relay race 1,600 m.
Gardini, R.	Italy	Wrestling	Middle weight K.
Gargano, A. ...	"	"	Middle weight A.
Gamier, Ch. ...	France	Rowing	Fours, inriggers.
Garp, Th.	Denmark	Gymnastics	Team competition I.
Garton, A. S.	Great Britain	Rowing	Eights outriggers.
Gate, W. P.	South Africa	Fencing	Ind. épée, foils, ind. sabre.
Gayler, H. H. ...	Great Britain	Cycling	Cycling road race round Lake Mälär.
Gelfort, G.	Germany	Rowing	Eights, outriggers.
Gellert, I.	Hungary	Gymnastics	Team competition II, ind. competition.
Gentil, P.	France	Shooting	a. b. c. d. e. f. i.
Georgiades, J. N.	Greece	Fencing	Ind. épée.
Gerde, O.	Hungary	"	Team sabre, ind. sabre.
Gerhardt, P. C.	U. S. A.	Athletics	100 m. flat; 200 m. flat.
Germot, M.	France	Lawn Tennis (covered courts)	Gentlemen's Singles. " Doubles.
Germs, J. E. C. van	Holland	Fencing	Ind. épée.
Gerlow, P.	Denmark	Shooting	c. e. f. g. i.
Gerstacker; G. ...	Germany	Wrestling	Feather weight.
Gerstmans, L. ...	Belgium	"	Heavy weight.
Gibbon, A. W. J.	Great Britain	Cycling	Cycling road race round Lake Mälär.
Gignoux, J. E. ...	U. S. A.	Fencing	Foils, team épée, ind. épée.
Gillan, J. A. ...	Great Britain	Rowing	Eights, outriggers.
Gille, K.	Sweden	Athletics	Pole jump.
Gillespie, T. C.	Great Britain	Rowing	Eights, outriggers.

Name	Nation	Branch of Athletics	Competition
Gillis, D.	Canada	Athletics	Throwing the discus b. h.: throwing the ham- mer.
Giongo, F.	Italy	"	100 m. flat; 200 m. flat; 400 m. flat.
Girsén, C. o. ...	Finland	Yacht Racing	8-m. class.
Gitareff, B.	Russia	Football	
Gitsham, C. W.	South Africa	Athletics	Marathon race.
Glad, Th.	Norway	Yacht Racing	8-m. class.
Glaser, J.	Germany	Football	
Gleason, E. F. ...	U.S. A.	Shooting	n. o.
Glockauer, A. ...	Germany	Gymnastics	Team competition IX, team competition III.
Glommes, M. ...	Norway	Shooting	a. c.
Glover, E.	Great Britain	Athletics	5,000 m. flat; 10,000 m. flat; cross country race.
Gobert, A. H. ...	France	Lawn Tennis (covered courts)	Gentlemen's Singles, Gentlemen's Doubles.
Goedel, A.	Germany	Shooting	n. o.
Goedel, H.	"	"	n. o. q.
Godfree, D. W.	Great Britain	Fencing	Team sabre, ind. sabre.
Godfrey, G. A. ...	South Africa	Modern Pentathlon	
Goehring, L. ...	U. S. A.	Swimming	100 m. back stroke; 400 m. free style.
Golling, F.	Austria	Athletics	High jump; broad jump.
Gollini, A.	Italy	Fencing	Foils, team sabre, ind. sabre.
Gompogne, A. ...	France	Gymnastics	Team competition II.
Gonder, F.	"	"	Ind. competition.
Goodwin, J. M.	Great Britain	Athletics	Pole jump.
Goppold de Lobs- dorf, K.	Bohemia	Shooting	n.
Goppold de Lobs- dorf J:r, V. ...	"	Fencing	Ind. épée.
Goppold de Lobs- dorf S:r, V. ...	"	"	Team épée; ind. épée.
Gore, A. W. ...	Great Britain	"	Foils, ind. épée, team épée, team sabre.
Gorodetzky, N.	Russia	Lawn Tennis (covered courts)	Gentlemen's Singles, Gentlemen's Doubles.
Gould, A. E. ...	Great Britain	Fencing	Foils.
Goulding, G. H.	Canada	Wrestling	Light weight.
Goworsky, P. ...	Russia	Athletics	Walking race.
Graf, L.	Hungary	Fencing	Ind. épée, team épée, foils.
Grandell, E. ...	Sweden	Rowing	Eights, outriggers.
Granfelt, N. D.	"	Athletics	100 m. flat; 200 m. flat.
Graham, E. F. ...	U.S. A.	Gymnastics	Team competition I.
Graham, J. R. ...	"	Horse Riding comp.	Military.
Grantz, G.	Norway	Shooting	n. o.
Graubard, B. ...	Austria	Rowing	Eights, outriggers, fours, inriggers.
Green, H.	Great Britain	Football	
Greifenfels, A.		Athletics	Marathon race.
Guieber von. ...	Russia	Fencing	Team sabre, ind. sabre.

Name	Nation	Branch of Athletics	Competition
Gregoire, O. ...	Belgium	Swimming	100 m. back stroke, water polo.
Gregory, R. J. ...	Canada	Rowing	Eights, outriggers.
Griez von Ronse, A. D.	Austria	Fencing	Ind. épée.
Griffiths, A. J. ...	Great Britain	Cycling	Cycling road race round Lake Mälär.
Griffiths, D. J. ...	»	Shooting	g. i.
Grijseels Jr., J. ...	Holland	Athletics	100 m. flat, 200 m. flat.
Grimmelmann, H. J. W.	Denmark	Gymnastics	Team competition III.
Grineff, L.	Russia	Fencing	Foils.
Gripe, R. F. ...	Sweden	Yacht Racing	8 m. class.
Groot, H. F. de	Holland	Football	
Gross, K.	Germany	Wrestling	Middle weight B.
Gross, O.	»	Swimming	100 m. back stroke.
Grosvenor, W. P.	Great Britain	Shooting	n. o.
Grote	Germany	Horse Riding comp.	Prize jumping, ind.
Grubb, F. H.	Great Britain	Cycling	Cycling road race round Lake Mälär.
Grubbe, T.	Norway	Football	
Grumpelt, H. J.	U. S. A.	Athletics	High jump.
Grundwald, L. ...	Austria	Football	
Grüner, W.	Sweden	Athletics	Marathon race.
Grünfors, T. ...	»	Lawn Tennis (covered & out-of- door courts)	Gentlemen's Singles, Gentlemen's Doubles, Mixed doubles.
Grönfors, Th. ...	»	Yacht Racing	8-m. class.
Grönhagen, Å. E.	»	Fencing	Ind. épée
Grönvall, N. R. J.	»	Modern Pentathlon	
Guldbrandsen, K. J.	Norway	Fencing	Foils.
Gullaksen, R. ...	»	Cycling	Cycling road race round Lake Mälär.
Gumpel, M.	Sweden	Wrestling	Feather weight.
Gundersen, A. ...	Norway	Swimming	Water Polo.
Gustafsson, E. ...	Sweden	Wrestling	Middle weight A.
Gustafsson, K. ...	Sweden	Shooting	b.
Gustafsson, K. ...	»	Athletics	Marathon race.
Gustafsson, K. ...	»	Football	
Gustafsson, N. O.	»	»	
Gustafsson, P. A.	»	Athletics	Tug-of-War.
Guttenstein, M ^{mc}	Belgium	Swimming	100 m. free style. ladies.
Gutterson, A. L.	U. S. A.	Athletics	Broad jump.
Guttman, D. ...	Sweden	»	Marathon race.
Guy, F.	Great Britain	Cycling	Cycling road race round Lake Mälär.
Gylche, V. E. ...	Denmark	Athletics	Walking race.
Gyllenkrook, A.	Sweden	Shooting	i. m.
Günther, P.	Germany	Swimming	Spring-board diving.
Göbel, M. J. ...	Holland	Football	
Götke, K. C. ...	Denmark	Rowing	Fours, outriggers.
Haapanen, L. ...	Finland	Wrestling	Feather weight.
Hack, K.	Austria	Athletics	Marathon race.
Hackberg, W. ...	Sweden	»	Throwing the hammer, Decathlon.

Name	Nation	Branch of Athletics	Competition
Hæggström, N. I.	Sweden	Modern Pentathlon	
Hære, G.	Norway	Rowing	Eights, outriggers; fours, inriggers.
Haff, C. B.	U. S. A.	Athletics	400 m. flat.
Hagander, S.	Sweden	»	Throwing the javelin, r. & l. h.
Hagberg, E.	»	Yacht Racing	6-m. class.
Haglund, A. M.	Finland	Rowing	Single Sculls.
Haglund, K.	Sweden	Athletics	800 m. flat.
Haglund, N. E.	»	Swimming	400 m. free style.
Hagström, E. D.	»	Yacht Racing	8-m. class.
Hahne, H.	Russia	Athletics	200 m. flat.
Haintz, J.	Bohemia	Lawn Tennis (covered courts)	Gentlemen's Singles.
Haislund, J. M.	Denmark	Shooting	a. d. e.
Haley, E. W.	Great Britain	Athletics	200 m. flat; 400 m. flat.
Halik, K.	Bohemia	Wrestling	Light weight.
Hall, F.	U. S. A.	Shooting	n. o.
Hall, Sh.	»	Fencing	Foils, team épée, ind. épée.
Hallberg, G.	Sweden	Athletics	High jump.
Halldorsson, J.	Iceland	»	100 m. flat.
Halme, J.	Finland	»	Hop, step and jump; throwing the javelin, b. h., r. & l. h.
Halmos, G.	Hungary	Gymnastics	Team competition II.
Halpin, T. J.	U. S. A.	Athletics	800 m. flat.
Halse, A.	Norway	»	Throwing the javelin, b. h., r. & l. h.
Halt, K.	Germany	»	Throwing the javelin, b. h.; Putting the weight, b. h.; Pentathlon; Decathlon; relay race; 400 m.
Hammersley, K.	Chili	»	100 m. flat; high jump.
Hammond, G. M.	U. S. A.	Fencing	Foils, team épée, ind. épée.
Hammond, W. K.	Great Britain	Cycling	Cycling road race round Lake Mälär.
Hamrén, O. B. E.	Sweden	Swimming	200 m. breast stroke.
Hannam, E. M.	Great Britain	Lawn Tennis (covered courts)	Ladies' Singles, Mixed doubles.
Hanney, E. T.	»	Football	
Hansen, A.	Denmark	Gymnastics	Team competition III, ind. competition.
Hansen, A. H.	Norway	»	Team competition I.
Hansen, A. L.	»	Cycling	Cycling road race round Lake Mälär.
Hansen, A. M.	Denmark	Gymnastics	Team competition III.
Hansen, C. Ch.	»	Wrestling	Feather weight.
Hansen, C. H. Ch.	»	Cycling	Cycling road race round Lake Mälär.
Hansen, Ch. M.	»	Gymnastics	Team competition III.
Hansen, Fr. O.	»	Wrestling	Light weight.
Hansen, H.	»	Football	
Hansen, H.	»	Wrestling	Middle weight A.
Hansen, H.	Norway	Yacht Racing	12-m. class.
Hansen, H. Tr.	Denmark	Gymnastics	Team competition I.

Name	Nation	Branch of Athletics	Competition
Hansen, J.	Denmark	Gymnastics	Team competition I.
Hansen, J. Ch. ...	"	Rowing	Fours, inriggers.
Hansen, R.	"	Gymnastics	Team competition I.
Hansen, S. P.	"	Football	
Hansen, V. G. ...	"	Lawn Tennis (covered & out-of-door courts)	Gentlemen's Singles, Gentlemen's Doubles.
Hanson, L.	Great Britain	Gymnastics	Team competition II, ind. competition.
Hansson, L.	Sweden	Swimming	200 m. breast stroke, water polo.
Hansson, S.	"	"	200 m. breast stroke.
Happenny, W. ...	Canada	Athletics	Pole jump.
Haraldsen, P. ...	Norway	Football	
Hardwick, H. H. ...	Australasia	Swimming	100 m. free style, 400 m. free style, 1,500 m. free style, 800 m. team race.
Hardy de Beau- lieu, P.	Belgium	Fencing	Ind. épée, team sabre.
Hare, A.	Great Britain	Athletics	1,500 m. flat; 3,000 m. team race.
Haresnape, H. N. ...	"	Swimming	100 m. back stroke.
Harju, E.	Finland	Athletics	1,500 m. flat; team race 3,000 m.; cross-coun- try race.
Hartman, P. R. ...	Denmark	Rowing	Fours, inriggers.
Hartvall, E.	Finland	Yacht Racing	12-m. class.
Hartzell, C.	Sweden	Gymnastics	Team competition I.
Harvey, G. H. ...	South Africa	Shooting	a. b. c. d. e.
Hassanein, A. M. ...	Egypt	Fencing	Foils, ind. épée.
Hatfield, J. G. ...	Great Britain	Swimming	400 m. free style; 1,500 m. free style; 800 m. team race.
Hauenstein, H. ...	Australasia	Rowing	Eights, outriggers.
Hauler, L.	Hungary	Shooting	a. b. c. e. g.
Hauptmanns, J. ...	Germany	Wrestling	Heavy weight.
Hawkins, M. W. ...	U. S. A.	Athletics	Hurdle race.
Hay, Ebba	Sweden	Lawn Tennis (covered courts)	Mixed Doubles.
Hayes, W. E.	Great Britain	Wrestling	Light weight.
Healy, C.	Australasia	Swimming	100 m. free style; 400 m. free style; 800 m. team race.
Hebner, H. J. ...	U. S. A.	"	100 m. free style; 100 m. back stroke; 800 m. team race.
Heckel, B.	Germany	Wrestling	Light weight.
Hedegaard, H. C. ...	Denmark	Swimming	400 m. free style; 1,500 m. free style.
Hedlund, O. F. ...	U. S. A.	Athletics	1,500 m. flat.
Hedman, O. E. ...	Sweden	Football	
Hegner, E.	Hungary	Swimming	
Heikilä, W.	Finland	Athletics	Water Polo.
Heiland, H. W. ...	U. S. A.	"	Cross country race.
Heinrich, A. ...	Austria	Rowing	100 m. flat; 200 m. flat.
Helgerud, A. ...	Norway	Shooting	Single Sculls. b. c. d. e.

Name	Nation	Branch of Athletics	Competition
Hellawell, H. H.	U. S. A.	Athletics	10,000 m. flat; cross country race.
Hellensteiner, J.	Austria	Cycling	Cycling road race round Lake Mälär.
Hellgren, E. ...	Sweden	Athletics	Cross-country race.
Hellmich, O. ...	Hungary	Gymnastics	Team competition II.
Hellström, C. L.	Sweden	Yacht Racing	10-m. class.
Hemmerling, M.	Luxemburg	Gymnastics	Team competition II; team competition III.
Hempel, W.	Germany	Football	
Hendrickx, O. J.	Belgium	Swimming	Water Polo.
Hendrickson, J. H.	U. S. A.	Shooting	n. o.
Henderson, W. E.	Great Britain	Athletics	Throwing the discus, b.h.
Henley, E. J. ...	»	»	400 m. flat; 800 m. flat; relay race 1,600 m.
Hennet, R.	Belgium	Fencing	Foils, team épée, ind. épée, team sabre.
Henning, Th. ...	Sweden	Swimming	200 -m. breast stroke; 400 m. breast stroke.
Henriksen, P. G.	Norway	Cycling	Cycling road race round Lake Mälär.
Henriksson, V. ...	Finland	Rowing	Fours, outriggers.
Henriques, E.	Sweden	Yacht Racing	8-m. class.
Henry, G. V. ...	U. S. A.	Horse Riding comp.	Military, prize riding, prize jumping, team.
Hentges, Fr. ...	Luxemburg	Gymnastics	Team competition II; team competition III; ind. competition.
Hentges, P.	»	»	Team competition II; team competition III; ind. competition.
Henzsely, J.	Hungary	Cycling	Cycling road race round Lake Mälär.
Herczeg, I.	»	Gymnastics	Team competition II.
Herlofson, C. ...	Norway	Football	
Herlofson, H. ...	»	Rowing	Eights, outriggers.
Hermann, M. ...	Germany	Athletics	100 m. flat; 200 m. flat; 400 m. flat; relay race 400 m.; relay race 1,600 m.
Herschend, S. ...	Denmark	Yacht Racing	G-m. class.
Herschmann, O.	Austria	Fencing	Team sabre.
Herseth, M.	Norway	Rowing	Fours, inriggers.
Hestdal, M.	»	Wrestling	Feather weight.
Hetmar, V. E. R.	Denmark	»	»
Heuet, G.	France	Athletics	5,000 m. flat; 10,000 m. flat.
Heyden, H. C. F. Cl. van.	Holland	Football	
Heyden, L. M.	Germany	Lawn Tennis (out-of-door courts)	Gentlemen's Singles; Gentlemen's Doubles.
Heyman, B.	Sweden	Yacht Racing	8-m. class.
Hibbins, F. N. ...	Great Britain	Athletics	5,000 m. flat; 10,000 m. flat; cross country race.
Higgins, F. C. ...	»	Cycling	Cycling road race round Lake Mälär.

Name	Nation	Branch of Athletics	Competition
Hill, A. E.	Great Britain	Swimming	Water Polo.
Hill, Ch.,	»	Cycling	Cycling road race round Lake Mälär.
Hill, G. N.	Australia	Athletics	5,000 m. flat; 10,000 » » b. c. e. f. g. h. i.
Hird, F. S.	U. S. A.	Shooting	
Hirsch, J.,	Germany	Football	
Hjorth, C. H. R.	Sweden	Fencing	Foils.
Hlavay, G.	Hungary	Football	
Hoare, G. R. ...	Great Britain	»	
Hodgetts, S.	»	Gymnastics	Team competition II, ind. comp.
Hodgson, G. R.	Canada	Swimming	400 m. free style; 1,500 » » » k. l.
Hoffman, H. ...	Germany	Shooting	
Hoffman, J.,	Belgium	Swimming	Water polo.
Hoffman, K. ...	Germany	Rowing	Single Sculls.
Hoflund, J. A. ...	Sweden	Shooting	c.
Hohenau, von ...	Germany	Horse Riding comp.	Prize jumping, ind. and team.
Hohenlohe, E., Prince	Austria	Fencing	Ind. sabre.
Hohenthal, V. G. von	Russia	Modern Pentathlon	
Hol, P.	Norway	Gymnastics	Team competition I.
Holden, H. W.	U. S. A.	Athletics	800 m. flat.
Hollstein, E. ...	Germany	Football	
Holm, E.,	Finland	Shooting	d. e.
Holm, M.,	»	Wrestling	Middle weight A.
Holmberg, C. A.	Denmark	Athletics	Cross-country race.
Holmberg, T. O.	Sweden	Gymnastics	Team competition I.
Holmér, G.	»	Athletics	Pentathlon, Decathlon.
Holmer, S. E. ...	»	Swimming	High (plain) diving.
Holmström, A., ...	»	Lawn Tennis (covered & out-of- door courts)	Ladies' Singles; Mixed doubles
Holmström, G. V.	Finland	Football	
Holopainen, J., ...	»	»	
Holst, J. H. von	Sweden	Shooting	g. h. i. l. m.
Holt, M. D. V.	Great Britain	Fencing	Team épée, ind. épée.
Holter, R. D. ...	Norway	Rowing	Fours, inriggers.
Honzatko, B. ...	Bohemia	Athletics	Marathon race; Decath- lon.
Horine, G. L., ...	U. S. A.	»	High jump.
Horn, J. B.,	Luxemburg	Gymnastics	Team competition II, » » III.
Horn af Äminne, H.	Sweden	Horse Riding comp.	Military.
Horsfall, E. D., ...	Great Britain	Rowing	Eights, outriggers.
Horvay, A.	Hungary	Athletics	High jump.
Houtkooper, M.	Holland	Football	
Hovdenak, O., ...	Norway	Athletics	Cross-country race.
Howard, J. A., ...	Canada	»	100 m. flat, 200 m. flat, relay race 400 m.
Huber, R. W., ...	Finland	Shooting	n. o.
Hulford, F. H.	Great Britain	Athletics	800 m. flat, 1,500 m. flat.
Hullden V.	Finland	Yacht Racing	12-m. class,
Humby, H. R., ...	Great Britain	Shooting	n. o.

Name	Nation	Branch of Athletics	Competition
Humphreys, Fr.	Great Britain	Athletics	Tug-of-War.
Humphreys, T....	»	Wrestling	Heavy weight.
Hunter, W. L....	»	Athletics	10,000 m. flat, cross country race.
Husby, O.	Norway	Shooting	Broad jump.
Hussak, L.	Austria	Football	a. e.
Huszagh, K. ...	U. S. A.	Swimming	100 m. free style, 800 m. team race.
Hutcheson, R. B.	Canada	Shooting	o.
Hutson, E. W....	Great Britain	Athletics	5,000 m. flat, 3,000 m. team race.
Huttunen, H. ...	Finland	Shooting	d. e. k.
Hyks, B.	Bohemia	Lawn Tennis	Gentlemen's Singles.
		(out-of-door courts)	» Doubles.
Hylander, A. ...	Sweden	Gymnastics	Team competition I.
Hynes, M. St....	Great Britain	Athletics	Tug-of-War.
Hyvärinen, E....	Finland	Gymnastics	Team competition III.
Hyvärinen, M....	»	»	» » III.
Härleman, C....	Sweden	Athletics	Pole jump.
Höie, T.	Norway	Rowing	Eights, outriggers.
Hök, Å.	Sweden	Horse Riding comp.	Prize jumping.
Höyer, Cl.	Norway	Rowing	Fours, inriggers.
Ilmoniemi, T....	Finland	Swimming	High (plain) diving.
		Gymnastics	Team competition III.
Ingebrigtsen, O.	Norway	»	» » I.
		Athletics	Broad jump, throwing the javelin, b. h.
Ingerslev, V. ...	Denmark	Lawn Tennis	Gentlemen's Singles,
		(out-of-door courts)	» Doubles.
Indriksson, A....	Russia	Athletics	1,500 m. flat.
Innocent, G. ...	Great Britain	Swimming	200 m. breast stroke,
			400 » » »
Irons, F. C. ...	U. S. A.	Athletics	Broad jump.
Isberg, P.	Sweden	Yacht Racing	10- m. class.
Jaakonaho, J. ...	Finland	Cycling	Cycling road race round Lake Mälär.
Jack, F.	Germany	Fencing	Foils, team épée, ind. épée, team sabre.
Jackson, A. N. S.	Great Britain	Athletics	1,500 m. flat.
Jackson, J. E....	U. S. A.	Shooting	a. b. c.
Jacobs, D. H....	Great Britain	Athletics	100 m. flat, 200 m. flat relay race 400
Jacobsen, O. ...	Norway	Gymnastics	Team competition I:
Jacobson, Skotte	Sweden	Athletics	100 m. flat, 200 m. flat hop, step and jump, Decathlon.
Jacobsson, Sigge	»	»	Marathon race.
Jahn, W.....	Germany	»	800 m. flat.
Jakovleff, A. de	Russia	Fencing	Foils.
Jand, E.	Austria	Rowing	Fours, outriggers.
Janda, F.....	Bohemia	Athletics	Throwing the discus, b.h., Putting the weight, b.h.
Jankovich, I. ...	Hungary	»	100 m. flat, 200 m. flat relay race 400 m.

Name	Nation	Branch of Athletics	Competition
Janse, A. J.	Sweden	Gymnastics	Team competition I.
Jansson, K. E. ...	Finland	»	Ind. competition.
Jansson, K. J. E.	Sweden	Swimming	High (plain) diving, plain and variety diving, spring-board diving.
Janzon, C.	»	Athletics	Throwing the hammer.
Jaubert, Ch.	France	Shooting	l. m. n. o. r.
Javurek, J.	Bohemia	Fencing	Foils, team épée, ind. épée, team sabre.
Jebe, Ch.	Norway	Yacht Racing	8-m. class.
Jeffreys, C. A. ...	South Africa	Shooting	a. b. c. e.
Jeney, S.	Hungary	Rowing	Eights, outriggers.
Jensen, C. C. ...	Denmark	Gymnastics	Team competition III, ind. comp.
Jensen, C. J. ...	»	Athletics	Cross country race.
Jensen, E.	Norway	Gymnastics	Team competition I.
Jensen, J.	»	Horse Riding comp.	Prize jumping, ind.
Jensen, J. K. ...	Denmark	Gymnastics	Team competition I.
Jensen, O. A. ...	Norway	Shooting	a. b.
Jensen, O.	Denmark	Cycling	Cycling road race round Lake Mälär.
Jensen, S.	Norway	Football	
Jensen, S. A. ...	Denmark	Gymnastics	Team competition I.
Jensen, S. M. ...	»	Wrestling	Heavy weight.
Jensen, T.	Norway	Gymnastics	Team competition I.
Jensen, W.	Denmark	»	» » I.
Jernström, V. ...	Sweden	Shooting	a. b. c. e.
Jesinghaus, W. ...	Germany	Gymnastics	Team competition II. » » III.
Jilewitch, W. ...	Russia	Yacht Racing	8-m. class.
Jiranek, L.	Bohemia	Athletics	100 m. flat.
Jirsak, J.	»	»	Pole jump.
Jong, A. E. W. de	Holland	Fencing	Foils, team épée, ind. épée, team sabre.
Jongh, H. de ...	»	»	Ind. épée, team sabre, ind. sabre.
Johansen, D. V.	Norway	Athletics	Throwing the javelin, b.h. and r. & l. h.
Johansen, H. ...	»	Football	
Johansen, Hj. P.	Denmark	Gymnastics	Team competition III.
Johanson, A. ...	Sweden	Rowing	Fours, inriggers.
Johansson, A. ...	»	Swimming	High (plain) diving.
Johansson, C. H.	»	Shooting	a. b. d. e.
Johansson, Cl. E.	»	Wrestling	Middle weight A.
Johansson, E. ...	»	Football	
Johansson, E. A.	»	Shooting	g.
Johansson, Fr. R.	»	Wrestling	Middle weight A.
Johansson, F. W.	Finland	Athletics	5,000 m. flat; team race 3,000 m.; cross-country race.
Johansson, Greta	Sweden	Swimming	100 m. free style, ladies; high(plain)diving, ladies; 400 m. team race, ladies.
Johansson, G. M.	»	»	High(plain)diving, ladies.
Johansson, H. A.	»	Wrestling	Feather weight.
Johansson, Hj. ...	»	Swimming	High (plain) diving, plain and variety diving, water polo.

Name	Nation	Branch of Athletics	Competition
Johnsen, B.	Norway	Gymnastics	Team competition III.
Johnsen, J. H. ...	»	Swimming	100 m. free style; 100 » back stroke; 400 » free style; 1,500 » » »
Johnson, F.	Sweden	Yacht Racing	12-m. class.
Johnson, L.	France	Shooting	a. d. e. f. i. k.
Johnson, T.	Sweden	Rowing	Fours, inriggers.
Johnstone, A. E.	South Africa	Shooting	b. c. e.
Johnstone, J. O.	U. S. A.	Athletics	High jump.
Jokinen, A.	Finland	Wrestling	Middle weight A.
Jones, J. P.	U. S. A.	Athletics	800 m. flat; 1,500 m. flat; team race 3,000 m.; cross-country race.
Jones, P. H. ...	Great Britain	Shooting	k.
Jones, S. L.	»	Cycling	Cycling road race round Lake Mälär.
Jonsson, E.	Sweden	Shooting	c.
Jonsson, G.	»	Athletics	Throwing the hammer.
Jonsson, G. A. ...	»	Shooting	c. d. e.
Jonsson, J.	»	Yacht Racing	6-m. class.
Jonsson, K.	»	Athletics	Tug-of- War.
Jonsson, M.	»	Wrestling	Light weight.
Jonsson, R.	»	Shooting	b. e. i.
Jonsson, Sonja...	»	Swimming	100 m. free style, ladies; 400 m. team race, ladies.
Jordan, K.	Germany	Gymnastics	Team competition II; » » III.
Jordell, J. O. ...	Norway	Shooting	c. g.
Judkins, A.	Great Britain	Swimming	Water Polo.
Julin, H.	Sweden	»	100 m. free style; 200 m. breast stroke; water polo.
Jurgens, E.	Holland	Shooting	o.
Just, J.	Bohemia	Lawn Tennis (out-of-door courts)	Gentlemen's Singles; » Doubles.
Juslén, P.	Finland	Yacht Racing	12-m. class.
Jnstén, B.	»	»	8- » »
Jäger, A.	Germany	Football	
Järvi, T. M.	Finland	Swimming	100 m. free style, ladies.
Järvinen, W. ...	»	Athletics	Throwing the discus, b.h., r. & l. h.
Jöhncke, A.	Sweden	Fencing	Foils, team sabre.
Jölver, K. A. W.	Denmark	Modern Pentathlon	
Jørgensen, E. ...	»	Football	
Jørgensen, H. ...	»	Rowing	Fours, outriggers.
Jørgensen, P. P.	»	Gymnastics	Team competition III.
Jørgensen, S. ...	Norway	»	» » III.
Kache, A. de ...	Russia	Shooting	k. l. m.
Kahanamoku, D.	U. S. A.	Swimming	100 m. free style; 800 m. team race.
Kainuvaara, K. ...	Finland	»	Plain and variety diving.
Kaiser, F. H. ...	U. S. A.	Athletics	Walking race.
Kalinine, C. de	Russia	Shooting	b. c. d. e.
Kallberg, A. ...	Finland	Athletics	Marathon race.
Kaltenbrunner, J.	Austria	Football	

Name	Nation	Branch of Athletics	Competition
Kanakuri, S. ...	Japan	Athletics	Marathon race.
Kander, G. S. V.	Sweden	Yacht Racing	12-m. class.
Kangas, A.	Finland	Wrestling	Feather weight.
Kanivé, N.	Luxemburg	Gymnastics	Team competition II; » » III; ind. comp.
Kankkonen, J. ...	Finland	Cycling	Cycling road race round Lake Mälär.
Kankovszky, A. von	Hungary	Swimming	Water Polo.
Kaplur, O.	Russia	Wrestling	Light weight.
Kapmal, A.	»	Athletics	Marathon race.
Kari, Regina ...	Finland	Swimming	100 m. free style, ladies.
Karoly, J.	Hungary	Football	
Karpati, O.	»	Athletics	Marathon race.
Karlsson, D. ...	Sweden	Wrestling	Heavy weight.
Karlsson, K. ...	»	»	Feather weight.
Karlsson, M. ...	»	Athletics	5,000 m. flat, 10,000 m. flat.
Karlsson, W. ...	»	Cycling	Cycling road race round Lake Mälär.
Keely, E. J. ...	South Africa	Shooting	a. c. d. e.
Keeper, J.	Canada	Athletics	5,000 m. flat, 10,000 m. flat.
Kehrling, B. von	Hungary	Lawn Tennis (out-of-door courts)	Gentlemen's Singles. » Doubles.
Keinänen, I. ...	Finland	Gymnastics	Team competition III.
Keiser, W.	Russia	Fencing	Foils, team épée, ind. épée.
Kelemen, A. von	Hungary	Lawn Tennis (out-of-door courts)	Gentlemen's Singles. » Doubles.
Kellaway, H. G.	Great Britain	Athletics	Marathon race.
Kellner, Hanny ..	Austria	Swimming	High (plain) diving, ladies.
Kellner, P.	»	»	100 m. free style, ladies; 400 m. team race, ladies.
Kellner, P.	Germany	»	100 m. back stroke.
Kelly, F. W. ...	U. S. A.	Athletics	Hurdle race.
Kemp, F. W.	Great Britain	Shooting	g. i.
Kempe, C.	Sweden	Lawn Tennis (covered courts)	Gentlemen's Singles, » Doubles, Mixed Doubles.
Kempster, A. J.	Great Britain	Shooting	j. k. l.
Keene, A. V. ...	»	Fencing	Ind. sabre.
Kenna, P. A. ...	»	Horse Riding comp.	Military, prize-jumping, ind.
Kent, A. H. E.	Canada	Rowing	Eights, outriggers.
Kenyery, A. ...	Hungary	Swimming	100 m. free style, 400 » » » 800 m. team race.
Kenyon, J. H. ...	Canada	Shooting	o.
Kereszetsy, J. ...	Hungary	Gymnastics	Team competition II.
Kern, E.	Germany	Athletics	100 m. flat; relay race 400 m.
Kertesz, V.	Hungary	Football	
Ketterer, E.	Germany	Athletics	100 m. flat.
Keyper, R. J. G.	Denmark	Horse Riding comp.	Prize riding.
Kildal, K.	Norway	»	Prize jumping, ind.

Name	Nation	Branch of Athletics	Competition
Kilman, G.	Sweden	Horse Riding comp.	Prize jumping, team.
Kingsford, P. E.	Great Britain	Athletics	Broad jump.
Kinnear, W. D.	»	Rowing	Single Sculls.
Kipp, E.	Germany	Football	
Kippasto, A. ...	Russia	Wrestling	Light weight.
Kirby, A. G. ...	Great Britain	Rowing	Eights, outriggers.
Kirk, J. W.	»	Cycling	Cycling road race round Lake Mälär.
Kirk, K.	Denmark	Gymnastics	Team competition I.
Kirkebjerg, F. ...	»	Horse Riding comp.	Military.
Kirkegaard, J. ...	»	Gymnastics	Team competition I.
Kitson, H. A. ...	South Africa	Lawn Tennis (out-of-door courts)	Gentlemen's Singles. » Doubles.
Kiviati, A. R. ...	U. S. A.	Athletics	1,500 m. flat, team race 3,000 m.
Kivenheimo, V. Hj.	Finland	Gymnastics	Team competition III.
Kjems, A. N. ...	Denmark	»	» » I.
Klein, M.	Russia	Wrestling	Middle weight A.
Klein, N. F. H.	Sweden	Shooting	o.
Klem, Th.	Norway	Rowing	Fours, outriggers.
Klerck, C. G. ...	Sweden	Fencing	Ind. sabre, team sabre.
Klika, M.	Bohemia	»	Foils, team épée, ind. épée.
Klintberg, J. ...	Sweden	Athletics	Cross-country race.
Knepper, E. ...	Luxemburg	Gymnastics	Team competition II, » » III.
Kniajevitch, D. de	Russia	Fencing	Foils, team épée, ind. épée.
Knight, A. E. ...	Great Britain	Football	
Knudsen, K. L.	Norway	Gymnastics	Team competition III.
Kobulsky, K. ...	Hungary	Athletics	Throwing the discus, b.h., r. & l. h.
Koch, M.	Germany	Cycling	Cycling road race round Lake Mälär.
Koch	»	Shooting	n. o. q. r.
Kodl, J.	Bohemia	Lawn Tennis (out-of-door courts)	Gentlemen's Singles.
Koepke, A.	Russia	Cycling	Cycling road race round Lake Mälär.
Koepke, C.	»	»	Cycling road race round Lake Mälär.
Kofler, A.	Austria	»	Cycling road race round Lake Mälär.
Kohn, R.	»	Football	
Kokotowitsch, P.	»	Wrestling	Middle weight A.
Kolehmainen, H.	Finland	Athletics	5,000 m. flat, 10,000 m. flat, team race 3,000 m., cross-country race.
Kolehmainen, T.	»	»	10,000 m. flat, Marathon race.
Kolehmainen, T.	»	Wrestling	Light weight.
Kolho, L.	»	Shooting	e.
Kolho, V. V. ...	»	»	d. e.
Koller, V. C. ...	Chili	Cycling	Cycling road race round Lake Mälär.
Kolling, J. C. ...	Holland	Fencing	Ind. sabre.

Name	Nation	Branch of Athletics	Competition
Kolomenkine, N. de	Russia	Shooting	j. k. l. m.
Konow, M.	Norway	Yacht Racing	12-m. class.
Kopriva, F.	Bohemia	Wrestling	Middle weight B.
Kopsky, J. G. ...	U. S. A.	Cycling	Cycling road race round Lake Mälär.
Korody, K.	Hungary	Football	
Korponay, J. ...	»	Gymnastics	Team competition II; ind. comp.
Korver, J. M. de	Holland	Football	
Koskelo, K.	Finland	Wrestling	Feather weight.
Kouchnikoff, P.	Russia	Gymnastics	Ind. competition.
Kouskoff, D. de	»	Shooting	a. b. c. d. e. k.
Kousnezoff, N. ...	»	Fencing	Team sabre, ind. sabre.
Kovacs, E.	Austria	Swimming	Water Polo.
Kovács, M.	Hungary	Athletics	Throwing the javelin, b. h. r. & l. h., Throwing the discus, b. h.
Kovacs, N.	»	»	Broad jump.
Kraft, C. A. ...	Denmark	Horse Riding comp.	Military.
Kragh-Christian- sen, E.	Norway	Yacht Racing	6-m. class.
Kramer, R.	Austria	Cycling	Cycling road race round Lake Mälär.
Kramer, W. J. ...	U. S. A.	Athletics	10,000 m. flat, cross-country race.
Krebs, C. I. ...	Denmark	Gymnastics	Team competition III.
Krefting, Kr. ...	Norway	Football	
Kreuzer, O.	Germany	Lawn Tennis (out-of-door courts)	Gentlemen's Singles.
Krigsman, W. ...	Sweden	Athletics	Throwing the javelin, b. h., r. & l. h.
Kriz, Fr.	Bohemia	Fencing	Foils, team épée, ind. Épée, team sabre.
Krogh, O. T. ...	Norway	Rowing	Eights, outriggers.
Krogius, A.	Finland	Yacht Racing	12-m. class.
Krogmann, G.	Germany	Football	
Krojer, G.	Austria	Athletics	Hop, step and jump, throwing the javelin, b. h., Pentathlon, relay race 400 m.
Krombholz, F. ...	»	Rowing	Fours, outriggers.
Kruckenberg, C. W.	Sweden	Horse Riding comp.	Prize riding.
Kruklin, A.	Russia	Athletics	1,500 m. flat, Marathon race.
Krushel, A.	U. S. A.	Cycling	Cycling road race round Lake Mälär.
Kröcher, von ...	Germany	Horse Riding comp.	Prize jumping, ind.
Kröder, G.	Austria	Rowing	Fours, outriggers.
Kubrycht, B.	Bohemia	Cycling	Cycling road race round Lake Mälär.
Kudloff, W.	Germany	Fencing	Foils, ind. épée.
Kugelberg, E.	Sweden	Athletics	Pentathlon, Decathlon.
Kuhn, E. A.	Russia	Yacht Racing	8-m. class.
Kukkola, E.	Finland	Athletics	Broad jump, throwing the javelin, b. h.; Pentathlon.

Name	Nation	Branch of Athletics	Competition
Kulikoff, S.	Russia	Gymnastics	Ind. competition.
Kullberg, A. B. G.	Sweden	»	Team competition I.
Kullerstrand, K.	»	Athletics	High jump.
Kumfeldt, K. T.	»	Swimming	Water Polo.
Kummer, N. ...	Luxemburg	Gymnastics	Team competition II, » » III.
Kumpu, O. W....	Finland	Wrestling	Middle weight, B.
Kundert, Fr. ...	Bohemia	Cycling	Cycling road race round Lake Mälär.
Kunisch, G. ...	Germany	Swimming	100 m. free style, 800 m. team race.
Kurpiel, L.	Austria	Football	
Kurz, A.	Germany	Wrestling	Middle weight A.
Kusik, M.	Russia	Rowing	Single Sculls.
Kusmitscheff, V.	»	Yacht Racing	8-m. class.
Kwieton, F.	Austria	Athletics	Marathon race.
Kynin, N.	Russia	Football	
Kyrönen, W. ...	Finland	Athletics	Cross-country race.
Köring, Dora ...	Germany	Lawn Tennis (out-of-door courts)	Ladies' Singles, Mixed Doubles.
Körner, R.	»	Gymnastics	Team competition II, » » III.
Labat, R. J.	France	Athletics	High jump.
Labik, V.	Bohemia	»	100 m. flat, 200 m. flat, 400 m. flat.
Lagarde, C.	France	»	Throwing the discus, b.h., Putting the weight, b.h.
Lager, G.	Sweden	Rowing	Fours, outriggers.
Lager, J.	»	»	» »
Lagerlöf, L.	»	Shooting	b.
Laine, A.	Finland	Athletics	High jump.
Laitinen, O. A.	»	Wrestling	Light weight.
Lalu, M.	France	Gymnastics	Ind. competition.
Lamby, N. S. ...	Sweden	Yacht Racing	12-m. class.
Landberg, S.A.R.	»	Gymnastics	Team competition I.
Landrock, H. ...	Germany	Rowing	Eights, outriggers.
Landsberg, K. J.	Sweden	Cycling	Cycling road race round Lake Mälär.
Lane, A. P.	U. S. A.	Shooting	j. k. l. m.
Langford, Mary	Great Britain	Swimming	100 m. free style, ladies, 400 » team race, ladies.
Langaard, C. ...	Norway	Lawn Tennis (out-of-door courts)	Gentlemen's Singles, » Doubles, Mixed Doubles.
Lange, F.	Germany	Wrestling	Middle weight B.
Langkjær, S. ...	Denmark	Athletics	High jump, Pentathlon, Decathlon.
Langsam, M. ...	Luxemburg	Gymnastics	Team competition II, » » III.
Lanners, E.	»	»	» » II, » » III, ind. comp.
Lardin, M.	France	Shooting	a. c. f.
Larimer, M. W.	U. S. A.	Fencing	Foils, ind. épée, team. épée.
Larsen, A.	Norway	Yacht Racing	12-m. class.

Name	Nation	Branch of Athletics	Competition
Larsen, C. O. L.	Denmark	Gymnastics	Team competition I.
Larsen, E.	Norway	Athletics	Hop, step and jump.
Larsen, E.	Denmark	Lawn Tennis (covered courts)	Gentlemen's Singles; Mixed Doubles.
Larsen, H.	Norway	Rowing	Fours, outriggers.
Larsen, L. T. K.	Denmark	Shooting	d. e. k.
Larsen, N. H. D.	»	»	a. c. d. e. k.
Larsen, O.	Norway	Athletics	800 m. flat ; 1,500 m. flat.
Larsen, P.	»	Yacht Racing	12-m. class.
Larsson, A.	Sweden	Athletics	Throwing the javelin, b. h.
Larsson, A. V. ...	»	Swimming	High (plain) diving, ladies.
Larsson, B.	»	Athletics	10,000 m. flat; cross-country race.
Larsson, B.	»	Shooting	a. d. e.
Larsson, D.	»	Athletics	Tug-of-War.
Larsson, E. V. ...	»	»	»
Larsson, H.	»	Wrestling	Feather weight.
Larsson, K.	»	Shooting	q.
Lasanen, O. A.	Finland	Wrestling	Feather weight.
Las-Torres, B.von	Hungary	Swimming	400 m. free style; 1,500 m. free style; 800 m. team race.
Laufray, L.	France	»	Water Polo.
Laurson, J. P. M.	Denmark	Gymnastics	Team competition I.
de Laval, C. P. G.	Sweden	Modern Pentathlon	
de Laval, E. P. H.	»	Shooting	m.
de Laval, G. P. F.	»	Modern Pentathlon	
Lawrence	Great Britain	Shooting	j. k. m.
Laybourn, W. C.	Denmark	Horse Riding comp.	Military.
Lazaro, F.	Portugal	Modern Pentathlon	
Lear J:r, Ben ...	U. S. A.	Athletics	Marathon race.
		Horse Riding comp.	Military; prize jumping, team.
de Lébédéff, T.	Russia	Shooting	a. b. c. d. e.
Lee, G.	Great Britain	Athletics	5,000 m. flat; 10,000 m. flat.
Lefevre, M. L. ...	Denmark	Gymnastics	Team competition I.
Leffler, H.	Sweden	Lawn Tennis (covered & out-of-door courts)	Gentlemen's Singles.
Legat, M.	Italy	Athletics	Broad jump; pole jump.
Lehmann, E. ...	Germany	»	400 m. flat; 800 m. flat.
Lehmuswirta, J.W.	Finland	Wrestling	Feather weight.
Leister, K.	Germany	Rowing	Fours, outriggers.
Leivonen, K. ...	Finland	Wrestling	Feather weight.
Lelong, C. L. ...	France	Athletics	100 m. flat; 200 m. flat; 400 m. flat; relay race 400 m.; relay race 1,600 m.
Lemming, E. ...	Sweden	»	Throwing the javelin, b. h. & r. & l. h.; throwing the discus, r. & l. h.; throwing the hammer.

Name	Nation	Branch of Athletics	Competition
Lemming, O. ...	Sweden	Athletics	Pentathlon.
Lemnitz, F.	Germany	Cycling	Cycling road race round Lake Mälär.
Lenzi, A.	Italy	Athletics	Throwing the discus, b. h.; Putting the weight, b. h.
Leone, P.	»	Football	
Leparsky, F. ...	Russia	Fencing	Foils.
Lepère, A.	France	Cycling	Cycling road race round Lake Mälär.
de Lesche, P. ...	Russia	Shooting	b. c. d. e.
Lesieur, E.	France	Wrestling	Light weight.
de Lesser, E. C.	»	Shooting	n. o.
Lessimore, E. J.	Great Britain	»	f. g. i.
Leushner, W. F.	U. S. A.	»	f. g. h. i. p. q. r.
Levitzky, K. ...	Hungary	Rowing	Single Sculls.
Levidis, N.	Greece	Shooting	a. b. c. f. g. h. i. m. q.
Levin, J. G. Hj.	Sweden	Cycling	Cycling road race round Lake Mälär.
Levin, S.	»	Athletics	100 m. flat.
Levison, E.	Denmark	Fencing	Foils, team épée, ind. épée, team sabre, ind. sabre.
Lewenhaupt, C. G. S.	Sweden	Modern Pentathlon	
Lewenhaupt, Ch.	»	Horse Riding comp.	Prize jumping, ind.
Lewenhaupt, G.	»	»	Prize jumping, ind. & team.
Lewin, J.	»	Football	
Lewis, R.	South Africa	Cycling	Cycling road race round Lake Mälär.
Libbey, W.	U. S. A.	Shooting	p.
Liberg, E.	Norway	»	d. e.
Lichtenfels, J. ...	Germany	Fencing	Foils, ind. épée, team épée, ind. sabre, team sabre.
Lie, A.	Norway	Gymnastics	Team competition III.
Lie, B.	»	Shooting	
Lie, R.	»	Gymnastics	Team competition III.
Liebing, O.	Germany	Rowing	Eights, outriggers.
Liesche, H.	»	Athletics	High jump.
Lieth, P.	Russia	Shooting	o. q.
Lietola, V.	Finland	Football	
Lieven, J.	Russia	Cycling	Cycling road race round Lake Mälär.
Lilley, T. H. ...	U. S. A.	Athletics	Marathon race.
Lilliehöök, G. M.	Sweden	Modern Pentathlon	
Lind, C.	»	Athletics	Throwing the discus, b. h., r. & l. h.; throwing the hammer.
Lind, G. L.	Finland	Wrestling	Middle weight B.
Lind, K. G.	»	»	»
Lindahl, A.	Sweden	Athletics	Cross-country race.
Lindberg, E. F. J.	U. S. A.	»	400 m flat; relay race
Lindberg, K. ...	Sweden	»	1,600 m. 100 m. flat; 200 m. flat; relay race 400 m.

Name	Nation	Branch of Athletics	Competition
Lindberg, K. ...	Finland	Wrestling	Middle weight B.
Lindblom, G. ...	Sweden	Athletics	Hop, step and jump.
Lindblom, G. Th.	»	Fencing	Foils, team épée, ind. épée.
Lindblom, K. ...	»	Athletics	200 m. flat.
Linde, N.	»	»	Throwing the discus, r. & l. h. throwing the hammer.
Lindén, E.	»	Yacht Racing	10-m. class.
Lindewald, E. W.	»	Shooting	q. r.
Lindfors, A. V.	Finland	Wrestling	Heavy weight.
Lindgren, V. ...	»	Swimming	200 m. breast stroke, 400 m. breast stroke.
Lindh, E.	»	Yacht Racing	8-m. class.
Lindh, E. A. ...	»	»	10-m. class.
Lindholm,	Russia	»	»
Lindholm, A. ...	Finland	Athletics	5,000 m. flat; team race 3,000 m.; cross-country race.
Lindholm, E. ...	Sweden	»	100 m. flat; 400 m. flat; 800 in. flat; relay race 1,600 m.
Lindhlo, G.W.M.	»	Fencing	Ind. sabre.
Lindholm, I. ...	»	Athletics	Hop, step and jump; Pentathlon.
Lindnér, S. M. A.	»	Football	
Lindpaintner, O.	Germany	Lawn Tennis (out-of-door courts)	Gentlemen's Singles.
Lindqvist, E. J.	Sweden	Yacht Racing	12-m. class.
Lindroos, K.G.L.	Finland	Swimming	200 m. breast stroke; 400 m. breast stroke.
Lindskog, S. A.	Sweden	Shooting	q. r.
Lindstrand, F. G.	»	Wrestling	Heavy weight.
Lindström, K. H.	»	Athletics	Tug-of-War.
Lippincott, D. F.	U. S. A.	»	100 m. flat; 200 m. flat.
Littlejohn, C.W.B.	Great Britain	Rowing	Eights, outriggers.
Littlewort, H. C.	»	Football	
Ljunggren, G. ...	Sweden	Athletics	Broad jump.
Lloyd, E. W. ...	Great Britain	»	Marathon race.
Lloyd, L.	»	Shooting	c.
Lodal, O.	Denmark	Athletics	Marathon race.
Loftes, A. H. ...	U. S. A.	Cycling	Cycling road race round Lake Mälär.
Lofthus, H.	Norway	Wrestling	Light weight.
Logan, B.	Great Britain	Rowing	Fours outriggers.
Lomberg, C. ...	Sweden	Athletics	Broad jump; Pentathlon; Decathlon.
Lommatsch, E. ...	Russia	Yacht Racing	8-m. class.
Londen, A. F. ...	Finland	Shooting	n. p. q.
Longworth, W. ...	Australasia	Swimming	100 m. free style; 1,500 m. free style.
Lord, F.	Great Britain	Athletics	Marathon race.
Lorichs, H. L. ...	Sweden	Football	
Lotsy, D. N. ...	Holland	»	
Lourasoff, V. ...	Russia	Yacht Racing	8-m. class.
Lowe, A. H. ...	Great Britain	Lawn Tennis (covered courts)	Gentlemen's Singles; Gentlemen's Doubles.

Name	Nation	Branch of Athletics	Competition
Lowe, F. G. ...	Great Britain	Lawn Tennis (covered courts)	Gentlemen's Singles; Gentlemen's Doubles.
Loy, F.	Italy	Gymnastics	Team competition II.
Luber, H.	Germany	Swimming	High (plain) diving, plain and variety diving, spring-board diving.
Luck, Ch. J. ...	Great Britain	Gymnastics	Team competition II.
Ludinszky, L. ...	Hungary	Athletics	High jump.
von Luetcken ...	Germany	Horse Riding comp.	Military.
Luetlich, H. J. ...	"	Shooting	o.
Lukeman, F. L.	Canada	Athletics	100 m. flat; hurdle race; broad jump; Penta- thlon; Decathlon; relay race 400 m.; relay race, 1,600 m.
Lukk, K.	Russia	"	Walking race.
Lund, C. E. ...	Sweden	Wrestling	Light weight.
Lund, K. E. ...	Finland	Football	
Lund, K. Fr. ...	"	Gymnastics	Team competition III.
Lund, M.	Norway	Football	
Lund, T.	"	Gymnastics	Team competition III.
Lundberg, H. T.	Sweden	Athletics	Tug-of- War.
Lundberg, I. ...	"	"	Marathon race.
Lundeberg, Å. ...	"	Shooting	n. o. p. q. r.
Lundén, H.	"	Yacht Racing	10-m. class.
Lundgren, K. ...	"	Swimming	100 m. free style, ladies; 400 m. team race, ladies.
Lundqvist, C. A.	"	Cycling	Cycling road race round Lake Mälär.
Lundsten, F. ...	Finland	Wrestling	Middle weight A.
Lundström, K. ...	Sweden	Athletics	5,000 m. flat; cross- country race.
Lundvall, K.H.V.	"	Swimming	100 m. back stroke.
Lunghi, E.	Italy	Athletics	400 m. flat; 800 m. flat.
Lunzer, G.	Hungary	"	Throwing the discus, b. h., r. & l. h.
Lupton, W. T. ...	Great Britain	Wrestling	Light weight.
Luther, C.	Sweden	Athletics	100 m. flat; 200 m. flat; relay race 400 m.
Lyman, G.	"	Shooting	q. r.
Lyons, J. P. ...	Canada	Swimming	High (plain) diving.
Lyshon, W. J. ...	U. S. A.	Wrestling	Feather weight.
Lüthje, C.	Germany	Cycling	Cycling road race round Lake Mälär.
Lützwow, W.	"	Swimming	200 m. breast stroke; 400 m. breast stroke.
Löffler, W.	"	Fencing	Foils.
Löfgren, G. B. ...	Finland	Football	
Löfman, R.	Sweden	Shooting	g. i. k.
Lönn, K. A. ...	"	Cycling	Cycling road race round Lake Mälär.
Lönnberg, E. ...	Finland	Rowing	Fours, outriggers.
Lönnberg, I. ...	Sweden	Athletics	Marathon race.
Lövold, A.	Norway	Wrestling	Middle weight B.
Löwenadler, F.	Sweden	Swimming	200 m. breast stroke.
Löwenstein, L. ...	Russia	Athletics	100 m. flat.

Name	Nation	Branch of Athletics	Competition
Maartmann, E. ...	Norway	Football	
Maartmann, R. ...	»	»	
Mc Aleenan Jr, A.	U. S. A.	Swimming	High (plain) diving; spring-board diving.
Mc Arthur, K. K.	South Africa	Athletics	Marathon race.
Mc Cleary, W. O.	Canada	Rowing	Eights, outriggers.
Mc Clure, W. ...	Great Britain	Shooting	c. k. m.
Mc Clure, W. ...	U. S. A.	Athletics	800 m. flat; 1,500 m. flat.
Mc Connell, F. D.	Canada	»	100 m. flat; 200 m. flat; relay race 400 m.
Mc Curdy, W. M.	U. S. A.	»	1,500 m. flat; 5,000 m. flat.
Mc Dermott, M.	»	Swimming	200 m. breast stroke; 400 m. breast stroke.
Mc Donald, P.	»	Athletics	Putting the weight, b. h., r. & l. h.
Mc Donell, W. N.	»	Shooting	b. g. h. i. p.
Mc Gillivray, P.	»	Swimming	100 m. free style; 800 m. team race.
Mc Grath, M. J.	»	Athletics	Throwing the hammer.
Mc Kune, W. ...	Great Britain	Gymnastics	Team competition II.
Mc Lean, R. G.	»	»	»
Mc Laughlin, J.	U. S. A.	Fencing	Foils, ind. épée, team épée.
Mc Mahon, D. F.	»	Shooting	0.
Mc Villy, C. ...	Australasia	Rowing	Single Sculls.
Mc Whirter, D.	Great Britain	Football	
Macintosh, H. M.	»	Athletics	100 m. flat; 200 m. flat; relay race 400 m.
Mackenzie, G. ...	»	Wrestling	Feather weight.
Macmillan, D. ...	»	Athletics	100 m. flat; 200 m. flat.
Madeira, L. C. ...	U. S. A.	»	1,500 m. flat.
Madsen, A. S. ...	Denmark	Lawn Tennis (out-of-door courts)	Gentlemen's Singles; Gentlemen's Doubles.
Madsen, L. J. ...	»	Shooting	a. d. e. f. k.
Madsen, V. M. ...	»	Gymnastics	Team competition III.
Magnusson, E. ...	Sweden	Athletics	Throwing the discus, b. h., r. & l. h.
Maguire, H. F.	U. S. A.	»	10,000 m. flat.
Malfait, G. D. ...	France	»	200 m. flat; 400 m. flat.
Malisch, P.	Germany	Swimming	200 m. breast stroke; 400 m. breast stroke.
Malm, B. T. ...	Sweden	Football	
Malm, K. O. R.	»	Cycling	Cycling road race round Lake Mälär.
Malm, O. F. ...	»	Football	
Malmqvist, V. A.	Denmark	»	
Malmsten, G. ...	Sweden	Athletics	Broad jump.
Malmström, Hj.	»	Wrestling	Light weight.
Mangiante, G. ...	Italy	Gymnastics	Team competition II.
Mangiante, L. ...	»	»	»
Mann, P. E. ...	Great Britain	Athletics	800 m. flat.
Manno, M.	Hungary	Rowing	Eights, outriggers.
Mannström, K. ...	Sweden	Modern Pentathlon	
Manos, P.	Greece	Fencing	Team épée.
Manuel, R.	Austria	Swimming	Water polo.
de Mar, C. H.	U. S. A.	Athletics	Marathon race.

Name	Nation	Branch of Athletics	Competition
Maranda, A. ...	Canada	Athletics	Broad jump; hop, step and jump.
Marcault, J.	France	Cycling	Cycling road race round Lake Mälär.
Mariani, D.	Italy	Football	
le Marié, H. ...	France	Shooting	o.
Marini, V.	Italy	Gymnastics	Team competition II.
Marion, A.	France	Shooting	b. d. e.
Mark, O.	Sweden	Yacht Racing	6-m. class.
Mark, P. S.	Denmark	Gymnastics	Team competition I.
Markoff, W. A.	Russia	Football	
Markow, W. A.	»	Yacht Racing	8-m. class.
Markus, E. ...	Hungary	Wrestling	Light weight.
Marsh, W. W. ...	Great Britain	Fencing	Ind. sabre; team sabre.
Martin, A. R. ...	»	»	»
Martin, E.	France	Wrestling	Middle weight B.
Martin, W. C. ...	U. S. A.	Cycling	cycling road race round Lake Mälär.
Martin, W. W. ...	Great Britain	Football	
Martineau, S. ...	»	Fencing	Foils, ind. épée, team épée.
Martinsen, P. ...	Norway	Gymnastics	Team competition III.
Marton, K.	Hungary	Wrestling	Light weight.
Martuscheff, L.	Russia	Fencing	Ind. épée; team épée.
Marty, L. C. ...	France	Gymnastics	Ind. competition.
Maseng, R.	Norway	Shooting	b. g.
de Mas Latric, J.	France	Modern Pentathlon	
Massa, M.	Italy	Swimming	100 m. free style; 400 m. free style; 1,500 m. free style.
Mathiæ, H.	Germany	Rowing	Eights, outriggers.
Mathiesen, P. A.	Norway	Gymnastics	Team competition III.
Mathiesen, S. W.	»	Fencing	Ind. épée; team épée.
Matiason, E. ...	Sweden	Wrestling	Light weight.
Mattson, P.	»	Rowing	Eights, outriggers.
Mattsson, R. ...	»	Athletics	High jump.
Maunder, A. ...	Great Britain	Shooting	n. o.
Mavrogordato, T. M.	»	Lawn Tennis (covered courts)	Gentlemen's Singles; Gentlemen's Doubles; Mixed Doubles.
Mavrommatis, F.	Greece	Shooting	a. b. c. f. g. h. i. j. k. l. m.
Mayer, R.	Austria	Rowing	Fours, outriggers.
Mayer, V.	»	Swimming	Water Polo.
Mazur, G.	Hungary	Cycling	Cycling road race round Lake Mälär.
Mazzarocchi, S.	Italy	Gymnastics	Team competition II.
Mecredy, R. J. R.	Great Britain	Cycling	Cycling road race round Lake Mälär.
Meert, M. H. ...	France	Athletics	High jump.
Meesit, A.	Russia	Wrestling	Feather weight.
Megherian, M. ...	Turkey	Athletics	Throwing the discus, b. h.; Putting the weight, b. h., r. & l. h.; Pentathlon; Decathlon.
Meienreis, W. ...	Germany	Fencing	Ind. épée; team épée; team sabre.

Name	Nation	Branch of Athletics	Competition
Meignant, A. ...	France	Rowing	Fours, inriggers.
Meissner, F. ...	U. S. A.	Cycling	Cycling road race round Lake Mälär.
Meister, G.	France	Swimming	100 m. free style; water polo.
Melin, D. E. ...	Sweden	Athletics	Broad jump.
Mellin, V. ...	»	Wrestling	Middle weight A.
de Melnitsky, N.	Russia	Shooting	j. k. l. m. q.
Menaul, J. A. ...	U. S. A.	Athletics	Pentathlon.
Meny, M.	France	Lawn Tennis (out-of-door courts)	Gentlemen's Singles; Gentlemen's Doubles.
Mercer, E. L. ...	U. S. A.	Athletics	Broad jump; Pentathlon.
Meredith, J. E.	»	»	400 m. flat; 800 m. flat; relay race 1,600 m.
Meredith, L. ...	Great Britain	Cycling	Cycling road race round Lake Mälär.
Merkle, J.	Germany	Wrestling	Middle weight A.
Mérimon, D. ...	France	Shooting	b. c.
Merlin, E. A. ...	Great Britain	Cycling	Cycling road race round Lake Mälär.
Merz, R.	Austria	Football	
Messenger, A. W.	Great Britain	Gymnastics	Team competition II.
Mestecky, Z. ...	Bohemia	Athletics	800 m. flat.
Meszaros, E. ...	Hungary	Fencing	Ind. sabre; team sabre.
Meszaros, J.	»	Rowing	Single Sculls.
Metaxas, A.	Greece	Shooting	m. o.
Meulengracht- Madsen, H. ...	Denmark	Yacht Racing	6-m. class.
Meyboom, H. ...	Belgium	Swimming	100 m. free style; water polo.
Meyer	France	Horse Riding comp.	Military; prize jumping, ind. & team.
Meyer, A. T. ...	U. S. A.	Athletics	100 m. flat; 200 m. flat.
Meyer, G. H. ...	Germany	Shooting	l. m.
Mezei, F.	Hungary	Athletics	200 m. flat; 400 m. flat; relay race 1,600 m.
Michel, A.	Austria	Shooting	p. q.
Michiels, A. ...	France	Cycling	Cycling road race round Lake Mälär.
Mickler, G.	Germany	Athletics	1,500 m. flat; team race 3,000 m.
Middelboe, N. ...	Denmark	Football	
Middleton, S. A.	Australasia	Rowing	Eights, outriggers.
Milano, G.	Italy	Football	
Milch, Klara ...	Australasia	Swimming	100 m. free style, ladies, 400 m. team race, ladies.
Miller, J.	Great Britain	Cycling	Cycling road race round Lake Mälär.
Mills, E. A.	»	Athletics	Tug-of-War.
Milne, W.	»	Shooting	g. h. i.
Miloschevitsch, D.	Servia	Athletics	100 m. flat.
Mirambeau, A. ...	France	Rowing	Fours, outriggers.
Mishima, Y.	Japan	Athletics	100 m. flat; 200 m. flat; 400 m. flat.
Miskey, A.	Hungary	Wrestling	Middle weight A.

Name	Nation	Branch of Athletics	Competition
Modig, B.	Sweden	Athletics	5,000 m. flat.
von Moers,	Germany	Horse Riding comp.	Military, Prize-riding.
Molijn, W. H. ...	Holland	Fencing	Ind. épée.
Molokanof, B. ...	Russia	Athletics	Throwing the discus, r. & l. h.
Monsen, O.	Norway	»	High jump.
Montan, S. M. ...	Sweden	Swimming	High (plain) diving.
Montgomerie, R. C. L.	Great Britain	Fencing	Foils, ind. épée, team épée.
Montgomery, J. C.	U. S. A.	Horse Riding comp.	Military, Prize riding, Prize jumping, team.
de Montigny, F.	Belgium	Fencing	Foils, ind. épée, team épée.
Moore, B.	Great Britain	Swimming	100 m. free style, ladies.
Moore, J. M. ...	U. S. A.	Fencing	Ind. épée, team épée.
Moore, W. C. ...	Great Britain	Athletics	1,500 m. flat, team race
Morberger, R. ...	Austria	Swimming	3,000 m. Water Polo.
Mordovine, A. ...	Russia	Fencing	Foils, team épée, ind. sabre, team sabre.
Morelli, V.	Italy	Football	
Morén, H. H. S.	Sweden	Cycling	Cycling road race round Lake Mälär.
Mourlon, R. ...	France	Athletics	100 m. flat, 200 m. relay race.
Morville, C. V.	Denmark	Football	
Moss, C.	Great Britain	Cycling	Cycling road race round Lake Mälär.
Mostras, S. D. ...	Greece	Shooting	a. c.
Motte, A.	France	Athletics	Broad jump.
Mucks, A. M. ...	U. S. A.	»	Throwing the discus, b.h., r. & l. h.
Mudin, I.	Hungary	»	Putting the weight, b. h.
Mugridge, A. R.	Great Britain	»	Tug-of-War.
Muller, E. J. ...	U. S. A.	»	Throwing the discus, b.h., r. & l. h.
Munro, A.	Great Britain	»	Tug-of-war.
von Mura, A. T.	Hungary	Shooting	g. i. k. m.
Murphy, F. D. ...	U. S. A.	Athletics	Pole jump.
Murphy, W. E. G.	Canada	Rowing	Eights, outriggers.
Murray, R. C. ...	Great Britain	Shooting	f. g. i.
Murray, W.	Australasia	Athletics	Walking race.
Mustonen, R. ...	Finland	Wrestling	Feather weight.
Müller, Alois ...	Austria	Football	
Müller, F. A. ...	Chili	Athletics	800 m. flat.
Müller, I.	Hungary	Cycling	Cycling road race round Lake Mälär.
von Müller, O. ...	Germany	Lawn Tennis (out-of-door courts)	Gentlemen's Singles. Doubles.
Münich, C.	Austria	Fencing	Ind. sabre.
Myrberg, H. ...	Sweden	Football	
Myyrä, J.	Finland	Athletics	Throwing the javelin, b.h.
Mähl, H.	Sweden	»	High jump.
Månsson, G. ...	»	Yacht Racing	8-m. class.
Männel, O.	Germany	Cycling	Cycling road race round Lake Mälär.

Name	Nation	Branch of Athletics	Competition
Möbius, E. A. ...	Denmark	Gymnastics	Ind. competition.
Möller, C. M. A.	»	Rowing	Fours, inriggers.
Möller, E.	Sweden	Athletics	High jump, broad jump.
Möller, F.	»	Lawn Tennis (covered and out- of-door-courts)	Gentlemen's Singles. » Doubles.
Möller, G.	»	Athletics	100 m. flat, 200 m. flat, 400 m. flat.
Möller, H.	»	»	Throwing the discus, b.h.
Möller, I.	»	»	100 m. flat, 200 m. flat, relay race 400 m.
Nadi, N.	Italy	Fencing	Foils, ind. sabre, team sabre.
Nagel, O. W. D.	Denmark	Wrestling	Middle weight B.
Nardus, L.	Holland	Fencing	Ind. épée, team épée.
Nauman, F. J. T.	Sweden	Swimming	Water Polo.
Naumann, A. ...	Germany	Fencing	Ind. épée.
Nazarof, D.	Russia	Athletics	800 m. flat, 1,500 m. flat, team race 3,000 m.
Neklepaieff, N. ...	»	»	Throwing the javelin, b.h.
Nelson, F. F. ...	U. S. A.	»	Pole jump.
Nepokoupoi, B.	Russia	Modern Pentathlon	
Nerich, N. T.	U. S. A.	Swimming	100 m. free style.
Neser, J.	Germany	Wrestling	Heavy weight.
Neubauer, L. ...	Austria	Football	
Nicholson, J. P.	U. S. A.	Athletics	Hurdle race.
Nicol, G.	Great Britain	»	400 m. flat, relay race 1,600 m.
Nicolsky, M. ...	Russia	»	5,000 m. flat, 10,000 m. flat.
Nielsen, A. P. ...	Denmark	Shooting	e. k.
Nielsen, F.	»	»	e. f. g. k.
Nielsen, L. F. C.	»	Gymnastics	Team competition III.
Nielsen, N. C. O.	»	Football	
Nielsen, N. P. ...	»	»	
Nielsen, S. E. ...	»	»	
Nielsen, S. P. ...	»	Shooting	k.
Nielsen, V. C. ...	»	Cycling	Cycling road race round Lake Mälär.
Nielsen, V.	»	»	Cycling road race round Lake Mälär.
Nieminen, W. ...	Finland	Gymnastics	Ind. competition.
Nikitin, G. M. ...	Russia	Football	
Niklander, E. ...	Finland	Athletics	Throwing the discus, b.h., r. & l. h., putting the weight, b. h., r. & l. h.
Nilsson, C.	Sweden	»	Marathon race.
Nilsson, Dagmar	»	Swimming	High (plain) diving, ladies.
Nilsson, E.	»	Athletics	Throwing the discus, b.h., r. & l. h., putting the weight, b. h., r. & l. h., Pentathlon, Decathlon.
Nilsson, E. H. W.	»	Wrestling	Middle weight B.
Nilsson, G.	»	Athletics	Throwing the discus, b.h., r. & l. h.
Nilsson, I. T. ...	»	Wrestling	Light weight.
Nilsson, K. O. V.	»	Football	

Name	Nation	Branch of Athletics	Competition
Nilsson, M.	Sweden	Athletics	Pole jump.
Nilsson, O.	»	»	Throwing the javelin, b. h., r. & l. h.; throwing the discus b. h.
Nilsson, P. E. A.	»	Gymnastics	Team competition I.
Niska, A. J.	Finland	Football	
di Nola, U.	Italy	Fencing	Foils, team sabre.
Noll, O.	Austria	Football	
Norby, H. C. ...	Norway	Fencing	Team épée.
Nordén, G.	Sweden	Modern Pentathlon	
Nordenström, S.		Athletics	Hop, step and jump.
A. M.	»	Fencing	Ind. sabre, team sabre.
Nordenswan, A.	»	Shooting	f. g. i.
Nordlander, A. ..	»	Horse Riding comp.	Military.
Nordström, H. ..	»	Athletics	5,000 m. flat, cross country race.
Nordström, R. H.	Denmark	Gymnastics	Team competition III.
Nordvik, H.	Norway	Shooting	a. b.
Norelius, B. R.	Sweden	Gymnastics	Team competition I.
Norling, A.	»	»	» » I.
Norling, L. D. ...	»	»	» » I.
Norman, A. C. C.	South Africa	Athletics	Marathon race, walking race.
Normann, Aagot	Norway	Swimming	100 m. free style, ladies.
Notaris, S.	Greece	Fencing	Foils, ind. épée, team épée.
Nuytens, L.	Belgium	Rowing	Fours, outriggers.
Nyberg, H.	Sweden	Yacht Racing	10-m. class.
Nyberg, H.	»	Shooting	
Nyholm, J. W. ...	Finland	Rowing	Fours, outriggers.
Nylén, C. O. ...	Sweden	Lawn Tennis (covered & out-of- door courts)	Gentlemen's Doubles, Mixed Doubles.
Nylund, E.	Finland	Rowing	Fours, outriggers.
Nylund, S. T. ...	Sweden	Swimming	Spring-board diving.
Nyman, A. M. ...	Finland	»	High (plain) diving.
Nyman, G. R. ...	»	Shooting	d. e.
Nyström, J. F. ...	Sweden	»	g. k
Nyström, T. E.	»	»	b. c.
Nys, L. P.	Belgium	Swimming	Water Polo.
Nyssonen, A. H.	Finland	Football	
Oberholzer, H. A.	Great Britain	Gymnastics	Team competition II.
Oberle, E.	Germany	Football	
Ochs, J.	Belgium	Fencing	Foils, ind. épée, team épée.
Odelberg, E. A.	Sweden	Shooting	g. i.
Oehler, P.	Germany	Wrestling	Middle weight B.
von Oesterley	»	Horse Riding comp.	Prize riding.
Ohlsson, B.	Sweden	Athletics	Throwing the javelin, b.h.
Ohlsson, E.	»	Shooting	b. c.
Ohlsson, Hj. ...	»	Athletics	Hop, step and jump.
Ohlsson, P.	»	»	Broad jump, hop, step and jump.
Ohlsson, R.	»	»	Throwing the hammer.
Ohlsson, T.	»	»	5,000 m. flat, team race 3,000 m.

Name	Nation	Branch of Athletics	Competition
Ohrling, A.	Sweden	Athletics	Throwing the javelin, b. h., r. & l. h.
Ohsol-Berné A.	Russia	»	Putting the weight, b. h.
Oler, Jr, W. M.	U. S. A.	»	High jump.
Olin, J. F.	Finland	Wrestling	Heavy weight.
Olsen, C. T. ...	Norway	Cycling	Cycling road race round Lake Mälär.
Olsen, E.	Denmark	Gymnastics	Team competition I.
Olsen, F.	Norway	»	» » I.
Olsen, G.	»	Athletics	High jump.
Olsen, H.	Denmark	Fencing	Foils, ind. épée, team épée, team sabre.
Olsen, H. C. ...	»	Cycling	Cycling road race round Lake Mälär.
Olsen, H. G. ...	»	»	Cycling road race round Lake Mälär.
Olsen, O.	Norway	Athletics	Marathon race.
Olsen, O.	Denmark	Shooting	d. e.
Olsen, O.	»	Gymnastics	Team competition III.
Olsen, O. A. ...	»	Football	
Olsen, S. L. ...	»	Gymnastics	Team competition III.
Olsen, T.	Norway	Wrestling	Light weight.
Olsson, S.	Sweden	»	Middle weight A.
Olstad F.	Norway	Rowing	Fours, inriggers.
Olstad, O.	»	Gymnastics	Team competition I.
Ommundsen, H.	Great Britain	Shooting	a. b.
Onody, J.	Hungary	Swimming	Water Polo.
Opdahl, J.	Norway	Gymnastics	Team competition III.
Opdahl, N.	»	»	» » III.
Orlando, A.	Italy	Athletics	5,000 m.flat, 10,000 m.flat.
Orosz, D.	Hungary	Wrestling	Light weight.
Osburn, C. T. ...	U. S. A.	Shooting	a. b. c. e. f. g. i.
Osiier, I.	Denmark	Fencing	Foils, ind. épée, team épée, team sabre.
Otto, Louise ...	Germany	Swimming	100 m. free style, ladies. 400 m. team race, ladies.
Ouwersky, A. ...	Russia	Football	
Owen, E.	Great Britain	Athletics	1,500 m. flat, team race 3,000 m.
Paaske, C.	Norway	Modern Pentathlon	
Pagani, A.	Italy	Athletics	Hurdle race, high jump, broad jump, Pentath- lon, Decathlon.
Pahner, H.	Germany	Gymnastics	Team competition II, III.
Pajzs, P.	Hungary	Fencing	Foils, ind. sabre.
Palén, P.	Sweden	Shooting	k. l. m.
Palgen, M.	Luxemburg	Gymnastics	Team competition II, III.
Palma, L. E. ...	Chili	Athletics	800 m. flat.
Palmer, C.	Great Britain	Shooting	n. o.
Palmer, W. J. ...	»	Athletics	Walking race.
de Panteleymo- noff, G.	Russia	Shooting	k. l. m.
Paoli, R. L.	France	Wrestling	Heavy weight.
Papazian, V. ...	Turkey	Athletics	Putting the weight, b. h. 800 m. flat, 1,500 m. flat.

Name	Nation	Branch of Athletics	Competition
Sir W. L. Parker, Bt.	Great Britain	Rowing	Eights, outriggers.
Parker, T. C. ...	Australasia	»	»
Parnell, E. L. ...	Great Britain	Shooting	a. b. c.
Parton, M.	»	Lawn Tennis (covered courts)	Ladies' Singles, Mixed Doubles.
Paseman, R. ...	Germany	Athletics	Broad jump, pole jump.
Paszthy, E.	Hungary	Gymnastics	Team competition II, ind. comp.
Pataki, M.	»	Football	
Patching, G. H.	South Africa	Athletics	100 m. flat, 200 m. flat, 400 m. flat.
Paternelli, P. ...	Austria	Shooting	p. q.
Patou, J.	Belgium	Cycling	Cycling road race round Lake Mälär.
Patterson, A. ...	Great Britain	Athletics	800 m. flat.
Patterson, N. J.	U. S. A.	»	1,500 m. flat.
Patterson, R. ...	South Africa	Shooting	a. b. c. d. e.
Patton, Jr G. S.	U. S. A.	Modern Pentathlon	
Pauen, C.	Germany	»	»
Paulsen, E.	Norway	Gymnastics	Team competition I.
Pautex, L.	France	Athletics	Marathon race;
Payer, Imre.	Hungary	Football	
Pawlow, P. W.	Russia	Yacht Racing	8- m class.
Pawlowitch, P. ...	»	Wrestling	Feather weight.
Peacock, W. ...	Great Britain	Swimming	Water Polo.
Pedersen, A. ...	Norway	Athletics	100 m. flat, 400 m. flat
Pedersen, C. ...	»	Gymnastics	Team competition I.
Pedersen, C. J.	Denmark	»	» » III, ind. comp.
Pedersen, H. E.	»	»	Team competition I.
Pedersen, I.	Norway	Football	
Pedersen, J.	»	Athletics	400 m. flat, 800 m. flat, 1,500 m. flat.
Pedersen, K. ...	»	Football	
Pedersen, N. ...	Denmark	Athletics	Walking race.
Pedersen, O. ...	»	Gymnastics	Team competition I.
Pedersen, P. ...	Norway	»	» » I.
Pedersen, P. L.	Denmark	»	» » I.
Pedersen, V. ...	»	Athletics	10,000 m. flat, cross -country race.
Pédery, A.	Hungary	Gymnastics	Team competition II.
Peinaud, P.	France	Cycling	Cycling road race round Lake Mälär.
Pekkalainen, A.	Finland	Yacht Racing	10 -m. class.
Pelander, G. U.	»	Wrestling	Heavy weight.
Pelkonen, A. ...	»	Gymnastics	Team competition III.
Pell, T. R.	U. S. A.	Lawn Tennis (out-of-door-courts)	Gentlemen's Singles.
Pelletier, M.	Luxemburg	Athletics	Throwing the discus, b. h., Putting the weight, b. h.
Peltonen, U.	Finland	»	Throwing the javelin, b. h., r. & l. h.
Penc, V.	Bohemia	»	10,000 m. flat, Marathon race.
Pepé, J.	Great Britain	Shooting	f. g. h. i.
Pepper, E. E. ...	»	Gymnastics	Team competition II.

Name	Nation	Branch of Athletics	Competition
Percy, L.	France	Shooting	a. b. c. d. e.
Pereira, A.	Portugal	Wrestling	Feather weight.
Perk, A. C.	Holland	Fencing	Ind. épée, team épée.
Pernaja, I.	Finland	Gymnastics	Team competition III.
Personne, C. B.	Sweden	Fencing	Foils, ind. sabre, team sabre.
Persson, A. W.	»	Cycling	Cycling road race round Lake Mälär.
Persson, E. P. L.	»	Wrestling	Feather weight.
Person, J.	Germany	Athletics	400m. flat, 800m. flat.
Persson, K. P. ...	Sweden	Football	»
Persson, M.	»	Athletics	5,000 m. flat, 10,000 m. flat.
Persson, N.	»	Yacht Racing	12-m. class.
Persson, T.	»	Athletics	100 m. flat, 200 m. flat, relay race 400 m.
Pertel, B.	Russia	Shooting	0.
Pesteriff, S.	»	Cycling	Cycling road race round Lake Mälär.
Petersen, A. C.	Denmark	Football	»
Petersen, C. E. O.	»	Gymnastics	Team competition III.
Petersen, C. F.	»	Rowing	Fours, inriggers.
Petersen, H.	»	Gymnastics	Team competition I.
Petersen, N.	»	»	» III, ind. comp.
Peterson, P. M.	Norway	Lawn Tennis (out-of-door courts)	Gentlemen's Singles, » Doubles.
Petroff, E.	Russia	Athletics	1,500 m. flat.
Pettersen, B. ...	Norway	Gymnastics	Team competition III.
Pettersson, F. G.	Sweden	Football	»
Pettersson, J. A.	»	Cycling	Cycling road race round Lake Mälär.
Petropoulos, G.	Greece	Fencing	Ind. épée.
Pfeiffer, J.	Bohemia	Shooting	1.
Phelps, R. E. ...	Great Britain	Fencing	Foils, ind. épée team épée team sabre.
Philbrook, G. W.	U. S. A.	Wrestling	Light weight.
		Athletics	Throwing the discus, b.h., Putting the weight, b.h., Decathlon.
Pietrasanta F. ...	Italy	Fencing	Foils, ind. sabre, team sabre.
Piggott, R. F. ...	U. S. A.	Athletics	Marathon race.
Pihkala, L.	Finland	»	800 m. flat.
Pike, J. R.	U. S. A.	Cycling	Cycling road race round Lake Mälär.
Pikker, A.	Russia	Wrestling	Middle weight B.
Pimm, W. E. ...	Great Britain	Shooting	f. g. h. i.
Pinchard, G. E.	»	»	0.
Pipes, F.	Austria	Lawn Tennis (out-of-door courts)	Gentlemen's Singles, » Doubles.
Pitman, F. A. H. .	Great Britain	Rowing	Eights, outriggers.
Pjetursson, S. ...	Iceland	Wrestling	Middle weight B.
Plaskuda, H. ...	Germany	Fencing	Foils, ind. épée team épée team sabre.
Plater, P.	Great Britain	Shooting	b. c.
Platon, H. F. S.	Norway	Fencing	Ind. épée team épée

Name	Nation	Branch of Athletics	Competition
Pleckhoff, M. ...	Russia	Horse Riding comp.	Prize jumping, ind. & team.
Pletinckx, J.	Belgium	Swimming	Water Polo.
Podgornoff, N.	Russia	Yacht Racing	8-m. class.
Pohlis, J.	»	Wrestling	Middle weight A.
Poix, G.	France	Rowing	Fours, inriggers.
Pongracz, J.	Hungary	Wrestling	Feather weight.
Pontenani, A. ...	Italy	Fencing	Ind. sabre.
Ponurski, W. ...	Austria	Athletics	200 m. flat, 400 m. flat.
Porter, C. H. A.	Great Britain	»	5,000 m. flat, team race 3,000 m.
van Post, A. Zo.	U. S. A.	Fencing	Foils, ind. épée team; épée ind. sabre.
de Potékine, W.	Russia	Shooting	g.
Pott, H. E.	Great Britain	Swimming	Spring-board diving.
Potts, E. W. ...	»	Gymnastics	Team competition II.
Potts, R. H. ...	»	»	» » II, ind. comp.
Poulenard, C. A.	France	Athletics	200 m. flat, 400 m. flat, 800 m. flat, relay race 1,600 m.
Poulter, H. O. ...	Great Britain	Shooting	j. k. l.
Poulter, S. H. ...	Australasia	Athletics	Marathon race.
Povey, R.	South Africa	»	100 m. flat, 200 m. flat.
Powell, K.	Great Britain	»	Hurdle race.
Praem, J. V. T.	Denmark	Rowing	Fours, outriggers.
Pratneek, J.	Russia	Cycling	Cycling road race round Lake Mälär.
Preuss, A.	Germany	Shooting	n. o. q. r.
Prihoda, S.	Hungary	»	a. c. e.
Pritchard, E. M.	U. S. A.	Athletics	Hurdle race.
Prokopp, A.	Hungary	Shooting	c.
Prouvost, G. ...	France	Swimming	Water Polo.
Psyha, P.	Greece	»	100 m. back stroke.
Puhm, J.	Austria	Fencing	Foils, ind. sabre, team sabre.
Pukkila, T. V. ...	Finland	Wrestling	Light weight.
Puschnitsky ...	Russia	Yacht Racing	10-m. class.
Putnam, H. N. ...	U. S. A.	Athletics	800 m. flat, 1,500 m. flat.
Quinn, P.	Great Britain	»	Putting the weight, b. h.
Rabe, W.	Germany	Cycling	Cycling road race round Lake Mälär.
Racine, J.	France	»	Cycling road race round Lake Mälär.
Rács, V.	Hungary	Athletics	100 m. flat, relay race 400 m.
Radcliffe-Nash, E.	Great Britain	Horse Riding comp.	Military, Prize jumping, ind.
Radmilovic, P. ...	»	Swimming	100 m. free style, water polo.
Radoczy, K.	Hungary	Athletics	800 m. flat.
Radvany, Ö.	»	Wrestling	Light weight.
Raita, A. A. ...	Finland	Cycling	Cycling road race round Lake Mälär.
Rajala, A.	»	Wrestling	Middle weight R.

Name	Nation	Branch of Athletics	Competition
Rames, B.	Bohemia	Cycling	Cycling road race round Lake Mälär.
Ramme, W.	Germany	Swimming	100 m. free style.
Rammer, R.	Austria	Cycling	Cycling road race round Lake Mälär.
Rapin, F.	France	Athletics	100 m. flat
Rasmussen, A.	Denmark	»	Walking race,
Rasmussen, S.	»	»	Cross-country race.
Rasso, N.	Russia	»	Marathon race.
Rath, E.	Austria	»	» » , cross -country race.
Rathmann, O. .	Germany	Cycling	Cycling road race round Lake Mälär.
Rau, R.	»	Athletics	100 m. flat, 200 in. flat, relay race 400 m.
Rauch, K.	Austria	»	100 m. flat, 200 m. flat, relay race 400 m.
Rauss, H.	»	Wrestling	Feather weight.
Rayner, H. M. ...	U. S. A.	Fencing	Foils, team épée.
de Rechke, O. ...	Russia	Shooting	b. c. e.
Rechner, V.	Bohemia	Fencing	Foils, ind. épée.
Reese, H. H. ...	Germany	Football	
Refsum, T.	Norway	Shooting	b. e.
Regaud, A.	France	»	g. k.
Regaud, J.	»	»	f.
Regnell, Elsa ...	Sweden	Swimming	High (plain) diving, ladies.
Regnell, Lisa ...	»	»	High (plain) diving, ladies.
Reichelt, R.	Germany	Rowing	Eights, outriggers.
Reichenbach, K.	»	Gymnastics	Team competition II, » » III.
Reid, J.	Great Britain	Shooting	a. b.
Reidpath, C. D.	U. S. A.	Athletics	200 m. flat, 400 m. flat, relay race 1,600 m.
Reilin, K. H. L.	Finland	Shooting	q.
Reilly, J. H. ..	U. S. A.	Swimming	100 in. free style, 400 » » » Marathon race.
Reimann, E. ...	Russia	Athletics	Marathon race.
Reimfeld, E. ...	Germany	Rowing	Eights, outriggers.
Reinholt, H. ...	Norway	Football	
Reinvald, J. F.	Denmark	Cycling	Cycling road race round Lake Mälär.
Relssner, H. ...	Austria	Swimming	Water Polo.
Rémi, K.	Hungary	»	»
Renz, E.	U. S. A.	Athletics	Walking race.
Réti, J.	Hungary	Gymnastics	Team competition II.
Retschury, H. ...	Austria	Football	
Retzer, Jr, G. W.	U. S. A.	Wrestling	Feather weight.
Reuschle, J.	Germany	Gymnastics	Team competition II, » » III.
Révezs, B.	Hungary	Football	
Reynolds, J. J. ...	U. S. A.	Athletics	Marathon race.
Reyntiens, G. ...	Belgium	Horse Riding comp.	Military, Prize jumping. ind.
Rhys, N. R. ...	Great Britain	Wrestling	Middle weight A.
Rice, R. G.	»	Athletics	100 m. flat, 200 m. flat.

Name	Nation	Branch of Athletics	Competition
Richard, A.	France	Rowing	Fours, inriggers.
Richards, A. W.	U. S. A.	Athletics	High jump.
Richardson, L. ...	South Africa	»	10,000 m. flat; cross-country race.
Richardson, W.	Great Britain	Shooting	b. c.
Richter, E.	Russia	Cycling	Cycling road race round Lake Mälär.
Richter, K. W. ...	Germany	Gymnastics	Team competition II; team competition III.
Richter, R.	Bohemia	Athletics	Walking race.
Riddy, C.	Canada	Rowing	Eights, outriggers.
Rieder, J.	Germany	Cycling	Cycling road race round Lake Mälär.
Rigal, G.	France	Swimming	100 m. free style; water polo.
Rillon, R.	»	Cycling	Cycling road race round Lake Mälär.
de Rimscha, F.	Russia	Football	
Ripszam J:r, H.	Hungary	Athletics	Walking race; Marathon race.
Ritter, M.	Germany	Swimming	100 m. free style; 400 m. free style; team race 800 m.
Robach R.	Norway	Gymnastics	Team competition I.
von Rochow ...	Germany	Horse Riding comp.	Military; prize riding.
Rode, L. S.	Norway	Rowing	Fours, outriggers.
Rodier, J.	France	Swimming	Water Polo.
Rodionow, A. ...	Russia	Yacht Racing	10-m. class.
Rodzianko, A. ...	»	Horse Riding comp.	Prize jump., ind. & team.
Roedder, H. ...	U. S. A.	Shooting	k. m.
Rolot, G. J. B. ...	France	Athletics	100 m. flat; 200 m. flat; 400 m. flat; relay race; 400 m.
Rom, F.	Belgium	Fencing	Foils; team épée; ind. épée.
Romander, N. ...	Sweden	Shooting	c.
Romano, G.	Italy	Gymnastics	Team competition II; ind. comp.
Roper-Barrett, H.	Great Britain	Lawn Tennis (covered courts)	Gentlemen's Singles; Gentlemen's Doubles; Mixed Doubles.
Rose, R. W. ...	U. S. A.	Athletics	Throwing the discus, b. h.; Putting the weight, b. h., r. & i. h.; throwing the hammer.
von Rosen, H. ...	Sweden	Horse Riding comp.	Prize jumping, team.
von Rosen, P. R. C.	»	Fencing	Ind. épée; team épée.
Rosén, S. A. A.	»	Gymnastics	Team competition I.
Rosenberg, F. ...	Norway	Shooting	o.
Rosenberg, Grete	Germany	Swimming	100 m. free style, ladies; team race 400 m., ladies.
Rosenberger, J.M.	U. S. A.	Athletics	400 m. flat.
Rosenblad, C. ...	Sweden	Horse Riding comp.	Prize riding.
Rosencrantz, F.	»	»	Prize jumping, team.
Rosenqvist, E. E.	Finland	Shooting	p. q.

Name	Nation	Branch of Athletics	Competition
Rosenswård, H.	Sweden	Yacht Racing	10-m. class.
Ross, C. M. ...	Australasia	Athletics	400 m. flat.
Ross, G. J.	Great Britain	Gymnastics	Team competition II.
Ross-Boden, H.	Australasia	Rowing	Eights, outriggers.
van Rossem, G.	Holland	Fencing	Ind. épée, team épée; ind. sabre, team sabre.
Rosty, P.	Hungary	»	Ind. épée.
Rosvall, T.	Sweden	Rowing	Eights, outriggers; fours, inriggers.
Roth, H.	Germany	Gymnastics	Team competition II; team competition III.
Rought, C. G. ...	Great Britain	Rowing	Fours, outriggers.
von Roummel, C.	Russia	Horse Riding comp.	Prize jumping, ind.
Rovsing, L.	Denmark	Lawn Tennis (out-of-door courts)	Gentlemen's Singles; Gentlemen's Doubles.
Rucks, A.	Russia	Athletics	1,500 m. flat.
Ruff, W.	Great Britain	Wrestling	Light weight.
Ruffel, C. H. ...	»	Athletics	1,500 m. flat; 5,000 m. flat; 10,000 m. flat; cross-country race.
Ruggero, F. ...	Italy	»	Marathon race.
Rumbold, C. ...	Hungary	Football	
Runeborg, G. A. I.	Sweden	Swimming	Water Polo.
Runge, K.	Germany	Rowing	Eights, outriggers.
Runström, A. W.	Sweden	Swimming	High (plain) diving, spring-board diving.
Rusten, A.	Norway	»	200 m. breast stroke.
Ryan, M. J.	U. S. A.	Athletics	Marathon race.
Ryberg, I.	Sweden	Rowing	Eights, outriggers.
Rydman, A.	Finland	Gymnastics	Team competition III.
Rydström, R. R.	Sweden	Wrestling	Light weight.
Ryrie, J. A.	Australasia	Rowing	Eights, outriggers,
Röhr, O.	Germany	Athletics	High jump; Decathlon.
Rönström, G. ...	Sweden	»	Decathlon.
Röpnack, H. ...	Germany	Football	
Saarela, U. E. M.	Finland	Wrestling	Heavy weight.
Saaristo, J. J. ...	»	Athletics	Throwing the javelin, b. h., r. & l. h.
Saastamoinen, E.	»	Gymnastics	Team competition III.
Sælen, F.	Norway	»	»
Sæther, Ole	»	Shooting	b. d. e.
Sætherhaug, M.	»	Cycling	Cycling road race round Lake Mälär.
Sæter, Olof.	»	Shooting	d. e.
Saintongey, R. P.	France	Rowing	Fours, outriggers.
Sakellaropoulos, H. P.	Greece	Athletics	Marathon race.
Sakiritch, G. ...	Russia	Fencing	Ind. sabre, team sabre.
Salila, J. K.	Finland	Wrestling	Middle weight B.
Salinas, S. R. ...	Chili	Athletics	Walking race.
Salm-Hoogstraeten, L.	Austria	Lawn Tennis (out-of-door courts)	Gentlemen's Singles.
Salmon, C. J. M.	Belgium	Fencing	Foils, ind. épée, team épée, team sabre.

Name	Nation	Branch of Athletics	Competition
Salonen, J. A. ...	Finland	Wrestling	Light weight.
Salovaara, A. ...	»	Gymnastics	Team competition III.
Salvi, P.	Italy	»	Team competition II.
Sammallahti, H.	Finland	»	Team competition III.
Samoilow, W. ...	Russia	Fencing	Foils.
Sanchez, R. A. ...	Chili	Athletics	5,000 m. flat; 10,000 m. flat.
Sandberg, A. ...	Sweden	Wrestling	Heavy weight.
Sandberg, E. ...	»	Yacht Racing	6-m. class.
Sandberg, G. ...	»	Football	
Sandberg, H. ...	»	Yacht Racing	6-m. class.
Sandelin, E. ...	Finland	»	12-m. class.
Sandelin, T. ...	»	»	6-m. class.
Sanders, S. C. ...	Great Britain	Football	
Sandon, F.	»	Swimming	100 m. back stroke.
Sandor, J.	Hungary	Wrestling	Light weight.
Sandoz, E.	France	Shooting	1. m.
Santesson, S. ...	Sweden	Athletics	Pole jump.
von Sarbogard, G. M.	Hungary	Shooting	a. b. c. e.
Sardi, C.	Italy	Football	
de Sarnawsky, W.	Russia	Fencing	Foils, ind. épée, team épée,
Sartori, A.	France	Shooting	b. c. e.
Sauer, A. E. ...	U. S. A.	Fencing	Foils, ind. épée, team épée, ind. sabre.
Sauerhöfer, L. ...	Germany	Wrestling	Light weight.
Saunte, C. H. ...	Denmark	Horse Riding comp.	Military; prize riding.
Savnik, T.	Hungary	Athletics	1,500 m. flat.
Savorini, L.	Italy	Gymnastics	Team competition II.
Sayre, R. H. ...	U. S. A.	Shooting	k. l. m.
Scalogne, D. ...	Holland	Fencing	Ind. sabre; team sabre.
Scarlatos, C. ...	Greece	Shooting	j. k. l. m.
Schachlitz, W. ...	Austria	Swimming	Water Polo.
von Schaesberg- Thannheim, R.	Germany	Horse Riding comp.	Military.
Scharer, F.	Austria	Wrestling	Feather weight.
Schartau, F. A.	Sweden	Shooting	m.
Schejbal, B.	Bohemia	Fencing	Team sabre.
Schenk, F.	U. S. A.	»	Ind. épée, team épée,
Schenger, Z. ...	Hungary	»	Foils; ind. sabre; team sabre.
de Schesterikoff, G.	Russia	Shooting	j. k. m.
Schiele, O.	Germany	Swimming	100 m. back stroke; 400 m. free style; 800 m. team race.
Schirmer, Ö. ...	Norway	Gymnastics	Team competition III.
Schjöh, O.	»	Rowing	Fours, outriggers.
Schlosser, I. ...	Hungary	Football	
Schmal Jr., A. ...	Austria	Shooting	k. m.
Schnitt, G. A. ...	Finland	»	n. o.
Schomaker, J. ...	Russia	Yacht Racing	10-m. class.
Schomburgk, H.	Germany	Lawn Tennis (out-of-door courts)	Gentlemen's Singles; Gentlemen's Doubles; Mixed Doubles.
Schrader, H. ...	Germany	Fencing	Ind. épée.

Name	Nation	Branch of Athletics	Competition
Schryver, F. ...	Australasia	Swimming	200 m. breast stroke; 400 m. breast stroke.
Schuh, F.	Austria	»	400 m. free style; 1,500 m. free style; water polo.
Schultz, H. K. ...	Denmark	Shooting	a. b. c. e.
Schultze, E.	Germany	Swimming	100 m. back stroke.
Schurrer, R. ...	France	Athletics	100 m. flat; 200 m. flat; 400 m. flat; relay race 1,600 m.
Schutte, C. O. ...	U. S. A.	Cycling	Cycling road race round Lake Mälär.
Schwartz, S.	»	Athletics	Walking race.
Schwarz, A.	Russia	»	High jump.
Schwarz, F.	Germany	Fencing	Ind. épée, team épée; ind. sabre, team sabre.
Schwarz, R.	Russia	Athletics	100 m. flat.
Schwedrewitz, N.	»	»	Throwing the javelin, b. h.
Schybergson, L.	Finland	Football	
Schäffer, J.	Austria	Athletics	Throwing the discus, b. h., r. & l. h.; putting the weight, b. h.; De- cathlon.
Schön, E.	Germany	Fencing	Foils, ind. épée, team épée, team sabre.
Scott, H. L. ...	U. S. A.	Athletics	5,000 m. flat; 10,000 m. flat; team race 3,000 m.; cross-country race.
Scott, H. S. L. ...	Great Britain	Horse Riding comp.	Military; prize jumping, ind.
Scott, W.	U. S. A.	Athletics	10,000 m. flat; cross- -country race.
Sears, H. E. ...	»	Shooting	j. k. m.
Sebek, J.	Bohemia	Lawn Tennis (out of-door courts)	Gentlemen's Singles; Gentlemen's Doubles.
Sebestyén, B. ...	Hungary	Football	
Sedgewick, J. ...	Great Britain	Shooting	b. c.
Seebass, A.	Germany	Gymnastics	Team competition II; team competition III.
Seedhouse, C. N.	Great Britain	Athletics	200 m. flat; 400 m. flat; relay race 1,600 m.
Ségura, L.	France	Gymnastics	Ind. competition.
Seidelin-Nielsen, I. L.	Denmark	Football	
Seigner,	France	Horse Riding comp.	Military; prize riding; prize jumping, team.
Selenius, G.	Norway	Gymnastics	Team competition III.
Seligman, E. ...	Great Britain	Fencing	Foils, ind. épée, team épée.
Selikhoff, A. ...	Russia	Horse Riding comp.	Prize jumping, ind. & team.
Setterberg, C. L.	Sweden	Fencing	Foils.
Setterwall, G. ...	»	Lawn Tennis (covered & out-of- door courts)	Gentlemen's Singles; Gentlemen's Doubles; Mixed Doubles.
Sewell, J.	Great Britain	Athletics	Tug-of-War.

Name	Nation	Branch of Athletics	Competition
Seweroff, A. ...	Russia	Wrestling	Middle weight A.
Sharpe, I. G. ...	Great Britain	Football	
Sheff-Sochaczewski, O.	Austria	Swimming	Water Polo.
Shepherd, J. ...	Great Britain	Athletics	Tug-of-War.
Sheppard, M. W.	U. S. A.	»	400 m. flat; 800 m. flat; 1,500 m. flat; relay race 1,600 m.
Sherman, B. F. von Siengalewicz Z.	»	Athletics	Throwing the hammer.
von Siegel, E. ...	Austria	Swimming	400 m. breast stroke.
	Germany	Athletics	1,500 m. flat; team race 3000 m.
Siikaniemi, W. ...	Finland	»	Throwing the javelin, b. h., r. & l. h.
Silén, J.	»	Yacht Racing	12-m. class.
Silfverskiöld, N.	Sweden	Gymnastics	Team competition I.
Silfverstolpe, L.	»	Lawn Tennis (covered courts)	Gentlemen's Singles.
Silfverstrand, C.	»	Gymnastics	Team competition I.
Simmons, C. ...	Great Britain	»	Team competition II; ind. comp.
Simon, L.	Luxemburg	»	Team competition II; team competition III.
Simonsen, A. G.	Norway	Athletics	Marathon race.
Simonsen, M. ...	Denmark	Rowing	Fours, outriggers; Single Sculls.
Sinclair, A.	Canada	»	Eights, outriggers.
Sint, J.	Holland	Wrestling	Middle weight A.
Sirola, H.	Finland	Gymnastics	Team competition III.
Sivertsen, S. ...	Norway	»	»
Sjursen, R.	»	»	»
Sjöberg, G. G. ...	Sweden	Swimming	Plain and variety diving.
Sjöberg, R.	»	Athletics	High jump; pole jump.
Sjöqvist, F. H. ...	»	Yacht Racing	8-m. class.
Sjöqvist, J. A. ...	»	»	»
Skatteboe, G. G.	Norway	Shooting	b. d. e.
Skilton, E.	Great Britain	»	a. b.
Skjerven, H. N.	Norway	»	c.
Skog, N. J.	Sweden	»	e.
Skogen, E. E. ...	Norway	»	c. e.
Skou, P.	»	Football	
de Skrotsky, B.	Russia	Shooting	p. q. r.
Slavik, F.	Bohemia	Athletics	Marathon race.
Sluis, J. van der	Holland	Football	
Smebye, S.	Norway	Gymnastics	Team competition I.
Smedberg, S. ...	Denmark	Rowing	Fours, outriggers.
Smedmark, R. ...	Sweden	Athletics	100 m. flat, 200 m. flat; high jump.
Smiel, H.	Germany	Cycling	Cycling road race round Lake Mälär.
Smirmoff, L. ...	Russia	Football	
Smirmoff, M. ...	»	»	
Smith, A. A. ...	South Africa	Shooting	a. c. d. e.
Smith, C. S. ...	Great Britain	Swimming	Water Polo.
Smith, H. J. ...	U. S. A.	Athletics	Marathon race.

Name	Nation	Branch of Athletics	Competition
Smith, M. O. ...	Denmark	Cycling	Cycling road race round Lake Mälär.
Smith, T.	Norway	Lawn Tennis (out-of-door courts)	Gentlemen's Singles; Gentlemen's Doubles.
Sockalexis, A. ...	U. S. A.	Athletics	Marathon race.
Soinio, E. A. ...	Finland	Football	
Soinio, K. E. ...	»	»	
Sokoloff, P. P. ...	Russia	»	
Solberg, O.	Norway	Rowing	Eights, outriggers; fours, in riggers.
Soldatencow, A.	Russia	Fencing	Ind. épée, team épée.
Solymar, K.	Hungary	Athletics	Hurdle race.
Somers, J. P. ...	Great Britain	Shooting	b. c.
Sommerfeldt, E.	Norway	Rowing	Eights, outriggers.
Somogzi, R. ...	Hungary	Wrestling	Middle weight A.
Sonne, H.	Sweden	Athletics	Throwing the javelin, b. h., r. & l. h.
Sorge, E.	Germany	Gymnastics	Team competition II; team competition III.
Sotaaen, H.	Norway	Athletics	100 m. flat; 200 m. flat.
Soumarokoff- Elston, M. ...	Russia	Lawn Tennis (out-of-door courts)	Gentlemen's Singles; Gentlemen's Doubles.
Sourek, J.	Bohemia	Rowing	Single Sculls.
Southern, A. G.	Great Britain	Gymnastics	Team competition II.
Soutter, J. T. ...	»	Athletics	400 m. flat; 800 m. flat; relay race 1,600 m.
Sparre, P. L. ...	Sweden	Fencing	Ind. épée, team épée,
Speciale, P.	Italy	»	Foils, team sabre.
Speirs, Annie	Great Britain	Swimming	100 m. free style, ladies; 400 m. team race, ladies.
Sperling, A.	Germany	Gymnastics	Team competition II; team competition III.
Speroni, C.	Italy	Athletics	Marathon race.
Spies, R. C.	Germany	Lawn Tennis (out-of-door courts)	Gentlemen's Singles; Gentlemen's Doubles.
Spotts, R. L. ...	U. S. A.	Shooting	n. o.
Sprout, W. A. ...	»	»	a. b. c. e. f. g. h. i.
Staats, A.	Germany	Gymnastics	Team competition II; team competition III.
Stabell, A.	Norway	Shooting	o.
Stahnke, M.	Germany	Rowing	Single Sculls.
Staib, F.	Norway	Yacht Racing	12-m. class.
Stamper, H.	Great Britain	Football	
Steer, Irene	»	Swimming	100 m. free style, ladies; 400 m. team race, ladies.
Stefenson, J. H.	Sweden	»	High (plain) diving; plain and variety diving.
Steffan, M. M. ...	Germany	Fencing	Ind. sabre.
Stein, C.	»	Wrestling	Feather weight.
Steinback, E. ...	Austria	Shooting	p. q.
Steinert, J.	U. S. A.	Cycling	Cycling road race round Lake Mälär.
Stenborg, K. ...	Sweden	Athletics	100 m. flat; 200 m. flat; 400 m. flat.

Name	Nation	Branch of Athletics	Competition
Stenbäck, R. ...	Finland	Yacht Racing	6-m. class.
Stenroos, A. ...	»	Athletics	10,000 m. flat; team race 3,000 m.; cross-country race.
Stejskal, J.	Austria	Wrestling	Light weight.
Steputat, W.	Germany	»	Middle weight A.
Stevenson, D. M.	Great Britain	Cycling	Cycling road race round Lake Mälär.
Stevenson, J. ...	»	»	Cycling road race round Lake Mälär.
Stewart, C. E. ...	»	Shooting	j. k. l.
Stewart, W. A. ...	Australasia	Athletics	100 m. flat; 200 m. flat.
Stibolt, N.	Norway	Lawn Tennis (out-of-door courts)	Gentlemen's Singles; Gentlemen's Doubles.
Sticker, L.	Austria	Swimming	100 m. free style, ladies.
de Stieglitz, P. ...	Russia	Athletics	100 m. flat.
Stiemspez, G. E.	Sweden	Shooting	k.
Stiemspez, Y. ...	»	Gymnastics	Team competition I.
Stindt, Hermine	Germany	Swimming	100 m. free style, ladies; 400 m. team race, ladies.
Stokes, A. J. ...	Great Britain	Cycling	Cycling road race round Lake Mälär.
Stradi, P.	Italy	Gymnastics	Team competition II.
Stranne, J. S. ...	Sweden	Fencing	Team sabre.
Strauch	Russia	Modern Pentathlon	
Strid, K.	Sweden	Yacht Racing	10-m. class.
Stridfeldt, P. A.	»	Athletics	Tug-of-War.
Strobino, G. ...	»	Shooting	c.
Stromp, A.	U. S. A.	Athletics	Marathon race.
Ström, E.	Portugal	»	100 m. flat; 200 m. flat.
af Ström, O.	Norway	Gymnastics	Team competition III.
Studnicka, J. ...	Sweden	Horse Riding comp.	Prize riding,
Styles, W. K. ...	Austria	Football	
Stöhr, G.	Great Britain	Shooting	g. h. i.
Sund, C. J.	Germany	Fencing	Foils, ind. sabre.
Sunde, A. T. ...	Sweden	Shooting	b.
Sundholm, K. ...	Norway	»	a. b. c. e. g.
Sundman, G. I.	Sweden	Rowing	Fours, outriggers.
Sundqvist, J. ...	»	Swimming	100 m. back stroke.
Suni, L. O.	»	Athletics	Cross-country race.
Suomela, K. U.	Finland	Swimming	High (plain) diving: plain and variety diving.
Sustera, M.	»	Gymnastics	Team competition III.
Suttner, A.	Bohemia	Athletics	Throwing the discus, b.h.
Swahn, A.	Austria	Fencing	Foils, ind. épée; team sabre.
Swahn, O. G. ...	Sweden	Shooting	n. o. p. q. r.
Swann, S. E. ...	»	»	o. p. q. r.
Swatosh, J.	Great Britain	Rowing	Eights, outriggers.
Svendel, A.	Austria	Football	
Svensen, C. V.	Sweden	Rowing	Eights, outriggers.
Svensen, H. ...	Sweden	Gymnastics	Team competition III.
Svensson, C. E.	»	Swimming	100 m. back stroke.
Svensson, C.O.H.	Sweden	Gymnastics	Team competition I.
Svensson, G. ...	»	Football	
		Wrestling	Light weight.

Name	Nation	Branch of Athletics	Competition
Svensson, H. ...	Sweden	Athletics	Pole jump.
Svensson, H. ...	»	Football	
Svensson, I. S. ...	»	»	
Svensson, K. J. ...	»	Gymnastics	Team competition I.
Svorcik, O.	Bohemia	Fencing	Team sabre.
Syrjäläinen, M. A.	Finland	Football	
Syson, A. E. ...	Great Britain	Fencing	Ind. sabre.
Syttine, L.	Russia	Shooting	0.
Szalai, P.	Hungary	Athletics	100 m. flat; broad jump; relay race 400 m.
Szalay, J.	»	Gymnastics	Ind. competition.
Szantho, A.	»	Wrestling	Light weight.
Szebeny, A.	»	Rowing	Eights, outriggers.
Szebeny, G.	»	»	»
Szebeny, N.	»	»	»
Szebeny, S.	»	»	»
Szentgrothy, L. ...	»	Swimming	100 m. back stroke.
Szerelemhegyi, E.	»	Athletics	100 m. flat; 200 m. flat; 400 m. flat; relay race 1,600 m.
Szobota, F.	»	»	100 m. flat; relay race 400 m.
Szoszki, A.	»	Wrestling	Feather weight.
Szury, K.	»	Football	
Szűts, F.	»	Gymnastics	Team competition II.
Sällström, R. H.	Sweden	Yacht Racing	12-m. class.
Sökjer-Petersen, E.	»	Shooting	q. r.
Sörensen, A. ...	Denmark	Gymnastics	Team competition I.
Sörensen, E. F.	Sweden	Fencing	Ind. épée, team épée.
Sörensson, J. ...	»	Gymnastics	Team competition I.
Sörvik, L.	»	Rowing	Eights, outriggers.
Taber, N. S. ...	U. S. A.	Athletics	1,500 m. flat.
Taipale, A. R. ...	Finland	»	Throwing the discus, b. h., r. & l. h.
Tait, J. L.	Canada	»	800 m. flat; 1,500 m. flat; relay race 1,600 m.
Tallberg, B.	Finland	Yacht Racing	8-m. class.
Tallberg, G. ...	»	»	
Tamm, S.	Sweden	Rowing	Eights, outriggers.
Tamminen, A. F.	Finland	Gymnastics	Ind. competition.
von Tangen, G.	Norway	Fencing	Foils, team épée, ind épée,
Tanner, L.	Finland	Gymnastics	Team competition III.
Tanner, L. A. ...	»	Football	
Tanttu, A. R. ...	»	Wrestling	Light weight.
Tapscott, L. E.	South Africa	Lawn Tennis (out-of-door courts)	Gentlemen's Singles.
Tartakover, T. ...	Australasia	Swimming	100 m. free style; 400 m. free style.
Tauson, H. C. ...	Denmark	Shooting	e.
Taylor, A. W. ...	Great Britain	Wrestling	Feather weight.
Taylor, G. B. ...	Canada	Rowing	Eights, outriggers.
Taylor, H.	Great Britain	Swimming	400 m. free style; 1,500 m. free style; 800 m. team race.
Tekusch, F.	Austria	Football	

Name	Nation	Branch of Athletics	Competition
Tekusch, H.	Austria	Football	
Teppert, K.	Hungary	Cycling	Cycling road race round Lake Mälär.
Terawain, H.	Russia	Football	
Ternström, J.	Sweden	Athletics	Cross-country race.
Tery, O.	Hungary	Gymnastics	Team competition II.
Tewanima, L.	U. S. A.	Athletics	10,000 m flat; Marathon race.
Texier, R.	France	Shooting	n. o.
Thau, M. H.	Denmark	Gymnastics	Team competition I.
Thaulow, G.	Norway	Yacht Racing	12-m. class.
Thayssen, A.	Denmark	Lawn Tennis (out-of-door courts)	Gentlemen's Singles; Gentlemen's Doubles.
Theander, B. D.	Sweden	Swimming	400 m. free style.
Theiszenberger, I.	Hungary	Cycling	Cycling road race round Lake Mälär.
Theophilakis, A.	Greece	Shooting	a. b. c. j. k. m.
Theophilakis, J.	»	»	a. b.c. f.g.h.i.j.k.l.m.q.
Theophilas, J. ...	»	»	a. b. c. f. g. h. i.
Thiel, A.	Sweden	Yacht Racing	8 m. class.
Thiel, O.	Germany	Football	
Thielemann, L.	Norway	Shooting	b. c.
Thomas, R. B.	U. S. A.	Athletics	100 m. flat.
Thomaturge, L.	France	Rowing	Fours, outriggers.
Thommes, J. P.	Luxemburg	Gymnastics	Team competition II; team competition III; ind. comp.
Thompson, R.	Great Britain	Cycling	Cycling road race round Lake Mälär.
Thomsen, S. B.	Denmark	Yacht Racing	6-m. class.
Thomson, H. ...	Germany	Fencing	Ind. épée; ind. sabre,
Thomson, J. ...	»	»	Foils.
Thorborg, S. F.	Denmark	Gymnastics	Team competition I.
Thorpe, J.	U. S. A.	Athletics	High jump; broad jump; Pentathlon; Decathlon.
Thorstensen, M.	Norway	Rowing	Fours, outriggers.
Thubé, A.	France	Yacht Racing	6-m. class.
Thubé, G.	»	»	»
Thubé, J.	»	»	»
Thufason, A. M.	Denmark	Football	
Thulin, Vera ...	Sweden	Swimming	100 m. free style, ladies; high (plain) diving, ladies.
Thymann, P. ...	Denmark	Rowing	Fours, outriggers.
Tickell, E. J. ...	Great Britain	Shooting	k.
Tiiri, W. E.	Finland	Gymnastics	Team competition III.
de Tillo, A. ...	Russia	Shooting	a. b. c. d. e.
Tilkanen, W. O.	Finland	Cycling	Cycling road race round Lake Mälär.
Timofeew, A. ...	Russia	Fencing	Ind. sabre; team sabre.
Tintera, V.	Bohemia	Cycling	Cycling road race round Lake Mälär.
Tirkkonen, T. A.	Finland	Wrestling	Middle weight A.
Tirkkonen, P. E.	»	»	Light weight.
Tison, A.	France	Athletics	Throwing the discus, b. h.; putting the weight, h. h.

Name	Nation	Branch of Athletics	Competition
Titt, W.	Great Britain	Gymnastics	Team competition II.
Tjäder, E.	Sweden	Swimming	Spring-board diving.
Toivonen, N. ...	Finland	Shooting	e. p. q.
Tom, L.	Belgium	Fencing	Team sabre.
Tomashevitch, D.	Servia	Athletics	Marathon race.
Tomaselli, A. ...	Italy	Gymnastics	Team competition II.
Tonini, A.	»	Athletics	High jump; broad jump.
Torell, E. K. ...	Sweden	Gymnastics	Team competition I.
Torén, C. A. O.	»	Horse Riding comp.	Prize jumping, ind.
Torkilsen, T. ...	Norway	Gymnastics	Team competition I.
Torres, M.	France	»	Ind. competition.
Torres, P. J. ...	Chili	Cycling	Cycling road race round Lake Mälär.
Torstensen, G. ...	Norway	Gymnastics	Team competition III.
Torstensen Jr., T.	»	»	»
Toth, P.	Hungary	Fencing	Foils, ind. sabre, team sabre.
Toth, S.	»	Football	
Totuschek, A. ...	Austria	Wrestling	Middle weight A.
Townsend, A. ...	Great Britain	Athletics	Marathon race.
Trampller, R. ...	Austria	Fencing	Foils, ind. épée, team sabre.
de Trannoy, G.	Belgium	Horse Riding comp.	Military, prize riding; prize jumping, team.
Treble, A. L. ...	Great Britain	Athletics	5,000 m. flat.
Trestler, J.	Austria	Wrestling	Middle weight B.
Triantaphillacos, D.	Greece	Athletics	100 m. flat.
Triantaphillacos, T.	»	Fencing	Ind. épée, team épée.
Tronner, H. ...	Austria	Athletics	Throwing the discus, b. h., r. & l. h.
Tsicitiras, C. ...	Greece	»	High jump; broad jump.
Tucek, J.	Bohemia	Fencing	Foils, ind. épée.
Tuiskunen, H. H.	Finland	Shooting	d. e. q.
Tuli, G.	Hungary	Gymnastics	Team competition II.
Tunesi, A.	Italy	»	Team competition II; ind. competition.
Tvedt, N.	Norway	Swimming	High (plain) diving.
Tvorsky, W. ...	Bohemia	Fencing	Foils, ind. épée, team épée.
Tonsager, E. ...	Norway	Rowing	Fours, outriggers.
Tonsager, H. ...	»	»	»
Tommarck, C. I.	Sweden	Shooting	k. m.
Törnqvist, K. ...	»	Football	
Törnros, G.	»	Athletics	Marathon race.
Uggla, B.	»	»	»
Ugi, C.	Germany	Football	Pole jump.
Uhle, H. K. ...	»	»	»
af Uhr, P.	Sweden	Athletics	High jump.
Ujlaky, R.	Hungary	»	Throwing the discus, b. h., r. & l. h.
Upmal, A.	Russia	»	Marathon race.
Urvikko, V.	Finland	Wrestling	Light weight.
Ussing, J. B. ...	Denmark	Modern Pentathlon	

Name	Nation	Branch of Athletics	Competition
Vadgaard, K. M.	Denmark	Gymnastics	Team competition I.
Vadon, G.	Hungary	Athletics	Hop, step and jump.
Valentin, G.	France	Cycling	Cycling road race round Lake Mälär.
Valle, M.	Italy	Football	
Vanlaere, G.	France	Swimming	Water Polo.
Varga, B.	Hungary	Wrestling	Middle weight B.
Varley, F. E.	Great Britain	Shooting	b. c.
Vasko, K.	Hungary	Rowing	Eights, outriggers.
Vauhkonen, V.	Finland	Shooting	d. e.
Vavra; Z.	Bohemia	Fencing	Foils, ind. épée, team épée.
Veirman, P.	Belgium	Rowing	Single Sculls.
Velez, R.	Hungary	Shooting	a. b. c. e.
Verderber, R.	Austria	Fencing	Foils, ind. épée, team sabre.
Vernon, K.	Great Britain	Rowing	Fours, outriggers.
Versis	Greece	Fencing	Team épée, ind. épée.
Vetter, M.	Germany	Rowing	Eights, outriggers.
Victal, J.	Portugal	Wrestling	Middle weight A.
Victor, J. A.	South Africa	Athletics	800 m. flat; 1,500 m. flat, 5,000 m. flat; 10,000 m. flat; team race
Vietz, G.	Germany	»	3,000 m.; cross-count- ry race.
Vighals, P.	Norway	Shooting	b.
Vigurs, C. A.	Great Britain	Gymnastics	Team competition II.
Villemoes, P.	Denmark	»	Team competition I.
Vinne, E.	Norway	Athletics	Hop, step and jump.
Visser, G.	Belgium	Rowing	Fours, outriggers.
Voelmeke, A.	U. S. A.	Athletics	Walking race.
Vokoun, L.	Bohemia	Cycling	Cycling road race round Lake Mälär.
Vos, J.	Holland	Football	
Voss, N.	Norway	Gymnastics	Team competition III.
Vygoda, B.	Bohemia	Athletics	100 m. flat.
Väänänen, T.	Finland	Shooting	p. q.
Wacha, A.	Austria	Cycling	Cycling road race round Lake Mälär.
Wachtmeister, S.	Sweden	Rowing	Eights, outriggers.
van Waes, E.	Belgium	»	Fours, outriggers.
Wagner, F.	Luxemburg	Gymnastics	Team competition II; team competition III.
Wagner, J.	Switzerland	Athletics	Pentathlon.
Wagner, J.	Austria	Swimming	Water Polo.
Wahl, H.	Finland	Yacht Racing	10-m. class.
Wahlstedt, A. J.	Sweden	Shooting	g. i.
Waitzer, J.	Germany	Athletics	Throwing the javelin, b. h.; Pentathlon.
de Waldaine, P.	Russia	Shooting	a. b. c. d. e.
Walden, H. A.	Great Britain	Football	
Waley, R. G. K.	Australasia	Rowing	Eights, outriggers.
Walker, J.	Great Britain	Cycling	Cycling road race round Lake Mälär.
Walker, J. D.	»	Rowing	Eights, outriggers.
Walker, M.	»	Cycling	Cycling road race round Lake Mälär.

Name	Nation	Branch of Athletics	Competition
Walker, S. J.	Great Britain	Gymnastics	Team competition II.
Wallach, G. S.	»	Athletics	10,000 m. flat; cross-country race.
Wallenberg, V.	Sweden	Shooting	n. o.
Wallenborg, C.	»	»	b. c.
Waller, E.	»	Yacht Racing	10-m. class.
Wallerius, E.	»	»	»
Wallerius, H.	»	»	»
Wallin, B.	»	Swimming	Water Polo.
Walsh, M.	Great Britain	Cycling	Cycling road race' round Lake Mälär.
Wandolleck, B.	Germany	Shooting	l.
Wannag, E.	Russia	Athletics	Throwing the discus, b.h.; putting the weight, b.h.
Ward, H. K.	Australasia	Rowing	Eights, outriggers.
Wardener, I.	Hungary	Athletics	High jump.
Warsow, G.	Germany	Cycling	Cycling road race round Lake Mälär.
Wasama, K. J.	Finland	Gymnastics	Team competition III.
Wastl, J.	Austria	Swimming	200 m. breast stroke; 400 m. breast stroke.
Watercampf, C.	Russia	Fencing	Ind. sabre.
Watson, G.	Canada	Cycling	Cycling road race round Lake Mälär.
Webb, E. J.	Great Britain	Athletics	Walking race.
Weber, A.	Germany	Football	
Weber, F.	Austria	»	
Webster, G. H.	Great Britain	Swimming	100 m. back stroke.
Wedholm, J. E.	Sweden	»	400 m. free style; 1,500 m. free style.
Wegele, K.	Germany	Football	
Wegener, A.	»	Rowing	Eights, outriggers.
Wehrer, A.	Luxemburg	Gymnastics	Team competition II; team competition III; ind. competition.
Weinacht, L.	Germany	Rowing	Eights, outriggers.
Weinzinger, F.	Austria	Athletics	100 m. flat; relay race 400 m.
Wells, H. B.	Great Britain	Rowing	Eights, outriggers.
Wells, J. A.	»	Athletics	200 m. flat; 400 m. flat.
Welz, E.	Germany	»	Throwing the discus, b. h.
Wendelin, S.	Hungary	Swimming	100 m. back stroke.
Wendell, J.	U. S. A.	Athletics	Hurdle race.
Wenk, J.	Hungary	Swimming	100 m. back stroke; water polo.
Wennergren, C.	Sweden	Lawn Tennis (covered & out-of-door courts)	Gentlemen's Singles; Gentlemen's Doubles.
Wennerholm, O.	»	Gymnastics	Team competition I.
Wens, G.	Belgium	Athletics	100 m. flat.
Wenseler, H.	Germany	»	200 m. flat; 400 m. flat.
Werkner, L.	Hungary	Fencing	Team sabre, ind. sabre.
Werner, A. F. A.	Germany	Football	
Werner, H.	Sweden	Fencing	Ind. sabre, team sabre.
Werner, H.	Germany	Gymnastics	Team competition II; team competition III.
Wersäll, C. A.	Sweden	»	Team competition I.

Name	Nation	Branch of Athletics	Competition
Wersäll, E. G...	Sweden	Modern Pentathlon	
Westberg, J. ...	»	Athletics	Marathon race.
Westerlund, E...	Finland	Wrestling	Middle weight A.
Westermark, H.	Sweden	Yacht Racing	8-m. class.
Westermark, N.	»	»	»
Westling, K. ...	Finland	»	»
Wetter, H. M...	Norway	Swimming	1,500 m. free style.
Wetterstrand, E.	Norway	Rowing	Fours, outriggers.
Weydahl, C. ...	Norway	Shooting	c.
de Weysse, D...	Russia	»	a. b. c. e.
Wetzell, O. W.	Finland	Swimming	High (plain) diving, plain and variety diving, spring-board diving.
Whelan, G.....	South Africa	Shooting	c. d. e.
Whitaker, G. ...	Great Britain	»	n. o.
Whitaker, J. ...	»	Gymnastics	Team competition II; ind. competition.
White, I. M. ...	»	Swimming	High (plain) diving, ladies.
Whitney, L. A.	U. S. A.	Athletics	Throwing the discus, b. h.; putting the weight, b. h., r. & l. h.
Wiberg, B. A. R.	Finland	Football	
Wickholm, W...	»	Athletics	Hurdle race; Decathlon.
Wicksell, R. ...	Sweden	Football	
Wickström, A. R.	Finland	»	
Wide, E.....	Sweden	Athletics	1,500 m. flat; team race 3,000 m.
Widerøe-Aas, M.	Norway	Football	
Wieslander, H.	Sweden	Athletics	Pentathlon; Decathlon.
Wiggins, A. F. R.	Great Britain	Rowing	Eights, outriggers.
Wijnveldt, D...	Holland	Football	
Wikke, F. B...	Denmark	Athletics	Pole jump.
Wiklund, O. ...	Finland	Wrestling	Middle weight B.
Wikoff, G. M...	U. S. A.	Athletics	5,000 m. flat.
Wikström, O. A.	Sweden	Shooting	e.
Wikström, V. V.	Finland	Wrestling	Feather weight.
Wilding, A. F...	Australasia	Lawn Tennis (covered courts)	Gentlemen's Singles.
Wilhelmsohn, L.	Russia	Athletics	800 m. flat.
Wiljamaa, K. A.	Finland	Wrestling	Heavy weight.
Wilkens, W. ...	Sweden	Rowing	Eights, outriggers; fours, inriggers.
Wilker, H.	Germany	»	Fours, outriggers.
Wilkinson, G...	Great Britain	Swimming	Water Polo.
Wilkman, O. ...	Russia	Modern Pentathlon	
Willems, G.....	Belgium	Rowing	Fours, outriggers.
Willems, V.....	»	Fencing	Foils, ind. épée, team épée.
Willführ, P.....	Germany	Athletics	Throwing the javelin, b. h.; throwing the discus, b. h.; putting the weight, b. h.
Wilson, C. P...	U. S. A.	»	100 m. flat; 200 m. flat; relay race 400 m.
Wilson, J.	Great Britain	Cycling	Cycling road race round Lake Mälär.

Name	Nation	Branch of Athletics	Competition
Wiman, D. L.	Sweden	Gymnastics	Team competition I.
Winans, W.	U. S. A.	Shooting	k. l. m. p. q. r.
Winslow, C. ...	South Africa	Lawn Tennis (out-of-door courts)	Gentlemen's Singles; Gentlemen's Doubles.
Winther, J. L. ...	Denmark	Gymnastics	Team competition I.
Wirtz, F.	Luxemburg	»	Team competition II; team competition III.
de Wischniakoff, G.	Russia	Shooting	b. c.
Withol, R.	»	Athletics	1,500 m. flat.
Wlassenko, W. ...	»	Football	
de Wolf, N. ...	Holland	»	
Wolfhagen, V. ...	Denmark	»	
Wollert, C. ...	Sweden	Shooting	n. o.
Woodward, V. J. ...	Great Britain	Football	
Woojeward, H. ...	Holland	Fencing	Ind. épée, team sabre.
Worm, E.	Germany	Gymnastics	Team competition II; team competition III.
Woronkoff, N. ...	Russia	Swimming	400 m. free style.
Worptzkij, W. ...	Germany	Football	
Worthington, H. T.	U. S. A.	Athletics	Broad jump.
de Woyloschni- koff, P.	Russia	Shooting	j. k. l. m.
Wright, E. G. D. ...	Great Britain	Football	
Wright, M. S. ...	U. S. A.	Athletics	Pole jump.
Wyolio, Y. W. ...	Finland	Gymnastics	Ind. competition.
Wyuts, J.	Belgium	Swimming	100 m. free style.
Wylie, W.	Australasia	»	100 m. free style, ladies.
Wähämäki, K. ...	Finland	Gymnastics	Team competition III.
Wäre, E. E. ...	»	Wrestling	Light weight.
Wäre, F. A. J. ...	»	Cycling	Cycling road race round Lake Mälär.
Yakowleff, M. W. ...	Russia	Football	
Yanez, E.	Chili	Horse Riding comp.	Prize jumping, ind.
Yates, W. G. ...	Great Britain	Athletics	Walking race.
Yorke, R. F. C. ...	»	»	800 m. flat; 1,500 m. flat.
Young, D. B. ...	U. S. A.	»	200 m. flat; 400 m. flat.
Yvon, G.	Great Britain	Swimming	High (plain) diving, plain and variety diving.
Zabeline, T. ...	Russia	Gymnastics	Ind. competition.
Zachar, E.	Hungary	Swimming	Water Polo; 800 m. team race.
Zacharoff, J. ...	Russia	Athletics	100 m. flat.
Zagorsky, S. ...	»	Horse Riding comp.	Prize jumping, ind.
Zahourek, B. ...	Austria	Swimming	100 m. free style, ladies; 400 m. team race, ladies.
Zampori, G. ...	Italy	Gymnastics	Team competition II; ind. competition.
Zander, J.	Sweden	Athletics	1,500 m. flat; team race 3,000 m.
Zannolini, U. ...	Italy	Gymnastics	Team competition II.
Zborzil, A.	Austria	Lawn Tennis (out-of-door courts)	Gentlemen's Singles; Gentlemen's Doubles.

Name	Nation	Branch of Athletics	Competition
von Zedlitz und Leipe	Germany	Shooting	n. o.
Zeilau, T. C.	Denmark	Modern Pentathlon	
Zeman, J.	Bohemia	Lawn Tennis (out-of-door courts)	Gentlemen's Singles; Gentlemen's Doubles.
Zemla, L.	»	Lawn Tennis (out-of-door courts)	Gentlemen's Singles; Gentlemen's Doubles.
Zerling, P.	Sweden	Athletics	400 m. flat, relay race 1,600 m.
Ziegler, H.	Germany	Fencing	Foils, ind. épée, team épée.
Zilker, J.	Austria	Cycling	Cycling road race round Lake Mälär.
Zimmerman, R. M.	Canada	Swimming	Spring-board diving.
Zouang, J.	Luxemburg	Gymnastics	Team competition II; team competition III.
Zorzi, A.	Italy	»	Team competition II.
Zsigmondy, E.	Hungary	Lawn Tennis (out-of-door courts)	Gentlemen's Singles; Gentlemen's Doubles.
Zuffi, E.	Italy	Football	
Zulawsky, B.	Hungary	Fencing	Foils, ind. sabre.
Zürner, A.	Germany	Swimming	High (plain) diving, plain and variety diving, spring-board diving.
Åberg, A.	Sweden	Athletics	Throwing the hammer.
Åberg, G.	»	»	Broad jump, hop, step and jump.
Åberg, K. K.	Finland	Wrestling	Middle weight A.
Åbrink, R.	Sweden	Athletics	Throwing the javelin, b. h., r. & l. h.
Åkesson, B. V.	»	Wrestling	Feather weight.
Åsbrink, K. G.	»	Modern Pentathlon	
Öberg, A.	»	Athletics	10,000 m. flat.
Öberg, E.	»	Wrestling	Feather weight.
Öhman, J.	Finland	Football	
Örtegren, R.	Sweden	Shooting	b. f. g.
Östenson, Ö.	Norway	»	d. e.
Östrup, L. C.	Denmark	Fencing	Foils, ind. épée, team épée, team sabre.

**LIST OF THE LEADING ATHLETIC AND OTHER
SPORTING ORGANIZATIONS REPRESENTED
AT THE GAMES OF STOCKHOLM.**

Name	Address	Nation
ATHLETICS.		
The Amateur Athletic Union of Australasia.	N. S. Wales Sports Club Ltd, 10/14, Hunter Street, Sydney.	Australasia.
New South Wales Amateur Athletic Association.	Box 579 G. P. O., Sydney,	»
Victorian Amateur Athletic Association.	Amateur Sports Club, Collins Street, Melbourne, Vic.	»
New Zealand Amateur Athletic Association.	Christchurch, New Zealand.	»
Tasmanian Amateur Athletic Association.	A. M. P. Society, Hobart, Tasmania.	»
Österreichischer Leichtathletik Verband.	32, Hardtgasse, Vienna XIX.	Austria.
Ligue Belge d'Athlétisme.	30, Rue Lesbroussart, Brussels.	Belgium.
Ceská Athletická Amatérská Unie.	8, Panska Ulice, Prague II.	Bohemia.
Amateur Athletic Union of Canada.	22 College Street, Toronto, Ontario.	Canada.
Federation Sportiva Nacional Chile.	7, Amunatégui, Santiago.	Chili.
Dansk Athletik-Forbund.	9, C. F. Gardes Allé, Hellerup.	Denmark.
Finlands Gymnastik- och Idrottsförbund.	2, Köpmangatan, Helsingfors.	Finland.
Union des Sociétés Françaises de Sports Athlétiques.	34, Rue de Provence, Paris.	France.
Deutsche Sportbehörde für Athletik.	3, I, Ziegelstrasse, Berlin N 24	Germany.
Amateur Athletic Association.	10, John Street. Adelphi, London W. C.	Great Britain.
Union de Sociétés Helleniques d'Athlétisme et de Gymnastique.	13, Rue de l'Université. Athens.	Greece.
Nederlandsche Athletiek Unie.	45 d, Kalfjeslaan, Amsterdam.	Holland.
Magyar Athletikai Szövetség.	Centralstadthaus, Buda-Pesth.	Hungary.
Federazione Italiana Degli Sports Athletica.	Rome.	Italy.
Fédération des Sociétés Luxembourgeoises de Sports Athlétiques.	Luxemburg.	Luxemburg.
Norges Turn- og Idrætsforbund.	26 S:t Olavsgate, Christiania.	Norway.
Sporting Club Portugal.	15 Alameda do Lumiar, Lisbon.	Portugal.
Russischer Landesverband für leicht-Athletik.	21, Alexandroffsky Prosp., St Petersburg.	Russia.
Serbischer Leichtathletischer Verband.	29, Rue Svetogorska, Belgrade.	Servia.

Name	Address	Nation
South African Amateur Athletic and Cycling Association.	P. O. Box 421 , <i>Johannesburg.</i>	South Africa.
Svenska Idrottsförbundet.	18 , Drottninggatan, <i>Gothenburg.</i>	Sweden.
Amateur Athletic Union of the United States.	21 , Warren Street, <i>New York.</i>	U. S. A.
CYCLING.		
Österreichischer Radsport-Ausschuss.	33 Rennweg, <i>Vienna III.</i>	Austria.
Comité Sportif de la Ligue Vélocipédique Belge.	187 , Avenue du Sud, <i>Antwerp.</i>	Belgium.
Ceská Ustredni Jednota Velocipedistu.	Smichov, <i>Prague.</i>	Bohemia.
Canadian Wheelmen's Association.	80 , Rusholme Road, <i>Toronto, Ontario.</i>	Canada.
Dansk Cycle Union for Landevejs-sport.	115 , Jagtvejen, <i>Copenhagen.</i>	Denmark.
Union Vélocipédique de France.	24 , Boulevard Poissonnière, <i>Paris.</i>	France.
Deutscher Radfahrer Bund.	14 Nürnbergerstrasse, <i>Berlin.</i>	Germany.
National Cyclists Union.	Lonsdale Chambers, 27 Chan- cery Lane, <i>London E. C.</i>	Great Britain.
Magyar Kerékpáros Szövetség.	13/b. sz. Lónyay-u. <i>Buda-Pesth IX.</i>	Hungary.
Norges Cykleforbund.	Nitedal pr. <i>Christiania.</i>	Norway.
Union Vélocipédique Russe.	36 Sadowaia, <i>S:t Petersburg.</i>	Russia.
South African Amateur Athletic and Cycling Association.	P. O. Box 421 , <i>Johannesburg.</i>	South Africa.
Svenska Velocipedförbundet.	<i>Stockholm.</i>	Sweden.
National Cycling Union.	31 West 42nd Street, <i>New York.</i>	U. S. A.
FENCING.		
Österreichischer Fechterbund.	3 , Hintere Zollamtstrasse, <i>Vienna III.</i>	Austria.
Fédération des Cercles d'Escrime de Belgique.	47 , Rue Neuve S:t Pierre, <i>Ghent.</i>	Belgium.
Cesky Sermirsky Comitét.	<i>Prague.</i>	Bohemia.
Dansk Fægte Forbund.	5 , Herluf Trollesgade, <i>Copenhagen.</i>	Denmark.
Deutscher Fechterbund.	<i>Offenbach a/M.</i>	Germany.
Amateur Fencing Association.	21 , Old Square, Lincoln's Inn, <i>London W. C.</i>	Great Britain.
Nederlandsche Amateur Scherm- bond.	4 , Jansdam, <i>Utrecht.</i>	Holland.
Federazione Italiana di Scherma.	106 , Via Marsala, <i>Rome.</i>	Italy.
Norges Fegteforbund.	Stendal pr. <i>Christiania.</i>	Norway.

Name	Address	Nation
Centro Nacional de Esgrima.	Salao de S. Carlos, Largo do Picadeiro, <i>Lisbon</i> .	Portugal.
South African Fencing Association.	Govt. Laboratories, <i>Johannesburg</i> .	South Africa.
Svenska Fäktförbundet.	<i>Stockholm</i> .	Sweden.
Amateur Fencers' League of America.	53, Broadway, <i>New York</i> .	U. S. A.
FOOTBALL.		
Österreichischer Fussball Verband.	22, Franzensbrückenstr., <i>Vienna</i> .	Austria.
Dansk Boldspil Union.	4, Reventlowsgade, <i>Copenhagen</i> .	Denmark.
Finska Bollförbundet.	48, Kaserngatan, <i>Helsingfors</i> .	Finland.
Deutscher Fussball Bund.	75, Neuer Graben, <i>Dortmund</i> .	Germany.
Football Association.	42, Russel Square, <i>London W. C.</i>	Great Britain.
Nederlandsche Voetbal Bond.	29, van Boetzelaerlaan, <i>The Hague</i> .	Holland.
Magyar Labdarugók Szövetség.	9, Akademia utca, <i>Buda-Pesth</i> .	Hungary.
Federazione Italiano Giuoco del Calcio.	83, Corso Principe Oddone, <i>Turin</i> .	Italy.
Norges Fotballforbund.	Sofienlund, Sköien, pr <i>Christiania</i> .	Norway.
Union Russe de Football Association.	21, Alexandroffsky Prosp., <i>S:t Petersburg</i> .	Russia.
Svenska Fotbollförbundet.	<i>Stockholm</i> .	Sweden.
GYMNASTICS.		
Dansk Gymnastik Forbund.	62, Österbrogade, <i>Copenhagen</i> .	Denmark.
Finlands Gymnastik- och Idrottsförbund.	2, Köpmangatan, <i>Helsingfors</i> .	Finland.
Union des Sociétés de Gymnastique de France.	8, Rue Reigner, <i>Bordeaux</i> .	France.
Amateur Gymnastic Association.	»Hopeville», Lebanon Road, E. <i>Croydon</i> .	Great Britain.
Magyarországi Tesdező Egyesületek Szövétége.	Albrecht ut., <i>Buda-Pesth</i> .	Hungary.
Federazione Ginnastica Nazionale Italiana.	87, Via delle Muratte, <i>Rome</i> .	Italy.
Union des Sociétés Luxembourgeoises de Gymnastique.	<i>Roodt</i> .	Luxemburg.
Norges Turn- og Idrætsforbund.	26, S:t Olavsgate, <i>Christiania</i> .	Norway.

Name	Address	Nation
Union des Sociétés de Gymnastique.	31, Newski, <i>S:t Petersburg.</i>	Russia.
Svenska Gymnastikförbundet.	<i>Stockholm.</i>	Sweden.
LAWN TENNIS.		
Lawn Tennis Association of Australasia.	<i>Sydney, N. S. W.</i>	Australasia.
Österreichischer Lawn Tennis Verband.	1, Prinzen Allee, <i>Vienna 11/2</i>	Austria.
Ceská Lawn Tennisová Asociace.	63, Václavské, <i>Prague.</i>	Bohemia.
Dansk Boldspil Union.	4, Reventlowsgade, <i>Copenhagen.</i>	Denmark.
Deutscher Lawn Tennis Bund.	51, Kaiserdamm, <i>Berlin.</i>	Germany.
Lawn Tennis Association.	49 Queen Victoria Street, <i>London E. C.</i>	Great Britain.
Nederlandsche Lawn Tennis Bond.	3, Mauritskade, <i>The Hague.</i>	Holland.
Magyar Országos Lawn Tennis Szövetség.	Margitszigeti-Sporttelep, <i>Buda-Pesth III.</i>	Hungary.
Norges Lawn Tennisforbund.	63, Oscarsgate, <i>Christiania.</i>	Norway.
Union Russe de Lawn Tennis.	1, Alexander Prosp., <i>S:t Petersburg.</i>	Russia.
South African Lawn Tennis Union.	P. O. Box 1,660, <i>Johannesburg.</i>	South Africa.
Svenska Lawn Tennisförbundet.	<i>Stockholm.</i>	Sweden.
United States National Lawn Tennis Association.	<i>New York, N. Y.</i>	U. S. A.
ROWING.		
New South Wales Rowing Association.	Sports Club, Hunter Street, <i>Sydney.</i>	Australasia.
Victorian Rowing Association.	<i>Melbourne, Victoria.</i>	»
Österreichischer Ruderverband.	3, Annagasse, <i>Vienna I.</i>	Austria.
Fédération Belge des Sociétés d'Aviron.	14, Rue du Magistrat, <i>Brussels.</i>	Belgium.
Cesky Veslarsky Svaz.	c/o Zelenka & Zimmer, Hubernská ul., <i>Prague.</i>	Bohemia.
Canadian Association of Amateur Oarsmen.	33, Melinda Street, <i>Toronto, Ontario.</i>	Canada.
Dansk Forening for Rosport.	2, Christian den IX Gade, <i>Copenhagen.</i>	Denmark.
Finska Roddförbundet.	4, Kyrkogatan, <i>Helsingfors.</i>	Finland.
Fédération Française des Sociétés d'Aviron.	43, Boulevard Lannes, <i>Paris.</i>	France.
Deutscher Ruder Verband.	14, Dovenhof, <i>Hamburg.</i>	Germany.
Amateur Rowing Association.	3, Whitehall Court, <i>London S. W.</i>	Great Britain.

Name	Address	Nation
Magyar Evezős-egyletek Országos Szövetsége.	Margitszigeti-Sporttelep, <i>Buda-Pesth</i> III.	Hungary.
Norges Roforbund.	c/o Consul Wettre, <i>Christiania</i> .	Norway.
Fédération Russe des Sociétés d'Aviron.	1, Alexander Prosp., <i>S:t Petersburg</i> .	Russia.
Svenska Roddförbundet.	<i>Malmö</i> .	Sweden.
SHOOTING.		
Österreichischer Schützenbund.	11, Hörlgasse, <i>Vienna</i> IX.	Austria.
Dominion of Canada Trap Shooting Association.	<i>Ottawa</i> , Ontario.	Canada.
Danske Skytters Private Forening	13, Jesper Brockmandsgade, <i>Copenhagen</i> .	Denmark.
Finska Jaktföreningen.	3, Gengatan, <i>Helsingfors</i> .	Finland.
Union des Sociétés de Tir de France.	46, Rue de Provence, <i>Paris</i> .	France.
Saint Hubert Club de France.	21, Rue de Clichy, <i>Paris</i> .	»
National Rifle Association.	Bisley Camp, <i>Brookwood</i> , Surrey.	Great Britain.
Clay Bird Shooting Association.	68, Aldersgate St., <i>London</i> E. C.	»
Koninklijke Nederlandsche Jachtvereniging Nimrod.	<i>Haarlem</i> .	Holland.
Det Frivillige Skyttevæsen.	9, Storgate, <i>Christiania</i> .	Norway.
Transvaal Rifle Association.	Drill Hall, <i>Johannesburg</i> .	South Africa.
Natal Rifle Association.	<i>Durban</i> , Natal.	» »
Skytteförbundens Öfverstyrelse.	17, Hamngatan, <i>Stockholm</i> .	Sweden.
Svenska Jägarförbundet.	<i>Stockholm</i> .	»
National Rifle Association of America.	1025, Woodward Building, <i>Washington</i> .	U. S. A.
United States Revolver Association.	c/o Dr. Reginald H. Sayre, <i>New York</i> .	»
SWIMMING.		
New South Wales Amateur Swimming Association.	<i>Sydney</i> , N. S. W.	Australasia.
New Zealand Amateur Swimming Association.	P. O. Box 391, <i>Christchurch</i> , New Zealand.	»
Verband der Österreichischen Schwimmvereine.	23, Himmelpfortgasse, <i>Vienna</i> I.	Austria.
Fédération Belge des Sociétés de Natation.	569, Chaussée de Ninove, <i>Brussels</i> .	Belgium.
Canadian Amateur Swimming Association.	c/o A. Murray Hannah, <i>Montreal</i> , P. Q.	Canada.
Dansk Svømme- & Livredningsforbund.	90, Vester Voldgade, <i>Copenhagen</i> .	Denmark.
Finska Simförbundet.	5, Lilla Robertsgatan, <i>Helsingfors</i> .	Finland.

Name	Address	Nation
Union des Sociétés Françaises de Sports Athlétiques.	34 , Rue de Provence, <i>Paris</i> .	France.
Deutscher Schwimmverband.	49 , Mühlenstrasse, <i>Berlin</i> .	Germany.
Amateur Swimming Association.	24 , Cautley Avenue, Clapham Common, <i>London S. W.</i>	Great Britain.
Magyar Uszó Szövetség.	Központi Muegyetem, <i>Buda-Pesth I.</i>	Hungary.
Federazione Italiana di Nuoto.	64 , Via Vittorio Emanuele, <i>Florence</i> .	Italy.
Norges Svømmerforbund.	<i>Bergen</i> .	Norway.
South African Swimming Union.	P. O. Box 720 , <i>Durban, Natal</i> .	South Africa.
Svenska Simförbundet.	<i>Stockholm</i> .	Sweden.
Amateur Athletic Union.	21 , Warren Street, <i>New York</i> .	U. S. A.
WRESTLING.		
Österreichischer Athleten-Union.	11 , Auerspergstrasse, <i>Vienna VIII</i> .	Austria.
Česky Ustřední Svaz Tezkoathletický.	<i>Prague</i> .	Bohemia.
Dansk Athlet Union.	19 , Rørholmegade, <i>Copenhagen</i> .	Denmark.
Finlands Gymnastik- och Idrottsförbund.	2 , Köpmangatan, <i>Helsingfors</i> .	Finland.
Fédération Française de Boxe et de Lutte.	24 , Boulevard Poissonnière, <i>Paris</i> .	France.
Deutscher Reichsverband für Schwerathletik.	14 , Rotebühl, <i>Stuttgart</i> .	Germany.
National Amateur Wrestling Association.	49 , Oakley Road, Southgate Road, <i>London N.</i>	Great Britain.
Nederlandsche Krachtsport Bond.	42 , 2 E Atjehstraat, <i>Amsterdam</i> .	Holland.
Magyar Athletikai Szövetség.	Centralstadthaus, <i>Buda-Pesth</i> .	Hungary.
Federazione Atletica Italiana.	<i>Rome</i> .	Italy.
Norges Turn- og Idrætsforbund.	26 , St. Olavsgate, <i>Christiania</i> .	Norway.
Svenska Atletikförbundet.	<i>Malmö</i> .	Sweden.
Amateur Athletic Union.	21 , Warren Street, <i>New York</i> .	U. S. A.

**LIST OF THE FOREIGN OFFICIAL REPRESENTATIVES
AND FUNCTIONARIES AT THE OLYMPIC
GAMES OF STOCKHOLM.**

AUSTRALASIA.

Alexander, W. B.	Leader of Athletic Team.
Cunningham, C. S.	Leader of Rowing Team.
Deloitte, Q. L.	Member of International Jury for Rowing.
Helsham, C. H.	Leader of Rowing Team.
Hill, A. C. W.	Secretary of Australasian Olympic Committee. Leader of Swimming Team.
Horniman, V.	President of Australasian Olympic Delegation. Manager of Australasian Teams.
Marks, E. S.	Member of International Jury for Swimming.
Middleton, W. J.	Leader of Rowing Team.
Thomson, A.	Leader of Rowing Team.
Verge, C. A.	Medical Attendant.
Watson, Alex.	Leader of Swimming Team.

AUSTRIA.

Abeles, Ignaz, D:r.	Leader of Football Team.
Bauer, Henry	Leader of the Athletic and Wrestling Teams.
Count von Colloredo- Mannsfeld, R.	Member of International Olympic Com.
Deutsch, Robert	Leader of Athletic Team.
Elbogen, H.	Leader of Shooting Team.
Graf, Felix	Member of International Jury for Swimming. Leader of Swimming Team.
Hecht, Hugo, M. D.	Medical Attendant.
Herschmann, Otto, D:r. ...	President of Austrian Olympic Com. Member of International Juries for Wrestling, Fencing and Modern Pentathlon. Manager of Austrian Teams.
Kestler, Karl	Leader of Football Team.
Markones, F. X.	Judge in Wrestling Competitions. Leader of Wrestling Team.
D:r Mayer	Leader of Swimming Team.
Meisl, Hugo	Leader of Football Team.
Pfeiffer, Hans	Leader of Athletic Team.
Schönecker, E.	Leader of Athletic Team.

Major H. Tenner	Leader of Fencing Team. Judge in Fencing Competitions.
Wels, C. A.	Vice-President of Austrian Olympic Com. Manager of the Austrian Teams.
Prince Otto zu Windisch- Graetz	Member of International Olympic Com.
Wraschtil, Herman	Leader of Athletic Team.
Ziehrer, Wilh.....	Leader of Wrestling Team.
Baron M. Zois	Leader of Cycling Team.

BELGIUM.

Annoot, L.	Member of the Honorary Presidentship for Rowing Team.
Anspach, P.....	Leader of Fencing Team.
Count E. d'Assche	Representative for Lawn Tennis.
Count Henry de Baillet- Latour	Member of International Olympic Com.
Berré, M.....	Judge in Fencing Competitions.
Captain de Blommaert ...	Leader of Horse Riding Team.
Cnoops, C.	Leader of Fencing Team. Judge in Fencing Competitions.
Cohen, H.	Leader of Swimming Team.
Dupuich, A.	Member of Belgian Olympic Com.
Feyerick, A.	Member of Belgian Olympic Com. Judge in Fencing Competitions.
Grégoire, O.	Member of Belgian Olympic Com.
Van der Heyden, F.	Member of Belgian Olympic Com. Member of Intern. Jury for Swimming.
Major Joostens	Member of Intern. Jury for Horse Riding Competitions.
Major O. Lefebure	Vice-President of Belgian Olympic Com. Judge in Gymnastic Competitions.
Baron de Laveleye	President of Belgian Olympic Com. Member of Intern. Jury for Football.
Dr A. de Marneffe	Leader of Rowing Team.
Count J. d'Oultrement ...	Leader of Athletic Team.
Sarens, A.	Leader of Fencing Team. Judge in Fencing Competitions.

BOHEMIA.

Balcar, Em.....	Vice-President of Bohemian Olympic Com.
Dr J. Broft.....	Functionary of Bohemian Olympic Com.
Fehrer, Fr.	Leader of Cycling Team.
de Fuchs, Karel.....	Functionary of Bohemian Olympic Com.
Professor Jiri Guth.....	President of Bohemian Olympic Com. Member of International Olympic Com.
Herman, Gustav	Leader of Rowing Team.

Just, Jar., Ph. D:r	Leader of Lawn Tennis Team.
Kalva, Jar.	Press Representative of Bohemian Olympic Com.
Professor G. Karasek.....	Functionary of -Bohemian Olympic Com.
D:r P. Kostar	Judge in Fencing Competitions.
de Lobsdorf, Vilém G. ...	Leader of Fencing Team.
Matucka, I.	Functionary of Bohemian Olympic Com.
Pavlousek, V.	Archivist of Bohemian Olympic Com.
Pfeiffer, J.	Judge in Fencing Competitions.
Richter, R.	Leader of Athletic and Cycling Teams.
Roessler-Orovsky, J.	General Secretary of Bohemian Olympic Com.
	Member. of Intern. Jury for Modern Pentathlon.
	Judge in Gymnastic Competitions.
	Chief Manager of Bohemian Teams.
Rudl, Václav	Vice-President of. Bohemian Olympic Com.
	Member of Intern. Jury for Wrestling.
Schejbal, J.	Asst. Treasurer, Bohemian Olympic Com.
Schindler, R.	Judge in Wrestling Competitions.
	Leader of Wrestling Team.
Sebek, J. Muc.	Leader of Lawn Tennis Team.
Sourek, L. ...	Judge in Fencing Competitions.
Zelenka, Jos.	Treasurer, Bohemian Olympic Com.

CANADA.

Crow, Norton, H.	Secretary, Canadian Olympic Com.
	Manager of Canadian Teams.
Brigadier-General, Sir John Hanbury-Williams	Member of Intern. Olympic Com.
Merrik, James G., B. A....	President of Canadian Olympic Com.
	Member of Intern. Jury for Athletics.
Wright, Josef ..	Member of Intern. Jury for Rowing.

CHILI.

Kähni, Don Maximo	Manager of Chilian Teams.
Maia, Don Jorje	Member of Chilian Olympic Com.
Lieut.-Col. Don Alfredo Schönmeyr	Official Representative of Chilian Government.
	President of Chilian Delegation at the Games.
Subercasseaux y Browne, Don Fernando	Member of Chilian Olympic Com.

DENMARK.

Albany, William.	Rowing Team Functionary.
Arboe, O.	Rowing Team Functionary.
Miss Signe Bentsen	Functionary of Gymnastic Display Team.
Captain H. Bondo	Member of Intern. Jury for Wrestling and Modern Pentathlon.
Brydegaard, Johan	Functionary of Gymnastic Display Team.

Bukh, Niels E.	Team functionary for Gymnastics.
Clod-Hansen, Abr.	Judge in Gymnastic and Fencing Competitions.
Mrs Emborg	Functionary of Gymnastic Display Team.
Captain Torben Grut	Member of Intern. Olympic Com.
Hansen, A.	Functionary of Gymnastic Display Team.
Lieut-Col. Fritz Hansen...	President of Danish Olympic Com.
Lieut. Arne Højme	Leader of Athletic Team.
Illeris, Nils	Functionary of Gymnastic Display Team.
Jensen, Oluf	Leader of Rowing Team.
Knudsen, K. A.	Leader of Gymnastic Team.
Knudsen, K. P.	Functionary of Gymnastic Display Team.
Kristensen, Vilhelm	Functionary of Gymnastic Display Team.
Köster, H. S.	Member of Intern. Jury for Rowing.
Larsen, Johs	Team functionary for Athletics.
Levison, Ejnar	Leader of Fencing Team.
D:r L. J. Madsen	Leader of Shooting Team.
Madsen, Povl	Functionary of Gymnastic Display Team.
Lieut.-Col. O. A. H.	
Moltke	Member of Intern. Jury of Horse Riding Competitions.
Mouritzen	Team functionary for Football and Lawn Tennis.
Captain T. F. H. Møl- gaard	Team functionary for Gymnastics.
Möller, Carl	Team functionary for Cycling.
Möller, H. C. V.	Leader of Gymnastic Team.
	Member of Intern. Jury for Gymnastics.
Nathansen, J. L.	Vice-President of Danish Olympic Com.
Nielsen, A. R.	Judge in Wrestling Competitions.
Lieut. I. Nyholm	Secretary of Danish Olympic Com.
Olesen, K.	Functionary of Gymnastic Display Team.
Miss Kamilla Poulsen ...	Functionary of Gymnastic Display Team.
Miss Praestgaard,.....	Functionary of Gymnastic Display Team
Rasmussen, Moritz	Team functionary for Athletics.
Rasmussen, N. H., B. A. ...	Judge in Gymnastic Competitions.
D:r E. A. J. Saugmann,...	Team functionary for Rowing.
V. V. J. Schiermer,.....	Team functionary for Gymnastics.
Schmidt, Eugen	Team functionary for Rowing.
Steenberg	Team functionary for Football and Lawn Tennis.
Sylow, L.	Leader of Football and Lawn Tennis Teams.
Teilman, Kåre	Functionary of Gymnastic Display Team.
Toepfer, Georg	Leader of Cycling Team.
Vind, Rasmus	Functionary of Gymnastic Display Team.
Vogel-Jørgensen	Team functionary for Football and Tennis.
Östrup	Team functionary for Football and Tennis.

EGYPT.

Bolanachi A. Ch.	Member of Intern. Olympic Com.
-----------------------	--------------------------------

FINLAND.

Aro Toivo	Leader of Swimming Team.
Björk, Werner.....	Masseur attending Cycling Team.
Miss Elli Björksten	Leader of Women's Gymnastic Team.
Blomqvist, Johan.....	Chief Masseur.
Johansson, E.	Leader of Wrestling Team.
Koivistoinen, Janne.....	Masseur attending Athletic Team.
Koivistoinen, Yrjö	Masseur attending Athletic Team.
Liljander, Aame	Masseur attending Wrestling Team.
Liljefors, Axel.....	Leader of Wrestling Team.
Lindberg Carl.....	Leader of Cycling Team.
Lindstedt, Johan	Judge in Wrestling Competition.
	Leader of Wrestling Team.
Londen, Axel	Member of Finnish Olympic Com.
	Leader of Shooting Team.
Nylund, Emil	Leader of Rowing Team.
Pihkala, Lauri, B. A.....	Leader of Athletic Team.
Schroeder, I. E.	Leader of Gymnastic Team.
Sivén, Elis	Leader of Athletic Team.
Soinio, Kaarlo.....	Leader of Football Team.
Stenberg, Ragnar, M. B....	Leader of Athletic Team.
Vartia Arvo, Ph. Mag. ...	Leader of Gymnastic Team.
Wasenius, Gösta.....	Member of Finnish Olympic Com.
	Manager of Finnish Teams.
Westerholm, Uno	Member of Finnish Olympic Com.
	Member of Intern. Jury for Swimming.
Baron R. F. von Wille- brand	President of Finnish Olympic Com.
	Member of Intern. Olympic Com.
Wilskman, Ivar	Vice-President of Finnish Olympic Com.
	Member of Intern. Jury for Athletics.
	Manager of Finnish Teams.

FRANCE.

Count d'Arnaud	Member of French Olympic Com.
	Leader of Cycling Team.
Ballif, Abel.....	Member of Intern. Olympic Com.
Count A. de Bertier de Sauvigny	Member of Intern. Olympic Com.
Brennus	Leader of Athletic Team.
Breton, Léon	Leader of Cycling Team.
Lieut. Brulé.....	Member of French Olympic Com.
	Delegate of French Olympic Com. at the Games.
Callot, E... ..	Member of Intern. Olympic Com.
Canet, Albert	Leader of Lawn Tennis Team.
Baron de Castex.....	Leader of Clay Bird Shooting Team.
Castiglioni	Leader of Gymnastic Team.

Cazalet	Member of French Olympic Com. Leader of Gymnastic Team.
Champ, Paul	Treasurer, French Olympic Com. Delegate of French Olympic Com. at the Games.
Marquis de Chasseloup- Laubat	Member of French Olympic Com. Judge in Fencing Competitions.
Captain Chodron de Courcel	Judge in Horse Riding Competitions.
Christmann, Paul	Member of French Olympic Com. Delegate of French Olympic Com. at the Games.
Conord	Leader of Swimming Team.
Baron P. De Coubertin ...	President of French Olympic Com.
Marquis de Créqui Monfort	Member of French Olympic Com. Leader of Pistol Shooting Team.
Commander Destremau ...	Member of Intern. Jury for Horse Riding Competitions.
Dezaux, Maurice	Leader of Athletic Team.
Dorn	Member of French Olympic Com. Leader of Rowing Team.
Enderlin, René	Member of Intern. Jury for Athletics. Leader of Athletic Team.
Evelyn, Harold	Masseur.
Faure, Maurice	Member of French Olympic Com. Member of Intern. Jury for Shooting. Leader of Shooting Team.
Germot M.	Leader of Lawn Tennis Team.
Glandaz	Member of French Olympic Com. Member of Intern. Jury for Rowing. Leader of Rowing Team.
Glamer, André	Chief leader of Athletic Team.
Isambert, Charles	Secretary of French Olympic Com.
D:r Lachaud	Member of Intern. Jury for Gymnastics.
Meiers	Assist. Sec., French Olympic Com.
Mérillon	Member of French Olympic Com.
Mirambeau	Leader of Rowing Team.
Noquet.....	Assist. Sec., French Olympic Com.
Regnier	Leader of Wrestling Team.
Rousseau, Paul	Member of French Olympic Com.
Rousselot	Leader of Cycling Team.
Roy, Pierre.....	Vice-President, French Olympic Com. Delegate-General of French Olympic Com. at the Games.
Captain F. Séé	Judge in Fencing Competitions.
Sevin	Member of French Olympic Com. Leader of Rowing Team.

GERMANY.

Major-General von Alten...	Honorary Member of Committee for Horse Riding Competitions.
Auerbach, F. W. K. Chief	
Dir. of Gymnast	Member of Deputation from Leipzig.
Bachmann	Team functionary for Athletics.
Berner, M.	Team functionary for Athletics.
Blome, C.	Team functionary for Football.
Blume, M.	Member of German Olympic Com. Leader of Swimming Team.
Boeckling, Th.	Member of German Olympic Com. Representative for Cycling.
Brandt, M.	Team functionary for Football.
Brustman, M.	Medical Attendant.
Büxenstein, Geh. Kom.	
Rat	Representative for Rowing.
Diem, Carl	Member of German Olympic Com. Member of Intern. Jury for Athletics. Leader of Athletic Team.
Drömer, F.	Member of German Olympic Com. Leader of Swimming Team.
Erckrath de Bary	Member of German Olympic Com. Judge in Fencing Competitions. Leader of Fencing Team.
Forster, P.	Member of German Olympic Com. Leader of Cycling Team.
Major von Giese.....	Member of Intern. Jury for Horse Riding Competitions.
Professor W. Goetze	Representative of Ducal Government of Brunswick.
Professor Heffner	Representative for Football.
D:r Hoffman	Leader of Football Team.
Baron J. von Hünefeld ...	Treasurer, German Olympic Com.
Captain H. Jüst... ..	Member of German Olympic Com. Member of Intern. Jury for Fencing.
D:r Kappe	Team functionary for Athletics.
Kiessling, E.	Member of German Olympic Com. Member of Intern. Jury for Wrestling.
D:r Kuhr.....	Leader of Athletic Team.
D:r Mallwitz	Member of German Olympic Com. Medical Attendant.
Markus, K.	Team functionary for Athletics.
D:r Paul Martin	Chief Secretary, German Olympic Com.
Mayer, H.	Judge in Fencing Competitions.
Mess, G.	Judge in Fencing Competitions.
Meyerhof, J. W.....	Team functionary for Athletics.
D:r Paul Meynen	Member of Delegation from Leipzig.
Müller, B.	Team functionary for Athletics.

Müller, Joh. J. P.	Asst. Secretary, German Olympic Com.
Natusch, B.	Judge in Fencing Competitions.
Obst, G.	Member of German Olympic Com. Representative for Football.
Ober-Regierungsrat, U. von Oertzen	Vice-President of German Olympic Com.
Petri, A.	Judge in Fencing Competitions.
States-Minister, V. von Podbielski	President of German Olympic Com.
Preuss, A.	Member of German Olympic Com. Leader of Shooting Team.
Preuss, R.	Member of German Olympic Com. Judge in Wrestling Competitions. Leader of Wrestling Team.
Rahn, A.	Team functionary for Athletics.
Colonel, Count von Roth- kirch und Trach,	Leader of Horse Riding Team.
Runge, J.	Leader of Athletic Team.
D:r O. Ruperti	Member of German Olympic Com. Member of Intern. Jury for Rowing. Leader of Rowing Team.
Sans, W.	Team functionary for Football.
D:r W. Schomburgk	Leader of Lawn Tennis Team.
Lieut. Col. Seiffert,	Judge in Horse Riding Competitions.
Count A. F. Sierstorpff, ..	Member of Intern. Olympic Com.
Streigler, B.	Member of Delegation from Leipzig.
Baron von Venningen . . .	Member of Intern. Olympic Com.
Wagener, E.	Leader of Athletic Team.
Count C. von Wartens- leben	Member of Intern. Olympic Com. Member of Intern. Jury for Swimming.
Witt, A.	Leader of Swimming Team.
Witzgall, E. R., Chief Dir. of Gymn,	Member of Deputation from Leipzig.

GREAT BRITAIN.

D:r A. Abrahams	Team functionary for Athletics.
Barker, H. R.	Leader of Rowing Team.
Baxter, F.	Leader of Swimming Team. Member of Intern. Jury for Swimming.
Birch, A.	Football Trainer.
Blair, J.	Member of British Olympic Council. Leader of Cycling Team.
Brickett, W.	Swimming Trainer.
Brommage, W. A.	Member of Intern. Jury for Athletics.
Brown, J. T.	Team functionary for Athletics. Leader of Swimming Team.

Cook, Theodore A.	Member of British Olympic Council. Member of Intern. Olympic Com. Member of Intern. Jury for Rowing.
Cross, W.	Trainer in Athletics.
Rt. Hon. Lord Desborough of Taplow, K. C. V. O.	President of British Olympic Council. Member of Intern. Olympic Com.
Ditchman, J. F. ..	Leader of Cycling Team.
Captain W. M. Ellerton, R. N.	Member of British Olympic Council.
Fowler-Dixon, J. E.	Member of British Olympic Council.
Gold, H. G.	Leader of Rowing Team.
Colonel J. Heap.....	Leader of Shooting Team.
Hearn, G. W.....	Leader of Swimming Team.
Henry, Wm.....	Member of British Olympic Council.
Mrs. Holmes	Swimming Trainer.
Hughes, C. J.....	Leader of Football Team.
Hurd, John C. ..	Member of British Olympic Council. Leader of Swimming Team.
Mrs. Jarvis	Swimming Trainer.
Johnstone, R.	Member of British Olympic Council. Leader of Cycling Team.
Colonel P. A. Kenna, V. C.....	Leader of Horse Riding Team.
Kirby, A. G.	Member of British Olympic Council.
Klein, W.	Trainer in Wrestling.
Rev. R. S. de Courcy Laffan	Secretary to British Olympic Council. Member of Intern. Olympic Com. Manager of British Teams.
Major L. N. Lloyd, D. S. O.	Leader of Shooting Team.
Longhurst, Percy	Leader of Wrestling Team. Judge in Wrestling Competitions.
Milne, W.	Team functionary for Shooting.
Moss, S. G.....	Team functionary for Athletics.
Musgrove, L. M. ..	Assist. Sec. to British Olympic Council.
Nelson, A.	Trainer in Athletics.
Nicholson, P. W.	Team functionary for Gymnastics.
Lieut.-Col. J. F. Noel-Birch	Member of Intern. Jury for Horse Riding.
Oberholzer, R.	Leader of Gymnastic Team.
Parker, F. W.....	Team functionary for Athletics.
Parrish, W.....	Trainer in Athletics.
Pelling, E. H.....	Team functionary for Athletics.
Pimm, W. E.....	Team functionary for Shooting.
D:r H. P. Potter ..	Medical Attendant.
Major P. W. Richardson.	Leader of Shooting Team.

Ridley-Martin, A.	Leader of Fencing Team.
Seligman, E.	Leader of Fencing Team.
Simmons, G. W.	Team functionary for Football.
Sykes, J.	Cycling Trainer.
Captain A. E. Syson	Judge in Gymnastic Competitions.
Thomas, W. G.	Trainer in Athletics.
Thomson, H.	Cycling Trainer.
Wall, F. J.	Member of British Olympic Council. Leader of Football Team.
West, C. J.	Member of British Olympic Council. Leader of Gymnastic Team.
Whitaker, G.	Team functionary for Shooting.
Woolfall, D. B.	Leader of Football Team. Member of Intern. Jury for Football.
Captain W. Wright	Member of British Olympic Council.

GREECE.

Professor Jean Chryssafis...	Member of Greek Olympic Com. Member of Intern. Jury for Shooting.
Metaxas, Anastase	Member of Greek Olympic Com. Member of the Intern. Jury for Athletics.

HOLLAND.

Blöte, C.	Team functionary for Football.
Brands, G. A. M.	Judge in Wrestling Competitions.
General, Baron Van der Capelle.....	Honorary Member of Committee for Horse Riding Competitions.
de Haan, P. A.	Team functionary for Football.
Hirschmann, C. A. W.	Leader of Football Team. Member of Intern. Jury for Football.
Lieut. A. E. W. de Jong	Member of Intern. Jury for Fencing. Judge in Fencing Competitions. Leader of Fencing Team.
de Jong, H.....	Judge in Fencing Competitions.
Ploeger, W.....	Leader of Wrestling Team.
Porthoine, Th.....	Team functionary for Football.
Reynolds, W.	Leader of Athletic Team.
van Rossem, G.	Judge in Fencing Competitions.
Count W. de Stirum	Secretary to Dutch Olympic Com.
Baron F. W. de Tuyll ...	President of Dutch Olympic Com. Member of Intern. Olympic Com.
Warner, J.	Representative for Football.
Willing, H. G.	Representative for Football.

HUNGARY.

von Abray, Zoltán	Leader of Rowing Team.
Count Géza Andrassy.....	Member of Intern. Olympic Com.
Bély, Michel	Judge in Gymnastic Competitions.
Csanádi, Moritz	Member of Intern. Jury for Wrestling.
Farkas, Aladár	Leader of Shooting Team.
von Füzessery, Arpád.....	Member of Intern. Jury for Swimming.
D:r M. Hajdu.....	Judge in Fencing Competitions.
von Iszer, Karl	Leader of Gymnastic Team. Member of Intern. Jury for Gymnastics.
Kárpáti, Béla	Leader of Football Team.
Kiss, Gésa	Leader of Swimming Team.
Laubar, Desider	Secretary to Hungarian Olympic Com. Member of Intern. Jury for Modern Pentathlon.
von Muzsa, Julius	President of Hungarian Olympic Com. Member of Intern. Olympic Com. Manager of Hungarian Teams.
D:r Béla Nagy	Judge in Fencing Competitions. Leader of Fencing Team.
Stankovits, Szilárd	Leader of Athletic Team. Member of Intern. Jury for Athletics.
Tarján, Elemer	Leader of Cycling Team.
D:r Péter Tatics	Judge in Wrestling Competitions. Leader of Wrestling Team.
Zsigmondy, Jeno	Leader of Lawn Tennis Team.

ITALY.

Ballerini, F.,	Treasurer to Italian Olympic Com.
Count E. Brunetta d'usseaux	Member of Intern. Olympic Com.
Brunialti, A., Councillor of State	Member of Intern. Olympic Com.
Marquis Compans de Brichanteau	President of Italian Olympic Com. Member of Intern. Jury for Fencing.
Croci, Em.	Leader of Swimming Team.
Diana, D. ..	Judge in Fencing Competitions.
Marquis M. Ferrante ..	Vice-President, Italian Olympic Com.
Professor R. Guerra	General Secretary to Italian Olympic Com.
Massini, Tito	Leader of Athletic Team.
di Nola, Ugo	Judge in Fencing Competitions.
Nunes, Ito	Leader of Fencing Team.
Captain F. Pietrasanta	Judge in Fencing Competitions.
Baron Pontenani ..	Judge in Fencing Competitions.
Pozzo, V.,.....	Leader of Football Team.
Speciale, P.	Judge in Fencing Competitions.

Professor Cesare Tifi Leader of Gymnastic Team.
 Judge in Gymnastic Competitions.
 Dr F. Tonetti..... Leader of Athletic Team.
 Valvassori, E. Leader of Football Team.

JAPAN.

Director Jigoro Kano Member of Intern. Olympic Com.
 Professor Hyozo Omori ... Member of Japanese Olympic Com.
 Captain Yeshioka Member of Japanese Olympic Com.

LUXEMBURG.

Kayser, Aloys Secretary to Luxemburg Olympic Com.
 Peffer, Valentin Leader of Gymnastic Team.
 Pescatore, Maurice Member of Intern. Olympic Com.

MONACO.

Count A. Gautier-Vignal... Member of Intern. Olympic Com.

NORWAY.

Miss Martha Aanensen ... Functionary for Gymnastic Display Team.
 Lieut. Aas, L. Th. Judge in Fencing Competitions.
 Allum, J. F..... Judge in Gymnastic Competitions.
 Captain Baumann Representative for Horse Riding.
 Bech, Nich..... Team functionary for Athletics.
 Major L. Bentzen Judge in Gymnastic Competitions.
 Berge, Anton Leader of Swimming Team.
 Berthelsen, F. Judge in Gymnastic Competitions.
 Björnstad, Johs. Rowing Instructor.
 Björnstad, S. Team functionary for Swimming.
 Botolfsen, Bernh. Team functionary for Cycling.
 Bye, Oscar W. ... Leader of Gymnastic Team.
 Captain Johs. Dahl. Instructor of Gymnastic Team.
 Lieut. Col. Egeberg-
 Ottesen..... Member of Intern. Jury for Horse Riding.
 Eger, Jr. Team functionary for Rowing.
 Enger, Johan Team functionary for Shooting.
 Ericksen, Chas. F. Trainer and Masseur.
 Captain R. Fabritius Instructor of Gymnastic Team.
 Fearnley, J:r, Thos..... Leader of Lawn Tennis Team.
 Five, O. Team functionary for Shooting.
 Captain Fougner..... Leader of Cycling Team.
 Frisch, A. Leader of Shooting Team.
 Member of Intern. Jury for Shooting.
 Lieut. Frölich-Hanssen, C. Secretary to Norwegian Olympic Com.
 Instructor for Gymnastic Team.
 Glad, Th..... Leader of Yachting Competitors.

Gude-Smith, Axel	Team functionary for Gymnastics.
Captain Grøttum	Representative for Norwegian Central Athletic Association.
Haanshus, O. A.	Team functionary for Rowing.
Hansen, Halvard	Team functionary for Cycling.
Heiberg, Chr.	Team functionary for Rowing.
Miss Inga Henriksen ...	Functionary for Gymnastic Display Team.
Jensen, Alfr. K.	Leader of Athletic Team.
Karlsen	Instructor for Rowing Team.
Captain O. T. Klingenberg	Leadar of Modern Pentathlon Team. Member of International Jury for Modern Pentathlon.
Knudsen, Oscar	Team functionary for Rowing.
Larsen, Alfred	Leader of Yachting Competitors.
Major-General, H. D. Lowzow	Honorary Member of Committee for Horse Riding Competitions.
Lund, Alfr. Chr.	Leader of Gymnastic Team.
Lund, Trygve	Team functionary for Football.
Lördahl, M.	Team functionary for Athletics.
Martens, Joh.	President of Norwegian Olympic Com.
Captain S. W. Mathiesen..	Judge in Fencing Competitions.
Captain Michelet	Leader of Horse Riding Team.
Moen, Haakon.....	Trainer and Masseur.
Moestue, L.	Team Functionary for Rowing.
Olsen, S.	Trainer and Masseur.
Pedersen, Carl Alfr.	Team functionary for Athletics.
Miss Kirsten Ravnsborg...	Functionary for Gymnastic Display Team.
Kosenvinge-Kolderyp, O...	Team functionary for Athletics.
Captain C. F. B. Schøyen	Leader of Football Team.
Lieut. Col. Seeberg	Representative for Shooting.
Lieut. Styri	Instructor for Rowing Team.
Captain Johan Sverre.....	President of Norwegian Olympic Com. Member of Intern. Olympic Com.
von Tangen.....	Leader of Fencing Team.
Thorstensen	Team functionary for Cycling.
Torgensen	Team functionary for Football.
Trogstad, Aug.	Team functionary for Cycling.
Consul Einar Wettre	Treasurer to Norwegian Olympic Com. Leader of Rowing Team. Member of Intern. Jury for Rowing Competitions.
Colonel H. Wettre.....	Honorary Member of Committee for Horse Riding Competitions.
Lieut. Wettre	Functionary for Horse Riding.
Major Wiel-Gjedde.....	Judge in Horse Riding Competitions.

PORTUGAL.

- Correrira, Fernando Member of Portuguese Olympic Com.
Manager of Portuguese Teams.
- Count de Penha-Garcia ... Honorary President of Portuguese Olympic Com.

RUSSIA.

- Anderson, Ervin Trainer.
- Berger, Georges One of Honorary Presidents for Rowing.
- Captain G. Bertren..... Judge in Prize Riding Competitions.
- Boutoussoff, Paul..... Leader of Football Team.
- Professor Franjo Bucar ... Representative for Gymnastics.
- Duperron, Georges Secretary to Russian Olympic Com.
Member of Intern. Jury for Modern Pentathlon.
- Captain Anatol Fok Leader of Gymnastic Team.
- Fulda, Roman..... Member of Moscow Olympic Sub-committee.
Representative for Football.
- Grotzky, Hugo President of Baltic Olympic local Com.
- Henning, Théodor Leader of Athletic Team.
- Count Serge Ignatieff..... Orderly to Official Representative of Russia at the
Games.
- Lieut. Boris Iwanenko ... Purser on S. S. "Birma".
- Major-General de Khimetz Hon. Member of Committee of Horse Riding Com-
petitions.
- Colonel D. Kniagewitch... Leader of Épée-Fencing Team.
- Linowall, Paul, Treasurer to Russian Olympic Com.
- Macpherson, Arthur Member of Russian Olympic Com.
Leader, of Lawn Tennis Team.
- Captain Martuscheff Judge in Fencing Competitions.
- Baron Th. Meïendorff' ... Hon. President of Russian Olympic Com.
- Colonel Alex. Mordowine Commander of steamer "Birma".
Leader of Fencing Team.
- Colonel Platon Moskoff... Leader of Shooting Team.
Member of Intern. Jury for Shooting.
- Muser, Heinrich Representative for Yacht Racing.
- H. Ex., E. Nobel Hon. Member of Committee for Horse Riding
Competitions.
- Prince Léon Orousoff..... Member of Intern. Olympic Com.
- D:r Wl. de Peskow Representative for Russian Admiralty.
- von Reïsnér, Karl Secretary to Baltic Olympic Sub-com.
- Sabatelli, V..... Bandmaster on board steamer "Birma".
- Captain Wl. Sarnafsky ... Adjutant-in-Waiting to Official Representative of
Russia at the Games.
- Schlicht, Karl Eugen..... Representative for Cycling.
- Colonel de Schweder..... Leader of Horse Riding Team.
- Sofronoff, Alexis Leader of Rowing Team.
- State-Councillor W. Sres-
neffsky President of Russian Olympic Com.
- D:r Wl. Stasenkoff..... Medical Attendant.

de Stieglitz, Nicolas Member of Russian Olympic Com.
 Leader of Cycling Team.

Captain Sweguinzoff Member of Intern. Jury for Horse Riding Competitions.

Teriavainen, Jalmer Interpreter.

Tschaplinsky, Ludwig..... Member of Intern. Jury for Wrestling.
 Leader of Wrestling Team.

General Vladimir Woie-
 koff Official Representative of Russia at the Games.

Woronkoff, Nicolai..... Leader of Swimming Team.

Dr W. Wsewolojskoi..... Medical Attendant.

Lieut. Nil Zavalischin ... Officer of S. S. "Birma".

SERVIA.

Captain S. Djonkitch Director of Servian Olympic Com.

Jovitch, A., C. E. Leader of Servian Teams.

Lieut. D. V. Voinovitch... Secretary to Servian Olympic Com.

SOUTH AFRICA.

Sir Lionel Philliphs, Bart Member of South African Olympic Com.
 Member of Intern. Jury for Shooting.

Captain W. Wetherell..... Member of South African Olympic Com.
 Manager of South African Teams.

SWITZERLAND.

Baron G. de Blonay President of Swiss Olympic Com.
 Member of Intern. Olympic Com.

Professor E. Richème..... Member of Swiss Olympic Com.

TURKEY.

Selim Sirry Bey Member of Intern. Olympic Com.

UNITED STATES OF AMERICA.

Armour, Allison V. Member of Intern. Olympic Com.

Billings, Charles W. Leader of Clay Bird and Running Deer Shooting Teams.

Brown, Everett, C..... Vice-President of U. S. A. Olympic Com.

Curtiss, A. H..... Treasurer to U. S. A. Olympic Com.

Farley, T..... Member of U. S. A. Olympic Com.

Colonel F. S. Foltz Member of Intern. Jury for Horse Riding Competitions.
 Leader of Horse Riding Team.

Halpin, M. P. Manager of U. S. A. Teams.
 Leader of Athletic and Wrestling Teams.

Hammond, G. M.	Member of U. S. A. Olympic Com. Judge in Fencing Competitions. Leader of Fencing Team.
Lieut. A. S. Jones	Leader of Shooting Team.
Kirby, Gustavus T.....	Vice-President of U. S. A. Olympic Com. Member of Intern. Jury for Modern Pentathlon.
Commander H. Lanning...	Leader of Army Rifle Shooting Team.
Lieut. Col. William Libbey	Member of Intern. Jury for Shooting.
Maccabe, Joseph B.	Member of U. S. A. Olympic Com.
Professor E. O'Neill	Member of U. S. A. Olympic Com.
Post A. van Zo	Judge in Fencing Competitions.
Sauer, A. E.	Judge in Fencing Competitions.
Dr R. H. Sayre.....	Leader of Pistol Shooting Team.
Professor W. M. Sloane...	Member of Intern. Olympic Com.
Sullivan, James E.	Official Representative of U. S. A. at the Games. Secretary to U. S. A. Olympic Com. Member of Intern. Jury for Athletics.
Colonel Robert M. Thompson	President of U. S. A. Olympic Com.
Wahle, Otto.....	Leader of Swimming Team.
Wainwright, A. R. W. ...	Member of U. S. A. Olympic Com.
Weeks, Bartew S.	Vice-President of U. S. A. Olympic Com. Member of Intern. Jury for Swimming.
Wendell, Evert J.	Member of Intern. Olympic Com.

**TABLE SHOWING THE TOTAL NUMBER OF FOREIGN
OFFICIAL REPRESENTATIVES AND FUNCTIONARIES
PRESENT AT THE GAMES OF STOCKHOLM.**

Nation	Number
Australasia	11
Austria	20
Belgium	18
Bohemia	22
Canada	4
Chili	4
Denmark	45
Egypt	1
Finland	23
France	39
Germany	53
Great Britain	54
Greece	2
Holland	15
Hungary	17
Italy	18
Japan	3
Luxemburg	3
Monaco	1
Norway	60
Portugal	2
Russia	40
Servia	3
South Africa	2
Switzerland	2
Turkey	1
United States of America	24
	Total 487

**LIST OF THE SWEDISH MEMBERS OF
COMMITTEES AND OFFICIALS.**

Aaris, Arthur	Hälsingborg	Official, Rowing Comp.
Adelswärd, A.	Stockholm	» Horse Riding Comp.
Adlersträhle, M., Fru ..	»	Memb. of Lawn Tennis Comm.
Agardt, Erik	Öebro	Official, Athletics Comp.
		» Football Comp.
Ahlberg, A.	Stockholm	» » »
Ahlsell, F.	»	Vice-Pres. of Entertainments Comm.
Ahlström, Harry	»	Official, Swimming Comp.
Anderberg, Aug.	»	» » »
Ahnström, A.	»	» Horse Riding Comp.
Ahnström, Otto	Umeå	» Athletics Comp.
		Memb. of Athletics Comm.
Albrechtsson, Knut.	Gothenburg	Official, Swimming Comp.
		» Rowing Comp.
Alderin, J.	Stockholm	» » »
Allen, K.	Köping	» Cycling Comp. (Control Comm.)
Almqvist, A.	Stockholm	Memb. of Tug-of-War Comm.
		Official, Athletics Comp.
Almström, K.	»	» Rowing Comp.
Almqvist, Sune	Uppsala	» Lawn Tennis Comp.
		» Football Comp.
Aminoff, Ivar	Falun	» Athletics Comp.
Amundson, K. A. B. ...	Stora Frösunda ..	Memb. of Building Comm.
Andersson, Adolf	Stockholm	Official, Swimming Comp.
Andersson, Alb.	»	» Yacht Racing Comp.
Andersson, Alb.	Västerås	» Cycling Comp. (Control Comm.)
Andersson, Carl	Stockholm	» » »
Andersson, Carl	Malmö	Memb. of Wrestling Comm.
		Official, Wrestling Comp.
Andersson, Erik	Mariefred	» Cycling Comp. (Control Comm.)
Andersson, E.	Eskilstuna	» Football Comp.
Andersson, Hugo	Stockholm	Asst. Sec. in Yacht Racing Comm.
		Official, Yacht Racing Comp.
Andersson, John B. ...	»	» Rowing Comp.
Andersson, John G. ...	»	Memb. of Swimming Comm.
		Official, Swimming Comp.
Andersson, Karl	Enköping	» Cycling Comp. (Control Comm.)
Andersson, Olof	Mariefred	» » » » »
Andersson, Otto	Stockholm	Memb. of Rowing Comm.
		Official, Rowing Comp.
Andersson, R.	» ..	Memb. of Football Comm.
		Official, Cycling Comp.
Andersson, V.	Kungsör	» » » (Control Comm.)
Andersson, Wicke	Enköping	» » » » »
Anderson-Edenberg, A.	Stockholm	Memb. of Press Comm.
Appelqvist, Harry	»	Official, Cycling Comp. (Control Comm.)
Appeltofft, Carl J.	Landskrona	» Rowing »

Armgaradt, G.	Malmö.....	Official, Athletics Comp.
Arosenius, K.	Enköping.....	» Cycling Comp. (Control Comm.)
Arp, L.	Bålsta	» » » (Control Stat.)
Arp, W.	»	» » »
Arpi, Signhild.....	Stockholm	» Gymnastics Comp.
Arvidson, Carl.....	Malmö.....	» Wrestling Comp.
Arvidsson, P. O.....	Stockholm	Memb. of Shooting Comm.
Asp, Nils.....	»	Official, Rowing Comp.
Asplund, Mauritz.....	Gothenburg.....	» Swimming »
Asplund, R.....	Stockholm	» Cycling »
Arfvedson, Axel	Örebro	» Swimming »
v. Bahr, Louise	Stockholm	» Gymnastics »
Balck, V. G.	»	Pres. Swed. Olymp. Comm.
		» Ex. Comm. of Swed. Olymp. Comm.
		» Building Comm.
		» Athletics Comp.
		» Modern Penta.
		» Intern. Jury for Gymn.
Bark, A.	Gothenburg.....	Official, Wrestling Comp.
Beck-Friis, G. J.....	Stockholm	» Horse Rid. »
Beckman, Gösta.....	»	» Swimming »
Behrens, Paul.....	»	» Cycling » (Control Stat.)
Benedicks, Edv.....	»	Memb. of Shooting Comm.
Bengtsson, Sture.....	Hälsingborg.....	Official, Athletics Comp.
Bennet, Fr.	Stockholm	» Horse Riding Comp.
Berg von Linde, A. ...	Kristianstad	» Gymnastics Comp.
Bergkvist, A.	Stockholm	» Cycling Comp.
Bergman, C.	Köping.....	» » » (Control Comm.)
Bergström, Arvid	Gäfle	» Athletics Comp.
Bergström, G.....	Gothenburg.....	» Football Comp.
Bergström, Otto.....	Stockholm	Pres. Accom. Comm.
Bergström, R.....	Eskilstuna	Official, Cycling Comp.
Bergvall, Erik.....	Stockholm	Pres. Swimming Comm.
		Memb. of » » Reception Comm.
		» » Modern Penta. Comm.
		» » Intern. Jury Swimming.
		» » Press Comm.
		Official, Swimming Comp.
		» » »
Bergvall, Harry	»	Memb. of Swimm. Comm's Recep. Comm.
Bergvall, Maria, Fru...	»	Comm.
Berndtsson, F.....	Uppsala	Official, Lawn Tennis Comp.
Beskow, Einar.....	Stockholm	» Wrestling »
Bielke, Ture	»	Nation-host for Austria.
Bildt, Tore	»	Official, Athletics Comp.
Bille, Fredrik.....	»	Memb. of » Comm. Ex. Com.
		Official » Comp.
Billman, H.....	Västerås	» Cycling » (Control Comm.)
Björk, O.....	Stockholm	» » » (» Stat.)
Björkenstam, Fr.....	»	Memb. of Shooting Comm.
		» » Big Game Shooting Comm.
		Official, Shooting Comp.
		Memb. of Intern. jury for Shooting.
Björkgren, A. W.	Malmö.....	» » Wrestling Comm.
		Official » Comp.
		Memb. of Intern. jury for Wrestling.
Björkvall John	Västerås	Official, Cycling Comp. (Control Comm.)
Blanche, T.h.	Stockholm	» Yacht Racing Comp.

Blidberg, Carl	Gothenburg	Memb. of Swimming Comm. Official » Comp.
Blixen-Finecke, C. von	Helsingborg	Official, Horse Riding Comp.
Blom, Sven	Uppsala	Nation-host for France.
Blomberg, D.	Stockholm	Sec. of Entertainm. Comm.
Blomberg, P.	»	Official, Yacht Racing Comp.
Blomquist, Carl	Karlskrona	» Wrestling Comp.
Bohnstedt, F.	Uppsala	Memb. of Lawn Tennis Comm. Official, Lawn Tennis Comp.
Boivie, Gustaf C.	Stockholm	Sec. Shooting Comm.
Bonde, C.	Tjärås	Memb. Horse Riding Comm.
Bondesson, C.	Stockholm	Official, Swimming Comp.
Bonthron, Axel	»	» Athletics »
Borg, James	Malmö	Memb. of Wrestling Comm Official, » Comm.
Bergström, W.	Lidingön	» Cycling »
Bosman, Jac.	Stockholm	Nation-Host for Holland.
Boström, W.	»	Memb. of Lawn Tennis Comm.
Bovin, Knut	»	Sec. Yacht Racing Comm. Official Yacht Racing Comp.
Brambeck, N.	»	Memb. of Fencing Comm. Official, » Comp.
von Braun, Chr.	»	» Cycling »
Bredberg, E.	»	» Swimming »
Broberg, Gustaf	Västerås	» Cycling » (Control Comm.)
Brolin, Erik	Stockholm	Nation-host for Great Britain.
Burman, Fale	»	» » » Hungary.
Börjesson, E.	»	Official, Cycling Comp.
Carlberg, E.	»	Memb. of Shooting Comm. Official » Comp.
Carlberg, W.	»	Memb. of Modern Penta. Comm. Sec. Gymnastics Comm. Official, » Comp.
Carlson, Sven	Falun	Memb. of Athletics Comm. Official » Comp.
Carlsson, Beyron	Saltsjöbaden	Memb. of Entertainm. Comm.
Carlsson, Fritz	Stockholm	Official, Athletics Comp.
Carlsson, G.	Eskilstuna	» Football »
Carlsson, Gunnar	Hälsingborg	» Cycling » (Control Comm.)
Cauillvine	Södertälje	» Rowing »
Ceder, Emil	Stockholm	» Cycling » (Control Comm.)
Cederlund, Edw., Jr	»	» » »
Cederström, B.	»	» Yacht Racing Comp.
Cederström, Cl.	»	» Horse Riding »
Christiansen, Ernst	Uppsala	Memb. of » » Comm.
Chryssafis, Michel E.	Stockholm	Official, Rowing Comp.
Clarino, Bernhard	»	Nation-host for Greece.
Clemens, W.	»	Official, Yacht Racing Comp.
Cleve, M.	»	Memb. of Rowing Comm. Official, Athletics Comp.
Cnattingius, B.	»	» Rowing »
Croneborg, W.	»	» Athletics »
Cronholm, Viking	Lidingön	Sec. Fencing Comm. Memb. of Modern Penta. Comm. Official, Fencing Comp.
Daavel, Anders	»	» Horse Riding Comp.
	»	» Athletics Comp.
	»	» Rowing »
Daewel, Anders	Stockholm	Memb. of Tug-of-War Comm. Official, Athletics Comp.

Dahl, Edward.....	Sundbyberg	Official, Athletics Comp.
Dahl, V.	Stockholm	» » »
Dahlberg, R.	»	» Swimming »
Dahlgren, E. S.	»	» Yacht Racing Comp.
Dahlström, Fr.	»	» Wrestling »
Dahlström, K.	»	» Rowing »
Dalman, Gösta	Gothenburg.....	Memb. of Football Comm.
		» » » Reception Comm.
Danielsson, Albin	Stockholm	Official, Rowing Comp.
Dickson, Charles.....	»	Memb. of Swed. Olympic Comm.
		» » Finance Comm.
		» » Building »
Dinell, Oscar	»	Official, Swimming Comp.
Djurberg, Nils	»	Memb. of Tug-of-War Comm.
		Official, Athletics Comp.
Djurberg, Wilhelm.....	»	» Swimming »
Drake, C. G.	»	Pres. Cycling Comm.
		» Tug-of-War Comm.
		Official, Athletics Comp,
		» Cycling »
		Nation-host for Denmark.
Drakenberg, Sten	»	Memb. of Intern. Jury Fencing.
Duhs, Hugo	»	Official, Yacht Racing Comp.
Eckermann, Erik v. ...	Sparreholm	Memb. of Big Game Shooting Comp.
Edlund, N. D.	Malmslätt.....	Vice-Pres. Swimming Comm.
		Pres. Intern. Jury Swimming.
Edström, J. S.	Västerås	Vice-Pres. Swed. Olympic Comm.
		Memb. of Ex. Comm. of Swed. Olympic Comm.
		Pres. Technical Section.
		Memb. of Building Comm.
		Pres. Intern. Jury Athletics.
Ehlert, F.	Stockholm	Official, Cycling Comp.
		» Rowing »
Ekberg, E.	»	» Athletics »
Ekberg, P.	»	» » »
Ekberg, Willie	Malmö.....	» Swimming»
Ekelund, Erik	Jönköping.....	» Rowing »
Ekenstam, E. af.....	Stockholm	» Yacht Racing Comp.
Ekhoff, John	»	» Swimming »
Eklund, Herman.....	Insjön	» Athletics »
Eklöf, E.	Stockholm	» » »
Ekman, Axel	Malmö.....	» Rowing »
Ekman, J. E.	Stockholm	Memb. of Shooting Comm.
Ekström, S. af.....	Stockholm	Nation-host for Germany.
Ekström, Birger	»	Memb. of Tug-of-War Comm.
		Official, Athletics Comp.
Ekström, W.	»	Memb. of Accom. Comm.
Ellberg, Ernst.....	»	» » Jury for Music Comp.
Elliot, Bror	»	Official, Athletics Comp.
Enell, K.	»	» Fencing »
Engelbrektson, Carl ...	Örebro.....	» Swimming »
Englund, Leopold	Gothenburg.....	Chief Sec. Athletics Comm.
		Official » Comp.
		Memb. of Ex. of Athletics Comm.
Engström, P. E.	Fristad Hed ...	Official, Fencing Comp.
Enlund, A. E.	Stockholm	» Cycling »
Eriksson, Arvid	Enköping	» » » (Control Comm.)
Eriksson, E.	Kungsör	» » » »
Eriksson, H.	»	» » » »

Eriksson, Henning	Kolbäck	Official, Cycling Comp. (Control Comm.)
Essen, C. von	Stockholm	› Horse Riding Comp.
Essen, H. von	›	Memb. of Fencing Comp.
		Official › Comp.
Fagrell, Folke	›	Memb. of Shooting Comm.
von Feilitzen	›	Official, Fencing Comp.
Fick, Emil	›	Pres. of › Comm.
		Memb. of Modern Penta. Comm.
		Official, Fencing Comp.
Fick, H.	›	Memb. of Lawn Tennis Comm.
Fjästad, Per	›	› › Swimming ›
		› › Rowing ›
		Official › Comp.
Fjästad, G.	Arvika ..	› Swimming ›
		› Cycling ›
Flygare, E.	Västerås	› › Comp. (Control Comm.)
Fogelberg, Dr.	Enköping	› › Comp.
Fornander, John	Stockholm	› › ›
Forsberg, A. F.	›	› Athletics ›
Forsell, G.	›	› Horse Riding Comp.
Forshell, O.	Gothenburg	Memb. of Football Comm.
		Official, Athletics Comp.
Francke, G.	Bålsta	› Cycling Comp. (Control Comm)
Fred, C.	Stockholm ..	› › Comp.
Fredell, Fabian	›	› Lawn Tennis Comp.
Frestadius, Erik	›	Memb. of Swed. Olympic. Comm.
		› › Entertainm. 1
		Pres. Reception Comm.
		Official, Yacht Racing Comp.
Frestadius, Gunnar	›	Memb. of Reception Comm.
Friberg, Wilh.	Gothenburg	› › Athletics ›
		› › Football ›
		Official, Athletics Comp.
Fries, Allan	Stockholm	› Cycling ›
Fries, C.	›	Sec Accom. Comm.
Fries, K. A. E.	›	Official, Athletics Comp.
		› Swimming ›
		› Cycling ›
Friman, Thor	Södertelje	Memb of Swimming Comm.
		Official, › Comp.
Frisell, O.	Falun	› Athletics ›
Frykman, G.	Stockholm	› Football ›
Fältdt, Alfred	›	Memb. of Tug-of-War Comm.
		Official, Athletics Comp.
Ganslandt, W.	Malmö	› Rowing ›
Gartz, Allan	Kolbäck	› Cycling Comp. (Control Comm)
Gelbord, Ruben	Stockholm	› Athletics Comp.
Giesecke, A.	Strängnäs	› Cycling › (Control Comm)
Graf, Vilh.	Stockholm	› Rowing Comp.
Grahn, Eman	›	› Athletics ›
Grahn, Erik	Örebro	Memb. of Football Comm.
		Official, Athletics Comp
		› Cycling Comp. (Control Comm)
Granberg, A.	Eskilstuna	
Granfelt, S.	Stockholm	Memb. of Modern Penta. Comm.
		Official, Rowing Comp.
		› Swimming ›
		› Modern Penta. Comp.
Granlund, Sten	›	Memb. of Press Comm.
Granström, Alexis	›	Official, Swimming Comp.
Grill, C	Skövde	› Horse Riding Comp.
Grut, Torben	Stockholm	Memb. of Entertainm. Comm.

Gräslund, A. I.	Stockholm	Official, Fencing Comp.
Grönberger, Gustaf.....	»	» Swimming Comp.
Gustafsson, B.	»	» Yacht Racing Comp.
Gustafsson, Georg	Järfva	» Cycling Comp. (Control Stat.)
Gyllenhammar, G.	Stockholm	» Athletics »
		Memb. of Tug-of-War Comm.
Haak, F.	»	Official, Rowing Comp.
Hafström, G.	»	» Yacht Racing Comp.
Hagberg, K.	»	Memb. of Press Comm.
Hagman, Carl	Hälsingborg	Official, Athletics Comp.
Hagner, G.	Mariefred	» Cycling Comp. (Control Comm.)
Hagström, E.	Stockholm	» » Comp.
Hallberg, K. E.	»	» Swimming Comp.
Hallén, Andreas	»	Memb. of Jury for Music Comp.
Hallman, John	»	Official, Wrestling Comp.
Hallman, M. N.	»	Memb. of Shooting Comm.
Hamilton, H.	Hessleholm	Official, Athletics Comp.
Hammar, A.	Gäfle	Memb. of Football Comm.
Hammar, John.....	Stockholm	Nation-host for Great Britain.
Hansson, G.	»	Official, Cycling Comp.
Hansson, Thure	»	» Swimming »
Hartzell, Erik	»	» Athletics »
Hartzell, Nils	»	» » »
Hay, Ebba	Jönköping	Memb. of Lawn Tennis Comm.
Hedberg, Gustaf.....	Stockholm	Official, Athletics Comp.
Hedberg, L.	Hälsingborg.....	» Horse Riding Comp.
Hedenblad, Hj.	Växjö	» Gymnastics »
Hedenblad, P.....	Hälsingborg.....	Memb. of Athletics Comm.
		Official, » Comp.
Hedendahl, Hugo	Boden	Nation-host for Russia.
Hedenstierna, A.....	Sköfde	Official, Horse Riding Comp.
Heidenstam, R. von ...	Stockholm	» Yacht Racing Comp.
Heijl, C. A.	»	Nation-host for France.
Heille, W.	»	Official, Cycling Comp.
Helgesson, Carl	Gothenburg	Pres. Wrestling Comm.
		Official, » Comp.
		Pres. Intern. Jury Wrestling Comm.
Hellberg, Carl.....	Stockholm	Memb. of Football Comm.
		» » Advertis. »
Hellberg, K. S.	Eskilstuna	Adj. member of Cycling Comm.
		Official, Cycling Comp.
Hellberg, O.	Stockholm	» Lawn Tennis Comp.
Helling, E.	»	» Shooting »
Hellkvist, O.	»	Memb. of Press Comm.
Hellsten, Albin	»	Official, Swimming Comp.
Hellsten, F.....	Västerås	» Fencing »
Hellström, Kristian.....	Stockholm	Sec. Swed. Olympic Comm.
		Memb. of Ex. Comm. of Swed. Olymp. Comm.
		Sec. Tug-of-War Comm.
		» Swimming »
		» Modern Penta. »
		» Advertis. »
		» Athletics »
		» » » Ex. Comm.
		Memb. of Entertainm. Comm.
		» » Accom. Comm.
Hellström, Sigrid	Stockholm	Official, Gymnastics Comp.
Hellström, W.....	Eskilstuna	» Cycling Comp. (Control Comm.)
Hemberg, Oscar	Stockholm	Memb. of Press Comm.
Hennichs, H.	»	Nation-host for Denmark.

Hermansson, V. R.	Stockholm	Official, Cycling Comp.
Hermelin, S. D. A. ...	»	Memb. of Swed. Olympic Comm.
		» » Accom. Comm.
		» » Reception Comm.
		Pres. Press Comm.
		Memb. of Athletics Comm.
Hessler, E.	»	» » Jury for Music Comp.
Hilding, Axel	Kolbäck	Official, Cycling Comp. (Control Comm.)
Hjorth, B. A.	Stockholm	Memb. of Yacht Racing Comm.
		Official, » » Comp.
Hjorth, C.	»	Memb. of Fencing Comm.
		Official, » Comp.
Hjortzberg, Olle	Saltsjöbaden.....	Memb. of Entertainm. Comm.
Hjärne, Erland	Gothenburg.....	» » Football »
		Official, » Comp.
Hodell, E.	Åmål	» Athletics »
		» Football »
		» Cycling Comp. (Control Comm.)
Hofstedt, O.	Stockholm	Memb. of Football Comm.
Holm, Ivar	»	Official, Athletics Comp.
		» Cycling »
Holmberg, E.	»	» Swimming »
Holmberg, Edmund ...	Malmö.....	» »
Holmberg, O.	Stockholm	Memb. of Gymnastics Comm.
		Official, » Comp.
		» Swimming »
Holmerin, H. F.	»	» Wrestling »
Holmqvist, Ivan	Karlskrona	» »
Holmsten, Karl	Stockholm	Nation-host for U. S. A.
Holtermann, Oscar.....	»	Memb. of Swed. Olympic Comm.
		Pres. Yacht Racing Comm.
		Official » » Comp.
Huldt, Hampus	»	Nation-host for Finland.
Hult, N.	Kolbäck	Official, Cycling Comp. (Control Comm.)
Hulthén, F.	Malmö.....	» Rowing »
Hultman, Axel	Stockholm	Nation-host for Norway.
Hultman, Axel	»	Memb. of Swimming Comm.'s Reception Comm.
		Official, Swimming Comp.
		» Rowing »
		» Athletics »
		» Horse Riding»
Husén, Arne	»	Memb. of Yacht Racing Comm.
Hübinette, S.	»	Official, » » Comp.
Hydén, Sven	»	» »
		» Fencing Comp.
Hylander, A.	Uppsala	» Cycling »
Hägglund, Carl	Stockholm	» » »
Hägglund, Thure	»	» » »
Höglund, F.	»	» » »
Höglund, Hugo	»	» » » (Control Comm.)
Höjer, Gunnar.....	»	» Gymnastic»
Höjer, O.	»	» Cycling »
Hök, Arvid	Norrköping.....	» Rowing »
		» Athletics »
Insulander, G.	Karlskoga	» »
Isaksson, C. J. A.	Stockholm	Nation-host for Germany.
Jacobsson, B.	Hälsingborg.....	Official, Rowing Comp.
Jansson, Ernst	Västerås	» Athletics »
Jansson, S. J.	Stockholm	» Fencing »
Johanson, Anton	»	Sec. Football Comm.
		Memb. of Swimming Comm.
Johansson, B.	»	Official, Lawn Tennis Comp.
Johansson, Edv.	Kolbäck	» Cycling Comp. (Control Comm.)

Johansson, E.	Västerås	Official, Swimming Comp.
Johansson, H.	Kolbäck	» Cycling Comp. (Control Comm)
Johansson, Herbert	Gothenburg	» Wrestling Comp.
Johansson, Hjalmar	Stockholm	Memb. of Wrestling Comm.
		Official, » Comp.
Johansson, Josef	»	» Cycling Comp. (Control Comm.)
Johansson, Karl	»	» Swimming Comp.
Johansson, Ragnar	Gothenburg	» Athletics »
Johansson, Rybin	Hälsingborg	Memb. of Football Comm.
		Official, » Comp.
Johansson, Sixtus	Stockholm	» Swimming »
Johnson, John	Enköping	» Cycling Comp. (Control Comm.)
Jonsson, Alfred	Stockholm	» » Comp.
Jonsson, Jonas	»	» » »
Juhlin, Elis	»	Memb. of Athletics Comm.
		» » » Ex. Comm.
		Official, » Comp.
Juhlin, Herman	»	» » »
Jundell, I.	»	» » »
Jungbäck, F.	Malmö.....	» Rowing »
Jöhncke, A.	Stockholm	» Fencing »
Jørgensen, O.	»	» Cycling »
		» Rowing »
Karling, Ivar	»	» Athletics »
Karlsson, Emanuel	»	» Cycling Comp. (Control Comm.)
Karlsson, Hilding	»	» Horse Riding Comp.
Karsten, P.	»	Memb. of Lawn Tennis Comm.
Keiller, James, J:r	Gothenburg	Official, Athletics Comp.
Kellgren, Henry	Norrköping	» Swimming »
Kihlmark, M.	Örebro	Vice-Pres. Tug-of-War Comm.
Killander, Ernst	Stockholm	Memb. of Football Comm.
		Official, Athletics Comp.
Kindberg, Axel	»	Nation-host for Austria.
Kindberg, A. E.	»	Official, Cycling Comp.
Kjellberg, C.	»	» Shooting »
Kjellén, L. E.....	»	» Fencing »
Kjellin, J. O.	Västerås	» Cycling » (Control Comm.)
Kjerrulf, H.....	Stockholm	» Yacht Racing Comp.
Klerck, C. G.....	»	» Fencing Comp.
Klercker, J. af.....	»	Memb. of Tug-of-War Comm.
Klinkowström, Axel ...	Ekerö	» » Shooting »
Klinteberg, Svante af...	Linköping	Nation-host for U. S. A.
Knafve, Baltzar	Stockholm	» » Luxemburg.
Knös, C.	»	Official, Horse Riding Comp.
Kock, Folke.....	»	Memb. of Press Comm.
Kornerup, C. L.	»	Pres. Football »
		» Advertis. »
		Memb. of Swimming Reception Comm.
		Pres. Intern. Jury for Football.
Kraepelin, O	»	Memb. of Cycling Comm.
		Official, » Comp.
Krafft, H.....	Sköfde	» Horse Riding »
Krautmeyer, A.	Falun	» Gymnastics »
Krook, N. J:r.....	Stockholm	» Shooting »
Kroplien, T.	»	» » »
Kullberg, A. G.	»	» Fencing »
Kumfeldt, Torsten	»	Memb. of Swimming Comm.
		Official, » Comp.
Källander, Paulus	Örebro	» » »
Källman	Södertälje.....	» Cycling Comp. (Control Comm.)

König, Cl.	Stockholm	Memb. of Modern Penta. Comm. Official, Horse Riding Comp.
Lagerberg, A. O.	»	» Athletics Comp.
Lagerkrantz, F.	»	Nation-host for Great Britain.
Lagerlöf, L.	»	Official, Cycling Comp.
Landegren, V.	»	Nation-host for Servia.
Lander, A.	Kungsör	Official, Cycling Comp. (Control Comm.)
Landqvist, Otto	Enköping	» » Comp.
Langborg, Gunnar	Stockholm	» » »
Larka, Torston	»	» Rowing »
Larsson, C.	»	» Cycling »
Larsson, David	Södertälje	» » » (Control Comm.)
Larsson, Gustaf	»	» » Comp. »
Larsson, Josef.	Stockholm	» Swimming »
		» Cycling »
Larsson, S. D.	»	Member of Swimming Comm. Official, » Comp.
		» Rowing Comp.
Larsson, Sigurd	Gothenburg	» Athletics »
de Laval, P.	Stockholm	» Fencing »
Leander, H.	»	Memb. of Press Comm.
Lennholm, N.	»	Official, Cycling Comp.
Lewenhaupt, C. G.	»	Memb. of Horse Riding Comm. » » Modern Penta. »
Lewenhaupt, Claes.	Katrineholm.	Pres. Big Game Shooting Comm. Official, Shooting Comp.
Levander, L.	Stockholm	» Lawn Tennis Comp.
Levin, Astley	»	Memb. of Swed. Olympic Comm. Pres. Medal & Badge Comm.
		Memb. of Finance Section.
Levin, Ernst	»	Official, Athletics Comp. » Cycling »
Levin, Hugo	Gothenburg.	Memb. of Athletics Comm. Official, » Comp.
		» Football »
Liberg, O.	Eskilstuna	» Cycling Comp. (Control Comm.)
Lieberath, E.	Gothenburg.	» Gymnastics Comp.
Lilja, A.	Stockholm	Pres. Entertainm. Comm.
Lindbohm, H. E.	»	Official, Fencing Comp.
Lindeberg, Edv.	Eskilstuna	» Cycling » (Control Comm.)
Lindencrona, G, C. A.	Stockholm	» Rowing Comp. Memb. of » Comm.
		» » Football »
Lindewald, E. W.	»	» » Shooting »
		Official, » Comp.
Lindfors, Th.	»	» Gymnastics »
Lindgren, Ernst.	Hufvudsta	» Swimming »
Lindh, Harald.	Stockholm	» » »
Lindh, Sam.	»	» » »
Lindhe, E.	Bålsta	» Cycling Comp. (Control Comm.)
Lindholm, G. W. M. ..	Stockholm	» Fencing Comp.
Lindman, Alex.	Stockholm	Sec. Building Comm. Memb. of Press Comm.
		Official, Cycling Comp.
Lindman, H.	»	» Football »
Lindman, Th.	»	» Cycling »
Lindmark, G. H.	»	Memb. of Tug-of-War Comm. Official, Athletics Comp.
Lindmark, Ivar.	Örebro	» Swimming »
Lindqvist, G.	Mariefred	» Cycling Comp. (Control Comm.)

Lindqvist, Herman	Enskede	Official, Swimming Comp.
Lindroth, Adolf	Stockholm	Nation-host for Portugal.
Lindroth, B.	Official, Shooting Comp.
Lindström, E.	»	» Swimming »
Lindström, Harald	Karlskrona	» Wrestling »
Linnander, A. H.	Bålsta	» Cycling » (Control Comm.)
Linnér, S. N.	Stockholm	Memb. of Swed. Olympic Comp.
		» » Finance Section. Comm.
Lithander, L.	»	Official, Rowing Comp.
Littorin, B. E.	»	Memb. of Gymnastics Comm.
		Official, » Comp.
		» Swimming »
Littorin, Konrad	Örebro	Memb. of » Comm.
		Official, » Comp.
Ljungberg, Fritz	Brussels	» » »
Ljungberg, Gottfrid.....	Bålsta	» Cycling Comp. (Control Comm.)
Ljungberg, Karl	Stockholm	Memb. of Yacht Racing Comm.
		Official, » » Comp.
Ljunggren, Adolf	Jönköping	» Athletics Comp.
Ljunggren, Erik	»	» Rowing »
Ljunggren, Nils	Stockholm	Pres. » Comm.
		Official, » Comp.
		» » »
Ljunggren, Thure	»	» Athletics »
Ljungquist, Henric	»	» Cycling »
Ljungquist, C. G.	»	» Cycling »
Lomm, E. E.	»	Sec. Finance Section. Comm.
Lund, A.	Kolbäck	Official, Cycling Comp. (Control Comm.)
Lundberg, Anna.....	Stockholm	» Gymnastics Comp.
Lundberg, C. O.....	Jönköping	» Horse Riding »
Lundberg, Emil	Stockholm	Memb. of Swimming Comm.
		Official, » Comp.
		» Cycling Comp. (Control Comm.)
Lundblad, Carl	Mariefred	» Gymnastics Comp.
Lundblad, P.	Visby	» Athletics »
Lundell, H.	Stockholm	» Athletics »
Lundgren, E.	Bålsta	» Cycling Comp. (Control Comm.)
Lundgren, Nils	Stockholm	» Yacht Racing Comp.
		Sec. Reception Comm.
Lundin, E.	Bålsta	Official, Cycling Comp. (Control Comm.)
Lundin, J. A.	Uppsala	» » Comp.
Lundin, L.	Bålsta	» » » (Control Comm.)
Lundqvist, Nils	Stockholm	» Athletics Comp.
Lundqvist, Victor.....	»	» Swimming »
Lundvik, Martin	»	» Athletics »
Låftman, Sven.....	»	Memb. of » Comm.
		Official, » Comp.
		Memb. of » Comm. Exec.
Löfgren, Charles.....	Örebro	Official, » Comp.
Löfgren, G.	Stockholm	Memb. of Gymnastics Comm.
		Official, » Comp.
		» » »
Löfvenius, E.	Norrköping	» » »
Lönnberg, Einar.....	Stockholm	Memb. of Jury for Big Game Shooting Comp.
Lönnegren, J. A.....	Berlin	» » Swimming Comm.
		» » » Reception Comm.
Löwenadler, C. O.	Smålands Anne- berg	» » Athletics Comm.
		Official, » Comp.
Löwenadler, Fredrik ...	Henley-on- Thames	Memb. of Swed. Olympic Comm.
		Hon. Pres. Rowing Comm.
		Pres. Intern. Jury for Rowing Comp.

Löwenadler, P.	Jönköping	Official, Horse Riding Comp.
Löwenthal, J.	Stockholm	Memb. of Press Comm.
Magnusson, J.	»	» » Rowing »
		Official, » Comp.
Magnusson, O.	Lund	» Lawn Tennis Comp.
Mally, T.	Gothenburg	» Swimming »
Malmgren, Gösta.	Ystad	» » »
Malmkvist, E.	Stockholm	» Cycling »
Malmros, G. J. C.	»	» Fencing »
Malmström, Hedvig ...	»	» Gymnastics »
Malmström, Karl.	Gothenburg	» Swimming »
Malmström, William ...	Malmö	» Wrestling »
Mannerhjärta, N.	Linköping	» Gymnastics »
Mannerstähle, K.	Ystad	» Horse Riding »
Maule, J.	Stockholm	» » »
Mauritzi, C. P.	London	» Swimming »
Meissner, Hjalmar	Stockholm	Memb. of Jury for Music Comp.
Melin, A.	Gothenburg	Official, Football Comp.
Melin, E.	Stockholm	Memb. of Shooting Comm.
Meurlin, S.	»	Official, Athletics Comp.
Moberg, C. Ludv.	»	» » »
Moberg, G.	»	» Gymnastics »
Modin, B.	Gäfle	» Football »
Molin, Edvin	Stockholm	Memb. of Advertis. Comm.
Molin, Gustaf	Hälsingborg	» » Rowing Comm.
Morales, Olallo	Stockholm	» » Jury for Music Comp.
Mossberg, G.	»	Official, Shooting Comp.
Munck, B.	Malmö	» Horse Riding Comp.
		Memb. of » » Comm.
Murray, A.	Stockholm	» » Reception Comm.
Murray, Walter	»	» » Swed. Olymp. Comm.
		» » Finance Section Comm.
Mårtenson, H.	»	Official, Yacht Racing Comp.
Möller, Sven	»	» Swimming »
		» Rowing »
Naess, H. Th.	»	Memb. of Jury for Big Game Shooting
Nathorst, A. G.	»	Comp.
Nauckhoff	Strängnäs	Official, Cycling Comp. (Control Comm.)
Nerman, Einar	Stockholm	Pres. Gymnastics Comm.
		Official, » Comp.
		Memb. of Intern. Jury for Gymnastics.
Nicklasson, Gustaf	»	Official, Athletics Comp.
Nilsson, E.	»	» Cycling » (Control Comm.)
Nilsson, Lambert.	Köping	» » »
Norbäck, H. G.	Stockholm	» Fencing »
Nordberg, A. G.	»	» Athletics »
Nordenström, S. A.	»	» Fencing »
Nordh, Oscar	Malmö	» Wrestling » (Control Comm.)
Nordvaeger, A.	Strängnäs	» Cycling »
Noring, Hugo	Gothenburg	» Athletics »
Numa, H.	Stockholm	» Rowing »
Nyberg, Felix	»	» Yacht Racing Comp.
Nyberg, G.	»	» Cycling Comp.
Nyberg, Knut	Falun	» Athletics »
Nyblaus, G.	Stockholm	Pres. Intern. Jury for Horse Rid. Comp.
Nygren, A.	»	Official, Yacht Racing Comp.
Nyqvist Eric	»	Nation-host for Hungary.
Nyström, Gunnar.	»	Official, Athletics Comp.
Ohlson, C. G.	Uppsala	» Horse Riding Comp.

Ohlson, O.	Visby	Official, Horse Riding Comp.
Ohlsson, John	Eskilstuna	» Athletics Comp.
		Memb. of Football Comm.
		» » » » Finance Comm.
		» » » » Technical »
Ohlsson, John	Malmö	» » Wrestling »
Ohrling, G.	Stockholm	» » Football »
		» » » » Finance Comm.
		Official, Athletics Comp.
		Memb. of Football Techn. Comm.
Olofsson, K.	»	Official, Cycling Comp.
Olsson, Harold	Saltsjöbaden	» Rowing »
Olsson, John	Södertälje	» Cycling » (Control Comm.)
Olson, John	Malmö	» Wrestling Comp.
Olsson, Magnus	Örebro	» Swimming »
Olsson, Märta	Stockholm	» » »
Olsson, Simon	Hallsberg	» Athletics »
Oxenstierna, E. C. G.	Stockholm	Pres. Horse Riding Comm.
Pallin, E.	Stockholm	Sec. Press Comm.
		Memb. of Cycling Comm.
		Official, » Comp.
Palm, Ernst	Malmö	» Wrestling »
Palm, N.	Västerås	» Shooting »
Palmborg, Harry	Stockholm	» Athletics »
Palmqvist, Maria	»	» Gymnastics »
Palmstierna, N.	»	Memb. of Horse Riding Comm.
		Official, » » Comp.
Paulsson, G.	Landskrona	» Rowing Comp.
Peil, Ernst, A.	Malmö	» » »
Pehrson, S.	Kungsör	» Cycling » (Control Comm.)
Personne, C. B.	Stockholm	» Fencing Comp.
Peterson, Erik	»	Memb. of Press Comm.
Petre, R. F.	»	» Advertis. Comm.
Pettersson, Albin	Köping	Official, Cycling Comp. (Control Comm.)
Pettersson, Axel	Stockholm	» » Comp.
Pettersson, Eli	»	» » » »
Pettersson, Emil	»	» Swimming Comp.
Pettersson, F.	»	Memb. of Cycling Comm.
		Official, » Comp.
Pettersson, Henrik	»	» Yacht Racing Comp.
Pettersson, J.	»	» Cycling Comp. (Control Comm.)
Pettersson, J. W.	»	» » Comp.
Pettersson, K. A.	»	» Athletics »
Philipson, J.	Norrköping	Memb. of Horse Riding Comm.
Philipson, O.	Eksjö	Official, » » Comp.
Piper, C. Fr.	Malmö	» » » »
von Platen, C.	Stockholm	» Gymnastics Comp.
Platen, C. G.	»	Pres. Intern. Jury for Fencing Comp.
Platin, C. F.	»	Adj. memb. of Cycling Comm.
		Official, Cycling Comp.
Poppius, G.	»	Nation-host for Canada.
Poss, Paul E.	»	Official, Swimming Comp.
Poss, David P:son	»	» Athletics »
Prollius, O.	Södertälje	» Cycling Comp. (Control Comm.)
Ramel, F.	Stockholm	Memb. of Reception Comm.
		» » Finance Section. Comm.
Ramsten, Gunnar	»	Official, Swimming Comp.
Ramström, C.	»	Memb. of Entertainm. Comm.
Ramström, Sven	Falun	Official, Athletics Comp.

Regnell, L.	Stockholm	Official, Swimming Comp.
Rettig, P.	»	» Cycling »
Richter, August	Lund	» Swimming »
Ringstrand, Arvid	Norrköping	» Athletics »
Rodhe, C.	Gothenburg	» »
Rosen, Clarence v.	Stockholm	Memb. of Swed. Olymp. Comm.
		» » Horse Riding »
Rosen, R. von.	»	» Intern. Jury for Horse Rid. Comp.
Rosengren, Karl Th. ...	Gothenburg	Official, Athletics Comp.
Rosin, Axel	Stockholm	Nation-host for Bohemia.
Rudberg, C.	Lysekil	Official, Athletics Comp.
Rude, A.	Stockholm	» Cycling »
Rudenschöld, Th.	»	» Horse Riding Comp.
Rundberg, Herman	»	» Athletics »
Runeborg, Gunnar	»	» Swimming »
Rydén, M.	»	» Cycling »
Rydstrand, N. F.	Ystad	» Horse Riding »
Rålamb, S.	Stockholm	Memb. of Shooting Comm.
		Official, » Comp.
Rönström, W.	»	» Yacht Racing Comp.
Salchow, Ulrich	»	Sec. Rowing Comm.
		Memb. of Press Comm.
		Official, Athletics Comp.
		» Rowing »
		Memb. of Intern. Jury for Rowing Comp.
Salmson, B.	»	Official, Horse Riding Comp.
Salmson, E.	»	Adj. memb. of Cycling Comm.
		Official, Cycling Comp.
Salmson, Walter	»	» »
Samsioe, C. G.	Linköping	» Athletics »
Samuelsson, Ernest	Gothenburg	» »
Sandberg, Carl	»	Memb. of Wrestling Comm.
		Official, » Comp.
Sandborg, Edvin.	Stockholm	Memb. of Athletics Comm.
		» » » » Exec.
		Official, Athletics Comp.
		Memb. of Football Comm.
		Pres. » » Fin. Sect.
		Memb. of » Technic. Comm.
Sandberg, F. af.	»	» » Swed. Olymp. Comm.
		» » Finance Section.
Sandell, G.	Jönköping	Official, Horse Riding Comp.
Sandqvist, David	Stockholm	» Wrestling Comp.
Santesson, B.	Eskilstuna	» Cycling Comp. (Control Comm.)
Schantz, Ragnar	Stockholm	» Swimming Comp.
Scharnhorst, Julius	»	» Cycling Comp. (Control Comm.)
Scherstén, O.	Djursholm	» Swimming Comp.
Schidorsky, L.	Stockholm	» Cycling »
Schnell, C. G.	Umeå	» Horse Riding Comp.
Scholander, Torkel.	Stockholm	Nation-host for Japan.
Schubert, Hugo	»	Official, Yacht Racing Comp.
Schumacher, W.	»	» Shooting Comp.
Schwerin, Ph. von	Eksjö	» Athletics »
Schånberg, L. B.	Jönköping	» Rowing »
		» Athletics »
Schöntal, A. R.	Stockholm	» Rowing »
Sederbaum, F.	Strängnäs	» Cycling Comp. (Control Comm.)
Segebaden, G. von.	Djursholm	» » Comp.
Seger, Alex.	Stockholm	» Swimming Comp.

Seger, Mauritz.....	Stockholm	Official, Swimming Comp.
Seldener, Herman	»	Memb. of Press Comm.
Sellin, C. E.	»	Official, Cycling Comp.
Setterberg, C.	Oskar Fredriks- borg.....	» Gymnastics Comp.
Shannong, Mia	Stocksund	» »
Silfverskiöld, P. O.....	Moscow	Nation-host for Russia.
Silfversparre, C.	Stockholm	Memb. of Building Comm.
		Official, Cycling Comp.
Silverstolpe, C.	»	Memb. of Modern Penta. Comp.
		» » Reception Comm.
		» » Intern. Jury for Athletics Comp.
		» » Intern. Jury for Modern Penta. Comm.
		Official, Modern Penta. Comp.
Silverstolpe, L.	»	» Lawn Tennis »
Silow, C.	Stockholm	» Fencing Comp.
Sjöberg, Ernst.....	Köping.....	» Cycling » (Control Comm.)
Sjöberg, Ernfrid.....	Sandhamn	» Yacht Racing Comp.
Sjöberg, F. A.....	»	» » »
Sjöberg, Th.	Järfva	» Cycling Comp. (Control Comm.)
Sjöblom, P.	Stockholm	» Football Comp.
Sjögren, N.	»	» Cycling »
Sjögreen, O.....	Norrköping.....	Memb. of Shooting Comm.
		Official, » Comp.
		» Wrestling »
Sjöholm, P. A.....	Gothenburg.....	Nation-host for South Africa.
Skjöld, Nore	Mölnbo	Memb. of Athletics Comm.
Smedmark, Sune.....	Stockholm	» » » Ex. Comm.
		Official, » Comp.
		Memb. of Modern Penta. Comm.
Smith, E. A.	»	Official, Yacht Racing Comp.
Sohlman, Harald.....	»	Memb. of Swed. Olymp. Comm.
Sorbon, David.....	Södertälje.....	Official, Cycling Comp. (Control Comm.)
Sparre, A. A:son	Stockholm	» Lawn Tennis Comp.
Spens, Harald.....	Uppsala	Nation-host for Italy.
Staafl, K. G.....	Stockholm	Official, Athletics Comp.
Stackell, E.....	Östersund.....	» Horse Riding Comp.
Staël von Holstein, C. G.	Ystad	» » » »
Stamsö, K. K.....	Malmö.....	Memb. of Rowing Comm.
		Official, » Comp.
		» » »
		» Swimming »
Stendahl, A. Fridlef...	Paris.....	Memb. of Swimming Reception Comm.
Stendahl, Najme.....	Gäfle	Nation-host for U. S. A.
Stierngranat, M. L.....	Stockholm	Vice-Pres- Cycling Comm.
Storm, A.....	Danderyd.....	Official, » Comp.
		» Fencing »
Stranne, J. S.....	Stockholm	» Yacht Racing»
Stålhand, Joh.....	»	» Cycling Comp. (Control Comm.)
Sund, Karl.....	Kolbäck	» Fencing Comp.
Sundell, Y.....	Stockholm ..	Memb. of Shooting Comm.
Swahn, Alf.....	Rosenhill-Täby	» » » »
Swahn, O. G.....	Stockholm	Official, Cycling Comp. (Control Comm.)
Svenson, Albin	Köping.....	» » » »
Svensson, Arvid.....	»	» » » »
Svensson, Filip	Gothenburg.....	» Athletics »
Svensson, Hj.	Stockholm	» Cycling »
Swedlund, G.....	Gäfle	» Gymnastics Comp.
Sydow, K. von	Gothenburg.....	» Horse Riding »
Söderberg, E. A.	Strängnäs.....	» Cycling Comp. (Control Comm.)

Söderberg, E.	Stockholm	Official, Swimming Comp.
Söderberg, G.	Enköping.....	» Cycling Comp. (Control Comm.)
Söderqvist, O. F.....	Västerås	» » » »
Söderström, Bruno	Stockholm	Memb. of Athletics Comm.
		» » » Ex. Comm.
		Official, » Comp.
Söderström, Gustaf.....	Norsborg	» » »
Taube, C. E.	Stockholm	Pres. Shooting Comm.
		Vice-pres. Modern Penta. Comm.
		Official, » » Comp.
		Pres. Jury for » » »
		» » » Shooting Comp.
Tauvon, A.	Bålsta	Official, Cycling Comp. (Control Comm.)
Ternström, Gustaf ...	Stockholm	Nation-host for Switzerland.
Tham, V.....	»	Official, Athletics Comp.
Thisell, Nore	»	Memb. of Swed. Olymp. Comm.
		» » » » Exec.
		Comm.
		» » Accom. Comm.
		» » Athletics »
		» » » » Ex. Comm.
Thomas, A. V.	»	» » Swimming Reception Comm.
		Official, » Comp.
Thorén, Per.....	»	» » »
Thorsell, Erik.....	Gothenburg.....	» Athletics »
Thorslund, Ivar	Västerås	» Swimming »
Thulin, Arthur	Enköping.....	» Cycling Comp. (Control Comm.)
Thulin, J. G.	Lund	» Fencing Comp.
Thulin, O.	Gothenburg	» Football »
Torén, G.	Djursholm	Memb. of Horse Riding Comm.
Trägårdh, C.	Stockholm	Sec. » » »
Tägtström, I.	»	Memb. of Fencing Comm.
		Official, » Comp.
Törnebladh, Carl	»	» Yacht Racing Comp.
Törnequist, John	»	Memb. of Press Comm.
Törsleff, A.	»	Official, Lawn Tennis Comp.
Törsleff, Thor	»	Nation-host for Belgium.
Uggla, Axel.....	Karlskrona	Official, Athletics Comp.
Uggla, G. G:son.....	Stockholm	Memb. of Swed. Olymp. Comm.
		» » » » » Ex.
		Comm.
		» » Press Comm.
		Vice-pres. Athletics Comm.
		Pres. Athletics Comm.'s. Exec. Comm.
		Official, » Comp.
		Memb. of Techn. Section.
		» » Modern Penta. Comm.
Ullén, C. A.	»	Sec. Cycling Comm.
		Official, » Comp.
Ullén, Erik.....	»	Pres. Mountain Ascents Comm.
Ulrich, A.	Säter	Memb. of Swimming Comm.
		Official, » Comp.
Unander, Victor.....	Stockholm	Nation-host for Greece.
		Official, Shooting Comp.
Wagner, Fredr.....	»	» Yacht Racing Comp.
Wahlberg, David	»	Press Commissioner.
Wahlqvist, O. W.	»	Memb. of Accom. Comm.
Wahlqvist, W.....	»	Official, Shooting Comp.

Wahlstedt, A.	Stockholm	Official, Athletics Comp. » Cycling »
Waldenström, Frans ...	»	» Rowing »
Valentin, Oscar	»	» Athletics »
Wallenberg, Vict.	»	» Shooting »
Wallenberg, A.	»	Pres. Lawn Tennis Comm.
Wallenius, K.	Uppsala	Official, Gymnastics Comp.
Wallsten, Gustaf	Jönköping	» Rowing »
Wannberg, G.	Eksjö	» Horse Riding »
Warelius, Stellan	Stockholm	Memb. of Wrestling Comm. Official, » Comp.
Wennerholm, A.	»	» Lawn Tennis »
Wennerholm, J.	»	» Horse Riding »
Wennerström, Gunnar ...	»	» Swimming »
Werkmäster, John	Falun	» Athletics »
Werner, C.	Stockholm	» Yacht Racing »
Werner, H.	Västerås	» Fencing »
Wersäll, Adolf	Stockholm	» Athletics »
Westergren, Hj.	Norrköping	» Football »
Westerling, S.	Stockholm	» Horse Riding »
Westin, L.	Kungsör	» Cycling Comp. (Control Comm.)
Westin, M.	Stockholm	» Athletics Comp. » Cycling »
Wibom, T.	Rosersberg	» Athletics »
Wiborgh, G. A.	Stockholm	» Horse Riding Comp.
Videman, Sigurd	»	» Swimming »
Wiedesheim-Paul, G. ...	Malmö	» Horse Riding »
Wiggberg, R.	Stockholm	» Cycling »
Wigh, Gustaf	»	» Rowing »
Wijkander, W.	Bålsta	» Cycling Comp. (ControlComm.)
Wilton, R.	Stockholm	» Yacht Racing Comp.
Winroth, Arne	»	Nation-host for Chili.
Winroth, G.	Karlberg	Official, Gymnastics Comp.
Wirström, A.	Stockholm	» Rowing »
Wirström, S.	»	» » »
Wollgarth, A. Hj.	»	Memb. of Tug-of-War Comm. Official, Athletics Comp.
Wrede, Fab. F:son	Lidingö	Treasurer, Horse Riding Comm.
Wretman, G.	Stockholm	Memb. of Modern Penta. Comm. » » Swimming Comm. Official, » Comp.
Wretman, Helmer	»	» » »
Wähländer, G.	Uppsala	» Cycling »
Ydén, Set	Södertälje	» » Comp. (Control Comm.)
Zetterlund, V.	Vaxholm	Memb. of Rowing Comm. Official, » Comp.
Zetterberg, Kurt	Stockholm	Sec. Lawn Tennis Comm. Official, » Comp.
Åfeldt, Svante	Ystad	» Athletics »
Åhlin, A.	Eskilstuna	» Cycling Comp. (Control Comm.)
Åhman, C. Gösta	Gothenburg	» Athletics Comp.
Åkerblom, Simon	Eskilstuna	» Football »
Åkerman, J.	Stockholm	» Horse Riding Comp.
Åkerstedt, S.	Tumba	Memb. of Cycling Comm. Official, » Comp.
Åkesson, R.	Stockholm	» » »

Ålund, C. W.	Uppsala	Official Fencing Comp.
Åsbrink, Gustaf	Stockholm	Memb. of Advertis. Comm.
Öfverström, H.	»	Official, Cycling Comp.
Öhngren, A.	»	» Athletics »
Östberg, N. F.	»	Nation-host for Australasia.
Östlund, P. A.	»	Official, Cycling Comp.

**LIST OF FOREIGN JOURNALISTS
AT THE GAMES.**

AUSTRALASIA.

Cunningham, C. S.....	Melbourne Argus	Melbourne.
Hill, James	Sidney Morning Herald.....	Sydney.

AUSTRIA.

Dregiewicz, T.	Abendblatt	Lemberg.
Graf, Felix	Neue Freie Presse	Vienna.
Hack, Karl	Körpersport im Wort und Bild	»
Hänsler, Em.	Allgemeine Sportzeitung.....	»
Koetschke	Die Zeit	»
Netreffo, Otto	Telegraf Bureau	»
Pfeiffer, Hans	Die Zeit	»
Spaette, W. Erich	Linzer Post	Linz.
Valentin, A.		Vienna.
Wraschtil, H.	Sport Korrespondenz Bureau	»

BELGIUM.

Boin, Victor.....	Le Petit Bleu du Matin.....	Brussels.
Grégoire, Fils	La Chronique	»

BOHEMIA.

Kalva, Jar.	Narodni Politika	Prague.
Kraus, H. A.	Prager Tageblatt und Bohe- mia	»
Paukowski, E.	Prager Bohemia	»
Taussig, Rudolf	Prager Tageblatt.....	»

CANADA.

Lanctôt, Gustave	La Presse Montreal	Montreal.
------------------------	--------------------------	-----------

DENMARK.

Aabye, E.	Politiken	Copenhagen.
Christensen, J.	Idraetten	»
Diemer, Anders, M.	Berlingske Tidende.....	»
Diemer, Asmus	Köbenhavn	»
Gottlieb, J. C.....	Kristeligt Dagblad	»
Graucob, P.	Verden og Vi	»
Gulman	Nationaltidende	»
Hübscher, A.	Idraetten	»

Högmark, Fred	Jysk Morgenblad	Aarhus.
Jensen, K.	Idraetten	Copenhagen.
Lomberg-Nielsen, N. Mrs. ...	Ugens Tilskuer	»
Melchior, H. E.	Politiken	»
Meyer, A. C.	Social Demokratene	»
Middlebo, A.	Aftenbladet	»
Dr. Möller	Sportsbladet	»
Nielsen, A. R.	Riget	»
Nielsen-Nyberg, N. C.	Sorö Amtstidende	Slagelse.
Nyblom, C. G.	Ny Ill. Tidende	Copenhagen.
Schmidt, Eugen	Aalborgs Amtstidende	Aalborg.
Seedorff, H. H.	Dansk Pressebureau	Copenhagen.
Voyd-Jørgensen, T.	Aarhus Stiftstidende	»
Wannberg, Helge	Politiken	»

FINLAND.

Blomberg, Aug.	Åbo Underrättelser	Åbo.
Flander, Astrid, Mrs.	Dagens Tidning	Helsingfors.
Flander, W.	Dagens Tidning ..	»
Halme, J.	Uusi Suometar	»
Krogerus, Valter	Tammerfors Nyheter	Tammerfors.
Linderoos, A.	Finskt Idrottsblad	Helsingfors.
Mosinen, M.	Karjala	Wiborg.
Oksanen, J.	Kaiku	Uleåborg.
Pusinen, O.	Socialisti	Åbo.
Roilo, J.	Työmies	Helsingfors.
Soinio, K.	Helsingin Sanomat	»
Strandberg, S.	Furun Sanomat	Åbo.
Valarne, T.	Aamulehti	Tammerfors.
Westerholm, Uno	Hufvudstadsbladet	Helsingfors.
Wilskman, Jarl	Vasabladet	Wasa.
Woutia, A.	Suomen Urheilulehti	Helsingfors.

FRANCE.

Adams-Ray, E.	The Continental Daily Mail ...	Paris.
Borgh, Th.	Le Figaro	»
Champs, Paul	L'Auto	»
Eliason, Léo	Le Soleil	»
Eliason, M:me	Le Petit Niçois	Nice.
Etzel, E.	Le Matin	Paris.
Glarner, A.	Excelsior	»
Guérin, R.	Le Matin	»
Hébertot, J.	L'Aéro	»
Heyman, H.	»
de Lafreté, G.	L'Echo de Paris	»
Légal, E.	Phare de la Loire	Nantes.
Prade, Georges	Le Journal	Paris
Puaux, R.	Le Temps	»
Rousseau, Paul	Le Temps	»
Rozet, Georges	L'Opinion	»

GERMANY.

Backman, H.	Süddeutsche Sportzeitung	Karlsruhe.
Berna, M.	Berliner Lokalanzeiger	Berlin.
Blomquist, G.	Vossische Zeitung	»
Brandt, M.	Sportliche Rundschau	»
Braun	Fussball	Munich.
Bräuel, Paul	Spiel, und Sport	Danzig.
Diem, Carl	Berliner Lokalanzeiger	Berlin.

Dierking, Karl	Scherls Ill. Zeitungen	Berlin.
Dörr, W.	Frankfurter Zeitung	Frankfurt.
Freitag, R.	Der Deutsche Schwimmer.....	Stuttgart.
Friedrich, H.	Rad und Auto	Berlin.
Glückermann	Schlesische Zeitung	Breslau.
Groh, Fritz	Deutsche Turnzeitung	Leipzig.
Hallama, G.	Schlesische Zeitung	Breslau.
Herold, E.	Münchener Neueste Nachrichten	Munich.
Jaeschke, A.	Münstersche Zeitung	Münster.
Kilian, O.	Kölnische Zeitung	Cologne.
Köhler, Fr.	General Anzeiger	Dortmund.
Lahrnsen, Paul		Eutin i. Holstein.
Loening, Arthur	Nordland	Berlin.
Loenne, W.	Westdeutsche Presse	Düsseldorf.
Lönnegren, John		Berlin.
Dr. Malwitz.....	Berliner Tageblatt	»
Markus, Carl	Fussball und Leichtathletik ...	»
Martens, Walther	Stettiner Neueste Nachrichten	Stettin.
Maschke, Th. Prof.....	Schlesische Zeitung	Breslau.
Meynen, Paul	Leipziger Neueste Nachrichten	Leipzig.
Möser, Max	Berliner Zeitung am Mittag ...	Berlin.
Nierich, Max	Arbeiter Turn-Zeitung	Leipzig.
Riecken	Berliner Volkblatt	Berlin.
Rothe, Paul	Deutsche Warte	»
von Salzgeber	Der Sport	»
Schmülling, Jr, Carl	Tempelhofer Vorort Zeitung...	Tempelhof.
Sommerfeldt, Th. Prof.....	Die Hygiene	Berlin.
Spiller, Carl, Dr.	Vollblut Zucht und Rennen ...	»
Stempel, R. C.	Kölnische Volks-Zeitung	Cologne.
Struckmann	Illustrierter Sport	Berlin.
von Vagenheim, Freiherr. ...	Neue Preussische Kreuz-Zeitung	»
Volderauer, Rich.	Badische Presse	Karlsruhe.
Wagner, Eugen	Berliner Zeitung am Mittag ...	Berlin.
Wäitzler, Joseph	Illustrierte Sportzeitung	Munich.
Walter, Rud.	Wolffs Bureau.....	Berlin.

GREAT BRITAIN.

Adam, George.....	Reuter's Office	London.
Adam, George, Mrs	Truth	»
Barnes-Stevani, W.	Authors Club	»
Bernett, Marshall	Sheffield Daily Telegraph.....	Sheffield.
Binks, Joe	News of the World	London.
Colvill, R. A.	Express & Echo	Exeter.
Fair, W. J.	The Central News, Ltd	London.
Fowler-Dixon, C. D.	Athletic News Agency	»
George, A. B.	Sports News Agency	»
George, W. G.	The Budget.....	»
Henry, William	The Evening News	»
Hetcher, J. E.....	The Ill. Sporting & Dramatic News	»
Hodson, B. J.	The Central News, Ltd.....	»
Hulton	Sporting Chronicle	Manchester.
Johnsson, A. E.	The Graphic	London.
Nickalls, Guy	The Morning Post	»
Monks, S. J.	The Evening News	»
Moss, P. J.	The Daily Mirror	»
Mussabiri, L. A.....	The Daily Telegraph.....	»

Page, A. H.	The Sportsman	London.
Parker, W. A.	Glasgow News	Glasgow.
Phillips, P.	The Daily Express	London.
Robinson H. Perry	The Times	»
Samuel, John	The Glasgow Herald	Glasgow.
Short, W. P.	Edinburgh Evening Despatch ..	Edinburgh.
Sinclair, W. L.	Athletic News	Manchester.
Smith, C. Stewart	Health & Strength	London.
Thomas, W. Beach	The Daily Mail	»
Wagstaffe-Simmons, G.	The Sporting Life	»

HOLLAND.

Bruna, Jan J.	De Nieuwe Courant	Amsterdam.
Dietovis, C. A.	Maasbode	Rotterdam.
Hoogesseger, J. T.	Nieuwe Rotterdamsche Cou- rant	»
Humme, A. A.	Nieuwe Rotterdamsche Cou- rant	»
Levie, M. Dr.	Groningen Dagbladet	Groningen.
Nyland, G. J.	Algemeen Handelsblad	Amsterdam.
Phzu, Haryette	De Telegraaf	»
Vijnberg, A. V.	Groningen Dagbladet	Groningen.

HUNGARY.

Antal, Alexander	Az Ujsaj	Buda Pesth.
Balint, A.	Fügettler Maygodoslag	»
Barlay, O.	Sport Vilag	»
Benet, Stephanie, Miss	Politisches Volkblatt	»
Bing, E.	Astes Politisches Volkblatt.....	»
Biro, D.	Nepozava	»
Dirsztay, Gedeon, Baron ..	Sport Hirlap	»
Földessy, F.	Magyar Hirlap	»
Gillemot, F.	Az Est	»
Goldscheider, N.	A Nap	»
Halper, K. Ropia	Neues Pester Journal	»
Herendi, A.	Az Misaj	»
Herman, G. Dr.	Tesnesvari Hirlap	»
Izolai, I.	Magyar Estilap	»
Izso, L.	Pesti Hirlap	»
Kis, G.	Budapesti Hirlap	»
Kohn, Emerich	Neues Budapester Abendblatt..	»
Kondor, Alfred	Uj Idók	»
Kondor, Alfred, Mme	Uj Idók	»
Laszlo, S.	Magyarodozay	»
Lazar, F.	Pesti Hirlap	»
Magyor, Karoly	Magyar Nemzet	»
Neuwelt, E.	Uj Hirck	»
Pasztór, A.	Az Est	»
Polonyi, D.	Nemzeti Sport	»
Speide, Z. Dr.	Sport Hirlap	»
Vida, H.	Budapester Presse	»

ITALY.

Balestriere, Arturo	Sports Atletici, Gazzetta Sport..	Milan.
Ballerini, F.	Agenzia Stefani	Rome.
Benfratello, John	Corriere di Sicilia	Palermo.
Boite, A. Prof.	L'Independente	Rome.
Francesco, F.	Messagero	Rome.

Guazzini, L.	La Nazione	Rome.
Guerra, Romano	Giornale d'Italia	»
Lantieri, F.	Sport Italiano	New York.
Scarabelli, P.	Stampa Sportiva	Turin.
Speciale, P.	L'Ora	Palermo.
Toffaletti, Ugo	Il Secolo	Milan.
Touetti, F.	Corriere della Sera	»

JAPAN.

Mr. Oi		Tokio.
Mr. Omori		»
Mr. Oki Tsuchiya	The Osaka Mainichi Shimbun.	Osaka.

NORWAY.

Bruzelius, Hj.	Morgenposten	Christiania.
Durban-Hansen, H.	Tidens Tegn	»
Fjeldvig, B.	Idraetsfolk	Trondhjem.
Frich, O. R.	Örebladet	Christiania.
Froisland	Aftenposten	»
Mrs. Hemberg	Morgenbladet	»
Klingenberg, Captain	sport	»
Kvale, T.	Trondhjems Adresseavis	Trondhjem.
Mo, Carl	Norska Socialdemokraten	Christiania.
Ottesen, E., Miss	Ny tid	Trondhjem.
Thorp, G. S.	Norsk Idraetsblad	Christiania.
Welhaven, Gerda Mrs.	Dagbladet	»
Welle-Strand, Edv.	Bergens Aftenblad	Bergen.

PORTUGAL.

Carreo, Fernando	O Intransigente	Lisbon.
Vital, Joaquim	Os Sports	»

RUSSIA.

de Belocha, M.	Ziemstchina	St. Petersburg.
von Hagen, A.	Rigasche Zeitung	Riga.
Janowsky-Janschewsky, J.	Rigas Avise	»
Kallas, Oscar, Dr.	Postimeas	Dorpat.
Klosnik-Janusjowsky, Z.	Wedrowiec	Swow.
von Kügelgen	St Petersburg-Zeitung	St. Petersburg.
Kühn, Alfred	Rigasche Rundschau	Riga.
Linemuth, A.	Rigaer Tageblatt	»
Rowrokowsky, Alex.	Metropolis Gossips	Moscow.
de Stieglitz	Novoje Wremja	St. Petersburg.
Stumburg, I.	Dsimtenes Wehtstnesis	Riga.
Tiraspolkaja, Raisse, M:me..	Retch	St. Petersburg.
Trum, George	Kraft und Gesundheit	»
Tönson, Leopold	Tallina Teataja	Reval.
Vartasarianz, Leon	Horison	Tiflis.

SOUTH AFRICA.

Keartlard, H. B.	Cape Argus	Cape Town.
-----------------------	------------------	------------

SPAIN.

Juncosa, J. C. y.	La vue de Catalunya	Barcelona.
de Perca, R. Estedez	Heraldo de Madrid	Madrid.

SWITZERLAND.

Gandard, V.	La Gazette de Lausanne.....	Lausanne.
Moeschlin, Felix	Baseler Nachrichten	Basle.
Rüegg, Ja	Verlag des "Football"	Zürich.
Wagner, Julius	Ill. Zeitschrift für Sport und Touristik	»

U. S. A.

Albertanti, Frank	New York Evening Mail	New York.
Andersson, Karl G.	Svenska-Tribunen Nyheter.....	»
Armfelt, G., Baron	America, The Catholic Review	»
Axelson, J. W.	Chicago Record Herald.....	Chicago.
Bonde, Emil, J.	Svensk-Amerikanska Familje- Journalen ..	Evanston, Ill.
Borgström, William	Nordstjärnan	New York.
Collins R. M.	Associated Press	»
Durkin, Martin T.	The Editorial Review.....	»
Ekdahl, Sigurd	The Milwaukee Leader	Milwaukee.
Florén, J. C.	Lindsborgs Posten	Lindsborg.
Hallahan, John H.	The Boston Herald.....	Boston.
Hyde, Louis B.	The Detroit Free Press.....	Detroit.
Irwin, William	Colliers National Weekly	New York.
Mitchell, James	The New York Herald	»
Norberg, Thor	Svenska Amerikanaren	Chicago.
Rell, E. P.	The Chicago Daily News	»
Reynolds, Howard	The Boston Post.....	Boston.
Robertson L.	Evening World	New York.
Royd, E.	The New York American	»
Rushnell, E. R.	The New York Tribune	»
Shepherd, W. G.	United Press	»
Stern, F. E.	Saturday Evening Post	»
Svensson, Sven	Vestkusten	San Francisco.
Tewson, W. O.	The New York Times	New York.
Valentine, Howard	The Globe	»
Whelan, Paul W.	The New York Sun	»
Williams, Ch. W.	The New York American	»
Yarrow, E. A.	The New York Independent...	»

NUMBER OF JOURNALISTS AT THE
OLYMPIC GAMES.

Australasia	2
Austria	10
Belgium	2
Bohemia	4
Canada.....	1
Chili.....	—
Denmark	22
Egypt	—
Finland	16
France	16
Germany	42
Great Britain	29
Greece	—
Holland	8
Hungary	27
Italy	12
Japan	3
Luxemburg	—
Norway	13
Portugal	2
Russia	15
Servia	—
South Africa	1
Spain	2
Sweden	186
Switzerland	4
Turkey.....	—
U. S. A.	28
	445

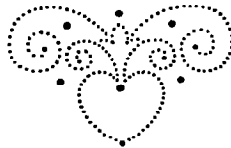

**RULES AND REGULATIONS
FOR THE COMPETITIONS.**

ATHLETICS.

GENERAL REGULATIONS.

1. The competitions will be organized by the Olympic Sub-Committee for Athletics appointed by the Svenska Idrottsförbundet (Swedish Amateur Athletic Association.)

2. The competition shall be confined to amateurs in accordance with the following definition:

An amateur is one who has never:

a) competed for a money prize or a monetary consideration, or in any way drawn pecuniary gain from the exercise of his sport;

b) competed against a professional;

c) taught in any branch of athletics for payment;

d) sold, pawned, hired out, or exhibited for payment any prize won in a competition.

3. Each competitor shall wear a jersey with short sleeves and drawers to the knees, and shall also have on back and front during competition a distinctive number corresponding to the number in the programme assigned to him by ballot.

4. A competitor who wilfully jostles, runs across, or obstructs another competitor is disqualified from that competition, and forfeits the right to any prize that he would otherwise have been entitled to.

5. The respective stations of the competitors shall be decided by ballot.

In races, the starting position of the competitors is, moreover, decided in the same way immediately before starting, the lowest number being placed on the far left.

6. No attendant shall accompany any competitor on the arena or during the race; nor shall any competitor be allowed, without the permission of the judges, to receive assistance or refreshment from anyone during the progress of a race. This rule applies also to the Marathon Race.

7. Only acting officials and those who are taking part in a competition actually in progress may remain in the arena of the Stadium.

Running and Walking.

I. GENERAL RULES.

a) All races shall be started by the report of a pistol.

All questions concerning the start shall be decided by the starter.

When on the mark, no competitor shall touch the ground in front of the scratch-line with any part of his body.

b) The running track shall be measured 30 cm. from the inside edge.

c) The direction of running will be against the sun, left hand inside.

II. SPECIAL RULES.

100 and 200 metres Flat.

The start shall be made on the following words of command: "*Intag Edra platser*" (On your marks!); "*Färdiga*" (Ready!), and then, when all are quite in order, the pistol shall be fired.

In the first round, those coming in first and second in each heat shall be allowed to run in the second round. In the second round, which consists of six heats, the winners only shall have the right to start in the final.

When the signal has been given to begin the competition, and the runners in each heat are assembled at the start, the orderly ("ordningsman") shall at once see that lots are drawn for the various lanes on the track (special celluloid tubes shall be used for this purpose). Each runner gives the said orderly the number he has drawn, and the competitors in each heat shall be so placed that the runner who has drawn the lowest number shall be stationed on that part of the track which lies farthest to the left, and so on. Immediately after lots have been drawn by the competitors in one heat, the orderly shall ask for the return of the celluloid tubes, for the purpose of using them again in the drawing of lots for the next heat.

When the pistol has been fired, the heat must not be run a second time unless:

1. The starter sees that he fired after one or more of the competitors had crossed the line too soon, or

2. one competitor *purposely* hinders another competitor.

The track-judge shall decide in each special case whether a runner who has hindered another competitor, has done so intentionally or unintentionally.

If a protest is admitted, the heat in question shall be re-run by all the competitors with the exception of the one that wilfully hindered the other competitor.

400 and 800 metres Flat.

The first and second men in each preliminary heat are qualified for the semi-final. In the 400 metres race, the winner in each semi-final is entitled to start in the final and in the 800 metres race the three best men in each semi-final are entitled to start in the final.

When the signal has been given to begin the competition and the runners in each heat are assembled at the start, the orderly ("ordningsman") shall at once see that lots are drawn for the various lanes on the track (special celluloid tubes shall be used for this purpose). Each runner gives the orderly the number he has drawn, and the runners in each heat shall be so placed that the runner who has drawn the lowest number shall be stationed on that part of the track which lies farthest to the left, and so on.

Immediately after lots have been drawn by the competitors in one heat, the orderly shall ask for the return of the celluloid tubes, for the purpose of using them again in the drawing of lots for the next heat.

The orderly, immediately after lots have been drawn, shall order the functionaries at the notice-board to put the number of the heat highest up, and, under this, the numbers of the runners from left to right, in the order in which they are to stand in accordance with the lots drawn. The orderly shall also see that the numbers are fastened to the right trouser-leg of the competitors.

When the pistol has been fired, the heat must not be run a second time unless:

1. The starter sees that he fired after one or more of the competitors had crossed the line too soon, or

2. one competitor *purposely* hinders another.

The track-judge shall decide in each special case whether a runner that has hindered another competitor, has done so intentionally or unintentionally.

If a protest is admitted, the heat in question shall be re-run by all the competitors with the exception of the one that wilfully hindered the other competitor.

1,500, 5,000 and 10,000 metres Flat.

The first and second men in each preliminary heat of the 1,500 metres are qualified for the final. In the 5,000 metres, the first three in each preliminary heat, and, in the 10,000 metres running and the 10,000 metres walking races, the first 5 in the preliminary heats shall be allowed to start in the final.

When the signal has been given to begin the competition and the runners in each heat are assembled at the start, the orderly ("ordningsman") shall at once see that lots are drawn for the various courses on the track (special celluloid tubes shall be used for this purpose). Each runner shall give the orderly the number he has drawn, and the competitors in each heat shall be so placed that the runner who has drawn the lowest number shall be stationed on that part of the track which lies farthest to the left, and so on.

Immediately after lots have been drawn by the competitors in one heat, the orderly shall ask for the return of the celluloid tubes, for the purpose of using them again in the drawing of lots for the next heat.

When the pistol has been fired, the heat must not be re-run unless:

1. The starter sees that he fired after one or more of the competitors had crossed the line too soon, or
2. one competitor *purposely* hinders another competitor.

The track-judge shall decide in each special case whether a runner that has hindered another competitor has done so intentionally or unintentionally. A competitor who wilfully hinders another competitor shall be excluded from the competition, so that, if the incident happens in a preliminary heat, the offender shall not have the right to take part in the final, even if he has otherwise qualified for it and if the incident takes place during the final, the offender shall not be awarded any prize which he would otherwise have gained.

Marathon Race.

a) The Marathon Race will be run on a high-road, with start and finish in the Stadium.

b) Each competitor must send with his entry a medical certificate of fitness, and must further undergo a medical examination, immediately previous to the start, by the Swedish Olympic Committee's official doctors, who pass the competitors or advise them not to start.

c) No competitor, either at the start or during the progress of the race, may take any so-called drugs, on pain of immediate disqualification.

Hurdle Race, 110 metres.

On every course there shall be 10 hurdles, 1,06 metres high, with a distance between each flight of 9,14 metres.

The top rail of the hurdles shall be fixed fast to the upright supports.

The distance from the scratch mark to the first hurdle shall be 13,72 metres, from the last hurdle to the winning post 14,02 metres.

In the first round, the first two in each heat shall be allowed to run in the second round. In the final there shall run the 6 competitors who have won the six intermediate heats.

When the signal has been given to begin the competition, and the runners in each heat are assembled at the start, the orderly ("ordningsman") shall at once see that lots are drawn for the various courses on the track (special celluloid tubes shall be employed for this purpose). Each runner gives the orderly the number he has drawn, and the runners in each heat shall be so placed, that the runner who has drawn the lowest number shall be stationed on that part of the track which lies farthest to the left, and so on.

When the pistol has been fired, the heat must not be re-run unless:

1. The starter sees that he fired after one or more of the competitors had crossed the line too soon, or
2. one competitor *purposely* hinders another.

The track-judge shall decide in each special case whether a runner who has hindered another competitor has done so intentionally or unintentionally.

Walking Race, 10,000 metres.

The competitors shall be divided into 2 heats, the best 5 from each heat taking part in the final.

Each judge of the course has the right to decide whether a competitor is walking fairly or not, and can, without any previous warning, exclude a competitor from further participation in the competition.

The rules for correct (fair) walking are:

"The tips of the toes of the rear foot shall not be lifted from the ground before the instant that the heel of the front foot touches it. The legs shall be extended at each step taken, and the body shall be carried erect."

In other respects the same regulations shall apply as those in force for long distance running.

Relay Race, 400 and 1,600 metres.

The course shall be divided into four parts, each 100 metres long (in the case of the 1,600 metres' race, each part shall be 400 metres long). Unless the baton is carried by the members of the various relays from start to winning-post, the running of the team in question will not be valid, in addition to which, the baton must be passed on within a distance of 20 metres, which is marked with chalked lines.

In the first round, the winning team is allowed to run in the second round, and the three winning teams in the second round shall take part in the final. This rule just stated is for the 400 metres' relay race. In the case of the 1,600 metres' relay race, the winner in each heat shall be entitled to take part in the final. There are only 3 teams in the final. The composition of the team must not be changed after a trial heat has been run.

When the signal has been given to begin the competition, and the first runners of each team in each heat are assembled at the start, the orderly ("ordningsman") shall at once see that lots are drawn for the various courses (special celluloid tubes shall be used for this purpose). Each runner gives the orderly the number he has drawn, and the runners in each heat shall be so placed that the first runner who has drawn the lowest number shall be stationed on that part of the track which is farthest to the left and so on.

Immediately after lots have been drawn, the orderly shall ask for the return of the celluloid tubes, for the purpose of using them again in the drawing of lots for the next heat.

When the pistol has been fired the heat must not be re-run unless:

1. The starter sees that he fired after one or more of the competitors had crossed the line too soon, or
2. one competitor purposely hinders another.

The track-judge shall decide in each case whether a runner who has hindered another competitor, has done so intentionally or unintentionally. If it has been done wilfully, then the entire team to which the offender belongs is disqualified. A team is also disqualified if the baton has been handed over outside of the 20 metres' limit (i. e. a runner must not run to meet the bearer of the baton to a greater distance than to the limit-line which is marked).

In the case of the 400 metres' relay race, separate lanes are marked out by strings. In the case of the 1,600 metres' relay there is one track, common to all the teams competing in the heat.

Team Race, 3,000 metres.

The competition shall be divided into trial heats and a final race.

The start shall be simultaneous.

5 men may run in each team, the first 3 men of each team to count. The team having the lowest aggregate of points will be declared the winner.

In the event of a tie, the total time taken by the scoring three of each team shall decide.

Cross-Country Race.

a) The race will be over country of varying character on a course unknown to the competitors, to be marked out with red ribbons immediately before the start.

b) The start and finish will be in the Stadium.

c) The start shall be simultaneous.

(This does not apply to the Cross-Country Race in the Modern Pentathlon, in which the competitors start singly, at intervals of 1 minute.)

Jumping.

SPECIAL RULES.

Running High Jump.

The competitors shall be divided into three groups.

The competition shall start at a height of 160 centimetres and, at the tries, the bar shall be raised successively in accordance with the following scale.

160 cm.
170 »
175 »
180 »
183 »

and, after this, by a further 2 cm. at each try. Three jumps are allowed at each height, and a failure at the third attempt shall disqualify.

A competitor may commence at any height he chooses above the minimum height, but having done so, he must jump at every following height until he fails in three jumps and thus forfeits his right to continue.

A wooden bar will be used for the cross-piece.

Neither a "saltomortal" nor a flying leap over the bar shall be permitted. By a "saltomortal" is meant a somersault over the bar, and by a flying leap, a jump over the bar, head and hands first, with the breast towards the bar, so that the upper part of the body comes to the ground first.

As soon as a competitor has made a spring upwards in order to jump, this will be counted as a try. If the competitor passes under the bar without having made a spring, this will not count as a jump, but three runs will be regarded as a full try.

All measurements shall be made perpendicularly from the ground to the upper side of the bar where it is lowest.

If two or more competitors tie at a jump in the finals, their order shall be decided by a re-jumping.

All employment of weights is forbidden.

The final competition, which shall take place the following day, and in which shall compete all who have cleared 183 cm., or such lower height as the leader of the competition may specially determine, shall be carried out in accordance with the same scale, with the exception, however, that the bar can be placed at other heights if *all* the competitors so desire. Trial jumps shall not be permitted.

The jumpers shall be allowed to mark the take-off at pleasure, but they shall be obliged to remove the take-off mark they have made, immediately after they have jumped.

If it is necessary to have re-jumping for the purpose of determining the order of the prize-winners, the tie shall be determined by means of a fourth, extra jump.

If both or all the competitors in question clear the bar, this shall be raised; if both knock down the bar, it shall be lowered to the previous height, to be once more raised if this height be cleared. If the new height be cleared by all the competitors in question, the bar is raised still more, and so on, but only the result reached in the ordinary competition shall be recorded as the official figure.

If a competitor does not come on the field before the competition has begun, he has the right to compete, but he must begin at the height the other competitors were jumping at, or had just jumped at, when he presented himself.

Standing High Jump.

The competitors shall, if necessary, be divided into three groups.

The competition shall start with the bar at a height of 130 cm. and, after each try, the bar shall be raised successively in accordance with the following scale:

130 cm.
135 »
140 »
145 »
148 »

and thereafter, by a further 2 cm. after each try.

Three jumps are allowed at each height, and a failure at the third attempt shall disqualify.

A competitor may commence at any height he chooses above the minimum height, but, having done so, he must jump at every following height until he fails in three jumps, and thus forfeits his right to continue.

A wooden bar will be used for the cross-piece.

Neither a "saltomortal" nor a flying leap over the bar shall be permitted. By a "saltomortal" is meant a somersault over the bar, and by a flying leap, a jump over the bar, head and hands first, with the breast towards the bar, so that the upper part of the body comes to the ground first.

As soon as a competitor has made a spring upwards in order to jump, this will be counted as a try.

All measurements shall be made perpendicularly from the ground to the upper side of the bar where it is lowest.

If two or more competitors tie in the finals, their order shall be determined by re-jumping. All employment of weights is forbidden.

As soon as the competitor has made himself ready to spring, the following will be reckoned as a *full try*:

1. If the *right* foot is *lifted twice* from the ground,
2. If the *left* foot is *lifted twice* from the ground,
3. If *each* foot in succession is *lifted once*,
4. If the *right* foot is *slid twice* along the ground,
5. If the *left* foot is *slid twice* along the ground,
6. If *each* foot in succession is *slid once* along the ground,
7. If the *right* foot is *lifted once*, and the *left* foot is *slid once*,
8. If the *right* foot is *slid once*, and the *left* foot is *lifted once*,
9. If the *right* foot is *lifted once* and is *slid once*,
10. If the *left* foot is *lifted once* and is *slid once*.

The finals will be held immediately and, if two or more groups had been formed, those competitors are now brought together into the final who, at the various competing places, have cleared 150 cm., or a lower height if this should prove to be necessary.

If it is necessary to have re-jumping for the purpose of determining the order of the prize-winners, the tie shall be determined by means of a fourth, extra jump. If both or all the competitors in question clear the bar, it shall be raised; if both knock down the bar it shall be lowered to the previous height, to be once more raised if this height be cleared. If the new height be cleared by all the competitors in question, the bar shall be raised still more, and so on, but only the result reached in the ordinary competition shall be recorded as the official figure.

If a competitor does not come on to the field before the competition has begun, he shall have the right to compete, but he must begin at the height the other competitors last jumped at, or were jumping at, when he presented himself.

Running Broad Jump.

The competitors shall be divided into groups, each of 15 men.

Before the beginning of the competition, the orderly ("ordningsman") shall call over the names of all the competitors in every group.

The length of the run is unlimited.

The competitor shall be allowed three jumps, and the three competitors who have obtained the best results shall be allowed three more jumps. The best of each man's six jumps shall determine the order of the three competitors.

If any competitor crosses the taking-off line and touches the ground in front of it with any part of his foot, or if he swerves to the side at the taking-off line, this jump shall not be measured, but shall be counted against the competitor as one jump.

The jump shall be measured at right angles from the outside edge of the taking-off line to the nearest spot where any part of the competitor's body has touched the ground.

After the groups have finished their jumps, those three competitors that have gained the best results shall at once go on to the final. If, after the conclusion of the first rounds, two or more competitors tie for the 3:rd place, those who have made jumps of the same length shall make another jump, and the result of this extra jump shall decide which of these competitors is to take part in the final. If, in the extra jump as well, some of the competitors should tie, another extra jump must be made.

Each competitor is allowed one trial jump. This shall be made before any jump is made in the competition, and the competitors shall, preferably, execute this trial-jump in the order in which they are to compete.

The competitors shall have the right to mark the taking-off place by means of marks in the run, but these marks must be removed immediately after each competitor has made his jump. If a competitor is not present when the judge calls his name in that order in which it stands on the programme, the judge shall call his name once more after a slight pause. If the competitor does not present himself when his name is thus called the second time, he shall lose his right to take part in that turn.

Standing Broad Jump.

The competitors shall be divided into groups of 15 men each.

As soon as the competitor has made himself ready to spring, the following shall be reckoned as a *full try*.

- If the *right* foot is *lifted twice* from the ground,
- If the *left* foot is *lifted twice* from the ground,
- If *each* foot in succession is *lifted once*,
- If the *right* foot is *slid twice* along the ground,
- If the *left* foot is *slid twice* along the ground,
- If *each* foot in succession is *slid once* along the ground,
- If the *right* foot is *lifted once* and the *left* foot is *slid once*,
- If the *right* is *slid once* and the *left* foot is *lifted once*,
- If the *right* foot is *lifted once* and is *slid once*,
- If the *left* foot is *lifted once* and *slid once*.

Each competitor shall be allowed three jumps, and the three competitors that have obtained the best results shall be allowed three more jumps. The best of each man's six jumps shall determine the order of the three competitors.

The jump shall be measured at right angles from the outside edge of the taking-off line to the nearest spot where any part of the competitor's body has touched the ground.

After the groups have finished their jumps, those three competitors who have gained the best results shall at once go on to the final. If, after the conclusion of the first rounds, two or more competitors tie for the 3:rd place, those who have made jumps of the same length shall make another jump, and the result of this extra jump shall decide which of these competitors is to take part in the final. If some of the competitors should tie in the extra jump as well, another extra jump must be made.

Hop, Step and Jump.

The competitors shall be divided into groups of 15 men each.

Only jumps with alternate feet will be counted.

The length of the run is unlimited.

If when changing feet, the free foot should happen to touch the ground, the jump will still be reckoned.

Each competitor shall be allowed three jumps, and the three competitors who have gained the best results shall be allowed three more jumps. The best of each man's six jumps shall determine the order of the three competitors. Ties in the hop, step and jump of the greatest length shall be decided by a new jump until a decision is reached. The results of these deciding jumps is only of importance as deciding the order in which the competitors who had tied are to be placed.

If any competitor crosses the taking-off line, and touches the ground in front of it with any part of his foot, or if he swerves to the side at the taking-off line,

this jump shall not be measured, but shall be counted against the competitor as one jump.

The jump shall be measured at right angles from the outside edge of the taking-off line to the nearest spot where any part of the competitor's body has touched the ground.

After the groups have finished their jumps, those three competitors who have gained the best results shall go on at once to the final. If, after the conclusion of the trial rounds, two or more competitors tie for the 3:rd place, those who have made jumps of the same length shall make another jump, and the result of this extra jump shall decide which of these competitors is to take part in the final. If some of the competitors should tie in the extra jump as well, another extra jump must be made.

Each competitor is allowed one trial jump. This shall be made before any jump is made in the competition, and the competitors shall, preferably, execute this trial jump in the order in which they are to compete.

The competitors shall have the right to fix their leap by means of marks in the run, but these marks must be removed immediately after each competitor has made his jump. If a competitor is not present when the judges call his name in the order in which it stands on the programme, the judge shall call his name once more after a slight pause. If the competitor does not present himself when his name is thus called the second time, he shall lose his right to take part in that turn.

Pole Jump.

The competition shall begin with the bar at a height of 300 centimetres, and, after each try, the bar shall be raised successively in accordance with the following scale:

300	cm.
320	»
340	»
350	»
360	»

and, thereafter, by a further 5 cm. after each try.

The competitor is allowed to mark the taking-off place as he likes, but he must remove the mark he may thus make, immediately after the execution of his jump.

All those who clear 365 cm. are entitled to take part in the final.

If it is necessary to have re-jumping for the purpose of determining the order of the prize-winners, the tie shall be determined by means of a fourth extra jump. If both or all the competitors in question clear the bar, this shall be raised; if both knock down the bar, it shall be lowered to the previous height, to be once more raised if this height be cleared. If the new height be cleared by all the competitors in question, the bar is raised still more, and so on, but only the results reached in the ordinary competition shall be recorded as the official figure.

If a competitor does not come on to the field before the competition has begun, he shall have the right to compete, but he must begin at the height the other competitors were jumping at, when he presented himself, or the height next above that.

Three jumps are allowed at each height, and a failure at the third attempt shall disqualify.

A competitor may commence at any height he chooses above the minimum height, but, having done so, he must jump at every following height until he fails in three jumps and thus forfeits his right to continue.

As soon as a competitor has made a spring upwards in order to jump, this will be counted as a try. If the competitor makes a run without a spring upwards, this shall not be counted as a jump, but three such runs shall be counted as a full try.

A competitor has the right to use a hollow to help him in jumping. Neither at the moment when a competitor makes the jump, nor after he is in the air, may he place the lower hand above the upper one; neither may he shift the upper hand higher up the pole.

A competitor has the right to use his own poles. These may have bindings round them, but no further support for the hands is allowed.

A wooden bar shall be used for the cross-piece. All measurements shall be made perpendicularly from the ground to the upper side of the bar where it is lowest.

Throwing.

I. GENERAL RULES.

a) Only implements provided by the Swedish Olympic Committee shall be used in the throwing competitions.

b) Each competitor shall be allowed three throws, and the best three shall throw again three times (with either hand, according to the class of competition); the farthest throw of the six throws (with the right and the left hand) shall decide the order between the three. In the case of a tie, another, deciding throw must be made. (In competitions with the right and the left hand, such additional throws shall be made with both hands.) The result of the additional throwing shall determine the position only of those who have thrown again.

c) A throw is counted as a trial, but without being measured, when the competitor touches the ground outside the outer part of the throwing circle, with any part of his body before the throw has been marked by the proper official, or if the competitor passes over the taking-off limit with any part of his body.

(By the taking-off limit is meant the inner edge of the marked scratch-line.)

II. SPECIAL RULES.

Javelin Throwing.

The javelin shall be of wood with a sharp iron point. It shall be 800 grammes (1.6 lbs.) in weight, and 2.6 metres (8.5 feet) in length.

About the centre of gravity of the javelin there shall be a binding 16 cm. (6.3 inches) broad. No thongs or notches, nor any other hold than the above mentioned binding shall be permitted on the javelin or the hand, and the javelin shall be gripped round the binding with the whole hand.

The throw shall take place from behind a scratch line consisting of a wooden bar of at least 10 cm. (3.9 inches) in width and c:a 3 cm. (1.18 inch) in thickness, securely fastened to the ground. The run is unlimited in length.

The throw must be executed with the hand gripping round the binding, and no other method of holding is permitted.

No throw shall be scored from, in which the point of the javelin does not strike the ground before any part of the shaft does.

The throw shall be measured at right angles from the spot at which the point of the javelin struck the ground first, to the scratch-line, or to the scratch-line produced.

In the competition in throwing the javelin with both right and left hand, the right-hand throw shall be made first.

The competitors shall be divided into groups of 15 men each.

No trial throw shall be allowed.

As "past the line" shall be reckoned when a competitor, touches the ground in front of the scratch line with any part of his body, before the throw has been marked; but a fault is also committed if a competitor steps on the outer edge of the scratch line, or if, the competitor touches the outer edge of the scratch line with his fingers or hands, etc., after the cast has been made.

As soon as a throw is completed, the orderly ("ordningsman") shall warn the next competitor to be ready when the judge calls his name. If the competitor is not present when the judge calls his name in the order in which it stands on the programme, his name shall be once more called by the judge. Should the competitor not present himself at this second call, he has lost his right to take part in that turn.

Throwing the Discus.

The discus shall be 2 kilogrammes (4.4 lbs.) in weight, and 22 centimetres (8.7 inches) in diameter; thickness in the middle, 45 mm. (1.77 inches); thickness at the rounded off edge, 22 mm. (0.86 inch).

The discus shall be thrown from a circle of about 2.5 metres (8.2 feet) diameter.

All throws, to be valid, must fall within a 90° sector marked on the ground.

All throw will be measured from the point at which the discus first strikes the ground to the centre of the circle, after which the distance is reckoned from the taking-off limit.

In the competition with both right and left hand, the right-hand throw shall be made first.

The competitors shall be divided into groups of 15 men each.

No trial throws shall be permitted in the ring.

If the competitor is not present when the judge calls his name in the order in which it stands on the programme, his name shall be once more called by the judge. Should the competitor not present himself at this second call, he has lost his right to take part in that turn.

As "past the line" shall be reckoned when a competitor touches the ground in front of the front half of the ring or hoop with any part of his body before the throw has been marked, but it is also a fault if the competitor steps on the outer edge of the ring or hoop, either in the front half or, when taking a run, in the back half, or if the competitor steps over the ring when the start is being made, or if, after the throw has been made, the competitor touches the outer edge of the front part of the ring with his fingers or hands, etc. The thrower thus has, the right when he has regained his balance, to leave the ring backwards immediately after the throw is completed.

Throwing the Hammer.

The hammer consists of a massive leaden head provided with a shaft of steel wire and one or two triangular handles. The whole length of the hammer, including the head, shall be 1.22 metres (4 feet), and its complete weight 7.25 kilogrammes (15.9 lbs.).

All throws shall be made from a circle of 2.13 metres (7 feet) diameter.

A throw shall not be scored from unless it falls within a 90° sector marked on the ground.

The competitors shall be divided into groups of 15 men each.

As "past the line" shall be reckoned when a competitor touches the ground in front of the front half of the ring or hoop with any part of his body before the throw has been marked, but it is also a fault if the competitor steps on the outer edge of the ring or hoop, either in the front half or, when taking a start, in the back half, or if the competitor steps beyond the ring or hoop when the start is being made, or if, after the throw has been made, the competitor touches the outer edge of the front part of the ring or hoop with his fingers, or hands, etc. The thrower has thus the right, when he has regained his balance, to leave the ring backwards immediately after the throw is completed.

Putting the Weight.

The weight is massive and of iron; its weight shall be 7.25 kilogrammes.

The put shall be made from a circle of 2.13 metres diameter.

The weight shall be put from the shoulder with one hand, and must never be brought behind the shoulder.

A throw shall not be scored from unless it falls within a 90° sector marked on the ground.

In the competition with both right and left hand, the right-hand put shall be made first.

The competitors shall be divided into groups of 15 men each.

No trial puts shall be permitted in the ring.

As "past the line" shall be reckoned when a competitor, touches the ground in front of the front half of the ring or hoop with any part of his body before the put has been marked; but it is also a fault if the competitor steps on the outer

edge of the ring or hoop either in the front half or, when taking a start, in the back half, or if the competitor steps over the ring or hoop when the start is being made, or if, the competitor touches the outer edge of the front part of the ring with his fingers or hands, etc. after the put has been made.

The thrower has, thus, the right, when he has regained his balance, to leave the ring backwards immediately after the put is completed.

As soon as a put is completed, the orderly ("ordningsman") shall warn the next competitor to be ready when the judges call his name. If the competitor is not present when the judge calls his name in the order in which it stands on the programme, his name shall be once more called by the judge. Should the competitor not present himself at this second call he has lost his right to take part in that turn.

Combined Competitions.

Pentathlon.

The competition comprises the following events: *Running Broad Jump; Throwing the Javelin* (with the javelin held in the middle), best hand; *200 metres Flat Throwing the Discus*, best hand, and *1,500 metres Flat*. The events, will succeed each other in the order just given.

Three tries are allowed both in jumping and in throwing.

In the 200 metres flat race, groups of three men are formed by lot. If the number of runners is such that, after the groups have been arranged, one man is left to run alone, then one man shall be drawn by lot from among the other competitors, to run against him.

All compete in the first three events, in each of which the winner shall receive 1 point, the second man 2 points, and so on.

The total points of the competitors are now counted, and the best twelve, i. e. those with the lowest number of points, shall have the right to compete in the Discus Throwing. If the counting of the points result in a tie for the twelfth place, all such may start in the Discus Throwing competition.

Points are counted according to the result obtained, and, in the event of a tie, the competitors will not compete in order to decide the tie. Thus, if two or more obtain the best result, these two each receive the point 1, and the next man is given the point 3, and so on.

The points of the competitors entitled to compete in the Discus Throwing shall then be counted again with reference to their relative order in each of the first three series, their points being counted as if they alone had competed, and without any reference to the placing of the other competitors. The Discus Throwing and 1,500 metres Flat are now started, with the points thus awarded.

After the Discus Throwing, the best six compete in the 1,500 metres Flat race, in which the start is simultaneous.

If more than one tie for the sixth place after the Discus Throwing, all such may compete in the 1,500 metres Flat race.

In the Flat races, each competitor's time shall be taken with three watches.

The winner shall be the one who, on the completion of the 1,500 metres Flat race, has obtained the *lowest* total points in the five competitions.

If, at the end of the competition, two or more of the competitors have obtained the same number of points, their respective positions shall be determined by the valuation of their results in accordance with the Decathlon Table.

The broad jump, javelin throwing and discus throwing are arranged according to special rules, but in the event of two or more reaching the same figures, the competitors will not compete again to decide the tie

In the 200 metres Flat, 3 men shall start in every heat. The time of each runner is taken separately. If two or more competitors in different heats have the same time, they shall be given the same point. If two or more competitors in the same heat get the same time, but one of them comes in a fractional distance in front of the other(s), the one(s) behind shall receive $\frac{1}{2}$ point more than the one who had the same time but passed the tape a little distance ahead. If the third man, too, in the heat has the same time, but is about a decimetre be-

hind the winner, he, like the second man, will have as his point $\frac{1}{2}$ point added to the point given to the winner. If in the final, the second and third men reach the same number of points, then the "second man" shall be entitled to be placed before the "third man".

Decathlon.

The competition comprises the following events; *100 metres Flat*; *Running Broad Jump*; *Putting the Weight*, best hand (on the first day); *Running High Jump*; *400 metres Flat*; *Discus Throwing*, best hand; *Hurdle Race 110 metres* (on the second day); and *Polk Jump*; *Throwing the Javelin* (with the javelin held in the middle) best hand; and *1,500 metres Flat* (on the third day).

All the competitions will take place in the order given.

Both in the 100 metres and the 400 metres Flat races, as well as in the Hurdle race, 3—4 competitors will start in each group. In the 1,500 metres Flat race, all the competitors will start at the same time, but the leader of the competition shall have the right to alter this determination should it be necessary to do so. The composition of the groups shall be determined by lot.

The winner shall be the one who, on adding together the points in the several events, has reached the *highest* number of points.

For a result similar to the best result obtained at previous Olympic Games, 1,000 points will be awarded. Lower results are valued in accordance with a special table. If a result exceeds the best "Olympic" result, correspondingly higher points will be awarded.

— - - -

TUG-OF-WAR.

GENERAL REGULATIONS.

1. The competitions will be arranged by the Olympic Sub-Committee for the Tug-of-War.

2. The competitions shall be confined to amateurs in accordance with the following definition:

An amateur is one who has never:

- a) competed for a money prize or a monetary consideration, or in any way drawn pecuniary gain from the exercise of his sport;
- b) competed against a professional;
- c) taught in any branch of athletics for payment;
- d) sold, pawned, hired out, or exhibited for payment any prize won in a competition.

Special Rules.

a) The *rope* shall be of such a length as to allow of a "pull" (free space in the middle of the rope extending from the central tape as far as to the outer coloured tapes mentioned below) of 3.5 metres; a "slack" of 3.5 metres at each end, and a space of 1.25 metres for each competitor in the teams. The rope shall be at least 10 centimetres in circumference, and shall have no knots or other holds for the hands.

A coloured tape shall be affixed to the middle of the rope, with two other tapes of another colour fastened, one on each side, at a distance of 1.75 metres from each side of the central tape. Into the ground there is driven a central peg and, in a straight line with, and on each side of this (i. e., in front of it and behind it), two other pegs which are to mark the position of the side-lines, which shall be at right angles to the direction of the pulling and at a distance of 1.75 metres from an imaginary line drawn through the centre peg. At the start, the rope shall be taut, with the central tape over the central peg, and all the competitors shall stand behind the side-lines.

Only such ropes shall be used as are provided by the Swedish Olympic Committee.

b) The *start* shall take place on the following words of command:

"Fatta linan!" (Take Hold!)

"Färdiga!" (Ready!)

"Kör!" (Pull!)

The first position of two opposing teams shall be decided by lot; for the second bout the teams shall change places. Should a third pull be necessary, the positions will again be decided by means of drawing lots.

The pull shall be won by that team that succeeds in drawing its opponent's side-tape over the first-named team's "side-line", or in pulling one member of the opposing team past the central mark.

No competitor shall wear boots or shoes with sharp, projecting sides or points of any kind whatsoever. No kind of spiked shoes or boots shall be used, nor may the soles have any kind of projecting additions.

Heel-irons are permitted on the shoes or boots, but they shall be so sunk in the heel that the bottom of the heel on the boot or shoe shall be perfectly smooth and hard.

All foot-gear (shoes and boots) shall be submitted to the approval of the leader of the competition before the beginning of the competition.

Holes in the ground shall not be made before the start.

c) The *pulling* shall take place with the front side of the body turned towards the opposing team and with the rope under the arm; the body shall not be turned from this front position to such a degree that the line of the shoulders passes beyond an imaginary line parallel to the rope. Some exception to this latter rule may be made for the "anchor", however.

The "anchor" may hold the slack of the rope in any way he pleases, as long as it is not knotted round his waist.

Turning is not permitted.

A competitor shall not wilfully touch the ground with any part of his body except the feet.

From the moment the final word of command is given, both the feet of a competitor may not leave the ground at the same time.

d) No team shall have the right to be captained during the competition by any leader not forming one of the team.

e) There shall be an interval of 5 minutes between the different bouts taking place in one and the same competition between two teams. A team which has already competed shall not take part in a fresh competition before the expiration of 30 minutes after its last pull.

f) The competitions shall take place in such a manner that all the teams shall meet each other.

In each heat, that team shall be the victor which has won two pulls.

g) The competitions shall take place on sandy ground.

CYCLING.

REGULATIONS FOR THE COMPETITION.

The competition will be arranged by the Olympic Sub-Committee for Cycling appointed by the Svenska Velocipedförbundet (Swedish Cyclists' Union), and will conform to the rules for the Championships of the World laid down in June 1907 by the Union Cycliste Internationale.

The start will be from Liljeholmsbron in Stockholm on Sunday, July 7th, at 2 a. m. (the night between Saturday and Sunday), and all competitors must be present at the roll call not later than 1 a. m. No competitor may leave the starting place without special permission.

Before starting, each competitor will have to undergo a medical examination by the doctors officially appointed by the Swedish Olympic Committee.

The order of starting will be decided by lot.

The competitors will start singly at intervals of three minutes.

The competitors, both at start and finish, may be assisted only by persons authorized by the Committee (so-called attendants).

Each competitor shall wear, both on the back and in front, the number assigned to him by lot.

Pacing is strictly forbidden during the competition, and no person will be allowed to accompany any competitor. Refreshments must only be given by persons on foot.

Any competitor who has manifestly been paced or has intentionally interfered with the progress of another competitor, or has not passed the control stations, will be disqualified. Moreover, any offence against these rules involves disqualification.

Whilst riding, the competitors shall keep to the *left* and, by duly sounding their bell in good time, warn anybody approaching.

At the control stations, all of which must be passed, and which are marked (with red rings) on the map on the back of these rules, there will be official controllers wearing blue and yellow arm-badges. The stations are: Södertelje, Läggesta, Strengnäs, Eskilstuna, Kungsör, Köping, Kolbäck, Vesterås, Enköping, Bålsta, and Jerfva.

At these control stations, refreshments will be provided gratis to competitors, as well as the help necessary for cleaning and repairing the machines; any information required will also be given.

At some of these control stations, the competitors will have to prove their identity by their signatures.

If a competitor retires from the competition, he must immediately give notice to that effect to the nearest control station, and take away his number. If a competitor makes a stop, he must re-start from the same place where the stop was made.

On arrival at the finish, which is in the Stadium, one lap of the track shall be ridden round to the right. The time will be taken immediately before beginning of the said lap.

Only competitors, officials concerned, and attendants will be allowed in the arena of the Stadium.

Notice: Reserve machines, if so desired, can be left at the control stations; in such a case, the machines must be delivered to the Committee at least 4 days before the competition.

FENCING.

RULES FOR THE COMPETITIONS.

General Rules.

Every competitor by the fact of his entry agrees to accept the rules in force. Ignorance of these rules and of any later additions will not be accepted as an excuse for any contravention of the rules for the Tournament.

Only amateurs are qualified to compete, or to be members of the jury, or to be organisers of the Tournament.

Any one who is an amateur according to the laws of his own country will be recognized as such.

The Amateur qualification must be confirmed by a certificate from the Amateur Fencing Association or, failing this organisation, by the Olympic Committee of the competitor's own country, who shall be responsible for its validity.

Any fencer who, within one year after these games, shall be proved to have infringed the rules for Amateurs, shall be disqualified, and all the prizes that he has gained must be returned to the Committee, who may award them to another competitor. The disqualification of one member of a team disqualifies the whole team.

The Swedish Committee will not pay any expenses of the competitors or jurors in this tournament.

There is no entrance fee; all entries must be made in writing (*entries by telegram will not be accepted*) before June 6 1912, by the Olympic organisation of the respective country on official note-paper and provided with a certificate testifying that those who have entered are amateurs.

The competitors must observe the following conduct in respect to the jurors:

Complaints or observations must be made with due courtesy.

The decision of the Jury must be accepted absolutely.

The competitors bind themselves on their honour to fight all bouts to a finish unless physically prevented, and to fence in such a manner as to obtain the best possible place. Any agreement made by the fencers with the object of altering the result of a pool can lead to their disqualification.

If a fencer withdraws or is disqualified, or is unable to continue the contest, the result of all his previous contests shall be deleted from the score-sheet as if they had never existed, but, if the fencer had been a Winner, before retiring owing to reasons acceptable to the president of the jury, he will retain his winning points, even if all the subsequent assaults were counted as defeats.

No fencer may change his weapon from one hand to another during the action of an assault, except in case of an accident acknowledged by the Jury, but he is allowed to make different attacks with different hands.

As a rule no rest will be allowed during an assault.

If a competitor (or a team) appointed to fence in a pool does not make an appearance at the instance of the President, his name will be scratched from that part of the Tournament. He shall not be replaced and the other competitors will reap the benefit of his absence.

An objection or claim can be made by any competitor in the individual competitions, and by the captains of teams. It must be made in writing by a member of the National Olympic Committee, not later than one hour after the contest, to the International Jury of Honour, whose decision shall be final.

The Weapons and their employment.

The weapons must be of an orthodox known model and satisfy the conditions mentioned below. All abnormally-made weapons may be refused by the Committee for Fencing. The weapons may be mounted in the French or Italian style or in a similar manner.

The foil; blade, 900 mm. max.

If the open guard is used, it must be protected with leather so as not to catch the button of the adversary's blade;

cup-guard, max. diam. 132 mm. (no part of the mounting may extend beyond the edge of the guard);

hilt, including pommel 220 mm. max.;

total length of the weapon 1,100 mm. max.;

total weight between 400 and 700 gr.

The épée: triangular or lozenge blade, 900 mm. max.;

guard max. diam. 132 mm. (no part of the mounting may extend beyond the edge of the guard);

convexity to 50 mm.;

eccentricity 35 mm. max.;

total length of the weapon 1,100 mm. max. (not including the *pointe d'arrêt*).

Hilt, including the pommel 220 mm. max.;

total weight of the weapon between 470 and 770 grammes.

The triple *pointe d'arrêt* alone is permitted. It must present an effective projection at 2 mm. max. It shall be arranged by the fencers themselves conformably to the regulation pattern and subject to the approval of the Jury.

The sabre: Blade, 900 mm. straight or curved, with an arc not greater than 40 mm. Hits can be scored with the point, with the edge which extends along the whole side of one edge of the blade, and for 20 centimetres from the point along the other side.

The guard must be sufficiently large to protect the hand and the wrist; max. dimension towards the back and the edge of the blade 150 mm.; and towards the flat of the blade (perpendicular to the edge) 140 mm. It must not have any perforation in which the point of an adversary's sword can become entangled.

Hilt 220 mm. max.;

total length of the weapon 1,100 mm. max.;

total weight of the weapon; between 470 and 770 grammes;

The weapon (foil, épée, sabre) may be attached to the hand, on the condition that the system employed presents no obstacle to an opponent's fencing.

The weapon must not be held so as to increase the effective length of the blade by placing the hand farther off from the guard. The extremity of the thumb when fully extended must not be more than from 2 to 3 centimetres from the guard, and the pommel must not be held in the hollow of the hand.

Dress.

The clothes must be absolutely protective against accidents.

The *vest* and the trousers must be white, or of a very light colour.

The *thigh piece* is de rigueur for the épée and sabre.

Any sort of *boots* may be worn, but they must not have any projections on the soles.

The *mask* must be strong and well padded for the sabre; without throat-piece for the foil and, if there is one for the other weapons, this must also be as small as possible.

Any *gloves* of a very light colour; for épée, without hard arm-shield; for the sabre, well padded.

All parts of the body exposed to attack must be properly protected.

Each fencer must wear his national colours on his unemployed arm. He will likewise wear the armet, indicating his individual number in the pool, which armet will be handed to him on the occasion.

The Ground.

All the competitions will take place indoors, and on pistes of linoleum.

Each competitor will have 15 m. space behind him, counting from the back foot, in which to retreat if necessary.

The ground gained by an adversary is kept. When a fencer reaches the line 3 metres from the limit, he is warned by the President of the jury by the words "Trois metres". He is warned again at the moment when he arrives at the limit by the word "Limite". The limit will, in case of necessity, be indicated by a large white line. If, after this warning, the fencer passes the limit with both feet a hit will be scored against him. The position of each fencer on the ground is decided by lot before the commencement of each bout, and will be changed after each heat.

ORGANISATION OF THE CONTESTS.

Constitution of the Juries and their functions.

The Jury and President on accepting office engage morally to act with courtesy and unquestionable impartiality.

There will be an International Jury of Honour and competition juries.

The Jury of Honour will be chosen by the Swedish Olympic Committee of the Olympic Games of Stockholm, 1912 and can be international. It constitutes the last court of appeal in all points of dispute which may arise during the tournament. Its decision is final. It will receive, through a member of the Fencing Committee, the objections or claims made in writing, examine the question and give the verdict.

The competition juries are international.

The National Olympic Committees of each competing nation will be requested to nominate, before the 6 June (with the entries of the competitors) 3 or 4 of their countrymen whom they deem competent to serve on competition juries, and who are willing to act as jurors.

The Swedish Committee will form a sufficient number of competition juries, each consisting of 5 (3) members, one of whom will act as president.

Each pool jury will have a Swedish Secretary, not a member of the jury, to keep the scoring sheet.

The composition of the Jury will be uniform for all contests.

The juries are responsible for the proper conduct of all the pools which they are called upon to direct.

The President will act as leader of the contest, direct the passes, and has alone the right to give the warnings of "Trois metres" and of "Limite"; he will observe exactly the different phases in order to be able to analyse them and determine, in case of need, which of the competitors has first been hit; and to this end he can employ any means of investigation he considers necessary; he can stop any bout in which he considers that the proper character of a contest is endangered.

The Jurors will be placed according to the following figure:

Jurors and the fencer on the left.

Jurors and the fencer on the right.

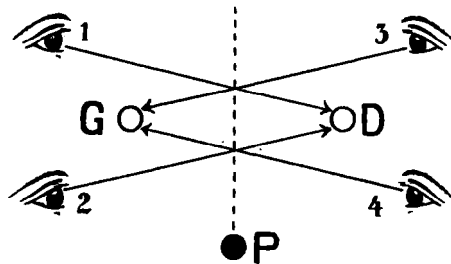

Whenever one of the jury thinks that he sees a hit, he must immediately call out 'Halte'. When 'Halte' has been called, the President shall loudly ask both the jurors, Nos. 1 and 2 on the left and them only if D, on the right has been hit, and then those on the right, 3 and 4, and them only, if G, on the left, has been hit, commencing with the one who has called "Halte". This double question must always be put by the president, whatever his own opinion regarding a hit may be. In any case, jurors 1 and 2 on the left will not have the right to voluntarily express an opinion if G, the fencer on the left, has been hit, since they have to watch fencer D on the right; but, very exceptionally, in case of doubt, as, for example, a forward hit, the President may consult them. The same remarks shall apply to jurors 3 and 4 on the right, in reference to the fencer D on the right.

The jurors on the left must not forget that, generally, one of them can see the whole of the left side of the fencer D on the right, while the other sees the whole of the right side, and that only the front portion of the body can be seen by both. They must be very careful not to refuse a hit noticed by one of them which cannot be seen by both of them at the same time. If they have not seen anything they must abstain. The same observations apply to jurors 3 and 4 in regard to the fencer G on the left. To the successive questions by the President, Is D hit? ("D est-il touché?") "Is G hit?" ("G est-il touché?"), the jurors shall reply loudly 'Yes' (Oui), 'No'(Non), or 'I abstain' (Je m'abstiens) without any explanations, unless the President puts an additional question.

If one of the jurors says Yes (Oui), the other No (Non), the President, whose duty it is principally to watch the course of the combat as a whole and no fencer in particular, in order to judge clearly the simultaneousness of the hits, may, however have seen the hit made; he will in such a case divide the jury, but he will give his opinion last. If he does not do so, the fencer will have the benefit of the doubt, and be declared as not hit; but in order that his opponent may not suffer from this doubt, if the latter be hit at the same time or later, the last named hit will like wise be cancelled and the combat will recommence.

If one of the jurors says 'yes' while the other, not having seen the hit, says 'I abstain' (Je m'abstiens), and if the President cannot pronounce an opinion, the fencer is declared hit. As a rule, if there is a doubt, the fencer has the benefit of it without his opponent suffering. If one of the jurors abstains, the opinion of the other shall decide.

If jurors 1 and 2 on the left declare the fencer D on the right, hit, and jurors 3 and 4 on the right declare the fencer G on the left, hit, the President must immediately ask if there was any remise, and, if so, which hit was first. He then shall ask jurors 1 and 2, on the left, to point out the exact spot where the fencer D on the right was hit, by putting their fingers on the spot touched, and to indicate the slope of the body at the precise moment when the hits were made. (Difference of length of line.) The same questions shall be put to jurors 3 and 4, on the right, regarding the fencer G on the left. Then the President will communicate to the 4 jurors the results of their replies regarding the time and length of line. Since, on the other hand, though the jurors are directed to watch only one fencer, they may have been able to form an exact impression regarding the time of the hits received and given, the only course for the President will be to take the jurors' votes, beginning with the youngest. He himself will vote last. He will then ask "Is it a coup double?" and, should he receive a negative reply, "Which one is hit".

The Jury will be invested with plenary powers for the observance of these rules- It will have the right, after giving one warning, to disqualify anyone not conforming to these rules.

CONSTITUTION OF THE POOLS.

A. In the individual Competitions.

The pools are: eliminating;
semi-finals;
final.

Eliminating pools; no pool shall consist of *more* than 8 fencers and no more than 4 fencers shall pass out of it into the next round.

The exact number of fencers who are to take part in a pool, shall, if necessary, be decided by the Swedish Fencing Committee.

In a succeeding round, only those who have done best in the preceding eliminating pools shall compete.

Final pool. The eight best in the semi-finals shall compete in the final.

Division of the Competitors in the pools.

The fencers will be so arranged in the eliminating- and semi-final pools, that, *representatives of each nation shall, as far as possible, fence against those of other nations.* This placing will be decided by lot. Each fencer in a pool will be designated by a number, drawn by lot, and the order of the bouts will be as follows:

For a pool of four (4):

(1) 1-4	(2) 2-3	(3) 1-2	(4) 3-4
(5) 2-4	(6) 1-3		

For a pool of five (5):

(1) 1-4	(2) 2-3	(3) 4-5	(4) 1-2
(5) 3-5	(6) 2-4	(7) 1-5	(8) 3-4
(9) 2-5	(10) 1-3		

For a pool of six (6):

(1) 1-4	(2) 2-5	(3) 3-6	(4) 1-5
(5) 2-6	(6) 3-4	(7) 1-6	(8) 2-3
(9) 4-5	(10) 1-2	(11) 3-5	(12) 4-6
(13) 1-3	(14) 2-4	(15) 5-6	

For a pool of seven (7):

(1) 1-4	(2) 2-5	(3) 3-6	(4) 1-7
(5) 5-4	(6) 2-3	(7) 6-7	(8) 1-5
(9) 3-4	(10) 2-6	(11) 5-7	(12) 1-3
(13) 4-6	(14) 2-7	(15) 3-5	(16) 1-6
(17) 2-4	(18) 3-7	(19) 5-6	(20) 1-2
(21) 4-7			

For a pool of eight (8):

(1) 1-5	(2) 2-6	(3) 3-7	(4) 4-8
(5) 1-6	(6) 2-7	(7) 3-8	(8) 4-5
(9) 1-7	(10) 2-8	(11) 3-5	(12) 4-6
(13) 1-8	(14) 2-5	(15) 3-6	(16) 4-7
(17) 1-2	(18) 3-4	(19) 5-6	(20) 7-8
(21) 1-3	(22) 2-4	(23) 5-7	(24) 6-8
(25) 1-4	(26) 2-3	(27) 5-8	(28) 6-7
			$n (n-1)$

For a pool of n..... 2

For scoring, official scoring sheets of the following appearance shall be employed

Scoring sheet.

Individual competition with foils.	Eliminating Pool No.
» » » épée.	Semi-final » »
» » » sabre.	Final » »
Mod. Pentathlon, épée.	x = defeat; o = win
	x = coup double.

Nation	Name	No.	Counter No.								No. of Wins	Placing
			1	2	3	4	5	6	7	8		
		1	■									
		2		■								
		3			■							
		4				■						
		5					■					
		6						■				
		7						■		o		
		8							x	■		

President.

Secretary.

The result of each assault is marked by the signs:

(x = defeat; o = win.)

x = coup double.

In the contests in which there are several hits, each hit received is marked by a line as well.

Example: Nos. 7 and 8 meet in the foils, where the contest is decided by five hits. No. 8 receives three hits from no. 7 and hits him 5 times. See the method of scoring on the above scoring sheet.

A tie will be decided by one hit.

The placing is determined by the number of wins, or, should these be equal, by the number of hits received.

B. In the Team Competitions.

The captain is responsible to the Swedish Olympic Committee and to the President of the Jury for the proper behaviour of his team. He will select the four fencers to compete in each pool. Only in case of a serious accident acknowledged by the Jury can a fencer be replaced by another during the same pool.

Each team will be designated by a number drawn by lot.

The teams will fight in the order laid down for individual contests.

In the pool competition with two teams, the members of the team bearing the lowest number, will be numbered from 1 to 4 and the members of the other team from 5 to 8. These numbers will be distributed by the captains. The captain will hand to the President of the Jury in due time, before each pool, a list of the names and numbers of his fencers who are to take part in the pool.

He alone is authorized to make any necessary claims on behalf of the members of his team.

The order of the assaults will be the following:

- | | | | |
|----------|----------|----------|----------|
| (1) 1-5 | (2) 2-6 | (3) 3-7 | (4) 4-8 |
| (5) 1-6 | (6) 2-7 | (7) 3-8 | (8) 4-5 |
| (9) 1-7 | (10) 2-8 | (11) 3-5 | (12) 4-6 |
| (13) 1-8 | (14) 2-5 | (15) 3-6 | (16) 4-7 |

The Scoring Sheet will be on the following plan:

Scoring Sheet.

Competition for épée teams.
 » » sabre »

x = defeat.
 o = win.
 x = coup double.

Team (Nation)	Name	No.	Counter No.								Wins of each fencer	Wins of the team	Placing
			1	2	3	4	5	6	7	8			
}		1										}	
		2											
		3											
		4											
}		5										}	
		6											
		7											
		8											

President.

Secretary.

The result of each assault is marked by the signs:

x = defeat; o = win.
 x = coup double.

In the contests with several hits, each hit received is marked by a line as well. See the scoring sheet, on the preceding page.

In each contest between two teams, the winning team shall be the one which has the fewest number of hits registered against it. As soon as one team has had nine points scored against it, it is defeated and the Captain may withdraw if he pleases, but he has the right to complete the series if he desires to do so.

In a contest between two teams, when the number of hits is equal they shall fight their series again with the same men, until one team has established its superiority.

Contests.

General Rules.

Only the hits made neatly and cleanly will be counted.

The thrust must hit with the point.

The cut must hit with the edge; a cut which hits the body but which, at the same time, clearly strikes the guard is not counted.

Places where the hits are counted.

With the foil; the trunk from the collar-bone to the line of the hips.

If a fencer, by adopting an ungainly position, unduly effaces the target in exposing irregularly another portion of the body, or instead of parrying, covers his chest with his arm, hand or head, the hits on these parts will be counted.

With the sword and the sabre; the whole body; all the limbs and the head; that is to say everywhere.

The competitors will be placed against each other standing straight, the arm extended, point to point. They take back guard and will commence on the double command of the President:

1) En garde!
 Take guard!

2) Allez messieurs!
 Go!

On the command "Halte", the competitors must immediately stop. Any hits given after the command have no value. A hit given to a fallen or disarmed ad-

versary has no value if the fencer has had time to recognize that an accident has happened.

The *Corps à corps* will be stopped by the President.

It is a *corps à corps* when the fencers are in actual bodily contact, or when one of the fencers ceases to parry only with his weapon and defends himself with any part of his body.

The *corps à corps* must not be confused with the combat *rapproché*, which is allowable.

It is forbidden to hinder the action of an opponent's weapon with the arm or hand or to make use of the unemployed arm and hand for parrying.

Special rules for the contests with foils.

The combats shall be carried out according to the fencing rules.

The attacker must take cover.

The receiver of an attack must first parry.

The coup double is the movement which most damages the art of fencing.

A fencer who, either by not parrying or not completing the phrase, thereby produces a 'coup double', has a hit scored against himself alone.

In case of an initial movement of aggression at the same instant, the 'coup double' is not counted.

If, in a case of this kind, one of the simultaneous hits is made on a prohibited part of the body, this hit is not counted unless the jury should be firmly persuaded that the prohibited portion was not deliberately aimed at, or exposed intentionally.

The *stop-hit* (*coup d'arrêt*) is a *counter-attack* made upon the opponent's preparation to attack, or upon a feint. If a player who attempts to make a stop-hit, hits his adversary and is himself untouched, or if he hits his opponent an appreciable interval of time before he is himself touched, the hit is in his favour. If he is hit simultaneously (*coup double*), the hit is in favour of his opponent.

The *time-hit* (*coup de temps*) is a *counter-attack* made with opposition upon the opponents' attack in such a way that it parries the attack on which it is made. A time attack is valid only if the player who attempts it remains absolutely untouched, and in case of simultaneous hits, the hit is against the fencer who delivers the time hit.

The *redoublement* is the renewal of an attack, immediately after the first, made either in the same line or otherwise.

Its aim is to profit by the disorder caused by the first attack on an opponent who has parried without a riposte, or who has avoided a hit by retreating.

In the first case the second attack is preceded by a reprise of the backward guard, in the second case by a forward guard.

The *Reprise d'attaque* is an attack made, without retrieving, after an adverse parade not followed by a riposte.

In the case of a riposte directe (*à temps perdu*) if the reprise d'attaque result in the coup double, the resulting hits are invalid (simultaneous attacks).

The *remise* is a time hit, made after the development, and without retrieving, on a riposte composée. It is practiced also after an insufficient parade and which is not followed by a riposte.

a) In the case of a riposte composée, if the remise results in the coup double, the riposte alone is valid (time hit).

b) If there is a remise on the immediate riposte, only the riposte is valid.

When the two fencers are hit simultaneously — three cases can arise:

1st. The attacker alone may be declared hit.

2nd. The defender » » » » » »

3rd. A hit may be counted against neither.

That is to say: 1:0 The attacker is at fault and the hit is against him:

a) If he runs on the point of his opponent, with his arm naturally extended against him, without having attacked so as to make the blade deviate from the line.

b) If, on attempting an attack on the blade, he is deceived but continues his attack.

- c) If he tries to parry a stop-hit (coup d'arrêt) and does not succeed, but nevertheless continues his attack.
 - d) If in the execution of a feinte he meets his opponent's blade and, notwithstanding his opponent's riposte, continues the attack.
 - e) If he makes a remise on the immediate riposte of his opponent.
- 2:0 The defender is at fault and the hit is against him:
- a) If he makes a stop-hit on a simple attack.
 - b) If he makes a time hit, but without cover.
- 3:0 Both are at fault and no hit is scored:
- a) In the event of a simultaneous attack.
 - b) If one of the combatants makes an attack composed of several feints, without covering himself, and the other, after having attempted to parry the first feints, risk a stop-hit.
 - c) If, in the case of a riposte à temps perdu, the reprise occurs simultaneously.

Special rules for the Épée and Sabre Competitions.

The rules given above, which were drawn up for the foil competitions, are also applicable to the épée and sabre contests as regards the reconstruction of the phrase d'armes, whereby a hit results.

This reconstruction of the phrase and of the thrust is not solely to determine, as in the foil assaults, which of the two opponents is right or wrong from a fencing point of view, but to permit the determination of the relative successive positions of the opposing épées at different moments of the decisive phrase of the contests, in order to be able to determine as clearly as possible the following two factors: the difference in time between the hits, and the varying lengths of the lines of attack.

It must then be considered, not only as a purely theoretical dissertation, but also as a means of study of the sole practical result which the judges may have to consider; the coup de pointe for the sword, the coup de pointe and de taille for the sabre.

But since experience shows that the coups doubles (simultaneous hits) are relatively infrequent in the serious contests, and as, in any case, it is almost impossible to decide on the simultaneousness of the two hits, this result — a "Coup double" — always forms a doubtful case.

For this reason the judges must by every possible means, i. e.;

- by reconstructing the phrase d'armes;
- by determining the relative positions of the opposing weapons;
- by determining the distance;

endeavour to establish the difference of time between the two hits.

They then vote to determine which fencer has been hit first, or if there is a coup double.

In the case of a coup double, each of the fencers is considered hit.

FOOTBALL.

SPECIAL RULES.

1. The competition shall be under the control and management of the Sub-Committee for Football appointed by the Swedish Football Association. The Committee's decision on all matters relating to the competition shall be final and without appeal. The Committee shall appoint Referees and Linesmen in all matches.

2. The competition shall be played according to the rules and regulations of the Swedish Football Association, which correspond to the Laws of the Game as promulgated by the Federation Internationale de Football Association.

The competition shall be confined to amateurs in accordance with the following definition.

a) An amateur player is one who has never:
Competed for a money prize, or received any remuneration or consideration of any sort above his necessary hotel and travelling expenses actually paid in connection with football matches;

b) Engaged in, assisted in, or taught in any branch of sport as a means of pecuniary gain;

c) Been registered as a professional;

d) Sold, pawned, hired out, or exhibited for payment any prize won in a competition.

3. Each National Football Association belonging to a nation recognized as such by the International Olympic Committee and affiliated to the International Football Federation (Federation Internationale de Football Association) is entitled to send four teams.

4. The competition shall be conducted in the following manner.

The competing teams shall be drawn in couples. These teams shall compete, and the winners shall be drawn again in couples, and so on, until the competition is completed.

5. Each team shall compete in its National Association colours. Where the colours of the two competing teams are the same, one of the teams shall play in such colours as may be determined by the Swedish Sub-Committee for Football.

6. Players of each team may be changed during the series of matches.

7. The duration of a match shall be one hour and a half.

8. Should a match result in a draw, an extra half hour shall be played. Should the match result in a draw after it has been played for two hours, it must be re-played as the Committee may determine.

9. The dimensions of the field of play shall be: length 115 yards (105 metres, breadth 75 yards ($68\frac{1}{2}$ metres).

10. Laws of the Game. The laws to be followed will be those fixed by the Fédération Internationale de Football Association for the season 1911/12.

GYMNASTICS.

GENERAL REGULATIONS.

1. The competitions will be arranged by the Olympic Sub-Committee for Gymnastics appointed by the Svenska Gymnastikförbundet (Swedish Gymnastic Association).

2. The competition shall be confined to amateurs according to the following definition: —

An amateur is one

- a) who has never, for pecuniary gain, taken part in an open competition or display;
- b) who has never taken part in a competition with money prizes;
- c) who in all other respects is an amateur according to the rules of his own country.

Gymnastic teachers and leaders, even though they receive payment as such, are regarded as amateurs.

3. The judges for Competition I will be appointed by the Sub-Committee for Gymnastics. The judges for Competitions II and III and IV will be selected in such a way that each nation competing in Competitions II or III or entering at least 5 men in Competition IV, has the right to appoint *one* judge. The name, title, and address of such judge shall be sent in to the Swedish Olympic Committee before *May 1st, 1912*.

In case of sufficient judges not having been selected before the above-mentioned date, the Sub-Committee for Gymnastics will complete the number.

4. All competitors who do not appear at the place of competition at the time fixed in the programme forfeit their right to take part.

5. Any gymnast leaving his team without the permission of a judge shall forfeit his right to return to the team.

6. No gymnast shall be allowed to replace another during the course of the competition.

7. The Gymnasts must conform to the directions of the judges.

8. Cases of illness, indisposition or injury occurring during the competitions shall be immediately reported to the judges and confirmed by the official doctors.

9. Protest against the admission of any gymnast to the competition shall be made before the commencement of the competition, or immediately on an occasion arising. (See paragraph 13 "Olympic Games: General Regulations".)

SPECIAL RULES.

I. Team Competition with Exercises according to the Swedish system.

1. Exercises.

The competing team must execute a complete set of exercises (day-table). Each member of the team must execute every movement.

2. Apparatus.

The following apparatus on the Swedish model will be placed at the disposal of the competitors:

- 4 beams (double);
- 20 ribbstalls (stall-bars), available from both sides, thus enabling 40 competitors to perform simultaneously ;
- 2 inclined ropes;

- 24 vertical ropes;
- 2 horses with adjustable legs;
- 3 plinths (vaulting-boxes);
- 1 buck with adjustable legs;
- 6 benches with balance-bar and movable hooks;
- 8 beam-saddles.

Planks for the run and take-off will be at hand, and may be used if desired. Platforms and Spring-boards may not be used.

3. Programme.

Each competing team may arrange its own programme as regards the various movements.

Six type-written copies of the complete programme for the competition must be sent in, together with the entry, under registered cover, bearing the following heading: "Programme de Contours de Gymnastique I".

The programme, which will not be shown to anyone except the respective judges, may be written in Swedish, Norwegian, Danish, English, French or German.

4. Dress.

All the members of a team must be dressed alike.

5. Time.

The time allowed to each team for the march-in, the execution of the various exercises and the march-out is, 1 hour.

6. Judges.

The judges shall be five in number, and each shall award points independently; during the competition they shall not consult with each other about the judging, and immediately on the conclusion of each competition, shall send in their protocols, duly signed, to the Sub-Committee for Gymnastics.

7. Principles for Judging.

Each judge shall award points, from 0 (minimum) — 15 (maximum), for each of the groups mentioned below.

Each group has a fixed coefficient, which, multiplied by the number of marks, shall decide the points of each group.

The points obtained by the groups shall be added together.

Groups comprised in the plan of judging.

	Marks	Coefficient	Max. points
Introductory exercises	0—15	5	75
Archflexions	»	8	120
Heaving movements,	»	7	105
Balance movements	»	4	60
Shoulder-blade movements	»	6	90
Abdominal exercises,	»	6	90
Marching and running	»	7	105
Lateral trunk movements,	»	7	105
Vaulting	»	7	105
Concluding exercises	»	4	60
Evenness and precision	»	8	120

Total 1,035

Each judge will keep his own protocol.

The average of the totals of the five protocols will decide the result of the team competition.

Should the programme include several exercises or movements of the same group, except in the introductory and concluding groups, separate marks will be awarded for each exercise.

The average of marks awarded for movements of a similar nature will be multiplied by the coefficient of the group.

Defective exercises will be counted and judged with the movement which they complete.

The individual competitor's manner of moving in exercises of translation will be counted and judged with the exercise, in connection with which such movement takes place.

Evenness and precision comprise: uniformity, attention, and correctness of execution by all the members, correct time and rhythm in the different movements, strength and suppleness in the right place.

The judges shall assist in calculating the points for the various teams.

There is no appeal against the decisions of the judges.

II. Team Competition with Exercises according to the conditions stated below.

1. Exercises.

The competing teams shall execute:

- a) a series of free exercises in unison, with or without hand apparatus (such as wands, sticks, dumb-bells, Indian clubs &c.),
- b) a series of exercises on the horizontal bar,
- c) » » » » » » parallel bars,
- d) » » » » » » pommelled horse,
- e) exercises according to the leader's selection, with or without apparatus, but not with those mentioned under *b, c, d*, however.

All the competitors of a team shall perform the same series and *must* execute all the exercises.

Movements on one apparatus shall be completed by the entire team before movements on another apparatus are begun.

2. Apparatus.

The following apparatus will be placed at the disposal of the competitors:

4 *Horizontal Bars.*

(Height of bar 240 cm., length 220 cm., thickness 32 mm.; bar of polished steel.)

4 *Parallel Bars.*

(Parallel bars: height 160 cm., length of bars 3 m., their thickness 45—48 mm., and their distance from each other 42—45 cm.)

4 *Pommelled Horses.*

(Height of horse 130 cm., length 2 m., height of pommels 12—15 cm., distance from each other, 40—45 cm. and their thickness 31—33 mm.)

4 *Pairs of Rings.*

(Round rings, height 240 cm.)

Hand apparatus (such as wands, sticks, dumb-bells, clubs &c.). Other movable apparatus, not mentioned here, must be supplied by the team.

3. Programme.

Each team shall arrange its own programme both for the free exercises and the exercises on apparatus.

Six type-written copies of the complete programme for the competition must be sent in, together with the entry, under registered cover bearing the following heading: "Programme de Contours de Gymnastique II".

The programme, which will not be shown to anyone except the respective judges, may be written in English, French or German.

4. Leader.

Competing teams shall be under the command of a leader who shall not participate in the competition. He can show the free exercises at the team gymnastics and shall command the team. During the execution of the exercises on the apparatus, the leader may keep near the apparatus in order to prevent possible accidents, but must not help in the execution of the exercises. The exercises performed by him are not reckoned and do not affect the points of the team.

The leader's name and profession shall be stated in the entry.

5. Dress.

All the members of a team must be dressed alike. Competitors will not be allowed to modify their dress during the course of a competition.

6. Time.

The time allowed to each team for the march-in, the execution of various exercises and the march-out is 1 hour.

7. Order of rotation.

The order stated in the programme for the divisions *a—c* must be followed.

8. Principles for Judging.

The judges shall be at least 5 in number, and shall officiate at all the competitions, unless prevented by illness or other urgent cause.

The judges shall devote their entire attention to the competitions, and the judges may not undertake any other duties which may cause them to leave the place of competition, or, which place any obstacle in the way of the regular performance of the work.

The judges together form a jury, which shall appoint a president from its number.

The requisite number of officials will be placed at the disposal of the jury by the Sub-Committee for Gymnastics.

When judging, the judges shall each award the points independently, and shall not consult with each other regarding them.

Protocol forms will be supplied by the Sub-Committee for Gymnastics.

The protocols, duly signed, shall be sent in to the Sub-Committee for Gymnastics immediately on the close of the competition. During the competition the judges may not divulge the points awarded by them.

The points will be awarded as follows:

1. *for the free exercises in unison:*

For the carriage of the team: a maximum of 2 points and for execution: 0—10 points comprising;

0	points	for	no	execution
2	»	»	bad	»
4	»	»	moderate	»
6	»	»	satisfactory	»
8	»	»	good	»
10	»	»	excellent	»

These points will be awarded to the whole team once.

2. *competition groups b, c, and d:*

For the carriage of the team:

for the manner of approaching the apparatus: max. 1 point.

» » » » leaving the apparatus: » 1 »

These points will be awarded to the whole team for each of the three stipulated apparatus — or 3 times in all;

for the execution: 0 — 10 points comprising:

0	points for no	execution
2	» »	bad »
4	» »	moderate »
6	» »	satisfactory »
8	» »	good »
10	» »	excellent »

These points will be awarded to the whole team for each of the 3 stipulated paratus — thus 3 times.

3. *for competition group e:*

for execution 0 — 10 points, comprising :

0	points, for no	execution
2	» »	bad »
4	» »	moderate »
6	» »	satisfactory »
8	» »	good »
10	» »	excellent »

These points will be awarded once to the whole team.

The *intermediate points allowed* are: .75, .50 and .25

The *maximum* number of points to be awarded by *one* judge shall be:

1.	for free exercises in unison:	
	» carriage	2
	» execution	10
2.	for exercises on the three apparatus prescribed <i>b, c and d:</i>	
	for carriage and for manner of moving to and from the apparatus:	
	2 points × 3 apparatus	6
	for execution :	
	10 points × 3 apparatus	30
3.	for exercises under <i>e:</i>	
	for execution	10
	total maximum: 58 points	

The judges shall assist in calculating the points for the various teams. The average of the total sums of the protocols shall decide the result of the team competition.

There is no appeal against the decisions of the judges.

III. Team Competition with free choice of Movements and Apparatus.

1. Exercises.

The competing team shall itself select the movements.

2. Apparatus.

For details regarding the apparatus, see "Special Rules" I. 2 and II. 2.

3. Programme.

Each team shall arrange its own programme.

Six type written copies of the complete programme for the competition must be sent in, together with the entry, in a registered envelope, bearing the following heading "Programme de Contours de Gymnastic III".

The programme, which will not be shown to anyone except the respective judges, may be written in English, French or German.

4. Leader.

Competing teams shall be under the command of a leader who shall not participate in the competition. He can show the free exercises of the team gymnastics and shall command the team. During the execution of the exercises on the apparatus, the leader may keep near the apparatus in order to prevent possible accidents, but must not help in the execution of the exercises. The exercises performed by him are not reckoned and do not affect the points of the team.

The leader's name and profession shall be stated in the entry.

5 . Dress.

All the members of a team must be dressed alike. Competitors will not be allowed to modify their dress during the course of a competition.

6. Time.

The time allowed to each team for the march in, the execution of various exercises and the march out, is 1 hour.

7. Principles for judging.

The judges shall be at least 5 in number and shall officiate at all the competitions unless prevented by illness or other urgent cause.

The judges shall devote their entire attention to the competitions, and the judges may not undertake any other duties which may cause them to leave the place of competition, or which place any obstacle in the way of the regular performance of the work.

The judges together form a jury, which shall appoint a president from its number.

The requisite number of officials will be placed at the disposal of the jury by the Sub-Committee for Gymnastics.

When judging, the judges shall each award the points independently, and shall not consult with each other regarding these.

Protocol forms will be supplied by the Sub-Committee for Gymnastics.

The protocols, duly signed, shall be sent in to the Sub-Committee for Gymnastics immediately on the close of the competition. During the competition the judges may not divulge the points awarded by them.

Each judge shall award points for the whole team from 0 (minimum) to 25 (maximum).

In judging, notice shall be taken of the execution of the movements, the composition of the programme, and the carriage and attention of the team.

IV. Individual Competition.

1. Exercises.

The competition comprises:

1. Exercises on the horizontal bar
2. » » parallel bars,
3. » » rings
4. » » pommel horse.

2. Apparatus.

For details regarding the apparatus, see Special Rules II. 2.

3. Programme.

Each competitor has the right to arrange his own programme.

4. Time.

Each competitor has 2 minutes at his disposal at each apparatus.

5. Division and order of rotation of the competitors.

The competitors shall be allotted competition numbers by means of the ballot, by which the order of rotation will be decided.

The order determined upon shall be adhered to throughout the competition at all apparatus.

The competitors will be divided into squads of not more than 12 men, and will be led from apparatus to apparatus.

6. Other Regulations.

Immediately on his name being called, the competitor shall stand at attention, at a distance of 2-3 meters from the apparatus and facing it.

At the word of command: "Börja" (Commence), from which moment the time allowed for execution is taken, the competitor shall approach the apparatus and carry out his programme.

Having performed his turn, the competitor shall again stand at attention at the apparatus and, on the command of the judge, shall retake his place in the team.

Competitors are not allowed to change their dress in any way during the competition.

7. Principles for Judging.

There shall be three judges at each apparatus. Each judge shall award the points independently, and shall not consult with his colleagues regarding the points.

Immediately after a squad has gone through its programme at an apparatus, the judges' protocols, duly signed, shall be sent in to the Sub-Committee for Gymnastics.

During the competition the judges may not divulge the points awarded by them. Points will be awarded at each apparatus in the following manner:

For the manner of approaching the apparatus: max. 1 point.

For the manner of leaving the apparatus: max. 1 point.

For execution: 0 — 10 points comprising:

0	points	for	no	execution
2	»	»	bad	»
4	»	»	moderate	execution
6	»	»	satisfactory	»
8	»	»	good	»
10	»	»	excellent	»

Intermediate points allowed are: .75, .50 and .25

Maximum points to be awarded by a judge:

for manner of moving to and from apparatus:

2 points × 4 apparatus 8 points

for execution: 10 points × 4 apparatus 40 »

total maximum: 48 points

The judges shall assist in calculating the points.

The points awarded by all the judges shall be added together, and the total thus obtained shall be decisive.

There is no appeal against the decision of the judges.

In making their awards the judges shall pay attention to the following points:

- a) difficulty and quality of the exercises performed;
- b) combination;
- c) change of exercises;
- d) style.

Regarding style, attention shall be paid to the following points:

- a) the carriage of the competitor on approaching and leaving the apparatus;
- b) decision and precision;
- c) speed, when so required by the exercise;
- d) precision in clutching, and on changing the clutch;
- e) that the competitor avoids touching the apparatus when not so required by the exercise;

- f) stiffness in the outstretched limbs; arms and legs shall be fully extended if the exercise requires it;
- g) bearing of the head.

A competitor will not be allowed a second attempt in executing an exercise unless all the officiating judges consider that he had been interfered with at the first attempt through no fault of his own.

V. Displays.

Each nation has the right to be represented by one team of men and one team of women.

Apparatus of Swedish model (see Special Rules, 1, 2) and other models, too, (see Special Rules II, 2) will be at the disposal of the competitors.

Teams have the right to bring their own apparatus.

HORSE-RIDING COMPETITIONS.

GENERAL REGULATIONS.

1. The Committee of the Horse-Riding Competitions at the Olympiad of Stockholm in 1912 organises, and is responsible for, the Equestrian Games.

2. The Games are confined to gentlemen riders exclusively; professionals are excluded.

3. The following will be considered the definition of a "gentleman":
for foreign competitors: the definition given in the regulations of the leading Horse-Riding Association of their country;

for Swedish competitors: the Racing Rules of the Swedish Jockey Club. art 88.

4. Maximum number of competitors from each country:

in individual competitions: *six (three reserves)*,

in team competitions and

in combined team and individual competitions: one team of *four*, the first *three* to count (*two* reserves).

5. Competitors are entitled to enter not more than two horses, but are only allowed to ride one horse in each competition.

6. Foreigners wishing to take part in the competitions shall send in their applications through the Olympic Committee of their country — if so desired, through the War Office of their country — to the Swedish Committee of the Horse-Riding Competitions.

7. Entries shall be engrossed or type-written on special forms, provided by the Swedish Committee for the Horse-Riding Competitions. Each form to serve for one competitor and *one* competition only. In the case of teams the names of the competitors should be given together with those of the reserves.

8. Entries close on the 1 June, 1912, for competitors and horses and their reserves.

No entries will be accepted unless they are in the hands of the Committee of the Horse-Riding Competitions before entries close.

Entries by telegram will not be accepted.

9. The Committee for the Horse-Riding Competitions reserves to itself the right to refuse the entry of any competitor, without being bound to give any reason for its decision.

10. Protests against the amateur status of a competitor must be lodged in writing at the earliest possible moment, and be in the hands of the Swedish Committee for the Horse-Riding Competitions not later than the 1 August 1912. Every protest shall be accompanied by a deposit of 20 kronor, which will be forfeited if the protest has been made on unreasonable grounds.

The Committee for the Horse-Riding Competitions shall decide on every protest, after having made the necessary investigations into the matter. The decision of the Committee is final.

11. The Committee for the Horse-Riding Competitions shall decide on every dispute concerning entries, general regulations, arrangements, etc., for the competitions, and its decisions shall be final.

12. The Committee of the Horse-Riding Competitions will appoint a Swedish President of the International Jury of the Horse-Riding Competitions. All protests against competitors or judges shall be referred to this Jury, against whose decision there is no appeal.

Any nation not having appointed a representative of its own on the Jury may be represented by the representative of another country. The names of the several representatives shall be given on the close of entries.

13. Foreign competitors will be accorded the following privileges:

Free transport in Sweden for horses entered for the games, free stabling, forage and veterinary attendance in Stockholm, free board and lodging for one groom.

Furthermore, four competitors from each country — in the first instance those entered for the Military competition — will have their travelling expenses in Sweden paid, as well as full board and residence in Stockholm while the Horse-Riding Competitions last (not exceeding 7 days).

At the expiration of the time for entries, each country shall, through their several Olympic Committees, send in the names of those competitors (and their reserves) who are to enjoy the benefit of the above privileges.

Application for free stabling shall be made at the close of entries, on the 1 June, 1912.

14. The Committee will not undertake any responsibility for accidents or illness which may befall any horse entered for the competitions.

15. The judges will, as a rule, be of Swedish nationality.

For judging the Prize-Riding competition, foreign judges will also be appointed. Further regulations will be issued later.

16. The Committee for the Horse-Riding Competitions reserves to itself the right to make alterations in, and additions to, the programme and regulations.

Propositions.

I.

Military=Competition.

Team competition: One team of not more than four competitors from each country; the first three to count (with not more than two reserves); at the same time *Individual competition.*

Special Regulations.

The competition is open only to officers on the active list (not more than four competitors from any country), riding either horses belonging to their respective armies, or those registered in the army as service horses. Entries to be accompanied by a certificate from the commanding officer of the regiment (principal of the Riding School) to the effect that the horse is a *bona fide* army horse or registered as a service horse.

Horses belonging to the army and attached to Government Riding Schools (not to individual officers) for purposes of instruction are barred.

The competition is divided into five tests and must not be concluded in less than three days. The Committee shall have the right to interpose one or more days of rest between those days on which competitions are held.

Each rider may enter not more than two horses, but can only use one of them, and shall be obliged to ride this one in all the tests. No outside help may be received during the progress of the competition, except in tests 1 and 2, for the purpose of shoeing, veterinary and medical treatment.

1. Long Distance Ride and during its progress:

2. Cross Country Ride.

Undress-Uniform without arms.

Bitting: curb and snaffle.

Saddling optional.

Minimum weight: 80 kilos.

Distance: 55 kilometres; 50 kilometres on the road and, during the latter part of the ride, 5 kilometres on a cross-country course of 5 kilometres, marked out with flags.

Maximum time: For the whole distance, 4 hours, of which 15 minutes will be counted for the cross-country ride of 5 kilometres; shorter time, whether for the whole ride or for the cross-country ride, will not be awarded extra points.

3. Individual Riding over Steeplechase Course.

Undress-Uniform without arms.

Bitting and *Saddling* optional.

Minimum weight: 80 kilos.

Distance: 3,500 metres with 10 obstacles.

Maximum time: 5 minutes 50 seconds; shorter time will not receive extra points.

4. Prize-Jumping Competition.

Undress-Uniform without arms.

Bitting: curb and snaffle.

Saddling optional.

Minimum weight: 80 kilos.

Obstacles: 15 high jumps of not more than 1,3 metres (fixed), the long jumps will not be above 3 metres.

Other conditions according to propositions for the prize-jumping competition of the Olympic Games (III).

5. Prize=Riding Competition.

Undress-Uniform without arms.

Bitting: curb and snaffle.

Saddling optional.

Weight: optional.

To be performed according to the regulations for the prize-riding competition of the Olympic Games (II). Figure 8 at a gallop, change of gallop from one leg to another, obstacle and obedience-test will not be required.

Principles for judging.

1. *Long Distance Ride.* This is to be considered as a test of endurance. Riders who have covered the distance within the maximum time will receive 10 points. For every minute or fraction of a minute in excess of this time, 1 point will be deducted.

2. *Cross-Country Riding.* Each judge will give points for the part of the course under his control, starting from the figure 10, which will be reduced in each case:

for refusing and bolting the first time by 2 points,
» » or » again; falling (the horse
falling), and for being thrown (the rider being
unseated): for each time and obstacle » 5 »

For every period of 5 seconds or fraction thereof in excess of the maximum time, the number of points will be reduced by 2.

Individual Riding over Steeplechase Course. For each obstacle, points will be allowed starting from the figure 10, which in each case of refusing or bolting, falling (of the horse) and of the rider being unseated (the rider falling off his horse) will be reduced by 5 points.

For every second or fraction of a second in excess of the stipulated maximum time, 2 points will be deducted.

4. *Prize-Jumping Competition* (see supplement 1 and 4. To be judged according to the regulations for the Prize-Jumping Competition of the Olympic Games (III).

5. *Prize-Riding Competition.* To be judged according to the regulations for the Prize-Riding Competition of the Olympic Games (II).

Rules for determining the Placing.

After each test the points of each competitor will be added up.

In order to give equal importance to the different tests for the final result, the latter will be determined according to the following principles:

The maximum number of points will be worked out for each test and divided by 10. The number of points of each competitor will then be divided in each test by the number thus obtained for the respective test. This will give a quotient, varying between 10 and 0, which will form the number of points of the respective competitors in the respective tests.

The total sum of the final points in the five tests will be the final number of points of the competitor, and this number will determine the order in the individual competition. The rider obtaining the highest number of points will be placed as No. 1, the one obtaining the next highest number will be placed as No. 2, and so on.

In the team competitions, the nation whose best three competitors have obtained the highest total number of points will be the winner, the nation obtaining the next highest number will be second, and so on.

II.

Prize Riding Competition.

Individual competition, not more than six competitors from each country (reserves not to exceed three).

Special Regulations.

The competition is open to all horses except those belonging to the army and attached to Government Riding Schools (not to individual officers) for purposes of instruction.

Every rider may enter not more than two horses, but may only ride one.

The prize will be awarded to the rider, not to the owner of the horse.

The riding will take place in the Stadium in an open, rectangular court, 40 metres by 20, the sides of which are clearly indicated.

Dress: Officers to wear uniform without arms, others high hat or hunting dress.

Bitting: Curb and snaffle; martingales, or other special reins not allowed.

Saddling: optional.

Programme.

The rider shall enter at a gallop, halt 10 metres in front of, and facing, the judges — salute.

After halting, the horse shall stand still and "at attention" until the signal is given, from which moment the rider is allowed 10 minutes for the performance of the movements specified below, at a walk, trot and gallop.

The horse shall now be walked, trotted and galloped in the order named, each gait in an unbroken succession.

All movements shall be exhibited alike from both sides in all the paces.

The judges will not take into consideration such movements as Passage, Piaffe, Spanish trot, etc.

Holding the reins, optional. When riding and holding the reins principally with one hand, 1 point extra will, however, be added to the number of points given for holding the reins, during the walk and trot collectively; for the same in galloping, 2 points will be added.

The walk (about $1\frac{1}{2}$ minute) shall be free and long-striding.

The trot (about $3\frac{1}{2}$ minutes) shall be ridden both "collected" and "fast". From "collected" trot a halt is made, then backing in a straight line (at least 6 metres at a stretch) and an immediate advance at a "collected" trot; turns, volts and facing-about on the hind-quarters without any previous halt.

The gallop (about 5 minutes) shall be ridden both "collected" and "fast", and the same movements as in the trot shall be displayed, and likewise:

breaking into a gallop from a standstill; figure 8 with a diameter of about eight metres, in which the gallop shall be kept up alternately (left-handed) and changed both ways; change of gallop from one leg to another in a straight line at least four times;

fast gallop, facing-about on hind quarters, fast gallop;

a halt is made from fast gallop, followed immediately by trot.

5 *obstacles* to be taken at a gallop immediately after the performance of the programme.

High jumps: one to be 0.8 metres high, two 1.0 metre and one 1.1 metre.

Long jump: one to be 3 metres wide.

Obedience in the horse and controlling power of the rider will be tested by walking the horse up to, possibly over or through, the object, which has alarmed him. There will be no firing of guns, beating of drums etc.

Principles for Judging.

Each judge shall give points from 0 to 10 for each of the following items:

- 1) The horse's carriage when standing still,
- 2) walking,
- 3) trotting,
- 4) galloping,
- 5) the rider's seat in the saddle,
- 6) handling and management of the reins,
- 7) the movements and ability of the horse to turn,
- 8) jumping and
- 9) the rider's management, exhibition and control of the horse.

The horse shall, in all paces, move smoothly and be well on the bit with a steady head.

In turning, the horse shall be set in the neck and have the trunk bent in the direction of the turn; when turning in the gallop, it shall be set to the right when riding a right gallop, in the opposite case to the left.

When backing, the horse shall be well gathered together.

The rider's seat shall be correct and must show a good, and supple grip of the horse, in unison with the motion of the horse, and without exaggerated movements.

If the rider omit any of the movements stipulated in the programme, 1 point will be deducted. Should such omission be repeated, this will be considered a lack of training and occasion a deduction of 5 points.

The judges are entitled to demand a repetition of any detail of the rider's performance, and an exhibition of any movements that may possibly have been omitted.

In the event of a movement having been omitted, a judge is obliged to point this out to the other judges after the programme has been gone through.

Rules for determining the Placing.

For each performance under the heading of "Principles for judging" (1—9) a *certain number of points* will be allotted.

All these figures will be added together for each competitor in the protocol of each of the judges, by which means the *total number of points* awarded to each competitor will be determined.

After all the competitors have ridden, each judge will receive a summary of his protocols, in which the competitors are placed according to the total number of points by the respective judge. The judge awards *the first place* to the competitor who has obtained the highest number of points, the second to the next one, and so on.

In case of two or more competitors obtaining the same *total number of points*, the judge will decide their respective places according to his impression of the performance of the competitors as a whole.

The rider whom a majority of the judges have placed as No. 1 will be the winner. In case of there not being a majority in favour of any one competitor, the result will be obtained by adding the figures given by each judge, in which case the lowest figure will be declared the winner, the next lowest, second, and so on.

If, in spite of this, the total number of all the points should remain equal for two or more competitors, the total of the points awarded by all the judges to the respective competitors will decide the award of the prizes, in which case the highest number of points will be No. 1, the next one No. 2, and so on. In the event of even such a procedure not giving a decision, the competitors with the same number of points shall draw lots.

III.

Prize=Jumping Competition.

A. *Individual Competition.* Not more than six competitors from each country, (reserves not to exceed three).

B. *Team Competition.* One team of not more than four competitors from each country, the first three to count (reserves not to exceed two).

Special Regulations.

The competition is open to all horses except those belonging to the army and attached to Government Riding Schools (not to individual officers) for purposes of instruction.

Each rider may enter not more than two horses, but may only ride one.

The prizes will be awarded to the rider, not to the owner of the horse.

The prize-jumping competition will take place on an obstacle-course in the Stadium.

Dress: Officers to wear undress-uniform, without arms; others high hat or hunting dress.

Bitting and saddling optional.

Minimum weight: 75 kilos.

Number of obstacles 19 (see supplements 1 and 3). Maximum height 1.4 metres (fixed). The obstacles will have a solid appearance, but will be so constructed that essential portions will give way when struck with force. For judging touches there will be a loose marking lath.

Long jump obstacles not to exceed 4 metres.

Riders to cover the obstacle-course at the rate of 400 metres a minute, which will be timed; less time will not be awarded additional points.

Competitors are not allowed to try the jumps before the competition.

Taking part in a previous competition will not be counted as a trial of the jumps.

Principles for Judging.

Points will be given for each obstacle, starting from the figure 10, which will be reduced in each case:

for refusing and bolting the first time ... by 2 points,
» falling (of the horse), refusing or bolting the second time » 4 »
» refusing or bolting again and falling off (the rider being unseated) » 6 »
and further

in taking the high jumps:

for touching with fore legs by 1 point,
» » » hind » » 1 »
» knocking down the fence with the fore legs » 4 »
» knocking down the fence with the hind legs » 2 »

For touching or knocking down with both fore and hind legs, only the fore legs will be counted.

for long jumps:

if the horse lands with his hind-legs on the limit mark on the far side of the ditch by 1 point,
if the horse lands with his hind-legs inside the limit-mark, or touches the surface of the water with his hind-legs » 2 »

if the horse lands with his fore-legs on the
limit mark on the far side of the ditch by 2 points,
if the horse lands with his fore-legs inside
the limit mark, or touches the surface
of the water with his fore-legs..... ▶ 4 ▶

In the case of combined obstacles the above regulations apply to each one separately.

Each period of 5 seconds or fraction thereof in excess of the maximum time will incur a penalty of 2 points.

Any competitor riding the wrong way or not taking the obstacles in their proper order will be disqualified.

If any alteration in the equipment of the horse takes place during the course of the competition, the rider will not, for this reason, be allowed another try over the obstacles.

No outside help may be made use of in the course of the competition.

Rules for determining the order.

The competitors will be placed in numerical order, according to the *number of points* obtained, and thus the one who has obtained the highest number of points will be placed No. 1, the next one, No. 2, and so on.

In case of two or more competitors obtaining the same number of points, the competition will be continued between them over obstacles 2, 3, 12, 13, 10, and 11, which, in the case of the "Military" competition, will not be increased beyond 1.3 metres, and, in the case of the prize-jumping competition III A and B, not beyond 1.4 metres. In the event of the competitors again reaching the same number of points, the time occupied shall decide who is to be declared the winner. The principles for judging given above shall be in force.

In team competitions, that nation will be declared the winner whose best three competitors have obtained the highest total number of points; the nation that has obtained the next highest number will be second, and so on.

Obstacles used in the Horse Riding Competitions.



No. 1. Hedge.

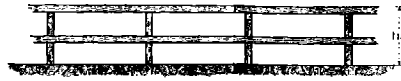

No. 2. Fence.

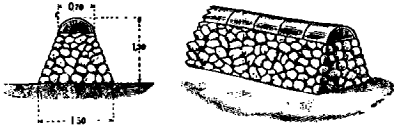

No. 3. Stone-wall.

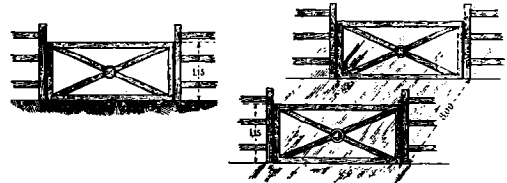

No. 4. Railway-gates.

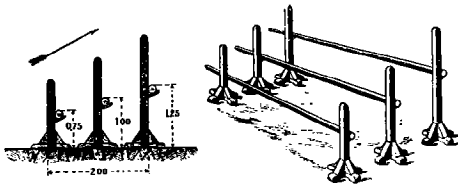

No. 5. Triple bar.

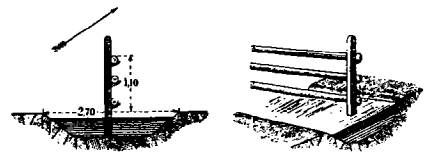

No. 6. Fence in dike.

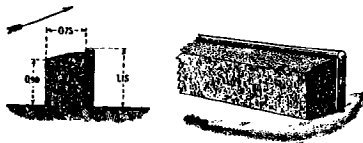
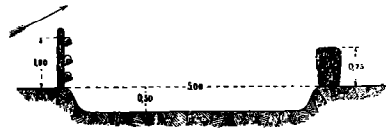

No. 7. Hedge and Top bar.

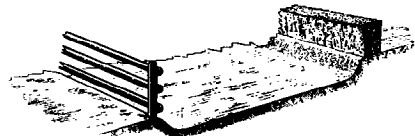

NO. 8. Fence—Dike—Hedge.



No. 9. Fence.

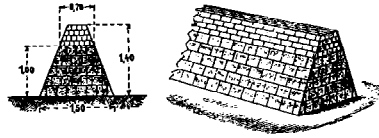

No. 10. Brick-wall.

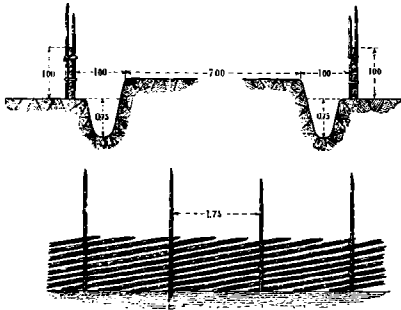

No. 11. Country road. Fence on either side

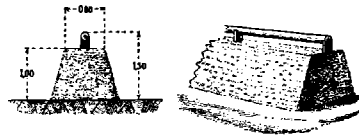

No. 12. Earth-wall with bar.

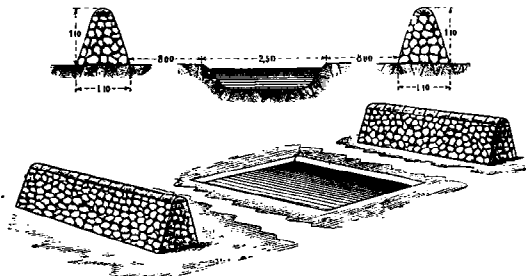

No. 13. Stone-wall—Dike—Stone wall.



No. 14. Bank—Fence.

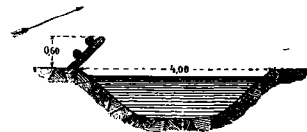

No. 15. Dike.

The "Military".

Prize=Jumping. 15 obstacles.

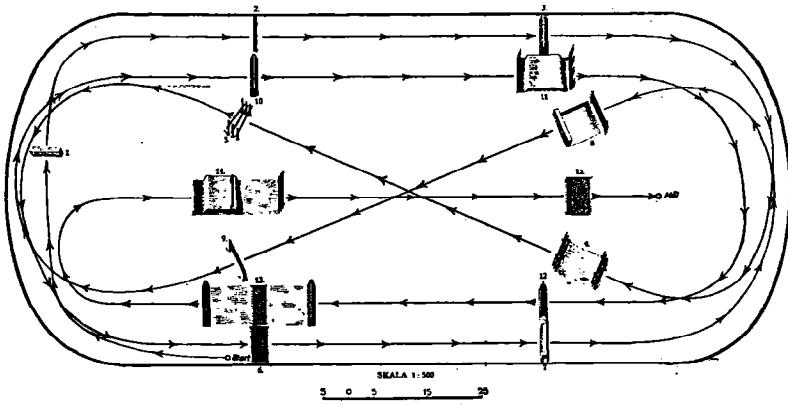

III. Prize=Jumping A and B. 19 obstacles.

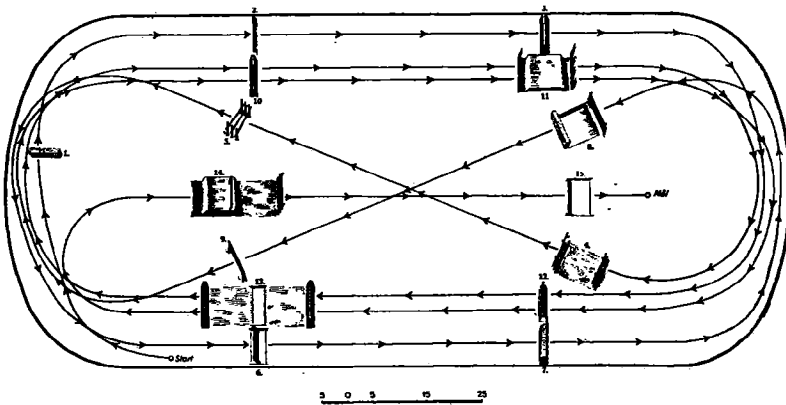

LAWN TENNIS.

GENERAL REGULATIONS.

1. The competitions shall be confined to amateurs in accordance with the following definition.

An amateur is one who has never:

- a) taken up any branch of sport as a profession;
- b) competed in Lawn Tennis competitions or exhibitions, or taught Lawn Tennis for payment or for pecuniary consideration;
- c) sold, pawned, bartered, hired out or exhibited for payment any prize won in a competition;
- d) competed in an open competition with or against a Lawn Tennis Player who was not an Amateur according to these conditions.

2. The competitions will be arranged by the Sub-Committee for Lawn Tennis appointed by the Swedish Lawn Tennis Association, and will conform to the rules and regulations of that Association (which agree with those of the Lawn Tennis Association of Great Britain).

3. The Committee undertakes all arrangements with regard to the judging of the competitions, and will appoint the referee, who may nominate a deputy recognized by the Committee. The referee or his deputy shall have the power to appoint umpires. The referee shall decide all disputes concerning the rules of the game, etc., which are referred to him by the Umpires. The Referee's decision shall be final.

4. The Umpire shall count in the English language.

5. All the matches shall be decided by the best of five sets, with the exception of the singles for ladies and of the mixed doubles, which shall be decided by the best out of three sets.

6. The draw shall be made in the following manner. The name of each competitor shall be written on a separate piece of paper. These pieces of paper shall be put into a bowl or hat, and taken out at random one after the other, after which the names shall be written down on a list in the order in which they were drawn. Every competitor or his representative shall have the right to be present at the draw, which will take place on the first convenient day after entries are closed.

7. If a competitor is absent when it is his turn to play, or refuses to play, or has previously informed the referee or a member of the Committee that he cannot compete, his opponent shall have a walk over.

8. The competitors who have been beaten in the semi-finals shall compete against each other for the third prize.

9. Slazenger's balls shall be used.

LAWS OF THE GAME.

The Single-Handed Game.

For the single-handed game, the Court is 27 feet (8.23 m.) in width, and 78 feet (23.78 m.) in length. It is divided across the middle by a net, the ends of which are attached to the tops of two posts which stand 3 ft. (0.91 m.) outside the Court on each side. The height of the net is 3 ft. 6 in. (1.06 m.) at the posts, and 3 feet (0.91 m.) at the centre. At each end of the Court, parallel with the net and at a distance of 39 ft. (11.89 m.) from it, are drawn the *Base-lines*, the extremities of which are connected by the *Side-lines*. Halfway between the side lines, and parallel with them, is drawn the *Half-Court-line* dividing the space on each side of the net into two equal parts, called the *Right* and *Left Courts*. On each side of the net, at a distance of 21 ft. (6.4 m.) from it and

parallel with it, are drawn the *Service-lines*. The marking of the *Half-court-line* between the *Service-lines* and the *Base-lines* is omitted, with the exception of a small portion at the centre of each *Base-line*.

2. The balls shall not be less than $2\frac{1}{8}$ inches (63.5 mm.) nor more than $2\frac{9}{16}$ in. (65.1 mm.), in diameter; and not less than $1\frac{7}{8}$ oz. (53 gr.) nor more than 2 oz. (65.1 gr.) in weight.

3. In all competitions where an umpire is appointed his decision shall be final, but if a referee is also officiating, the competitors can appeal to him from the decision of an umpire on a question of law, and in all such cases the decision of the Referee shall be final.

4. The choice of sides and the right to be Server or Striker-out during the first games shall be decided by toss, provided that, if the winner of the toss choose the right to be server or striker-out, the other player shall have the choice of sides, and vice versa, and provided that the winner of the toss may, if he prefer it, require the other player to make the first choice.

5. The players shall stand on opposite sides of the net; the player who first delivers the ball shall be called the *Server*, the other the *Striker-out*.

6. At the end of the first game the Striker-out shall become Server, and the Server shall become Striker-out, and so on, alternately, in the subsequent games of the set.

7. The Server shall, before commencing to serve, stand with both feet at rest on the ground behind (i. e. further from the net than) the base-line and within the limits of the imaginary continuation of the half-court and the side-lines, and thereafter the server shall not run, walk, hop or jump before the service has been delivered, but the server may raise one foot from (and, if desired, replace it on) the ground, provided that both feet are kept behind the base-line until the service has been delivered.

8. The Service shall be delivered from the right and left courts alternately, beginning from the right in every game, even though odds be given or owed, and the ball served shall drop within the service-line, half-court-line, and side-line, of the Court which is diagonally opposite to that from which it was served, or upon any such line.

9. It is a *fault* if the Server commit any breach of Law 7, or if the service be delivered from the wrong Court, or if the ball served drop in the net or beyond the service-line, or if it drop out of Court or in the wrong Court. If the Server in attempting to serve, miss the ball altogether, it does not count a fault; but if the ball be touched, no matter how slightly, by the racket, a service is thereby delivered, and the laws governing the service at once apply.

10. A fault may not be taken.

11. After a fault, the Server shall serve again from the same Court from which he served that fault, unless it was a fault because served from the wrong Court.

12. A fault may not be claimed after the next service has been delivered.

13. The service may not be *volleyed*, i. e., taken before it touches the ground, even though the ball be clearly outside the Service Court.

14. The Server shall not serve until the Striker-out is ready. If the latter attempt to return the service, but fail, he loses the stroke. If, however, the Striker-out signify that he is not ready after the service has been delivered, but before the ball touch the ground, he may not claim a fault because the ball ultimately drops outside the Service Court.

15. A ball is *in play* from the moment at which it is delivered in service (unless a fault) until it:

- a) has been volleyed by the Striker-out in his first stroke;
- b) has dropped in the net or out of Court;
- c) has touched either of the players or anything that he wears or carries except his racket in the act of striking;
- d) has been struck by either of the players with his racket more than once consecutively;
- e) has been volleyed before it has passed over the net;
- f) has failed to pass over the net before its first bound (except as provided in Law 17);
- g) has touched the ground twice consecutively on either side of the net, though the second time may be out of Court.

16. It is a *let* if the ball served touch the net, provided the service be otherwise good, or if a service or fault be delivered when the Striker-out is not ready. In case a player is obstructed by any accident not within his control, the ball shall be considered a *let*; but where a permanent fixture of the Court is the cause of the accident, the point shall be counted. The benches and chairs placed around the Court and their occupants, and the umpire and linesmen shall be considered permanent fixtures. If, however, a ball in play strike a permanent fixture of the Court (other than the net or post) before it touches the ground, the point is lost; if after it has touched the ground, the point shall be counted. In case of a *let*, the service or stroke counts for nothing, and the server shall serve again. A *let* does not annul a previous fault.

17. It is a good return:

a) if a ball touch the net or post, provided that it pass over either and drops into the Court;

b) if a ball, served or returned, drop into the proper Court and screw or be blown back over the net, and the player whose turn it is to strike reach over the net and play the ball, provided that neither he nor any part of his clothes or racket touch the net, and that the stroke be otherwise good;

c) if a ball be returned outside the post, either above or below the level of the top of the net, even though it touch the post, and provided that it drop into the proper Court;

d) if the player's racket pass over the net after he has returned the ball, provided the ball pass over the net before being played and be properly returned;

e) if a player succeed in returning a ball, served or in play, which strikes a ball lying in the Court.

18. The Server wins a stroke:

a) if the Striker-out volley the service, or fail to return the service or the ball in play (except in the case of a *let*);

b) if he return the service or ball in play so that it drop outside any of the lines which bound his opponent's Court;

c) if he otherwise lose a stroke, as provided by Law 20.

19. The Striker-out wins a stroke:

a) if the Server serve two consecutive faults;

b) if the Server fail to return the ball in play (except in the case of a *let*);

c) if the Server return the ball in play so that it drops outside any of the lines which bound his opponent's Court;

d) if the Server otherwise lose a stroke, as provided by Law 20.

20. Either player loses a stroke:

a) if the ball in play touch him or anything that he wears or carries, except his racket in the act of striking, or if he volley the ball (unless he thereby makes a good return), no matter whether he is standing within the precincts of the Court or outside them;

b) if he touch or strike the ball in-play with his racket more than once consecutively;

c) if he or his racket, in his hand or otherwise, touch the net or any of its supports while the ball is in play;

d) if he volley the ball before it has passed the net.

21. On either player winning his first stroke, the score is called *15* for that player; on either player winning his second stroke, the score is called *30* for that player; on either player winning his third stroke, the score is called *40* for that player; and the fourth stroke won by either player is scored game for that player; except as below:

If both players have won three strokes, the score is called *deuce*; and the next stroke won by either player is scored *advantage* for that player. If the same player win the next stroke, he wins the game; if he lose the next stroke, the score is again called *deuce*; and so on until either player win the two strokes immediately following the score at *deuce*, when the game is scored for that player.

22. The player who first wins six games wins a set; except as below:

If both players wins five games, the score is called *games-all*; and the next game won by either player is scored *advantage game* for that player. If the same player win the next game, he wins the set; if he lose the next game, the score is again

called games-all; and so on until either player win the two games immediately following the score of games-all, when he wins the set.

Note. Players may agree not to play advantage-sets, but to decide the set by one game after arriving at the score of games-all.

23. The players shall change sides at the end of the first, third and every subsequent alternate game of each set, and at the end of each set unless the number of games in such set be even.

It shall, however, be open to the players, by mutual consent and notification to the umpire before the opening of the second game of the match, to change sides instead at the end of every set, until the odd and concluding set, in which they shall change sides at the end of the first, third, and every subsequent alternate game of such set.

24. When a series of sets is played, the player who was Server in the last game of one set shall be Striker-out in the first game of the next.

The Four-Handed Game.

25. The above laws shall apply to the four-handed games, except as below.

26. For the four-handed game the Court is 36 ft. (10.97 m.) in width. Within the sidelines, at a distance of $4\frac{1}{2}$ ft. (1.37 m.) from them, and parallel with them, are drawn the service-side-lines. In other respects the Court is similar to that which is described in Law 1.

27. In the four-handed game, the pair who have the right to serve in the first game may decide which partner shall do so, and the opposing pair may decide similarly for the second game. The partner of the player who served in the first game shall serve in the third; and the partner of the player who served in the second game shall serve in the fourth, and so on in the same order in all the subsequent games of a set.

28. The players shall take the service alternately throughout each game; no player shall receive or return a service delivered to his partner; and the order of service and of striking out, once arranged, shall not be altered, nor shall the Striker-out change Courts to receive the service before the end of the set.

29. The ball served must drop within the service line, half-court-line, and service-side-line of the Court, which is diagonally opposite to that from which it was served, or upon any such line.

30. It is a *fault* if the ball do not drop as provided in Law 29, or if it touch the Server's partner, or anything that he wears or carries. If, however, the ball in Service strike either the Striker-out or his partner, the server wins the stroke.

31. If a player serve out of his turn, the Umpire, as soon as the mistake is discovered by himself or by one of the players, shall direct the player to serve who ought to have served; but all strokes scored, and any fault served before such discovery, shall be reckoned. If a game shall have been completed before such discovery, then the service in the next alternate game shall be delivered by the partner of the player who served out of his turn; and so on in regular rotation.

MODERN PENTATHLON.

The competitions will be arranged by the Olympic Sub-Committee for the Modern Pentathlon, consisting of representatives from the Sub-Committees for the different branches of sport comprised in the Modern Pentathlon.

SPECIAL RULES.

I. Duel=Shooting. Distance 25 metres.

1) Any revolver or pistol with open fore- and backsight. Hair-trigger is not permitted. Ammunition with metal cartridge case.

2) *Number of shots:* 20 shots in 4 series of 5 shots each; 2 sighters.

3) *Target:* Whole-figure (in zones), 1.7 metres high (see fig.).

4) *Starting position:* Arm stretched downwards, the muzzle turned towards the ground.

5) *Firing:* A shot is to be fired on the command word: "Eld" (fire). The figure vanishes after three seconds.

After a series of 5 shots, there will be an interval for marking. Between the shots in the series, there will be an interval of 10 seconds. A shot not fired will be counted as a miss.

6) *Counting:* In the event of an equal number of hits, the points will be counted by the zones. The inner edge of the shot-hole will determine its value.

(See, moreover, the special rules and regulations for shooting.)

II. Swimming 300 metres, free style.

The special rules and regulations for Swimming, apply, with, however, the exception that the competition will be divided into different heats without a final race. The time taken (not the order) will determine the result.

III. Fencing. Weapon : Épée.

The victory, in each case, will be assigned to the one who first makes three hits.

See, also, the special rules and regulations for Fencing.

IV. Riding.

Riding singly over a special, marked course, not exceeding 5,000 metres.

The course will be shown on Monday, 8 July, but it must not then be ridden over by the competitors, to whom will be then shown only its approximate features and not the actual obstacles. On this occasion each competitor will receive a map of the course.

At the same time, lots will be drawn, when such competitors for whom horses have been provided by the Competitors have the right of trying their mounts. After this, the horses will not be at the disposal of the competitors until the day of the competition (July 11).

All obstacles (natural or artificial) will be indicated by flags, between which the riding shall take place.

Competitors start singly, at intervals of at least 5 minutes.

Maximum time allowed for riding the course: 15 minutes.



No help may be rendered by any other person during the course of the competition.

Each rider will receive 100 points to begin with, from which will be deducted:

for refusing and bolting, the first time	2	
» refusing or bolting again, each time.....	5	»
» horse falling.....	5	»
» rider falling off completely (whether at or between the obstacles)	10	»
» each period of 5 seconds or fraction thereof, in excess of the maximum time	2	»

The deductions are for each occasion and each obstacle. (As obstacles are reckoned only such as are marked by two flags, between which the rider has to pass.)

In the case of two or more competitors having the same number of final points, the time occupied shall decide the event.

V. Cross=Country Race, c:a 4,000 metres.

The Cross-Country Race will take place over diversified country, and on a course unknown to the competitors, which will be marked out immediately before the start with white and red ribbons.

Competitors start singly, at intervals of one minute.

Both start and finish will be in the Stadium.

See, also, the special rules and regulations for Athletics.

Judging the Competition.

The competition will be decided by a calculation of points based on the place-numbers in the 5 sub-events, in which the first man in each event receives 1 point, the second, 2, and so on. The victor will be the one with the lowest number of points.

In the event of two or more competitors obtaining the same number of points, and the same number of best relative places, the competition shall be decided by the result of the last event.

In order to obtain a prize, a competitor must take part in, and complete, every one of the 5 events.

If any competitor leaves the competition, this will not alter the point-figures for the remaining competitors.

In the event of dead-heats in running, swimming and riding, there will be no second trial. If, thus, two competitors reach the best result in these events, each of these will receive the point-mark 1, the next man 3, and so on. On the other hand, equal best points in fencing will be decided by another bout (1 hit), and in shooting, the entire series must be re-fired, until the placing is decided.

If, in shooting, no decisive result has been reached after the series mentioned, the placing of the competitors in the shooting event shall be decided by the best relative results.

ROWING.

GENERAL REGULATIONS.

1. The Regatta shall be held under the management of the Olympic Sub-Committee for Rowing appointed by the Svenska Rödöförbundet (Swedish Rowing Association).

2. Only amateurs according to the following definition are qualified to compete.

An amateur is one who has never:

- a) received payment as a trainer;
- b) competed for a money prize;
- c) competed or given a display for payment;
- d) competed or given a display against a professional;
- e) drawn any pecuniary gain from athletic exercises by selling, exchanging, pawning, or hiring out any prize won in a competition.

Note: An amateur shall be allowed, when taking part in races or displays, to receive his travelling and hotel expenses from the club to which he belongs or, with the consent of the said club, from the club arranging the competition or display, without forfeiting his amateur status. Payment for such a journey, however, may be made only by the club which he represents in the said competition. No competitor shall be allowed to make any pecuniary gain or profit from such payment.

A professional shall not be allowed to take part in any competitions or displays for amateurs, neither may he officiate therein as judges or in any other capacity.

A professional is one who as a seaman, fisherman or in any other capacity has in any way, in the exercise of his calling, engaged in rowing within two years before the date of competition.

3. The Regatta shall be held in Stockholm on July 18 and 19, 1912.

4. Entries close May 18, 1912, and a statement as to the *definite composition of the crews* must be in the hands of the Swedish Olympic Committee at the latest by July 1, 1912. Each entry shall state weights and ages. Reserves of, at most, half the number of a crew can be entered. No person may be substituted for another who has already rowed or steered in a heat.

5. Maximum number of entries from each nation in each event: 2 boats.

6. Length of course in all events: 2,000 metres.

7. The following types of boats shall be used:

a) Eights, outriggers (best boats), with coxswain.

b) Fours, " " " " " "

c) " inriggers, sliding seats, " "

(see special definition).

d) Single Sculls (best boats).

SPECIAL RULES.

8. Stations shall be drawn by lot. Each competing crew may have a representative at the draw.

9. If several crews enter for the same race, trial heats will be arranged. In such trials two boats will start simultaneously. The races will be decided by heats until only two crews remain for the final.

10. All boats shall start with the bow level with the starting post, and will be considered to have finished the race as soon as the bow passes the winning-post.

11. A boat not at the start at the specified time shall be considered to have scratched, and is disqualified.

The starter has, the power however, to make an exception in the case of a reasonable explanation being given.

12. The start shall be made by the report of a pistol as soon as the starter is satisfied that the competitors are ready.

Should a competing boat be interfered with by any outside boat or person, the umpire shall have power, if he thinks fit, to order a new start.

13. If the starter considers the start false, he shall at once recall the boats by report of a pistol. A boat which refuses to obey such command, or a boat which starts too soon, shall be liable to disqualification.

14. The minimum weight of a coxswain shall be 50 kilogrammes. Deficiencies must be made up by dead weight.

15. At the request of any person concerned, the coxswain shall be weighed before the start.

16. Each competitor shall keep his course throughout the whole competition. A boat's course is that which, at the start and finish, as well as during the race, is parallel with the centre of the course. Deviations from the course shall render a boat liable to disqualification. A course of at least 12 metres in width will be allowed for each boat.

17. If, in the event of a dead heat, either of the crews refuse to start again, such crew shall be considered as having retired. If a competitor causes a foul by leaving his course, the umpire shall immediately disqualify him, without waiting for an appeal to be made. Should a competitor be compelled by unforeseen obstacles to leave his course, the umpire may order a new start, whether a foul has taken place or not. The competitor causing such an interruption shall not be disqualified.

18. A foul must be reported to the umpire by the stroke of the crew immediately after it has happened, and shall be considered to have taken place when, after the start for a race, a competitor has, with his oar, boat or body, collided with the oar, boat or body of another competitor, and shall be given if the umpire considers the foul to have influenced the result of the race.

19. The umpire alone shall be the sole judge of the proper course of a boat.

20. During a race, the umpire may caution any competitor who is in danger of causing a foul.

21. The jurisdiction of the umpire extends over the whole course, and his decision in each case shall be final. All officials shall be subordinate to the umpire.

22. Swedes only will officiate in the competitions.

23. All crews entered will be furnished with particulars as to the names and weights of their opponents.

24. No consideration whatever will be paid to any accident to material or crew during the race.

Definition of a Four-oared Inrigger.

An inrigger gig shall be clinker-built and shall comply with the following measurements and weights:—

Length	maximum	10.60	metres
Width at the widest place	minimum	1.05	»
Depth	»	0.36	»
Width at water-line	»	0.78	»
Weight	»	85	kilos
Number of boards on either side	»	7	

The width of the boards must not vary more than 2 centimetres in any part of the cross-sections of the boat.

For the purpose of measuring the width at the water line, an apparatus of the following construction will be used:

A bar, about 1 metre in length, placed on edge and supplied with two vertical, movable arms, 12 $\frac{1}{2}$ centimetres high, one at each end. In the middle of the bar a notch is made, large enough to fit over the keel of the boat.

When a boat is to be measured, it shall be laid bottom upwards, with the apparatus placed over the middle rib. The vertical arm is then pushed so far along the bar as to touch the sides of the boat, at the water-line. The distance is measured on the bar between the vertical arms, and if, for example, this distance for a four-oared boat is at least 0.78 metre, the boat holds the measurement; if the distance is less, it is not up to the standard.

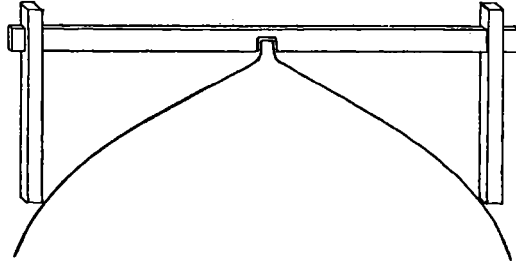

Apparatus for measuring a Four-oared Inrigger.

The length shall be measured in a straight line between the extreme ends of the stem and the stern.

The depth shall be measured inwards, from the deepest point of the keel to the deepest part of the boat, and perpendicularly up to a line through the upper edges of the uppermost boards.

The width shall be measured between the outer edges of the uppermost boards on the widest part of the boat.

The width at the water-line shall be measured outwards on the middle rib and at a height of 12 $\frac{1}{2}$ centimetres above the lowest board.

The boat shall have an outward *keel* which, in every cross-section, shall reach at least 1 centimetre below the lowest edge of the lowest board.

The weight of the boat is reckoned exclusive of the oars, but inclusive of all other equipment of the boat.

The position of the rowlocks or the axle of the movable rowlock may not be more than 3 centimetres outside the outer edge of the upper board, and the measurement shall be made straight out from the place where the rowlock is fixed.

SHOOTING.

GENERAL REGULATIONS.

1. The competitions will be held under the management of the Olympic Sub-Committee for Shooting.

The Committee itself will appoint judges and officials etc., and its decision in all matters concerning the competition shall be final.

2. The competitions are exclusively confined to amateurs according to the following definition.

An amateur is one who has never: —

- a) shot in public, or been specially occupied with instruction in shooting with the intention of thereby earning his living;
- b) taken part in an open competition for professional shooters;
- c) sold, pawned, hired but, or exhibited for payment any prize won in a competition;
- d) been engaged at a gunsmith's and there been specially occupied with sighting and adjusting weapons.

3. Shooters can be disqualified on the ground of insufficient knowledge of, or of transgression against, the conditions of the programme, or on account of late arrival.

4. In Team Shooting, after the shooting has begun, reserves shall not be permitted to replace those competing.

SPECIAL RULES.

I. Shooting with Army Rifle.

The national military arm of any country according to adopted model without any alteration or addition. Before the competition, the captain of the shooting contingent of each country shall certify that this condition is observed.

Rifles of private manufacture may be used, but they must be of officially prescribed military pattern; in the case of the rifles of countries having an official view mark, the rifle used must bear such mark.

The fore- and back-sights must be regulation, and not telescopic or magnifying. No other colour than black may be employed for sighting.

Ordinary spectacles may be worn, if desired.

Ammunition of any kind may be used, but it must not be of a dangerously explosive character. In all cases of accident arising from defective ammunition, the user only shall be held responsible.

The pull of the trigger must under no circumstances be under 4 pounds (1.8 kg.); the triggers will be tested immediately before firing at each distance.

Rifle-slings may be used as a support for one arm, but in such a case they shall be of regulation military pattern.

The centre of the shot-hole will determine the value of the shot.

A ricochet will be counted as a miss.

a) Team Shooting. (The International.)

1. Open to one team from each nation. Each team to consist of six men, with maximum 3 reserves.

2. The distances are 200, 400, 500, and 600 metres.

3. All targets are coloured white with black bull's-eyes (see fig. 1 and 2).

4. Any position may be taken, but without artificial rest.

5. Each competitor shall shoot two sighters and 15 shots at each distance.
6. Two targets shall be allotted to each team.
The order of shooting in each team shall be decided by its captain.
The order of team shooting shall be decided by ballot.
7. No protection against light or wind may be employed.
8. The marking shall be challenged before another shot has been fired at the same target.

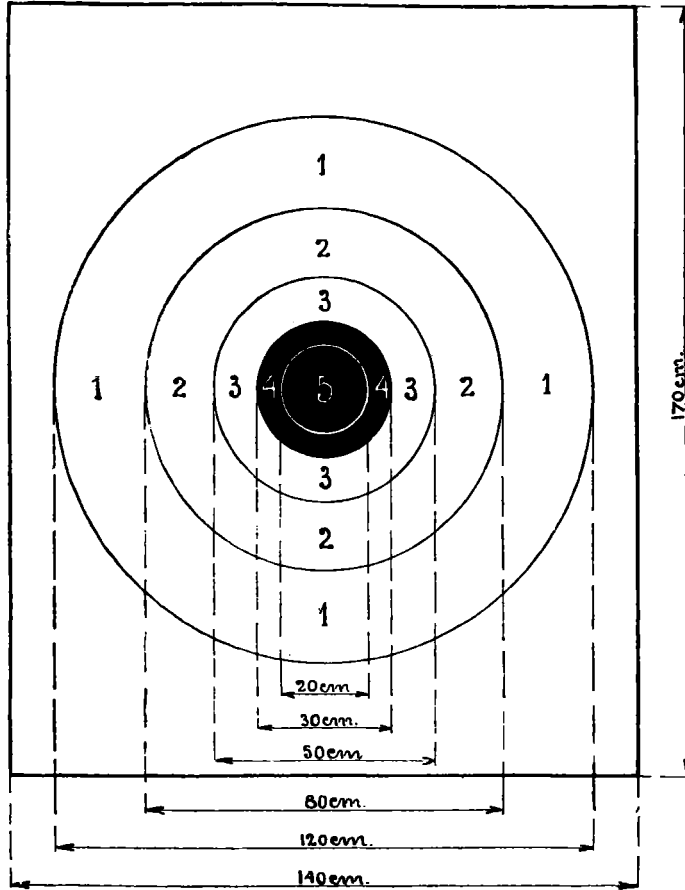

Figure 1. Target for 200 metres.

9. The competition shall occupy one day only.
The time is limited to one hour and thirty minutes at each distance.
The time limit is exclusive of successful challenges.
No allowance will be made for a defective cartridge, except in the case of a miss-fire.
10. The leader of the competition shall have the power to suspend the shooting on any day should the atmospheric conditions render that step necessary, and to fix another day for the resumption of the competition.
11. No two competitors detailed to fire at the same time may shoot with the same rifle; nor may a competitor change his rifle or any part thereof during his firing at any single distance of the competition, unless his first rifle shall become unserviceable through an accident which must be verified by an umpire.

12. No rifle may be cleaned or wiped out between the shots fired with it at any single distance of the competition.

13. In case of a dispute, the umpire's decision shall in every case be final.

14. The highest aggregate of the scores at all the distances shall determine the winning team.

In the event of a tie in the final totals, each member shall fire one sighter and seven shots at 600 metres. If there is still a tie, each member of the team shall fire one shot more, and so on, till a distinction can be made.

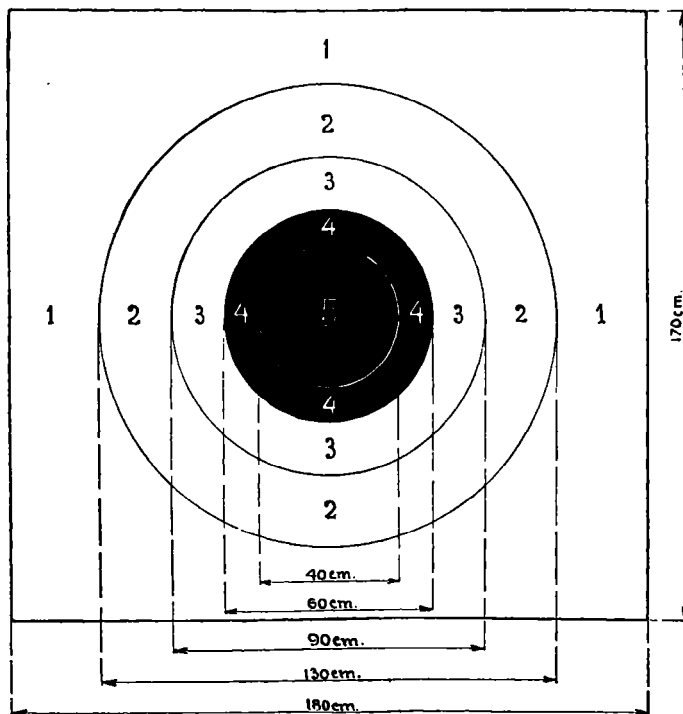

Figure 2. Target for 400, 500, and 600 metres.

b) Individual Competition. Distance 600 metres.

1. The competition is limited to 12 individual entries from each nation.
2. The targets to be the same as in competition *a* (see figure 2).
3. Any position without artificial aid will be permitted.
4. Each competitor shall fire 20 shots. 5 sighters are permitted.
5. Any ties must be shot off on the spot.

c) Individual Competition. Distance 300 metres.

1. The competition is limited to 12 individual entries from each nation.
2. *Target:* stationary and half figure (see figs. 3 and 4). A hit in the figure will be counted as five points.
3. *Time, positions, and number of shots.* Each competitor shall shoot 2 series of 10 shots in every series.
One series shall first be shot at the stationary target, and then, as soon as the marking is finished, one series at the half-figure.

The series at the target shall consist of 4 shots lying down, 4 shots kneeling, and 2 shots standing, during a total period of max. 3 minutes, inclusive of the time taken for loading and position.

The half-figure series shall consist of 5 shots in a lying, and 5 shots in a kneeling position; the time allowed shall be not more than 3 minutes, inclusive of loading and taking position.

The start of each series will be made from a standing position, with the butt of the rifle resting on the ground and open at the breech.

The time shall be counted from the word of command "Eld" ("Fire"), and cease at a signal from a whistle.

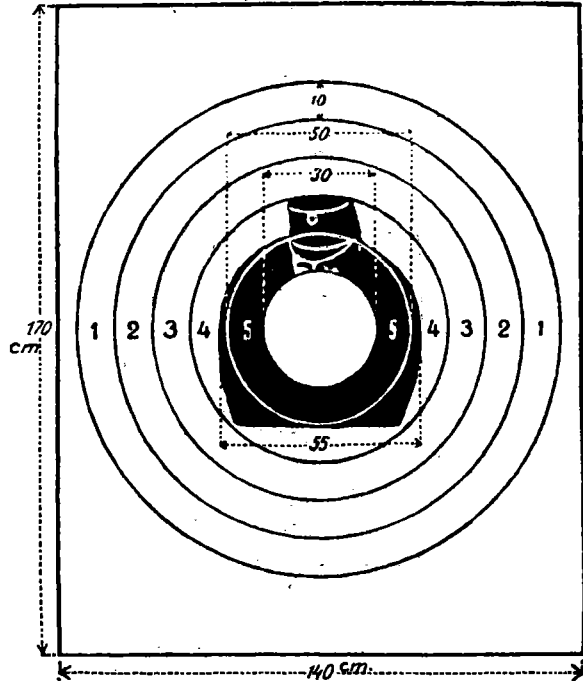

Figure 3. Stationary ("Precision") Target.

If any shots are fired after the signal has been given by the whistle, the best hit or hits will be deducted to a corresponding number.

The points for both series shall be reckoned together.

In the event of a tie, the result will be decided by the greatest number of points in the half-figure section. Should the result still be a tie, one shot more shall be fired, and so on, till a result is arrived at.

II. Shooting with any Rifle.

Rifles and ammunition of any kind may be used.

Fore- and back-sight shall be open.

The Target is coloured white, one metre in diameter, with a black round bull's-eye, 60 centimetres in diameter. The whole target to be divided into 10 zones counting from 1 to 10 points (see fig. 5).

Position.

Standing. On both feet, without any other support.

Kneeling. A cushion is allowed underneath the leg, but the knee and foot must touch the ground.

Lying. The competitor can place himself either in the direct line of fire or across it, on the ground or on a mat or waterproof sheet, but the body must be supported on the elbows, and the fore-arms must not rest on the ground or mattress.

The centre of the shot-hole will determine the value of the shot.

Ricochets will be counted as misses.

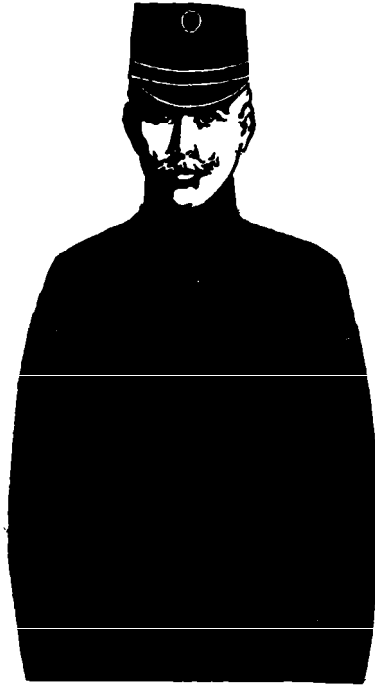

Figure 4. Half-figure. Width = 50 cm.; height = 90 cm.

d) Team Competition. Distance 300 metres.

1. The competition will be open to one team from each nation. Each team to consist of 6 men, with maximum 3 reserves.

2. The number of targets allotted to each team shall be at least three; the order of shooting shall be decided by lot on the morning of the competition-day, before the shooting begins.

3. Each competitor shall fire 120 shots, (40 standing, 40 kneeling and 40 lying down.)

4. 10 sighters are allowed for each of the three positions.

5. The winning team will be that which has the highest aggregate number of points.

Ties will be decided: —

(1) By the greatest number of hits on the targets.

(2) By the greatest number of centres.

(3) " " " " " 10's, 9's, 8's, etc.

e) Individual Competition. Distance 300 metres.

1. The competition is limited to 12 individual entries from each nation;
2. Each competitor shall fire 120 shots, (40 standing, 40 kneeling, and 40 lying down.)
3. 10 sighters are allowed for each of the three positions.
4. The winner will be the one who has the highest aggregate number of points.

Ties will be decided:

- (1) By the greatest number of hits on the target.
- (2) " " " " " centres.
- (3) " " " " " 10's, 9's, 8's, etc.

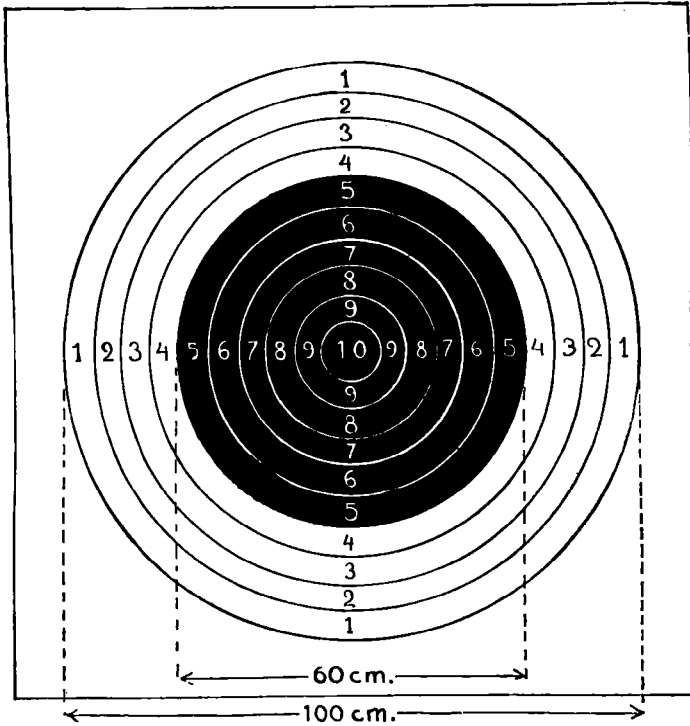

Figure 5. Target for 300 metres (Comps. d. and e.).

III. Miniature Rifle Shooting.

Rifle. Any breech-loading rifle with calibre not exceeding 6 mm., using miniature ammunition intended for competition. Any back- and fore-sight, except magnifying or telescopic.

Ammunition. The weight of the bullet must not exceed 10 grammes, and the observed initial velocity must not exceed 450 metres.

Position. Any, without artificial rest.

f) Team Competition. Distance 50 metres.

Open to one team from each nation. Each team to consist of 4 men, with a maximum of 2 reserves.

1. *Target,* white with black centre (see fig. 6).
2. *Number of shots.* 40 shots in 4 series, with 10 shots in each series. 4 sighters.
3. The centre of the shot-hole will determine the value of the shot.

g) Individual Competition. Distance 50 metres.

The competition is limited to 12 individual entries from each nation. The same rules as for *f*.

h) Team Competition. Distance 25 metres.

Open to one team from each nation. Each team to consist of 4 men, with a maximum of 2 reserves.

1. *Target (disappearing)*: reduced whole-figure, in zones (see fig. 7).

The figure, 12 cm. high, will appear 25 times, each time for 3 seconds, with intervals of 5 seconds between each appearance. After each series of 5 shots, a pause will be made for the change of figures.

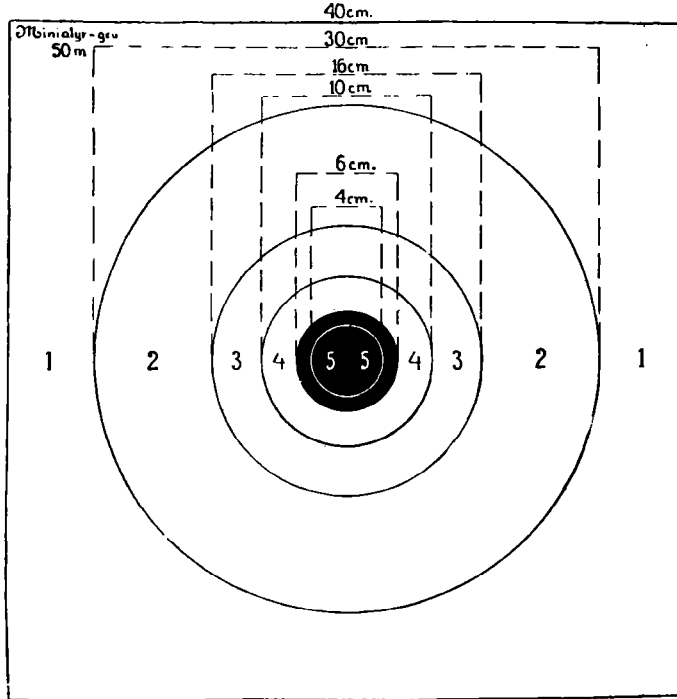

Figure 6. Target for 50 metres (Comps f. and g.).

2. *Number of shots.* 25 shots in 5 series, with 5 shots in each series. 2 sighters.

3. *Scoring.* In the event of a tie, the zones will be used to decide.

4. The edge of the shot-hole will determine the value of the shot.

i) Individual Competitions. Distance 25 metres.

The competition is limited to 12 individual entries from each nation. The same rules as for *h*.

IV. Revolver and Pistol Shooting.

Any revolver or pistol with open fore- and back-sights. Ammunition with metal cartridge case. Hair-triggers will not be permitted.

j) Team Competition. Distance 50 metres.

Open to one team from each nation. Each team to consist of 4 men, with a maximum of 2 reserves.

1. *Number of shots:* 60 shots in 10 series, with 6 shots in each series. 2 sighters.

2. *Time:* 4 minutes for a series of 6 shots.

3. *Target:* white, 50 cm. in diameter. The target is divided into 10 zones, 2 1/2 cm. between each zone. Centre, black, 20 cm. in diameter (see fig. 8).

Position: standing, right or left hand, with arm extended. The centre of the shot-hole will determine the value of the shot.

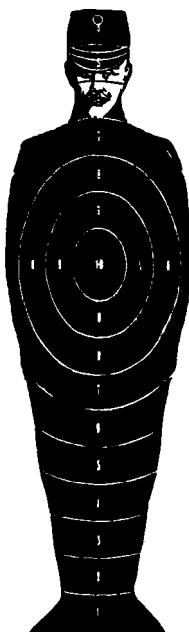

Figure. 7. Whole-figure for competitions h. i. l. and m.

k) Individual Competition. Distance 50 metres.

The competition is limited to 12 individual entries from each nation.

The same rules as for j.

l) Team Competition in Duel Shooting.

Distance 30 metres.

Open to one team from each nation. Each team to consist of 4 men, with a maximum of 2 reserves.

1. *Number of shots:* 30 shots in 6 series, with 5 shots in each series. 2 sighters.

2. *Target:* whole-figure (in zones), 1.7 metres high (see fig. 7).

3. *Starting position:* arm stretched downwards, the muzzle turned towards the ground.

4. *Firing.* A shot shall be fired on the word of command "Eld" (Fire).

The figure will disappear after three seconds.

After each series of 5 shots there will be an interval for marking. Between the shots in the series there will be 10 seconds interval.

A shot not fired will be counted as a miss.

5. *Counting.* In the event of a tie, the zones are used. The edge of the shot-hole will determine the value of the shot.

m) Individual Competition in Duel Shooting.

Distance 30 metres.

The competition is limited to 12 individual entries from each nation.

The same rules as for l.

V. Clay Bird Shooting.

1. Three traps throwing in different directions will be set up, concealed by a screen, before each mark.

2. 5 marks will be arranged at a distance of 5 metres between each, and numbered 1, 2, 3, 4, and 5. Numbering begins from the left.

The marks will be placed at a line 15 metres distant from the traps.

3. Guns of greater calibre than 12 may not be used.

4. Cartridge cylinders, powder and shot of any sort may be used, but a charge of shot may not exceed 35.5 grammes, and the shot may not be coarser than No. 6 English sort (2.5 mm.)

The leader of the competitions reserves the right of instructing the control official to take out two cartridges from the stock of cartridges of each competitor, to examine them with regard to their proper loading.

5. The gun shall be open at the breech till the control official has assured himself that the competitors have taken up their places, and until he has given the order "Linjen klar" ('line ready').

6. Two shots may be fired at each clay pigeon.

7. The competitor must *not* shoulder his gun and take sight, or rest the butt against his shoulder, before the clay pigeon thrown up has appeared in sight. The butt of the gun is to be held between the hips and the arm-pits, but may on no account rest against the shoulder.

8. The leader of the competitions must see that the traps are in due order and adjusted, and that all precautions are taken to avoid accidents during the shooting. The leader shall decide all differences of opinion that may arise, and shall judge the results. His decision is final.

9. As "no bird" are counted the following:

If the marksman discharges both shots practically at once and hits his clay pigeon, it is counted as "no bird", but if he misses, a miss is noted.

The marksman has the right to refuse a clay pigeon if it leaves the machine in a broken condition, but he is bound by the result, if he fires at a part of the clay pigeon.

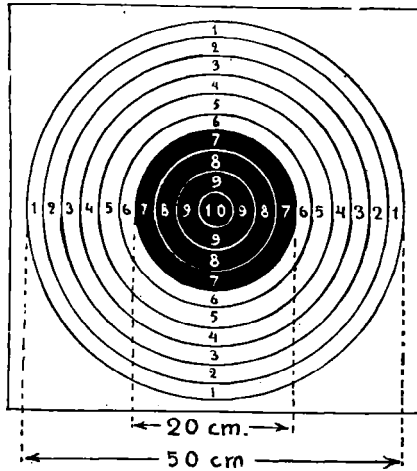

Figure 8. Target for 50 metres (Comps. j. and k.).

If one or more clay pigeons are, by accident, thrown up at the same time as the pigeon which is to be shot at, the competitor has the right to consider this as "no bird".

If the gun, duly loaded and cocked, misses fire for some reason beyond the control of the marksman, the pigeon shall be counted as "no bird". If the gun misses fire with the first barrel and the marksman fires the second shot and hits, it shall be judged as a "hit", but if he fires the second shot and misses, it shall be counted as a "miss." If the second shot is not fired, the pigeon shall be counted as "no bird". If the second shot misses, a fresh bird is thrown up for the marksman, but in such case the first barrel shall be charged with only a powder-filled cylinder, which shall be fired after the trap has been set in motion. The result of the second shot will be counted. If the marksman uses a gun which necessitates a fully-loaded cartridge to be discharged in order that the mechanism may work at the second shot, or if the first cartridge or a part thereof sticks or prevents firing, the marksman can claim two more cartridges, the first of which, after the trap has been set in motion, shall be discharged into the air, and the second at the clay pigeon. The result of the second shot will be counted. Should the first shot hit the pigeon, a miss shall be counted.

The defective cartridge shall be submitted to the leader, who will examine where-in the fault lies, and decide if, in conformity with the above rules, another shot may be fired.

10. In order to be entered as a hit, the pigeon must break before touching the ground. The leader's decision as to whether a pigeon is hit or not is final. A

marksman not bowing to his decision will be disqualified. The pigeons must not, under any circumstances, be picked up for the purpose of examination.

11. *Continuous firing.*

6 marksmen are ranged for the 5 marks. 5 guns occupy the marks, and No. 6 takes his place behind No. 1 and there awaits his turn. Gun No. 1 shoots first from mark No. 1, gun No. 2 from mark 2, and so on. At, or during, the closing of the series, number 1 shall stand at mark number 2, and number 6 at mark No. 1, No. 2 at mark No. 3, and so on; so that No. 5 is the shot who waits at the back of mark No. 1. Competitors must not leave their marks before the series is concluded.

When the marksmen have taken their marks, the person who is regulating the throwing from the different machines calls out, "N:o 1 klar" ('ready'), whereupon the competitor who is standing at mark No. 1 answers "Gå" ('go'). The remaining competitors answer "Gå" when the number of their mark and "Klar" are called out.

12. *Firing out of turn.*

If a marksman fires out of his turn, a miss will be reckoned to him. The marksman whose turn it was to shoot, has a fresh bird thrown up.

13. *Unknown angles.*

The marksman shall be unaware which of the traps, behind each screen, will be discharged.

14. *Single shots from unknown traps.*

All the machines will be filled before the shooting commences, and the competitors will be kept in ignorance of the group of traps and the trap from which the pigeons will be thrown.

15. *One marksman on the line.*

The marksman is to stand at mark No. 3 and shoot at the fixed number of pigeons before leaving his mark.

16. *Two marksman on the line.*

One stands at mark No. 2 and shoots at the required number of pigeons thrown up from sets of traps Nos. 1, 2 and 3; the second stands at mark No. 4 and shoots at the required number thrown up from the groups of traps Nos. 3, 4 and 5.

n) Team Competition.

1. The competition is open to one team from each nation. Each team to consist of 6 men, with a maximum of 3 reserves, of whom the team-captain may form one.

2. The order of shooting between the teams will be decided by lot.

3. The shooting will be divided into three rounds. Each round will be concluded, if possible, in one day.

First stage.

20 clay pigeons per man, thrown up at unknown angles from known traps, will be shot at under continuous firing in 2 series of 10 birds each. Two or three teams shoot together. Each marksman, from the different teams alternately, shall in his turn shoot off a series of 10 shots. The first stage will thus constitute a succession of competitions. A tie shall be decided by each marksman shooting at 10 pigeons on the continuous firing system.

Second stage.

A maximum of 50% of the teams competing in the first stage who have obtained a lower number of points shall retire. The order of shooting among the different teams will be the same as in round 1.

30 clay pigeons per man, thrown up at unknown angles from known traps, will be shot at without an interval in two series of 15 birds each. A tie will be decided by each competitor re-shooting at 10 pigeons on the continuous firing system.

Third stage.

A maximum of 50% of the teams competing in the second stage, who have obtained a total lower number of points in the first and second rounds, shall retire. The order of shooting will be the same as in stage No. 1.

40 pigeons per man are shot at, on the continuous firing system, in 2 series of 20 birds each, and thrown up from known sets of traps at unknown angles on the group system. In addition, from firing-point No. 3, single shots at 10 pigeons

per man, thrown at unknown angles from unknown traps. Ties shall be shot off with 10 birds by each marksman on the single shot system, i. e. from mark 3.

The winner will be the team which has obtained the highest total number of hits in all three stages.

o) Individual Competition.

1. The competition is limited to 12 individual entries from each nation.
2. The order of shooting will be decided by lot.
3. The shooting will be divided into three stages. Each stage will be concluded in one day if possible.

First stage.

20 clay pigeons per man, thrown up at unknown angles from known traps, will be shot at on the continuous fire system in 2 series of 10 birds each. In the event of a tie, 10 pigeons are to be shot at by each competitor on the continuous fire system.

Second stage.

A maximum of 50% of the competitors competing in the first round who have obtained a lower number of points will retire. The order of shooting among the marksmen will be the same as in stage No. 1.

30 clay pigeons per man, thrown up at unknown angles from known sets of traps, in two series of 15 birds each, will be shot at on the continuous firing system. In the event of a tie, there will be re-shooting at 10 pigeons per man with continuous firing.

Third stage.

50%, at most, of the competitors in the second round who in the first and second stage obtained a total lower number shall retire. The order of shooting among the marksmen is the same as in stage 1. 40 clay pigeons per man will be shot at, with continuous firing, in 2 series of 20 pigeons each, thrown up at unknown angles from known sets of traps, and also at 10 pigeons per man in two series of 5 pigeons each, with continuous firing, thrown up at unknown angles from unknown sets of traps. The marksman will stand at mark No. 2, for 5 pigeons thrown up from set of traps Nos. 1, 2 or 3, and at mark No. 4, for 5 pigeons thrown from traps Nos. 3, 4 or 5. A tie will be decided by shooting off, on the continuous firing system, at 10 pigeons per man, thrown up at unknown angles from known sets of traps.

4. The marksman who has obtained the highest total number of hits in all three stages will be declared the winner.

VI. Running Deer Shooting.

The target shall consist of the figure of a deer, life size (see fig. 9).

General Regulations:

1. Rifles of any construction and calibre may be used. The pull of the trigger, which must be tested before the beginning of the competition, shall be four pounds (1.8 kg.). Only open fore- and backsights, without any lateral adjustment, will be permitted. The centres of both sights must be fixed over the centre of the barrel. Only *one* platinum or other line will be permitted on the back-sight.

Spirit levels are allowed.

Arms may not be exchanged during the competition without a valid reason approved of by the umpire.

2. Any sort of bullets may be used except cartridges loaded with explosive bullets.

3. Any position may be taken.

4. The distance from the mark to the target is 100 metres. The open part of the run is 23 metres in width, and the target will appear for about 4 seconds.

5. The breech of the rifle shall be kept open till the umpire has given the order "Linjen klar" ("Line clear").

6. The points shall be reckoned 5, 4, 3, 2, 1 and 0. Five and four points are allowed for hits within the centre of a circle measuring, respectively, 15 cm. for 5

(bull's eye), and 30 cm. for 4; three points for a hit between the outer circle and the nearest perpendicular lines; two points for a hit on a space, 10 cm. wide, behind the centre surface, or for a hit between the centre circle's outward boundary line and the head; one point for a hit between the two-point limit and a line drawn perpendicularly, which hits the groin mark; and no point for a hit on the head, hind-quarters and legs. The divisions on the deer are not visible from the firing point.

7. The hits shall be marked on the deer set up over both the masked butts by means of a round disc, 20 cm. in diameter, which is placed over the middle of the bullet hole.

The colour of the disc shows the points:

red	5 points
red and white	4 "
blue	3 "
blue and white	2 "
white	1 "
black.....	0 "



Figure 9. Running Deer.

A miss is shown by a black swinging disc.

8. The leader has the right, to see, himself or by means of a controller, that the rules in § 1. are observed.

9. The leader of the competition shall see that all precautionary measures are observed for the avoidance of accidents during the shooting.

The leader shall decide any differences of opinion which may arise; he judges the result, and his decision is final.

10. The rifle must not be raised to the shoulder before the target appears. The shot must not be discharged if part of the target is hidden by either of the posts.

11. "Linjen klar" ("Line clear").

When the leader has assured himself that the marksman is ready to fire, he shall give the order to the butts to set the target in motion. The first run for every series will be from the right butt, either if it is a sighter or a shot fired in competition.

The marksman shall at once get ready for the next run, which begins as soon as the shots have been marked and the target has been patched and turned.

12. If the rifle, after being duly loaded and cocked, misses fire, from a cause beyond the control of the marksman, the target for the re-shoot shall be set in motion from the same butt.

The defective cartridge shall be handed over to the leader, who will decide wherein the fault lies, and decide if a re-shoot shall take place.

13. If in a double-shot competition a rifle, properly loaded and cocked, misses fire at the first shot from causes beyond the control of the marksman, the second shot shall not be fired, but the target shall be run again from the same butt. If the second shot is fired, two misses shall be counted. If the second shot misses fire, the first shot shall be counted as no shot, and the target again run from the same butt.

p) Team Competition.

1. The competition is open to one team from each nation. Each team to consist of 4 men, with a maximum of 2 reserves, of whom the team-leader may be one.
2. The order of shooting will be determined by lot.
3. Two sighters will be allowed.
4. Each man will have 10 shots in succession. One shot is fired in each run.
5. Ties are shot off by 5 shots in succession per man. One shot will be fired in each run.
6. The team that has obtained the highest number of points will be declared the winner.

q) Individual Competition. Single shot.

1. The competition is limited to 12 individual entries from each nation.
2. The order of shooting will be decided by lot.
3. Two sighters shall be permitted.
4. The shooting will consist of 10 shots in succession per man; one shot will be fired in each run.
5. Ties are decided by shooting off with 5 shots in succession per man. One shot shall be fired in every run.
6. The marksman with the highest number of points will be declared the winner.

r) Individual Competition. Double shot.

1. The competition is limited to 12 individual entries from each nation.
2. The order of shooting will be decided by lot.
3. Two sighters are permitted.
4. The shooting will consist of 20 shots in succession, per man; two shots will be fired in each run.
5. Ties are decided by shooting off with 6 shots in succession per man. TWO shots are fired in every run.
6. The marksman with the highest number of points will be declared the winner.

SWIMMING.

GENERAL REGULATIONS.

1. The competitions will be arranged by the Olympic Sub-Committee for Swimming appointed by the Svenska Simförbundet (Swedish Amateur Swimming Association), and will conform to the rules and regulations of the International Swimming Association (Fédération Internationale de Natation Amateur).

2. The competition shall be confined to amateurs in accordance with the following definition:

An amateur is one who has never

- a) competed for a money price, declared wager, or staked bet, in swimming or any other athletic sport;
- b) taught, pursued or assisted in the practice of swimming, or any other athletic exercise, as a means of pecuniary gain;
- c) knowingly and without protest taken part in any competition or exhibition with anyone who was not an Amateur (except whilst in the Military or Naval Services, and then only in Military or Naval Competitions).

A professional in any sport shall be considered a professional in swimming.

The exceptions laid down by the Federation Internationale de Natation Amateur shall apply.

3. The competitions will take place in the open, and in absolutely still and fresh water, and in an enclosed course 100 metres long, 20 metres wide and at least $1\frac{1}{2}$ metres deep.

4. The Swimming Committee will make all arrangements with regard to the competitions, and will appoint judges as well as all other officials. The referee shall decide all questions referred to him by the judges.

5. The competitors shall wear the regulation swimming costume. The starter shall see that the competitors conform to these rules, and no one shall be permitted to start if his costume is not in accordance with the regulation. The costumes must be in accordance with the following regulations:

- a) The colour of the costume shall be black or dark blue.
- b) Cloth drawers, at least 6 centimetres high at the sides, must be worn under the costume.
- c) The sleeves must not be cut lower than $7\frac{1}{2}$ centimetres from the armpit.
- d) The costume must not be cut lower in the neck than 5 centimetres crosswise from the shoulders.
- e) Ladies' costumes shall be cut straight round the neck, and shall be provided with shaped arms of at least $7\frac{1}{2}$ centimetres length.
- f) As identification marks, competitors shall wear caps of different colours, which will be supplied by the Swimming Committee. In Water Polo, the caps for one team shall be white, for the other dark blue, with red bands for the goal-keepers.

6. The relative order of starting of the competitors, as well as of the heats, shall be decided by ballot.

In all races, the positions of the competitors, counting from right to left, shall be decided in the same way immediately before the start.

Swimming Races.

I. GENERAL REGULATIONS.

- a) All races shall be started by the report of a pistol.

The start for all races (with the exception of back stroke) shall be from a board placed 30 centimetres above the surface of the water. All questions

regarding the start shall be decided by the starter. A competitor starting too soon will be disqualified, unless he returns to his position and starts afresh.

- b) Every race will be divided into heats and a final, with a sufficient number of intermediate heats in proportion to the number of competitors. If in any heat not more than 3 competitors line up, the starter shall let them join the next following incomplete heat.
- c) The first and second in each heat, and also the fastest third, shall be qualified to swim in the next round or final.
- d) In all contests, dead-headers in preliminary heats shall be qualified to compete in the next round or final. If a dead heat ensue in a final, the competitors who tie shall again compete at such time as the judges may direct.
- e) A competitor who wilfully obstructs another competitor shall be disqualified from that competition, and forfeits his right to any prize which he might otherwise be entitled to.

Should such a foul endanger the chance of success of a competitor, the judge shall have power to allow him to compete in the next round, or, should the foul occur in a final, they may order it to be re-swum.

- f) When turning, swimmers must touch the end of the bath or course with one or both hands. For Breast-Stroke, there are special rules in this respect.
- g) Standing on the bottom during a race shall not disqualify a competitor, but he must not walk.
- h) A competitor "swimming over" must cover the whole distance to qualify as the winner.

II. SPECIAL RULES.

Breast Stroke.

- a) Both hands must be pushed forward together and brought backwards simultaneously.
- b) The body must be kept perfectly on the breast, and both shoulders in line with the surface of the water.
- c) When touching at the turn, or on finishing a race, the touch shall be made with both hands simultaneously.
- d) Any competitor introducing a side-stroke movement shall be disqualified.

Back Stroke.

- a) Competitors shall line up in the water, facing the starting end, with both hands on the end or rail of the bath. A push-off at the start is permitted.
- b) At the signal for starting the competitors shall push off and swim upon their backs throughout the race.

Team Races.

The team races shall be conducted as follows: The first member of each team shall start together at the starting signal, and shall then be succeeded by the other competitors as soon as they have finished, and so on.

The team whose fourth member finishes first shall be declared the winner.

If any one of the competitors starts before the preceding swimmer has finished, his team shall be disqualified unless he returns and starts again according to the regulations.

A start controller will be appointed for each team.

Diving Competitions.

I. GENERAL REGULATIONS.

- a) The depth of the water under the platforms shall be at least 5 metres.
- b) Entries must be accompanied by a statement as to which voluntary dives the competitor wishes to make.

c) All variety dives must be made by the competitor alone, without assistance from any other person, and in conformity with the following conditions.

d) For each competition 5 judges will be appointed, who will estimate the value of the dive in conformity with the regulations, and each shall judge for himself, without having the right to consult with another.

e) For each dive each judge shall award points according to the following scale:

a) Unsuccessful attempt	0	points.
b) Bad dive	3	»
c) Good dive	6	»
d) Very good dive	8	»
e) Excellent »	10	»

Intermediate points and half-points may be awarded, but the highest possible number of points shall be 10.

f) The judges shall take into consideration: firstly — the execution of the dive (correct bearing, confidence and form); secondly — the force and speed of the dive; thirdly — the entry into the water, and, fourthly — the execution of the run or take-off. The bearing is excellent when it is easy, supple and graceful, with the head erect, well closed and straight legs, outstretched instep, easy movement of the arms, and the fingers together.

In a plain dive, the bearing in the air shall be easy, supple and elegant, either with the head, body and limbs in an even and unbroken line, or with the arms stretched out during the dive at right angles to the body, head erect and chest forward.

In the standing dive, the take-off must be bold, confident and elegant, with the body thrown upwards and outwards.

In judging an armstand dive, the judge shall note carefully that the competitor keeps his balance before the dive is made.

The drop into the water is excellent when a good bearing is observed and the body cuts the water smoothly with the arms extended over the head and held close together, fingers together, and legs and feet straight together and in line with the body. The incline of the body towards the water must not exceed the vertical position.

The take-off shall be easy, supple and bold.

g) To determine the number of points for the voluntary dive, the points allowed for each dive by each judge shall be multiplied, each dive separately, by the degree of difficulty stated in tables A. and B.

For plain and compulsory dives, there is no special degree of difficulty.

h) After the points allowed for each voluntary dive by each judge have been multiplied (see above), the sums thereby obtained from each judge shall be added to the points for the compulsory dives, and the total number of points thus obtained shall decide the competitors' place-numbers with each judge. The total place-numbers awarded by the judges shall decide in the first place.

In the event of a tie, the total number of points awarded shall decide. If, in a judge's protocol, two or more competitors obtain the same number of points, they shall receive the same place-numbers, but those following shall be placed in the order which they otherwise would have taken.

The final number of points for each competitor shall be determined by the total number of points awarded by each judge, after which the total sum will be divided by the number of judges.

II. SPECIAL RULES.

High Diving.

a) The competition in plain diving, and plain and variety diving combined, from a fixed take-off, will take place from a platform at least 5 metres in length and not less than 2 metres in width.

The running-board, which is fixed, will be covered with cocoa-nut matting and surrounded on 3 sides by a rail.

Each running-board will project at least 1 metre over the running-board or stage beneath.

The heights shall be two: 5—6 and 10—11 metres, measured from the surface of the water.

b) The competition in plain diving (for men as well as for ladies) shall comprise 5 dives, namely:

- | | | |
|------------------|---|--------------------------------|
| 1) standing dive | } | from a height of 5—6 metres; |
| 2) running | | |
| 2) standing | } | from a height of 10—11 metres. |
| 4) running | | |
| 5) running | | |

c) The competition in plain and variety diving combined shall comprise, *partly*, the following compulsory dives:

- | | | |
|--------------------------|---|--------------------------------|
| 1) running plain dive... | } | from a height of 5—6 metres; |
| 2) backward somersault | | |
| 3) standing plain dive | } | from a height of 10—11 metres; |
| 4) running | | |

partly 3 voluntary variety dives from a height of 10—11 metres. No dive, however, may be made more than once.

The dives must be selected from table A.

Table A.

Degrees of difficulty for voluntary variety dives from a fixed take-off at a height of 10—11 metres.

Name of Dive.	Degree of difficulty.
<i>I. Dives with face towards the platform.</i>	
1. Backward header	1.9
2. Backward somersault	1.7
3. Backward spring outwards, turn inwards with header ...	1.1
4. Do. with somersault	1.5
5. Do. with one and a half somersault	1.8
<i>II. Armstand Dives.</i>	
6. Armstand with header	1.3
7. Armstand with overback	1.8
8. Armstand with somersault	1.4
<i>III. Running Dives.</i>	
9. One somersault forwards	1.9
10. Flying somersault forwards (first well pointed header, then somersault)	2.0
11. One and a half somersault forwards	1.8
12. Isander's dive (spring outwards, turning inwards and header)	2.0
13. Mollberg's dive (spring outwards, turning inwards and somersault)	1.8

Spring=board Diving.

a) The competition in plain and variety dives from a spring-board will take place from a board at least 4 metres in length and 1/2 metre in width.

The running board, the spring of which shall be good and even, is covered with a cocoa-nut matting. It shall have an incline not exceeding 5°.

The heights are two: 1 and 3 metres above the surface of the water, measured from the outer edge of the spring-board.

b) The competition shall comprise, *partly* the following compulsory dives;

- | | | |
|-------------------------------------|---|---------------|
| 1) running plain dive | } | from a height |
| 2) running forward somersault | | of 1 metres; |
| 3) standing plain dive | | from a height |
| 4) running plain dive..... | | of 3 metres; |

and *partly*, 3 voluntary variety dives from a height of 3 metres. No dive, however, may be made more than once.

The dives must be selected from table B.

Table B.

Degrees of difficulty for voluntary variety dives from a spring-board of 3 metres height.

Name of Dive.	Degree of difficulty.	
	Stand- ing.	Run- ning.
<i>I. Dives with face towards the water.</i>		
1. Falling dive forwards (arms stretched by the sides) ...	1.1	—
2. Ordinary header forwards (arms by the sides).....	1.4	1.5
3. Screw dive forwards with half turn	1.6	1.6
4. » » » » one »	1.9	1.9
5. Pike dive forwards	1.5	1.6
6. » » (arms by the sides)	1.6	1.7
7. Forward somersault (arms stretched by the sides)	1.7	1.8
8. Flying somersault forwards (first well pointed header, then somersault)	—	1.8
9. One and a half somersault.....	1.6	1.6
10. » » » » (arms stretched by the sides)	1.9	1.9
11. Isander's dive	1.9	1.8
12. Mollberg's dive (arms by the sides).....	1.8	1.8
<i>II. Dives with face towards the spring-board.</i>		
13. Falling dive backwards (arms stretched by the sides)	1.2	—
14. Ordinary header backwards.....	1.4	—
15. Pike dive with backward spring and turning inwards...	1.5	—
16. Backward somersault (arms by sides).....	1.6	—
17. Pike dive with backward spring, turning inwards and somersault (arms by the sides)	1.7	—
18. Pike dive with backward spring, turning inwards and one and a half somersault	2.0	—

Note. For an even or divided spring, equal points will be awarded. Dives 7—10 and 16—18 can be made either with the body erect, or with bending at the hips and knee joints, but the entry into the water shall be made with the body and legs straight.

Water Polo.

RULES FOR THE DRAW.

The competition will be arranged on the elimination system. The competing teams will be drawn in couples for the first round, after which, the order of play for the following rounds will be determined in such a way that the order up to the final is decided before the commencement of the competition. The necessary number of extra matches will take place between teams qualifying for the second and third prizes.

Rules of the Game.

1. *Field of Play.* The distance between the goals shall not exceed 30 yards nor be less than 19 yards (27 met.—17 m.); the width shall not be more than 20 yards (18 m.), and shall be of even width throughout the field of play. The two yard and four yard (met.) penalty lines and the half-distance, shall be clearly marked on both sides of the field of play.

2. *Depth.* The water shall not be shallower than 3 feet ($1\frac{1}{2}$ m.).

3. *Goals.* Goal posts shall be fixed at each end of the field of play. These must be at least 1 foot (30 cm.) from the end of the bath or from any obstruction. The width between the posts to be 10 feet (3 m.), and the cross bar to be 3 feet (90 cm.) above the surface, when the water is 5 feet ($1\frac{1}{2}$ m.) or more in depth; when the water is less than 5 feet in depth, the cross bar to be 8 feet (2.44 m.) from the bottom. Nets must be attached to the goal-posts in such a way as to enclose the whole goal area, and hang below the surface of the water. The back of the net must be at least 1 foot (30 cm.) behind the goal line and hung from the height of the cross bar.

4. *The Ball.* The ball, which will be provided by the Swimming Committee, shall be leather-covered and must be round and fully inflated, and shall measure not less than 27 inches and not more than 28 inches (711 mm.—686 mm.) in circumference. It shall be waterproof, with no strapped seams outside, and no grease or other objectionable substance on the surface.

5. *Flags.* The necessary flags, etc., for officials will be supplied by the Swimming Committee.

6. *Officials.* The officials shall consist of a referee, a timekeeper and two goal scorers.

7. *Referee.* The duties of the referee shall be:

a) to start the game,

b) to stop all unfair play,

c) to decide all cases of dispute,

d) to declare fouls and, generally, see that the rules are observed,

e) to decide upon all goals, corner throws and goal throws, whether signified by the goal scorer or not.

f) Goals, fouls, and other stoppages of the game shall be signified by whistle.

The referee's decision on questions of fact is final, and must be unconditionally carried out during the game.

Note. A referee may alter his decision, providing such alteration be notified before the ball is again in play. A referee has power to stop play at any period of the game if, in his opinion, the behaviour of the players or spectators, or other exceptional circumstances, prevent the match from coming to a proper conclusion.

8. *Goal Scorers.* The goal scorers, having tossed for choice of ends, shall stand at the side and in a line with the front of each goal, and when they consider that the entire ball has passed through the goal posts, or over the goal line, at their respective ends only, they shall signify the same to the referee, a red flag denoting a corner; a white flag denoting a goal throw; and both flags to denote a goal. The goal scorers shall not change ends, and shall keep the score of goals of each team at their respective ends.

9. *Timekeeper.* The timekeeper must be provided with an ordinary stop watch and a whistle, which will be provided by the Swimming Committee. He shall notify half-time and time by a whistle, and the signal shall take immediate effect.

10. *Time.* The duration of a match shall be not more than 14 minutes; 7 minutes each way. 3 minutes shall be allowed at half-time for change of ends. When the ball crosses the goal line, whether it be a goal, corner throw or goal throw, it shall be dead until the restart of the game, or until it leaves the hand of the player taking the throw, and all such time shall be deducted. Time occupied by disputes or fouls, or when the ball is thrown from the field of play, or lodges on an obstruction, as per Rule 21, shall not be reckoned as in the time of play.

11. *Teams.* Each side shall consist of 7 players, who shall wear drawers, or costumes, with drawers underneath the costumes. No oil or grease or other objectionable substance may be rubbed on the body.

12. *Captains.* The captains shall be playing members of the teams they represent, they shall agree upon all preliminaries, and shall toss for choice of ends; the loser of the toss shall have choice of colours. If they are unable to agree upon any point, the referee shall decide it for them.

13. *Starting.* The players shall enter the water simultaneously and place themselves in a line with their respective goals. The referee shall stand in a line with the centre of the course, and, having ascertained that the captains are ready, shall give the word "Go", and immediately throw or release the ball into the water at the centre of the field of play. From the start or restart a goal cannot be scored until the ball has been handled, viz., played with the hand below the wrist, either by two members of one team — in which case the scorer shall be within half distance of the goal attacked — or by a player of each team. An attempt on the part of the goalkeeper to stop the ball when it has been handled by the players of one team only, and shot from over half distance shall not constitute handling, and should the ball cross the goal-line, a goal throw shall be awarded.

14. *Scoring.* A goal shall be scored by the entire ball passing beyond the goal posts, and under the cross-bar. If, on the notification of half-time or time, the ball be not fully through the goal posts, no goal shall be allowed.

A goal may be scored by the head or feet, providing the ball has been previously handled by two players, as provided by Rules 13 and 17.

15. *Ordinary Fouls.* It shall be a foul:

- a) to touch the ball with both hands at the same time;
- b) to hold the goal posts, rail, or side, during any part of the game;
- c) to walk about the bath;
- d) to stand on or touch the bottom during any part of the game; unless for the purpose of resting;
- e) to interfere with an opponent or impede him in any way, unless he is holding the ball;
- f) to hold the ball under water when tackled;
- g) to jump from the bottom or push from the side — except at starting or restarting — in order to play the ball or duck an opponent;
- h) to hold, pull back, or push off from an opponent;
- i) to turn on the back and kick at an opponent;
- j) to assist a player at the start or restart of the game, or for any player to push off from any part of the goal posts;
- k) for the goalkeeper to go more than 4 yards (met.) from his own goal line, or to take a goal throw improperly (Rule 20);
- l) in a free throw, to throw the ball at the goalkeeper or to an attacking player within two yards (met.) of goal (Rule 20);
- m) not to play the ball in accordance with the directions of the referee after a free throw or a throw in.
- n) to touch the ball before it has reached the water, when thrown in by the Referee. (See Rules 17 and 21.)

Note. — Clause e). — Dribbling or striking the ball is not "holding", but lifting, carrying, pressing under water, or placing the hand under or over the ball when actually touching, is holding. Dribbling the ball up and through the posts is permissible.

16. *Wilful Fouls.* If, in the opinion of the referee, a player commits an ordinary foul — Rule 15 — wilfully, or one of the following specified offences, the referee shall at once order him out of the water until a goal has been scored.

It shall be considered a wilful foul:

- a) to start before the word "Go";
- b) to deliberately waste time;
- c) for a player to take up a position within two yards (met.) of his opponent's goal-line;
- d) to deliberately change position after the Referee has blown the whistle to stop the game and until the ball is again in play;
- e) to deliberately splash in the face of an opponent;
- f) to strike at the ball with the clenched fist.

Any player ordered out of the water for misconduct or for a wilful foul, shall not re-enter until a goal has been scored, notwithstanding that half-time may intervene, or extra time be played, and then only with the consent of the referee.

Note. — In the event of a referee ordering a player out of the water and such player refusing to obey, the game shall be stopped, and the match awarded to the other side.

17. *Free Throws.* The penalty for each foul shall be a free throw to the opposing side from the place where the foul occurred. The referee shall declare a foul by blowing a whistle and exhibiting the colour of the side to which the free throw is awarded. The player nearest to where the foul occurred shall take the throw. The other players shall remain in their respective positions from the blowing of the whistle until the ball has left the hand of the player taking the throw. A free throw shall be such as, in the opinion of the referee, allows all players to see when the ball leaves the hand of the thrower. In the event of illness or an accident, or of one or more players from each team committing a foul so nearly at the same moment as to make it impossible for the referee to distinguish who offended first, he shall have the ball out of the water and throw it in as nearly as possible at the place where the foul occurred, in such a manner that one member of each team may have an equal chance of playing the ball. In such cases the ball must be allowed to touch the water before it is handled. In all cases where a free throw is allowed under this Rule, and under Rules 15, 16, 19 20 and 21, the ball must be handled, i. e., played with the hand below the wrist, by more than one player before a goal can be scored.

18. *Penalty Throw.* A player wilfully fouled when within four yards (metres) of his opponent's goal line, shall be awarded a penalty throw, and the player who commits the offence must be ordered out of the water until a goal has been scored. The player to whom a penalty throw is awarded shall proceed to any point on the four yard (met.) line and await the signal of the referee by whistle.

In the case of a penalty throw, it shall not be necessary for the ball to be handled by any other player before a goal can be scored, but any player within the four yard (met.) line may intercept a penalty throw.

19. *Goalkeeper.* The goalkeeper may stand to defend his goal, but he must not throw the ball beyond half distance: the penalty for so doing shall be a free throw to the opposing side from half distance at either side of the field of play. The goalkeeper must keep within 4 yards (met.) of his own goal line, or concede a free throw from the 4 yard (met.) line to his nearest opponent. The goalkeeper is exempt from Clauses a, c, d and g, in Rule 15, and Clause f in Rule 16, but he may be treated as any other player when in possession of the ball. Except when injury or illness compels him to leave the water — when Rule 22 shall apply — the goalkeeper can only be changed at half-time. In the event of a goalkeeper being ordered out of the water, his side cannot appoint another goalkeeper except at half-time, as defined above, and any player defending the goal in his place shall not enjoy the special limitations and exceptions attached to a goalkeeper.

20. *Goal and Corner Throws.* A player throwing the ball over his own goal line shall concede a free corner throw to his opponents, and such free corner throw shall be taken from the two yard (met.) line at the side of the bath, by the player on the opposing side nearest the point where the ball leaves the field of play. If the attacking side throw the ball over, it shall be a free goal throw to their opponents' goalkeeper, who must pass the ball to another player or beyond the two yard (met.) line. The whistle must be blown immediately the ball crosses the goal line, and from that time until the ball leaves the hand of the player taking the free throw, all players must remain in their respective positions.

Note. — If a goalkeeper puts the ball in play by a free throw, and, before any other player has handled, regains possession, and carries it back right through his goal, a corner throw shall be awarded to the opposing side.

21. *Out of Play.* Should a player send the ball out of the field of play at either side, it shall be thrown in any direction from the spot where it went out by one of the opposing side, and shall be considered a free throw. The player nearest the

point where the ball leaves the field of play must take the throw. Should the ball strike or lodge on an overhead obstruction, it shall be considered out of play, and the referee shall then stop the game and throw the ball into the water under the said obstruction. The ball must be allowed to touch the water before it is handled, and must be handled by more than one player before a goal can be scored.

22. *Leaving the Water.* A player leaving the water, or sitting or standing on the steps or sitting on the side of the bath in which the match is being played, during the progress of the game, except in case of illness or accident or by permission of the referee, shall not re-enter the water until a goal has been scored, or until half-time. Any player having left the water must have the permission of the referee before re-entering, and he may only re-enter at his own goal line. A player leaving the water during the progress of the game, without the permission of the referee, or refusing to re-enter the water at the request of the referee, shall be deemed guilty of misconduct, and be disqualified from all competitions during the Olympic Games.

High Dive.

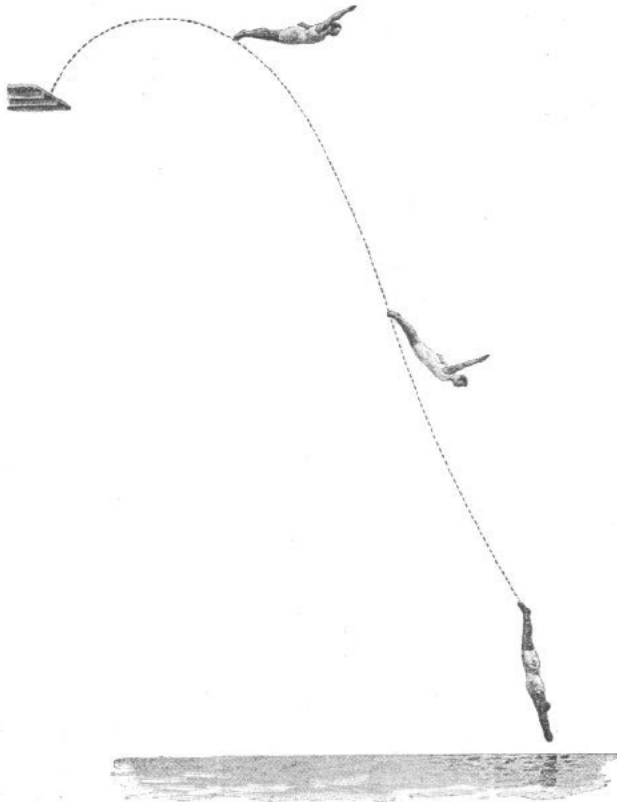

Plain Header

High Dive.

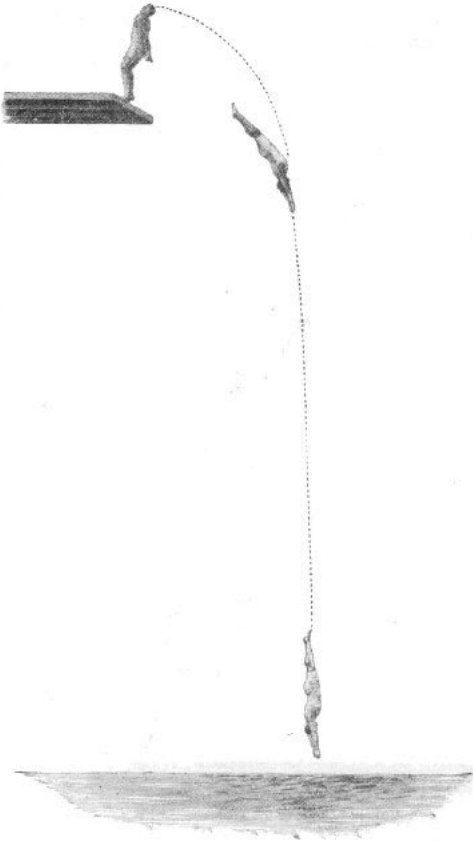

1. Backward Header.

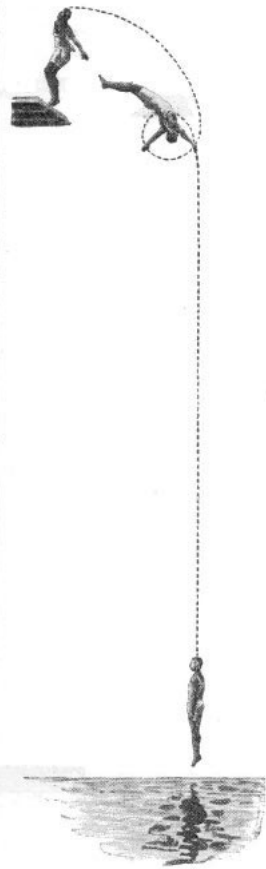

2. Backward somersault.

High Dive.

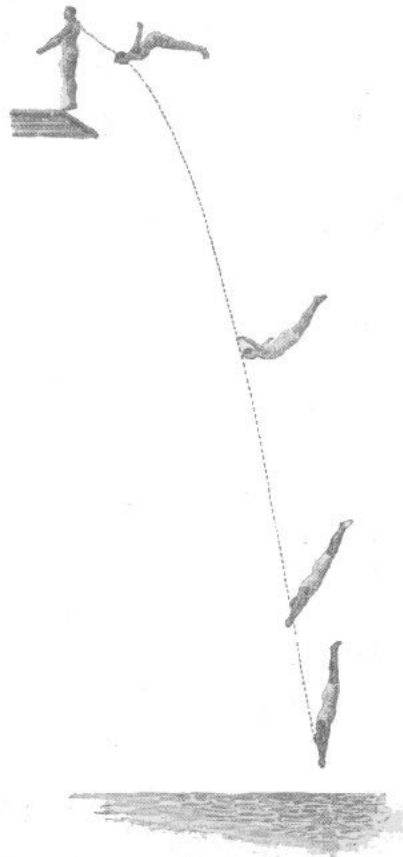

3. Backward spring outwards and turning inwards with header.

High Dive.

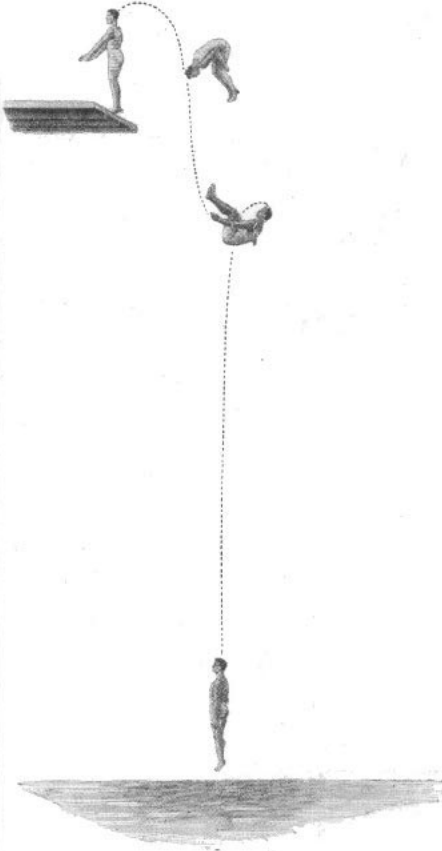

4. Backward spring outwards and turning inwards with somersault.

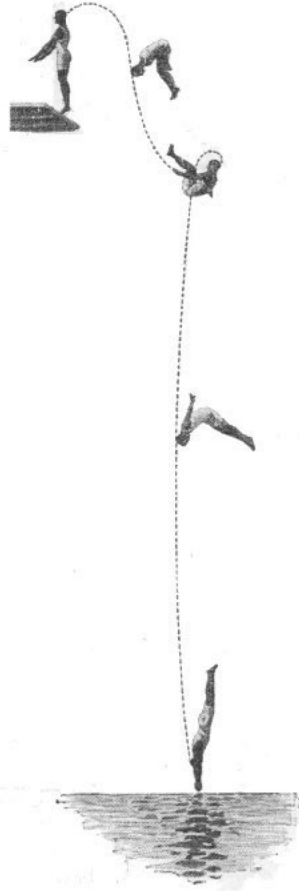

5. Backward spring outwards and turning inwards with somersault.

High Dive.

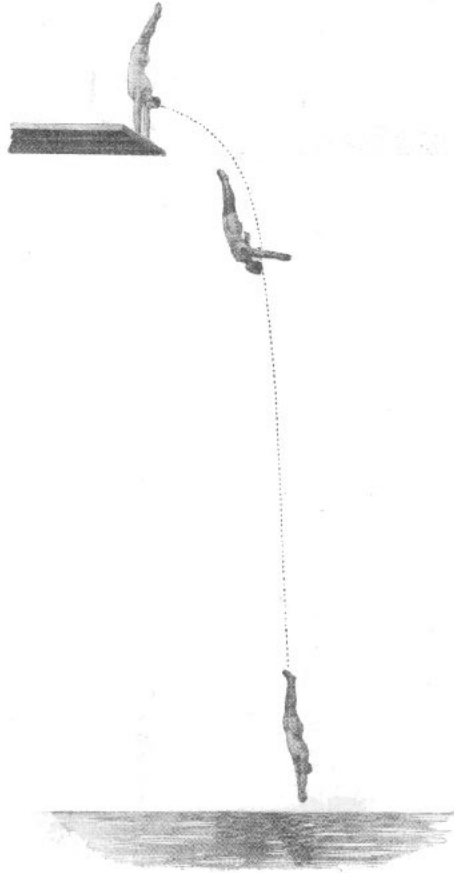

6. Armstand with header.

High Dive.

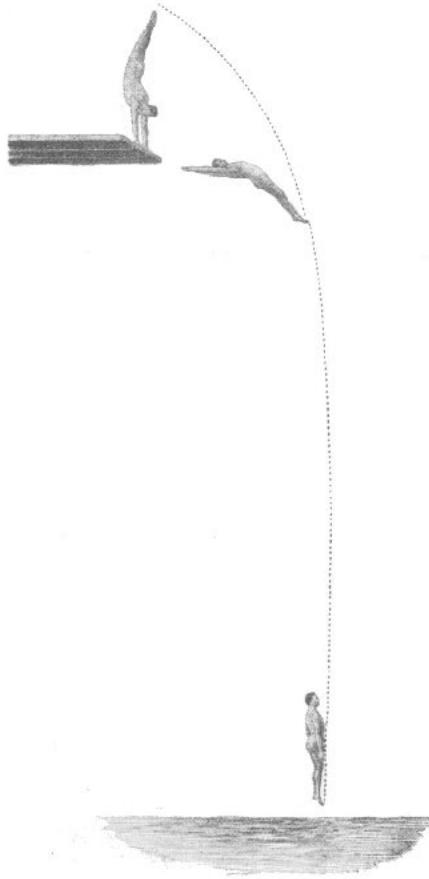

7. Armstand with overback.

High Dive.



8. Armstand with somersault.

High Dive.

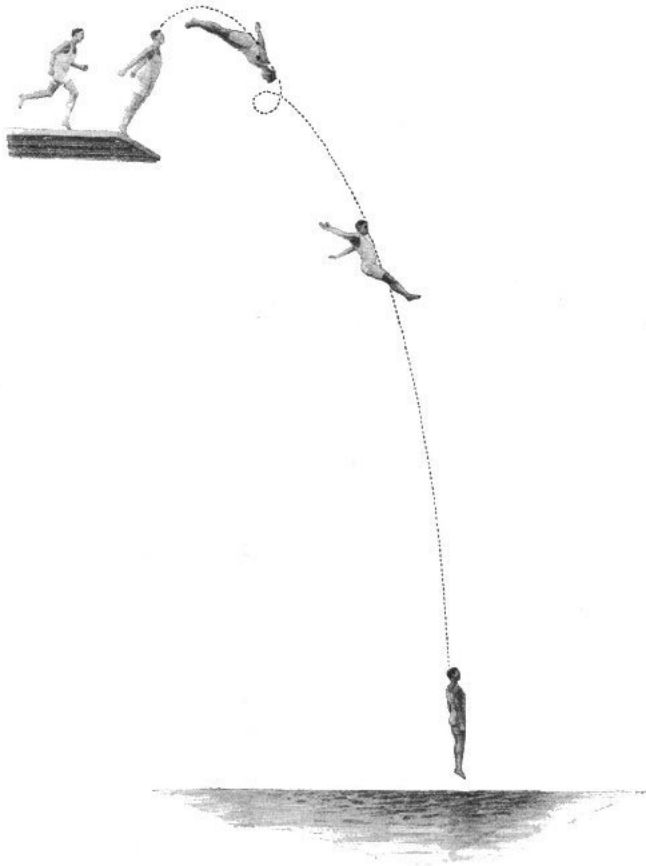

9. One somersault forwards.

High Dive.

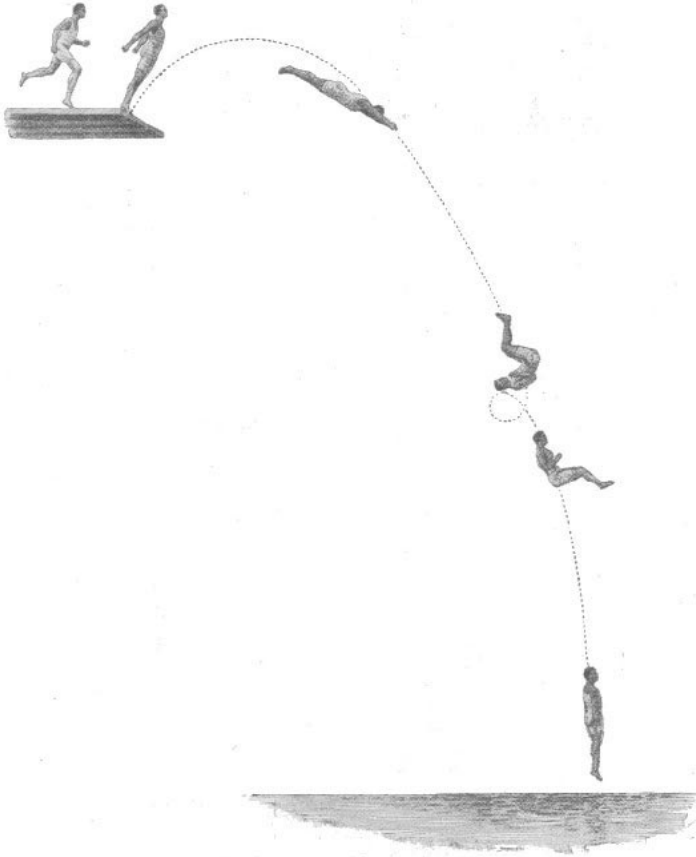

10. Flying somersault forwards.

High Dive.

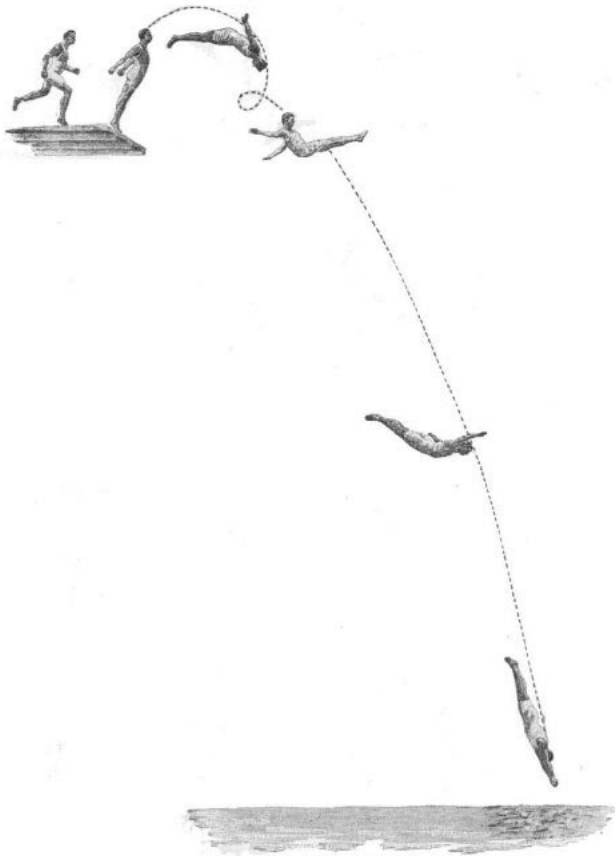

11. One and a half somersault forwards.

High Dive.

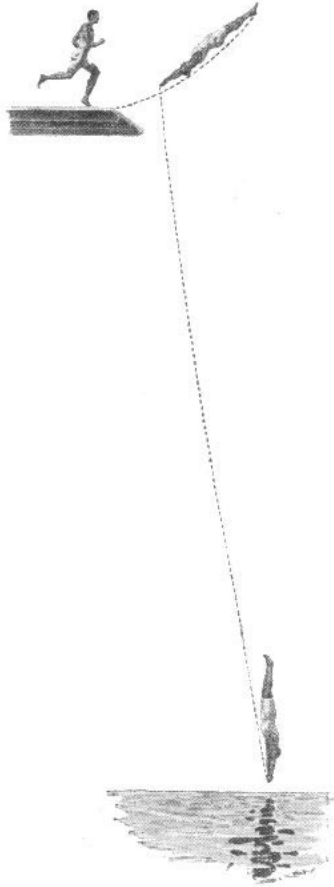

12. Islander's dive.

High Dive.

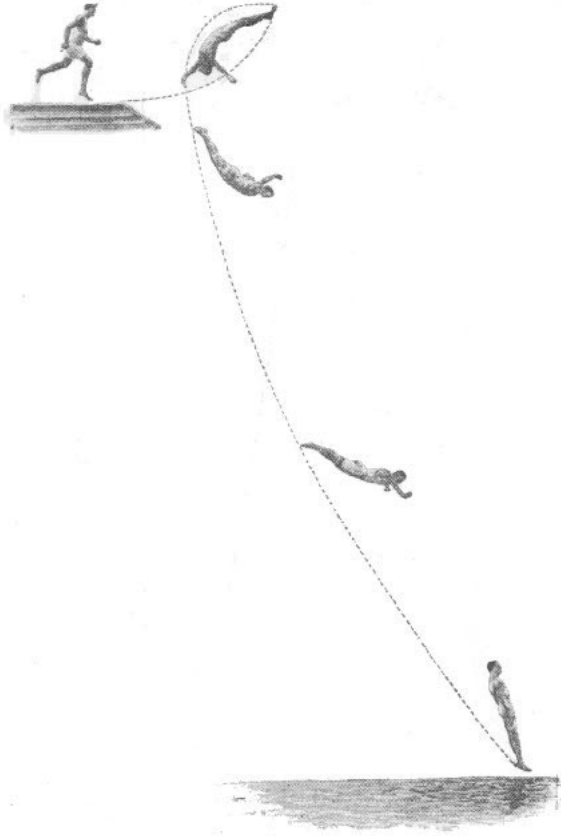

13. Mollberg's dive.

Spring Board Dive.

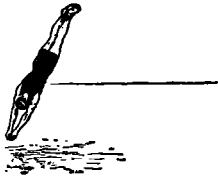

Plain Header.

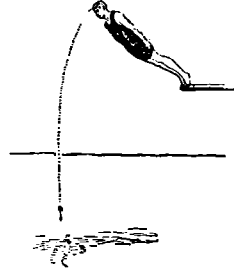

I. Falling Dive forwards.

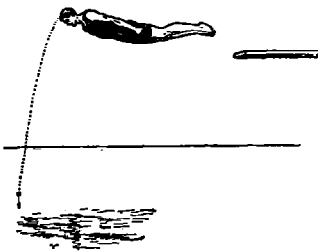

2. Ordinary header forwards,
(arms by sides).

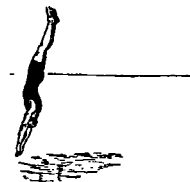

3. Screw Dive forwards
with half turn.

Spring Board Dive

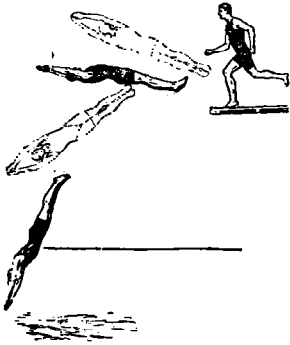

4. Screw Dive forwards with one turn.

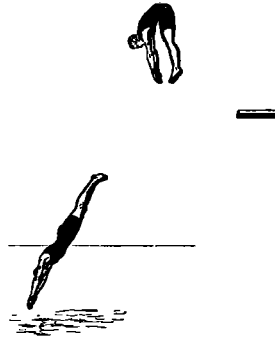

5. Pike Dive forwards.

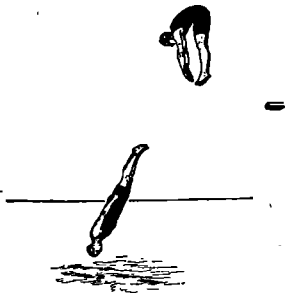

6. Pike Dive, (arms by sides).

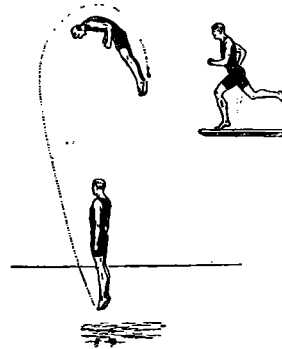

7. Forward somersault.

Spring Board Dive.

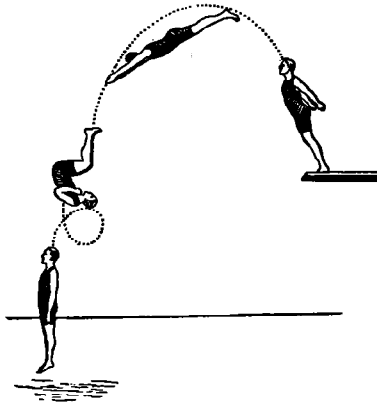

8. Flying somersault forwards.

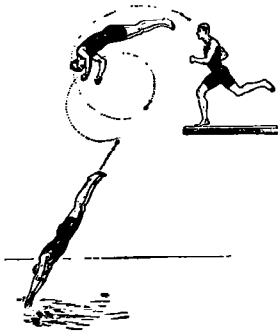

9. One and a half somersault.

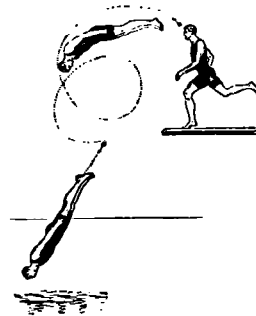

10. One and a half somersault,
(arms stretched by sides).

Spring Board Dive.

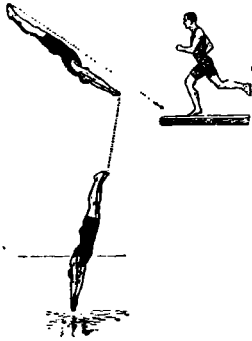

11. Isander's dive.

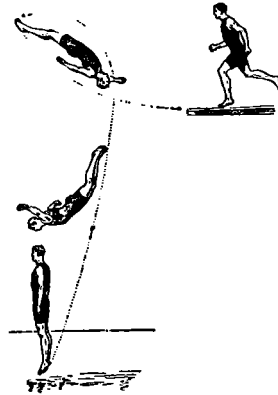

12. Mollberg's dive.

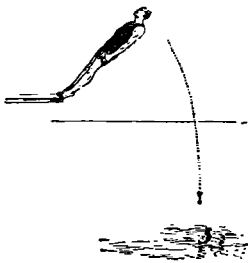

13. Falling dive backwards.

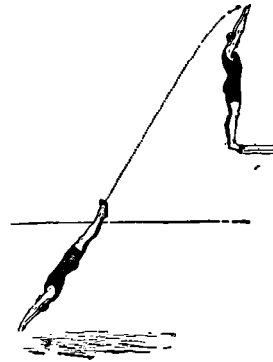

14. Ordinary header backwards.

Spring Board Dive.

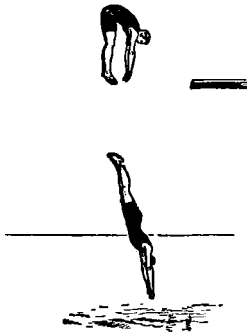

15. Pike dive with backward spring and turning inwards.

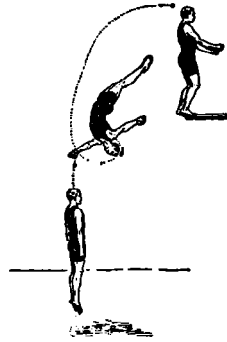

16. Backward somersault.

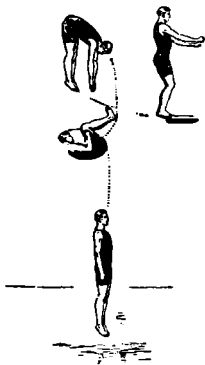

17. Pike dive with backward spring, turning inwards and somersault.



18. Pike dive with backward spring, turning inwards and $1\frac{1}{2}$ somersault.

WRESTLING.

General Regulations.

The competitions will be arranged by the Olympic Sub-Committee for Wrestling appointed by the Svenska Atletikförbundet (Swedish Athletic Union).

The competition shall be confined to amateurs according to the following definition:

An amateur is one who has never

- a) competed for a money prize or for monetary consideration, or in any way drawn pecuniary gain from the exercise of his sport;
- b) competed against a professional;
- c) taught in any branch of sport for payment;
- d) sold, pawned, hired out or exhibited for payment any prize won in a competition.

Special Rules.

1. In all competitions the ring shall not be less than 5 metres square, and shall be sufficiently soft.

2. Competitors must have their finger nails trimmed short, and must not wear rings on their fingers or have any metal substance, such as buckles, in their belts or on their clothes. The wrestling costume shall cover the body from the shoulders to half of the thigh. Tight-fitting swimming drawers, suspensors, etc., are to be worn under the costume.

3. The wrestlers are divided into the following weight classes:

Feather weight	up to	60	kilos (c:a	132	lbs.)
Light weight	» »	67 ¹ / ₂	»	(»	149 »)
Middle weight, A	» »	75	»	(»	165 »)
Middle weight, B	» »	82 ¹ / ₂	»	(»	182 »)
Heavy weight	over	82 ¹ / ₂	»	(»	182 »)

Weighing, without wrestling costume, takes place on the first day of competition in the respective classes. A competitor will be allowed to compete in a heavier weight class than that to which he belongs, but in one class only, however. Should a competitor be found too heavy for the class in which he has entered, he will have the right to compete in a heavier weight class on making immediate application.

4. At the beginning of the competition, the opponents approach each other, shake each other's right hand, then leave each other in the direction from which they started, whereupon the wrestling begins.

5. Wrestlers are forbidden to take hold of each other below the hips, and no part of an opponent's body, with exception of the hands and arms, may be seized except with the flat hand. Furthermore, it is forbidden (when done with the sole intention of incommoding an opponent) to touch his face from the eyebrows down to the lower part of the chin, to seize by the throat, belt, or to hold the mat; to trip, strike, kick, tear, pinch etc. Twisting of the arms or the so-called back-hammer-lock, and all painful and dangerous holds in general are also barred. At a backward grasp of the body, head down, the attacker must go on his knee, and must not dash his opponent's head on the carpet.

6. There shall be three judges, one of whom is to be referee and has to decide in case the other judges disagree. The officials are to intervene when dangerous grips are used, and have the power to disqualify any one who deliberately employs prohibited or dangerous holds.

7. A competitor who touches the carpet with both shoulders at the same time is defeated. Rolling falls are not counted. If during a rolling fall, a competitor has rolled from one shoulder to the other without having bridged, and afterwards, in the same way, has been forced back on to the first shoulder, this shall be

counted as a fall. Falls with only the shoulders and head on the carpet and the rest of the body outside are counted if the judges consider that the competitor was not prevented by the fall outside from defending or attacking.

In the event of a fall outside the carpet, dragging or carrying an opponent on to the carpet and there completing the fall is permitted, but, on the other hand, fresh holds must not be taken outside the carpet, unless an opponent is defending himself by getting off the carpet.

If the judges deem that, by falling outside the carpet, a competitor was not in a position to defend himself, the above conditions do not apply.

A competitor who intentionally gets off the carpet in order to avoid a fall shall be cautioned and, on repeating the offence, is liable to be disqualified.

One judge must not of his own accord stop a wrestling bout as decided, before he is assured that at least one of the other judges agrees with him. This can be conveniently arranged by the judge who considers it to be a fall raising his hand or uttering the word "Fall", whereupon the wrestling is immediately stopped as decided, if two judges agree.

8. The maximum limit for each bout is generally 60 minutes. If there has been no fall within the first 30 minutes, the judges can, nevertheless, declare the bout decided if one of the competitors has been continuously attacking, while the other has been almost entirely on the defence. This decision of the judges must, however, be unanimous, otherwise the bout is to be continued. If a further 30 minutes elapse without a fall, the bout is awarded to the one who has shown the best wrestling, i. e., who has made the most real attacks during the latter period. In order to decide this, the referee shall note the number of attacks which the competitors have made 'on each other during the latter period of 30 minutes. The attacks are reckoned by points: 1 point for a good attack, 2 for an attack by which an opponent is almost made to fall.

The referee calls out loudly and distinctly every time he notes an attack. If an attack is not accepted by both the other judges, it is not to be reckoned.

Should this system not lead to any definite result, the wrestling is to be continued for a further 30 minutes under the same conditions, and so on. If neither of the competitors has made any real attack during the first 30 minutes, or in the following bouts, the judges can declare both to be defeated; this decision of the judges must be unanimous.

If, at the end of a period, either of the competitors has such a hold on his opponent that a fall can be expected immediately, the wrestling shall not be stopped at once, but shall continue till some change takes place.

Rules for the Draws.

Principle: 2 defeats debar.

Opponents are drawn by lot.

Example: 1, 2, 3, 4, 5, 6, 7, 8, 9; 10, 11, etc.

Thus, in the first round the following wrestle:

1 — 2
3 — 4
5 — 6
7 — 8
9 — 10
and 11 has a bye.

The next round will be:

11 — 1
2 — 3
4 — 5
6 — 7
8 — 9, and finally
10 — 11.

All have now wrestled twice, and those who have been defeated twice retire, whereupon the remainder continue according to the order fixed, until so many have suffered two defeats that only three competitors remain. These three wrestle for the prizes without regard to the preceding results, according to the following conditions:

Example I:

A beats B, B beats C:

A I, B II, C III prize.

Example II:

A beats B, C beats B,

A beats C:

A I, C II, B III

Example III:

A beats B, C beats B,

C beats A:

C I, A II, B III

This wrestling for the prizes shall be decided by actual falls. The above-mentioned alphabetical designation is distributed after the wrestling of the first pair is decided; the winner is designated by A, the loser by B, and the competitor with a bye is designated by C. Opponents of the same nation are not to meet as long as it is avoidable. However, even if by so doing two opponents of the same nationality cannot avoid meeting, all must take part in every round, and odd numbers that occur, participate as first competitors in the following round.

If, in the preceding example, 1 and 2 have been of the same nationality, 1 and 3 meet instead, or the following competitors of different nationalities, 2 and 4, etc.

The protocol shall be drawn up according to the following plan, in which an example is given.

A win is indicated by +; a defeat by —

The time taken by each pair shall be recorded.

In the following plan the different pairs are indicated by running numbers to show the order in which they are to compete.

The different nations represented are indicated by A, B, C, etc.

Plan :

	1	2	3	4	5	6	7	8	9	10	11	12	13	14	15	16	17	18	19	
1 A	\	1 +	20 +			27 —													10 —	
2 B	1 —	\	11 —																	
3 C	20 —	11 +	\	2 +	28 +										32 +					
4 A			2 —	\		12 —														
5 A			28 —		\	3 —	13 +		21 +											
6 C	27 +			12 +	3 +	\				22 —			33 +							
7 C					13 —		\	4 +		29 —	23 +									
8 D							4 —	\		14 —										
9 D					21 —				\	5 —			15 +							
10 A						22 +	29 +	14 +	5 +	\								34 +		
11 D							23 —				\		6 —	16 +						
12 D												\	24 —	7 +	17 —					
13 E						33 —			15 —		6 +	24 +	\		30 +					
14 C											16 —	7 —	\							
15 F			32 —										17 +	30 —	\		8 +	25 +		
16 F																\	18 —	9 —		
17 B									34 —					8 —	18 +	\	31 +	26 +		
18 A														25 —	9 +	31 —	\	19 +		
19 B	10 +																26 —	19 —	\	

Thus, numbers 3, 6 and 10 survive to wrestle for the prizes, both the first-named with 1 defeat each, the last without any defeat.

All the others have retired with 2 defeats.

YACHT RACING.

GENERAL REGULATIONS.

1. At the request of the Swedish Olympic Committee, the Olympic Yacht Races will be organized by the Royal Swedish Yacht Club. The management will be in the hands of the Sailing Committee of the Club.
2. The helmsman and every member of the crew of a yacht competing in the Olympic yacht races, must be an amateur.
3. Every member of a recognized sailing club is an amateur, who has never carried on yacht sailing as a profession, nor, during the last five years, has followed other sailing as a trade.
4. Yachts and crews competing in the Olympic Yacht Races must be selected and entered by such National Authority as defined in the rules of the International Yacht Racing Union, or, where no such authority exists, by the Olympic Committee of that nation.
5. The amateur status of every competitor must be guaranteed by the National Authority, or, where no such authority exists, by the Olympic Committee of that nation.
6. Only two (2) yachts from every nation can be entered for each class.
7. A "nation" in the Olympic sense, is any country having such National Authority as defined in the rules of the International Yacht Racing Union, or having separate representation on the International Olympic Committee, or, where no such representation exists, any country recognized as a "nation" at the last Olympic Games, and, further, any sovereign state, not forming part of a states-union, as well as any states-union under one and the same sovereign jurisdiction.

Natural-born or naturalized subjects of a "nation" or of a sovereign state, of which a "nation" forms part, are alone eligible to represent that "nation" at the Olympic Yacht Races.

8. In each class there will be 2 ordinary races, with the following method of scoring:

1:st place	7 points
2:nd place	3 points
3:rd place	1 point

Should two or more yachts in any class tie under these conditions, they shall re-sail, as stated in the accompanying table.

9. The Olympic yacht races are arranged for the 6-, 8-, 10- and 12-Metre international R. classes.
10. The Olympic yacht races will be sailed under the racing rules of the International Yacht Racing Union, with the additions made in this notice.
11. The following prizes will be awarded in each class:
 - 1:st prize: Gold Olympic Medal to the helmsman, and silver-gilt Olympic Medal to every member of the crew.
 - 2:nd prize: Silver Olympic Medal to the helmsman and every member of the crew.
 - 3:rd prize: Bronze Olympic Medal to the helmsman and every member of the crew.

In addition to this, the Commemorative Plaque of the Royal Swedish Yacht Club will be presented to the owner of every prize-winning yacht.

12. In the 12-metre class, a Gold Olympic Medal will be presented to the mate or leading hand of the winning yacht, instead of the silver-gilt Olympic Medal, and, in the 6-metre class, the Challenge Cup of the French Government will be awarded to the owner of the winning yacht.

13. The number of persons allowed on board during the Olympic Yacht Races, in conformity with the rules of the International Yacht Racing Union is:

in the 12-Metre class	10
» » 10- » »	8
» » 8- » »	5
» » 6- » »	3

Persons in excess of the regulated number may be entered, but must be specially indicated as substitutes.

Note: According to regulation 2, every person on board must be an amateur.

14. There will be no entrance fee.
15. The prescribed fee to be lodged on entering a protest is Kr. 50 (45/-).
16. The Olympic Yacht Races will be sailed over courses at Nynishamn (in the vicinity of Stockholm).
17. Entry of a yacht and of every member of the crew, as well as of substitutes, should be made in writing, on special forms, to the *Kungl. Svenska Segel Sällskapet, Stockholm*, which, on application, will supply the entry forms and will give every information desired. Entry of a yacht must be accompanied by a certificate of rating in original or confirmed copy, stating the immersion of the yacht in fresh water.
18. The Sailing Committee will hold a survey of the competing yachts to see whether the prescribed salt- and fresh-water marks and the spar marks, if any, have been attached, and that the maximum immersion of the yacht is as indicated by the fresh-water marks; and for this survey a competing yacht must report her presence in Nynäshamn to the office of the Royal Swedish Yacht Club there not later than noon, Friday July 19, 1912.
19. Entries for the Olympic Yacht Races close at 8 p. m., Thursday, 20 June 1912. Notice of entry given by telegram, sent before noon, 20 June 1912, will be accepted, if confirmed by post, by a written entry enclosing the prescribed documents.
20. Starting programme, sailing instructions and numbers will be supplied between 16—18 July at the office of the "Kungl. Svenska Segelsällskapet", Kastellholmen, Stockholm, and between 19—22 July at the office of the Club at Nynäshamn.

Table

giving all possible results of the two ordinary races.

In each of the two ordinary races 7 points will be given for a first place, 3 for a second and 1 for a third.

Highest number of points for a yacht after the two ordinary races.	Number of points for other yachts placed, after the two ordinary races.	R e - s a i l i n g :
14	6 . 2	No re-sailing.
14	6 . 1 . 1	Yachts with 1 point re-sail for the 3:rd prize.
14	4 . 4	Yachts with 4 points re-sail for the 2:nd and 3:rd prizes.
14	4 . 3 . 1	No re-sailing.
14	3 . 3 . 2	} Yachts with 3 points re-sail for the 2:nd and 3:rd prizes.
14	3 . 3 . 1 . 1	
10	10 . 2	Yachts with 10 points re-sail for the 1:st and 2:nd prizes.
10	10 . 1 . 1	Yachts with 10 points re-sail for the 1:st and 2:nd prizes, and yachts with 1 point re-sail for the 3:rd prize.

Highest number of points for a yacht after the two ordinary races.	Number of points for other yachts placed, after the two ordinary races.	R e - sailing:
10	8 . 4	} No re-sailing.
10	8 . 3 . 1	
10	7 . 4 . 1	
10	7 . 3 . 2	
10	7 . 3 . 1 . 1	
8	8 . 6	Yachts with 8 points re-sail for the 1:st and 2:nd prizes.
8	8 . 3 . 3	Yachts with 8 points re-sail for the 1:st and 2:nd prizes, and yachts with 3 points for the 3:rd prizes.
8	7 . 6 . 1	} No re-sailing.
8	7 . 4 . 3	
8	7 . 3 . 3 . 1	
7	7 . 6 . 2	Yachts with 7 points re-sail for the 1:st and 2:nd prizes.
7	7 . 4 . 4	Yachts with 7 points re-sail for the 1:st and 2:nd prizes, and yachts with 4 points for the 3:rd prize.
7	7 . 4 . 3 . 1	Yachts with 7 points re-sail for the 1:st and 2:nd prizes.
7	7 . 3 . 3 . 2	} Yachts with 7 points re-sail for the 1:st and 2:nd prizes, and yachts with 3 points for the 3:rd prize.
7	7 . 3 . 3 . 1 . 1	

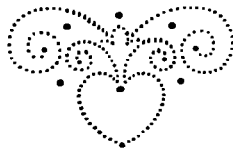

AFTERMATH.

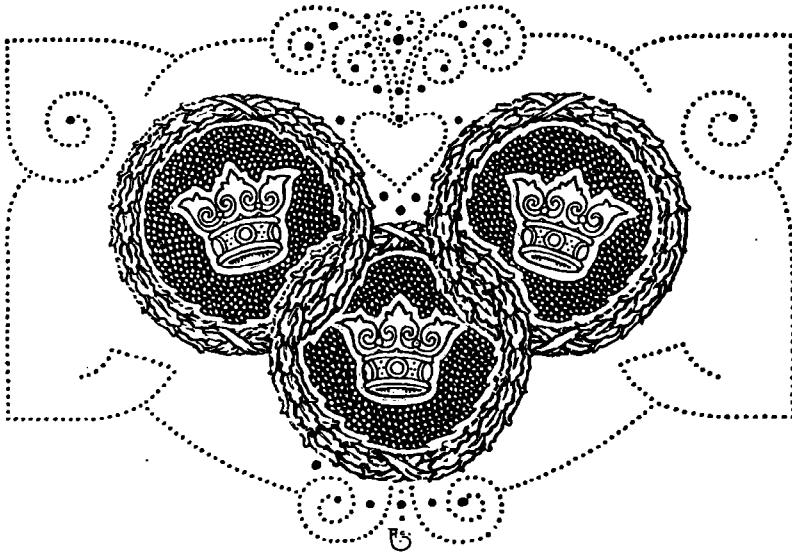

AFTERMATH.

The aftermath of the Fifth Olympiad has been rich almost beyond expectation. Addresses of thanks have flowed in from far and near, and everywhere in the world the newspapers published lengthy descriptions of the Games. Large numbers of letters and telegrams have been sent by corporations and private persons, and the Swedish Olympic Committee has received much other evidence that its work for the organization of the Olympic Games of Stockholm 1912, was appreciated both within and beyond the borders of Sweden. It would require volumes to give anything like a complete summary of what has been said of the Olympic Games of Stockholm and their organization, but a more suitable conclusion to this Report cannot be found than the publication of the official communications in this respect received from the International Olympic Committee, the National Olympic Committees, and other similar bodies.

Letter addressed, after the close of the Games, by Baron Pierre de Coubertin, President of the International Olympic Committee, to H. M. King Gustaf V.

Sire.

Au nom du Comité International Olympique, je viens présenter à Votre Majesté ainsi qu'à Sa Majesté la Reine le tribut de notre très respectueuse gratitude.

Par l'assiduité de son auguste présence aux Jeux, par la création de la Médaille commémorative, par tant de marques précieuses d'une persévérante bienveillance. Votre Majesté a pris une part considérable au succès de cette magnifique Olympiade.

Grâce à la nation Suédoise dont l'effort unanime fut guidé par celui de son plus noble fils, l'Olympisme renaissant remporte une victoire décisive. Il nous est agréable de penser que l'Olympisme à son tour a procuré à la Suede un surcroît d'intelligente sympathie de la part des peuples divers qui furent représentés aux Jeux par l'élite de leurs forces juvéniles.

Je prie Votre Majesté ainsi que Sa Majesté la Reine de daigner accepter au soir de ces fêtes inoubliables, avec l'expression de notre fidèle reconnaissance l'hommage de notre plus profond respect.

PIERRE DE COUBERTIN.

*H. M. The King's reply to Baron
Pierre de Coubertin.*

Monsieur le Baron,

S. M le Roi me charge de vous présenter les vifs sentiments de reconnaissance de sa part de même que de la part de Sa Majesté la Reine pour les mots aimables que vous venez d'adresser à LL. MM.

Ainsi qu'il est dit dans le discours du Roi au moment de l'inauguration, Sa Majesté tient à vous répéter qu'Il considère comme un grand honneur pour son pays d'avoir reçu dans sa capitale tous les délégués des différentes nations représentant l'élite des fils de chaque pays.

Ayant l'espoir que les Jeux Olympiques de Stockholm demeureront un bon souvenir pour tous les participants, Leurs Majestés vous adressent à vous, Monsieur le Baron, ainsi qu'à tous les membres du Comité International, leurs compliments pour la belle oeuvre que vous venez de terminer.

Par ordre du Roi:
Le maréchal de la Cour,
DE P EYRON.

*Letter sent by Baron Pierre de Cou-
bertin to the Swedish Olympic Committee.*

22 Juillet, 1912.

Monsieur le Président, Messieurs et chers collègues.

Au nom du Comité International Olympique je viens vous exprimer notre gratitude et en même temps notre admiration sincère pour la célébration de cette V^{ème} Olympiade à laquelle vous avez su donner un éclat incomparable.

Nous vous prions d'accepter avec l'expression de ces sentiments le souhait que nous formons tous pour la consolidation des liens de bonne amitié qui se sont noués entre nous tous au cours de ces journées inoubliables.

Le Comité qui a réalisé de pareille façon une oeuvre si considérable est de ceux dont la collaboration est entre toutes précieuse et désirable pour le développement et le progrès de l'institution Olympique.

Nous y comptons, n'est-ce pas? et saisissons cette occasion de vous remettre ci-joint l'invitation à prendre part au grand congrès de Paris en 1914.

Veuillez, Monsieur le Président, Messieurs les Membres du Comité Suédois, trouver ici l'assurance de nos sentiments les plus affectionnés et les plus dévoués.

PIERRE COUBERTIN.

*Letter from Colonel Charles Graves,
U. S. A. Minister in Stockholm.*

Legation of the
United States of America.
Stockholm, September 24th 1912.

Excellency,

I have the honor, by direction of the Department of State, to beg you to convey to His Majesty the King of Sweden, to the War Department of Sweden and to the Authorities of the Olympic Games, an expression of the sincere appreciation by the Honorable H. L. Stimson, Secretary of War of the United States, of the honors and courtesies shown to the representatives of the United States War Department at the Fifth Olympiad at Stockholm.

I take this opportunity to renew to Your Excellency the assurance of my most distinguished consideration.

His Excellency
Count Albert Ehrensward,
Minister for Foreign Affairs.

CHARLES GRAVES.

*Letter sent by Colonel Robert M.
Thompson, President of the U. S. A.
Olympic Committee, to H. R. H. Crown
Prince Gustaf Adolf.*

On board S. Y. Catania, Stockholm, July 19, 1912.

Your Royal Highness,

For the American Olympic Games Committee and the American athletes I thank you, and, through you, the Swedish Committees, for the hospitality extended to us and our athletes. I wish also to express my appreciation of the perfection of detail and management of the Games, which will make the Fifth Olympiad ever remembered as the model of what such Games should be.

I am, with great respect,

Your obedient servant,
ROBERT M. THOMPSON.
President American Olympic Games Committee.

Letter from Colonel Robert M. Thompson.

On board S. Y. Catania, Stockholm, July 19, 1912.

My dear Colonel Balck,

For myself and for the American athletes I thank you, and, through you, all the members of your several Committees, for the constant kindness and hospitality with which you have received and treated us since our arrival in Sweden.

We return home in love with your land, its brave men and its beautiful women, and we will long remember the Fifth Olympiad as the model of what Olympic Games should be.

Believe me,
Very cordially yours,
ROBERT M. THOMPSON
President American Olympic Games Committee.

*Letter from James E. Sullivan, Esq.
Secretary to the U. S. A. Olympic Com-
mittee.*

September 18th, 11.

Col. Victor G. Balck, President,
Kristian Hellström, Secretary,
Swedish Olympic Committee,
Stockholm, Sweden.

My dear Sirs,

I beg to acknowledge receipt of yours of the 4:th inst. and I thank you very much indeed for the kind expressions contained therein. It was a pleasure to have supported you in your work. During my many years' connection with athletics, I have never worked with a Committee that gave the entire satisfaction that the Swedish Olympic Committee did. In all our dealings with you, you were prompt and courteous, and when we asked favours, they were cheerfully granted. So, on the whole, it was a pleasure to have worked for Sweden, and I hope when the Games travel around from country to country, we will all be alive and that they will again be held in your beautiful city and we can again enjoy your kind hospitality. The Games ended with good feeling all around, and all the Americans were happy and satisfied. I feel sure the hundreds of Americans in our party will agree with me in these expressions.

Yours very truly,
JAMES E. SULLIVAN
Secretary American Committee.

*Letter from Professor W:m M. Sloane,
Member of the International Olympic
Committee.*

Hotel Rose, Wiesbaden, Sept. 15, 1912.

Dear Mr. Hellström,

When you look at the token of American respect and good will you will remember that, without exception, every American present at Stockholm, whether as participant or onlooker, carried away the most pleasant memories of their own kind treatment — and something far more; a profound respect for the Olympic Institution itself and gratitude to those who raised it to the height of its full importance by prudence, forethought, capacity and hospitality. Among these you were not the least.

Ever sincerely
W:M M. SLOANE.

*Letter from Mr. J. W. Hill, Leader of
the Australasian Swimming Contingent.*

8, Bayley Street, London, W. C., 9th August 1912.

Kristian Hellström, Esq.,
Olympiska Spelen,
Stockholm.

Dear Sir,

I have to acknowledge receipt of your letter of the 2:nd instant, and to thank you for the sentiments expressed therein. I can assure you both personally and on behalf of the small Australian team, that our memories of Stockholm are all

pleasant ones, and that our stay there will always be a green spot in our lives to look back upon. The small swimming team, which, with myself, arrived as the first of the foreign competitors to reach Sweden, are especially indebted to you, your Committee, and the good people of Sweden for their exceedingly enjoyable sojourn in your city. I have already acknowledged our indebtedness to the President of the Swimming Committee, and now take this opportunity of thanking you and congratulating you on the brilliant success of the Fifth Olympiad, due mainly to your own self-sacrificing and unselfish work of organisation. Perhaps it may be some recompense to you to think that your labours are appreciated by the small contingent from far-off Australia, to whom not the least pleasing feature of the Olympic Games of 1912 is that the country which received them in such a hospitable manner, has the honour of heading the list of the competing nations.

— — — — —

Yours very faithfully,

J. W. HILL.

Australian Olympic team 1912.

Letter from the Austrian Swimming Association.

Wien, den 5. April 1913.

Verehrliches

Organisationskomitee der

Olympischen Spiele in Stockholm,

Stockholm.

In höflicher Beantwortung Ihrer sehr geehrten Zuschrift vom 2. d. M. danken wir Ihnen herzlichst für das schöne Erinnerungszeichen in Form des Diplomes.

Es hätte aber wahrlich keines Diplomes bedurft, um uns Schwimmern Ihre liebe Heimatsstadt dauernd in Erinnerung zu bringen.

Die sonnigen Tage, die Ausflüge nach Saltsjöbaden und Sandhamn und last but not least die Liebenswürdigkeit der schwedischen Damen und Herren, die uns den Aufenthalt so angenehm als möglich machten, wird dem schönen nordischen Venedig ein dauerndes Andenken in unseren Herzen bewahren.

Hoffentlich ist uns in absehbarer Zeit die Gelegenheit gegeben, Ihnen bei dem gleichen Anlass in Wien die edle Gastfreundschaft, die Sie uns gewährten, zu erwidern.

Genehmigen Sie die herzlichsten schwimmsportlichen Grüsse und den verbindlichsten Dank für die schöne Erinnerung von Ihrem erg.

Verband der Österreichischen Schwimmvereine.

FRANZ SCHUH.

Letter from Baron de Laveleye, President of the Belgian Olympic Committee.

Jette St. Pierre $\frac{5}{8}$ 1912.

Monsieur Kr. Hellström,

Secrétaire du Comité des Jeux Olympiques,

Stockholm.

Cher Monsieur,

Je viens de rentrer en Belgique et reçois votre aimable lettre du 31 Juillet.

Je suis très heureux, en réponse, de pouvoir vous exprimer la très vive recon-

naissance éprouvée par toute notre délégation pour l'accueil véritablement excellent que nous avons reçu de votre comité dans la superbe ville de Stockholm.

Il y a un ou deux choses dans un don: le don lui-même et la manière de le donner;

Je puis vous assurer que votre Comité a réussi à joindre de manière parfaite la réception de ses hôtes la plus brillante et la plus hospitalière à l'offre du spectacle sportif le plus complet et le mieux organisé qu'il nous a été donné d'admirer jusqu'ici.

Je vous prie d'être auprès de votre président et votre comité l'interprète de la délégation belge tout entière et de croire personnellement à mes meilleurs sentiments de très sincère et de très vive cordialité.

Le Président du C. B. J. O.
Baron DE LAVELEYE.

*Letter from Mr. E. Henrion, Secretary
to the Belgian Olympic Committee.*

Etterbeek-Bruxelles, le 5 Octobre 1912.

Monsieur le Président,

Très flatté de votre très honorée lettre du 5 Septembre 1912 m'exprimant les remerciements de votre Comité pour les quelques services que j'ai rendu aux Jeux Olympiques, je m'empresse de vous exprimer toute la satisfaction que j'ai eue de travailler pour une aussi noble cause et l'agrément que j'ai éprouvé à correspondre avec un comité exécutif aussi parfait que le vôtre.

Je suis heureux de remercier tout particulièrement Monsieur le Secrétaire Général de l'empressement et de la grande amabilité qu'il a toujours mise dans nos rapports.

Veuillez agréer, Monsieur, l'expression de ma haute considération.

A Monsieur le Président du Comité
d'Organisation des Jeux Olympiques,
Stockholm.

E. HENRION.

*Letter from the Bohemian Olympic
Committee.*

Prague le 26 juillet 1912.

Le Comité d'Organisation des Jeux Olympiques 1912,
Le Secrétariat, à Stockholm.

Messieurs,

Le Comité Olympique Tchèque se permet, à l'occasion de la clôture de la cinquième Olympiade, de Vous exprimer ses félicitations très sincères de la splendide réussite des Jeux Olympiques à Stockholm. Grâce à Votre effort l'oeuvre de la réorganisation des Jeux Olympiques a atteint une hauteur inattendue, mais digne de la grande idée de son initiateur Mr. le Baron Pierre de Coubertin.

Ensuite le Comité Olympique Tchèque Vous remercie très chaleureusement de tant de gracieuse hospitalité dont les Tchèques avaient été l'objet pendant tout leur séjour à Stockholm.

Nous n'oublierons jamais, avec laquelle bienveillance le Comité d'organisation suédois avait accueilli, au cours de nos travaux mutuels, tous nos voeux et nos désirs.

Veillez agréer, Messieurs, l'expression de nos sentiments meilleurs et les plus reconnaissants.

Le Comité Olympique de la Bohême

Le Président:
Dr. JIRI GUTH.

Le Secrétaire Général :
I. ROESSLER-OROVSKY.

Telegram sent by Dr. Jiri Guth, President of the Bohemian Olympic Committee, to H. R. H. the Crown Prince Gustaf Adolf.

Son Altesse Royale Prince Royal de Suède, Stockholm.

Comité Olympique Tchèque Prague à l'occasion de clôture de cinquième Olympiade félicite Comité Suédois de splendide organisation des Jeux et remercie Votre Altesse Royale de tant de grâces envers les Tchèques en présentant ses hommages les plus respectueux.

Dr. JIRI GUTH,
Président.

Letter from the British Olympic Council.

London, S. W., 21st August, 1912.

Dear Sir,

Owing to the serious illness of Mrs. Laffan I am dealing with correspondence on behalf of Mr. Laffan.

At the meeting of the British Olympic Council held on 21st August, the Secretary was instructed to convey to the Swedish Olympic Committee, on behalf of the British Olympic Council, their very high sense of gratitude for the kindness and hospitality which had been received by the representatives of Great Britain during the Olympic Games of Stockholm 1912, and at the same time to thank and congratulate the Swedish Olympic Committee on the stimulus afforded to the Olympic movement by their successful conduct of the Games.

I am, Dear Sir,
Your obedient servant,

To The Secretary,
Swedish Olympic Committee.

F. W. JONES.
Hon. Treas.

Letter from the English Amateur Athletic Association.

London, August 2nd, 1912.

Kristian Hellstrom, Esq.,
Olympiska Spelen, Stockholm.

Dear Ur. Hellstrom,

I am writing on behalf of the members of the English Athletic Team to thank you for your courtesy and kindness during our stay in Sweden for the Olympic Games of Stockholm. Although we did not do so well in the athletic events as we had hoped and expected, we have, I trust, taken our defeat as true sportsmen should. All our men are loud in their praises of the Swedes and all thoroughly enjoyed their visit to your beautiful country. May I take the opportunity of offer-

ing our congratulations on Sweden's success in heading the list of nations.
It was a splendid performance of your country

With apologies for troubling you at such length and with many thanks for all
your kindnesses.

Believe me,
Yours sincerely,
S. G. Moss,
Assistant Secretary.

(Translation.)

Letter from Mr. M Kähni, Technical Leader of the Chilian Contingent at the Games.

Stockholm, 31 July, 1912.

To the Swedish Olympic Committee.

As the moment is approaching when I shall be obliged to leave Sweden and begin the return journey to my distant native land, Chili, I wish, before leaving, to address a few words of gratitude to the Organization that has directed the Olympic Games of Stockholm.

I and my fellow-countrymen who came here to take part in the Games have enjoyed the friendship and hospitality of Swedish athletes in such full measure, that we feel we owe you an eternal debt of thanks, and I have been honoured by the commission to hereby convey to the Swedish Olympic Committee, the deep-felt gratitude of the Chilians for the memorable weeks we have spent in Sweden.

As technical leader of the Chilian Delegation to the Olympic Games, may I be permitted to express my sincere admiration of the work you have carried out for the promotion of international athletics during the course of these Games, which will long remain an example for all nations of the manner in which such international competitions can, and ought to be organized.

What we have learned at the Olympic Games of 1912 will, without doubt, tend most powerfully to the promotion of athletics in Chili, and it will be an honour and a duty for me to show the leading sportsmen in my native country that Swedish athletics, its votaries and protectors, are our best teachers.

Yours most respectfully

M. KÄHNI

Technical Leader of the Chilian Delegation to the
Olympic Games of Stockholm 1912.

(Translation.)

Letter from the Danish Olympic Committee.

Copenhagen, 17 August, 1912.

To the Swedish Olympic Committee, Stockholm,

The Danish Olympic Committee begs herewith to send its hearty thanks for all the hospitality and good will experienced by the Danish athletes during their stay at the Olympic Games of Stockholm.

The Danish Committee seizes the opportunity to express its admiration of the excellent manner in which the Olympic Games of Stockholm were organized and directed.

FRITZ HANSEN,
President of the Committee.

Yours faithfully
NATHANSEN
Vice-President and Acting-Secretary.

(Translation.)

Telegram from the Icelandic Athletes.

The Olympic Games, Stockholm.

Icelandic athletes send Swedish Olympic Committee best thanks for all kindness shown during the Games.

Yours faithfully
PJETURSSON.

*Letter from Baron F. W de Tuyll
de Serooskerken, President of the Dutch
Olympic Committee.*

Au Comité d'organisation des Jeux Olympiques à Stockholm.

Avant de quitter votre ville de Stockholm le soussigné, Président du comité Olympique en Hollande, prend la liberté de vous offrir les plus sincères remerciements pour la façon si aimable et si courtoise dont Vous avez accueilli les participants aux jeux olympiques. Votre organisation était si parfaite, Votre accueil si chaleureux, Votre dévouement à la cause si profond que tout en Vous félicitant de tout coeur pour le splendide résultat obtenu, nous Vous donnons l'assurance que le souvenir de la V:ème Olympiade restera à jamais gravé dans notre mémoire.

Veillez agréer, Messieurs, mes sentiments les plus reconnaissants et très dévoués.

F. W. DE TUYLL DE SEROOSKERKEN.

Stockholm le 17 juillet 1912.

(Translation.)

Letter from the Finnish Olympic Committee.

To the Swedish Olympic Committee,
Stockholm,

The Finnish Olympic Committee assembled for the first time after the Olympic Games of Stockholm unite, in their own names and on the part of all the Finlanders who took part in the Games, to express, first, their unfeigned admiration of the brilliant manner in which the Swedish Olympic Committee carried out its trying task, and then their warm thanks for the hospitality, good will and sympathy that the representatives of Finland had the pleasure of experiencing in every quarter during the memorable weeks in Stockholm.

The unexpected great success of the Finnish athletes during the Games would, of itself, be calculated to make the Fifth Olympiad one of the dearest and most lasting memories that can ever find a place in their hearts and in those of their fellow countrymen. The joy we experience at our success would not be so unmixed, however, if we had not also experienced how the ancient bonds of friendship uniting Swedish and Finnish athletes had been retained and strengthened by their meetings during the summer of 1912.

The firm hope of the long continuance of this good understanding which, based

as it is on mutual respect, friendship and confidence, is of such value for the athletic life of our country, increases the gratitude with which we shall always retain the memory of the glorious, sunshine-filled Olympiad of 1912 — the greatest, most important, most brilliant and best-organized athletic festival the world has ever seen.

Helsingfors, August 1912.

For the Finnish Olympic Committee:

R. F. v. WILLEBRAND.

IVAR WILSKMAN.

AD. FR. LONDEN.

AUGUST LUNDQVIST.

GÖSTA WASENIUS.

UNO WESTERHOLM.

ERNST KROGIUS.

(Translation.)

Telegram from Finnish athletes

The Swedish Olympic Committee, Stockholm.

Being about to return to our native country after unforgettable, sunny Olympic weeks in Stockholm, Finland's athletes send, from the depths of their hearts, their warm and respectful thanks to the Swedish Olympic Committee, to the leaders and officials of the competitions, to fellow competitors, to the City of Stockholm, and to the people of Sweden.

Letter from Paul Rousseau. Vice-President of the French Cycling Association.

24, Boulevard Poissonnière, Paris, le 7 Août 1912.

Monsieur Kristian Heliström,

Secrétaire du Comité des Jeux Olympiques,

Hamngatan I A,

Stockholm, Suède.

Monsieur le Secrétaire.

J'ai bien reçu, à mon retour de Stockholm, votre lettre du 31 Juillet. Je vous en suis très reconnaissant. J'avais eu, du reste, l'honneur de vous rendre visite avant mon départ et je vous avais laissé ma carte, mais je n'ai pas eu le plaisir de vous rencontrer.

Les Jeux Olympiques sont, en effet, terminés mais, nous en aurons retenu, comme vous, de profitables enseignements, et je suis persuadé, qu'un jour, nous nous rencontrerons encore dans quelque réunion sportive pour arriver, à donner, si possible, à toutes les épreuves de sport une organisation meilleure et obtenir de la part de tous les pays, des manifestations de plus en plus nombreuses et de plus en plus profitables pour les sports.

En vous remerciant encore et en vous disant combien le me félicite de mon voyage en Suède, je vous prie d'agréer, Monsieur le Secrétaire, l'expression de mes sentiments les meilleurs et les plus distingués.

Le Vice-Président de l'U. V. F.

PAUL ROUSSEAU.

Letter from the German Olympic Committee.

Berlin, den 12. Oktober 1912.

Hochgeehrter Herr Oberst!

Im Namen des Deutschen Reichs-Ausschusses für Olympische Spiele sage ich Ihnen hiermit für die liebenswürdige Aufnahme und umfassende Gastfreundschaft,

welche wir alle während unseres Aufenthalts in Stockholm fanden, unseren verbindlichsten Dank.

Während der unvergleichlich schönen Tage der V. Olympiade haben viele unserer jungen Sportsleute mit den schwedischen Kameraden enge Freundschaft geschlossen und ich gebe der Zuversicht Ausdruck, dass diese Freundschaft eine dauernde und der Ursprung immer festerer Beziehungen zwischen den beiden stammverwandten Nationen sein wird.

Möge es uns vergönnt sein, Sie und die schwedischen Sportsleute im Jahre 1916 hier in Berlin recht zahlreich zu begrüßen, um unsere Dankbarkeit beweisen und zu einem Teil abtragen zu können.

Mit dem Ausdruck meiner besonderen Hochachtung verbleibe ich, Herr Oberst,
Ihr sehr ergebener

VON PODBIELSKI,
Staatsminister
Präsident des Deutschen Reichsausschusses
für Olympische Spiele.

An das Schwedische Organisationskomitee
der V. Olympiade
Z. H. des Herrn Oberst Balck,
Stockholm.

*Letter from the Hungarian Olympic
Committee.*

Budapest, am 9.-ten September 1912.

Hochlöbliches Schwedisches Olympisches Organisationscomité,
Stockholm.

Das Präsidium des Ungarischen Olympischen Comités, von Stockholm zurückgekehrt, erachtet es als seine angenehme Pflicht so dem Schwedischen Olympischen Comités, wie auch allen jenen, die an dem Arrangement der Stockholmer Olympiade mitgearbeitet haben, seinen aufrichtigsten und innigsten Dank auszusprechen.

Sämtlichen Ungarischen Teilnehmern, werden so der grossartigen Empfang, wie auch die gastfreundliche Aufnahme, ewig unvergesslich bleiben. Es ist uns die Möglichkeit geboten worden die Schweden kennen und lieben zu lernen, und haben wir Ihre grossartige Kultur bewundert.

Als Sporttreibende haben wir mit Bewunderung das exacte und unerreichbar correcte Arrangement bestaunt.

Das vollkommen precise und sportlich correcte Arrangement bezeugte die muster-giftige Arbeit unserer Schwedischen Sportfreunde, dieses Arrangement kan einer jeden nachfolgenden Olympiad nur als leuchtenden Beispiel dienen.

Wir sind dessen fest überzeugt, dass die allgemeine Anerkennung, welche von einen jeden Kulturstaate Ihnen zuteil wurde, das für die geleistete übermenschliche Arbeit, der schönste Preis ist.

Indem wir noch die herzlichste Gratulation Ihnen darbringen zu jenen grossartigen und gutverdienten Erfolgen, welche die Schwedische Nation im grossen Turnier der Völker erreicht hat, ersuchen wir Sie, dass Sie unsere Nation in angenehmer Erinnerung halten mögen.

Uns bestens empfehlend verbleiben mit ganz besonder Hochachtung.

MAGYAR OLYMPIAI BIZOTTSAG,
Comité Olympique Hongrois.

LAUBER,
Secretär.

DE GERENDAY,
Vicepräsident.

JULES VON MUZSA,
Präsident.

(Translation.)

Letter from the Norwegian Olympic Committee.

Gardermoen, 7 August, 1912.

The Swedish Olympic Committee, Stockholm.

On behalf of the Norwegian Olympic Committee I beg to send the Swedish Olympic Committee the heartiest and most respectful thanks for all that it has done during the Fifth Olympiad in Stockholm, which has just ended.

Just as this Olympiad will always remain a brilliant event in the history of Sweden, so it will be an example to be followed by us all. We admired the clear planning; we have watched its execution with the same admiration, and we have brought home with us to our nation a sum of useful and fundamental experience.

On the part of all the Norwegian competitors and officials who shared in the Fifth Olympiad I beg to remain.

Yours most respectfully
JOHAN SVERRE,
President.

(Translation.)

Letter from Dr. Jayme Mauperrin Santos, President of the Portuguese Olympic Committee.

Lisbon, 21 August, 1912.

At an ordinary meeting held under my presidency, the Portuguese Olympic Committee unanimously resolved to write to you to express the deep sense of recognition and gratitude for your unwearied care and protection of the Portuguese competitors during the whole of their stay in Stockholm, as well as for the tokens of deep sympathy you evinced on the lamentable occasion of the death of our fellow — countryman, Francisco Lazaro. The only return the Portuguese Olympic Committee can make for all this exceeding kindness is this expression of its indelible sense of gratitude.

With fraternal greetings,
DR. JAYME MAUPERRIN SANTOS,
President.

Letter from G. Duperron, Secretary to the Russian Olympic Committee.

Le 2 Septembre 1912.

Monsieur Kristian Hellström,
Stockholm.

De retour à Stockholm après une tournée à l'étranger j'ai trouvé votre aimable lettre.

Je ne puis qu'approuver le regret de ne pas avoir pu vous connaître davantage et je vous prie d'accepter tout mon estime pour la grande oeuvre que vous avez si personnellement accomplie.

Mon travail dans le Comité Russe me permet de considérer tout spécialement l'énorme effort que vous avez dû fournir pour la réussite des Jeux Olympiques.

Veillez agréer encore mes remerciements personnels pour toute l'amabilité que j'ai vu de votre part aux occasions des courtes entrevues que nous avons eues.

G. DUPERRON.

Letter from the Servian Olympic Committee.

Belgrade 10—IX—1912

Mon Colonel,

Le Comité Olympique Serbe a l'honneur de vous remercier du charmant accueil que vous avez bien voulu réserver à ses représentants à la V Olympiade à Stockholm, et vous prie de croire à sa sincère reconnaissance.

Veillez accepter, mon Colonel, pour vous-même les expressions de mes sentiments les plus dévoués.

Président du Comité Olympique Serbe, Général

NIK. STEFANOVITCH.

*Telegram from Captain E. Wetherell,
Manager of the South African Con-
tingent.*

Chairman, Olympic Committee.

On our departure from Sweden we would thank you and your Committees for the excellent arrangements made for the Games and also for our personal comfort. The kindness we have received on all hands has been very great. We are leaving your country with great regret.

Captain WETHERELL,
and members of South African Olympic Team.

*Letter from J. Menkin, Esq., Secre-
tary of the South African Olympic
Committee.*

Johannesburg 21st October 1912.

The Secretary,

The Swedish Olympic Committee,

1 A, Hamngatan,
Stockholm.

Dear Sir,

I beg to acknowledge the receipt of your favour of the 4th September, conveying the thanks of your Committee, which was laid before my Committee, and I can assure you the flattering remarks therein contained were greatly appreciated. Whatever slight support and co-operation my Committee has been able to render you has been a pleasure and a benefit to them, as the results of the recent Games testify.

In return, will you kindly convey to your Committee the warmest thanks of my Committee, not only for your kind help and support in obtaining quarters and accommodation for the South African team, and for general assistance throughout, but also for your every effort to do honour where honour was due.

Believe me, dear Sir,

Yours sincerely,

J. MENKIN,
Secretary.

*Letter from Sidney H. Farrar, Esq.,
President of the south African Olympic
Committee.*

4, London Wall Buildings, London, E. C. 8th October 1912.

The Secretary,
Swedish Olympic Committee,

Stockholm.

Dear Sir,

On behalf of the South African Olympic Committee who have now had an opportunity of seeing their athletes on their return to South Africa, I beg to tender to you and your Committee their sincere thanks for your great kindness and courtesy to the South African Team, which, I can assure you, has been very much appreciated throughout South Africa.

Personally, I should like to add my sincere thanks to you for your prompt courtesy in all matters on which I have had occasion to refer to you.

I am, dear Sir,
Yours very truly,

SIDNEY H. FARRAR,
Chairman, London Committee, South African Olympic Team.

*Letter from Godefroy de Blonay, Mem-
ber of the Swiss Olympic Committee.*

Monsieur Kristian Hellström,
Stockholm.

Monsieur,

On me retourne aujourd'hui la lettre que vous m'avez l'honneur de m'adresser le 31 Juillet; je vous en remercie tout spécialement Soyez persuadé que l'immense tâche que vous avez menée à bien avec une compétence sans pareille vous vaut la reconnaissance de tous et que chacun de seul qui ont été en rapports avec vous eut désiré pouvoir collaborer dans une plus large mesure à votre travail. J'espère avoir le plaisir de vous rencontrer encore avant mon départ, si cela ne devait pas être le cas je vous prie d'accepter, Monsieur, avec l'assurance de mes meilleurs sentiments tous mes vœux pour le bonheur qui vous attend prochainement.

GODEFROY DE BLONAY.

Grand Hôtel de Saltsjöbaden
le 8 Août 1912.

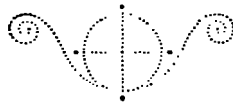

CORRECTIONS.

- Page 70, line 20 from bottom: for 'Katrina' read 'Catania'.
» **168**, » 7 » » » ' , while' » 'and'.
» **262**, » 8 » top: » 'this' » 'thus'.
» **613**, » 22 » » » 'officials' » 'officials*'.
» **1041**, » 16 » » » 'order' » 'Placing'.
- Plate 83 *dele* 'Road'.
» **279** » 'Harbour'.
» 59 for 'Sèvre' read 'Sèvres'.
» **230** » 'Barret' » 'Barrett'.

